

SWEETS

C A T A L O G

COMMERCIAL DOOR HARDWARE

*We make the impossible, possible, through
creativity and ingenuity in life safety and security*

ARCHITECTURAL PULLS
ALUMINUM CONTINUOUS GEARED HINGES
STAINLESS STEEL PIN & BARREL HINGES
EDGE GUARDS
HOSPITAL PUSH & PULL LATCHES
PIVOTS & PIVOT SETS
RESCUE HARDWARE

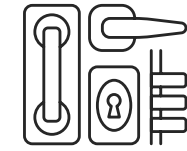

OUR PROMISE

Our team vows to continue exceeding customers' expectations by providing quality products, exceptional cost savings, friendly customer service and expedient delivery.

As an independent, family-owned and operated company since 1991, our employees and customers have always come first. When you call ABH | First Choice[®], a live person always will answer the phone, and questions will be answered promptly and accurately from one of our knowledgeable cross-trained team members with a smile. No automated answering service, no waiting for a list of extensions, no five-minute waits just to be connected with a specific person. Just good ol' fashioned outstanding customer service. We are a dedicated team and we are here to make the impossible, possible, through creativity and ingenuity in life safety and security!

TABLE OF CONTENTS

Quick click to find exactly what you are looking for



TARGET 1 – Quick Ship	1
Standard Finishes	5
Architectural Pulls	7
Locking Ladder Pulls	10
Aluminum Continuous Hinges	11
Stainless Steel Pin & Barrel Continuous Hinges Cross Reference	15
Stainless Steel Pin & Barrel Continuous Hinges	17
Stainless Steel Edge Guards	19
Stainless Steel Edge Guards Cross Reference	21
Hospital Push/Pull Latches & Cross Reference 6800Q & LR6000Q	22
Hospital Push/Pull Latches	25
Electromagnetic Door Holders & Cross Reference	27
Overhead Stops & Holders	31
Overhead Stops & Holders Cross Reference	32
Pivots & Pivot Sets	36
Pivots & Pivot Sets Cross Reference	37
Roller Latches & Roller Latch Cross Reference	40
Electrical Power Transfers & Electrical Power Transfer Cross Reference	41
Rescue Hardware & Rescue Hardware Cross Reference	44
Slide Bolts, Surface Bolts, & Flush Bolts	46
Slide Bolts Cross Reference	47
Door Stops & Override Indicator	50
Coordinators & Coordinator Cross Reference	51
Specialty Hinges	54
Custom Pulls	56
Miscellaneous Products - Custom Door Knocker	57
Miscellaneous Products - Privacy Door Latch	58
Miscellaneous Products - Automatic Door - Opener Cover	59



TARGET 1

QUICK SHIP

All products listed will ship within 3 business days from date of order entry at Standard Buying Program.
(Based on availability. Contact factory for details.)

Part #	Type	Details & Size
OVERHEAD STOPS AND HOLDERS		
1000-US32D	Concealed Mount	Heavy Duty
4000-US32D	Concealed Mount	Medium Duty
4400-US32D	Surface Mount	Medium Duty
7000-US32D	Surface Mount	Heavy Duty
9000-US32D	Surface Mount	Heavy Duty
90541-US32D	Angle Jamb Brackets	Heavy Duty
44443-US32D	Angle Jamb Brackets	Medium Duty
HOSPITAL PUSH/PULL LATCHES		
6000-US32D	Cylindrical Latch	2-3/4" or 5"
6800-US32D	Cylindrical Latch-Low Profile	2-3/4" or 5"
6800Q-US32D	Cylindrical Latch-Low Profile, Quiet Glide	2-3/4" or 5"
605912-US32D	Extended Lip ASA Strike	1-1/2"
605958-US32D	Extended Lip ASA Strike	1-5/8"
ELECTROMAGNETIC HOLDERS		
2100-US28	Recessed Mount	Tri-Voltage
2300-US28	Surface Mount	Tri-Voltage
2400-US28	Flush Mount	Tri-Voltage
2600-US28	Single Floor Mount	Tri-Voltage
20038, 20050, 20075, 20100, 20400, 20600, 20020-US28	Standard Door Armature & Extensions	-
ALUMINUM CONTINUOUS GEARED HINGES		
All Standard Hinge Models - Including Standard Finishes, Heights & Most Options Ship within 48 Hours		
STAINLESS STEEL PIN & BARREL CONTINUOUS HINGES		
A500-US32D	Full Concealed	83-1/8" Only
A505-US32D	Full Concealed, Single w/Edge Guard	83-1/8" Only
A515-US32D	Full Concealed, w/Dual Edge Guards	83-1/8" Only
A511-US32D	Half Mortise, Swing Clear w/Edge Guard	83-1/8" Only
A502-US32D	Full Surface	83-1/8" Only

Part #	Type	Details & Size
PIVOTS & PIVOT SETS		
0117-US32D	Pivot Set, 3/4" Offset	Floor Mount - 300 lb. capacity (0180 Top Pivot Included)
0127-US32D	Pivot Set, Center Hung	Side Jamb Mount - 200 lb. capacity (0320 Top Pivot Included)
0128-US32D	Pivot Set, Center Hung	Floor Mount - 250 lb. capacity (0320 Top Pivot Included)
0147-US32D	Pivot Set, 3/4" Offset	Floor Mount - 600 lb. capacity (0180 Top Pivot Included)
0195-US32D	Pivot Set, 3/4" Offset	Side Jamb Mount - 450 lb. capacity (0180) Top Pivot Included)
019-US32D	Intermediate Pivot - 3/4" Offset	-
0519-US32D	Pocket Pivot	-
0923-US32G	Reinforcing Pivot	300 lbs capacity
ELECTRICAL POWER TRANSFERS		
PT1000-US28, or S5	-	-
PT200-US28, or S5	-	-
PT105-US32D	-	Allows for up to 105° Opening
PT180-US32D	-	Allows for up to 180° Opening

Part #	Type	Details & Size
FLUSH BOLTS		
1855S-US32D	Manual Flush Bolt 1/2"	Use for Metal Doors
1857S-US32D	Manual Flush Bolt	Use for Wood Doors
1860P-US32D	Automatic Flush Bolts	Use for Metal Doors (pair)
1862P-US32D	Automatic Flush Bolts	Use for Wood Doors (pair)
COORDINATORS		
3721-US28	-	For Equal Pair of Doors (56 1/16" to 72")
3780-USP	Universal Coordinator	-
3751-US28	Mounting Brackets	For Stops Less than 2 1/2"
3752-US28	Mounting Brackets	For Stops 2 1/2" or greater
SURFACE BOLTS		
1815TB-US32D	-	8" w/ Top & Bottom Strike
1815BLT-US32D	-	8" w/ Top & Bottom Strike & Locking Bracket
SLIDE BOLTS		
1884A-US32D	Slide Bolt w/Locking Feature	2 3/4" Backset and ASA Strike
ROLLER LATCHES		
1890-US32D	-	5/16" Max projection with 1 11/16" Cast Strike
1895-US32D	-	1/2" Max projection with T-Strike

- All orders must be clearly marked Target 1 or the order will default to the standard lead time.
- If an order is placed with additional products not offered on Target 1, the entire order will default to the standard lead time.
- ABH® also offers Target 3 program (limited discount) for the other products based upon availability. Contact factory direct.





Standard & Custom Finishes

*** Custom Finishes Available – Contact Factory**

ABH® reserves the right to make changes or improvements in design, material, parts or specifications, and "discontinue" without notice.

				ABH PRODUCTS																					
				Door Pulls & Custom Pulls	Rescue Hardware	Electrical Power Transfers	Locking Ladder Pulls	Custom Strikes	Electromagnetic Door Holders	Surface Bolts, Slide Bolts, Vertical Rod Protectors & Covers	Roller Latches	Coordinators	Flush Bolts	Wall Stops, Floor Stops, Applied Stops, Pipe Stops	Overhead Holders & Stops	Hospital Push/Pulls	Cam Lift Hinges & Specialty Hinges	Custom Slim Line Pivots	Pivots & Pivot Sets	Edge Guards	Stainless Steel Door	Continuous Hinges	Stainless Steel Pin & Barrel Hinges	Aluminum Geared Hinges	
S – Standard C – Custom	ANSI #	Color Name																							
S	US3	605/632	BRIGHT BRASS	•	•		•	•	•	•	•		•	•	•	•	•	•	•	•	•	•	•	•	•
S	US4	606/633	SATIN BRASS	•	•		•	•	•	•	•		•	•	•	•	•	•	•	•	•	•	•	•	•
C	US5	609/638	SATIN BRASS OXIDIZED	•	•		•	•	•	•	•		•	•	•	•	•	•	•	•	•	•	•	•	•
S	US9	611	BRIGHT BRONZE – CLEAR COATED	•	•		•	•	•	•	•		•	•	•	•	•	•	•	•	•	•	•	•	•
S	US10	612/639	SATIN BRONZE	•	•		•	•	•	•	•		•	•	•	•	•	•	•	•	•	•	•	•	•
C	US10A	641	ANTIQUE BRONZE LACQUERED	•	•		•	•	•	•	•		•	•	•	•	•	•	•	•	•	•	•	•	•
S	US10B	613/640	DARK BRONZE	•	•		•	•	•	•	•		•	•	•	•	•	•	•	•	•	•	•	•	•
C	US14	618	BRIGHT NICKEL (US32)	•	•		•	•	•	•	•		•	•	•	•	•	•	•	•	•	•	•	•	•
C	US14B	-	BRIGHT BLACK NICKEL	•	•		•	•	•	•	•		•	•	•	•	•	•	•	•	•	•	•	•	•
C	US15	619/646	SATIN NICKEL	•	•		•	•	•	•	•		•	•	•	•	•	•	•	•	•	•	•	•	•
C	US15A	620/647	SATIN NICKEL ANTIQUE OXIDIZED	•	•		•	•	•	•	•		•	•	•	•	•	•	•	•	•	•	•	•	•
C	US17A	621	SATIN BLACK NICKEL CLEAR COAT	•	•		•	•	•	•	•		•	•	•	•	•	•	•	•	•	•	•	•	•
C	US26	625/651	BRIGHT CHROME (US32)	•	•		•	•	•	•	•		•	•	•	•	•	•	•	•	•	•	•	•	•
C	US26D	626/652	SATIN CHROME (US32D)	•	•		•	•	•	•	•		•	•	•	•	•	•	•	•	•	•	•	•	•
S	US32D	630	SATIN STAINLESS STEEL	•	•		•	•	•	•	•		•	•	•	•	•	•	•	•	•	•	•	•	•
S	US32	629	BRIGHT STAINLESS	•	•		•	•	•	•	•		•	•	•	•	•	•	•	•	•	•	•	•	•
S	USP	600	PRIME COAT	•	•		•	•	•	•	•		•	•	•	•	•	•	•	•	•	•	•	•	•
S	S1	689	PAINTED ALUMINUM	•	•		•	•	•	•	•		•	•	•	•	•	•	•	•	•	•	•	•	•
S	S2	695	PAINTED BRASS	•	•		•	•	•	•	•		•	•	•	•	•	•	•	•	•	•	•	•	•
S	S3	694	PAINTED SATIN BRONZE	•	•		•	•	•	•	•		•	•	•	•	•	•	•	•	•	•	•	•	•
S	S4/BSP	693	BLACK SUEDE POWDER COAT	•	•		•	•	•	•	•		•	•	•	•	•	•	•	•	•	•	•	•	•
S	S5	695	PAINTED DARK BRONZE	•	•		•	•	•	•	•		•	•	•	•	•	•	•	•	•	•	•	•	•
S	S8/WSP	-	WHITE SUEDE POWDER COAT	•	•		•	•	•	•	•		•	•	•	•	•	•	•	•	•	•	•	•	•
S	AM	-	CRYSTAL CLEAR – ANTI – MICROBIAL	•	•		•	•	•	•	•		•	•	•	•	•	•	•	•	•	•	•	•	•
S	C	628	CLEAR ANODIZED (US28)	•					•															•	
C	-	-	CHAMPAGNE ANODIZED	•																					•
C	-	311	LIGHT BRONZE ANODIZED	•																					•
C	-	312	MEDIUM BRONZE ANODIZED	•																					•
S	D	313	DARK BRONZE ANODIZED	•																					•
S	B	315	BLACK ANODIZED	•																					•
C	-	-	GOLD ANODIZED																						•
C	-	-	CUSTOM ANODIZED FINISHES																						•



■ AB7501



■ AB3410



■ AB3206



■ AB3802



■ AB4700



■ AB4160



■ AB7200-BTB



■ AB4800



■ AB4999



■ AB7210



■ AB8848



■ AB5270



■ AB3300



■ AB3330





Locking Ladder Pulls

FEATURES

- Operates from outside and inside turn piece
- Locking Options – Head (Top), Floor (Bottom), or Both (Top & Bottom)
- Bolt Location – 2" from face of door
- Bolt has 13/16" travel with minor adjustment
- Stainless steel base material – All BHMA Finishes

DOOR OPTIONS

- Glass 3/8" – 1"
- Aluminum 1 3/4" to 2 1/2"
- Wood or hollow metal 1 3/4" – 2 1/4"

BENEFITS

- Glass door applications secure the opening without bulky patch fittings or rails
- Bolt concealed inside pull provides a clean, streamlined look
- Faster installation with simple door prep
- Requires only 2 holes for half height pulls, 3 holes for full-height
- Custom shapes and sizes to fit you needs



Options

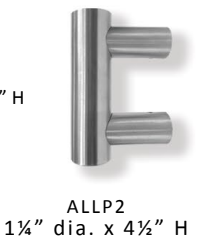
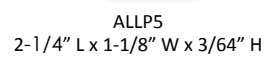
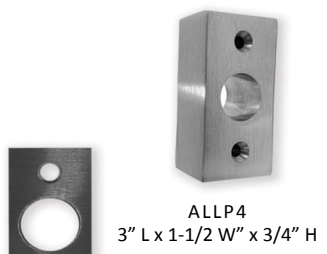



Type	ABH	Allegion	ASSA Abloy		Best	Hager	Select	NGP	PBB	Kingsway
		Ives	Pemko	McKinney						
Full Concealed	A110	112	FM_SLF	MCK-12	661	780-112	SL11	HD1100	CG31	-
	A110SL	-	-	-	-	780-110	SL38	-	-	-
	A110 AHT SEC	-	-	-	-	-	-	-	-	KG200
	A110WT	040	WT_FM	MCK-WT	661WT	780-235	SL40	-	-	-
	A111	-	-	MCK-14	667	780-111	SL18	HD1800	CG31I	-
	A111WT	-	-	-	667WT	-	-	-	-	-
	A120	-	-	-	-	-	-	-	-	-
	A130	-	FM_SLISF	MCK-38	668	780-113	SL71	-	-	-
	A135	-	-	-	-	-	-	-	-	-
	A140	114	-	-	669	780-124	SL14	HD1400	-	-
	A150	-	K_FM	K-MCK-12	670	-	-	-	-	-
	A160	-	FM_SLI	-	671	-	-	-	-	-
	A170	-	-	-	-	780-112A/111B	SL12	-	-	-
	A240	224	FM	MCK-25	662	780-224	SL24	HD2400	CG31L	-
	A260	026	-	-	672	-	SL26	-	CG31L	-
	A270	027	-	-	673	780-226	SL27	HD2700	CG31PN	-
A280	-	-	-	-	-	-	-	-	-	
A410	041	OS_FM	-	674	780-041	SL41	HD4100	CG31CL	-	
Double Acting	A507	-	Markar DSH1000	-	-	-	-	-	-	KG202
Half Surface	A211	-	OS_HS	-	675	780-211	-	HD4200	-	-
	A213	-	-	-	676	780-213	-	-	-	-
	A450	045	-	-	677	780-045	-	-	-	-
	A460	046	-	-	678	780-046	-	-	-	-
	A530	053	-	-	679	780-053	SL53	HD5300	CG34N	-
	A540	054	HS	MCK-54	663	780-054	SL54	HD5400	CG34	-
A550	-	HS_SF	-	680	780-155	-	-	-	-	
Half Mortise	A520	-	HM	-	-	-	-	-	-	-
Full Surface	A210	210	FS	MCK-22	665	780-210	SL21	HD2100	CG33C	-
	A570	157	FS_CP	MCK-58	664	780-157	SL57	HD5700	CG33N	-
	A571	-	FS_BP	-	681	780-057	SL60	-	-	-
	A571 AHT SEC	-	-	-	-	-	-	-	-	KG210
A575	-	-	-	-	-	-	-	-	-	
Electrical Options	EA12	TW	WIRE/ACC	CC	CE	ETW	CTW (AP)	-	-	-
	EA12-EZ	TW CON	QC	QC	-	QC	ATW	-	-	-
	R	-	-	-	-	RETW	RP	-	-	-
	R & EA12-EZ	TWP	SER (EZ)	SER (EZ)	-	-	-	-	-	-
	PT	EPT	PT	EPT	EPT	EPT	EPT	-	-	-
	EM	-	CM	MM	CS	EMN	ECMG	-	-	-
	ES	-	-	-	-	EIS	EMS	-	-	-
Non-Electrical Options	HT	HT	HT	HT	HT	HT	HT	-	-	-
	WEDGE	-	-	-	-	-	TIPPIT	-	-	-
	AHT	-	ALP/SSHT-ALP	-	-	-	-	-	-	-
	FR	-	FIRE PINS	FIRE PINS KIT	FP	UL-STUD	FR3	-	-	-
	SC	-	-	-	SC	BAT	SO	-	-	-
DD	-	-	DD	DD	DD	DD	-	-	-	

Brand names are trademarks or registered trademarks of their respective companies.

AHT

Advanced Hospital Tips - Smooth safe tips provides a safer environment for healthcare.

■ No ligature points in the open and closed positions

* Contact Factory for more details

■ A110*
Full Mortise



■ A120HD
Full Mortise



■ A110WT*
Full Mortise



■ Full Concealed



■ Full Surface



PATENTS PENDING

■ A211HD*
Half Surface



■ A460HD*
Half Surface



■ A520HD
Half Mortise



■ A507
Anti-Ligature
Double Swing Hin



■ A210HD*
Full Surface



■ A571HD*
Full Surface



■ A575HD*
Full Surface
(shown without covers)



■ EA Thru Wire Geared Hinge Electrical Prep
(Lifetime Warranty)



This EA Series Continuous Hinge was designed for easy access electric through-wires to provide continuous current. It's as "EA"sy and as practical as it looks to assemble. Made of aluminum, it is designed and built to last for the life of the building. It comes with twelve 22 AWG Ultra flexible bonded wires that have been tested to 3,000,000 Cycles.



LR Bearings

Ligature Resistant Bearings provide protection from the sharp edges on aluminum geared hinges and helps keep patients safe.

Aluminum Continuous Geared Hinges

STANDARD FEATURES

- ABH[®] provides heavy duty hinges at standard prices.
- Supports doors up to 450 lb. and 48" wide (Concealed models for lead-lined doors = 1,000 lb. max)
- Hinges are anodized after milling and drilling
- Extruded 6063-T6 Aluminum Alloy
- UL/ULC Listed*
- Standard Lengths: 79", 83", 85", 95", and 120"
- Self-drilling screws come standard. Please specify if wood screws are required.

PARTS & OPTIONS

- Custom anodized & powder coated finishes available
- Full line of hinge modifications done in-house. See Cross Reference on page 7.
- Cut to custom lengths available - No additional charge

Visit our website www.abhmfg.com for more Aluminum Continuous Hinges

Type	ABH	Allegion	ASSA Abloy		Best	Hager	Select	NGP	PBB
		Ives	Markar	McKinney					
Full Concealed	A500	700	FM300	MCK-FM300	651	790-900	SL300	SS300	CH51
	AC500	-	-	-	-	-	-	-	-
	A505	705	HG305	MCK-HG305	652	790-905	SL305	SS305	CH31
	AC505	-	-	-	-	-	-	-	-
	A515	715	HG315	MCK-HG315	653	790-915	SL315	SS315	-
	AC515	-	-	-	-	-	-	-	-
	A525	-	-	-	-	-	-	-	-
	A526	-	HG326	MCK-HG326	-	790-926	-	-	-
	A529	-	HG329	-	-	790-929	-	-	-
	A5500	-	FM3500	MCK-FM3500	651HD	-	SL3500	-	-
	A5500WT	-	FM300WT	-	651HD-WT	-	-	-	-
	A5505	-	HG3505	MCK-HG3505	652HD	-	-	-	-
	A5505WT	-	-	-	-	-	-	-	-
	A5515	-	-	-	653HD	-	-	-	-
A5515WT	-	-	-	-	-	-	-	-	
Double Acting	A508	-	-	-	-	-	-	-	-
Half Mortise	A504	-	HM304	MCK-HM304	654	790-904	-	SS304	-
	A506	-	HG306	MCK-HG306	655	790-906	SL306	SS306	-
	A510	-	HG310	MCK-HG310	-	-	SL310	-	-
	A511	711	HG311	MCK-HG311	656	790-911	SL311	SS311	-
Half Surface	A503	-	HS303	MCK-HS303	-	790-903	SL303	-	-
Full Surface	A501	-	-	-	-	-	-	-	-
	A502	702	FS302	MCK-FS302	657	-	SL302	SS302	-
	A512	-	-	-	-	-	-	-	-
Electrical Options	TW4	TW-4	-	CC-4	-	ETW-4	-	-	-
	TW8	TW-8	-	CC-8	CE-600	ETW-8	-	-	-
	TW12	-	-	-	-	-	-	-	-
	EZ4	TW-4 CON	EL4	EL4	-	ETW-4	EL-4	-	-
	EZ8	TW-8 CON	EL8	EL8	-	ETW-8	EL-8	-	-
	EZ12	-	EL12	EL12	-	-	EL-12	-	-
	M	-	ETAP	ETAP	-	-	ETAP	-	-
	ES	-	-	ES	-	EIS	-	-	-
	PT	EPT	CTP	EPT	EPT	EPT	CTP	-	-
Non - Electrical Options	AMS	-	AMS	AMS	-	-	AMS	-	-
	CB (STD)	-	MB	-	-	-	-	-	-
	SEC	-	PEMKO M91-0031	-	-	-	-	-	-
	AS	-	AS	-	-	-	-	-	-
	HT	HT	HT-MP	HT	HT	HT	HT	-	-
	WEDGE	-	-	-	-	-	TIPIT	-	-
	DD	DD	DDP-MP	DDP	DD	DUTCH SECURITY STUDS	DD	-	-
STUD	-	STUD	SECURITY STUDS	STUD	SECURITY STUDS	SEC STUD	-	-	

Brand names are trademarks or registered trademarks of their respective companies.



Stainless Steel Pin & Barrel Continuous Hinges



OMH Approved Products

Standard Features

- Meets ANSI/BHMA Standard A156.26
- Supports doors up to 600 lbs. and 48" wide (A5500 Series = 900 lbs. max)
- UL and ULC Listed for 3 hours*
- Standard Lengths: 78³/₄", 83-1⁷/₈", 85", 95", and 118³/₄"
- Custom lengths and modifications available
- "CB" Clinical Bearings - Standard
- "WEP" Welded End Pins - Standard

Parts & Options

- Custom powder coated finishes available
- Full line of hinge modifications done in house. See Cross Reference on page 9.

Visit our website www.abhmf.com for more Stainless Steel Hinges

*Contact factory for more information



■ AC500*
Full Mortise



ACCREDITED BY CBM
NO GAPS BETWEEN THE LEAFS

■ A500*
Full Mortise



■ A505*
Full Mortise



■ A501
Full Surface



■ A502*
Full Surface



■ A512
Full Surface



■ A504*
Half Mortise



■ A506*
Half Mortise



■ A500* Welded Hospital Tip
Full Mortise
Welded Hospital Tip



■ A5500* Welded Hospital Tip
Full Mortise
SS 12 Ga.



■ A511*
Half Mortise
Swing Clear



Mortised Type	ABH	Allegion	ASSA Abloy		Best	Trimco	Hager
		Ives	Markar	Rockwood			
2-Sided - Square	A528SM	7300	-	300	-	KE31-1	180H
2-Sided - Bevel	A528BM	7301	-	301	-	KE32-1	180K
3-Sided - Square	A538SM	7302	-	302	-	KE33-1	180M
3-Sided - Bevel	A538BM	7302B	-	302B	-	KE33-2	180P
3-Sided - Radius	A538RM	7307	-	-	-	KE34-1	180Q
3-Sided w/Astragal - Square	A548SM	-	-	-	-	-	-
3-Sided w/Astragal - Bevel	A548BM	-	-	-	-	-	-
Non-Mortised Type	ABH	Allegion	ASSA		Stanley	Trimco	Hager
		Ives	Markar	Rockwood			
2-Sided - Square	A528S	7304	EG-C-308 - SQUARE	304	EG1	-	182H
2-Sided - Bevel	A528B	7305	EG-C-308	305	EG1B	-	182K
3-Sided - Square	A538S	7306	EG-308 SQUARE	306	EG2	-	182M
3-Sided - Bevel	A538B	7306B	EG-308	306B	EG2B	-	182P
3-Sided - Radius	A538R	7307	-	307	-	-	182Q
Overlapping - 2-Sided - Square	A528SO	7308	-	308	-	KE35-1	181H
Overlapping - 2-Sided - Bevel	A528BO	7309	-	309	-	KE36-1	181K
Overlapping - 3-Sided - Square	A538SO	7310	-	310	-	KE37-1	181M
Overlapping - 3-Sided - Bevel	A538BO	73010B	-	310B	-	-	181P
3-Sided w/Astragal - Square	A548S	7306-A	EG-T308	306-AST	EG3	-	-
3-Sided w/Astragal - Bevel	A548B	7306B-A	EG-T-308	306B-AST	EG3B	-	-
Options							
	161 Latchbolt	No 6	-	-	-	-	-
	T Strike	No 1	-	-	-	-	-
	ASA Strike	No 2	-	-	-	-	-
	Butt Hinge	No 7/ No 8	-	-	-	-	-
	Auto FB	No 4	-	-	-	-	-
	Manual FB	No 3	-	-	-	-	-
	86 Mortise	No 5	-	-	-	-	-
	Fire Bolt	No 9	-	-	-	-	-

Brand names are trademarks or registered trademarks of their respective companies.



Cross Reference

Edge Guards wrap around the edge of a door to protect them from damage that equipment passing through, such as hospital beds, carts, wheelchairs can cause.

Stainless Steel Edge Guards

Mortised Edge Guards

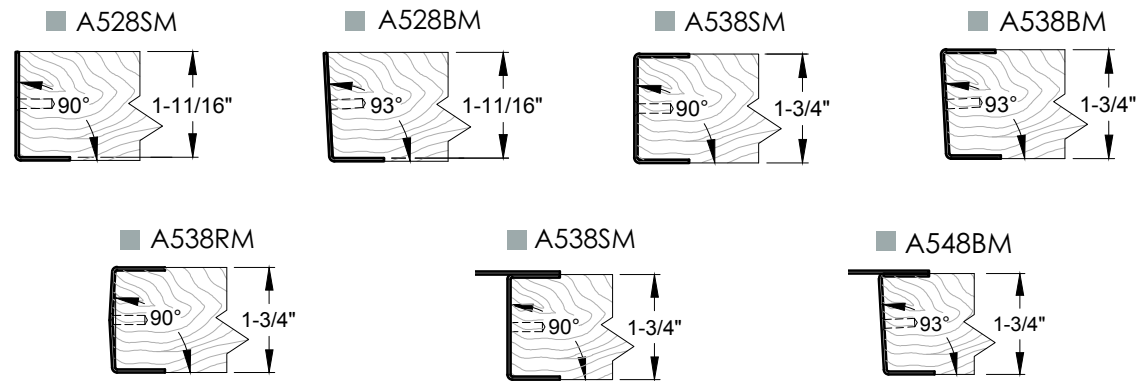

Non-Mortised Edge Guards

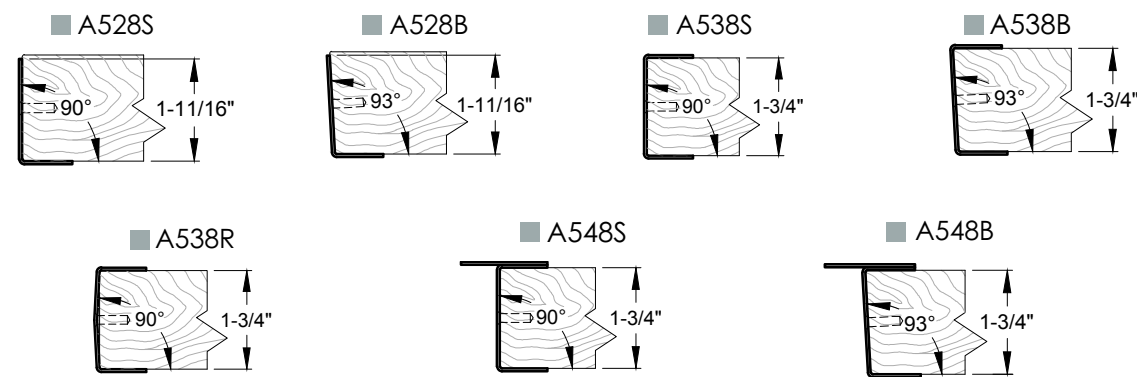

Overlapping Non-Mortised Edge Guards

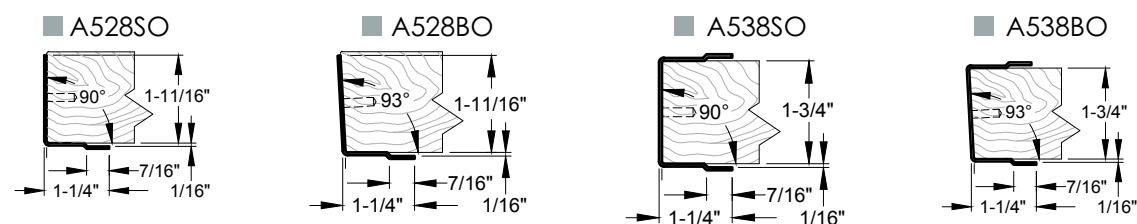

Stainless Steel Lock Side - Clearance Chart

Hinge Side Order Form

Lock Side Order Form

- Download Form
- Fill out PDF Form
- Click to Order
- Attach form to email

Stainless Steel Edge Guards

Standard Features

- 304 Stainless Steel material
- UL Rated
- Standard Finishes - US32D, US32**, US3**, US4**, US10**, US10B**
- #6 X 5/8" FH, U/C SMS fasteners, stainless steel
- Specify any length up to 120"

**Contact factory for finishes on 42 1/8" and larger

Parts & Options

Please fill out Hinge or Lock Side Order Forms. Click below or visit www.abhmf.com

- Standard and Custom cut-outs
- Custom door thicknesses and leg sizes
- "AS"- Adjustable Studs

*Contact factory for more information

Place Your Order Today!

Click to Order



Hospital Push/Pull Latches

Shhhhhh Quiet

6800Q & LR6000Q Quiet Hospital Latches



LR6600 - Ligature Resistant with Mortise Lock



6800Q Quiet Cylindrical Latch

- Zero decibels gained during push and pull action
- Less than 5 lbs. to activate latch - Meets ADA requirements
- All BHMA finishes available
- Custom engraving
- Patented linear acting cam for smooth operation
- UL Listed in U.S.A. and Canada
- Patent #7,285,374 & Additional Patents Pending

Cross Reference

Type	ABH	GJ/ Schlage	ASSA Abloy			Trimco
			Rockwood	Sargent	Corbin Russwin	
Cylindrical Latch	6000	HL6	596	-	-	-
	6800	-	-	114/115	-	1562
	6800Q	-	-	-	-	-
	LR6000	-	-	HPU15ALP	HP3010 HPSK	-
	LR6000Q	-	-	-	-	-
	6000PL 6000PS	HL6-EO	-	-	-	-
	6200	-	-	-	-	-
	6400	PL8	-	-	-	1562L
	6500	PL7	-	-	-	1562L
	6830	-	-	-	-	1591A
6840	-	-	-	-	1562E	
Trim with Mortise Lock Body	6600	HL6-9000	-	7800 PT	-	1562M 1562Q
	LR6600	-	-	8200ALP	ML2000 HPSK	-
Trim Only for Other Manufacturers' Mortise Lock Body	6700	-	-	-	-	-
	LR6700	-	-	-	-	-

Brand names are trademarks or registered trademarks of their respective companies.

Standard Features

- Least amount of moving parts needed to retract latch in the industry
- Most units are non-handed and handles can be mounted in horizontal or vertical positions (except 6800)
- Unit are UL listed

Options

- L - Lead-lining
- P - Engraved Handles "Push" & "Pull"
- RC - Rounded Covers
- J - Junior Covers - Compact 3½" X 2¾"
- H - Hip Paddle
- X - Slip-On Extended Handle
- EX - 6" Extended Handle
- AM - Antimicrobial Coating
- CN - Copper + Nickel Antimicrobial Alloy
- Extended Lip & Custom Strikes Available

Available for Cylindrical or Mortise Lock

- 6800 Low Profile Cylindrical Latch
Quiet Model Available
(Custom Engraving Available)



- LR Series Trim
 - LR6000 - Supplied with Cylindrical Latch (Q-Quiet Available)
 - LR6600 - Supplied with Mortise Lock Body
 - LR6700 - Trim custom made to work with other Manufacturers' Mortise Lock Body



- 6600/6700
 - 6600 - Supplied with Mortise Lock Body
 - 6700 - Trim custom made to work with other Manufacturers' Mortise Lock Body

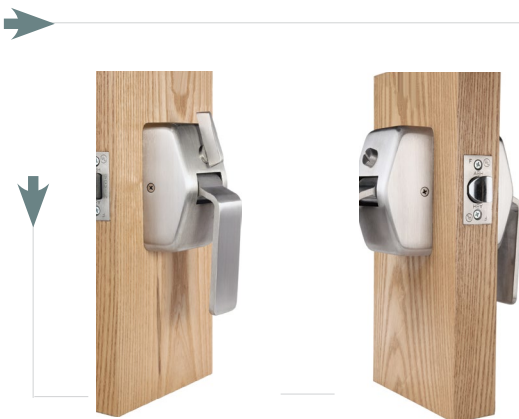

■ 6400/6500
Privacy Cylindrical Push/Pull Latch



■ LR6000F/LR6600F
Flip Up Hospital Latch



■ 6600 x AB x B
Mortise Asylum - Both Sides

← Asylum Trim Available for Cylindrical or Mortise - Choose from one of our three options



■ "B" Round Trim



■ "C" Angled Trim



■ "FM" Flush Mount Trim

Hospital Push/Pull Latches

Personalize your space with Custom Engraving!

Call or Email Factory

[Click Here to Email
Customer Service](#)

Standard Features

- 30–40 lbs. holding power (except 2510 model =300 lbs.)
- Meets and/or exceeds ANSI/BHMA Standard 156.15
- UL/ULC listed
- California State Fire Marshall listed
- All units come tri-voltage for stocking and installation ease (except 2510 model)
- Door armature has 360° mobility
- No special armature adapter piece required to add extensions
- Positive release button armature initiates door closing
- No plastic parts
- Units supplied with a complimentary 1" extension (except 2400L, 2400LS & 2400LR)
- Offered in US28, US32D, US32, and Painted Finishes (except 2400LR, 2600, 2700)

Parts & Options

- Standard size extensions: 3/8", 1/2", 3/4", 1", 2", 4", and 6"
- S20020 Custom Door Armature Extension Available (10" or greater)

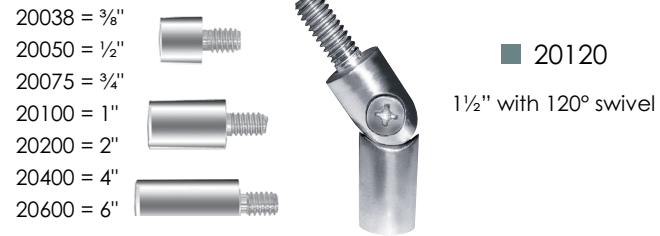

ABH	ASSA Abloy		Allegion LCN	Dormakaba	Hager	RSG Security	Edwards Signaling
	Rixson	Sargent					
2100	998 997 994	1561	SEM7850 SEM7840	EM-504 EM-505	380F	DHXXXXR	1504
2300	996	1560	SEM7830	EM-508	380S	DHXXXXS	1508
2400	990	-	-	EM-509	380R	DHXXXXF	1509
2400L	-	-	-	-	-	-	-
2400LS	989	-	-	-	-	-	-
2400LR	-	-	-	-	-	-	-
2510	993	-	-	-	-	-	-
2600	980	1562	SEM7820	EM-501	380G	DHXXXXG	1501*
2700	981	1563	-	EM-502	380H	-	1502*

Brand names are trademarks or registered trademarks of their respective companies.

■ 2400LR Ligature Resistant



Sloped Door Armature Assembly 1 1/2" - 3 3/4" Projection with extension options, 6° adjustment built in for maximum flexibility for uneven wall conditions



■ 2100(RS)/2100
(RS-Rocker Switch Option)
Recessed Wall Mount



Door Armature
1-5/8" Projection
Wall = 1" Projection

■ 2300/ 2300(RS)
(RS-Rocker Switch Option)
Surface Wall Mount



Door Armature
1-5/8" Projection
Wall = 3" Projection

■ 2400
Flush Wall Mount



Door Armature
1-5/8" Projection
Wall = 1/4" Projection

■ 2400L
Flush Wall Mount



Door Armature
7/8" Projection
Wall = 1/4" Projection

■ 2400LS
Flush Wall Mount



Door Armature
3/8" Projection
Wall = 1/4" Projection

■ 2510
Surface Wall Mount - 300 lbs.



Door Armature
2" Projection
Wall = 2-1/2" Projection

■ 2600
Single Floor Mount

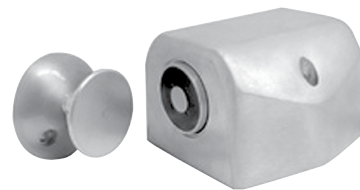

Door Armature
1-5/8" Projection

■ 2700
Double Floor Mount

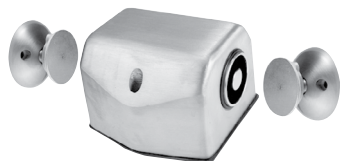

Door Armatures 1-5/8" Projection

■ S20020
Custom Armature Extension



Special for lengths over 10"

■ 20020
Door Armature

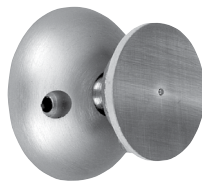

1-5/8" Projection



Electromagnetic Door Holders

Electromagnetic Door Stops & Holders keep doors open until they are released by fire-alarm system. In the event of a power failure, the door is released to keep a facility secured.



Type	ABH	Function	Allegion	ASSA Abloy			Dormakaba	Hager	Cal Royal	ANSI Code
			GJ	Rixson	Sargent	Rockwood				
Concealed Mount	1010	Hold Open	-	1-x26	690H	OH100H	910H	7017 CON	CON880H	C01511
	1020	Stop	-	1-x36	690S	OH100S	910S	7016 CON	CON880S	C01541
	1030	Friction	-	1-x16	-	-	-	7015 CON	-	C01531
	1010A	Hold Open	-	1ADJ-x26	-	-	-	-	-	C01511
	1020A	Stop	-	1ADJ-x36	-	-	-	-	-	C01541
	1030A	Friction	-	-	-	-	-	-	-	C01531
	1010RA	Hold Open	-	-	-	-	-	-	-	C01511
	1020RA	Stop	510	-	-	-	-	-	-	C01541
	1030RA	Friction	-	-	-	-	-	-	-	C01531
	1010SA	Hold Open	100H ADJ	-	-	-	-	-	-	C01511
	1020SA	Stop	100S ADJ	6ADJ-x36	-	-	-	-	-	C01541
	1010SL	Hold Open	100H	-	-	-	-	-	-	C01511
	1020SL	Stop	100S	6-x36	-	-	-	-	-	C01541
	4010	Hold Open	410H	2-x26 5-x26	1530H	-	710H	6017 CON	CON770H	C04511
	4020	Stop	410S	2-x36 5-x36	1530S	-	710S	6016 CON	CON770S	C04541
	4030	Friction	410F	2-x16	1530F	-	710F	6015 CON	-	C04531
	4010RA	Hold Open	-	-	-	-	-	-	-	C04511
	4020RA	Stop	-	-	-	OH200M	-	-	-	C04541
4030RA	Friction	-	-	-	-	-	-	-	C04531	
Surface Mount	3310A	Hold Open	-	-	-	-	6017 SRF	-	-	C05511
	3320A	Stop	-	-	-	-	6016 SRF	-	-	C05441
	3330A	Friction	-	-	-	-	6015 SRF	-	-	C05531
	3414	Hold Open	-	-	-	-	-	-	-	-
	3424	Stop	-	-	-	-	-	-	-	-
	3434	Friction	-	-	-	-	-	-	-	-
	3500	Hold Open	-	-	-	-	-	-	-	-
	4410	Hold Open	450H	10-x26 55-x26	1540H	-	700H	-	CR550H	C05511
	4420	Stop	450S	10-x36 55-x36	1540S	-	700S	-	CR550S	C05541
	4430	Friction	450F	10-x16	1540F	-	700F	-	-	C05531
	4410RA	Hold Open	-	-	-	-	-	-	-	C05511
	4420RA	Stop	-	-	-	OH1000M	-	-	-	C05541
	4430RA	Friction	-	-	-	-	-	-	-	C05531
	7010	Hold Open	70H	-	-	-	-	-	-	C08511
	7020	Stop	70S	-	-	-	-	-	-	C08541
	HD7010	Hold Open	79H	-	-	-	-	-	-	C08511
	HD7020	Stop	79S	-	-	-	-	-	-	C08541
	8010	Hold Open	81H	8-x26	-	-	-	-	-	C03511
	8020	Stop	81S	8-x36	-	-	-	-	-	C03541
	9010	Hold Open	90H	9-x26	590H	OH900H	900H	7017 SRF	HD660H	C02511
	9020	Stop	90S	9-x36	590S	OH900S	900S	7016 SRF	HD660S	C02541
	9030	Friction	90F	9-x16	-	-	-	7015 SRF	-	C02531
	9010A	Hold Open	-	9ADJ-x26	-	-	-	-	-	C02511
	9020A	Stop	-	9ADJ-x36	-	-	-	-	-	C02541
9030A	Friction	-	-	-	-	-	-	-	C02531	
9010RA	Hold Open	550	-	-	-	-	-	-	C02511	
9020RA	Stop	-	-	-	-	-	-	-	C02541	
Options	AJB - Angle Jamb Bracket	-	J	5458 5459	-	-	7090	-	-	-
	CL - Cam Lift	-	-	-	-	-	-	-	-	-
	HC - Hold Closed	-	-	-	-	-	-	-	-	-
	LL - Lead Lined	-	-	-	-	-	-	-	-	-
	LS - Less Spring	-	SE	-	-	-	-	-	-	-
	SNB - Sex Bolt Fasteners	-	SB	-	-	-	-	-	-	-
	SEC - Security Fasteners	-	SOC	-	-	-	-	-	-	-
	T - Threaded Pivot Screw	-	-	-	-	-	-	-	-	-
THICK - Special Door Thickness	-	-	-	-	-	-	-	-	-	

Brand names are trademarks or registered trademarks of their respective companies.

Concealed Mount

Surface Mount

Surface Mount

■ **1000 Series**
Heavy Duty - Concealed



■ **1000A Series** - Adjustable
Heavy Duty - Concealed



■ **1000RA Series** - Series
Concealed Mount Overhead
Stop & Holder, Adjustable



■ **1000SL Series** - Slim Line
Heavy Duty - Concealed



■ **1000SA Series**
Slim Line Adjustable
Heavy Duty - Concealed



■ **4000 Series**
Medium Duty - Concealed



■ **4000RA Series**
Medium Duty - Concealed



■ **3300A Series** - Adjustable
Medium Duty - Surface



■ **3400 Series**
Side Jamb Mount
Medium Duty - Surface



■ **3500 Series**
Parallel Arm Holder



■ **4400 Series**
Medium Duty - Surface



■ **4400RA Series** - Adjustable
Medium Duty - Surface,



■ **9000 Series**
Heavy Duty - Surface



■ **7000 Series**
Heavy Duty - Surface



■ **HD7000 Series**
Extra Heavy Duty - Surface



■ **8000 Series**
Heavy Duty - Surface
NYS
CA
APPROVED



■ **9000A Series** - Adjustable
Heavy Duty - Surface



■ **9000RA Series** - Adjustable
Heavy Duty - Surface



Passionate, Dedicated,
Open to Change

Standard Features

- Meets or exceeds BHMA Standard 156.8
- Classified by UL as Miscellaneous Fire Door Accessory (Stop Only)
- Available in most standard BHMA finishes - Done in-house
- Contain no plastic parts
- Stainless steel used as standard base material (except the 3500)

Parts & Options

- Angle Jamb Brackets available (44443, 70377, 90541)
- Frame Reinforcements available (R4401, R90541)
 - Jamb Bracket Fillers/Shims available (4000JF, 7000JF, 9000JF)
- Hold-Open & Friction Conversion Kits available (Specify model)
- "N" 100% All Stainless Steel (Non-Ferrous) Components
- "SPECIAL" Custom units to fit almost any application
 - "CL" For use with Cam Lift Door applications
 - "HC" Hold Closed

Custom Slim Line Pivots

Standard Features

- Stainless steel base material - Standard (No additional charge)
- Heavy duty needle bearings - Standard (No additional charge)
- Offset pivots UL/ULC Listed for 3 hours - Standard
- Available in most standard BHMA finishes Done in-house

Parts & Options

- "EZ" - Molex® Plug-In Connectors for electrified pivots
- "B" - Bottom pivot only of pivot set
- "SEC" - Pin-in Tox Security Fasteners
- "EXT-SPIN" - Extended spindle for bottom pivot for additional clearance
- "EXT-PIN" - Extended pin for top pivot for additional clearance

Visit our website www.abhmfg.com for more information

[Click Here to Download Custom Pivot Configuration Form](#)



■ E019

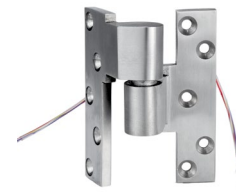

■ E0519EZ Electrical Power Transfer Pivots

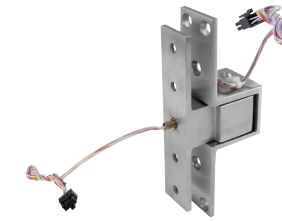

■ E0340

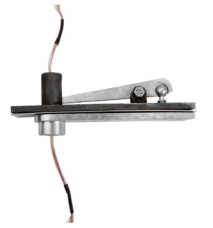

■ 0147-1.5 Offset Pivot Set



■ 0195 Offset Pivot Set

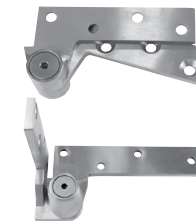

■ 0923 Reinforcing Pivot (Non-Handed)

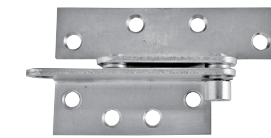

■ 019 Intermediate Pivot



■ 0117.75 Center Hung Pivot



■ 0327 Center Hung Pivot Set

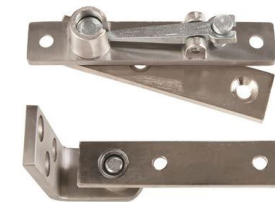

■ 0519 Pocket Pivot



■ 0128 Set Center Hung Pivot

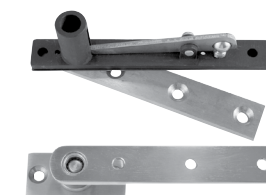

Custom Pivots (See www.abhmfg.com)



Sample Finishes



Cross Reference

Type	ABH	Allegion	ASSA Abloy			Dormakaba	Best	Don Jo	ANSI/ BHMA
		Ives	Rixson	Markar	McKinney				
3/4" Offset	0117	-	117	-	-	OP440	-	-	C07162
		-	F117	-	-	OP440F	-	-	C07202
	0117.25	7212 SET	117-1/4	-	-	-	-	-	C07172
	0117.5	7227 SET	117-1/2	-	-	OPH750	-	-	C07121
		7227F SET	F117-1/2	-	-	OPH750F	-	-	C07202
	0147	7226 SET	147	-	-	-	-	PS-2	C07162
		7226F SET	F147	-	-	-	-	-	C07202
	0147B	-	-	-	-	-	-	BP-2-34	-
	0147 & 019	-	-	-	-	-	-	PS-4	-
	0165	-	165	-	-	-	-	-	C07162(MOD)
	0173	7222	173	-	-	-	-	-	C07162(MOD)
	0180	7212 TOP	180	-	-	75120	-	TP-34	-
		7215 TOP	F180	-	-	-	-	-	-
		7215F TOP	180-20	-	-	-	-	-	-
		7222 TOP	H180	-	-	-	-	-	-
		7226 TOP	H180-20	-	-	-	-	-	-
		7226F TOP	FH180	-	-	-	-	-	-
		7227 TOP	-	-	-	-	-	-	-
		7227F TOP	-	-	-	-	-	-	-
	019	7215 INT	M19	-	-	75220	-	IP-34	C07321
		7215F INT	M19-20	-	-	75222	-	-	C07371
		7226 INT	FM19	-	-	75233	-	-	-
		7226F INT	M190-20	-	-	-	-	-	-
		7227 INT	FM190	-	-	-	-	-	-
	7227F INT	-	-	-	-	-	-	-	-
	0195	7215 SET	195	-	-	OPJ350	-	PS-1	C07131
		7215F SET	F195	-	-	-	-	-	-
	0195B	-	-	-	-	-	-	BP-1-34	-
	0195 & 019	-	-	-	-	-	-	PS-3	-
	0547	-	547	-	-	-	-	-	C07162(MOD)
-		F547	-	-	-	-	-	-	
L0117	7237F SET	L117	-	-	OPL800	-	-	C07111	
	-	FL17	-	-	-	-	-	-	
L0147	7230F SET	L147	-	-	OPL440	-	-	C07162	
	-	FL147	-	-	-	-	-	C07202	
L0180	7230F TOP	L180	-	-	75140	-	-	-	
	-	FL180	-	-	-	-	-	-	
L019	7230F INT	ML19	-	-	75240	-	-	C07311	
	7237F INT	FML19	-	-	-	-	-	-	
0147-1.5	7244F SET	147 x 1-1/2 OS	-	-	OP15200	-	-	C07612	
	-	F147 x 1-1/2 OS	-	-	-	-	-	-	
0180-1.5	7224F TOP	180 x 1-1/2 OS	-	-	15120	-	-	-	
	7245F TOP	F180 x 1-1/2 OS	-	-	-	-	-	-	
019-1.5	-	H180 x 1-1/2 OS	-	-	-	-	-	-	
	7244F INT	M19 x 1-1/2 OS	-	-	15220	-	-	C07321	
-	7245F INT	M19 x 1-1/2 OS-20	-	-	-	-	-	C07371	
-	-	FM19 x 1-1/2 OS	-	-	-	-	-	-	

Brand names are trademarks or registered trademarks of their respective companies.

Cross Reference

Type	ABH	Allegion	ASSA Abloy			Dormakaba	Best	Don Jo	ANSI/ BHMA
		Ives	Rixson	Markar	McKinney				
Center Hung	0127	7255J SET	127-3/4	-	-	-	-	-	-
	0128	7255 SET	128-3/4	-	-	-	-	-	-
	0320	-	320	-	-	-	-	-	-
	0327	-	-	-	EP-5J	-	DAP-3	-	-
	0340	7253 TOP	340	-	-	8062	-	-	-
		7255 TOP							
		7255 J TOP							
		7256 TOP							
	0345	-	345	-	-	-	-	-	-
	0370	7255 SET	370	-	-	CP440	-	-	C07032
-		-	-	-	CPA440	-	-	-	
0117.75	-	117-3/4	-	-	CP660	-	-	-	
Pocket	0519	91105F	F519	-	PH-4	75520	-	-	C07611
		-	-	-	-	75523	-	-	-
Electrical Power Transfer	E019	7215PT INT	EM19	-	-	75200	-	E8WIP-34	-
		7226PT INT	EFM19	-	-	-	-	-	-
		7227PT INT	-	-	-	-	-	-	-
	E019U	-	EM19U	-	-	-	-	-	-
	CM019	-	CSM19	-	-	-	-	-	-
	CME019	-	CSEM19	-	-	-	-	-	-
	E019-1.55	-	EM19 x 1-1/2 OS	-	-	-	-	-	-
	E0340	-	EH340	-	-	E8062	-	-	-
	E0519	91105FPT	EF519	-	-	-	-	-	-
	EL019	7230FPT INT	EML19	-	-	-	-	-	-
7237FPT INT		EFML19	-	-	-	-	-	-	
Reinforcing	0923	-	-	B1923	-	-	-	-	

Brand names are trademarks or registered trademarks of their respective companies.



Roller Latches

Cross Reference

Standard Features

- Easily adjustable roller ensures proper contact between door and frame
- Stainless steel base material standard
- Available in most standard BHMA finishes - Done in-house
- Meets ANSI/BHMA Standard A156.16

Parts & Options

- Custom strikes available (1890S) - Contact Factory
- 18900 - Cast Strike for Roller Latch
- 18901 - ASA Strike for Roller Latch
- 18902 - T-Strike for Roller Latch
- 18904 - Extended Cast Strike 1-5/8" for Roller Latch
- 1890-BODY - Body ONLY for the 1890, 1891, 1892, & 1894
- 1895-BODY - Body ONLY for the 1895, 1896, 1897, & 1898

■ 1890

Cast Strike = 1-1/16" x 2/4"
 Roller latch face = 1" x 3 3/8"
 Maximum roller projection = 5/16"

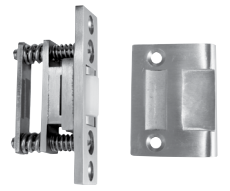

■ 1890S

Custom Strike = Contact factory
 Roller latch face = 1" x 3 3/8"
 Maximum roller projection = 5/16"

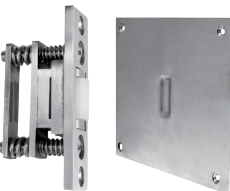

■ 1891

ASA Strike = 1 3/8" (lip to center) x 4 7/8"
 Roller latch face = 1" x 3 3/8"
 Maximum roller projection = 5/16"



■ 1892

T-Strike = 1 3/8" (lip to center) x 2 3/4"
 Roller latch face = 1" x 3 3/8"
 Maximum roller projection = 5/16"

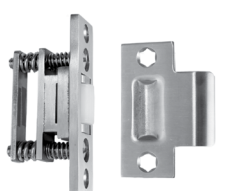

■ 1893

Cast Strike = 1 1/8" x 2 1/4"
 Roller latch face = 1 1/2" x 4 1/2"
 (with integrated angle stop)
 Maximum roller projection = 5/16"



■ 1894

Extended Cast Strike = 2 1/8" x 2 1/4"
 Roller latch face = 1" x 3 3/8"
 Maximum roller projection = 5/16"



■ 1895

T-Strike = 1 3/8" (lip to center) x 2 3/4"
 Roller latch face = 1 1/8" x 2 1/4"
 Maximum roller projection = 1/2"

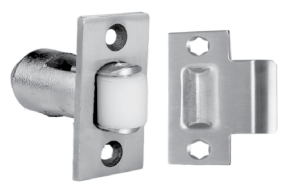

■ 1896

ASA Strike = 1 3/8" (lip to center) x 4 7/8"
 Roller latch face = 1 1/8" x 2 1/4"
 Maximum roller projection = 1/2"



■ 1897

Cast Strike = 1 1/16" x 2 1/4"
 Roller latch face = 1 1/8" x 2 1/4"
 Maximum roller projection = 1/2"

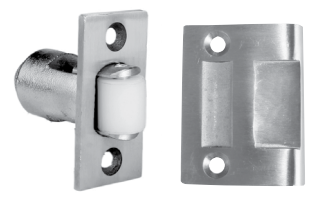





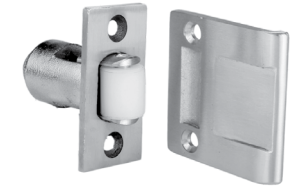

■ 1898

Extended Cast Strike = 2 1/8" x 2 1/4"
 Roller latch face = 1 1/8" x 2 1/4"
 Maximum roller projection = 1/2"

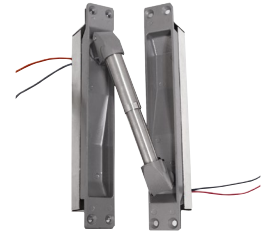
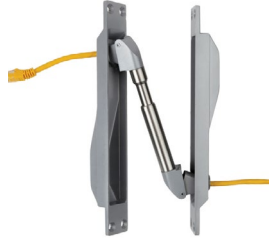

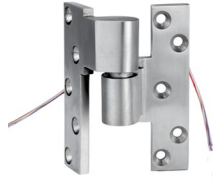
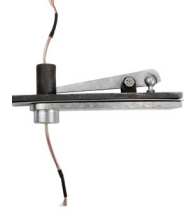
ABH	Allegion	ASSA Abloy		DCI	Hager	Trimco	Don Jo
	Ives	Rockwood	McKinney				
1890	RL30	590	RL1	4030A	1442	1559WA	1700
1890S	-	590DA	-	-	-	-	-
1891	RL30A	591	-	4030C	1443	1559WC	1704
1892	RL36	592	-	4030B	318D	1559WB	1702
1893	RL1152	593	-	4040	318S	1559BL	-
1894	-	-	-	-	320R	-	-
1895	RL32	594	-	-	-	1554_B	1710
1896	RL32A	-	-	-	-	1554_C	-
1897	-	-	-	-	-	1554_A	-
1898	-	-	-	-	-	-	-
18900 Cast Strike	-	-	-	-	-	1559A	-
18901 ASA Strike	-	-	-	-	-	1559C	-
18902 T Strike	-	-	-	-	-	1559B	-
18904 Extended Cast Strike	-	-	-	-	-	-	-

Brand names are trademarks or registered trademarks of their respective companies.

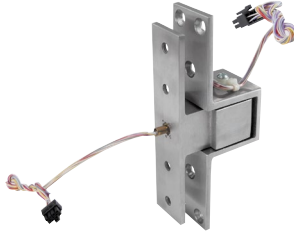
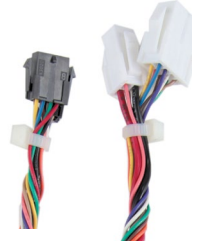
<p>■ PT1000 (10) 24 AWG Wires</p> 	<p>■ PT200 (2) 18 AWG Wires</p> 	<p>■ PTC5E (1) 22 AWG Wires</p> 	<p>■ PTR105 / PTR180 Rounded (No Wire Provided) Standard</p> 
<p>■ PT105SC/PT180SC Power Transfer - Swing Clear (No Wire Provided) Standard</p> 	<p>■ E019 Electrified Intermediate Pivot (8) 30 AWG</p> 	<p>■ E0340 Electrified Center Hung Top Pivot (8) 30 AWG Wires</p> 	<p>■ PT105 / PT180 Square (No Wire Provided Standard)</p> 
<p>■ Concealed Thru Wire "EA & R" 12 wires available for Continuous Hinges (12) 22 AWG Super Flex Ribbon Wire</p> 	<p>■ Movable "M" Movable Section for Electrified Stainless Steel Hinge (Accessible)</p> 	<p>■ E0519 Electrified Pocket Pivot (EZ Connect shown)</p> 	<p>■ EZ Connect Molex® Connector Option</p> 

ABH	Allegion		ASSA Abloy			Dormakaba	Best	Hager	SDC Security Door Controls	Detex	Pamex
	Von Duprin	Securitron	Adams Rite	McKinney							
PT1000	EPT-10	CEPT-10	-	-	-	-	2-679-0623	PTM10	-	EPT-M10	
PT1000EZ	EPT-10 CON	EL-CEPT	-	-	-	-	-	-	-	-	
PT1200EZ	-	-	-	-	-	EPT-12C	-	-	-	-	
PT200	EPT-2	-	-	-	-	-	-	PTM2	-	EPT-M2	
PT200EZ	EPT-2 CON	-	-	-	-	-	-	-	-	-	
PTC5E	-	CEPT-C5E	-	-	-	-	-	-	-	-	
PTC6PLUS	-	-	-	-	-	-	-	-	-	-	
PT105	-	SEPT	-	MCK-EPT	ES105	EPT-5	-	-	-	-	
PTR105	-	EPT	4612-1	-	-	-	-	-	PT-5	-	
PTR105SC	-	-	4612-1-SC	-	-	-	-	-	-	-	
PT180	-	-	-	-	-	-	-	-	-	-	
PTR180	-	EPTL	4612-2	-	-	-	-	-	-	-	
"EZ" OPTION	CON	EL	-	EL	-	-	-	-	-	-	

Brand names are trademarks or registered trademarks of their respective companies.

Electrical Power Transfer Hardware

Cross Reference

Standard Features

- Means of transferring electrical power from frame to door
- PT1000 & PT200 fit into the same prep as other leading manufacturers
- No Plastic Parts

Parts & Options

- Molex® Connectors are available - EZ Connect
- EZ4 - 4-Wire with Molex®
- EZ8 - 8-Wire with Molex®
- EZ12 - 12-Wire with Molex®
- EZ - PT1000 - 12-Wire with Molex®
- EZ - PT200 - 2-Wire with Molex®
- CAT - Cable Wire available
- PTC5E (1 -100 MHz)
- PTC6PLUS (1 -250 MHz)
- SEC - Security screws available
- Electrified mortise lock bodies available
- E6600 - Contact factory
- SC - Swing Clear Option



Rescue Hardware

Cross Reference

Standard Features

- Stainless steel base material
- Spring-loaded
- Non-handed unit
- Hold-back option built-in (half-moon style only)
- Can be used with ABH® center hung pivot sets (0127, 0128, 0370, or 0327 models)
- Available in most standard BHMA finishes - Done in house

Custom Size Combination

- Also available for use with mortise locks and custom frame sizes - over 1,000 custom templates ready online www.abhmfg.com

■ 0127 Center Hung Pivot Set

Rescue Hardware
Pivot Sets

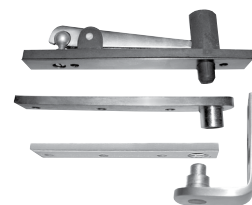

012750 Hardware Set
0127 + CR4550 = 012750

■ CR4570 & CR4580

Combination Rescue Stops
1/8" Inset

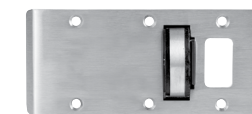

■ CR4594 & CR4593



■ DS4510 & DS4520

Double Lipped Strikes

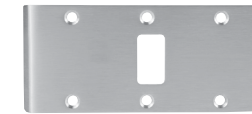

■ DS4530 & DS4540



Rescue Stops

Combination, Center Hung
Rescue Stops

■ SCRM4550



■ CR4550 & CR4560



■ CR4591 & CR4592



Type	ABH	Allegion	ASSA Abloy		Best	Hager	Kingsway
		Ives	McKinney	Pemko			
Double-Lipped Strike Combo Half Moon	CR4550	-	-	-	-	455	-
	CR4560	299AS-7	-	-	-	456	-
	CR4570	-	-	-	-	457	-
	CR4580	299AB-7	-	-	-	458	-
Double-Lipped Strike Combo Flipper	CR4591	-	CSS-9	-	-	-	-
	CR4592	299AS-7	CSS-9	-	-	-	-
	CR4593	-	CSS-9	-	-	-	-
	CR4594	299AB-7	CSS-9	-	-	-	-
Rescue Stop Only	4590	299AL	DS-6	-	ES-1	610	-
Full Length Rescue Stop	A509	-	-	ERS	-	-	KG207

Brand names are trademarks or registered trademarks of their respective companies.

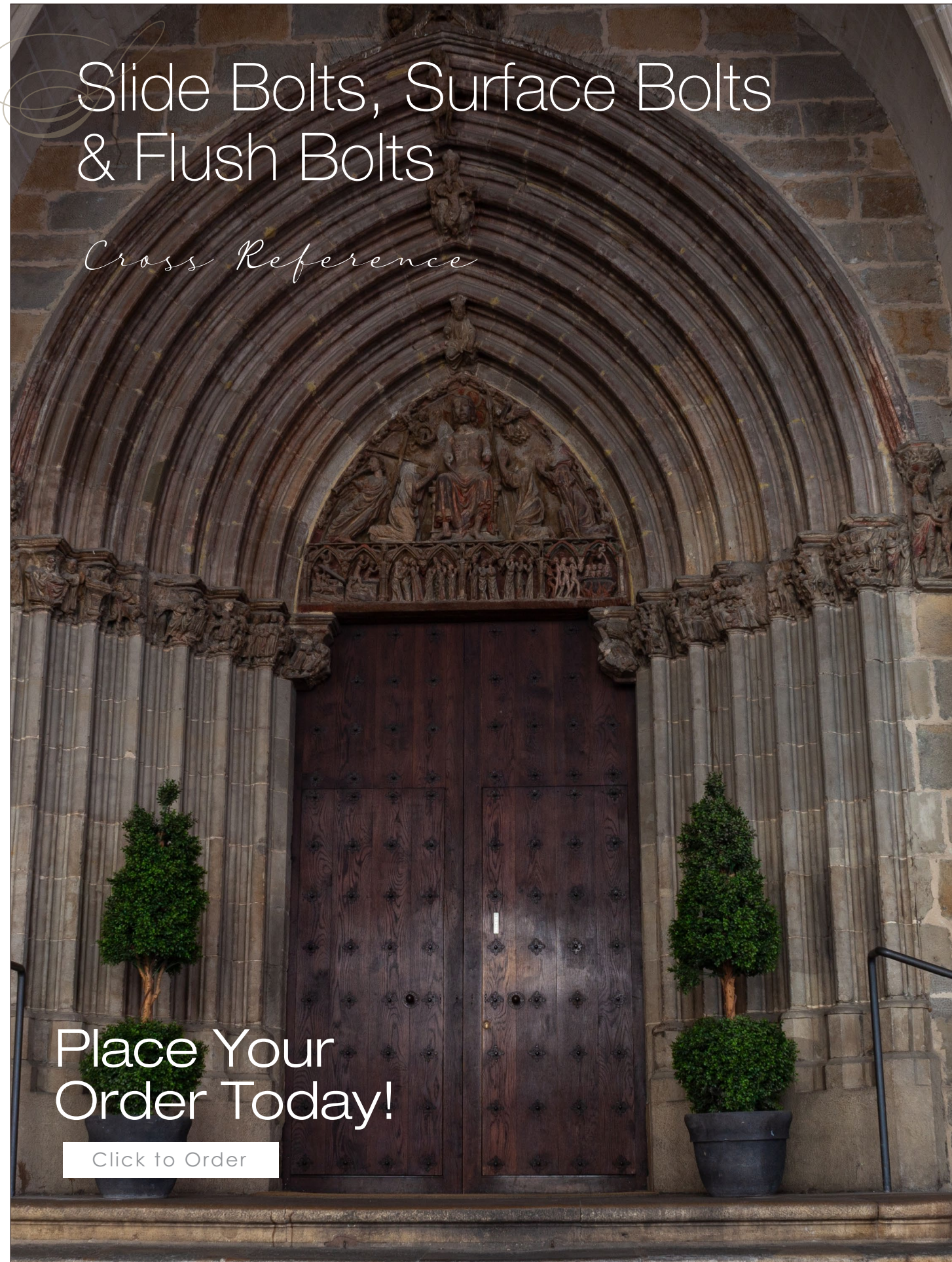

Slide Bolts, Surface Bolts & Flush Bolts

Cross Reference

Place Your Order Today!

[Click to Order](#)

Manual Flush Bolts	ABH	Rockwood	Ives	DCI	Hager	Trimco	Don Jo
Metal - Manual Top Bolt & Bottom Fire Bolt	1854	555 X 18BFB	-	-	-	3917 X 3850	-
Metal - Single	1855S	555	FB458	780F	282D	3917	1555
Metal - Pair	1855P	-	-	-	-	-	-
Wood - Manual Top Bolt & Bottom	1856	557 X 19BFB	-	-	-	1913 X 3850	-
Wood - Single	1857S	557	FB358	790F	283D	3913	1557
Wood - Pair	1857P	-	-	-	-	-	-

Bottom Fire Bolt	ABH	Rockwood	Ives	DCI	Hager	Trimco	Don Jo
Universal for Metal or Wood	1858	18BFB	-	8BFB	-	3850	-

Automatic Flush Bolts	ABH	Rockwood	Ives	DCI	Hager	Trimco	Don Jo
Metal - Single	1860S	2840	FB31T	840	292S	3810L	-
Metal - Pair	1860P	2842	FB31P	842	292D	3810 x 3810	1560
Universal for Metal or Wood - Single	1861S	-	-	-	-	-	-
Universal for Metal or Wood - Pair	1861P	2962	-	960	-	-	-
Wood - Single	1862S	2940	FB41T	942	291S	3815L	1562
Wood - Pair	1862P	2942	FB41P	940	291D	3815 x 3815	-
Metal - Automatic Top & Bottom	1867	2848	FB32	840 X 8BFB	295M	3810 X 3850	-
Wood - Automatic Top & Bottom	1868	2948	FB42	940 X 9BFB	295W	3815 X 3850	-
Universal Top - Metal or Wood & Bottom Fire	1869	2960	-	960 X 9BFB	-	-	-

Self-Latching & Combination Flush Bolts	ABH	Rockwood	Ives	DCI	Hager	Trimco	Don Jo
Metal - Single Self-Latching Top Bolt	1863S	2805	FB51T	805	293S	3820	-
Metal - Self-Latching Top & Automatic Bottom	1863P	2845	FB51P	845	293D	3810 X 3820	-
Wood - Single Self-Latching Top	1864S	2905	FB61T	905	294S	3825L	-
Wood - Single Self-Latching Top & Automatic Bottom	1864P	2945	FB61P	945	294D	3825L X 3815L	-
Metal - Single Self-Latching Top & Bottom Fire Bolt	1865	2849	FB52	805 X 8BFB	-	3820 X 3850	-
Wood - Single Self Latching Top and Bottom Fire Bolt	1866	2949	FB62	905 X 9BFB	-	3825L X 3850	-

Dust Proof Strike	ABH	Rockwood	Ives	DCI	Hager	Trimco	Don Jo
With Removable Section for Use with Threshold	1870	570	DP2/DP1	82	280X	3910, 3910N, 3911	1570/1572

Brand names are trademarks or registered trademarks of their respective companies.

■ 1805 Surface Bolts

- All stainless steel components
- 3/16" x 3/4" stainless steel bar
- 1815TB - 8" with Top & Bottom Strike
- 1825TB - 12" with Top & Bottom Strike
- 1835TB - 24" with Top & Bottom Strike

For other sizes contact factory

■ HD1805 Series
Heavy Duty Surface Bolts

- All stainless steel components
- 3/4" x 3/4" stainless steel bar
- HD1825TB - 12" with Top & Bottom Strike
- HD1835TB - 24" with Top & Bottom Strike
- HD1845TB - 36" with Top & Bottom Strike

For other sizes contact factory

Manual Flush Bolts

- 1855P ■ 1857P



- 1884 Slide Bolt - 2 3/4" backset (161 prep)
■ 1888 Slide Bolt - 2 3/8" backset (160 prep)



(Padlock not included)

■ 1870 Dust Proof Strike



■ 1858 Universal Fire Bolt



Automatic Flush Bolts

- 1860P ■ 1861P ■ 1862P



Self-Latching,
Combination Flush Bolts

- 1862S ■ 1864S



■ 1815TBL

(Padlock not included)

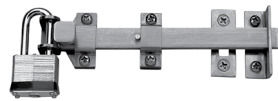

■ HD1825TB - Heavy Duty

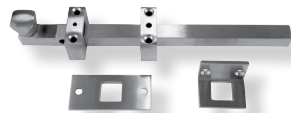

■ 1811 Vertical Rod Protectors & Latch Bolt Covers

- For use in hospitals, schools and other institutions to cover the latching bolt and lower portion of vertical rod assembly
- US32D - Satin stainless steel finish
- Standard lengths for rod covers = 24", 36", 48"
- Custom lengths available - Contact factory
- 1811 = (2) 24" Vertical Rod Covers + (1) RH Latch Bolt Protector + (1) LH Latch Bolt Protector
- 1812 = (1) 24" Vertical Rod Cover + (1) RH Latch Bolt Protector
- 1813 = (1) 24" Vertical Rod Cover + (1) LH Latch Bolt Protector



ABH	Slide Bolts					
	Allegion Ives	ASSA Abloy Rockwood	DCI	Hager	Trimco	Don Jo
1815TB	SB453-8	580-8	-	275D	3922	1580
1815TBL	SBO454-8	582-8	1008P	-	3922L	1582
1825TB	SB453-12	580-12	1012F	276D	3923	1581
1835TB	-	580-24	-	-	3923-24	-
1825TBL	SBO454-12	582-12	1012P	-	-	-
HD1825TB	SB360	585-12	-	-	-	-
HD1835TB	-	585-24	-	-	-	-

Brand names are trademarks or registered trademarks of their respective companies.



Standard Features

Surface Bolts Only

- Lock-out option offers the option for adding another padlock (Suffix "LO")
- Ideal for lockers & temporary locking situations
- Non-handed reversible with built-in fail safe
- Stainless steel assembly

Parts & Options

(for Surface Bolts only)

- L - Locking Bracket
- DL - Double Locking Bracket
- SEC - Security Fasteners
- SNB - Sex Bolt Fasteners

Cross Reference

Slide Bolts, Surface Bolts
& Flush Bolts

Door Stops & Override Indicator

Cross Reference



OMH Approved

Standard Features

- For use in high abuse areas
- Ideal for correctional facilities, schools, & institutions
- No exposed fasteners
- Installed in quick-set cement

■ 1841 Ligature Resistant Wall Stop

- 1" Projection from face of wall
- 2½" Diameter Plate



■ 1842 Ligature Resistant Wall Stop

- 1¾" Projection from face of wall
- 3⅝" Diameter Plate



■ 1804 Pipe Stop & Holder



- All stainless steel components with rubber bumper
- Rubber bumper on the door hits the floor portion when used as a stop
- Door is hooked to floor portion with hook when used as a holder
- Floor portion installed in quick-set cement

■ 1803 Bumper

2" D x 1⅝" H
Rod = ⅝" D x 3" H



■ 1803HO Bumper

Supplied with stainless steel door portion and hook



■ H1803 Bumper

4" D x 1⅝" H
Rod = ⅝" D x 3" H



■ EHD1803 Bumper

3¼" D x 2" H
Rod = ⅝" D x 3" H



■ RM446 Door Stop

Base 1-1/4"
Height 1-1/2"



■ 66300 Override Knob



■ 66200 Indicator with Override



■ 1801 Applied Stop

- For use on single or double doors without a stop
- Available in most standard BHMA finishes
- Stainless steel base material



ABH	Allegion	ASSA Abloy	Hager	Trimco	Don Jo
	Ives	Rockwood			
1801	-	AS18	-	-	1420
1802	-	-	-	-	-
1803	466	FS18S	269F	1209	1462
H1803	-	-	-	-	-
EHD1803	465	FS18L	269T	-	1463
1803HO	464	-	-	-	-
1804	-	-	-	-	-

Brand names are trademarks or registered trademarks of their respective companies.

■ **3700 Full Bar Coordinator**

One size for pairs of doors up to 8' wide



■ **3780 Universal Coordinator**

One size for pairs of doors up to 8' wide



■ **3790 Gravity Coordinator**

Stainless steel base material



3700 SERIES - For Pairs of Equal Doors			
Model#	Door Frame opening (Equal Pair of Doors)	Coordinator (Included)	Door Frame opening (Equal Pair of Doors)
3711	52" or Less	32"	20"
3712	52 ¹ / ₁₆ " - 56"	32"	32"
3721	56 ¹ / ₁₆ " - 72"	52"	20"
3722	72 ¹ / ₁₆ " - 84"	52"	32"
3723	84 ¹ / ₁₆ " - 96"	52"	44"
3733	96 ¹ / ₁₆ " - 104"	60"	44"
3741	UNEQUAL PAIR 36" ACTIVE & 12" - 24" INACTIVE	42"	20"

■ **3760 Carry Bar**

Use where inactive door can be opened before active door



■ **3751**

5" Wide
Stop widths less than 2¹/₂"

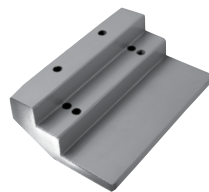

■ **3752**

5" Wide
Stop widths 2¹/₂" or greater

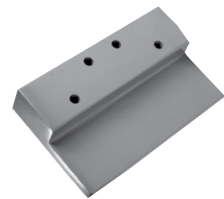

ABH	Allegion Ives	ASSA Rockwood	DCI (Range)		Hager	Trimco	Don Jo
3711	COR32 FL20		N-635	N-652	-	3094A2	2011
3712	COR32 FL32	2660	N-653	N-654	-	3094B1	2012
3721	COR52 FL20	2672	656	672	297D	3094B2	2021
3722	COR52 FL32	2684	673	684	297D	3094B3	2022
3723	COR52 FL44	2696	685	696	297D	3094B4	2023
3733	COR60 FL44		L-696	L-6104	-	3094C4	2033
3741	COR42 FL20	NX2654	NX-648	NX-654	-	-	-
3751	MB-2	2601AB	AB	-	297M	3095	2051
3752	MB-1	2601C	C	-	297N	3096	2050
3760	CB1	1100	CB	-	297C	3090	2060
3780	-	1700	-	-	-	3092	2040
3790	COR7G	576	500	-	298D	3093	2080

Brand names are trademarks or registered trademarks of their respective companies.



Standard Features

- For use on pair of doors when one must close before the other .
- Active door lever holds active door open until inactive door closes enough to trip release mechanism — then active door closes.
 - Filler bar included to fill entire length of opening
- Mounting brackets available for stop mounted hardware (3751 and 3752)
 - UL Listed

Specialty Hinges



Place Your Order Today!

[Click Here to Order](#)

■ Olive Knuckle Hinge



■ A561 Spring Gate Hinge - Full Mortise or Full Surface, Self Closing less Spring, (Tool to tighten included)



■ Paumelle Hinges



■ A563 Spring Gate Hinge - Full Mortise or Full Surface, Self Closing, Less Spring, (Tool to tighten included)



■ LO4545 Lift Off Hinge & LO5050 Lift Off Hinge
4.5" x 4.5" & 5" x 5"



■ A950 Cam Lift Hinge
5" x 4.5" Cam Lift Hinge - 5/16" Lift - 500 Lbs.



■ A661 Heavy Weight Radius Corner 4BB NRP



■ A663 Standard Duty Radius Corner 2BB NRP



■ A9500 Cam Lift Hinge
5" x 4.5" Cam Lift Hinge 5/16" of lift, can hold up to 900lbs.



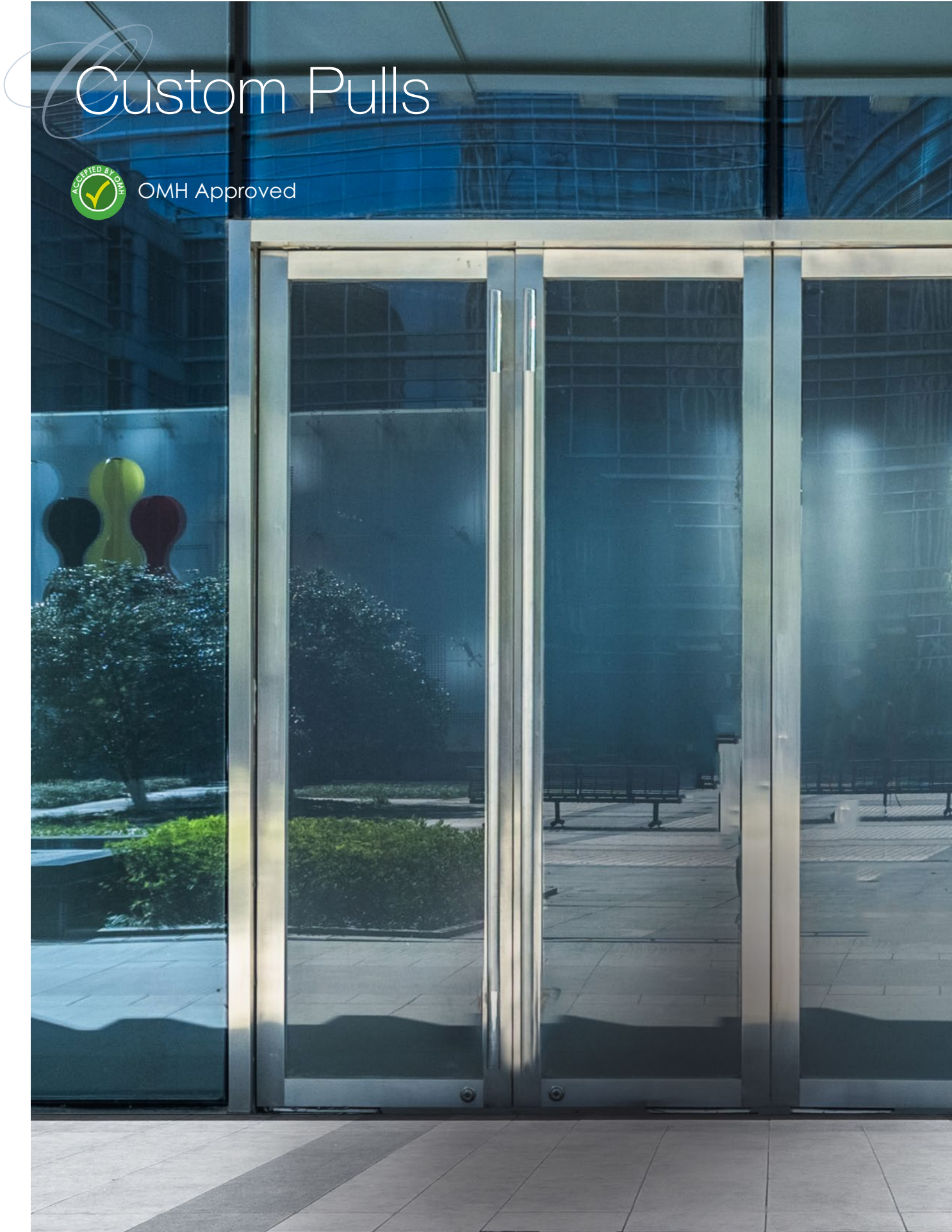

ACCEPTED BY OMH
OMH Approved

■ 1911 Flush Door Pull



■ 1930 & 1930-BTB Ligature Resistant Pull Handle



■ 1931 Ligature Resistant Cabinet Pull



■ 18200 Stainless Steel Round Edge Pull

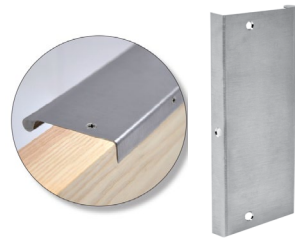

■ 18300 Stainless Steel Round Edge Pull



■ 18158 Door Edge Pull



■ 18726 Square Edge Pull



■ AB150BF



■ AB156BF



■ AB157BF



■ 18115



■ 18130



■ 18111







Automatic Door-Operator Cover

■ 6101
Stainless Steel
Automatic Door-Operator Cover

- #316 Stainless Steel
- Sloped for quick wipe down or easy water runoff after hose cleaning
- Protects clean room environment from contaminants released by operator use
- Protects internal components from daily cleaning reducing maintenance
- Custom made for any automatic door operator
- Closed ends



Inside View



Side View with end cap



- Single door units are available in 36", 42" and 48"
- Double units are also available in 60" and 72"



Architectural Builders Hardware Manufacturing, Inc.
First Choice Building Products
740 Hilltop Drive, Itasca, IL 60143-1326
ABH 630-875-9900 | FCBP 800-793-4544
www.abhmfg.com | www.fcbp.com

Questions, email us at: cs@abhmfg.com • sales@fcbp.com