

W & M Series IDH MAX[®] & Electromechanical Locks by BEST

BEST: Setting the Standard for Security

TABLE OF CONTENTS

IIDH MAX [®] introduction	2	I40HW electrified how-to-order	8
IDH MAX [®] features	2-3	8KW/9KW electrified specification	10
IDH Max [®] chart	3	8KW/9KW electrified how-to-order	10
HM, KM, HW & KW options	3	8KW/9KW electrified functions	10
40HM IDH MAX [®] specifications, how-to-order	4	Trim variations	11
40HM IDH MAX [®] functions	5	Electrified accessories	12,13
93KM IDH MAX [®] specifications, how-to-order	6	Terminology	13
Quick Connect, how-to-order	7, 20	1W electric switch lock introduction	14
93KM IDH MAX [®] functions	7	Optional boxes	14
40HW/8KW/9KW electrified lock introduction	7	1W electric switch lock how-to-order	14
40HW electrified specification	7	1W electric switch locks	15-19
40HW electrified functions	8-9		

IDH MAX[®] – Introduction

The IDH MAX[®] from BEST offers convenience and efficiency for your electrified lock applications. Instead of installing reader devices, installing electrified strikes, installing door contacts and installing request-to-exit devices, you can now install the IDH MAX[®] in cylindrical or mortise lock applications. With IDH MAX[®] all of the formerly separate equipment needed to control access are self-contained in a single installation. The complexity of multiple wire runs is drastically reduced.

You can let BEST show you how to MAXimize your access control system with the IDH MAX[®]! For the name and location of your local office, visit our web site at www.bestaccess.com. IDH MAX[®] and W series locks are compatible with BEST's NT500 and most other Access Control Systems.

IDH MAX[®] – Features

IDH Max[®] Features

Includes latch status, door status and request to exit features

NOTE: Latch Status not available on Deadbolt functions

- Requires only one 4 conductor wire run
- Reduces number of components installed and visible at the door (PIR, RQE push buttons and door contacts)
- Installation time is reduced
- The RQE switch senses the inside lever/knob rotation
- All of the door components are housed in one manufacturer's hardware
- With the elimination of components, only the lockset is visible at the door
- The reader is integrated into the lockset escutcheon
- Available in magnetic stripe and proximity readers
- Available in all popular lever/knob styles and finishes
- Operates with BEST interchangeable core as a mechanical override
- Integrates with many manufacturer's on-line EAC equipment

Mortise Features

- Lock case meets the requirements as listed in the ANSI/BHMA A156.13 standard for Series 1000, Grade 1 Operational and Grade 2 Security locks
- UL listed for GYQS Electrically controlled single point locks or latches for use on 3 hr, A label doors (4' x 10'). The listing applies for both U.S. and Canadian applications
- Door contact, request-to-exit, and latch status sensors positioned inside lock case

- The door contact magnet is installed behind the strike and out ofsite (except when deadbolt option is ordered)
- All sensors are standard in IDH Max mortise locks
- The heavy duty design of the mortise lock results in less field maintenance and part failures
- Twist off lever spindle design protect internal lock parts from damage and failure.
- Oil impregnated stainless steel 3/4" anti-friction latchbolt reduces door closing force and wear.

Cylindrical Features

- Non-handed levers allow for ease of installation
- Lock chassis meets the requirements as listed in the ANSI/BHMA A156.2, standard for Series 4000 Grade 1 locks
- UL listed for GYQS Electrically controlled single point locks or latches for use on 3 hr, A label single doors (4' x 10') GYJB. The listing applies for both U.S. and Canadian applications
- Request-to-exit sensor positioned inside lock trim
- The ISC (Intelligent System Controller) is embedded behind the escutcheon secured and out of site
- Request-to-exit and door contact sensors are standard in IDH MAX cylindrical locks

Magnetic Stripe Electronic Lock Features

- Durable material has teflon-like characteristics for increased life and wear resistance
- Variable read rate allows for easy usage

Proximity Card Reader Features

- HID and Motorola/Indala proximity cards supported Usable in most environmental/exterior applications.

IDH MAX[®] Chart



IDH MAX[®]

- Prep door for IDH MAX[®]
- Run single 4 conductor wire for IDH MAX[®]
- Install IDH MAX[®]
- Install electrified hinge
- Mount PIM

* Operates with most control panel hardware.

HM, KM, HW & KW – Options

AL – Besides complying with a wide variety of accessibility codes and ordinances, lever handles are available with a special abrasive feature. Abrasive strip on the lever immediately identifies warnings on doors to hazardous areas for the blind.

BRK – When excessive force (approx. 300 inch lbs.) is applied to #4, #6 keyed knobs, they "breakaway" and spin freely, thus allowing entrance only by key. Simple part replacement returns lock to functional usage.

C – The easy to use quick connect system enables efficient installation to the respective BEST Lock electrical options ordered.

IDH – The Integrated Door Hardware groups three components into one hardware package. 1. Door status switch (normally closed)

2. Request-to-Exit switch (normally open) 3. Electrically controlled locking mechanism.

KNL – Knurl feature is available only on #6 knobs. The knurling is machined into the outer edge of the knob. The knurled feature can be used for blind, safety, or accessibility applications.

LL – Lead lined feature can be used to protect against X-rays. Since the majority of lead lined doors contain the lead in the surface of the door, the knob lockset provide lead lining for the holes cut in the door when preparing the door for the trim.

LM – The Lost Motion feature allows the lever handle to turn freely when it is locked without retracting the latchbolt assembly. This feature makes over-torque abuse more difficult to achieve.

SH – Security head provided for all exposed screws.

RQE – Cylindrical or Mortise locksets can be supplied with a request-to-exit switch. A normally open switch provides momentary switch closure when the inside lever/knob is rotated.

TAC – Grooves are machined into knobs to improve grip or to be used as a warning in hazardous areas. This option can be used for blind, safety or accessibility applications.

Thick door – Specify thickness if other than 1-3/4".

TL – Tactile levers may be used in areas where improved grip is required or as a warning in hazardous or Safety First areas. Grooves are machined into the back of the hand grasp portion of the lever to improve grip and/or provide a sensory warning. This option can be used for blind, safety, or accessibility applications.

40HM IDH Max® – Specifications

Mechanical

Case – Heavy wrought steel, 5-7/8" H x 4-1/4" D x 1" W steel parts are zinc dichromate plated for corrosion protection.

Faceplate – Brass or bronze, 8" H x 1-1/4" W x 1/16" T. Lock face automatically adjusts to proper bevel during installation.

Strike – Brass, bronze or stainless steel base material, 4-7/8" H x 1-1/4" W x 3/32" T. Fits standard door frame cut out as specified in ANSI A115.1. Universal (non-handed) strike supplied standard with lock.

Backset – 2-3/4"

Door thickness – For doors 1-3/4" – 3" thick. (specify thickness when ordering).

Installation – Lock requires modified door prep to mount the trim. Faceplate dimensions fit standard door preparation as specified in ANSI A115.1. Lockset is easily reversible to match door handing without opening the mortise case.

Latchbolt – Solid stainless steel, 3/4" throw. Latch is oil-impregnated for anti-friction operation. Reversible without opening case.

Deadbolt – Solid stainless steel, 1" throw.

Auxiliary bolt – Stainless steel, non-handed.

Lever Handle – Brass, bronze, or stainless steel base material. Lever styles 3, 14, and 15 return to a minimum of 1/2" of door surface. Lever 12, 16 and 17 do not return.

Escutcheon – 10-1/2" H x 3-5/16" W x 1" D (1" at the top, sloping down to 3/4" at the bottom)

Knobs – Diameter: 2-1/8" Projection on door: 2-7/8" #4, #6 knobs: Material machined from brass or bronze.

Lever handle – Brass, bronze or stainless steel. (Lever #3, #14 and #15 conform to California Titles 19 and 24.)

Mounting – Knob and lever attached with hardened set screw on inside knob or inside lever.

Finishes –

- 605 - bright brass, clear coated
- 606 - satin brass, clear coated
- 611 - bright bronze, clear coated
- 612 - satin bronze, clear coated
- 613 - oxidized satin bronze, oil rubbed
- 625 - bright chromium plated (brass base material)
- 626 - satin chromium plated (brass base material)
- 629 - bright stainless steel
- 630 - satin stainless steel
- 690 - dark bronze coated (brass base material)

* 613 finish is designed to wear over time, providing an "antique" appearance. ** 690 finish will continue as a dark brown appearance over time.

Antimicrobial Finishes –

- 626AM – Satin Chrome Plated with UltraShield Antimicrobial coating
- 630AM – Satin Stainless Steel with UltraShield Antimicrobial coating



45HM IDH MAX® Mortise

Electronic

Maximum current draw – 11 Amp for 50 milliseconds. Typical current draw (hold condition): 650 milliAmps Voltage: 10.2 to 13.2 V (DC only) Magnetic Stripe Card Reader

Read Rate – 5 inches per second to 50 inches per second.

Card Thickness – ISO standard .030" ± .003 thick. Compliance to FCC, Canadian, and European EMC requirements; for interference FCC Class A digital apparatus.

Proximity Reader – ANSI/BHMA A156.25 compliant. Compatible with Motorola / Indala and HID proximity cards. ABA and Wiegand output. Weatherproof bezel and gasket provide protection for outdoor use. (Usable in most environmental/exterior applications)

Card Read Range – 0 – 3 inches. Compliance to US FCC, Canadian FCC, and European EMC requirements

ESD Protection – 15 Kilo Volt

40HM IDH MAX® – How To Order

Series	Core Housing	Function Code	Lever Style	Trim Style	Finishes	Door Hand	Options
45HM-IDH Max® Mortise	0 – keyless 7 – 7-pin housing accepts all Best cores	DEL – single key latch, fail safe DEU – single key latch, fail secure NXEL – keyless, latch, fail safe NXEU – keyless, latch, fail secure TDEL – single key deadbolt, fail safe TDEU – single key deadbolt, fail secure LEL – keyless, deadbolt, fail safe LEU – keyless, deadbolt, fail secure	Standard Levers: 14 – curved return 15 – contour/angle return 16 – curved/no return 17 – gull wing Knobs: 4 – round	MS – magnetic stripe PM – proximity Motorola PH – proximity HID MSA – other cylinder PHA – other cylinder PMA – other cylinder	605 606 611 612 613 618 619 625 626 690 Antimicrobial Finishes 626AM – Satin Chrome Plated with UltraShield Antimicrobial coating 630AM – Satin Stainless Steel with UltraShield Antimicrobial coating	RH RHRB LH LHRB	C – quick connect SH – security head screws TAC – tactile lever Thick Door – specify thickness if other than 1-3/4" 7/8" LTC – flat lip strike
		pages 15-18	page 11	page 11			

40HM IDH Max® – Functions

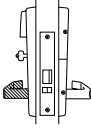
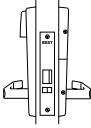
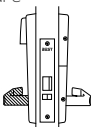
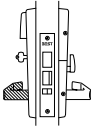
Function	Latch		Outside Knob/Lever*		Inside Knob/Lever	
	Operated by	Locked by	Unlocked by	Locked by	Unlocked by	
DEL–Locked Fail Safe 	Outside knob/lever when power is removed from the solenoid Outside key Inside knob/lever Latchbolt is deadlocked by an auxiliary latch	Applying power to the solenoid; remains locked while power is on.	Removing power from the solenoid	Cannot be locked	Always unlocked	
DEU–Unlocked Fail Secure 	Outside knob/lever when power is applied from the solenoid Outside key Inside knob/lever Latchbolt is deadlocked by an auxiliary latch	Removing power from the solenoid	Applying power to the solenoid; remains unlocked while power is on.	Cannot be locked	Always unlocked	
NXEL–Locked Fail Safe 	Outside knob/lever when power is removed from the solenoid Outside key Inside knob/lever Latchbolt is deadlocked by an auxiliary latch	Applying power to the solenoid; remains locked while power is on.	Removing power from the solenoid	Cannot be locked	Always unlocked	
NXEU–Unlocked Fail Secure 	Outside knob/lever when power is applied from the solenoid Outside key Inside knob/lever Latchbolt is deadlocked by an auxiliary latch	Removing power from the solenoid	Applying power to the solenoid; remains unlocked while power is on.	Cannot be locked	Always unlocked	
TDEL–Locked Fail Safe 	Outside key Outside knob/lever when power is removed from the solenoid. Inside knob/lever Latchbolt is deadlocked by an auxiliary latch	Applying power to the solenoid; remains locked while power is on. Deadbolt operated by: Outside key Inside thumb turn	Removing power from the solenoid Deadbolt and Latchbolt retracted simultaneously by: Inside knob/lever Outside knob/lever when power is removed	Cannot be locked	Always unlocked	
TDEU–Unlocked Fail Secure 	Outside knob/lever when power is applied from the solenoid Outside key Inside knob/lever Latchbolt is deadlocked by an auxiliary latch	Removing power from the solenoid Deadbolt operated by: Outside key Inside thumb turn	Applying power to the solenoid; remains unlocked while power is on. Deadbolt and Latchbolt retracted simultaneously by: Inside knob/lever Outside knob/lever when power is applied	Cannot be locked	Always unlocked	
LEL–Locked Fail Safe 	Outside knob/lever when power is removed from the solenoid Inside knob/lever Latchbolt is deadlocked by an auxiliary latch	Applying power to the solenoid; remains locked while power is on. Deadbolt extended by: Inside thumb turn	Removing power from the solenoid Deadbolt retracted by: Inside thumb turn Inside knob/lever retracts the deadbolt and latchbolt simultaneously Outside lever when power is removed	Cannot be locked	Always unlocked	
LEU–Unlocked Fail Secure 	Outside knob/lever when power is removed from the solenoid Outside key Inside knob/lever Latchbolt is deadlocked by an auxiliary latch	Removing power from the solenoid Deadbolt extended by: Inside thumb turn	Applying power to the solenoid; remains locked while power is on. Deadbolt retracted by: Inside thumb turn Inside knob/lever retracts the deadbolt and latchbolt simultaneously Outside knob/lever when power is applied	Cannot be locked	Always unlocked	

NOTE: Powered by 12V DC. temperature control module is not needed.

*A ridged lever/knob in a non-energized state.

9KM IDH MAX® – Specifications

Mechanical

Materials – Internal parts are brass, zinc or corrosion-treated steel.

Chassis – 2-1/16" diameter to fit 2-1/8" diameter hole in door.

Strike – Brass, bronze, or stainless steel base material; STK 2-3/4" H standard, S3 4-7/8" H. Fits standard door frame cut out as specified in ANSI A115.1. Strike box supplied as standard.

Backset – 2-3/4" standard, 3-3/4" and 5" available.

Door Thickness – Standard lock configuration designed for doors 1-3/4" – 2-1/4" thick.

Installation – Lock dimensions requires modified door prep ANSI A156.2 Series 4000, Grade 1 to mount housing.

Latchbolt – 9/16" throw.

Escutcheons – 10-1/2" H x 3-5/16" W x 1" D (1" at the top, sloping down to 3/4" at the bottom).

Knobs – Diameter: 2-1/8" Projection on door: 2-7/8" #4, #6 knobs: Material machined from brass or bronze.

Lever handle – Made from high-quality zinc alloy. Body is approximately 1-5/8" in diameter. Handle is approximately 4-3/4" in length (from center-line of chassis). Lever styles 14 and 15 return to a minimum of 1/2" of door surface. Lever 16 does not return.

Finishes –

- 605 - bright brass, clear coated
- 606 - satin brass, clear coated
- 611 - bright bronze, clear coated
- 612 - satin bronze, clear coated
- 613* - oxidized satin bronze, oil rubbed
- 625 - bright chromium plated (brass base material)
- 626 - satin chromium plated (brass base material)
- 690** - dark bronze coated (brass base material)

* 613 finish is designed to wear over time, providing an "antique" appearance. ** 690 finish will continue as a dark brown appearance over time.

Antimicrobial Finishes –

- 626AM – Satin Chrome Plated with UltraShield Antimicrobial coating
- 630AM – Satin Stainless Steel with UltraShield Antimicrobial coating



9KM IDH MAX® Mortise

Electronic

Maximum current draw – 850 MilliAmps, for 50 milliseconds

Typical Current Draw (hold condition) – 550 milliAmps

Voltage – 10.2 to 13.2 V (DC only)

Magnetic Stripe Card Reader:

Read Rate – 5 inches per second to 50 inches per second.

Card Thickness – ISO standard .030" ± .003 thick. Compliance to FCC, Canadian, and European EMC requirements; for interference FCC Class A digital apparatus.

Proximity Reader – ANSI/BHMA A156.25 compliant, Compatible with Motorola / Indala and HID proximity cards, ABA and Wiegand output. Weatherproof bezel and gasket provide protection for outdoor use. (Usable in most environmental/exterior applications).

Card Read Range – 0 – 3 inches. Compliance to US FCC, Canadian FCC, and European EMC requirements

ESD Protection – 15 Kilo Volt

9KM/8KM IDH MAX® – How To Order

9KM3	7	DDEU	14	MS	STK	626	
Series Backset	Core Housing	Function Code	Lever Style	Trim Style	Strike Package	Finishes**	Options
Lever: 9KM3 – 2-3/4" 9KM4 – 3-3/4" 9KM5 – 5" Knob: 8KM3 – 2-3/4" 8KM4 – 3-3/4" 8KM5 – 5"	0 – keyless 7 – 7-pin housing accepts all Best cores	DDEU – electrically unlocked DDEL – electrically locked	Standard Levers: 14 – curved return 15 – contour/angle return 16 – curved/ no return Knobs: 4 – round 6 – tulip	MS – magnetic stripe PM – proximity Motorola PH – proximity HID	STK – 2-3/4" ANSI S3 – 4-7/8" ANSI	605 606 611 612 613 618 619 625 626 690 Antimicrobial Finishes 626AM – Satin Chrome Plated with UltraShield Antimicrobial coating 630AM – Satin Stainless Steel with UltraShield Antimicrobial coating	8KM: BRK – breakaway knob, KNL – knurled knob TAC – tactile knob 9KM: AL – abrasive lever LM – lost motion TL – tactile lever Note: specify inside (I), outside (O), or both (B) for AL, TL, TAC, KNL options Both 8KM & 9KM: C – quick connect, SH – security head screws 3/4 – 3/4" throw latch
		page 7	page 11	page 11			page 3

Please reference the BEST price list for a complete list of options. ** Handles and trim are made from a zinc alloy, and have been plated to be equivalent in appearance to the finishes listed.

Cylindrical Lock – Functions

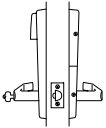
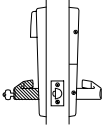
Function	Latch	Outside Knob/Lever*		Inside Knob/Lever	
	Operated by	Locked by	Unlocked by	Locked by	Unlocked by
DDEL–Locked 	Rotating the inside knob/lever; Rotating the outside knob/lever— only when power is off Turning the key in the outside knob/lever Latchbolt is deadlocked	Applying power to the solenoid; remains locked while power is on.	Removing power from the solenoid	Cannot be locked	Always unlocked
DDEU–Unlocked 	Rotating the inside knob/lever; Rotating the outside knob/lever— only when power is on Turning the key in the outside knob/lever Latchbolt is deadlocked	Removing power from the solenoid	Applying power to the solenoid; remains unlocked while power is on.	Cannot be locked	Always unlocked

NOTE: Powered by 12V DC. Temperature control module (TCM) is not needed.

*A ridged lever/knob in a non-energized state.

40HW/8KW/9KW Electrified Lock Introduction

The 40HW, 8KW, and 9KW electromechanical locks provide fail-safe (electrically locked) and fail-secure (electrically unlocked) operation. They also provide a way to lock and unlock the door from a remote location for safety, security, or convenience through an individual switch, switch lock, relay, access control system, or other automatic control system. More importantly, these locks exhibit the same features and meet the same standards and specifications as our mechanical 40H mortise and 8K/9K heavy duty cylindrical locksets.

How To Order BEST Quick Connect Pre-Wired Plug-In Connectors:

To order the BEST Quick Connect pre-wired plug-in connectors, include the "C" suffix for the BEST Locks. See page 20 for more details on how the BEST Quick Connect systems works.



40HW Electrified – Specifications

Types:

- 12 volts AC or DC – 0.60 amps
- 24 volts AC or DC – 0.45 amps
- All EU functions: Electrically Unlocked (Fail Secure)
- All EL functions: Electrically Locked (Fail Safe)

Approval Listings:

- UL listed for GYQS Electrically-controlled singlepoint locks or latches.
- This product has been approved by the California State Fire Marshal (CSFM) pursuant to section 13144.1 of the California Health and Safety Code.
- Approved by the city of New York Board of Standards and Appeals under calendar number 49-88-SA. See CSFM listing No. 4136-1175:101 for allowable values and/or conditions for use concerning material presented in this document. It is subject to re-examination, revisions and possible cancellation.

NOTE: All w-series locks require the use of a (TCM) Temperature Control Module. TCM and TCM connector are supplied standard with every order.

40HW Electrified – How To Order



45HW	7	NXEU	12	J	612	LH	RQE
Series Backset	Core Housing	Function	Lever Style	Trim Style	Finishes**	Handing	Options
45HW – lever 47HW – lever high security	45HW: 0 – keyless or less cylinder 7 – 7 pin IC housing accepts all BEST cores 47HW: 7 – 7 pin (accepts 5C cores only)	45HW/47HW: DEL – single key latch, fail safe DEU – single key latch, fail secure WEL – double key latch, fail safe WEU – double key latch, fail secure TDEL – single key deadbolt, fail safe TDEU – single key deadbolt, fail secure TWEL – double key deadbolt, fail safe TWEU – double key deadbolt, fail secure 45HW only: NXEL – keyless, latch, fail safe NXEU – keyless, latch, fail secure LEL – keyless, deadbolt, fail safe LEU – keyless, deadbolt, fail secure	Levers: 3 – solid tube/return 12 – solid tube/no return 14 – curved return 15 – contour/angle return 16 – curved/no return 17 – gullwing no return Knobs: 4 – round	45HW: H – 2-3/4" flat J – wrought M – forged N – forged concealed cylinder* S – 3-1/2" flat R – 2-3/4" concave 47HW: M – forged	45HW: 605 606 611 612 613 618 619 625 626 690 45HW: 626 630	RH RHRB LH LHRB	AL – abrasive lever C – quick connect LL – lead lined LS – latch status DS – door status RQE – request to exit SH – security head screws TL – tactile lever Thick Door – specify thickness if other than 1 3/4" (1-3/4" min x 4" max) 12V – Specify 12 Volt System (standard lock voltage is 24V)
		pages 8-9	page 11	page 11			page 3

*"N" trim not available on double keyed functions.

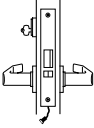
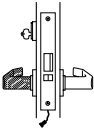
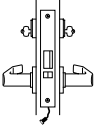
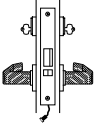
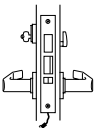
40HW Electrified – Functions

Function	Latch	Outside Knob/Lever*		Inside Knob/Lever	
	Operated by	Locked by	Unlocked by	Locked by	Unlocked by
DEL – Locked Fail Safe 	Outside knob/lever when power is removed from the solenoid Outside key Inside knob/lever Latchbolt is deadlocked by an auxiliary latch Powered by 12 or 24 volts AC/DC & 0.60 or 0.45 amps, continuous duty. Temperature control module (TCM) included.	Applying power to solenoid; remains locked while power is on	Removing power from the solenoid	Cannot be locked	Always unlocked
DEU – Unlocked Fail Secure 	Outside knob/lever when power is applied from the solenoid Outside key Inside knob/lever Latchbolt is deadlocked by an auxiliary latch Powered by 12 or 24 volts AC/DC & 0.60 or 0.45 amps, continuous duty. Temperature control module (TCM) included.	Removing power from the solenoid	Applying power to the solenoid; remains unlocked while power is on.	Cannot be locked	Always unlocked
WEL – Locked Fail Safe 	Inside and Outside knob/lever when power is removed from the solenoid Inside/Outside key Latchbolt is deadlocked by an auxiliary latch Temperature control module (TCM) included. Powered by 12 or 24 volts AC/DC & 0.60 or 0.45 amps, continuous duty. Applying voltage locks inside & outside knobs/levers simultaneously.	Applying power to the solenoid; remains locked while power is on.	Removing power from the solenoid	Applying power to the solenoid; remains locked while power is on	Removing power from the solenoid
WEU – Unlocked Fail Secure 	Inside and Outside knob/lever when power is applied to the solenoid Inside/Outside key Latchbolt is deadlocked by an auxiliary latch Powered by 12 or 24 volts AC/DC & 0.60 or 0.45 amps, continuous duty. Removing voltage locks inside & outside knobs/levers simultaneously. Temperature control module (TCM) included.	Removing power from the solenoid	Applying power to the solenoid; remains unlocked while power is on.	Removing power from solenoid	Applying power to solenoid; remains unlocked while power is on
TDEL – Locked Fail Safe 	Outside key Outside knob/lever when power is removed from the solenoid. Inside knob/lever Latchbolt is deadlocked by an auxiliary latch Powered by 12 or 24 volts AC/DC & 0.60 or 0.45 amps, continuous duty. Temperature control module (TCM) included.	Applying power to the solenoid; remains locked while power is on. Deadbolt operated by: Outside key Inside thumb turn	Removing power from the solenoid Deadbolt and Latchbolt retracted simultaneously by: Inside knob/lever Outside knob/lever when power is removed	Cannot be locked	Always unlocked

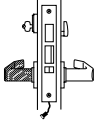
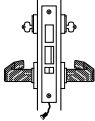
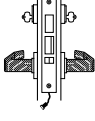
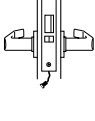
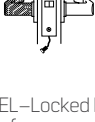
40HW Electrified – Functions (Continued)

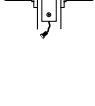
Function	Latch	Outside Knob/Lever*		Inside Knob/Lever	
	Operated by	Locked by	Unlocked by	Locked by	Unlocked by
TDEU–Unlocked Fail Secure 	Outside key Outside knob/lever when power is applied to the solenoid Latchbolt is deadlocked by an auxiliary latch	Removing power from solenoid Deadbolt operated by: Outside key Inside thumb turn	Applying power to solenoid; remains unlocked while power is on Deadbolt and latchbolt retracted simultaneously by: Inside knob/lever Outside knob/lever when power is applied.	Cannot be locked	Always unlocked
Powered by 12 or 24 volts AC/DC & 0.60 or 0.45 amps, continuous duty. Temperature control module (TCM) included.					
TWEL–Locked Fail Safe 	Outside & inside key Outside & Inside knob/lever when power is removed from the solenoid Latchbolt is deadlocked by an auxiliary latch	Applying power to solenoid; remains locked while power is on Deadbolt operated by: Outside or inside key Outside & Inside knob/lever when power is removed from the solenoid	Removing power from the solenoid	Applying power to solenoid; remains locked while power is on	Removing power from solenoid Temperature control module (TCM) included.
Powered by 12 or 24 volts AC/DC & 0.60 or 0.45 amps, continuous duty. Applying voltage locks inside & outside knobs/levers simultaneously.					
TWEU–Unlocked Fail Secure 	Outside & inside key Outside & Inside knob/lever when power is applied to the solenoid Latchbolt is deadlocked by an auxiliary latch	Removing power from solenoid Deadbolt operated by: Outside or inside key Outside & Inside knob/lever when power is applied to the solenoid	Applying power to solenoid; remains unlocked while power is on	Removing power from solenoid	Applying power to solenoid; remains unlocked while power is on Temperature control module (TCM) included.
Powered by 12 or 24 volts AC/DC & 0.60 or 0.45 amps, continuous duty. Removing voltage locks inside & outside knobs/levers simultaneously.					
NXEL–Locked Fail Safe 	Outside knob/lever when power is applied to the solenoid Inside knob/lever Latchbolt is deadlocked by an auxiliary latch	Applying power to solenoid; remains locked while power is on	Removing power from solenoid	Cannot be locked	Always unlocked Temperature control module (TCM) included.
Powered by 12 or 24 volts AC/DC & 0.60 or 0.45 amps, continuous duty. Temperature control module (TCM) included.					
NXEU–Unlocked Fail Secure 	Outside knob/lever when power is applied to the solenoid Inside knob/lever Latchbolt is deadlocked by an auxiliary latch	Removing power from solenoid	Applying power to solenoid; remains unlocked while power is on	Cannot be locked	Always unlocked
Powered by 12 or 24 volts AC/DC & 0.60 or 0.45 amps, continuous duty. Temperature control module (TCM) included.					
LEL–Locked Fail Safe 	Outside knob/lever when power is removed from the solenoid Inside knob/lever Latchbolt is deadlocked by an auxiliary latch	Applying power to the solenoid; remains locked while power is on Deadbolt extended by: Inside thumb turn	Removing power from the solenoid Deadbolt retracted by: Inside thumb turn Inside knob/lever retracts the deadbolt and latchbolt simultaneously Outside knob/lever when power is removed	Cannot be locked	Always unlocked
Powered by 12 or 24 volts AC/DC & 0.60 or 0.45 amps, continuous duty. Temperature control module (TCM) included.					
LEU–Unlocked Fail Secure 	Outside knob/lever when power is applied to the solenoid Inside knob/lever Latchbolt is deadlocked by an auxiliary latch	Removing power from the solenoid Deadbolt extended by: Inside thumb turn	Applying power to the solenoid; remains unlocked while power is on Deadbolt retracted by: Inside thumb turn Inside knob/lever retracts the deadbolt and latchbolt simultaneously Outside knob/lever when power is applied	Cannot be locked	Always unlocked
Powered by 12 or 24 volts AC/DC & 0.60 or 0.45 amps, continuous duty. Temperature control module (TCM) included.					

ATTENTION: Locksets that secure both sides of the door are controlled by building codes and the Life Safety Code®. In an emergency exit situation, failure to quickly unlock the inside lever could be hazardous or even fatal.

8KW & 9KW Electrified Locks – Specifications

Types –

- 12 volts AC/DC when used with supplied TCM – 0.50 amps
- 24 volts AC/DC when used with supplied TCM – 0.18 amps
- All EU functions: Electrically Unlocked (Fail Secure)
- All EL functions: Electrically Locked (Fail Safe)

Approval Listings –

- UL listed for GYOS Electrically- controlled singlepoint locks or latches.
- This product has been approved by the California State Fire Marshal (CSFM) pursuant to section 13144.1 of the California Health and Safety Code.
- Approved by the city of New York Board of Standards and Appeals under calendar number 730-89-SA. See CSFM listing No. 4136-1175:103. It is subject to re-examination, revision and possible cancellation

Door thickness –

- Standard lock configuration designed for doors 1 3/4" – 2 1/4" thick.
- NOTE: All W-series locks require the use of a (TCM) Temperature Control Module. A TCM and TCM connector are supplied standard with every order.



9KW Cylindrical Electrically-Operated Lockset

8KW & 9KW Electrified Locks – How To Order

9KW3	7	DEU	14	K	STK	626	TL
Series Backset	Core Housing	Function	Lever Style	Trim Style	Strike Package	Finishes*	Options
8KW: 8KW3 – 2-3/4" 8KW4 – 3-3/4" 8KW5 – 5" 9KW: 9KW3 – 2-3/4" 9KW4 – 3-3/4" 9KW5 – 5"	0 – keyless 7 – 7-pin housing accepts all Best cores	DEU – electrically unlocked DEL – electrically locked	8KW: 4 – round 6 – tulip 9KW: ♿ 14 – curved return ♿ 15 – contour angle return ♿ 16 – curved no return	C – 3" convex D – 3-1/2" convex K – 3" convex – no ring L – 3-1/2" convex – no ring	STK – 2-3/4" ANSI S3 – 4-7/8" ANSI	605 606 611 612 613 618 619 625 626 690	8KW only: BRK – breakaway knob KNL – knurled knob TAC – tactile knob 9KW only: AL – abrasive lever LM – lost motion ROE – request-to-exit TL – tactile lever Note: specify inside (I), outside (O), or both (B) for AL, TL, TAC, KNL options 8KW & 9KW: C – quick connect LL – lead lined SH – security head screws 3/4 – 3/4" throw latch 12V – Specify 12 Volt System (standard lock voltage is 24V)
	See Below		page 11	page 11			page 3

* Handles are made from a zinc alloy, and have been plated to be equivalent in appearance to the finishes listed.

8KW & 9KW Electrified Locks – Functions

Function	Latch	Outside Knob/Lever*		Inside Knob/Lever	
	Operated by	Locked by	Unlocked by	Locked by	Unlocked by
DEL-Locked	Rotating the inside knob/lever Rotating the outside knob/lever—only when power is off Turning the key in the outside knob/lever. Locks are powered by 12 or 24 volts AC/DC at 0.50 amps or 0.18 amps. Temperature control module (TCM) included	Applying power to the solenoid; remains locked while power is on.	Removing power from the solenoid	Cannot be locked	Always unlocked
DEU-Unlocked	Rotating the inside knob/lever Rotating the outside knob/lever—only when power is on Turning the key in the outside knob/lever Powered by 12 or 24 volts AC/DC & 0.60 or 0.45 amps, continuous duty. Temperature control module (TCM) included.	Removing power from the solenoid	Applying power to the solenoid; remains unlocked while power is on.	Cannot be locked	Always unlocked

*A ridged lever/ knob in a non-energized state.

Knob Styles

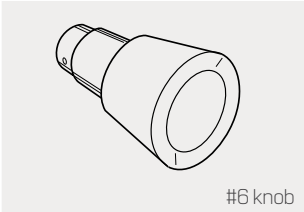
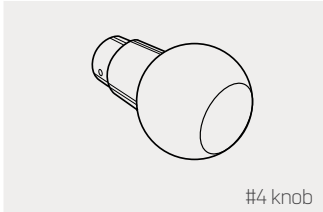

Lever Styles

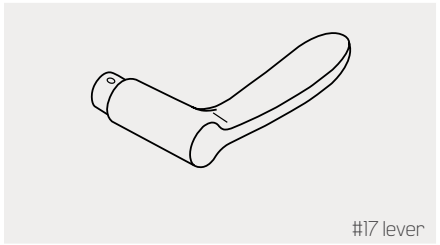
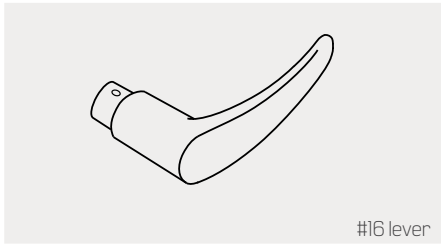
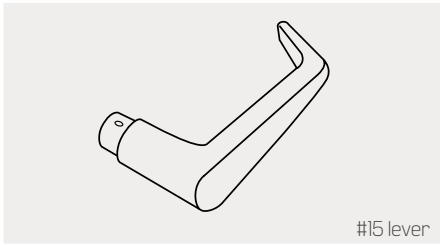
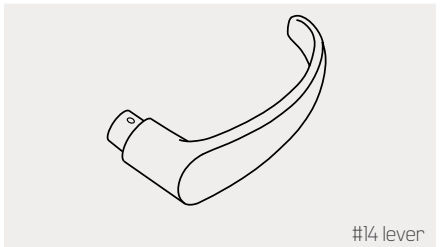
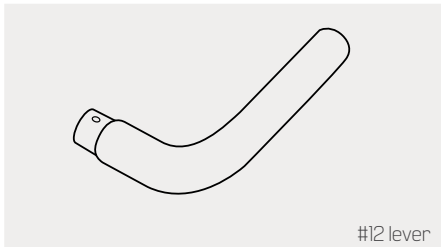
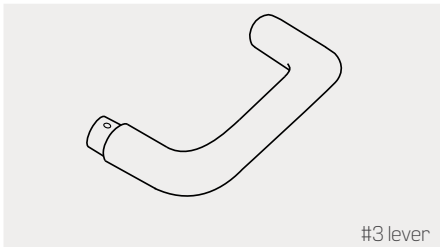

Mortise Rose Trims

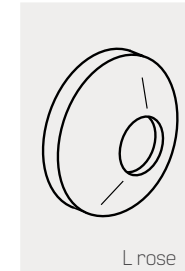
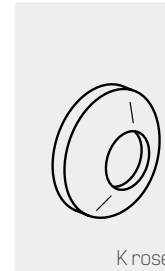
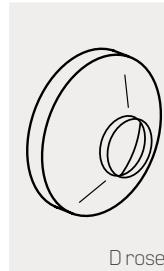
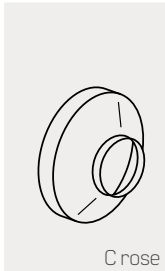
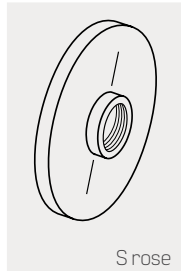
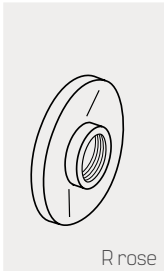
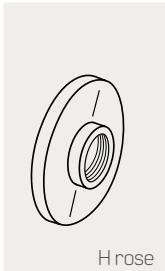

Cylindrical Rose Trims

Escutcheon Trim Variations

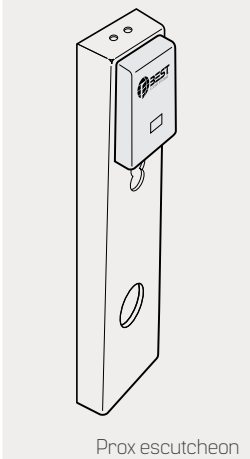
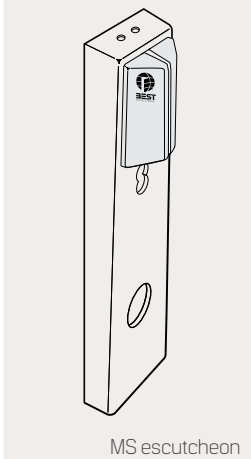
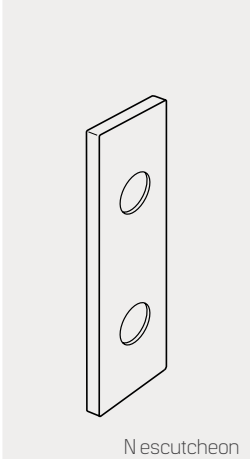
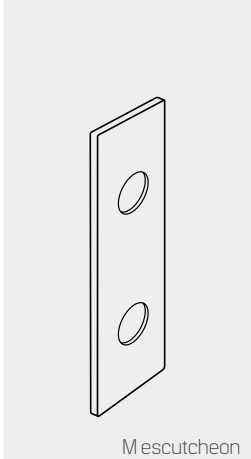
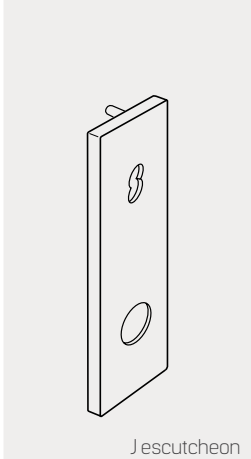

Electrified Accessories

8W599 Features

- Offers exceptionally high power for its compact size
- UL listed
- Thermally fused
- Convenient 4 point mounting provision allows rapid installation in a standard 1/2" knockout
- Foot-mounts for surface installation
- Pre-stripped pigtails provided for quick primary connection
- Secondary connection by screw terminals
- Sturdy nylon bobbin construction
- Cadmium plated finish

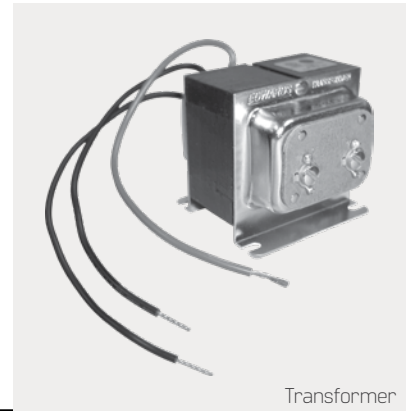

Transformer

8W599 Specifications

Primary voltage – 120 VAC (Wire Leads)

Secondary voltage – 24 VAC (Screw Terminals)

Secondary VA – 140 volts-amperes

Dimensions – 12-1/4" x 2-1/8" x 2-15/16"

To order specify: 18W599

Function/Application: Transforms 120 volts AC to 24 volts AC. (To get 24 volts DC, use with 8WCON, AC to DC converter.) Typically used as a power supply for electrically-operated locks.

8WCON Features

- 400 Ampere surge capability
- Electrically isolated base
- UL recognized
- Single-phase, full wave bridge

8W599 Specifications

Average forward current – 25 amps

Case – Plastic case with an electrically isolated aluminum base

Polarity – Terminal designation embossed on case: +DC output, -DC output, AC not marked

Mounting position – Bolt down. Gain the highest heat transfer efficiency through the surface opposite the terminals. Use silicone heat sink compound on mounting surface for maximum heat transfer.

Terminals – Suitable for "fast-on" connections. Readily solderable and corrosion resistant. Soldering is recommended for applications greater than 15 amperes.

Mounting torque – 20 inch-pounds maximum

Case size – 1.030 x 1.030 inches

Temperature range – -85° to 347°F [-65° to +175°C]

To order specify: 8WCON

Function/Application: Converts AC (alternating current) to DC (direct current) for locking circuit applications. (Typically used with 8W599 transformer.)



AC to DC Converter
Full wave bridge rectifier

8WBU-1-A / 8WBU-1-N Features

- Positive "snap" feedback
- Industrial-grade switch designed for rugged control applications
- Factory assembled with trimplate
- Standard or narrow plate available
- 1-3/16" dia. mushroom head – red in color

8WBU-1-A / 8WBU-1-N Specifications

Electrical rating – 28VDC or 115 VAC, 10A resistive, 5A inductive, 3A lamp load (see terminology on the back cover)

Switch type – SPST-NO-DB, FORM-X contacts, 25,000 cycles at full load, 50,000 cycles mechanical life

Mounting hole – 5/8" (.625) dia.

Switch dim. – 1.187 dia x 1.528 overall length

Standard wall plate – 2-3/4" x 4-1/2"

Narrow wall plate – 1-1/2" x 4-1/2"

Material/finish – Satin stainless steel

Wire leads – Two 6" long 20 AWG insulated wire leads

To order specify:
8WBU-1-A standard plate
8WBU-1-N narrow plate

To order specify:
8WCON

Function/Application: Converts AC (alternating current) to DC (direct current) for locking circuit applications. (Typically used with 8W599 transformer.)



8WBU-1-A
Standard plate



8WBU-1-N
Narrow plate

Electrified Accessories

Temperature Control Module Features

- All circuitry completely sealed

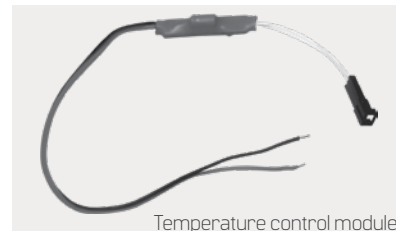

Temperature Control Module Specifications

Wire leads: Input – 24 AWG – Stranded wire with PVC insulation (approx. 60" in length)

Output – 24 AWG – Stranded wire with Teflon insulation (approx. 2.6" in length)

Input Voltage – 12 or 24 volts AC or DC

Output Voltage – Full voltage out @ 1 amp maximum for 0.5 seconds then 30% of voltage out for 5 seconds

Output protection – Short circuit current limiting set at one (1) amp.

Operating temp – -4 to 158°F (-20 to 70°C)

Size – 1/2" x 2-1/4" x 1/2"

Function/Application: A temperature control module (TCM) reduces the amount of current flow to a lockset one second after energizing, thereby lowering the temperature of the lockset trim. A (TCM) also converts AC power to DC power and should be used on all electrified mortise and cylindrical locksets.

NOTE: The TCM is not used with any IDH-Max function.

Terminology

Closed – A state in which a connection exists between the common terminal and another terminal on the switch. See Open also.

Common terminal – A terminal on a switch whose contact can be connected to one or more terminals on the switch.

Door status – A switch that monitors whether the door is open or closed. This switch is used to detect a forced entry, or a door that is propped open.

Inductive load – An electrical device such as a motor, relay, or solenoid.

NOTE: this type of load can cause arcing across switch contacts and may burn the contacts. See Resistive load and Lamp load also.

Latchbolt status – A switch that monitors whether the latch is engaged or retracted. This switch is used to detect a forced entry, or a latch that has been taped open.

Lamp load – An electrical device that produces light using a tungsten filament, such as an incandescent light bulb.

Note: this type of load can cause surges of current upon contact closure. This may cause the contacts to weld together. See Inductive load and Resistive load also.

Maintained – Remaining in a given state until the switch lever or button is actuated. Actuating the switch lever or button causes the switch to change to another maintained state.

Momentary – Remaining in a given state only as long as an external force is applied to the switch lever or button.

NC – (Normally Closed) Switch contacts that are closed as long as no external force is applied to the switch lever or button.

NO – (Normally Open) Switch contacts that are open as long as no external force is applied to the switch lever or button.

Open – A state in which no connection exists between the common terminal or any other terminal on the switch.

Pole – The number of independent circuits in a switch. For example, a double-pole, single-throw switch can control two separately powered motors. See Throw also.

Resistive load – An electrical device, such as a heater, having none of the characteristics of an inductive or lamp load. This type of load is the least severe on the switch because only a small amount of arcing occurs when the switch contacts open and close. See Inductive load and Lamp load also.

RQE – Request-to-exit. A switch that allows the user to exit without setting off an alarm. Turning the inside knob or lever actuates the switch and, when wired to an alarm system, sends a signal to disable or sound an alarm, start a timer, etc.

Throw – The number of circuits, or contacts controlled by each pole. For example, a single-pole, double-throw switch can control a motor with two contacts—a forward contact, and a reverse contact. See Pole also.

Electric Switch Lock – Introduction

BEST offers a line of electric switch locks available in various "on-off" and "momentary" keyed switch functions. Circuitry variations are available in single, double and triple pole with varied voltage and amperage ratings. Units may be keyed into any BEST® system. The BEST interchangeable core offers versatility and adaptability for new and existing electrical controls, panels, machines, etc.

Features

- Double D lock cylinder prevents slipping and turning
- Screw terminals on all switch locks (except the IW7A1) provides ease of installation
- All switches are UL recognized or listed

How to select a switch lock

1. Determine the electrical requirements for the device being controlled:

- A. Voltage (for example: 115 VAC or 24 VDC)
- B. Current or horsepower (for example: 6 amps or 1/2 horsepower)
- C. Type of load
 - Resistive (for example, heater elements)
 - Inductive (for example, motors, large transformers)
 - Lamp (for example, incandescent lights)

2. Determine the switch configuration (poles and throws) and key removal condition:

- A. Poles To determine the number of poles, find how many wires from the power source need to be switched on and off by the switch lock.
- B. Throws To determine the number of throws, find how many wires to the device the switch needs to control. For example, if a switch needs two different "on" conditions (low and high speed), two throws are needed. Or if the device is simply an "on-off" type (only one wire), you need one throw.

NOTE: A switch throw may be left unwired and used as an "off" condition.

- C. Key removal To determine the key removal condition, ask the question, "When the key is removed, should the switch be "off", or could the switch be either "on" or "off"?" Although the key can only be removed in the 12 o'clock position, the switch itself may be left in two or three positions. Check each switch lock for key removal switch positions.

3. Use the information collected and find the switch lock that best meets the requirements. Refer to the following catalog pages for a description of each switch lock. If environmental conditions make it necessary that the switch lock be housed in an electrical box, see the Optional boxes below for the box that best suits the switch lock and your application.

Note on functionality: Switch lock keys can only be removed in the 12 o'clock position.

Optional Boxes

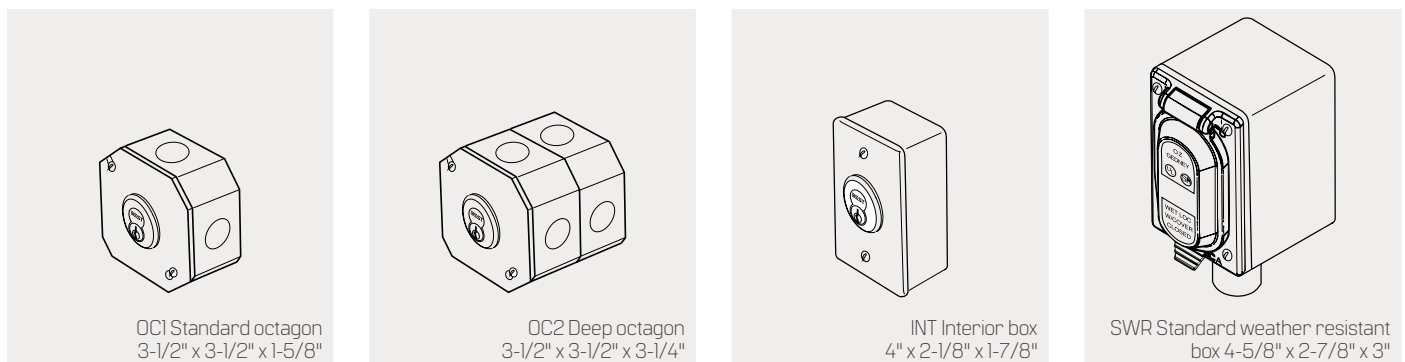

How To Order – IW Electric Switch Lock

IW	7	BI	626	SWR
Series	Core Housing	Function	Finishes	Box
IW	7–7-pin housing accepts all Best cores	see pages 15–19	605 606 611 612 613 619 622 625 626 690	OC1 OC2 INT SWR

IW Electric Switch Locks

IW7A1 Specifications

Contacts – Silver or gold flash

Contact rating – 28 VDC, 10 amps resistive

28 VDC, 3 amps inductive, lamp

125 VAC, 10.1 amps resistive

250 VAC, 10.1 amps resistive

Horsepower rating – 125 VAC, 1/4 HP

Operating temperature – -85°F to +257°F [-65° to +125°C]

Switch type – SPDT (Single pole-double throw)

Switch lock action – Maintained

Number of switches per assembly – One

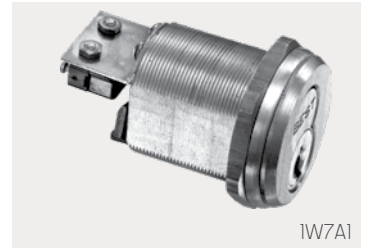

IW7A1

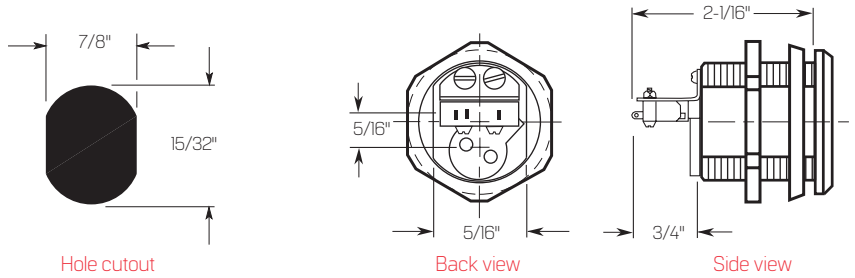

Key & switch positions

Remove key

Optional boxes



Key pos.1– Swt. pos.1

Key pos.2– Swt. pos.2

Key pos.1 only - Swt. pos.1

- SWR
- INT
- OCT

IW7B1 & IW7J1 Specifications

Contact rating – 30 VDC, 15 amps, resistive

125 VDC, 0.6 amps, resistive

250 VDC, 0.3 amps, resistive

125 VAC, 15 amps, resistive

25 VAC, 5 amps, lamp

250 VAC, 15 amps, resistive

Horsepower rating – 125–250 VAC, 1/2 HP

Operating temperature – up to +176°F [+80°C]

Switch type – SPDT (Single pole-double throw)

Switch lock action – Maintained

Number of switches per assembly – IW7B1: One, IW7J1: Two



IW7B1—One switch



IW7J1—Two switches

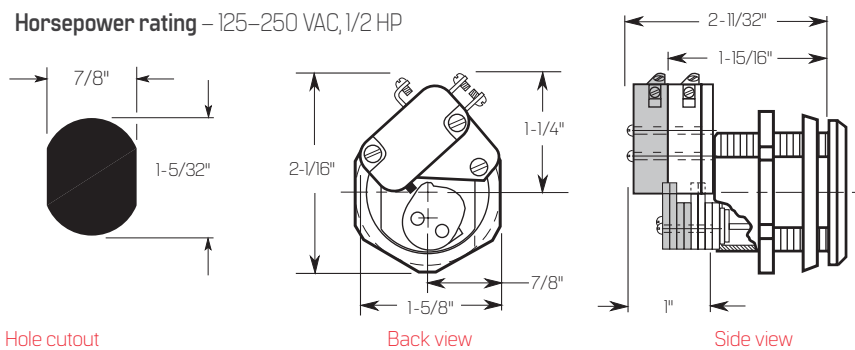

Hole cutout

The shaded area shows the additional IW7J3 switch and cam length.

Key & switch positions

Remove key

Optional boxes

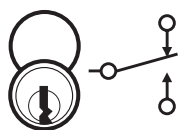
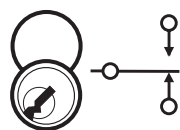
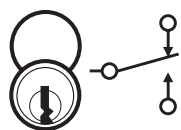

Key pos.1– Swt. pos.1

Key pos.2– Swt. pos.2

Key pos.1 only - Swt. pos.1

- OC1 (IW7B1 only)
- OC2
- INT
- SWR

1W Electric Switch Locks (Continued)

1W7B2 & 1W7J2 Specifications

Contact rating – VDC, 15 amps, resistive
 125 VDC, 0.6 amps, resistive
 250 VDC, 0.3 amps, resistive
 125 VAC, 15 amps, resistive
 125 VAC, 5 amps, lamp
 250 VAC, 15 amps, resistive

Horsepower rating – 125–250 VAC, 1/2 HP
Operating temperature – up to +176°F (+80°C)
Switch type – SPDT (Single pole-double throw)
Switch lock action – Maintained
Number of switches per assembly – 1W7B2: One, 1W7J2: Two

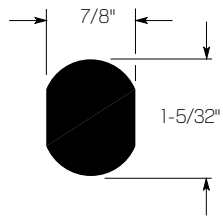

Hole cutout

The shaded area shows the additional 1W7J2 switch and cam length.

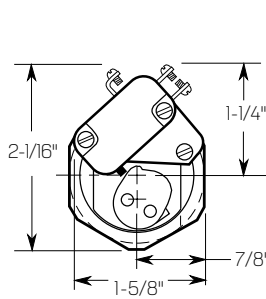

Back view

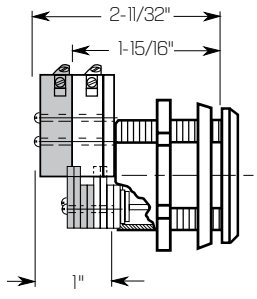

Side view



1W7B2—One switch



1W7J2—Two switches

Key & switch positions

Remove key

Optional boxes

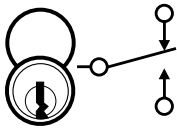

Key pos.1— Swt. pos.1

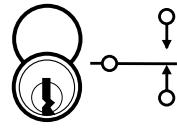

Key pos.2— Swt. pos.2
 [360°CCW]

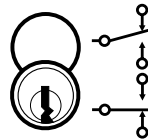

Key pos. 1 only - Swt. pos. 1
 Swt. pos. 1 and 2

- OC1 (1W7B2 only)
- OC2
- INT
- SWR

1W7B3 & 1W7J3 Specifications

Contact rating – 30 VDC, 15 amps, resistive
 125 VDC, 0.6 amps, resistive
 250 VDC, 0.3 amps, resistive
 125 VAC, 15 amps, resistive
 125 VAC, 5 amps, lamp
 250 VAC, 15 amps, resistive

Horsepower rating – 125–250 VAC, 1/2 HP
Operating temperature – up to +176°F (+80°C)
Switch type – SPDT (Single pole-double throw)
Switch lock action – Maintained
Number of switches per assembly – 1W7B3: One, 1W7J3: Two

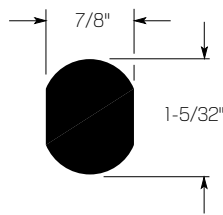

Hole cutout

The shaded area shows the additional 1W7J3 switch and cam length.

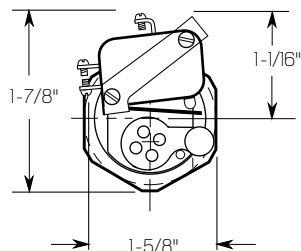

Back view

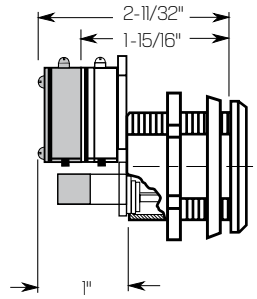

Side view

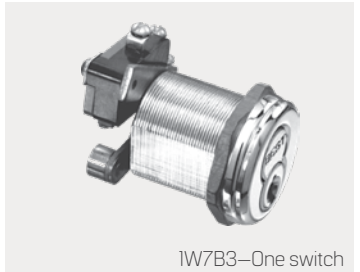

1W7B3—One switch

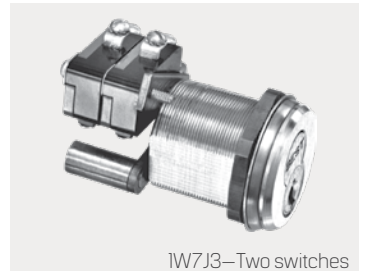

1W7J3—Two switches

Key & switch positions

Remove key

Optional boxes

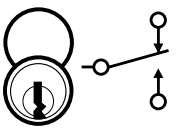

Key pos.1— Swt. pos.1

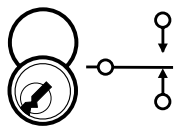

Key pos.2— Swt. pos.2

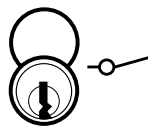

Key pos. 1 only - Swt. pos. 1

- OC1 (1W7B3 only)
- OC2
- INT
- SWR

IW Electric Switch Locks (Continued)

IW7D2 Specifications

Contact rating – 110 VAC or VDC, 16 amps, resistive
220 VAC or VDC, 8 amps, resistive

Horsepower rating – 1 HP @ 125–250 VAC or VDC

Operating temperature – 0°F to +150°F (-18°C to +66°C)

Switch type – DPST (Double pole-single throw)

Switch lock action – Maintained

Number of switches per assembly – One

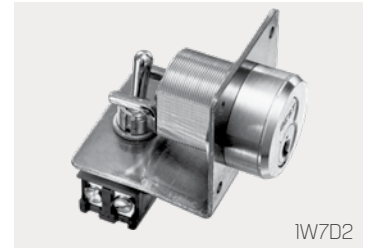

IW7D2

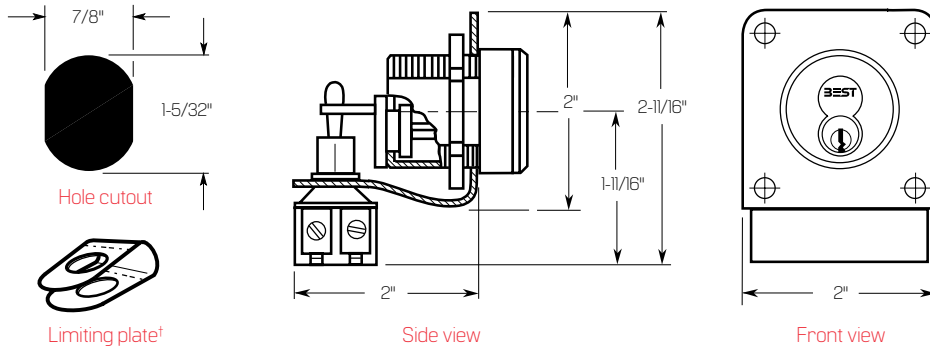

Key & switch positions

Remove key

Optional boxes

SWR

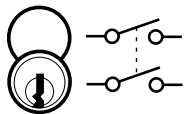

Key pos.1– Swt. pos.1

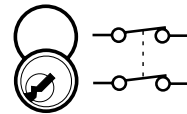

Key pos.2– Swt. pos.2

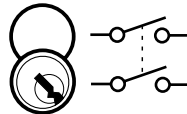

Key pos. 1 only - Swt. pos. 1

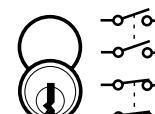

† Installing the limiting plate limits key removal to switch position 1 or 2. The key is always removed in the vertical position (key position 1).

IW7C2 Specifications

Contact rating – 110 VAC or VDC, 10 amps, lamp 220 VAC or VDC, 5 amps, resistive

Operating temperature – -40°F to +150°F (-40° to +65°C)

Switch type – SPST (Single pole-single throw)

Switch lock action – Maintained

Number of switches per assembly – One



IW7C2

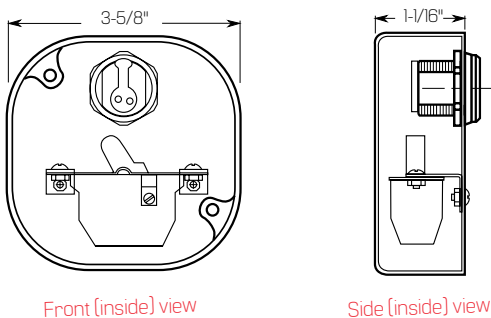

Front (inside) view

Side (inside) view

Key & switch positions

Remove key

Optional boxes

OCI-SPL

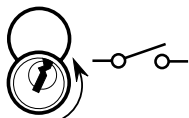

Key pos.1– Swt. pos.1

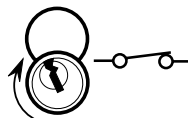

Key pos.2– Swt. pos.2

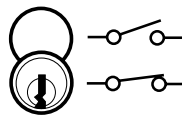

Key pos. 3 only Swt. pos. 1 and 2

1W Electric Switch Locks (Continued)

1W7E2 Specifications

Contact rating – 110 VAC, 15 amps, resistive
220 VAC, 10 amps, resistive

Horsepower rating – 250 VAC or VDC,
3/4 HP; 1, 2, or 3 phase

Operating temperature – 0 to +150°F (-18°C to 66°C)

Switch type – TPDT (Triple pole-double throw)

Switch lock action – Maintained

Number of switches per assembly – One

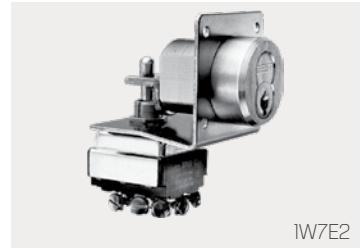

1W7E2

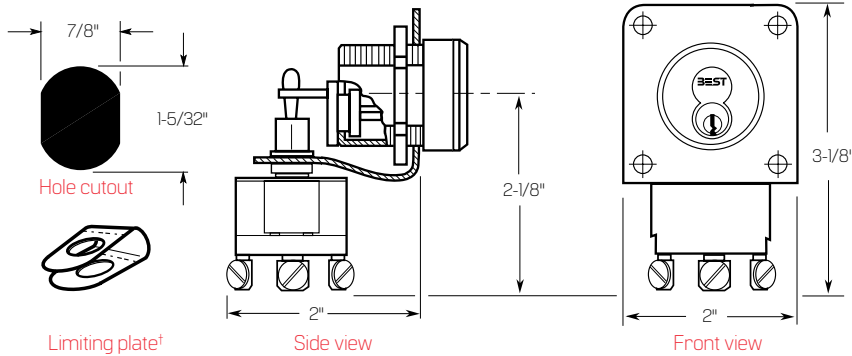

Key & switch positions

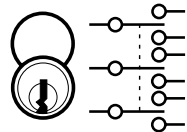

Key pos.1 – Swt. pos.1

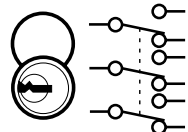

Key pos.2 – Swt. pos.2

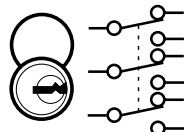

Key pos. 1 only – Swt. pos. 1

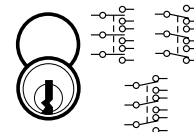

Key pos. 1 only
Swt. pos. 1, 2, and 3**

Remove key

Optional boxes

SWR

*Installing the limiting plate limits key removal to switch position 2, or 3. The key is always removed in the vertical position (key position 1).

1W7E4 Specifications

Contact rating – 110 VAC, 15 amps, resistive
220 VAC, 10 amps, resistive

Horsepower rating – 250 VAC, 1/2 HP

Operating temperature – up to +221°F (+105°C)

Switch type – DPDT (Double pole-double throw)

Switch lock action – Maintained

Number of switches per assembly – One



1W7K4

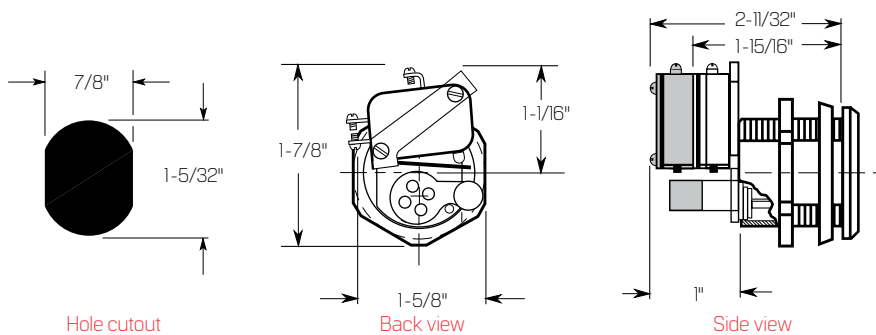

Key & switch positions

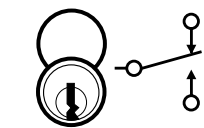

Key pos.1 – Swt. pos.1

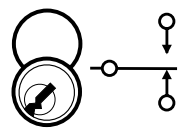

Key pos.2 – Swt. pos.2

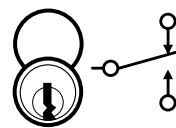

Key pos. 1 only - Swt. pos. 1

Remove key

Optional boxes

SWR

1W Electric Switch Locks (Continued)

1W7L2 Specifications

Contact rating – 110 VAC or VDC, 12 amps, resistive
220 VAC or VDC, 6 amps, resistive

Operating temperature – up to +221°F (+105°C)

Switch type – SPDT (Single pole-double throw)

Switch lock action – Maintained

Number of switches per assembly – One



1W7L2

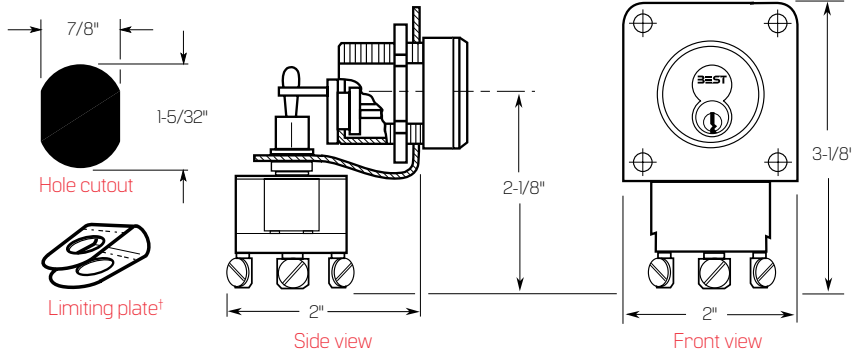

Key & switch positions

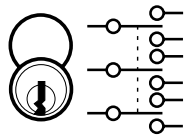

Key pos.1 – Swt. pos.1

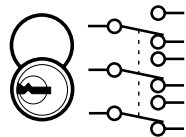

Key pos.2 – Swt. pos.2

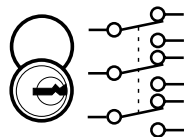

Key pos.1 only – Swt. pos.1

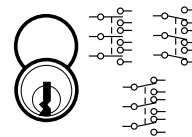

Key pos.1 only
Swt. pos.1, 2, and 3*

Remove key

Optional boxes

SWR

*Installing the limiting plate limits key removal to switch position 2, or 3. The key is always removed in the vertical position (key position 1).

1W7P4 & 1W7R4 Specifications

Contact rating – 30 VDC, 15 amps, resistive
125 VDC, 0.6 amps, resistive
250 VDC, 0.3 amps, resistive
125 VAC, 15 amps, resistive
125 VAC, 5 amps, lamp
250 VAC, 15 amps, resistive

Operating temperature – up to +176°F (+80°C)

Horsepower rating – 125–250 VAC, 1/2 HP

Switch type – SPDT (Single pole-double throw)

Switch lock action – Momentary

Number of switches per assembly – 1W7P4: Two, 1W7R4: Four

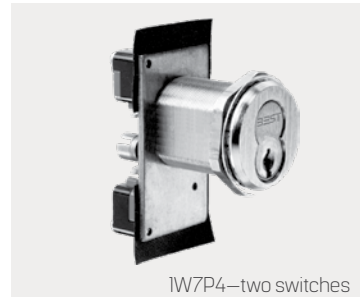

1W7P4—two switches

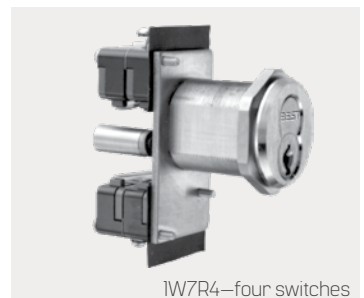

1W7R4—four switches

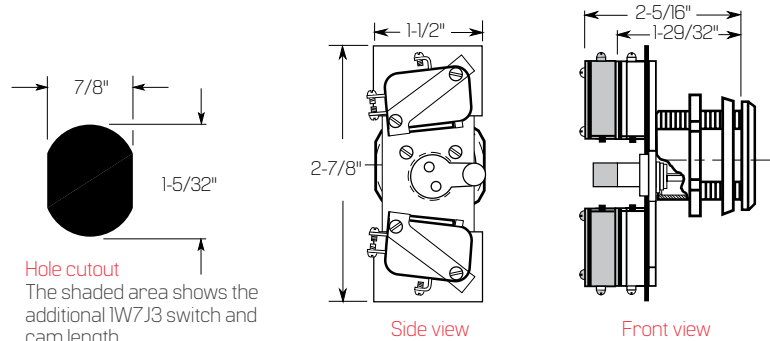

Hole cutout

The shaded area shows the additional 1W7J3 switch and cam length.

Key & switch positions

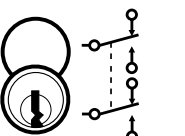

Key pos.1 – Swt. pos.1

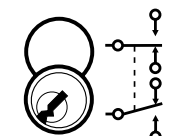

Key pos.2 – Swt. pos.2

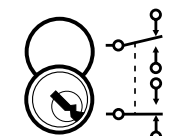

Key pos.1 only – Swt. pos.1

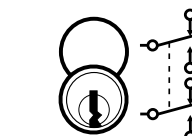

Key pos.1 only
Swt. pos.1, 2, and 3*

Remove key

Optional boxes

SWR

INT (1W7P4 only)

BEST Quick Connect System

BEST Quick Connect plug-in connectors must be used with the following components to work as a complete plug-and-play system:

1. Specify appropriate PRECISION or BEST electrified products
2. Specify correct wire harness length from door hardware to electric power transfer device or electrified hinge
3. Specify either the NEW electric power transfer (EPT-12C) or the NEW electrified hinge (CECB179-12C)
4. Specify correct wire harness length from power transfer or electrified hinge to wire extension (WH-6E)
5. Choose wire harness extension to connect to power source

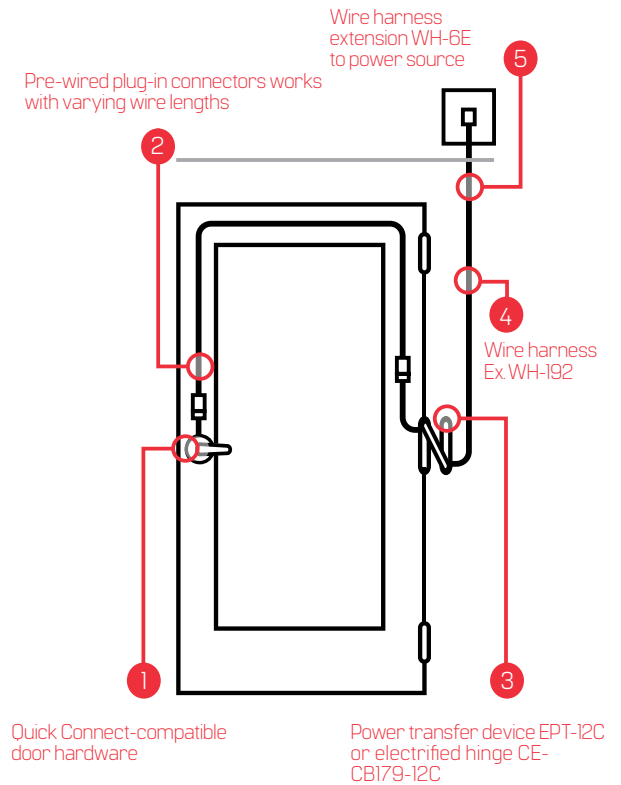

How To Order

To order the BEST Quick Connect pre-wired plug-in connectors, include the "C" suffix for the BEST electrified locks. See example below.

Example:

BEST Locks

45HW 7 DEL 14H 626 RH DSC

BEST Locks

9KW 37 DEU 15CS TK 626 24 VC



For questions about ordering and to be sure you get the right configuration for your needs, [contact your BEST dormakaba sales representative](#).
6161 East 75th Street, Indianapolis, IN 46250 USA | [855-365-2407](tel:855-365-2407) | bestaccess.com