



BEST 
dormakaba Group

Key and Core

by BEST



Setting the Standard for Security



Our Past: A Legacy of Innovation

The small format interchangeable core is still in use today. More than that, it is the basis for every other interchangeable core design currently being manufactured.



Our Present: Leadership in Security



BEST solutions and components form the pinnacle of today's toughest mechanical security solutions. Our unparalleled quality and engineering make us a top choice of distributors and customers worldwide.

Our products are built on the following pillars:

Quality

We design our locks to exceed expectations. With tight tolerances and top-quality materials, our keys and cores set the standard for security and functionality. BEST made the first small format interchangeable core in 1921, setting an industry standard that has been maintained for nearly a century. The small format interchangeable core also makes it simple and convenient to upgrade to BEST at a pace that works for you. Best of all, with the toughest mechanical hardware, BEST promises both durability and performance..

Customization and Key Control.

With a unique range of functionality and a superior masterkey system, BEST provides numerous combining options for a robust approach to your security.

Future-Ready

Our engineers use forwardthinking design for our hardware, cores and key systems to combat today's challenges, as well as anticipate possible threats in the future.

Setting the standard

Keys: Security, Control and Convenience



The unique way a key and core come together is the foundation of how every opening is secured. With our unique combining and keying, our distributors can ensure keys and cores work together in a way that not only ensures the integrity of every opening, but also makes them easy to maintain and manage over the life of the product.

We understand that choosing a key system is about more than the hardware installed on doors. It's about deploying a security philosophy with various product offerings that allow the customer to manage various access levels, permission rights and key management processes.

At BEST, we have patented and non-patented key systems that help you implement a robust and responsive security protocol. And best of all, we have significant experience in the industry to help you develop a system and approach that is custom-tailored to your facility and your people.



Keys can be personalized to an institution or organization. In addition to making them easier to identify, key stamping protects them against unauthorized duplication. Key stamping is provided for a one-time fee.

*There is no standard back key stamp for the IAP premium key

Key Anatomy

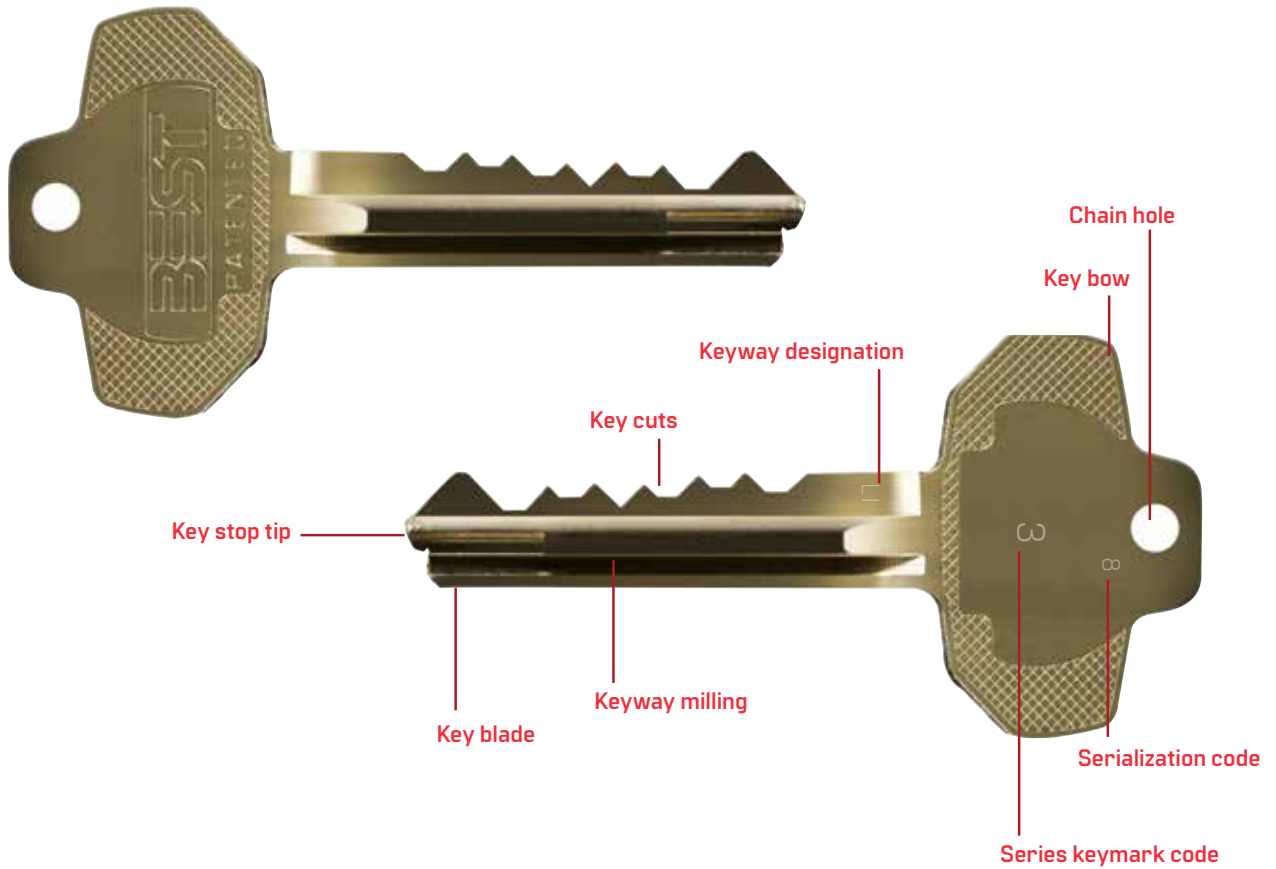

Key Types

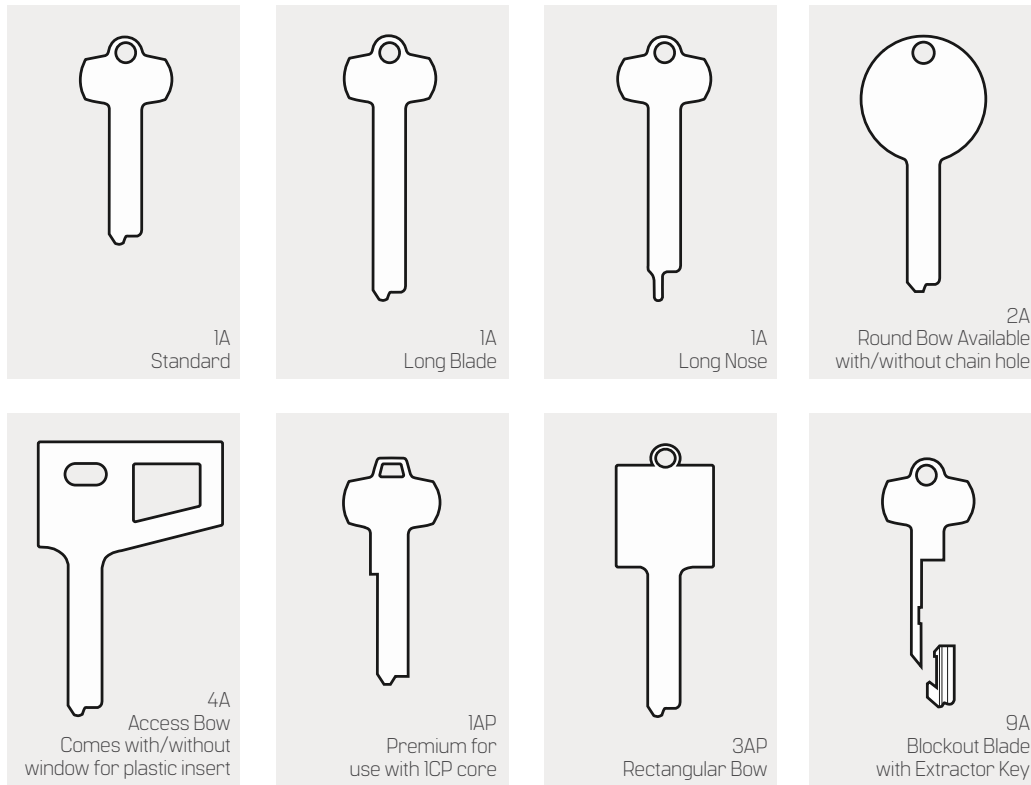

Cores: The Foundation of Mechanical Security



At the foundation of every BEST highquality key system is the core—one that is durable, flexible and easy to maintain. We invented the small format interchangeable core (SFIC) in 1921. Over time, our SFIC has only become more responsive to facilities and door openings as we've perfected it for smoother operation, more predictable performance and guaranteed longevity.

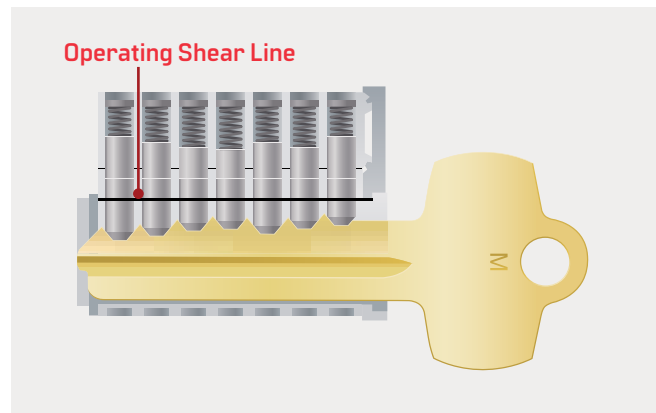
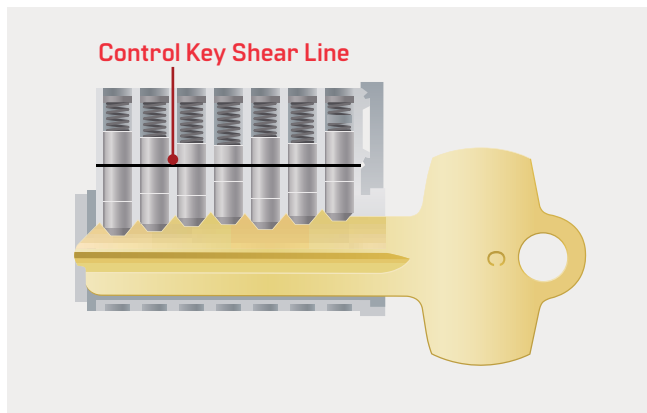

BEST cores are an industry standard for a number of reasons:

- Tight tolerances to provide the highest level of mechanical security and enhance the integrity of the lock
- 6- and 7-pin options to allow for a hybrid solution and ensure greatest number of key combinations
- Masterkeyed shear lines allow you to build multi-level access
- Brass alloy construction that is tough, strong and corrosion-resistant
- Individually capped chambers for easier maintenance and service
- BEST-constructed pin segments that help control tolerance and quality
- Stringent quality control that ensures every part of the core and lock meet our industry-high standards
- Warranty that stands behind every product we manufacture

Our cores are hardware specific. Please see our price book for available core options.

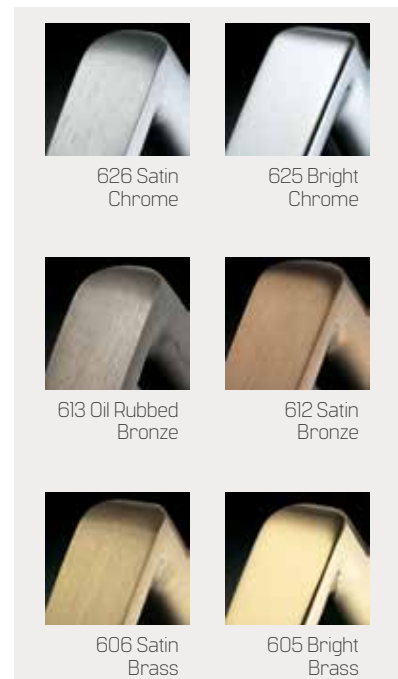

Core Anatomy

Cormax Core – Exploded View

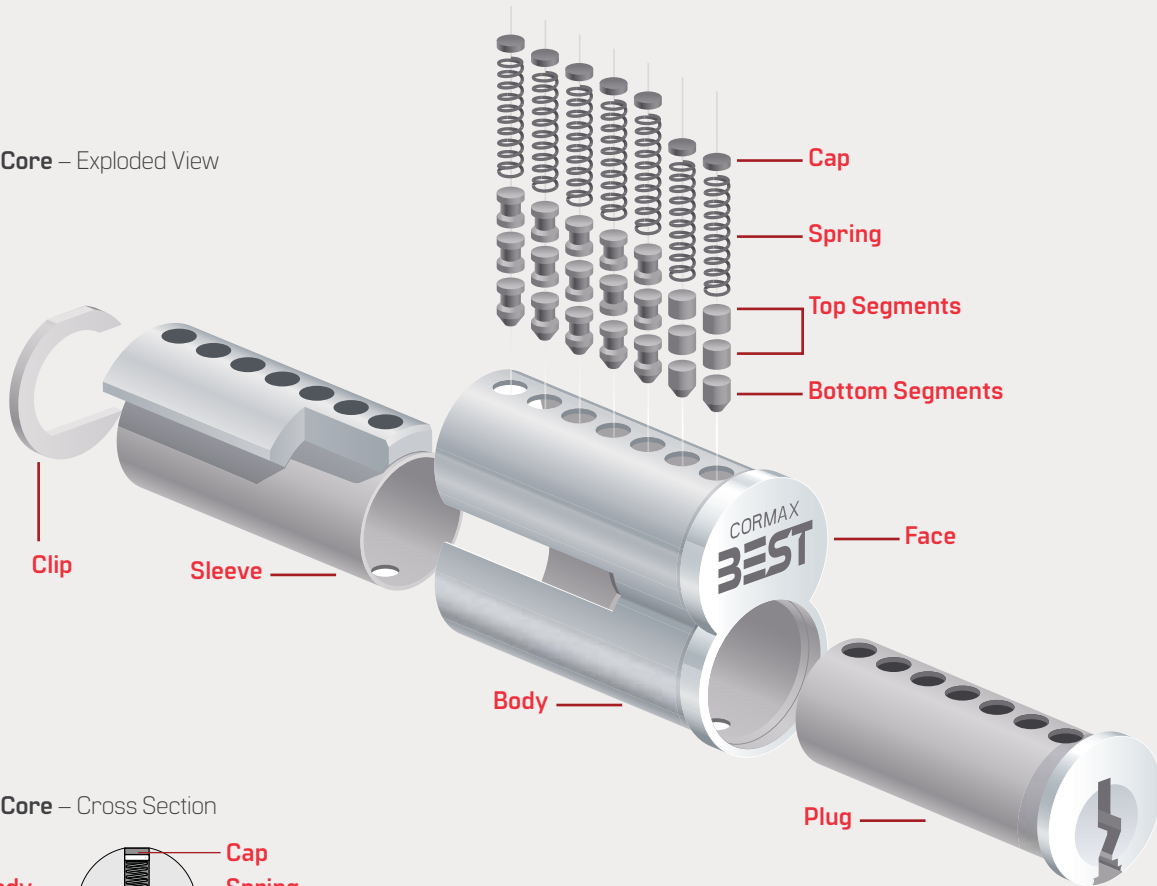

Cormax Core – Cross Section

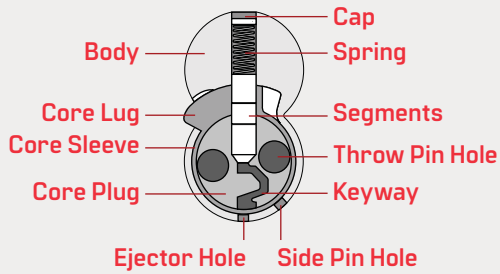

Core Types



CORMAX: Security, Control and Convenience



CORMAX™ is a premier patented key system that protects against unauthorized duplication of keys through 2027. Its unique patented key and side pin design ensure the highest level of mechanical security throughout a facility. Plus, because the CORMAX M Series operates on CORMAX and Standard cores, it is an ideal hybrid solution for retrofit projects. Facilities can add CORMAX to the perimeter and other high value openings, while maintaining their existing key system.

Increased Security

Patented through 2027, CORMAX delivers a higher security key system. Unauthorized duplication of keys is prohibited.

Geographic Exclusivity

CORMAX offers several levels of geographic exclusivity, including national exclusivity, depending on customer needs. All geographic exclusivity levels are protected against unauthorized duplication and distribution.

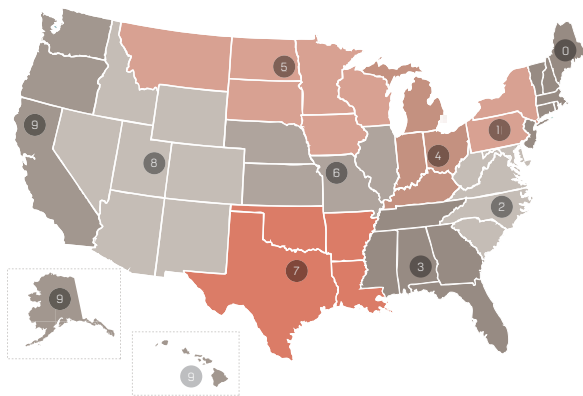

Flexibility

CORMAX seamlessly fits into any manufacturer's locking hardware requiring a small format interchangeable core (SFIC). CORMAX allows for customized masterkeying and quick core or key changes. CORMAX is also compatible with existing BEST service equipment—including standard-issue key cutting equipment—so there is no need to invest more money in a new key cutter or combining kit.

Service Options

With CORMAX, you can choose to handle service through our trusted network of distributors, or service your system in-house.

CORMAX Patented Keying System

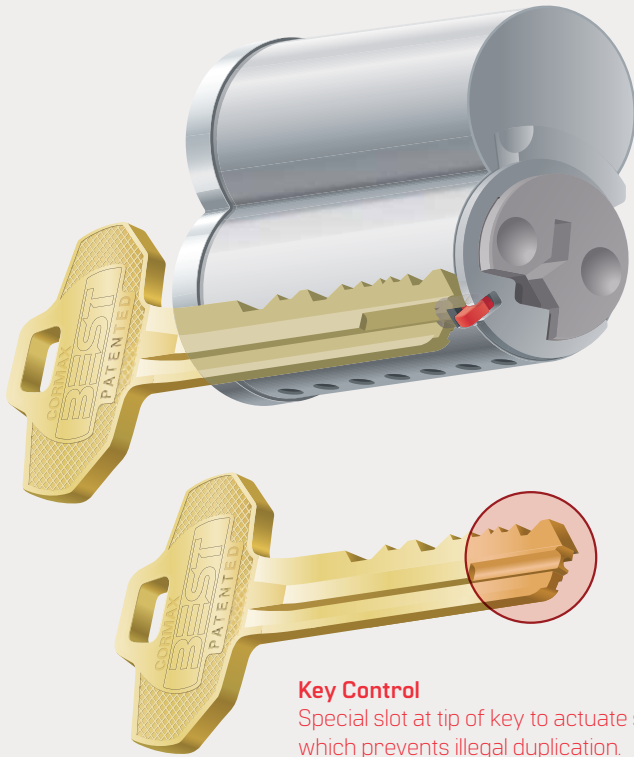

Key Control
Special slot at tip of key to actuate side pin which prevents illegal duplication.

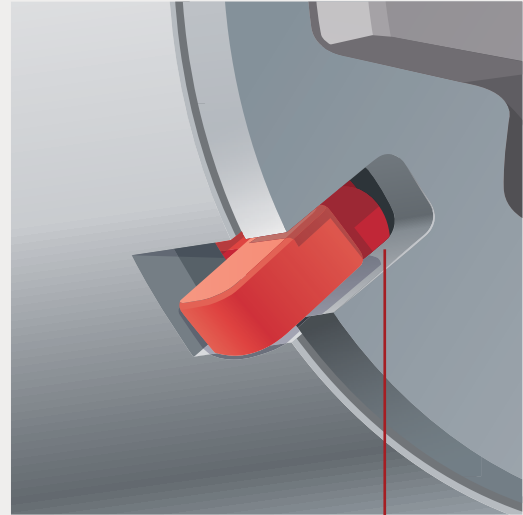

Enhanced Security
Patented side pin engages slot in core body, preventing rotation unless the proper CORMAX key is inserted.

CORMAX X Series and M Series

M Series

M Series keys operate both CORMAX and BEST Standard cores (backward compatibility) with J, K, L and M keyways, allowing for easier management of a hybrid keying solution. Available in large bow, long blade and long nose key blank, the M Series works with special applications and is designed to enable seamless, phase-in upgrades in large facilities and multi-building campuses.

X Series

X Series keyways offer even higher key duplication protection. Their thicker key blanks and larger bow provide extra strength and easier handling. The X Series is recommended for large facilities in multi-building campuses.

M Series Keys

Compatible with Standard and CORMAX cores

X Series Keys

With a thicker key blank, the X Series is compatible only with CORMAX cores

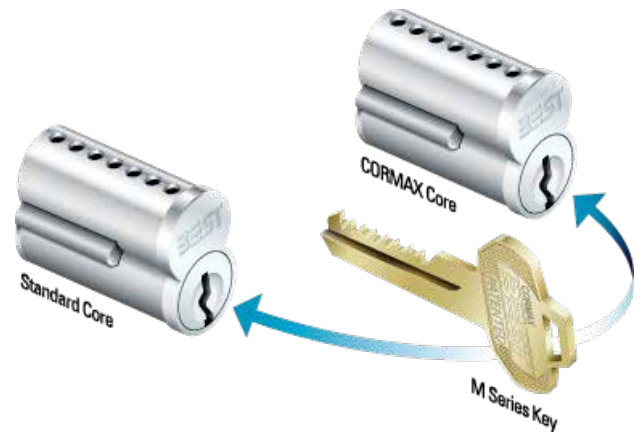

Standard and Premium: Quality, Durability and Reliability

For building projects where mechanical security is used to complement electronic access control, or key duplication doesn't need to be managed, BEST offers patented and non-patented key system options—all backed by BEST standards for quality, durability and reliability.

BEST Standard

For nearly 100 years, BEST Standard key systems have provided security, durability and performance in a wide range of applications. Engineered to the same high standards as our patented systems, BEST Standard cores are made to the same strict tolerances and high standards of excellence in manufacturing as our patented options to ensure quality, durability and performance you can trust.

BEST Standard key systems are durable and offer a wider range of options, providing the precise, carefully managed masterkey applications that make BEST one of the industry leaders for masterkeying. We actively support new and existing BEST Standard systems.

BEST Premium

BEST Premium utilizes our thickest key blank and is an ideal option for heavy traffic applications, making them more robust and far less prone to breakage and damage than other options. BEST Premium keys are larger and heavier than standard keys, so they hold up to strenuous daily use. Additionally, Premium options employ a paracentric keyway (keyline crosses center of core) that enhances security.

BEST Premium key systems are backed by BEST's exceptional depth of masterkey expertise, offering high-level control over assets and facilities. Managing our Premium key systems is simple as they are fully supported by BEST and our network of distributors.





BEST Retrofit Keying Options

BEST Preferred

The BEST Preferred system is a patented system through 2024. Backed by BEST's masterkey and key management expertise, the Preferred system is backwards compatible with all BEST Peaks systems.

BEST Peaks

BEST Peaks provides quality, durability and performance.

140 Series: This series is upgradeable with BEST Preferred components, allowing it to be effectively used as part of a hybrid solution in many retrofit projects. Additionally, the 140 Series can be used to secure facilities utilizing other manufacturers' hardware. All cylinders can be keyed into the same system, providing you the ability to operate all the locks at your facility using a single key, regardless of the lock manufacturer.

150 Series: For traditional BEST Interchangeable core applications, the 150 Series offers the security and convenience of a small format interchangeable core that will operate a wide variety of locking hardware, including cylindrical locks, padlocks, deadbolts and cabinet locks.

Masterkeying: The Core of Mechanical Security

With a mechanical key system, the level of security is determined by masterkey control. A masterkey system enables facilities of any size to manage the building by defining access by person and by area in increasing levels of complexity.

Since BEST invented the standard for masterkey systems, there is no company better suited to develop a custom-designed, scalable masterkey solution. For every BEST system, we apply our expertise to help you optimize key code application and maximize the life of the system. Our proprietary masterkey software—still unique in the industry today— generates masterkey codes and prevents cross keying to ensure the security and integrity of each door combined into a BEST system.

Additionally, in the event of key loss, a core can be rekeyed without total replacement, making it a responsive, low-maintenance, convenient solution that is a valuable investment for any building.

Our end user key control software available for purchase helps with the tedious task of managing your key and core records in today's environment, in which multiple people in different locations may need to access the data simultaneously.

The BEST System

In some cases, a mechanical system will be the sole security system. In others, it will complement an electronic access control system. Our BEST keying specialists can help determine if you need a patented system like CORMAX, or one that is non-patented but still provides solid security, such as our BEST Premium or Standard systems.



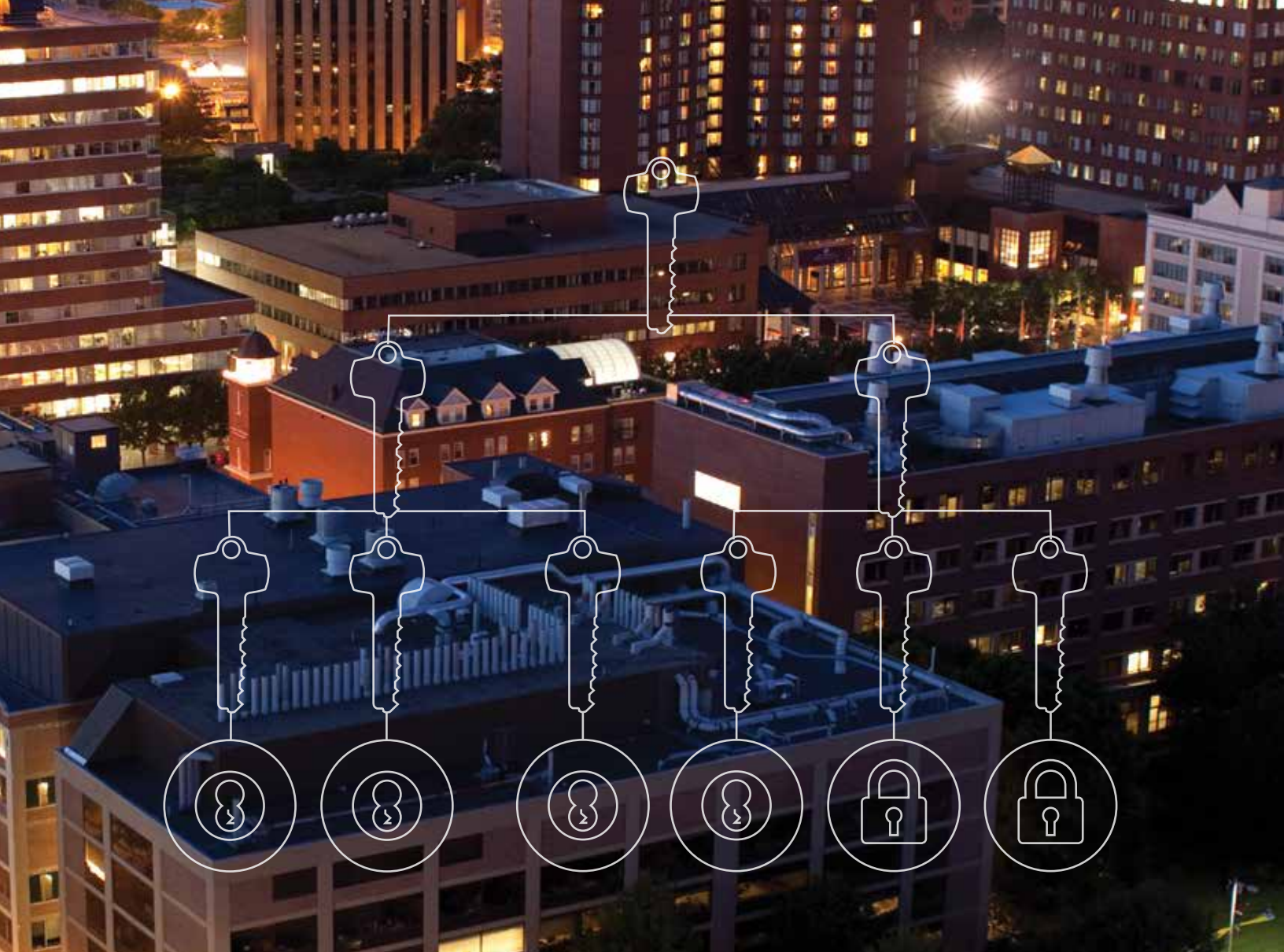

Important Questions to Masterkeying

New Construction

- What level of security do you want?
- Is it important to manage key duplication?
- How many levels of security do you need?
- Do you have high employee/tenant turnover rates?
- How much is mechanical security a part of your strategy?
- How will keys be managed and how will the system be maintained over the long term?
- Is it a single building or multiple buildings or locations?

OR

Retrofit

- What type of key system is currently in place?
- Why do you want to change or upgrade it?
- How many levels of security do you need?
- Do you have high employee/tenant turnover rates?
- How do keys get duplicated now?
Is that working?
- How do you want to manage key control as well as long-term maintenance?

Why BEST is SIMPLY the BEST

With access to BEST expertise and resources for the life of the system, it's easy to see why our customers stay loyal to the brand. Every aspect of our small format interchangeable cores and key systems—from engineering and manufacturing, to key control and long-term service—has been carefully designed with the security of the end user in mind.

Unparalleled Quality

BEST adheres to tight tolerances and the strictest manufacturing standards. With this laser focus on quality, we're able to consistently manufacture high-performance products. Our design and manufacturing practices give customers confidence they are receiving the highest level of key control and security.

Tight key control

When you choose a BEST key system, you not only get superior quality, durability and ease of use, but also access to the world's leading security infrastructure. Unauthorized duplication of keys is prohibited.

Leading Masterkey Management

With BEST, select distributors can have highly controlled access to our proprietary web-based masterkey software. This software generates masterkey codes that are designed to meet the exact requirements of a facility. Additionally, it ensures our distributors are following BEST masterkeying standards as they support customers and ensure the integrity and security of your BEST key system.

Ease of Service

Our team of dedicated key system specialists will support you and your BEST systems long after purchase. You receive continued masterkey support for the life of the system—completely free of charge. Plus, because of our smart design, when keys are lost, our interchangeable core makes it possible to change lock combinations with minimal effort and cost. Simply remove the core with your system's control key, insert a new core, issue new keys and update your records. There's no need for any lock disassembly or laborious service calls. Finally, with BEST's selfservice package, customers have the capability of combining or recombining cores and cutting new keys quickly and economically without compromising security. Keys are cut from registered codes on the combinatory so every BEST key is an original.



Maximizing Convenience. Optimizing Security.

We have the equipment you need to service keys and cores over the life of the key system. From key combiners and stamp cutters to core capping/decapping press and core/key marking blocks, we have the necessary equipment available to ensure you can combine a BEST core and generate new keys quickly.*

* See service equipment manual for a complete list of options.

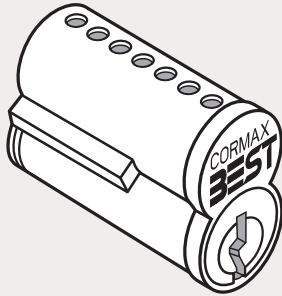

1CM

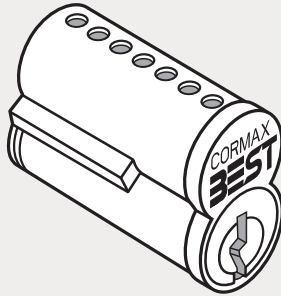

1CX

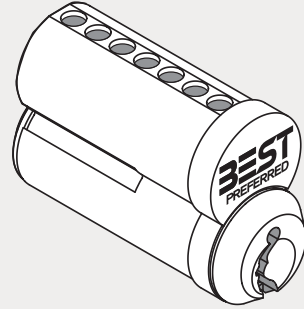

1CP

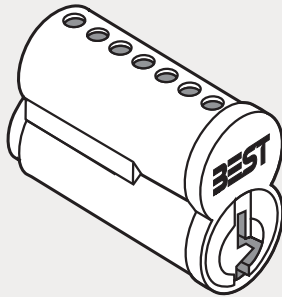

1CF

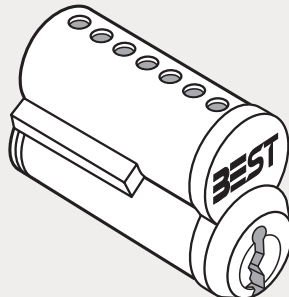

1CB

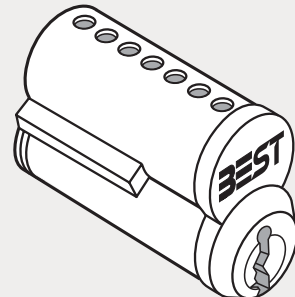

1CK

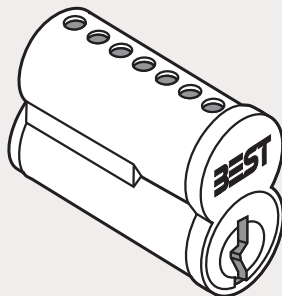

1C-7-pin

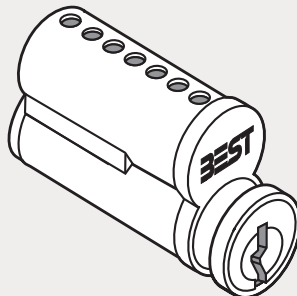

2C
Requires long blade key

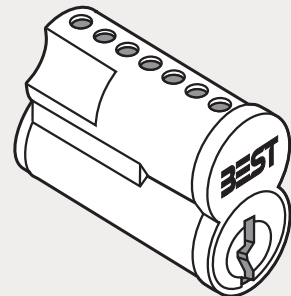

3C

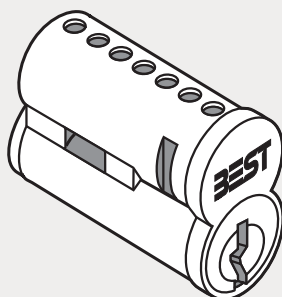

5C
Requires long blade key



6C

	Options For Keys	Options For Cores	Cormax M Series Core (ICM) / Key	Cormax X Series Core (ICX) / Key	Best Premium Core (ICP) / Key	Best Standard Core (IC) / Key	Best Preferred Core (ICF) / Key	Best Peaks Core (ICB) / Key
SFIC Core		x	▪	▪	▪	▪	▪	▪
BHMA A156.5 Grade 1 Certified		x	▪	▪	▪	▪	▪	▪
Patented Through (Year)	x	x	2027	2027			2024	
Unique Keyways Available	x	x	4	32+	8	29	10	10
Multi Mill Keys	x		▪	▪		▪	▪	▪
Key Material Thickness	x		0.106	0.106	0.145	0.097	0.09	0.09
Large Round Bow (2A)	x		▪			▪		
Large Rectangular Bow (3A)	x		▪			▪		
Access Bow Option (4A)	x		▪			▪		
Long Blade Option (B)	x		▪			▪		
Long Nose Option (N)	x		▪			▪	▪	▪
Special Key Stamp Option	x		▪	▪	▪	▪	▪	▪
Key Serialization Option (S)	x		▪	▪	▪	▪	▪	▪
"No Keyway Designation Option (NKW)	x					▪		
Blockout BladE (9A)	x		▪	▪	▪	▪	▪	▪
A2 System	x	x	▪	▪	▪	▪	▪	▪
A4 System	x	x	▪	▪	▪	▪	▪	▪
6 Pin Option		x	▪	▪		▪		▪
7 Pin Option		x	▪	▪	▪	▪	▪	▪
Finishes Available		x	8	8	8	8	4	3
Key Trap Option (K)		x	▪			▪		
Extended Plug Option (2C)		x	▪			▪		
Euro Option (3C)		x				▪		
High Security Option (5C)		x	▪			▪		
Sliding Door Lock Option (6C)		x			▪	▪		
5E Cylinder Option		x	▪	▪	▪	▪		
Drill Resistant (D) (B=D+P)		x	▪	▪	▪	▪	▪	▪
Pick Resistant Option (P)		x	▪	▪	▪	▪	▪	▪
Wear Resistant Option (W)		x	▪	▪	▪	▪	▪	▪
Core Face Mark Option		x	▪	▪	▪	▪		
Core Side Mark Option		x	▪	▪	▪	▪	▪	▪
140 Series (CK)	x	x					▪	▪
Convention Cylinder Option (3400 Series)		x					▪	▪
LFIC (6000 Series)		x					▪	▪
Punch Style Cutter	x		▪	▪	▪	▪		▪
4 Construction Core (icc)		x				▪		

How Can We Help?

If you have an existing BEST system

Call the BEST Customer Service Group at 855-365-2407.

If you have an existing system by another manufacturer

Contact your local BEST sales agent or find an agent near you at www.bestaccess.com/contactus.asp.

If you have a new construction facility

Find a local BEST distributor by calling the BEST Customer Service Group at 855-365-2407.

If you need specifications of any product

Contact your local BEST distributor for detailed specifications on any BEST product or solution. Our certified distributors can help you find the option that suits your application.



CORPORATE HEADQUARTERS

6161 EAST 75TH STREET
INDIANAPOLIS, IN 46250 USA

Phone 855-365-2407

bestaccess.com

For questions about ordering and to be sure you get the right configuration for your needs, [contact your BEST dormakaba sales representative](#).
6161 East 75th Street, Indianapolis, IN 46250 USA | [855-365-2407](tel:855-365-2407) | bestaccess.com