



**HD8000**  
**HD7000**  
**SL6000**

Surface Applied  
Door Closers



# TABLE OF CONTENTS

HD8000 Series.....	Pg 4
HD8000 Features & Certifications.....	Pg 4
How to order - HD8000.....	Pg 5
HD7000 Series.....	Pg 6
HD7000 Features & Certifications.....	Pg 6
How to order - HD7000.....	Pg 7
SL6000 Series.....	Pg 8
SL6000 Features & Certifications.....	Pg 8
How to order - SL6000.....	Pg 9
Pre-Fabricated Specifications (for spec writers).....	Pg 10
Finishes.....	Pg 12
Warranty Information.....	Pg 12
Technical Specifications.....	Pg 13

## ARM Selections

Round form arm (8mm & 10mm rods).....	Pg 14
Friction hold open arm.....	Pg 14
Plunger Hold open Arm.....	Pg 14
Flat form arm.....	Pg 15

Cushion IS arm.....	Pg 15
Spring stop IS arm.....	Pg 15
Super parallel arm.....	Pg 15
Door saver arm.....	Pg 16
Spring stop door saver arm.....	Pg 16
Track arms.....	Pg 16
Push side track.....	Pg 16
TDE Track.....	Pg 17

## Accessories

Sex nuts.....	Pg 17
Backplates.....	Pg 17
Conversion plate.....	Pg 18
Drop plate.....	Pg 18
Brackets.....	Pg 18 – 20
Slim plastic cover.....	Pg 20
Blade stop spacers.....	Pg 20



# HD8000 SERIES SURFACE CLOSERS



Versatile, durable, and reliable, featuring modern styling for institutional or high-traffic commercial applications.

BEST HD8000 series, Grade 1 hydraulic surface closers are housed in corrosion-resistant aluminum with a hardened pinion/piston providing toughness and high-strength. The arm hub is made from forged steel.

Standard on the HD8000 series closers are backcheck with two adjustment valves and adjustable spring size options from 1 - 6 or 5 - 6. The HD8000 series closers are ideal for a variety of heavy-duty, as well as barrier-free applications.

## HD8000—Features

- Available with fully adjustable spring sizes 1-6. Size 1 (5 lb opening force) meets interior barrier-free AD requirements.
- May be used on doors up to 48" wide interior (42" wide exterior) and up to 180 lb.
- Available with adjustable spring sizes of 5 -6 +50% for use on exceptionally wide, tall, or heavy doors.
- Non-handed for regular, top jamb, and parallel arm applications.
- Backcheck (BC) valve (standard) provides adjustable-intensity hydraulic cushioning, preventing uncontrolled door opening to protect door and frame during abusive or abrupt opening.
- AVB - advanced variable backcheck option maintains an effective backcheck range on parallel arm applications. Valve is accessible with the closer installed.
- Full adjustment using BC, Sweep and Latch valves standard.
- DA, AVB & AVB DA options with separate independent valve to allow for unobstructed passage through opening.
- Full plastic cover standard. Lead lined as well as full and oversized metal and plastic covers available to assist in concealing existing holes.
- All tamper-resistant (hex key) valve adjustments.
- Standard components required for three mounting configurations (Reg., TJ, PA).
- SNDTPK - Standard fasteners include separate self-drilling and self-tapping and sex nuts for 1-3/4" thick doors and machine screws.
- A variety of specialty arm options, interchangeable across most surface closer models.
- Full complement of optional plates and brackets available for special applications

## HD8000—Certification

- ANSI/BHMA A156.4 Grade 1 certified
- UL and CUL listed
- Meets UL10C for positive pressure
- Meets ANSI/BHMA A117.1 and ADA for barrier-free accessibility.



dormakaba USA quality and environmental management systems in Reamstown, PA and Indianapolis, IN are certified to ISO 9001:2015 and ISO 14001:2015.

# HD8000 How to order

## BEST Surface Door Closers

Series	Spring Size	Body Options	Arm	Cover Options	ACC Brackets	Fasteners	ACC Plates	ACC Other	Finish
HD80	16	DA	<b>AF80P</b>	<b>PC</b>	<b>Specify</b>	<b>SNDTPK</b>	<b>Specify</b>	<b>Specify</b>	<b>689</b>

(Bold are standard selections; or specify from available options)

HD80	16 Adjustable size 1-6 to meet barrier-free ADA requirements	DA Delayed action AVB Advanced variable backcheck	AF80P, AF80J, FH, FHP, FHJ, PH, PHP, DS, DS/R, DS/RCP, DST, DST/R, DST/RCP, SDS, SDS/R, SDS/RCP, SDST, SDST/R, SDST/RCP, IS, ISH, SIS, SISJ, ISJ, ISJH, SISJ, SISJH, SPA, SPA/R, SPA/RCP, SPAT, SPAT/R, SPAT/RCP, EMF, T, FT, JT, PT, TDE, TH, FTH, JTH, PTH, PTH, TDEH, LA	PC Plastic OPC Oversize plastic MC Metal LL Lead lined	PD PFT PHB MJ P80	SNDTPK - Self-drilling, self-tapping, thru bolts 1 3/4" door with machine screws TX80 - Torx security screws	BP80 DP80 CP4111 CP4040	AB80 BS BSHD NFHD FTHD BSNFHD	<b>Painted:</b> 600 Primed 689 Aluminum 691 Dull bronze 693 Black 695 Dark duranodic bronze 696 Gold <b>Plated:</b> 605 Polished brass 606 Satin brass 611 Polished bronze 612 Satin bronze 613 Satin oil-rubbed bronze 618 Polished nickel 619 Satin nickel 625 Polished chrome 626 Satin chrome
------	--	---	---	--	-------------------------------	---	----------------------------------	--	---

HD80

Spring size	Description
16	Adjustable size 1-6 to meet barrier-free ADA requirements
56	Adjustable size 5-6 +50% power over size 6 to meet PT4C requirements

### Accessories

Item	Description	Item	Description
AF80P	Standard flat form arm, tri-pack	SISJH	Heavy duty top jamb arm with hold open and compression stop for 3-1/2"-6-1/2" reveal
AF80J	Top jamb flat form arm for 4-8" reveal	SPA	Heavy duty parallel arm
FH	Friction hold open arm	SPA/R	Heavy duty parallel arm with LCN PA foot
FHP	Friction hold open arm, tri-pack	SPA/RCP	Heavy duty parallel arm with LCN PA foot & CP4040 conversion plate
FHJ	Top jamb friction hold open arm for 4-8" reveal	SPAT	Heavy duty parallel arm with thumb-turn hold open
PH	Regular/Top jamb plunger hold open arm	SPAT/R	Heavy duty parallel arm, thumbturn hold open with LCN PA foot
PHP	Parallel/Top jamb plunger hold open arm	SPAT/RCP	Heavy duty parallel arm, thumbturn hold open with LCN PA foot & CP4040 conversion plate
DS	Heavy duty parallel arm with stop	T	Track arm, pull side door mounted
DS/R	Heavy duty parallel arm, stop with LCN PA foot	FT	Flush track arm, push side transom mounted
DS/RCP	Heavy duty parallel arm, stop with LCN PA foot & CP4040 conversion plate	JT	Jamb track, pull side frame mounted
DST	Heavy duty parallel arm with hold open and stop	PT	Push track arm, push side soffit mounted
DST/R	Heavy duty parallel arm, stop with LCN PA foot	TDE	Track arm double egress, pull side frame mounted
DST/RCP	Heavy duty parallel arm, stop with LCN PA foot & CP4040 conversion plate	TH	Track arm with hold open, pull side door mounted
SDS	Heavy duty parallel arm with compression stop	FTH	Flush track arm with hold open, push side transom mounted
SDS/R	Heavy duty parallel arm, hold open, compression stop with LCN PA foot	JTH	Jamb track with hold open, pull side frame mounted
SDS/RCP	Heavy duty parallel arm, hold open, compression stop with LCN PA foot & CP4040 conversion plate	PTH	Push track arm with hold open, push side soffit mounted
SDST	Heavy duty parallel arm with hold open and compression stop	TDEH	Track arm with hold open double egress, pull side frame mounted
IS	Heavy duty regular/top jamb arm with stop	M8X30	Arm screw only (arm type determines screw)
ISH	Heavy duty regular/top jamb arm with hold open and stop	M8X16	Arm screw only (arm type determines screw)
SIS	Heavy duty regular/top jamb arm with compression stop	SNDTPK80	Standard self-drilling, self tapping and through bolts (replacement pack)
SISH	Heavy duty regular/top jamb arm with hold open and compression stop	PC80	Cover Option standard full size plastic cover
ISJ	Heavy duty top jamb arm with stop for 3-1/2"-6-1/2" reveal	OPC80	Cover Option over-sized plastic cover
ISJH	Heavy duty top jamb arm with hold open and stop for 3-1/2"-6-1/2" reveal	MC80	Cover Option non handed metal cover
SISJ	Heavy duty top jamb arm with compression stop for 3-1/2"-6-1/2" reveal	OMC80	Over-sized non handed metal cover
SPA/R	Heavy duty parallel arm with LCN PA foot	LL80	Cover Option non handed lead lined cover

See Price Book for descriptions and options for arms, covers, brackets, fasteners, plates and other accessories.

# HD7000 SERIES SURFACE CLOSERS



The HD7000 surface closer offer modern styling and versatility while providing safe and reliable door control.

With features like the full range spring power adjustment, the HD7000 Series closer provides the flexibility needed to meet the many demands of commercial and institutional applications, including ADA barrier-free accessibility requirements.

This door control is housed in corrosion-resistant aluminum, and features a backcheck positioning adjustment for parallel arm applications, to maintain an ANSI backcheck range similar to regular and top jamb applications. Standard full cover, optional slim cover, flat form arm, and architectural finishes provide the aesthetic qualities required of architectural grade closers.

## HD7000—Features

- Available as HD7000 closers for interior and exterior doors. Meets barrier-free requirements (adjustable size 1 -6).
- Non-handed for regular, top jamb and parallel arm applications.
- Adjustable backcheck standard. Controls opening motion during abusive or abrupt opening.
- POS backcheck positioning valve (standard) maintains effective backcheck range on parallel arm applications. Valve accessible with closer installed.
- Optional delayed action adjustable with a separate independent valve. Delays door closing to allow unobstructed passage through the opening.
- Full plastic cover is standard; slim plastic, metal, or lead lined optional.
- Designed to minimize change in closing speed during severe temperature changes.
- Aesthetically pleasing and easy to adjust arm assembly.
- Full complement of optional arms, plates, and brackets available for special applications.
- No slip bore spring adjustment standard.
- SNDTPK - Standard fasteners include separate self-drilling and self-tapping and sex nuts for 1-3/4" thick doors and machine screws.

## HD7000—Certification

- ANSI/BHMA A156.4 Grade 1 certified
- UL and CUL listed
- Meets UL10C for positive pressure
- Meets ANSI/BHMA A117.1 and ADA for barrier-free accessibility.



dormakaba USA quality and environmental management systems in Reamstown, PA and Indianapolis, IN are certified to ISO 9001:2015 and ISO 14001:2015.

# HD7000 How to order

# BEST Surface Door Closers

Series	Spring Size	Body Options	Arm	Cover Options	ACC Brackets	Fasteners	ACC Plates	ACC Other	Finish
HD70	16	DA	ARP	FPC	Specify	SNDTPK	Specify	Specify	689

(Bold are standard selections; or specify from available options)

HD70	16 Adjustable size 1-6 to meet barrier-free ADA requirements	DA Delayed action	ARP, ARJ, A80P, FH, FHP, FHJ, PH, PHP, DS, DST, SDS, SDST, IS, ISH, SIS, SISH, ISJ, ISJH, SISJ, SISJH, SPA, SPA/R, SPA/RCP, SPAT, EMF, T, FT, JT, PT, TDE, TH, FTH, JTH, PTH, PTH, TDEH, LA	FPC Full Plactic SPC Sim Plastic MC Metal LL Lead Lined	PD PFT PHB MJ P70	SNDTPK - Self-drilling, self-tapping, thru bolts 1 3/4" door with machine screws TX70 - Torx security screws	BP70 BP70FC BP70T BP70TFC BP70FT-FC DP70 DP70FC	AB70 BS BSHD NFHD FTHD BSNFHD	<b>Painted:</b> 600 Primed 689 Aluminum 691 Dull bronze 693 Black 695 Dark duranodic bronze 696 Gold <b>Plated:</b> 605 Polished brass 606 Satin brass 611 Polished bronze 612 Satin bronze 613 Satin oil-rubbed bronze 618 Polished nickel 619 Satin nickel 625 Polished chrome 626 Satin chrome 630 Satin stainless
------	--	-------------------	---	--	-------------------------------	---	---	--	--

HD70

Spring size	Description
16	Adjustable size 1-6 to meet barrier-free ADA requirements

### Accessories

Item	Description
ARP	Standard round form arm, tri-pack SPA Heavy duty parallel arm
ARJ	Top jamb round form arm for 4-8" reveal SPAT Heavy duty parallel arm with thumb-turn hold open
AQBP	Secured round form arm, tri-pack EMF Electric hold open track arm
FH	Friction hold open arm T Track arm, pull side door mounted
FHP	Friction hold open arm, tri-pack FT Flush track arm, push side transom mounted
FHJ	Top jamb friction hold open arm for 4-8" reveal JT Jamb track, pull side frame mounted
PH	Regular/Top jamb plunger hold open arm PT Push track arm, push side soffit mounted
PHP	Parallel/Top jamb plunger hold open arm TDE Track arm double egress, pull side frame mounted
DS	Heavy duty parallel arm with stop TH Track arm with hold open, pull side door mounted
DST	Heavy duty parallel arm with hold open and stop FTH Flush track arm with hold open, push side transom mounted
SDS	Heavy duty parallel arm with compression stop JTH Jamb track with hold open, pull side frame mounted
SDST	Heavy duty parallel arm with hold open and compression stop PTH Push track arm with hold open, push side soffit mounted
IS	Heavy duty regular/top jamb arm with stop TDEH Track arm with hold open double egress, pull side frame mounted
ISH	Heavy duty regular/top jamb arm with hold open and stop M8X30 Arm screw only (arm type determines screw)
SIS	Heavy duty regular/top jamb arm with compression stop M8X16 Arm screw only (arm type determines screw)
SISH	Heavy duty regular/top jamb arm with hold open and compression stop SNDTPK70 Standard self-drilling, self tapping and through bolts (replacement pack)
ISJ	Heavy duty top jamb arm with stop for 3-1/2"-6-1/2" reveal MC70L or MC70R Handed metal cover
ISJH	Heavy duty top jamb arm with hold open and stop for 3-1/2"-6-1/2" reveal LL70L / LL70R Handed lead lined cover
SISJ	Heavy duty top jamb arm with compression stop for 3-1/2"-6-1/2" reveal
SISJH	Heavy duty top jamb arm with hold open and compression stop for 3-1/2"-6-1/2" reveal

See Price Book for descriptions and options for arms, covers, brackets, fasteners, plates and other accessories.

# SL6000 SERIES SURFACE CLOSERS



The SL6000 Series surface closer offer modern styling and versatility while providing safe and reliable door control.

Featuring backcheck and adjustable spring sizes, SL6000 is the ideal solution in a wide variety of applications, including barrier-free. This Grade 1 hydraulic surface door closer is both flexible and easy to install. The SL6000 offers a compact design and is available in a variety of sprayed finishes to complement any opening's decor.

## SL6000—Features

- Available with adjustable spring sizes 1–4 and with adjustable spring sizes 3–6.
- Meets 5 lb interior barrier-free applications. (SL6014 only)
- Non-handed for regular, top jamb and parallel arm applications.
- Quick and easy to install.
- Compact design.
- Two noncritical adjusting valves (sweep and latch) with thermostatic properties work to provide consistent closing speeds under a wide variety of temperatures.
- Adjustable backcheck standard. Provides cushioning when the door is abusively opened.
- Available with optional delayed action to delay door closing from maximum opening. Delay time is adjustable.
- SNDTPK - Standard fasteners include separate self-drilling and self-tapping and sex nuts for 1-3/4" thick doors and machine screws.
- SL640C mounting bracket can be used when installing into a 9-1/16" template hole pattern.
- Optional slim plastic cover

## SL6000—Certification

- ANSI/BHMA A156.4 Grade 1 certified
- UL and CUL listed
- Meets UL10C for positive pressure



dormakaba USA quality and environmental management systems in Reamstown, PA and Indianapolis, IN are certified to ISO 9001:2015 and ISO 14001:2015.



# SL6000 How to order

# BEST Surface Door Closers

Series	Spring Size	Options	Arm	Cover Options	ACC Brackets	Fastners	ACC Plates	ACC Other	Finish
SL60	14	DA	<b>ARP</b>	SPC	Specify	<b>SNDTPK</b>	Specify	Specify	<b>689</b>

(Bold are standard selections; or specify from available options)

SL60	16 Adjustable size 1-6 to meet barrier-free ADA requirements  36 Adjustable size 3-6	DA Delayed action	ARP, ARJ, A80P, FH, FHP, FHJ, PH, PHP, DS, DST, SDS, SDST, IS, ISH, SIS, SISH, ISJ, ISJH, SISJ, SISJH, SPA, SPA/R, SPA/RCP, SPAT, EMF, T, FT, JT, PT, TDE, TH, FTH, JTH, PTH, PTH, TDEH, LA	SPC Sim Plastic	PD PFT PHB MJ P60	SNDTPK - Self-drilling, self-tapping, thru bolts 1 3/4" door with machine screws TX70 - Torx security screws	BP60 BP60T DP60 SL640C	AB60 BS BSHD NFHD FTHD BSNFHD	Painted 600 Primed 689 Aluminum 691 Dull bronze 693 Black 695 Dark duranodic bronze 696 Gold
------	--	-------------------	---	-----------------	-------------------------------	---	---------------------------------	--	--

SL60

Spring size	Description
14	Adjustable size 1-4 to meet barrier-free ADA requirements
36	Adjustable size 3-6

## Accessories

Item	Description
ARP	Standard round form arm, tri-pack
ARJ	Top jamb round form arm for 4-8" reveal
A08P	Secured round form arm, tri-pack
FH	Friction hold open arm
FHP	Friction hold open arm, tri-pack
FHJ	Top jamb friction hold open arm for 4-8" reveal
DS	Heavy duty parallel arm with stop
DST	Heavy duty parallel arm with hold open and stop
SDS	Heavy duty parallel arm with compression stop
SDST	Heavy duty parallel arm with hold open and compression stop
IS	Heavy duty regular/top jamb arm with stop
ISH	Heavy duty regular/top jamb arm with hold open and stop
SIS	Heavy duty regular/top jamb arm with compression stop
SISH	Heavy duty regular/top jamb arm with hold open and compression stop
ISJ	Heavy duty top jamb arm with stop for 3-1/2"-6-1/2" reveal
ISJH	Heavy duty top jamb arm with hold open and stop for 3-1/2"-6-1/2" reveal
SISJ	Heavy duty top jamb arm with compression stop for 3-1/2"-6-1/2" reveal
SISJH	Heavy duty top jamb arm with hold open and compression stop for 3-1/2"-6-1/2" reveal
SPA	Heavy duty parallel arm
SPAT	Heavy duty parallel arm with thumb-turn hold open
T	Track arm, pull side door mounted
FT	Flush track arm, push side transom mounted
JT	Jamb track, pull side frame mounted
PT	Push track arm, push side soffit mounted
TDE	Track arm double egress, pull side frame mounted
TH	Track arm with hold open, pull side door mounted
FTH	Flush track arm with hold open, push side transom mounted
JTH	Jamb track with hold open, pull side frame mounted
PTH	Push track arm with hold open, push side soffit mounted
TDEH	Track arm with hold open double egress, pull side frame mounted
SL640C	Drop plate for PA mounted closer body to doors' top rail or TJ w/ restricted ceiling clearance for use w/ FPC cover
M8X30	Arm screw only (arm type determines screw)
M8X16	Arm screw only (arm type determines screw)
SNDTPK70	Standard self-drilling, self tapping and through bolts (replacement pack)

See Price Book for descriptions and options for arms, covers, brackets, fasteners, plates and other accessories.

- A. Surface Door Closers (specifier: include 30 year warranty in Part 1 – Warranty section)
1. Manufacturers; Surface Mounted:
    - a. Best by dormakaba USA, Inc.
      - HD8000 Series;
      - HD7000 Series;
      - SL6000 Series;
      - or None - N/A
    - (<https://www.bestaccess.com/products/door-closers/>)
  2. Rack and Pinion Aluminum Surface Closers (Heavy Duty – HD8000)
    - a. Provide Full Rack and Pinion type closer constructed of DIN 266 Aluminum Alloy, or equal, to exceed the ANSI/BHMA A156.4 Grade 1 requirements.
    - b. Provide closers tested and approved for UL10C for positive pressure; UL228 & CAN/ULC-S133.
    - c. Provide closers that conform to ANSI/ICC A117.1 and ADA requirements for barrier-free accessibility.
    - d. Closer shall be available with heavy-duty arms and knuckles/elbows
    - e. Closer shall have maximum 2 7/16 inch case projection with non-ferrous cover.
      - 1) Closer cover to be:
        - a) Plastic (default)
        - b) Oversized Plastic
        - c) Metal
        - d) Lead Lined
      - 2) Closer cover finish to be:
        - a) Painted
        - b) Plated
        - c) RAL Custom Color Powder Coated
    - f. Provide closers with all-weather hydraulic fluid.
    - g. Provide closers with separate adjusting valves for closing and latching speeds, as well as advanced backcheck and delayed action.
    - h.
      - I. Provide closers with Delayed Action and/or Advanced Backcheck where noted in hardware sets (HD8000)
      - II. Provide closers with backcheck positioning & DA valve (HD7000)
      - III. Provide closers with Delayed action only (SL6000)
    - i. Provide adapter plates, shim spacers and blade stop spacers as required by frame and door conditions.
    - j. Mount closers on non-public side of door and stair side of stair doors, unless otherwise noted in hardware sets.
    - k. Closers shall be non-handed and multi-sized as noted in hardware sets. When specific sized closers are required provide:
      - 1) Size 1 through 6 to meet barrier- free ADA requirements - HD8016
      - 2) Size 5 through 6 - +50% power over size 6 to meet PT4C requirements - HD8056
  3. Rack and Pinion Aluminum Surface Closers (Heavy Duty – HD7000)
    - a. Provide Full Rack and Pinion type closer constructed of DIN 266 Aluminum Alloy, or equal, to exceed the ANSI/BHMA A156.4 Grade 1 requirements.
    - b. Provide closers tested and approved for UL10C for positive pressure; UL228 & CAN/ULC-S133.

- c. Provide closers that conform to ANSI/ICC A117.1 and ADA requirements for barrier-free accessibility.
  - d. Closer shall be available with heavy-duty arms and knuckles/elbows
  - e. Closer shall have maximum 2 1/8 inch case projection with non-ferrous cover.
    - 1) Closer cover to be:
      - a) Plastic (default)
      - b) Slim Line Plastic
      - c) Metal
      - d) Lead Lined
    - 2) Closer cover finish to be:
      - a) Painted
      - b) Plated
      - c) RAL Custom Color Powder Coated
  - f. Provide closers with all-weather hydraulic fluid.
  - g. Provide closers with separate adjusting valves for closing and latching speeds, as well as advanced backcheck and delayed action.
  - h.
    - I. Provide closers with Delayed Action and/or Advanced Backcheck where noted in hardware sets (HD8000)
    - II. Provide closers with backcheck positioning & DA valve (HD7000)
    - III. Provide closers with Delayed action only (SL6000)
  - i. Provide adapter plates, shim spacers and blade stop spacers as required by frame and door conditions.
  - j. Mount closers on non-public side of door and stair side of stair doors, unless otherwise noted in hardware sets.
  - k. Closers shall be non-handed and multi-sized as noted in hardware sets. Provide closers fully adjustable to Sizes 1 through 6 to meet barrier- free ADA requirements.
4. Rack and Pinion Aluminum Surface Closers (Slim Line SL6000)
- a. Provide Full Rack and Pinion type closer constructed of DIN 266 Aluminum Alloy, or equal, to meet the ANSI/BHMA A156.4 Grade 1 requirements.
  - b. Provide closers tested and approved for UL10C for positive pressure; UL228 & CAN/ULC-S133.
  - c. Provide closers that conform to ANSI/ICC A117.1 and ADA requirements for barrier-free accessibility.
  - d. Closer shall be available with heavy-duty arms and knuckles/elbows
  - e. Closer shall have maximum 2 1/8 inch case projection with non-ferrous cover.

**Optional Specification Writings: (for spec writers)**

- 1) Closer cover to be:
  - a) No Cover (default)
  - b) Slim Line Plastic
- 2) Closer cover finish to be:
  - a) Painted
  - b) RAL Custom Color Powder Coated
- f. Provide closers with all-weather hydraulic fluid.
- g. Provide closers with separate adjusting valves for closing and latching speeds, as well as backcheck and delayed action.

- h.
  - I. Provide closers with Delayed Action and/or Advanced Backcheck where noted in hardware sets (HD8000)
  - II. Provide closers with backcheck positioning & DA valve (HD7000)
  - III. Provide closers with Delayed action only (SL6000)
- i. Provide adapter plates, shim spacers and blade stop spacers as required by frame and door conditions.
- j. Mount closers on non-public side of door and stair side of stair doors, unless otherwise noted in hardware sets.
- k. Closers shall be non-handed and multi-sized as noted in hardware sets. When specific sized closers are required provide:
  - a) Size 1 through 4 to meet barrier- free ADA requirements – SL6014
  - b) Size 3 through 6 – SL6036

Finishes (Painted)		Finishes (Plated) - HD8000 & HD7000 only	
600	Primed	605	Polished brass
689	Aluminum (Standard)	606	Satin brass
690	Statuary bronze	611	Polished bronze
691	Dull bronze	612	Satin bronze
693	Black	613	Oxidized satin oil-rub bronze
695	Dark duranodic bronze	618	Polished nickel
696	Gold	619	Satin nickel
Custom Color (RAL color) Designer color match		625	Polished chrome
		626	Satin chrome
		630	Satin stainless (HD7000 only)



## Warranty

For details, refer to BEST Warranty Policy on our website at <https://www.bestaccess.com/products/door-closers/>.

**REDUCED OPENING FORCE INSTALLATIONS CAUTION:** Manual door closers, including those certified to meet ANSI/ BHMA A156.4, when installed and adjusted to conform to ADA or other reduced opening force requirements, may not provide sufficient power to reliably close and latch a door.

Refer to catalog for Low Energy Operator to meet reduced opening force requirements without affecting closing power.

## Technical Specifications

Features	SL6000	HD7000	HD8000
			
Spring sizes	1-4* & 3-6	1-6	1-6, 5-6 (w+50% pwr)
Non-handed	Standard	Standard	Standard
Full line of specialty function arms and plates	Standard	Standard	Standard
Backcheck positioning adjustment (POS)	N/A	Standard	Optional (AVB)
Controlled closing with two adjustment valves	180°-10° 10°-0°	180°-10° 10°-0°	180°-15° 15°-0°
Backcheck	Standard	Standard	Standard
Delayed action	Optional	Optional	Optional
Hold Open	Optional	Optional	Optional
Self-drilling & Self-tapping screws	Standard	Standard	Standard
Tamper-resistant TORX screws	Optional	Optional	Optional
Slim plastic cover	Optional	Optional	N/A
Full plastic cover	N/A	Standard	Standard
Over-sized plastic cover	N/A	N/A	Optional
Full metal cover	N/A	Optional	Optional
Lead-lined metal cover	N/A	Optional	Optional
Over-sized metal cover	N/A	N/A	Optional
* Meets 5 lb maximum opening force on 3'-0" wide interior doors.			

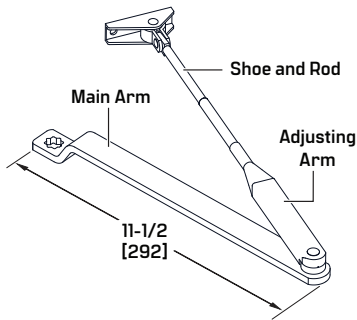

**Round Form Arm (8 mm rod)**

**AR (HD7000 & SL6000 only)** – Complete Arm Assembly (0"–4" [0 mm–102 mm] reveal) with 8 mm rod. Arm is non-handed.

**ARP (HD7000 & SL6000 only)** – Parallel round form arm complete (Tri-Pack) (0"–4" [0 mm–102 mm] reveal). P60 (PL70 - HD7000) included.

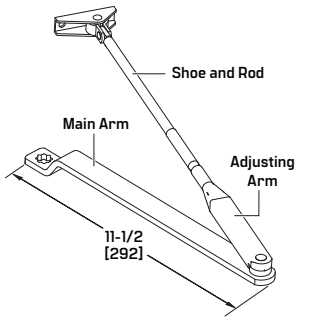

**Round Form Arm (10 mm rod)**

**ARJ (HD7000 & SL6000 only)** – Complete Arm Assembly (4"–8" [102 mm–203 mm] reveal) with 10 mm rod. Designed specifically for top jamb applications with deeper reveals. Arm is non-handed.

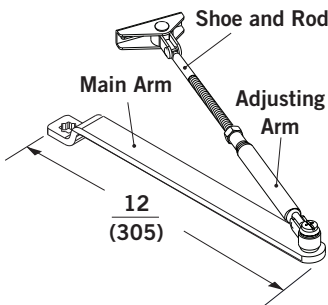

**Round Form Arm (8 mm rod)**

**A08 (HD7000 & SL6000 only)** – Complete secured elbow arm non-hold open assembly (0"–4" [0 mm–102 mm] reveal) with 8 mm rod. Arm is non-handed.

**A08P (HD7000 & SL6000 only)** – Parallel round form arm secured elbow non-hold open complete (Tri-Pack) (0"–4" [0 mm–102 mm] reveal). P60 included.

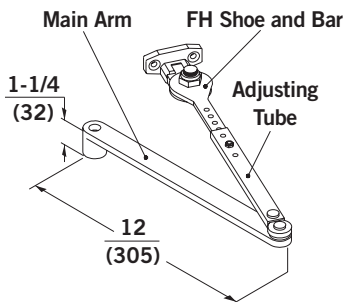

**Friction Hold Open Arm**

Provides a hold open function between approximately 90° and 180° of door opening (conditions permitting). Arm is non-handed.

**FH** – Friction hold open arm complete (0"–4" [0 mm–102 mm] reveal).

**FHJ** – Friction hold open arm complete (4"–8" [102 mm–203 mm] reveal).

**FHP** – Friction hold open arm complete (Tri-Pack) (0"–4" [0 mm–102 mm] reveal). PHB included.

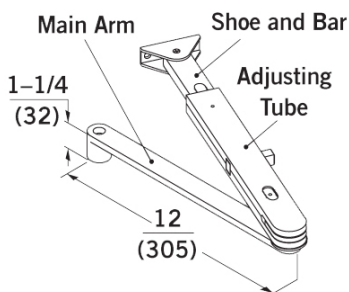

**Plunger Hold Open Arm**

Provides a hold open function at a selected point within a range from approximately 30° -150° (conditions and installation applications permitting). Ideal for doors frequently placed in and out of hold open. Arm is non-handed.

**PH (HD8000 & HD7000 only)** – Plunger hold open arm complete regular or top jamb mount (0" -1-1/2" [0 mm - 38 mm] reveal).

**PHP (HD8000 & HD7000 only)** – Plunger hold open arm complete parallel arm or top jamb mount (1-1/2" -3-1/2" [38 mm -89 mm] reveal).

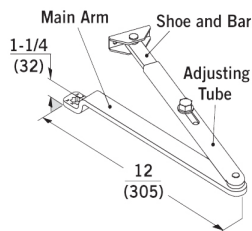

**Flat Form Arm**

**AF80P** (HD8000 only) – Parallel flat form arm complete (Tri-Pack) (0" - 4" [0 mm -102 mm] reveal). P80 included.  
**AF80J** (HD8000 only) – Top jamb flat form arm complete (4" - 8" [102 mm to 203 mm] reveal).

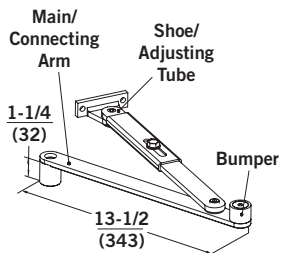

**Cushion IS Arm**

Provides a cushioned opening function for regular and top jamb applications at 85°, 90°, 95°, 100°, 105°, and 110°. Arm is non-handed.  
**IS** – Cushion IS arm complete (0"– 3-1/2" [0 mm–89 mm] reveal).  
**ISJ** – Cushion IS top jamb arm complete (3-1/2"–6-1/2" [89 mm–165 mm] reveal).  
**ISH** – Cushion IS hold open arm complete (0"–3-1/2" [0–89 mm] reveal).  
**ISJH** – Cushion IS top jamb hold open arm complete. (3-1/2"–6-1/2" [89 mm–165 mm] reveal).

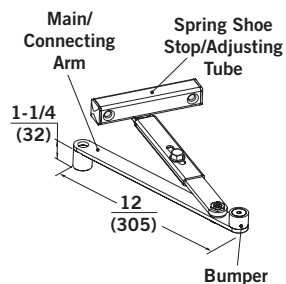

**Spring Stop IS Arm**

Provides a spring assisted dead stop function for regular and top jamb applications at 85°, 90°, 100°, and 110°. Arm is non-handed.  
**SIS** – Spring stop IS arm complete (0"–3-1/2" [0 mm–89 mm] reveal).  
**SISH** – Spring stop IS hold open arm complete (0"–3-1/2" [0 mm– 89 mm] reveal).  
**SISJ** – Spring stop IS top jamb arm complete (3-1/2"–6-1/2" [89 mm–165 mm] reveal).  
**SISJH** – Spring stop IS top jamb hold open arm complete (3-1/2"–6-1/2" [89 mm–165 mm] reveal).

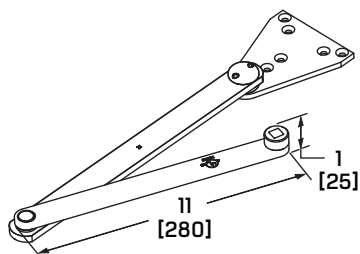

**Super Parallel Arm**

Heavy-duty parallel arm. Available in non-hold open and thumb turn hold open. Units can be installed for maximum opening of 100° or 180°. Hold open units will hold open at 90° or 125°. Maximum opening is 180° (permitting). Arm is non-handed. Non-hold open arm illustrated.  
**SPA** – Super parallel arm non-hold open.  
**SPA/R** – Heavy duty parallel arm with LCN PA foot  
**SPA/RCP** – Heavy duty parallel arm with LCN PA foot & CP4040 conv. plate  
**SPA** – Super parallel arm non-hold open.  
**SPAT** – Super parallel arm thumb turn hold open.  
**SPAT/R** – Heavy duty parallel arm, thumbturn hold open with LCN PA foot  
**SPAT/RCP** – Heavy duty parallel arm, thumbturn hold open with LCN PA foot & CP4040 conv. plate

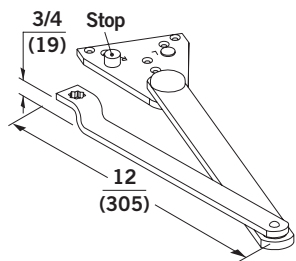

### Door Saver Arm

Heavy-duty parallel arm with integral cushioned opening function. Available in non-hold open, thumb turn hold open, and hex key turn hold open. Units can be installed to achieve either stop or stop and hold open at 85°, 90°, 100°, and 110°. Maximum opening is 110° (conditions permitting). Arm is non-handed. Non-hold open arm illustrated.

**DS** – Door saver arm non-hold open.

**DS/R** – Heavy duty parallel arm, stop with LCN PA foot

**DS/RCP** – Heavy duty parallel arm, stop with LCN PA foot & CP4040 conv. plate

**DST** – Door saver arm thumb turn hold open.

**DST/R** – Heavy duty parallel arm, hold open, stop with LCN PA foot

**DST/RCP** – Heavy duty parallel arm, hold open, stop with LCN PA foot & CP4040 conv. plate

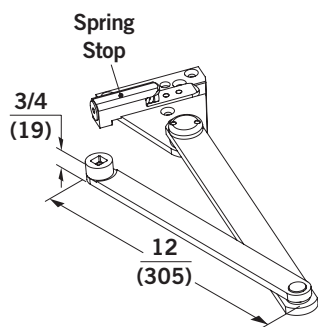

### Spring Stop Door Saver Arm

Heavy-duty parallel arm with spring assisted dead stop function. Available in non-hold open and thumb turn hold open. Units can be installed to achieve either stop at 85°, 90°, 100°, and 110° or stop and hold open function. Maximum opening is 110° (conditions permitting). Arm is non-handed. Non-hold open arm illustrated.

**SDS** – Spring stop door saver arm.

**SDS/R** – Heavy duty parallel arm, compression stop with LCN PA foot

**SDS/RCP** – Heavy duty parallel arm, compression stop with LCN PA foot & CP4040 conv. plate

**SDST** – Spring stop door saver arm thumb turn hold open.

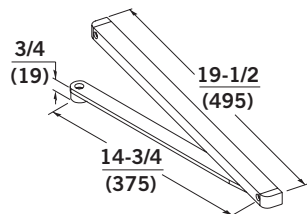

### Track Arm

Provides slide track function for improved aesthetics and vandal resistance. Units can be installed to provide 85°, 90°, 110°, or 180° of door opening (conditions and application permitting). Arm is non-handed.

**T** – Track arm complete. Can be used on pull-side T applications (closer on door, track on frame) and JT applications (track on frame, closer on door). Can also be used with FT flush transom applications (closer on transom, track on door).

**TH** – Track hold open arm complete. Can be used in same applications as T arm. Range of hold open and maximum opening varies with mounting application.

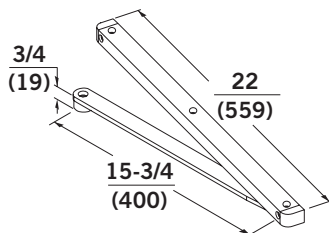

### Push Side Track Arm

**PT** – Push-side track arm complete. Used with PT track applications (closer on door, track on soffit).

**PTH** – Push-side track hold open arm complete. Used with PT track applications (closer on door, track on soffit).



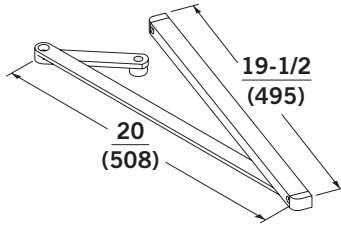

**TDE Track Arm**

Provides slide track function for pull-side reveal conditions up to 3-1/2". Provides 117° of door opening (conditions permitting). Arm is handed. Also available with hold open option to provide selective single point hold open between 30° and 110°.

Arm requires a minimum 3-3/4" clearance between door face and wall when opened 90° and greater.

**TDE** – Double egress track arm complete.

**TDEH** – Double egress hold open track arm complete.

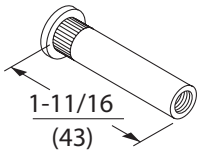

**Sex Nuts (Included in SNDTPK)**

Machine screws for 1-3/4" (44 mm) door

Required for use on unreinforced doors and wood or composite labeled fire doors for securely attaching hardware to the door.

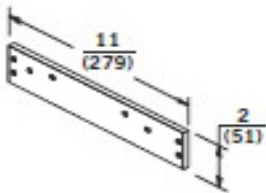

**Backplate**

**BP60** – (SL6000) For top jamb mount when overhead ceiling clearance is less than 2-1/4" (57 mm).

**BP70** – (HD7000) For top jamb mount of when overhead ceiling clearance is less than 2-1/4" (57 mm) or for regular mount to clear a mortised stop/holder.

**BP80** – (HD8000) For mounting top jamb when frame face is less than 2-7/8" (73 mm). Two sets of mounting holes accommodate 1-3/4" (44 mm) or 3-1/4" (83 mm) minimum ceiling clearance.\* Top set of holes create top jamb drop application to clear a surface applied stop/holder. Can also be used for regular mount to clear a mortised overhead stop/holder

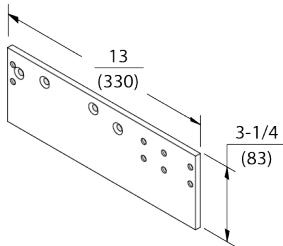

**Backplate**

**BP70FC** – (HD7000) For top jamb mount with a full cover when overhead ceiling clearance is less than 2-1/4" (57 mm) or for regular mount to clear a mortised stop/holder.

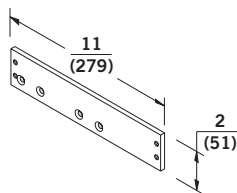

**Backplate**

**BP60T** – (SL6000) For use with pull-side track applications (closer on frame face, track on door) to permit installation on a standard 2" (51 mm) frame face.

**BP70T** – (HD7000) For use with pull-side track applications (closer on frame face, track on door) to permit installation on a standard 2" (51 mm) frame face.

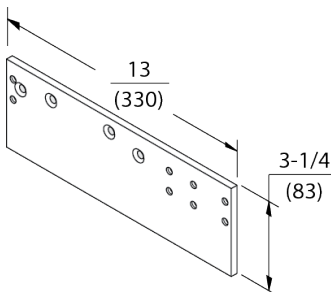

**Backplate**

**BP70TFC** (HD7000) – For use with pull-side track applications with full cover (closer on frame face, track on door) to permit installation on a standard 2" (51 mm) frame face.

**BP70FTFC** (HD7000) – Required for track mount with full cover when being used on a flush transom (closer on transom, track on door). Mounting holes in the plate avoid rabbet on door.

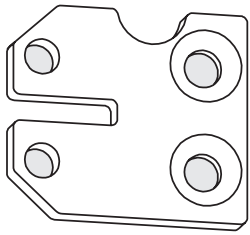

**Conversion Plate**

**SL640C** – For regular, top jamb, or parallel arm mounts. Eliminates the need to re-machine the door and frame. Totally concealed when installed. Allows installation of SL6000 to retrofit into any closer with a 9-1/16" x 3/4" hole pattern.

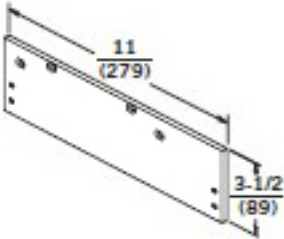

**Drop Plate**

**DP60** – (SL6000) For top jamb mount to clear a surface applied stop/ holder. Overhead ceiling clearance must be 1-3/4" [44 mm] or more. Permits parallel arm installation with minimum top door rail of 2-1/2" [64 mm] for non-hold open, 2-3/4" [70 mm] for friction hold open applications (assuming 5/8" [16 mm] stop dimension).

**DP80** – (HD8000) For parallel arm installation when top door rail is less than 5-3/4" [146 mm] for non-hold open and plunger hold open. When top door rail is less than 6" [152 mm] for friction applications (assuming 5/8" [16 mm] stop dimension).

**DP70** – (HD7000) For top jamb mount of with SPC, FPC and MC when overhead ceiling clearance is less than 1-7/8" [48 mm] or to provide clearance for a surface-applied stop/ holder. Permits parallel arm installation with a minimum top door rail of 2-1/2" [64 mm] for non-hold open, 2-5/8" [67 mm] for friction, fusible link and plunger hold open applications

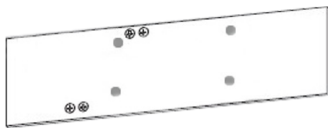

**Conversion plate**

**CP4040** – descriptions: conversion plate for HD8000 to retrofit LCN4040 w/ Heavy Duty PA arm application

**CP4111** – descriptions: conversion plate for HD8000 to retrofit LCN4111 w/ Heavy Duty PA arm application

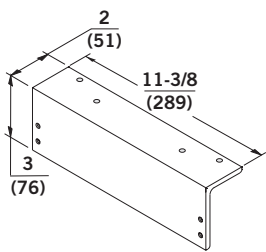

**Angle Bracket**

**AB60** (SL6000); **AB70** (HD7000); **AB80** (HD8000)– For installation of closers where parallel arm and top jamb applications are not practical due to low overhead ceiling clearance, narrow frame face or unusual trim conditions. This bracket can also be used to provide clearance for a surface-applied stop/holder.

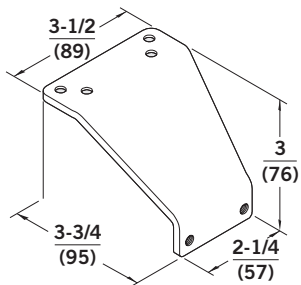

**Parallel Drop Bracket**

**PD**– For non-hold open parallel arm applications to clear a surface-applied stop/holder.

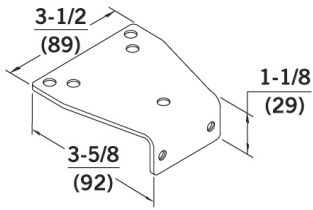

**Parallel Arm Bracket**

**P60** – Furnished standard with SL6000 series non-hold open parallel arm applications. Also available P70 (HD7000 - standard) and P80 (HD8000 - standard)

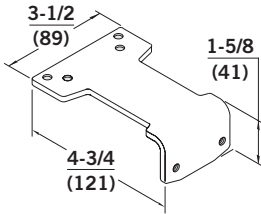

**Parallel Hold Open Bracket**

**PHB** – Furnished standard friction hold open parallel arm applications.

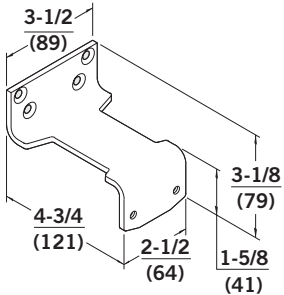

**Parallel Flush Transom Bracket**

**PFT** – For all hold open and non-hold open parallel arm applications where flush transom conditions prohibit use of P60, P70, P80 or PHB bracket.

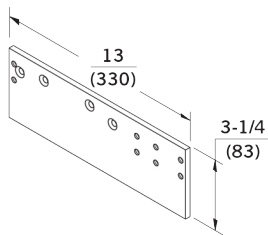

**Drop Plate**

**DP70FC** – Permits parallel arm installation with minimum top door rail of 2-1/2" [64 mm] for non-hold open, 2-5/8" [67 mm] for friction, fusible link, and plunger hold open applications (assuming 5/8" [16 mm] stop dimension).

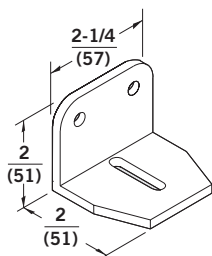

**Narrow Frame Bracket**

**NFHD** – For use with all DS and SPA applications where total frame depth is less than 4-1/2" [114 mm], prohibiting use of standard spacer block. NFHD bracket is used in lieu of block supplied with arm.

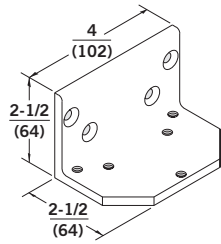

**Flush Transom Bracket**

**FTHD** – For use with all DS and SPA applications where flush transom conditions prohibit normal installation of soffit bracket.

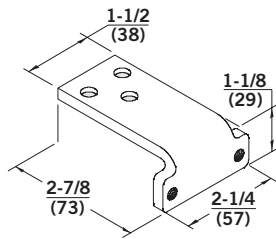

**Mortised Jamb Bracket**

**MJ** – For closers with regular mount non-hold open assemblies, where frame conditions will not permit use of the standard foot, e.g. molded bull nose, or ornate trim. Permits use of parallel arm application between twin communicating doors where limited space prohibits use of the P60, P70 and P80 bracket.

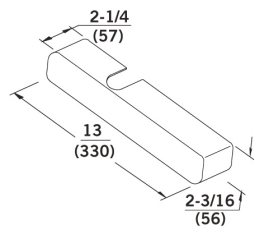

**Slim Plastic Cover**

**SPC** – [HD7000 and SL6000] Optional slim plastic cover.

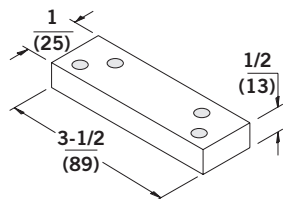

**Blade Stop Spacer**

**BS** – For use with all P60, P70, P80, PD, and PHB applications installed on cased frames with applied blade stops. This block is used to provide adequate clearance for the blade stop.

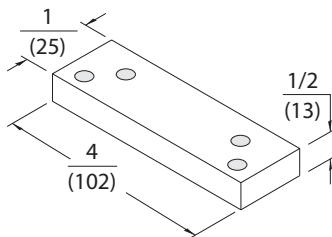

**Heavy-Duty Blade Stop Spacer**

**BSHD** – For use with all Series DS and SPA applications installed on cased frames with applied blade stops. This block is used in conjunction with the spacer furnished with the arm to provide adequate clearance for the blade stop.

For questions about ordering and to be sure you get the right configuration for your needs, [contact your BEST dormakaba sales representative](#).  
 6161 East 75th Street, Indianapolis, IN 46250 USA | [855-365-2407](tel:855-365-2407) | [bestaccess.com](http://bestaccess.com)