



EHD9000

Cast-Iron Surface
Applied Door Closer

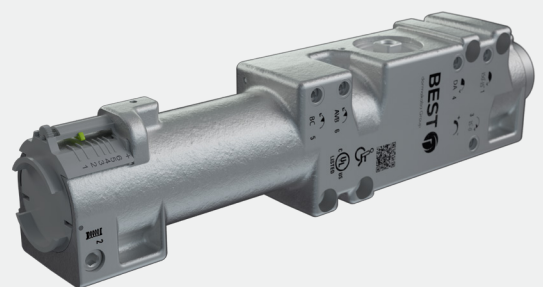

TABLE OF CONTENTS

EHD9000 Series.....	Pg 3
Features & Certifications.....	Pg 3
Pre-Fabricated Specifications (for spec writers).....	Pg 4
Finishes	Pg 6
Warranty Information.....	Pg 6
Technical Specifications.....	Pg 7
How to order.....	Pg 8

ARM Selections

Friction hold open arm.....	Pg 9
Plunger Hold open Arm.....	Pg 9
Flat form arm.....	Pg 9
Cushion IS arm.....	Pg 9
Spring stop IS arm.....	Pg 9
Super parallel arm.....	Pg 10
Door saver arm.....	Pg 10
Spring stop door saver arm.....	Pg 10
Track arms.....	Pg 10
Push side track.....	Pg 11
TDE Track.....	Pg 11

Accessories

Sex nuts.....	Pg 11
Backplates.....	Pg 11
Drop plate.....	Pg 11
Brackets.....	Pg 12
Blade stop spacers.....	Pg 13

EHD9000 CAST IRON SURFACE CLOSER



BEST EHD9000 Extra Heavy-Duty Surface Door Closer

The BEST EHD9000 is built to perform in even the highest traffic area and designed to be the most reliable, durable, and rugged door closer in the industry. When you need something as solid as your reputation, start with BEST.

Nothing Else Comes Close

- Rugged single-piece cast iron construction is sturdy with no seams, designed to perform consistently over the years.
- Front-facing spring-size indicator and adjustment points are easy to read and reach, for simpler and faster installation.
- Self-regulating valves keep your desired settings through changing temperatures.
- Dual-clamp design firmly secures the cover on both ends.
- Non-handed design with backcheck and advanced variable backcheck as standard functions allow you to have the right closer on hand.
- With one of the largest arm ranges in the market, the EHD9000 offers a solution for virtually all applications.

EHD9000 – Features

- Available with fully adjustable spring sizes 1-6+50%. Size 1 (5 lb opening force) meets interior barrier-free AD requirements.
- May be used on doors up to 48" wide interior (42" wide exterior) and up to 180 lb.
- For use on exceptionally wide, tall, or heavy doors.
- Non-handed for regular, top jamb, and parallel arm applications.
- Backcheck (BC) valve (standard) provides adjustable-intensity hydraulic cushioning, preventing uncontrolled door opening to protect door and frame during abusive or abrupt opening.
- AVB - advanced variable backcheck range on parallel arm applications. Valve is accessible with the closer installed.
- Full adjustment using BC, Sweep and Latch valves standard.
- DA option with separate independent valve to allow for unobstructed passage through opening.
- Full plastic cover standard. Lead lined as well as full metal covers available.
- All tamper-resistant (hex key) valve adjustments.
- Standard components required for three mounting configurations (Reg, TJ, PA).
- SNDTPK90 - Standard fasteners include separate self-drilling and self-tapping and sex nuts for 1-3/4" thick doors and machine screws.
- A variety of specialty arm options.
- Full complement of optional plates and brackets available for special applications

Certification

- ANSI/BHMA A156.4 Grade 1 certified
- UL and CUL listed
- Meets UL10C for positive pressure
- Meets ANSI/BHMA A117.1 and ADA for barrier-free accessibility.



dormakaba USA quality and environmental management systems in Reamstown, PA and Indianapolis, IN are certified to ISO 9001:2015 and ISO 14001:2015.

- A. Surface Door Closers (specifier: include 35 year warranty in Part 1 – Warranty section)
1. Manufacturers; Surface Mounted:
 - a. Best by dormakaba USA, Inc.
EHD9000 Series;
or None - N/A
(<https://www.bestaccess.com/products/door-closers/>)
 2. Rack and Pinion Cast Iron Surface Closers (Extra Heavy Duty)
 - a. Provide Full Rack and Pinion type closer constructed of one-piece cast iron, or equal, to exceed the ANSI/BHMA A156.4 Grade 1 requirements.
 - b. Provide closers tested and approved for UL10C for positive pressure; UL228 & CAN/ULC-S133.
 - c. Provide closers that conform to ANSI/ICC A117.1 and ADA requirements for barrier-free accessibility.
 - d. Closer shall be available with heavy-duty arms and knuckles/elbows
 - e. Closer shall have maximum 2 1/4 inch case projection with non-ferrous cover.
 - 1) Closer cover to be:
 - a) Plastic (default)
 - b) Metal
 - c) Lead Lined
 - 2) Closer cover finish to be:
 - a) Painted
 - b) Plated
 - c) RAL Custom Color Powder Coated
 - f. Provide closers with all-weather hydraulic fluid.
 - g. Provide closers with separate adjusting valves for closing and latching speeds, as well as advanced variable backcheck and delayed action.
 - h.
 - I. Provide closers with Delayed Action and/or Advanced Variable Backcheck where noted in hardware sets
 - II. Provide closers with backcheck positioning & DA valve
 - i. Provide adapter plates, shim spacers and blade stop spacers as required by frame and door conditions.
 - j. Mount closers on non-public side of door and stair side of stair doors, unless otherwise noted in hardware sets.
 - k. Closers shall be non-handed and multi-sized as noted in hardware sets.
When specific sized closers are required provide: Size 1 through 6 - +50% power over size 6 to meet barrier-free ADA and PT4C requirements
 3. Rack and Pinion Cast Iron Surface Closers (Extra Heavy Duty)
 - a. Provide Full Rack and Pinion type closer constructed of one-piece cast iron, or equal, to exceed the ANSI/BHMA A156.4 Grade 1 requirements.
 - b. Provide closers tested and approved for UL10C for positive pressure; UL228 & CAN/ULC-S133.

- c. Provide closers that conform to ANSI/ICC A117.1 and ADA requirements for barrier-free accessibility.
 - d. Closer shall be available with heavy-duty arms and knuckles/elbows
 - e. Closer shall have maximum 2 1/4 inch case projection with non-ferrous cover.
 - 1) Closer cover to be:
 - a) Plastic (default)
 - b) Metal
 - c) Lead Lined
 - 2) Closer cover finish to be:
 - a) Painted
 - b) Plated
 - c) RAL Custom Color Powder Coated
 - f. Provide closers with all-weather hydraulic fluid.
 - g. Provide closers with separate adjusting valves for closing and latching speeds, as well as advanced variable backcheck and delayed action.
 - h.
 - I. Provide closers with Delayed Action and/or Advanced Variable Backcheck where noted in hardware sets
 - II. Provide closers with backcheck positioning & DA valve
 - i. Provide adapter plates, shim spacers and blade stop spacers as required by frame and door conditions.
 - j. Mount closers on non-public side of door and stair side of stair doors, unless otherwise noted in hardware sets.
 - k. Closers shall be non-handed and multi-sized as noted in hardware sets. Provide closers fully adjustable to Sizes 1 through 6 - +50% power over size 6 to meet barrier-free ADA requirements.
4. Rack and Pinion Cast Iron Surface Closers
- a. Provide Full Rack and Pinion type closer constructed of one-piece cast iron, or equal, to meet the ANSI/BHMA A156.4 Grade 1 requirements.
 - b. Provide closers tested and approved for UL10C for positive pressure; UL228 & CAN/ULC-S133.
 - c. Provide closers that conform to ANSI/ICC A117.1 and ADA requirements for barrier-free accessibility.
 - d. Closer shall be available with heavy-duty arms and knuckles/elbows
 - e. Closer shall have maximum 2 1/4 inch case projection with non-ferrous cover.

Optional Specification Writings: (for spec writers)

- 1) Closer cover to be:
 Plastic with dual clamp mechanism on both sides of the cover (default). Adjustment of closing speed, latching speed, backcheck, advanced variable backcheck, optional delayed action and spring force to be made from the front.
 Visual spring size indicator readable from the front.
- 2) Closer cover finish to be:
 - a) Painted
 - b) RAL Custom Color Powder Coated
- f. Provide closers with all-weather hydraulic fluid.

- g. Provide closers with separate adjusting valves for closing and latching speeds, as well as backcheck and delayed action.

Optional Specification Writings: [for spec writers] cont.

- h.
 - I. Provide closers with Delayed Action and/or Advanced Backcheck where noted in hardware sets
 - II. Provide closers with backcheck positioning & DA valve
- i. Provide adapter plates, shim spacers and blade stop spacers as required by frame and door conditions.
- j. Mount closers on non-public side of door and stair side of stair doors, unless otherwise noted in hardware sets.
- k. Closers shall be non-handed and multi-sized as noted in hardware sets. When specific sized closers are required provide: Sizes 1 through 6 - +50% power over size 6 to meet ADA and PT4C requirements

Finishes (Painted)		Finishes (Plated)	
600	Primed	605	Polished brass
689	Aluminum (Standard)	606	Satin brass
690	Statuary bronze	611	Polished bronze
691	Dull bronze	612	Satin bronze
693	Black	613	Oxidized satin oil-rub bronze
695	Dark duranodic bronze	618	Polished nickel
696	Gold	619	Satin nickel
Custom Color (RAL color) Designer color match		625	Polished chrome
		626	Satin chrome
		630	Satin stainless

Warranty

For details, refer to BEST Warranty Policy on our website at <https://www.bestaccess.com/products/door-closers/>.

REDUCED OPENING FORCE INSTALLATIONS CAUTION: Manual door closers, including those certified to meet ANSI/ BHMA A156.4, when installed and adjusted to conform to ADA or other reduced opening force requirements, may not provide sufficient power to reliably close and latch a door.

Refer to catalog for Low Energy Operator to meet reduced opening force requirements without affecting closing power.

Technical Specifications

Features

EHD9000



Spring sizes	1-6 (w+50% pwr)
Non-handed	Standard
Full line of specialty function arms and plates	Standard
Backcheck positioning adjustment (POS)	AVB
Controlled closing with two adjustment valves	180°-15° 15°-0°
Backcheck	Standard
Delayed action	Optional
Hold Open	Optional
Self-drilling & Self-tapping screws	Standard
Tamper-resistant TORX screws	Optional
Full plastic cover	Standard
Full metal cover	Optional
Lead-lined metal cover	Optional

* Meets 5 lb maximum opening force on 3'-0" wide interior doors.

How to Order (EHD9000 Series)

How To Order – EHD9000 -- AVB body; PC90 Cover and SNDTPK90 Fasteners ship automatically unless other options are specified in nomenclature:

EHD90 16		AF90P		Specify		Specify		Specify		689	
Model	Spring	Body Option	Arm	Accessory Brackets	Cover Options	Fasteners	Accessory Plates	Other Accessories	Available Finish		
EHD90	16 Adjustable size 1-6 +50% power over size 6 to meet PT4C and barrier-free ADA requirements	DA AVB - Combination DA + AVB Standard select is AVB [Advanced variable backcheck]	AF90P, AF90J, AF90, FH90, FHP90, FHJ90, PH90, PHP90, DS90, DST90, SDS90, SDST90, IS90, ISH90, SIS90, SISH90, ISJ90, ISJH90, SISJ90, SISJH90, SPA90, SPAT90, T90, FT90, JT90, PT90, TDE90L, TDE90R, TH90, FTH90, JTH90, PTH90, TDEH90L, TDEH90R, LA	PFT90, PD90, PHB90, MJ90, P90	MC90 - Metal lined LL90 - Lead lined Standard select is PC90 (plastic)	TX90 - Torx security screws Standard select is SNDTPK90 (Self-drilling & tapping, thru bolts 1-3/4" door with machine screws)	BP90 DB90	AB90, NFHD90, FTHD90, BSHD90, BSNFHD90	Painted 600 Primed 689 Aluminum 691 Dull bronze 693 Black 695 Dark duranodic bronze 696 Gold	Plated: 605 Polished brass 606 Satin brass 611 Polished bronze 612 Satin bronze 613 Oxidized satin oil-rubbed bronze 618 Polished nickel 619 Satin nickel 625 Polished chrome 626 Satin chrome 630 Satin stainless	

Arm Option	Description
AF90P	Standard flat form arm, tri-pack
AF90J	Top jamb flat form arm for 4–8" reveal
AF90	Regular or top jamb flat form arm for 4" reveals
FH90	Friction hold open arm
FHP90	Friction hold open arm, tri-pack
FHJ90	Top jamb friction hold open arm for 4–8" reveal
PH90	Regular/Top jamb plunger hold open arm
PHP90	Parallel/Top jamb plunger hold open arm
DS90	Heavy duty parallel arm with stop
DST90	Heavy duty parallel arm with hold open and stop
SDS90	Heavy duty parallel arm with compression stop
SDST90	Heavy duty parallel arm with hold open and compression stop
IS90	Heavy duty regular/top jamb arm with stop
ISH90	Heavy duty regular/top jamb arm with hold open and stop
SIS90	Heavy duty regular/top jamb arm with compression stop
SISH90	Heavy duty regular/top jamb arm with hold open and compression stop
ISJ90	Heavy duty top jamb arm with stop for 3-1/2"–6-1/2" reveal
ISJH90	Heavy duty top jamb arm with hold open and stop for 3-1/2"–6-1/2" reveal
SISJ90	Heavy duty top jamb arm with compression stop for 3-1/2"–6-1/2" reveal
SISJH90	Heavy duty top jamb arm with hold open and compression stop for 3-1/2"–6-1/2" reveal
SPA90	Heavy duty parallel arm
SPAT90	Heavy duty parallel arm with thumb-turn hold open
T90	Track arm, pull side door mounted
FT90	Flush track arm, push side transom mounted
JT90	Jamb track, pull side frame mounted
PT90	Push track arm, push side soffit mounted
TDE90L	Track arm double egress, pull side frame mounted, left handed
TDE90R	Track arm double egress, pull side frame mounted, right handed
TH90	Track arm with hold open, pull side door mounted
FTH90	Flush track arm with hold open, push side transom mounted
JTH90	Jamb track with hold open, pull side frame mounted
PTH90	Push track arm with hold open, push side soffit mounted
TDEH90L	Track arm with hold open double egress, pull side frame mounted, left handed
TDEH90R	Track arm with hold open double egress, pull side frame mounted, right handed

Fasteners	
SNDTPK90	Standard self-drilling, self tapping and Sex Nuts for steel or aluminum door and frame applications (replacement pack)
TX90	Torx security screws

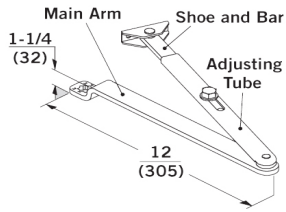

Flat Form Arm

- AF90P** – Parallel flat form arm complete (Tri-Pack) [0" - 4" [0 mm -102 mm] reveal]. P90 included.
- AF90J** – Top jamb flat form arm complete [4" - 8" [102 mm to 203 mm] reveal].
- AF90** – Regular or top jamb flat form arm for to 4" [102 mm] reveals.

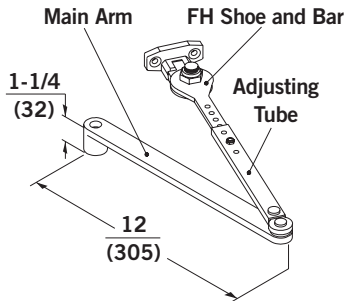

Friction Hold Open Arm

- Provides a hold open function between approximately 90° and 180° of door opening (conditions permitting). Arm is non-handed.
- FH90** – Friction hold open arm complete [0"-4" [0 mm- 102 mm] reveal].
 - FHJ90** – Friction hold open arm complete [4"-8" [102 mm- 203 mm] reveal].
 - FHP90** – Friction hold open arm complete (Tri-Pack) [0"-4" [0 mm-102 mm] reveal]. PHB included.

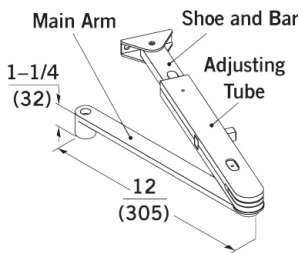

Plunger Hold Open Arm

- Provides a hold open function at a selected point within a range from approximately 30° -150° (conditions and installation applications permitting). Ideal for doors frequently placed in and out of hold open. Arm is non-handed.
- PH90** – Plunger hold open arm complete regular or top jamb mount [0" -1-1/2" [0 mm - 38 mm] reveal].
 - PHP90** – Plunger hold open arm complete parallel arm or top jamb mount [1-1/2" -3-1/2" [38 mm -89 mm] reveal].

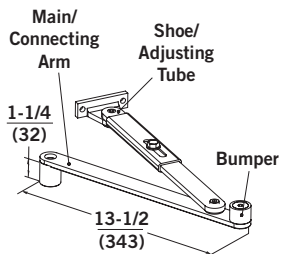

Cushion IS Arm

- Provides a cushioned opening function for regular and top jamb applications at 85°, 90°, 95°, 100°, 105°, and 110°. Arm is non-handed.
- IS90** – Cushion IS arm complete [0"- 3-1/2" [0 mm-89 mm] reveal].
 - ISJ90** – Cushion IS top jamb arm complete [3-1/2"-6-1/2" [89 mm-165 mm] reveal].
 - ISH90** – Cushion IS hold open arm complete [0"-3-1/2" [0-89 mm] reveal].
 - ISJH90** – Cushion IS top jamb hold open arm complete. [3-1/2"-6-1/2" [89 mm-165 mm] reveal].

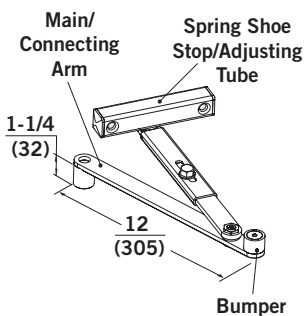

Spring Stop IS Arm

- Provides a spring assisted dead stop function for regular and top jamb applications at 85°, 90°, 100°, and 110°. Arm is non-handed.
- SIS90** – Spring stop IS arm complete [0"-3-1/2" [0 mm-89 mm] reveal].
 - SISH90** – Spring stop IS hold open arm complete [0"-3-1/2" [0 mm- 89 mm] reveal].
 - SISJ90** – Spring stop IS top jamb arm complete [3-1/2"-6-1/2" [89 mm-165 mm] reveal].
 - SISJH90** – Spring stop IS top jamb hold open arm complete [3-1/2"-6-1/2" [89 mm-165 mm] reveal].

NOTES: All combinations of features and options are not available for all models. To simplify initial installation, a range of back plates (BP90), drop plates (DP90), brackets, and spacers are available. Refer to Accessories section for details

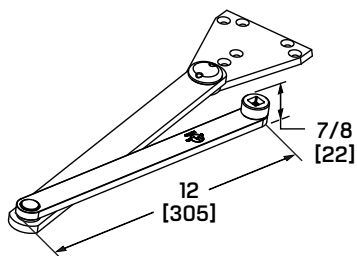

Super Parallel Arm

Heavy-duty parallel arm. Available in non-hold open and thumb turn hold open. Units can be installed for maximum opening of 100° or 180°. Hold open units will hold open at 90° or 125°. Maximum opening is 180° (permitting). Arm is non-handed. Non-hold open arm illustrated.

SPA90 – Super parallel arm non-hold open.

SPAT90 – Super parallel arm thumb turn hold open.

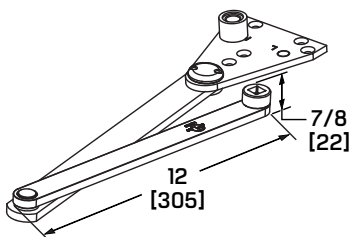

Door Saver Arm

Heavy-duty parallel arm with integral cushioned opening function. Available in non-hold open, thumb turn hold open, and hex key turn hold open. Units can be installed to achieve either stop or stop and hold open at 85°, 90°, 100°, and 110°. Maximum opening is 110° (conditions permitting). Arm is non-handed. Non-hold open arm illustrated.

DS90 – Door saver arm non-hold open.

DST90 – Door saver arm thumb turn hold open.

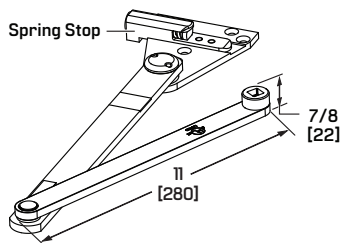

Spring Stop Door Saver Arm

Heavy-duty parallel arm with spring assisted dead stop function. Available in non-hold open and thumb turn hold open. Units can be installed to achieve either stop at 85°, 90°, 100°, and 110° or stop and hold open function. Maximum opening is 110° (conditions permitting). Arm is non-handed. Non-hold open arm illustrated.

SDS90 – Spring stop door saver arm.

SDST90 – Spring stop door saver arm thumb turn hold open.

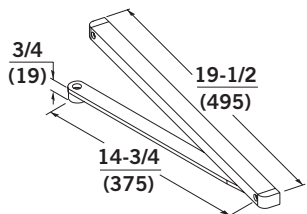

Track Arm

Provides slide track function for improved aesthetics and vandal resistance. Units can be installed to provide 85°, 90°, 110°, or 180° of door opening (conditions and application permitting). Arm is non-handed.

T90 – Track arm complete. Can be used on pull-side T applications (closer on door, track on frame) and JT applications (track on frame, closer on door). Can also be used with FT90 flush transom applications (closer on transom, track on door).

TH90 – Track hold open arm complete. Can be used in same applications as T90 arm. Range of hold open and maximum opening varies with mounting application.

Arms

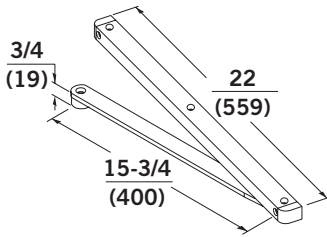

Push Side Track Arm

PT90 – Push-side track arm complete. Used with PT90 track applications (closer on door, track on soffit).

PTH90 – Push-side track hold open arm complete. Used with PT90 track applications (closer on door, track on soffit).

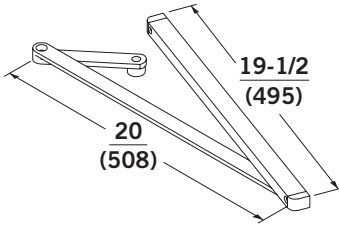

TDE Track Arm

Provides slide track function for pull-side reveal conditions up to 3-1/2". Provides 117° of door opening (conditions permitting). Arm is handed. Also available with hold open option to provide selective single point hold open between 30° and 110°.

Arm requires a minimum 3-3/4" clearance between door face and wall when opened 90° and greater.

TDE90L/R – Double egress track arm complete.

TDEH90L/R – Double egress hold open track arm complete.

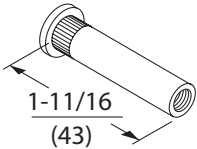

Sex Nuts (Included in SNDTPK90)

Machine screws for 1-3/4" (44 mm) door

Required for use on unreinforced doors and wood or composite labeled fire doors for securely attaching hardware to the door.

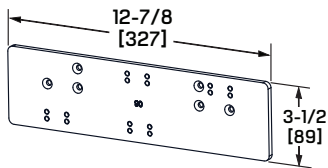

Backplate

BP90 – For mounting top jamb when frame face is less than 2-7/8" (73 mm). Two sets of mounting holes accommodate 1-3/4" (44 mm) or 3-1/4" (83 mm) minimum ceiling clearance.* Top set of holes create top jamb drop application to clear a surface applied stop/holder. Can also be used for regular mount to clear a mortised overhead stop/holder

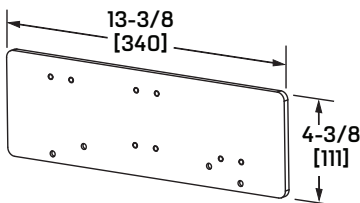

Drop Plate

DP90 – For parallel arm installation when top door rail is less than 5-3/4" (146 mm) for non-hold open and plunger hold open. When top door rail is less than 6" (152 mm) for friction applications (assuming 5/8" (16 mm) stop dimension).

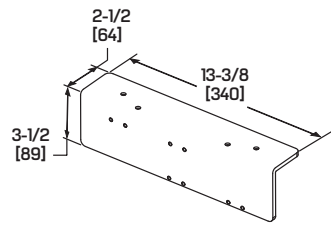

Angle Bracket

AB90 – For installation of closers where parallel arm and top jamb applications are not practical due to low overhead ceiling clearance, narrow frame face or unusual trim conditions. This bracket can also be used to provide clearance for a surface-applied stop/holder.

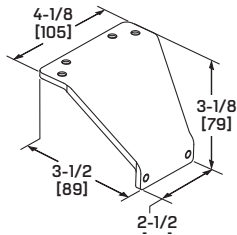

Parallel Drop Bracket

PD90 – For non-hold open parallel arm applications to clear a surface-applied stop/holder.

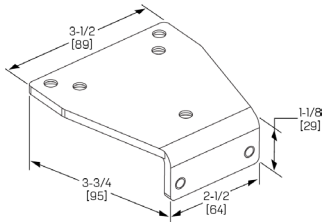

Parallel Arm Bracket

P90 – Furnished standard with EHD9000 series non-hold open parallel arm applications.

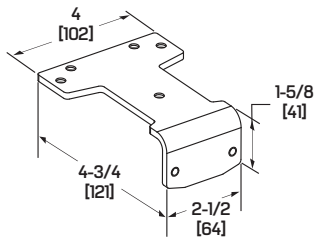

Parallel Hold Open Bracket

PHB90 – Furnished standard friction hold open parallel arm applications.

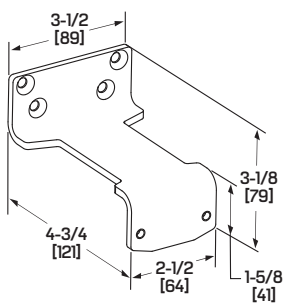

Parallel Flush Transom Bracket

PFT90 – For all hold open and non-hold open parallel arm applications where flush transom conditions prohibit use of P60, P70, P80 or PHB bracket.

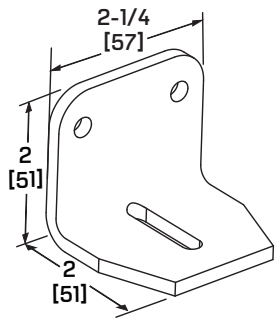

Narrow Frame Bracket

NFHD90 – For use with all DS90 and SPA90 applications where total frame depth is less than 4-1/2" (114 mm), prohibiting use of standard spacer block. NFHD90 bracket is used in lieu of block supplied with arm.

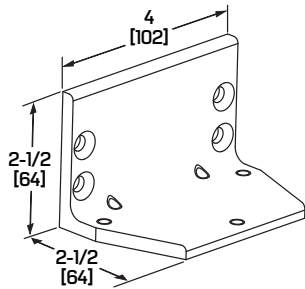

Flush Transom Bracket

FTHD90 – For use with all DS90 and SPA90 applications where flush transom conditions prohibit normal installation of soffit bracket.

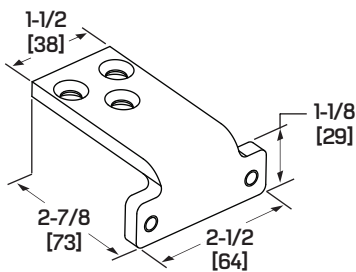

Mortised Jamb Bracket

MJ90 – For closers with regular mount non-hold open assemblies, where frame conditions will not permit use of the standard foot, e.g. molded bull nose, or ornate trim. Permits use of parallel arm application between twin communicating doors where limited space prohibits use of the P90 bracket.

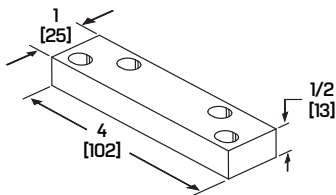

Heavy-Duty Blade Stop Spacer

BSHD90 – For use with all Series DS90 and SPA90 applications installed on cased frames with applied blade stops. This block is used in conjunction with the spacer furnished with the arm to provide adequate clearance for the blade stop.

Notes:

Notes:

For questions about ordering and to be sure you get the right configuration for your needs, [contact your BEST dormakaba sales representative](#).
6161 East 75th Street, Indianapolis, IN 46250 USA | [855-365-2407](tel:855-365-2407) | bestaccess.com