



BEST 
dormakaba Group

5 Knuckle Ball Bearing Hinges by BEST



Trusted experts. Proven reliability. Simply BEST.

TABLE OF CONTENTS

5 knuckle hinge design	2
Full mortise hinges	4-5
Half surface hinges	6-7
Half mortise hinges	8-9
Full surface hinges	10-11

Slip-in hinges	12
Pivot reinforced hinges	13
Swing clear hinges	14-15
Plain bearing hinges	16

5 Knuckle Ball Bearing Hinges

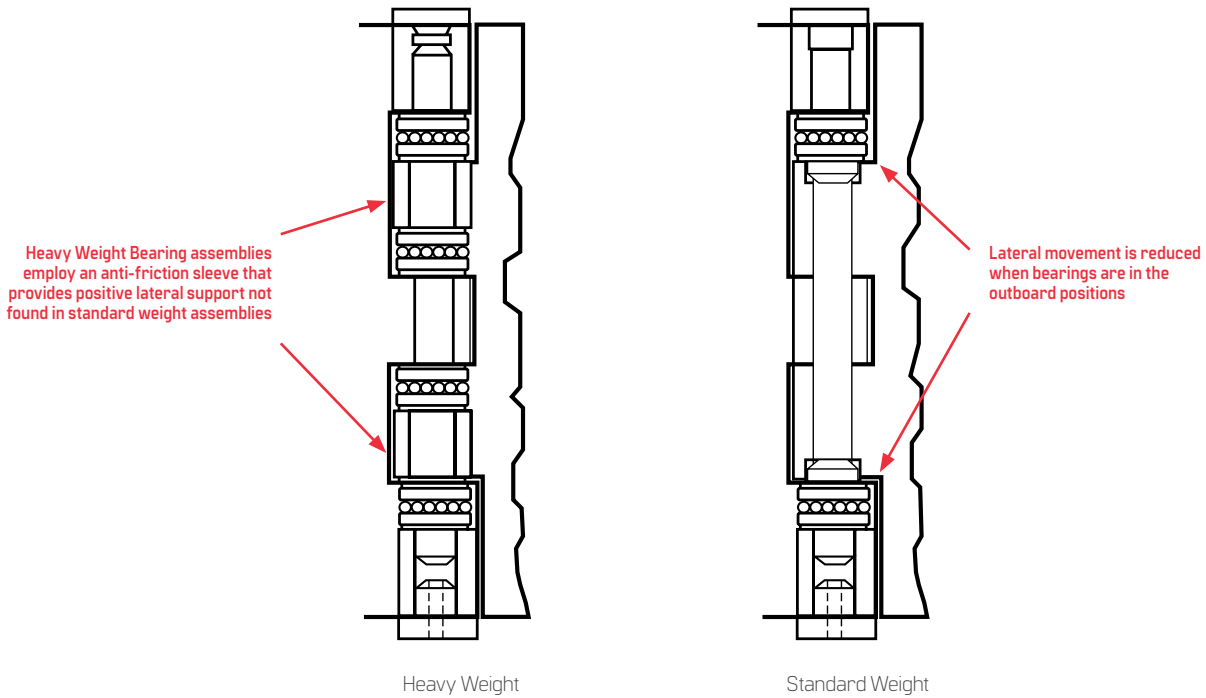

- The vertical load of the door is supported by through-hardened chrome alloy, vertical thrust ball bearing assemblies.
- The lateral load of the door is supported by the pin bearing on the inside of the hinge knuckles.
- Large cold headed, drawn stock of the pins and long bearing area within the knuckles distributes lateral wear over a greater area, resulting in increased life of the hinge.
- Approved for use on all types of fire doors up to 4' x 10' (1219mm x 3048mm),
- 8' x 10' (2438mm x 3048mm) pairs, to maintain the integrity of fire rated openings and walls. Refer to NFPA80.



5 Knuckle Full Mortise Hinges

Standard Weight Ball Bearing

FBB179 – (ANSI A8112) Steel – polished and plated or phosphated and prime coated for painting

FBB191 – (ANSI A2112) Brass or bronze – polished and plated or painted

FBB191 (32) – (ANSI A5112) Stainless steel – highly polished

FBB191 (32D) – (ANSI A5112) Stainless steel – satin finish



- For medium weight doors of average frequency
- All hinges have template screw hole location for use on either wood or hollow metal doors and frames
- Equipped with two permanently lubricated non-detachable ball bearings
- Pins in non-ferrous hinges are stainless steel
- Hole in bottom tip for easy pin removal
- Reversible flush tips and pins
- Hinges can be furnished as follows:
 - with raised barrel (RB)
 - with electric wires and/or switches (CE and/or CS)
 - with hospital tips (HT)
 - with decorative tips
 - with security studs
 - with non-removable pins (NRP)

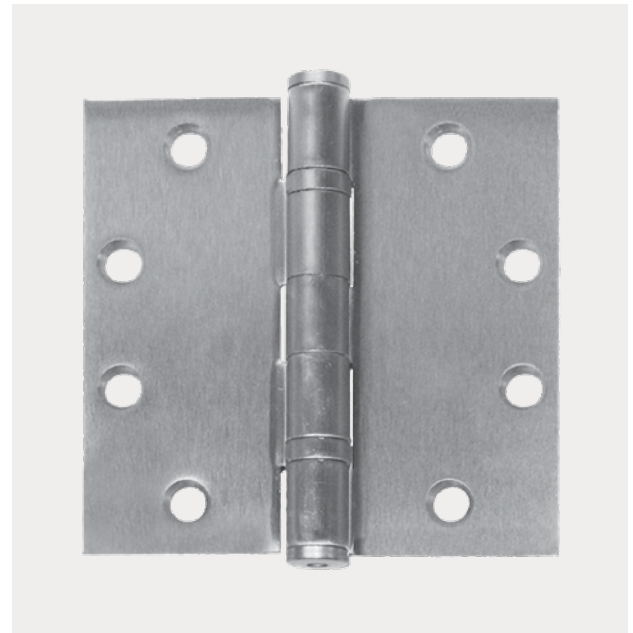

Size Open		Gauge of Metal		Flat Head Screws Per Piece		Quantity Per		Case Weight			
Inches	(mm)	Inches	(mm)	Machine	Wood	Box	Case	Bronze		Steel	
						Each	Each	Lbs.	(Kg)	Lbs.	(Kg)
3-1/2 x 3	(89 x 76)	.123	(3.1)	6 - 10-24 x 1/2	6 - 10 x 1	3	90	58	(26)	54	(24)
3-1/2 x 3-1/2	(89 x 89)	.123	(3.1)	6 - 10-24 x 1/2	6 - 10 x 1	3	90	65	(29)	59	(27)
4 x 3-1/2	(102 x 89)	.130	(3.3)	8 - 12-24 x 1/2	8 - 12 x 1-1/4	3	48	43	(19)	39	(18)
4 x 4	(102 x 102)	.130	(3.3)	8 - 12-24 x 1/2	8 - 12 x 1-1/4	3	48	45	(20)	42	(19)
4-1/2 x 4	(114 x 102)	.134	(3.4)	8 - 12-24 x 1/2	8 - 12 x 1-1/4	3	48	55	(25)	52	(24)
4-1/2 x 4-1/2	(114 x 114)	.134	(3.4)	8 - 12-24 x 1/2	8 - 12 x 1-1/4	3	48	59	(27)	55	(25)
5 x 4	(127 x 102)	.146	(3.7)	8 - 12-24 x 1/2	4 - 12 x 1-1/4	3	30	41	(19)	39	(18)
5 x 4-1/2	(127 x 114)	.146	(3.7)	8 - 12-24 x 1/2	4 - 12 x 1-1/4	3	30	45	(20)	43	(19)
5 x 5	(127 x 127)	.146	(3.7)	8 - 12-24 x 1/2	4 - 12 x 1-1/4	3	30	50	(23)	46	(21)
*6 x 4-1/2	(152 x 114)	.160	(4.1)	10 - 1/4 - 20 x 1/2	5 - 14 x 1-1/2	3	24	43	(19)	36	(16)
*6 x 5	(152 x 127)	.160	(4.1)	10 - 1/4 - 20 x 1/2	5 - 14 x 1-1/2	3	24	47	(21)	40	(18)
*6 x 6	(152 x 152)	.160	(4.1)	10 - 1/4 - 20 x 1/2	5 - 14 x 1-1/2	3	24	67	(30)	61	(28)

* Available in Steel only
Consult factory for other sizes not listed

5 Knuckle Full Mortise Hinges

Heavy Weight Ball Bearing

FBB168 – [ANSI A8111] Steel – polished and plated or phosphated and prime coated for painting

FBB199 – [ANSI A2111] Brass or bronze – polished and plated or painted

FBB199 (32) – [ANSI A5111] Stainless steel – highly polished

FBB199 (32D) – [ANSI A5111] Stainless steel – satin finish



- For use on heavy doors or doors where high frequency is expected such as entrance doors to office buildings, stores, public buildings and corridor entrance doors to offices
- All hinges have template screw hole location for use on either wood or hollow metal doors and frames
- Equipped with four permanently lubricated non-detachable ball bearings
- Pins in non-ferrous hinges are stainless steel
- Hole in bottom tip for easy pin removal
- Reversible flush tips and pins
- Hinges can be furnished as follows:
 - with raised barrel (RB)
 - with electric wires and/or switches (CE and/or CS)
 - with hospital tips (HT)
 - with decorative tips
 - with security studs
 - with non-removable pins (NRP)



Size Open		Gauge of Metal		Flat Head Screws Per Piece		Quantity Per		Case Weight		Case Weight	
Inches	[mm]	Inches	[mm]	Machine	Wood	Box	Case	Bronze	Steel	Lbs.	[Kg]
4-1/2 x 4-1/2	[114 x 114]	.180	[4.6]	8 - 12-24 x 1/2	8 - 12 x 1-1/4	3	30	45	[21]	42	[19]
5 x 4-1/2	[127 x 114]	.190	[4.8]	8 - 12-24 x 1/2	8 - 12 x 1-1/2	3	24	46	[21]	40	[18]
5 x 5	[127 x 127]	.190	[4.8]	8 - 12-24 x 1/2	8 - 12 x 1-1/2	3	24	50	[23]	46	[21]
6 x 4-1/2	[152 x 114]	.203	[5.2]	10 - 1/4 -20 x 1/2	10 - 14 x 1-1/2	3	24	63	[29]	53	[24]
6 x 5	[152 x 127]	.203	[5.2]	10 - 1/4 -20 x 1/2	10 - 14 x 1-1/2	3	24	65	[30]	55	[25]
6 x 6	[152 x 152]	.203	[5.2]	10 - 1/4 -20 x 1/2	10 - 14 x 1-1/2	3	24	76	[35]	64	[29]
8 x 6*	[203 x 152]	.203	[5.2]	16 - 1/4 -20 x 1/2	16 - 14 x 1-1/2	3	12	57	[26]	51	[23]
8 x 8*	[203 x 203]	.203	[5.2]	16 - 1/4 -20 x 1/2	16 - 14 x 1-1/2	3	12	68	[31]	61	[28]

* Available in Steel only
Consult factory for other sizes not listed

5 Knuckle Half Surface Hinges

Standard Weight Ball Bearing

FBB173 (ANSI A8412) – Steel – polished and plated or phosphated and prime coated for painting

FBB112 (ANSI A2412) – Brass or bronze – highly polished and painted or plated

FBB112 (32) (ANSI A5412) – Stainless steel – highly polished

FBB112 (32D) (ANSI A5412) – Stainless steel – satin finish



- For medium weight wood, kalamein, or mineral core doors with edge rails that won't hold screws, hung on hollow metal frames, of average frequency
- Equipped with two permanently lubricated non-detachable ball bearings
- Pins in non-ferrous hinges are stainless steel
- Reversible flush tips and pins
- Hinges can be furnished with hospital tips (HT)
- Consider using a back plate with these hinges
- Packed with machine screws and grommet nuts for 1-3/4" doors

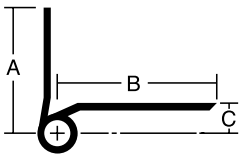

Measurements below

Size Length of Joint		Width				Offset		Gauge of Metal		Flat Head Screws Per Piece		Quantity Per		Case Weight		Case Weight	
Inches	[mm]	Frame Leaf (A)		Door Leaf (B)		[C]		Metal		Frame Leaf	Door Leaf	Box	Case	Bronze		Steel	
		Inches	[mm]	Inches	[mm]	Inches	[mm]	Inches	[mm]	Lbs.	Lbs.	Each	Each	Lbs.	[Kg]	Lbs.	[Kg]
4	[102]	1-13/16	[46]	2-1/4	[57.2]	1/2	[12.7]	.130	[3.3]	4-12-24 x 1/2	3-1/4-20 x 2	3	48	56	[25]	47	[21]
4-1/2	[114]	2-1/16	[52.4]	2-9/16	[65.1]	9/16	[14.3]	.134	[3.4]	4-12-24 x 1/2	3-1/4-20 x 2	3	30	44	[20]	37	[17]
5	[127]	2-1/16	[52.4]	2-7/8	[73]	9/16	[14.3]	.146	[3.7]	4-12-24 x 1/2	4-1/4-20 x 2	3	24	48	[22]	39	[18]

5 Knuckle Half Surface Hinges

Heavy Weight Ball Bearing

FBB163 (ANSI A8411) – Steel – polished and plated or phosphated and prime coated for painting

FBB113 (ANSI A2411) – Brass or bronze – polished and plated or painted

FBB113 (32) (ANSI A5411) – Stainless steel – highly polished

FBB113 (32D) (ANSI A5411) – Stainless steel – satin finish



- For heavy or high frequency wood, or mineral core doors with edge rails that won't hold screws hung on hollow metal frames
- Equipped with four permanently lubricated non-detachable ball bearings
- Heavy weight gauges increase available bearing surface area for maximum friction reduction
- Pins in non-ferrous hinges are stainless steel
- Reversible flush tips and pins
- Hinges can be furnished with hospital tips (HT)
- Consider using a back plate with these hinges
- Packed with machine screws and grommet nuts for 1-3/4" doors

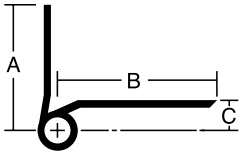

Measurements below

Size Length of Joint		Width				Offset		Gauge of Metal		Flat Head Screws Per Piece		Quantity Per		Case Weight		Case Weight	
Inches	(mm)	Frame Leaf (A)		Door Leaf (B)		(C)		Inches	(mm)	Frame Leaf	Door Leaf	Box	Case	Lbs.	(Kg)	Lbs.	(Kg)
		Inches	(mm)	Inches	(mm)	Inches	(mm)			Lbs.	Lbs.	Each	Each	Lbs.	(Kg)	Lbs.	(Kg)
4-1/2	(114)	2-1/8	(54)	2-9/16	(65)	5/8	(15.9)	.180	(4.6)	4-12-24 x 1/2	3-1/4-20 x 2	3	30	59	(27)	47	(21)
5	(127)	2-1/8	(54)	2-7/8	(73)	5/8	(15.9)	.190	(4.8)	4-12-24 x 1/2	4-1/4-20 x 2	3	24	58	(26)	48	(22)
6	(152)	2-1/8	(54)	3-1/4	(82.6)	5/8	(15.9)	.203	(5.2)	5-1/4-20 x 1/2	5-1/4-20 x 2	3	24	90	(41)	82	(37)

5 Knuckle Half Mortise Hinges

Standard Weight Ball Bearing

FBB167 (ANSI A8212) – Steel – polished and plated or phosphated and prime coated for painting

FBB108 (ANSI A2212) – Brass or bronze – polished and plated or painted

FBB108 [32] (ANSI A5212) – Stainless steel – highly polished

FBB108 [32D] (ANSI A5212) – Stainless steel – satin finish



- For medium weight hollow metal or wood doors of average frequency, hung on channel iron frames
- Equipped with two permanently lubricated non-detachable ball bearings
- Pins in non-ferrous hinges are stainless steel
- Reversible flush tips and pins
- Hinges can be furnished with hospital tips (HT)

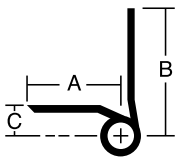

Measurements below



Size Length of Joint		Width				Offset (C)		Gauge of Metal		Flat Head Screws Per Piece		Quantity Per		Case Weight		Case Weight	
		Frame Leaf (A)		Door Leaf (B)						Frame Leaf	Door Leaf	Box	Case	Bronze	Steel		
Inches	(mm)	Inches	(mm)	Inches	(mm)	Inches	(mm)	Inches	(mm)	Lbs.	Lbs.	Each	Each	Lbs.	(Kg)	Lbs.	(Kg)
4-1/2	(114)	1-1/2	(38.1)	2-1/16	(52.4)	7/16	(11.1)	.134	(3.4)	3-12-24 x 1/2	3-12-24 x 1/2	3	30	30	(14)	29	(13)
4	(127)	1-1/2	(38.1)	2-1/16	(52.4)	7/16	(11.1)	.146	(3.7)	4-12-24 x 1/2	4-12-24 x 1/2	3	24	37	(17)	33	(15)

5 Knuckle Half Mortise Hinges

Heavy Weight Ball Bearing

FBB138 (ANSI A8211) – Steel – polished and plated or phosphated and prime coated for painting

FBB98 (ANSI A2211) – Brass or bronze – polished and plated or painted

FBB98 (32) (ANSI A5211) – Stainless steel – highly polished

FBB98 (32D) (ANSI A5211) – Stainless steel – satin finish



- For heavy or high frequency hollow metal or wood doors hung on channel iron frames
- Equipped with four permanently lubricated non-detachable ball bearings
- Pins in non-ferrous hinges are stainless steel
- Reversible flush tips and pins
- Hinges can be furnished with hospital tips (HT)

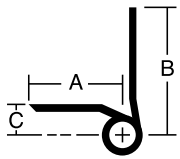

Measurements below



Size Length of Joint		Width				Offset		Gauge of Metal		Flat Head Screws Per Piece		Quantity Per		Case Weight		Case Weight	
		Frame Leaf (A)		Door Leaf (B)		(C)				Frame Leaf	Door Leaf	Box	Case	Bronze	Steel		
Inches	(mm)	Inches	(mm)	Inches	(mm)	Inches	(mm)	Inches	(mm)	Lbs.	Lbs.	Each	Each	Lbs.	(Kg)	Lbs.	(Kg)
4-1/2	(114)	1-1/2	(38.1)	2-1/8	(54)	1/2	(12.7)	.180	(4.6)	3-12-24 x 1/2	4-12-24 x 1/2	3	30	36	(17)	36	(17)
5	(127)	1-1/2	(38.1)	2-1/8	(54)	1/2	(12.7)	.190	(4.8)	4-12-24 x 1/2	4-12-24 x 1/2	3	24	36	(17)	36	(17)
6	(152)	1-1/2	(38.1)	2-1/8	(54)	1/2	(12.7)	.203	(5.2)	4-1/4-20 x 1/2	5-1/4-20 x 1/2	3	24	48	(22)	48	(22)

5 Knuckle Full Surface Hinges

Standard Weight Ball Bearing

FBB171 (ANSI A8312) – Steel – polished and plated or phosphated and prime coated for painting

FBB110 (ANSI A2312) – Brass or bronze – polished and plated or painted

FBB110 (32) (ANSI A5312) – Stainless steel – highly polished

FBB110 (32D) (ANSI A5312) – Stainless steel – satin finish



- For medium weight kalamein mineral core or wood doors of average frequency hung on channel iron frames
- Equipped with two permanently lubricated non-detachable ball bearings
- Pins in non-ferrous hinges are stainless steel
- Reversible flush tips and pins
- Hinges can be furnished with hospital tips (HT)
- Consider using a back plate with these hinges
- Packed with machine screws and grommet nuts for 1-3/4" doors

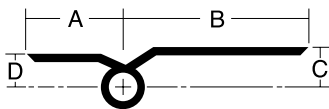
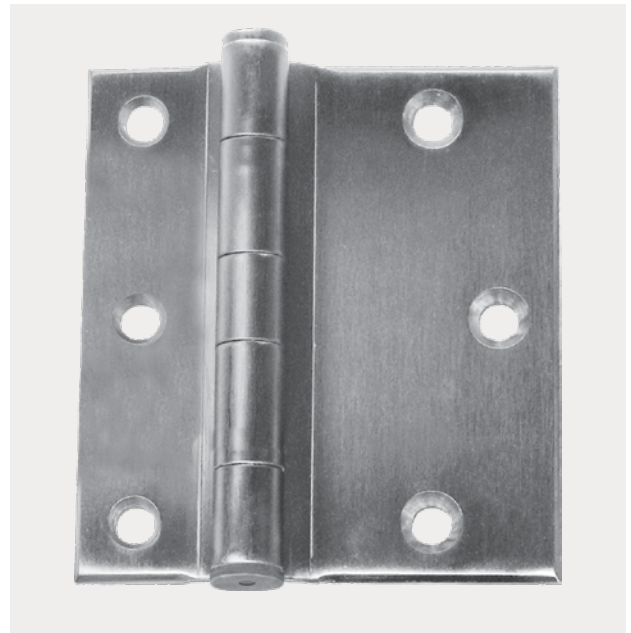

Measurements below

Size Length of Joint		Width		Offset		Offset		Gauge of Metal		Flat Head Screws Per Piece		Quantity Per		Case Weight		Case Weight			
Inches	(mm)	Inches	(mm)	Inches	(mm)	Inches	(mm)	Inches	(mm)	Lbs.	Lbs.	Each	Each	Lbs.	(Kg)	Lbs.	(Kg)		
4-1/2	(114)	1-1/2	(38.1)	2-9/16	(65)	9/16	(14.3)	7/16	(11.1)	.134	(3.4)	3-12-24 x 1/2	3-1/4-20 x 2	3	30	40	(18)	38	(17)
5	(127)	1-1/2	(38.1)	2-7/18	(73)	9/16	(14.3)	7/16	(11.1)	.146	(3.7)	4-12-24 x 1/2	4-1/4-20 x 2	3	24	43	(20)	39	(18)

5 Knuckle Full Surface Hinges

Heavy Weight Ball Bearing

FBB169 (ANSI A8311) – Steel – polished and plated or phosphated and prime coated for painting

FBB109 (ANSI A2311) – Brass or bronze – polished and plated or painted

FBB109 [32] (ANSI A5311) – Stainless steel – highly polished

FBB109 [32D] (ANSI A5311) – Stainless steel – satin finish



- For heavy or high frequency mineral core or wood doors with edge rails that won't hold screws, hung on channel iron frames
- Heavy weight gauges increase available bearing surface area for maximum friction reduction
- Equipped with four permanently lubricated non-detachable ball bearings
- Pins in non-ferrous hinges are stainless steel
- Reversible flush tips and pins
- Hinges can be furnished with hospital tips [HT]
- Consider using a back plate with these hinges
- Available with an inline hole pattern for tubular doors
- Packed with machine screws and grommet nuts for 1-3/4" doors

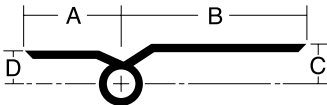
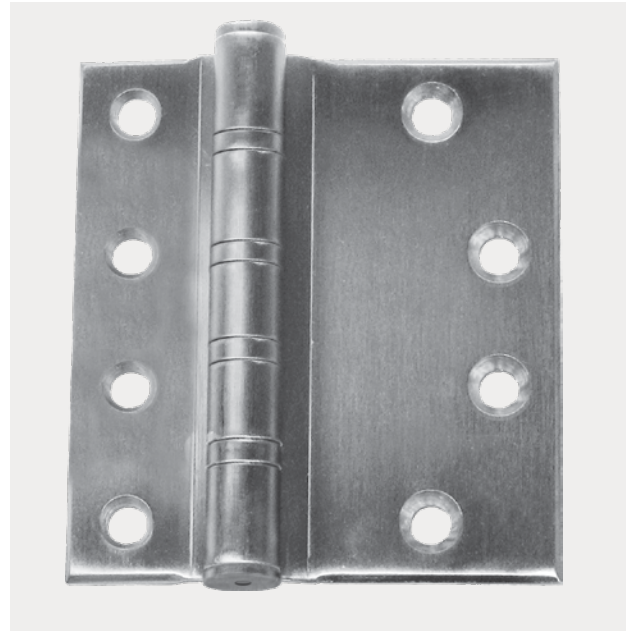

Measurements below

Size Length of Joint		Width				Offset		Offset		Gauge of Metal		Flat Head Screws Per Piece		Quantity Per		Case Weight		Case Weight	
Inches	(mm)	Inches	(mm)	Inches	(mm)	Inches	(mm)	Inches	(mm)	Inches	(mm)	Lbs.	Lbs.	Each	Each	Lbs.	(Kg)	Lbs.	(Kg)
4-1/2	[114]	1-1/2	[38.1]	2-9/16	[65]	5/8	[15.9]	1/2	[12.7]	.180	[4.6]	3-12-24 x 1/2	3-12-24 x 1/2	3	30	56	[26]	44	[20]
5	[127]	1-1/2	[38.1]	2-7/8	[73]	5/8	[15.9]	1/2	[12.7]	.190	[4.8]	4-12-24 x 1/2	4-12-24 x 1/2	3	24	57	[26]	51	[23]
6	[152]	1-1/2	[38.1]	3-1/4	[82.6]	5/8	[15.9]	1/2	[12.7]	.203	[5.2]	4-1/4-20 x 1/2	5-1/4-20 x 1/2	3	24	80	[36]	74	[34]

5 Knuckle Slip-In Hinges

Standard Weight Ball Bearing – Application "A"

FBB179 – (ANSI A8152) Slip-in application "A", steel – polished and plated or painted

FBB191 – (ANSI A2152) Slip-in application "A", brass or bronze – polished and plated or painted

FBB191 (32) – (ANSI A5152) Slip-in application "A", stainless steel – highly polished

FBB191 (32D) – (ANSI A5152) Slip-in application "A", stainless steel – satin finish

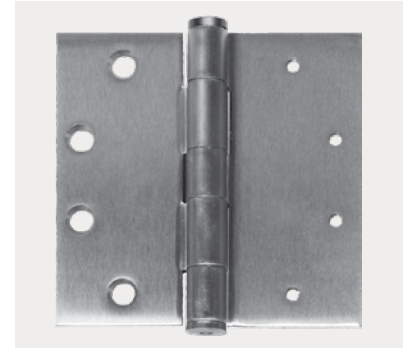

- For aluminum doors with aluminum frames
- "Slip-in" application where one leaf of hinge is inserted through a slot in door or frame, and the other leaf mortised
- Application A – specify "swaged to provide 3/16" [4.8mm] clearance between leaves when parallel and one leaf with standard punching and countersinking and other leaf drilled and tapped." Specify hand desired.
- Round corners – use prefix "RD" and specify radius desired. 1/4" [6.4mm] radius available on all sizes
- Other types and sizes available on request
- Pins in nonferrous hinges are stainless steel

Size Open		Gauge of Metal		Flat Head Screws Per Piece	Quantity Per		Case Weight		Case Weight	
Inches	(mm)	Inches	(mm)	Machine	Box	Case	Bronze	Steel	Lbs.	(Kg)
4 x 4	[102 x 102]	.130	[3.3]	8 - 12-24 x 1/2	3	48	44	[20]	45	[21]
4-1/2 x 4	[114 x 102]	.134	[3.4]	8 - 12-24 x 1/2	3	48	52	[24]	55	[25]
4-1/2 x 4-1/2	[114 x 114]	.134	[3.4]	8 - 12-24 x 1/2	3	48	55	[25]	59	[27]

* For application A when used on wood doors, specify wood screws for door leaf

Standard Weight Ball Bearing – Application "B"

FBB179 – (ANSI A8142) Slip-in application "B", Steel – polished and plated or painted

FBB191 – (ANSI A2142) Slip-in application "B", Brass or bronze – polished and plated or painted

FBB191 (32) – (ANSI A5142) Slip-in application "B", Stainless steel – highly polished

FBB191 (32D) – (ANSI A5142) Slip-in application "B", Stainless steel – satin finish



- For aluminum doors with aluminum frames
- "Slip-in" application where both leaves of hinge are inserted through slots in door and frame
- Application B – specify "both leaves swaged to provide 5/16" [7.9mm] clearance between leaves when parallel and both leaves drilled and tapped"
- Round corners – use prefix "RD" and specify radius desired. 1/4" [6.4mm] radius available on all sizes
- Other types and sizes available on request
- Pins in nonferrous hinges are stainless steel
- Not handed

Size Open		Gauge of Metal		Flat Head Screws Per Piece	Quantity Per		Case Weight		Case Weight	
Inches	(mm)	Inches	(mm)	Machine	Box	Case	Bronze	Steel	Lbs.	(Kg)
4 x 4	[102 x 102]	.130	[3.3]	8 - 12-24 x 1/2	3	48	44	[20]	45	[21]
4-1/2 x 4	[114 x 102]	.134	[3.4]	8 - 12-24 x 1/2	3	48	52	[24]	55	[25]
4-1/2 x 4-1/2	[114 x 114]	.134	[3.4]	8 - 12-24 x 1/2	3	48	55	[25]	59	[27]

* For application A when used on wood doors, specify wood screws for door leaf

5 Knuckle Pivot Reinforced Hinges

Heavy Weight Concealed Bearing
Shock Proof!

Steel – polished and plated or phosphated and prime coated for painting

FBB211 – (ANSI A8541)

FBB212 – (ANSI A8541)

FBB213 – (ANSI A8541)

Bronze – polished and finished

FBB221 – (ANSI A2541)

FBB222 – (ANSI A2541)

FBB223 – (ANSI A2541)

Stainless steel – satin finish

FBB221 (32D) – (ANSI A5541)

FBB222 (32D) – (ANSI A5541)

FBB223 (32D) – (ANSI A5541)



- Ideal for any door that is subject to jarring or abusive handling
- The purpose of this two-in-one combination is to anchor and reinforce doors and frames exposed to damage from abuse. In such installations, stresses are transferred to the top hinge
- A pivot and butt hinge are combined in one compact interlocked unit and share the same pin to assure perfect alignment.
- Interlocked corners prevent sidewise motion of pivot or butt leaves
- Heavy weight gauges increase available bearing surface area for maximum friction reduction
- Beveled edge doors require a different door plate than square edge doors
- Short door plate [4" (102mm) min.] available for use with most concealed holders and closers – specify on order
- Handed left or right

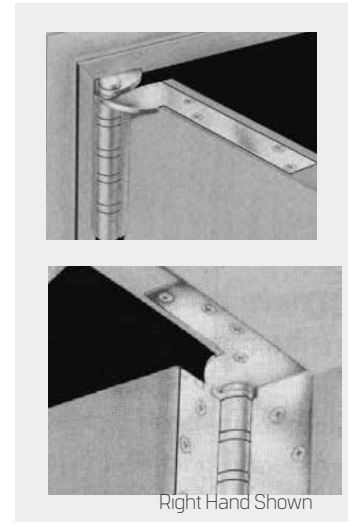

Class Number	Door Edge	Metal	Contents of Set			
			Top Hinge*	Intermediate and Bottom Hinge*		
				Number**	Inches	(mm)
FBB211	Square or beveled 1/8" in 2" (3.2 in 51mm)	Steel	1–Type of CBI68 NRP x Frame plate ONLY	2-CBI68-NRP	5 x 4-1/2	(127 x 114)
FBB212	Square	Steel	1–Type of CBI68 NRP x Frame and door plate	2-CBI68-NRP	5 x 4-1/2	(127 x 114)
FBB213	Beveled 1/8" IN 2" (3.2 in 51 mm)	Steel	1–Type of CBI68 NRP x Frame and door plate	2-CBI68-NRP	5 x 4-1/2	(127 x 114)
FBB221	Square or beveled (3.2 in 51 mm)	Bronze or Stainless Steel	1–Type of CBI99 NRP x Frame plate ONLY	2-CBI99-NRP	5 x 4-1/2	(127 x 114)
FBB222	Square	Bronze or Stainless Steel	1–Type of CBI99 NRP x Frame and door plate	2-CBI99-NRP	5 x 4-1/2	(127 x 114)
FBB223	Beveled 1/8" in 2" (3.2 in 51mm)	Bronze or Stainless Steel	1–Type of CBI99 NRP x Frame and door plate	2-CBI99-NRP	5 x 4-1/2	(127 x 114)

Class Number	Gauge of Metal		Frame Plate				Door Plate				Flat Head Screws Per Piece		Sets Per Case	Case Weight	
			Length		Width		Length		Width		Wood.	Machine		Lbs.	(Kg)
	Inches	(mm)	Inches	(mm)	Inches	(mm)	Inches	(mm)	Inches	(mm)					
FBB211	.190	(4.8)	5	(127)	1.25	(31.8)					28-12- x 1-1/2	28-12-24 x 1/2	1	6	(3)
FBB212	.190	(4.8)	5	(127)	1.25	(31.8)	7.78	(198)	1.25	(31.8)	32-12- x 1-1/2	32-12-24 x 1/2	1	7	(3)
FBB213	.190	(4.8)	5	(127)	1.25	(31.8)	7.64	(194)	1.25	(31.8)	32-12- x 1-1/2	32-12-24 x 1/2	1	7	(3)
FBB221	.190	(4.8)	5	(127)	1.25	(31.8)					12-12- x 1-1/2	28-12-24 x 1/2	1	6	(3)
FBB222	.190	(4.8)	5	(127)	1.25	(31.8)	7.78	(198)	1.25	(31.8)	16-12- x 1-1/2	32-12-24 x 1/2	1	7	(3)
FBB222 (32D)	.190	(4.8)	5	(127)	1.25	(31.8)	7.78	(198)	1.25	(31.8)	16-12- x 1-1/2	32-12-24 x 1/2	1	7	(3)
FBB223	.190	(4.8)	5	(127)	1.25	(31.8)	7.64	(194)	1.25	(31.8)	16-12- x 1-1/2	32-12-24 x 1/2	1	7	(3)
FBB223 (32D)	.190	(4.8)	5	(127)	1.25	(31.8)	7.64	(194)	1.25	(31.8)	16-12- x 1-1/2	32-12-24 x 1/2	1	7	(3)

* Hinges supplied with set screw in barrel, non-removable pin

** For doors over 7' 6" in height, specify additional hinges to order: specify catalog number, finish and hand

5 Knuckle Swing Clear Hinges

Standard Weight Plain Bearing "Swing Clear" Full Mortise

Steel – polished and plated or phosphated and prime coated for painting

F248 – [ANSI A8123]



- Equipped with easily seated non-rising pins
- Reversible flush tips and pins
- Ideal for remodeling or new construction
- Available for full mortise application on square edge doors only
- Designed to replace existing 3-1/2" [89mm] or 4" [102mm] hinges for Swing Clear openings (some modification of preparation may be required for residential use)
- Designed to swing doors completely clear of the opening when door is opened 95°

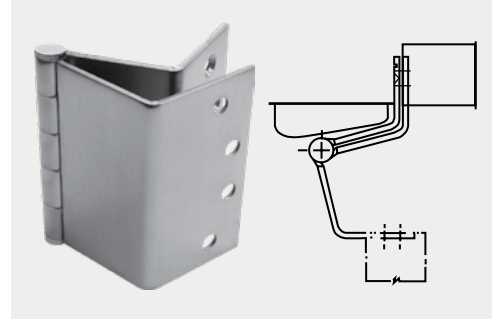

Class Number	Size Length of Joint		Gauge of Metal		Flat Head Screws Per Piece	Quantity Per Box	Quantity Per Case	Case Weight	
	Inches	[mm]	Inches	[mm]		Each	Each	Lbs.	[Kg]
F248	3-1/2	[89]	.123	[3.1]	6-10 x 1	2	20	16	[7]
	4	[102]	.130	[3.3]	8-12 x 1 1/4	2	20	24	[11]

5 Knuckle Swing Clear Hinges

Standard Weight Ball Bearing "Swing Clear" Full Mortise

Steel – polished and plated or phosphated and prime coated for painting

FBB248 – [ANSI A8122]

FBB258 – [ANSI A8122]

Stainless steel – highly polished or satin finish

STSFBB248 – [ANSI A5122]

STSFBB258 – [ANSI A5122]



- Reversible flush tips and pins
- Ideal for remodeling or new construction
- Specify FBB248 and STSFBB248 for full mortise application on square edge doors
- Specify FBB258 and STSFBB258 for full mortise application on bevel edge doors
- Designed to swing doors completely clear of the opening when door is opened 90°
- Equipped with two permanently lubricated non-detachable ball bearings
- Hinges can be furnished with hospital tips [HT]

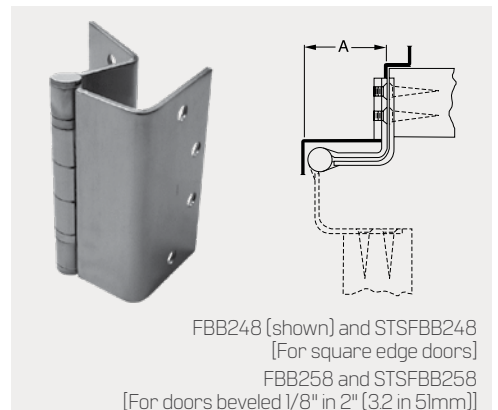

Class Number	Class Number	Size Length of Joint		Minimum Clearance Required Dimensions "A"		Gauge of Metal		Flat Head Screws Per Piece		Quantity Per Box	Quantity Per Case	Case Weight	
		Inches	[mm]	Inches	[mm]	Inches	[mm]	Machine	Wood			Each	Each
FBB248	STSFBB248	4-1/2	[114]	2-1/8	[54]	.134	[3.4]	4-12-24 x 1/2	4-12 x 1 1/4	3	24	36	[17]
FBB258	STSFBB258	4-1/2	[114]	2-1/8	[54]	.134	[3.4]	4-12-24 x 1/2	4-12 x 1 1/4	3	24	36	[17]

Heavy Weight Ball Bearing "Swing Clear"

Heavy Weight Ball Bearing "Swing Clear"

Steel – polished and plated or phosphated and prime coated for painting

FBB268 – [ANSI A8121]

FBB278† – [ANSI A8121]

FBB269 – [ANSI A8421]

FBB264 – [ANSI A8221]

FBB274† – [ANSI A8221]

FBB266 – [ANSI A8321]

Stainless steel – highly polished or satin finish

STSCB268 – [ANSI A5121]

STSCB278† – [ANSI A5121]

STSCB269 – [ANSI A5421]

STSCB264 – [ANSI A5221]

STSCB274† – [ANSI A5221]

STSCB266 – [ANSI A5321]



- For corridor doors to patients' rooms, operating rooms, emergency rooms, or wherever conditions require a completely clear opening in hospitals, institutions or public buildings
- Designed to swing door completely clear of the opening when door is opened 95°
- Consult factory for hinges available to clear 90°
- Equipped with four permanently lubricated non-detachable ball bearings
- Pins in nonferrous hinges are stainless steel
- Heavy weight gauges increase available bearing surface area for maximum friction reduction

- Hinges can be furnished with hospital tips
- Full surface and half surface hinges packed with flat head machine screws and grommet nuts for door leaf, specify door thickness if other than 1-3/4"
- Consider using a back plate on full surface and half surface hinges
- For half mortise and full surface hinges to fit narrow metal frames, consult factory
- Reversible flush tips and pins

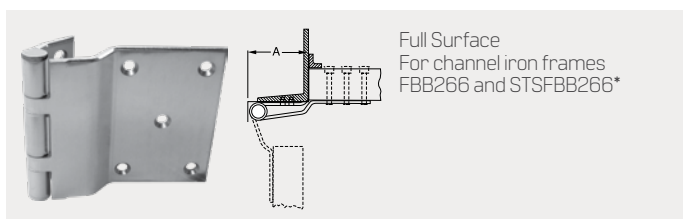
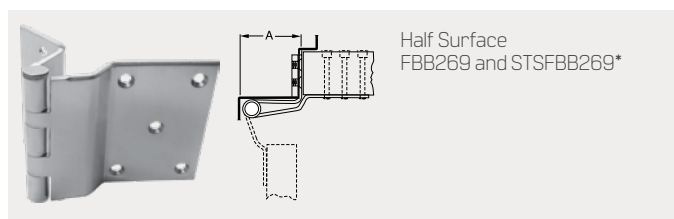
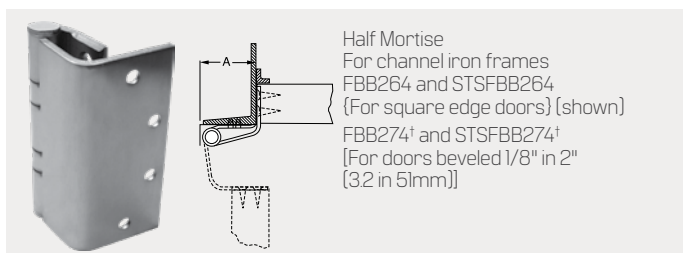
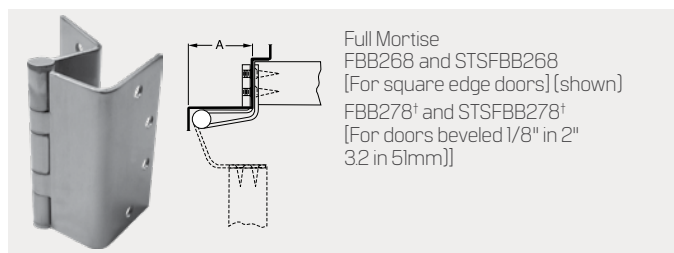

Class Number	Size	Length of Joint		Minimum Clearance Required Dimensions "A"		Gauge of Metal		Flat Head Screws Per Piece		Sets Per Box	Sets Per Case	Case Weight	
		Inches	(mm)	Inches	(mm)	Inches	(mm)	Machine.	Wood			Each	Each
FBB268,	STSFBB268	4-1/2	[114]	2-1/8	[54]	.180	[4.6]	4-12-24 x 1/2	4-12 x 1-1/4 WS	3	15	31	[14]
FBB268,	STSFBB268	5	[127]	2-1/8	[54]	.190	[4.8]	4-12-24 x 1/2	4-12 x 1-1/4 WS	3	15	35	[16]
FBB278†,	STSFBB278†	4-1/2	[114]	2-1/8	[54]	.190	[4.8]	4-12-24 x 1/2	4-12 x 1-1/4 WS	3	15	31	[14]
FBB278†,	STSFBB278†	5	[127]	2-1/8	[54]	.190	[4.8]	4-12-24 x 1/2	4-12 x 1-1/4 WS	3	15	35	[16]
FBB269,	STSFBB269	5	[127]	2-1/8	[54]	.190	[4.8]	4-12-24 x 1/2	5-1/4-20 x 1-1/4 MS.*	3	15	9	[4]
FBB264,	STSFBB264	5	[127]	2-1/8	[54]	.190	[4.8]	4-12-24 x 1/2	4-12 x 1-1/4 WS	3	15	35	[16]
FBB274†	STSFBB274	5	[127]	2-1/8	[54]	.190	[4.8]	4-12-24 x 1/2	4-12 x 1-1/4 WS	3	15	35	[16]
FBB266,	STSFBB266	5	[127]	2-1/8	[54]	.190	[4.8]	4-12-24 x 1/2	5-1/4-20 x 1-1/4 MS.*	3	15	35	[16]

* Furnished with through-bolts and grommet nuts.

† For doors beveled 1/8" IN 2" [3.2MM IN 51 MM] on hinge side. For frame and door leaf dimensions refer to template furnished on request. If door closers, friction or overhead door holders are to be used in conjunction with these hinges, consult manufacturer of the device to be used for application details

5 Knuckle Hinges

Full Mortise Standard Weight Plain Bearing

F179 – (ANSI A8133 except for 3" x 3") Steel – polished and plated or phosphated and prime coated for painting

F191 – (ANSI A2133) Brass or bronze – polished and plated or painted

F191 (32) – (ANSI A5133) Stainless steel – highly polished

F191 (32D) – (ANSI A5133) Stainless steel – satin finish



- For use on internal or external doors without door closers in hospitals, churches, schools, airports, hotels, malls, apartment houses, office buildings, etc.
- All hinges have template screw hole location for use on either wood or hollow metal doors and frames
- Use anti-friction bearing hinges on high and average frequency doors and all doors equipped with door closers
- Hinges can be furnished with hospital tips (HT)



Size Open		Gauge of Metal		Flat Head Screws Per Piece		Quantity Per		Case Weight		Case Weight	
Inches	[mm]	Inches	[mm]	Machine	Wood	Box	Case	Lbs.	[Kg]	Lbs.	[Kg]
3 x 3*	[76 x 76]	.080	[2]		6 - 9 x 3/4	2	100	32	[15]		
3-1/2 x 3	[89 x 76]	.123	[3.1]	6 - 10-24 x 1/2	6 - 10 x 1	2	100	60	[27]	64	[29]
3-1/2 x 3-1/2	[89 x 89]	.123	[3.1]	6 - 10-24 x 1/2	6 - 10 x 1	2	100	66	[30]	72	[33]
4 x 3-1/2	[102 x 89]	.130	[3.3]	8 - 12-24 x 1/2	8 - 12 x 1-1/4	3	48	38	[17]	44	[20]
4 x 4	[102 x 102]	.130	[3.3]	8 - 12-24 x 1/2	8 - 12 x 1-1/4	3	48	43	[20]	46	[21]
4-1/2 x 4	[114 x 102]	.134	[3.4]	8 - 12-24 x 1/2	8 - 12 x 1-1/4	3	48	51	[23]	54	[25]
4-1/2 x 4-1/2	[114 x 114]	.134	[3.4]	8 - 12-24 x 1/2	8 - 12 x 1-1/4	3	48	55	[25]	60	[27]
*5 x 4	[127 x 102]	.146	[3.7]	8 - 12-24 x 1/2	8 - 12 x 1-1/4	3	30	40	[18]	43	[20]
*5 x 4-1/2	[127 x 127]	.146	[3.7]	8 - 12-24 x 1/2	8 - 12 x 1-1/4	3	30	43	[20]	46	[21]
*5 x 5	[127 x 127]	.146	[3.7]	8 - 12-24 x 1/2	8 - 12 x 1-1/4	3	48	46	[21]	51	[23]

*Steel only – for other substrates consult factory

Half Surface Standard Weight Plain Bearing

F173 – (ANSI A8433) Steel – polished and plated or phosphated and prime coated for painting



- For low frequency kalamein or wood doors
- Use ball bearing hinges on all doors equipped with door closers
- Easily applied as only jamb leaf is mortised
- Packed with machine screws and grommet nuts

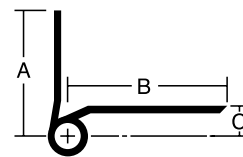

Measurements below



Size Length of Joint		Width		Offset		Gauge of Metal		Flat Head Screws Per Piece		Quantity Per		Case Weight			
Inches	[mm]	Inches	[mm]	Inches	[mm]	Inches	[mm]	Lbs.	Lbs.	Box	Case	Lbs.	[Kg]		
4-1/2	[114]	2-1/16	[52.4]	2-9/16	[65.1]	9/16	[14.3]	.134	[3.4]	4-12-24 x 1/2	3-1/4-20 x 2	3	30	37	[17]

5 Knuckle Residential Hinges

Full Mortise Light Weight Plain Bearing

741 (ANSI A8312) – Steel

RD741BA (ANSI A8312) – Steel

RD758BA (ANSI A8312) – Steel



- For use on lightweight residential doors in low frequency applications
- Non-rising removable flush pin
- Five knuckle, full mortise design
- 741, RD741BA, and RD758BA ship bulk assembled without screws
- Screw model 763 (3/4" x 9 (Type 17 Fly Cut) must be ordered separately
- Avail in square corners (741), 1/4" (6.4mm) radius corners (RD741BA) and 5/8" (15.9mm) radius corners (RD758)



741



RD741BA



RD758BA

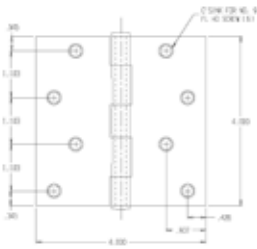

741 - 4x4 Template

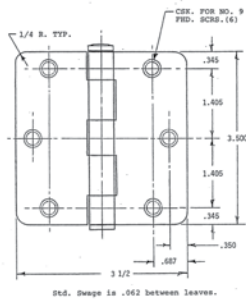

RD741 - 3.5x3.5 Template

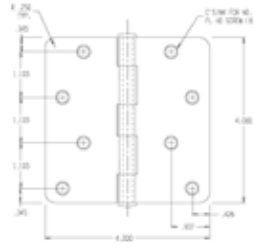

RD741 - 4x4 Template

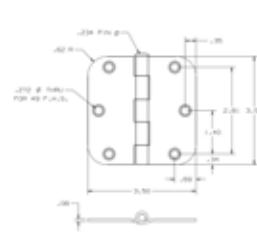

RD758 - 3.5x3.5 Template

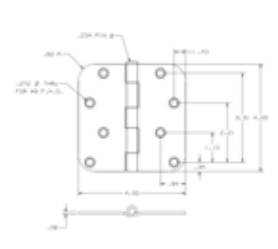

RD758 - 4x4 Template

Model	Size Option	Gauge of Metal (Inches : mm)	Corner Radius	Quantity per carton	
741	3x3	0.088	223	Square	100
741	3.5x3.5	0.088	223	Square	100
741	4x4	0.088	223	Square	100
RD741BA	3.5x3.5	0.088	223	1/4"	100
RD741BA	4x4	0.088	223	1/4"	100
RD758BA	3.5x3.5	0.088	223	5/8"	100
RD758BA	4x4	0.088	223	5/8"	100

763 - Bulk screw pack for residential hinges

Model	Size Option	Quantity per carton
763	3/4" x 9 Type 17	600

Half Mortise Standard Weight Plain Bearing

F167 – (ANSI A8233) Steel – polished and plated or phosphated and prime coated for painting



- For low frequency hollow metal or wood doors with channel iron frames
- Use ball bearing hinges on all doors equipped with door closers
- Easily applied as only door leaf is mortised

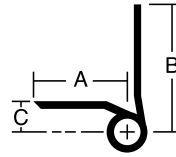

Measurements below



Size Length of Joint		Width				Offset		Gauge of Metal		Flat Head Screws Per Piece		Quantity Per		Case Weight	
Inches	(mm)	Frame Leaf (A)		Door Leaf (B)		Door Leaf (C)		Inches	(mm)	Lbs.	Lbs.	Each Box	Each Case	Lbs.	(Kg)
4-1/2	(114)	1-1/2	(38.1)	2-1/16	(52.4)	7/16	(11.1)	.134	(3.4)	4-12-24 x 1/2	3-12-24 x 1/2	3	30	28	(13)

Conversion Tips and Pins

- Converts standard flush tip "CB1900R" and "1900R"
- Available in three styles: Ball, Crown and Steeple
- Same tips fit "CB", "1900R" and "F" line hinge
- Conversion pins are stainless
- Conversion pins accept NRP screw
- Knurl eliminates pin rotation
- For heavy weight consult factory

Standard Weight Tips and Pins





CORPORATE HEADQUARTERS

6161 EAST 75TH STREET
INDIANAPOLIS, IN 46250 USA

Phone 855-365-2407

bestaccess.com

For questions about ordering and to be sure you get the right configuration for your needs, [contact your BEST dormakaba sales representative](#).
6161 East 75th Street, Indianapolis, IN 46250 USA | [855-365-2407](tel:855-365-2407) | bestaccess.com

BEST is a trademark of dormakaba Holding® 2021 All rights reserved. BEST is a member of the dormakaba Group, one of the top three providers for access and security solutions, globally.

