



# Everyday Basics

**Proven**  
performers.

---

**Affordable**  
prices.

A residential & commercial solution:

# Everyday Basics

Make a **big impact** on a **small budget.**

**750+**  
SKUs

**23** knobs

**58**  
style-forward designs

**30** pulls

**3** cup pulls

**2** edge pulls

A full breadth of pull sizes

**23%**  
3in  
(76mm) CTC

**24%**  
3-3/4in  
(96mm) CTC

**23%**  
5-1/16in  
(128mm) CTC

**23%**  
6-5/16in  
(160mm) CTC

**7%**  
7-9/16in  
(192mm) CTC  
and longer

A. Elega (p. 50) B. Arden (p. 20) C. Loop (p. 66) D. Incisive (p. 61)  
E. Central (p. 36) F. Cityscape (p. 38) G. Willow (p. 96) H. Chamfered Edge (p. 37)



**5** core finishes

## Complementing Finishes

Seamlessly tie the whole look together with these suggested **Amerock finish companions**.



Amerock Finish	Plumbing
<b>1</b> <b>Polished Chrome</b> (26)	<ul style="list-style-type: none"> <li>• <b>Delta® &amp; Moen®:</b> Chrome</li> <li>• <b>Brizo® &amp; Kohler®:</b> Polished Chrome</li> </ul>
<b>2</b> <b>Satin Nickel</b> (G10)	<ul style="list-style-type: none"> <li>• <b>Brizo® &amp; Moen®:</b> Brushed Nickel</li> <li>• <b>Delta®:</b> Stainless</li> <li>• <b>Kohler®:</b> Vibrant Brushed Nickel</li> </ul>
<b>3</b> <b>Champagne Bronze</b> (CZ)	<ul style="list-style-type: none"> <li>• <b>Brizo®:</b> Luxe Gold</li> <li>• <b>Delta®:</b> Champagne Bronze</li> <li>• <b>Kohler®:</b> Vibrant Brushed Moderne Brass</li> <li>• <b>Moen®:</b> Brushed Gold</li> </ul>
<b>4</b> <b>Oil-Rubbed Bronze</b> (ORB)	<ul style="list-style-type: none"> <li>• <b>Brizo®:</b> Venetian Bronze</li> <li>• <b>Delta®, Kohler® &amp; Moen®:</b> Oil-Rubbed Bronze</li> </ul>
<b>5</b> <b>Matte Black</b> (FB) (MB)	<ul style="list-style-type: none"> <li>• <b>Brizo®, Delta®, Kohler® &amp; Moen®:</b> Matte Black</li> </ul>



Looking for additional tips?



**92%**  
\$10 and under

- A** | \$5 or less
- B** | >\$5 to \$10
- C** | >\$10 to \$15

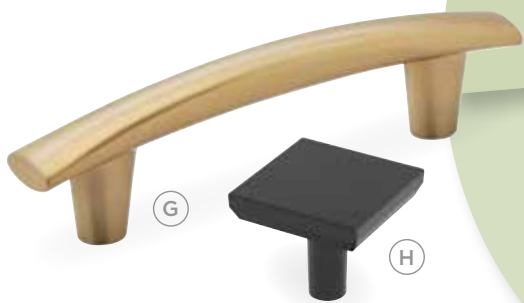
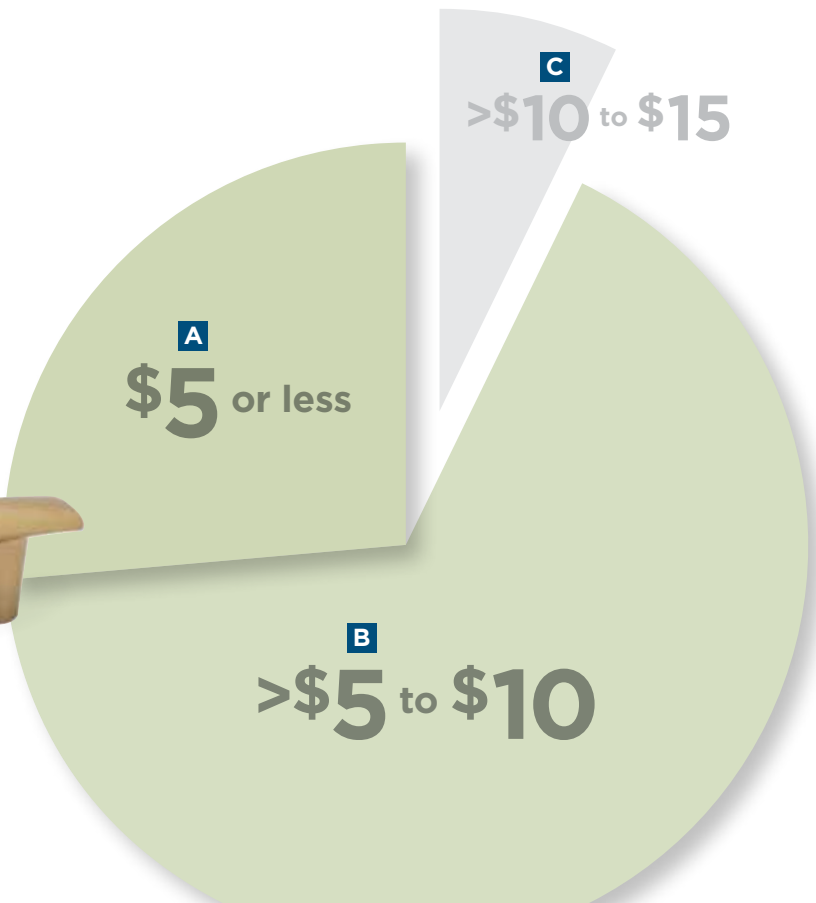



A 95-year legacy...

# Building the *foundation*

## Making *confident* choices effortless

With a wide breadth of products designed to complement popular plumbing, lighting and door hardware manufacturers, **it's easy to pull together a cohesive look.**

### Free samples program

Ensure you have the **right size, style, and finish for every project.** Contact your Amerock sales rep for details.

## Brand preservation

Amerock will conduct business solely with dealers and retailers who choose to advertise Amerock products in accordance with our **Minimum Advertised Price (MAP)** policy.

## A convenient dealer portal at your fingertips

Anyone with an Amerock customer account is eligible to use the portal on [Amerock.com](http://Amerock.com)

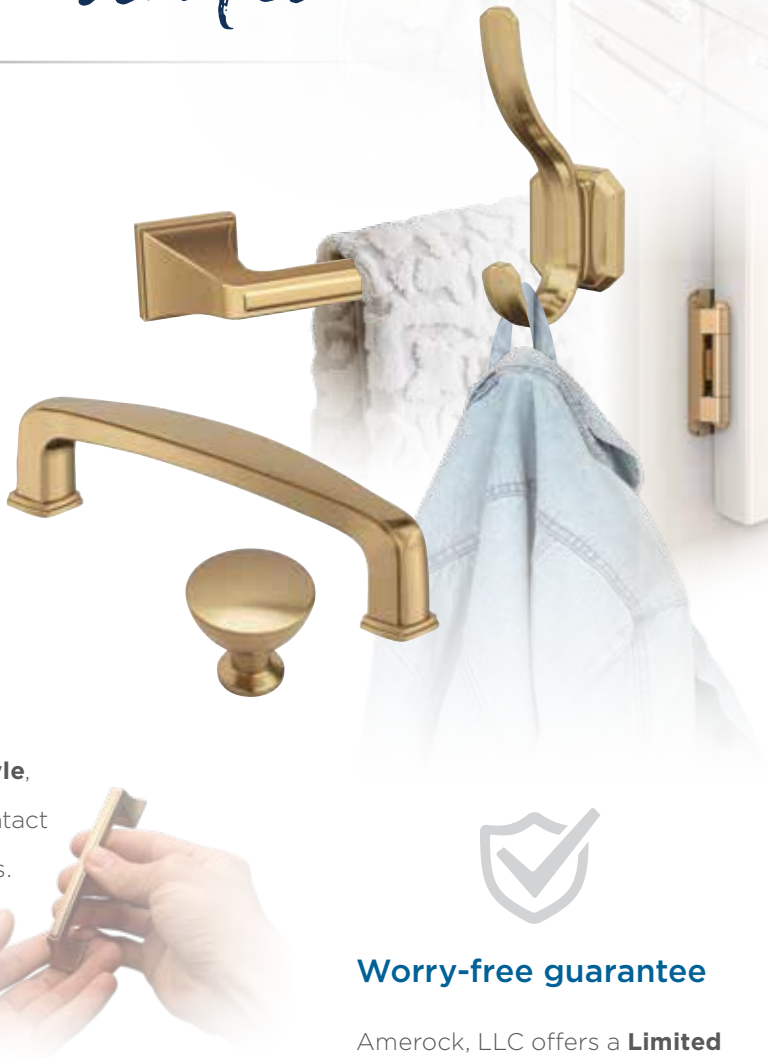
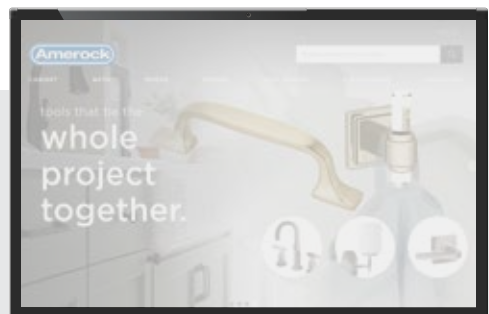

### Worry-free guarantee

Amerock, LLC offers a **Limited Warranty on all products.**

Visit [Amerock.com](http://Amerock.com) for terms.



# Selling made *easier*



## Merchandising simplified

We know that a one-size-fits-all approach doesn't work for merchandising. **Amerock's versatile solutions streamline the selection process and minimize pain points.**



Place and track  
all orders



Check stock  
availability



Obtain  
pricing



Order free  
samples

For help setting up your account, contact Amerock Customer Care:  
[amerock.customersupport@amerock.com](mailto:amerock.customersupport@amerock.com)



## Multiple ways to order

### 1 Electronic Data Interchange (EDI)

To learn more, email [edi\\_notify@amerock.com](mailto:edi_notify@amerock.com)

### 2 Fax or email

- **Standard Orders:**

800-618-6733

[amerock.orders@amerock.com](mailto:amerock.orders@amerock.com)

- **Next Day Air (NDA) Orders:**

800-527-0479

[amerock.specialorders@amerock.com](mailto:amerock.specialorders@amerock.com)

*Minimum Order Value (MOV) of \$50 may apply.*

### 3 Dealer Portal

Place orders in our private, secure dealer portal on Amerock.com.

*To learn more, see bottom of page.*

## Delivery the way it should be

Striving to deliver **best-in-class logistics service**

- Standard shipping reaches 80% of US in three days or less.
- Orders ship within 24 hours and will ship same day if received prior to 4pm EST.

# The legacy *continues*

**80%** of consumers start their research online...

...but only about **20%** complete their purchase online.

## Envisioning the finished product

Embracing digital as a key component in the shopper's journey, **Amerock continues to evolve toward a best-in-class digital experience.**

### Finish companions.

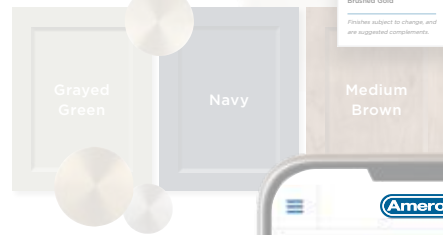

**Suggested pairings. Style & Finish**

- ✓ Plumbing: Delta® (Brushed Champagne Bronze)
- ✓ Door Hardware: No close companions. Selection: follow mix & match finishes on right.
- ✓ Lighting: Progress Lighting™ (Elevate Brushed Gold)
- ✓ Decorative Hook: Amerock (Champagne Bronze)

**Mix & match finishes. Do's & Don'ts**

- ✓ Finishes that contrast: Brushed Gold Finishes + Polished Silver Finishes, Matte Black Finishes.
- ✗ Finishes in the same color family: Brushed Gold Finishes + Brass Finishes.

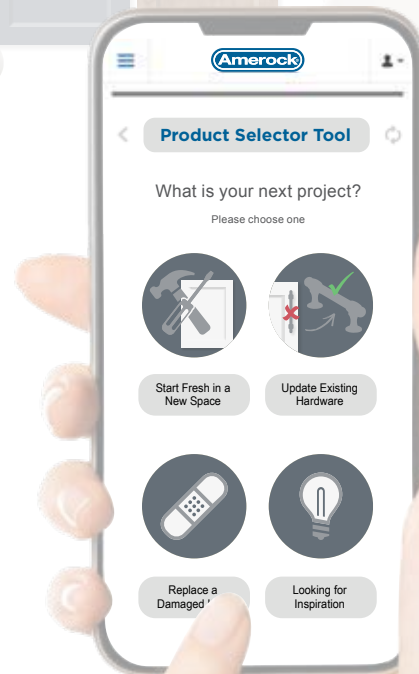
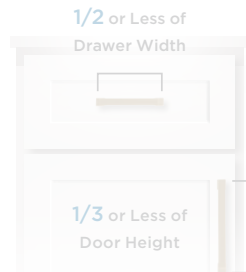

### Must-have bath measurements.

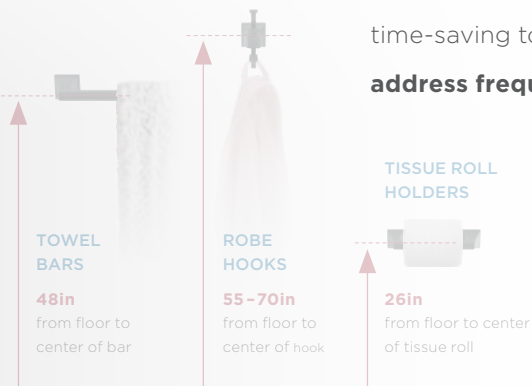

## Tools that move you faster

We've handled the details. Amerock provides time-saving tools that **inspire, educate,** and **address frequently asked questions.**

## Key software inclusion

Key software partnerships make it easier than ever to bring Amerock into your designs. In **2020 Design Live (v11.12 & up)**, our products can be **easily imported into projects** and utilized within cabinet manufacturer catalogs.



Here's how to **find Amerock.**

**2020**  
ACCREDITED  
MANUFACTURER

**envision**

# Contents

---

Program Overview	2
Amerock: The Right Choice	4
Collections Quick-Reference	8

---

Featured Collections	16
Angle	16
Arc	18
Arden	20
Augment	20
Bar Pulls	22
Bar Pulls Hollow	32
Bar Pulls Square	34
Bridgeport	35
Central	36
Chalice	37
Chamfered Edge	37
Cityscape	38

## Collections (cont'd)

Composite	40
Cup Pulls	42
Current	43
Cyprus	44
Edge Pulls	48
Edona	49
Eleva	50
Era	50
Evolve	51
Extensity	52
Fairfield	54
Franklin	55
Garfield	56
Grail	56
Granby	57
Hatfield	59
Haven	59
Hybridize	60
Incisive	61
Inspirations	62
Intersect	64
Intertwine	65
Loop	66
Metro	66
Monument	69

## Collections (cont'd)

Pailou	75
Parabolic	76
Pedestal	77
Prominence	77
Ravino	78
Revolve	81
Rift	82
Sheffield	83
Socle	84
Streamline II	84
Streamline Tab	86
Sunset	87
Torrance	87
Triomphe	88
Vaile	89
Versa	91
Whistle	96
Willow	96
Wire Pulls	98

---

Product Index 99

Center-to-Center  
Measuring Tool 107

## Ahead of the *curve*. Universal Design.

Evolving with the needs of homeowners, Amerock keeps **accessibility** and **ergonomics** in mind with ADA-Friendly\* pulls.

- ✓ **Clearance to accommodate** the hand of an average man.
- ✓ **For easy grip, pulls are U-shaped** and don't require tight grasping, pinching or twisting.

\* Designed according to Section 309.4 of the ADA Accessibility Guidelines (ADAAG) and the Dreyfuss Human Factor Scale.



Designated products in this catalog are marked with a star.



Discover Amerock's  
**ADA-Friendly pulls.**

# Collections

## QUICK REFERENCE

Example:  
**Amerock**  
**Part No.**



PRICE CODE BREAKDOWN • US Dollars					
<b>A</b>	\$5 or less	<b>E</b>	>\$20 to \$30	<b>I</b>	>\$75 to \$100
<b>B</b>	>\$5 to \$10	<b>F</b>	>\$30 to \$40	<b>J</b>	>\$100 to \$150
<b>C</b>	>\$10 to \$15	<b>G</b>	>\$40 to \$50	<b>K</b>	>\$150 to \$200
<b>D</b>	>\$15 to \$20	<b>H</b>	>\$50 to \$75	<b>L</b>	>\$200











- Polished Chrome (26)
- Stainless Steel (SS)
- Champagne Bronze (CZ)
- Matte Black (MB) (FB)
- Polished Nickel (PN)
- Polished Brass (3)
- Oil-Rubbed Bronze (ORB)
- Black Bronze (BBR)
- Satin Nickel (G10)
- Golden Champagne (BBZ)

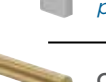

† = Coming Soon

	Knobs	Pulls							Available Finishes <i>(See top of page)</i>	
		76mm CTC	96mm CTC	128mm CTC	160mm CTC	192mm CTC	224mm CTC	256mm CTC	288mm CTC	
Angle <i>p. 16-17</i>	—	<b>B</b> 37299†	<b>B</b> 37300	<b>B</b> 37301	<b>B</b> 37304†	<b>C</b> 37302	—	<b>C</b> 37303	—	26, G10, CZ, MB
Arc <i>p. 18-19</i>	—	<b>A</b> 3416 37355 69153	<b>A</b> ★ 37356	<b>B</b> ★ 37357	<b>B</b> ★ 69158†	—	—	—	—	<b>3416:</b> 26, 3 <b>37355:</b> CZ, ORB, MB <b>69153:</b> G10 <b>37356, 37357, &amp; 69158:</b> 26, G10, CZ, ORB, MB
Arden <i>p. 20</i>	<b>B</b> 37340	—	—	—	—	—	—	—	—	26, G10, CZ, MB
Augment <i>p. 20-21</i>	—	<b>A</b> 37150	<b>B</b> ★ 37151	<b>B</b> ★ 37152	<b>B</b> ★ 37153	—	—	—	—	26, G10, CZ, MB



	Knobs	Cup Pulls 76mm CTC	76mm CTC	96mm CTC	128mm CTC	Pulls 160mm CTC   192mm CTC   224mm CTC   256mm CTC   288mm CTC					Appliance Pulls 12in CTC   18in CTC		Available Finishes <i>(See top of page)</i>
 Bar Pulls <i>p. 22-31</i>	See p. 14-15 for sizes & finishes available.												
 Bar Pulls Hollow <i>p. 32-33</i>	A 37029	—	A 37240	A 37241	A 37242	A 37243	A 37244	B 37245	B 37246	B 37247	—	—	26, SS, MB
 Bar Pulls Square <i>p. 34</i>	—	—	A 37175	B 37176	B 37177	B 37178	—	—	—	—	—	—	26, G10, CZ, MB
 Bridgeport <i>p. 35</i>	—	—	B 37030	B ★ 37031	B ★ 37032	B ★ 37033	—	—	—	—	—	—	26, G10, CZ, ORB, MB
 Central <i>p. 36</i>	—	—	B 37160	B 37161	B 37162	B 37163	—	—	—	—	—	—	26, G10, CZ, MB
 Chalice <i>p. 37</i>	A 37022	—	—	—	—	—	—	—	—	—	—	—	26, G10, CZ, ORB, MB
 Chamfered Edge <i>p. 37</i>	A 37028	—	—	—	—	—	—	—	—	—	—	—	26, G10, ORB, MB
 Cityscape <i>p. 38-39</i>	—	—	A 37130	B 37131	B ★ 37132	B ★ 37133	B ★ 37134	—	C ★ 37135	—	—	—	26, G10, CZ, ORB, MB
 Composite <i>p. 40-41</i>	—	—	B 37140	B 37141	B 37142	B 37143	C 37144	—	—	—	—	—	26, G10, CZ, MB
 Cup Pulls <i>p. 42</i>	—	B 53010	—	—	—	—	—	—	—	—	—	—	26, PN, G10, BBZ, CZ, ORB, FB
 Current <i>p. 43</i>	—	—	A 37210	B 37211	B 37212	B 37213	—	—	—	—	—	—	26, G10, CZ, MB
 Cyprus <i>p. 44-47</i>	—	—	B 26201	C 26203	C 9362	D 26204	D 26208 <sup>†</sup>	E 26209 <sup>†</sup>	F 26210 <sup>†</sup>	—	J 26206	K 26207	26, PN, G10, BBZ, CZ, ORB, BBR

# Collections

## QUICK REFERENCE

Example:  
**Amerock**  
Part No.



### PRICE CODE BREAKDOWN • US Dollars

<b>A</b>	\$5 or less	<b>E</b>	>\$20 to \$30	<b>I</b>	>\$75 to \$100
<b>B</b>	>\$5 to \$10	<b>F</b>	>\$30 to \$40	<b>J</b>	>\$100 to \$150
<b>C</b>	>\$10 to \$15	<b>G</b>	>\$40 to \$50	<b>K</b>	>\$150 to \$200
<b>D</b>	>\$15 to \$20	<b>H</b>	>\$50 to \$75	<b>L</b>	>\$200













- Polished Chrome (26) (CH)
- Antique Silver (AS)
- Champagne Bronze (CZ)
- Oil-Rubbed Bronze (ORB)
- Polished Nickel (PN)
- Polished Brass (3)
- Burnished Brass (BB)
- Matte Black (MB) (FB)
- Satin Nickel (G10)
- Golden Champagne (BBZ)



= Coming Soon

	Knobs	Edge Pulls			Pulls				Available Finishes <i>(See top of page)</i>
		96mm LGTH	116mm LGTH	148mm LGTH	76mm CTC	96mm CTC	128mm CTC	160mm CTC	
Edge Pulls <i>p. 48</i>	—	<b>A</b> 36573	<b>B</b> 36574	<b>B</b> 36575	—	—	—	—	26, PN, G10, CZ, ORB, FB
Edona <i>p. 49</i>	<b>A</b> 53005	—	—	—	—	—	—	—	26, PN†, G10, AS, 3, BBZ, CZ, BB, ORB, FB
Eleva <i>p. 50</i>	<b>B</b> 37021	—	—	—	—	—	—	—	26, G10, CZ, ORB, MB
Era <i>p. 50</i>	<b>A</b> 36907	—	—	—	—	—	—	—	26, G10, ORB, FB
Evolve <i>p. 51</i>	—	—	—	—	<b>B</b> 37070	<b>B</b> ★ 37071	<b>B</b> ★ 37072	<b>B</b> ★ 37073	26, G10, CZ, ORB, MB
Extensity <i>p. 52-53</i>	<b>A</b> * <b>B</b> ** 29370 <b>B</b> 29398	—	—	—	<b>B</b> 29379	<b>B</b> 29385	<b>B</b> 29393	<b>C</b> 29394	26, G10, CZ, ORB, FB
Fairfield <i>p. 54</i>	—	—	—	—	<b>A</b> 173	<b>B</b> 37220	<b>B</b> ★ 37221	<b>B</b> ★ 37222	CH, G10, CZ, ORB, FB
Franklin <i>p. 55</i>	—	—	—	—	<b>B</b> 37050	<b>B</b> ★ 37051	<b>B</b> ★ 37052	<b>B</b> ★ 37053	26, G10, CZ, ORB, MB
Garfield <i>p. 56</i>	<b>A</b> 37020	—	—	—	—	—	—	—	26, G10, CZ, ORB, MB

For Extensity 29370: \* Price code for 26 & FB. \*\* Price code for G10, CZ, & ORB.

		Knobs	Cup Pulls 76mm CTC	Finger Pulls	Pulls							Appliance Pulls		Available Finishes <i>(See top of page)</i>	
					76mm CTC	96mm CTC	128mm CTC	160mm CTC	192mm CTC	224mm CTC	256mm CTC	320mm CTC	12in CTC	18in CTC	
	Grail p. 56	<b>B</b> 37330	—	—	—	—	—	—	—	—	—	—	—	—	26, G10, CZ, MB
	Granby p. 57-58	—	—	—	<b>A</b> 53013	<b>B</b> ★ 55243	<b>B</b> ★ 55244	<b>C</b> ★ 55245	—	—	—	—	—	—	26, PN, G10, CZ, ORB, FB
	Hatfield p. 59	<b>A</b> 29113	—	—	—	—	—	—	—	—	—	—	—	—	26, G10, ORB, MB
	Haven Two-Way Install p. 59	—	<b>B</b> 76mm & 96mm 37180	—	—	—	—	—	—	—	—	—	—	—	26, G10, CZ, ORB, MB
	Hybridize p. 60	—	—	—	<b>B</b> 37060	<b>B</b> ★ 37061	<b>B</b> ★ 37062	<b>B</b> ★ 37063	—	—	—	—	—	—	26, G10, CZ, ORB, MB
	Incisive p. 61	—	—	—	<b>B</b> 37120	<b>B</b> ★ 37121	<b>B</b> ★ 37122	<b>B</b> ★ 37123	—	—	—	—	—	—	26, G10, CZ, ORB, MB
	Inspirations p. 62-64	<b>B</b> 33mm DIA 1586	—	—	—	—	—	—	—	—	—	—	—	—	26, G10, CZ, ORB, FB
		<b>C</b> 44mm DIA 15862	<b>C</b> 1592	<b>B</b> 1593	<b>B</b> 1590	<b>B</b> ★ 1587	<b>B</b> ★ 1588	<b>C</b> ★ 1589 <sup>†</sup>	—	—	—	—	—	—	
	Intersect p. 64	<b>A</b> 37027	—	—	—	—	—	—	—	—	—	—	—	—	26, G10, CZ, MB
	Intertwine p. 65	—	—	—	<b>A</b> 21171	<b>B</b> 21172	<b>B</b> 21173	<b>B</b> ★ 21174	—	—	—	—	—	—	26, G10, CZ, ORB, FB
	Loop p. 66	<b>A</b> 37025	—	—	—	—	—	—	—	—	—	—	—	—	26, G10, CZ, ORB, MB
	Metro p. 66-68	—	—	—	<b>B</b> 37289 <sup>†</sup>	<b>B</b> 37290	<b>B</b> 37291	<b>B</b> 37292	<b>B</b> 37293	<b>C</b> 37294	—	—	—	—	26, G10, CZ, MB
	Monument p. 69-74	<b>B</b> 36905	—	—	<b>A** B*</b> 36578	<b>B</b> ★ 36570	<b>B</b> ★ 36571	<b>B</b> ★ 36572	<b>B</b> ★ 36908	<b>B** D*</b> ★ 36909	<b>D</b> ★ 36910	<b>E</b> ★ 36911	<b>J</b> ★ 54045	<b>K</b> ★ 54046	26, PN, G10, BBZ, CZ, ORB, FB
	Pailou p. 75	—	—	—	—	<b>B</b> 37322	<b>B</b> 37323	<b>B</b> 37324	—	—	—	—	—	—	26, G10, CZ, MB

For Monument 36578 & 36909: \* Price code for BBZ. \*\* Price code for all other finishes.

# Collections

## QUICK REFERENCE

Example:  
**Amerock**  
Part No.



### PRICE CODE BREAKDOWN • US Dollars









<b>A</b>	\$5 or less	<b>E</b>	>\$20 to \$30	<b>I</b>	>\$75 to \$100
<b>B</b>	>\$5 to \$10	<b>F</b>	>\$30 to \$40	<b>J</b>	>\$100 to \$150
<b>C</b>	>\$10 to \$15	<b>G</b>	>\$40 to \$50	<b>K</b>	>\$150 to \$200
<b>D</b>	>\$15 to \$20	<b>H</b>	>\$50 to \$75	<b>L</b>	>\$200

- Polished Chrome (26)
- Satin Nickel (G10)
- Oil-Rubbed Bronze (ORB)
- Brushed Chrome (26D)
- Golden Champagne (BBZ)
- Matte Black (MB) (FB)
- Polished Nickel (PN)
- Champagne Bronze (CZ)



† = Coming Soon

	Knobs	Cup Pulls 76mm CTC	Edge Pulls				Pulls				Available Finishes <i>(See top of page)</i>
			44mm LGTH	76mm LGTH	102mm LGTH	127mm LGTH	152mm LGTH	76mm CTC	96mm CTC	128mm CTC	
Parabolic <i>p. 76</i>	—	—	—	—	—	—	<b>A</b> 37345	<b>B</b> ★37346	<b>B</b> ★37347	<b>B</b> ★37348†	26, G10, CZ, ORB, MB
Pedestal <i>p. 77</i>	<b>A</b> 37024	—	—	—	—	—	—	—	—	—	26, G10, CZ, ORB, MB
Prominence <i>p. 77</i>	<b>A</b> 37321	—	—	—	—	—	—	—	—	—	26, G10, CZ, MB
Ravino <i>p. 78-80</i>	<b>A</b> 53012	<b>A</b> 22094	—	—	—	—	<b>A</b> 21935	<b>A</b> ★21936	<b>B</b> ★21937	<b>B</b> ★21938	26, G10, CZ, ORB, FB
Revolve <i>p. 81</i>	—	—	—	—	—	—	<b>B</b> 36851†	<b>B</b> 36852	<b>B</b> 36853	<b>C</b> 36854†	26, G10, CZ, FB
Rift <i>p. 82</i>	—	—	—	—	—	—	<b>B</b> 36898†	<b>B</b> ★36899	<b>B</b> ★36900	<b>C</b> ★36906†	26, G10, CZ, FB
Sheffield <i>p. 83</i>	—	—	—	—	—	—	<b>A</b> 37040	<b>B</b> ★37041	<b>B</b> ★37042	<b>B</b> ★37043	26, G10, CZ, ORB, MB
Socle <i>p. 84</i>	<b>A</b> 37023	—	—	—	—	—	—	—	—	—	26, G10, CZ, ORB, MB
Streamline II <i>p. 84-85</i>	—	—	<b>A</b> 37190	<b>B</b> 37191	<b>B</b> 37192	<b>B</b> 37193	<b>B</b> 37194	—	—	—	26, G10, CZ, MB
Streamline Tab <i>p. 86</i>	—	—	<b>A</b> 37200	<b>A</b> 37201	<b>B</b> 37202	<b>B</b> 37203	<b>B</b> 37204	—	—	—	26, G10, CZ, MB

	Knobs	Pulls										Appliance Pulls		Available Finishes <i>(See top of page)</i>
		76mm CTC	89mm CTC	96mm CTC	102mm CTC	128mm CTC	160mm CTC	192mm CTC	224mm CTC	256mm CTC	320mm CTC	12in CTC	18in CTC	
 Sunset <i>p. 87</i>	<b>B</b> 37295	—	—	—	—	—	—	—	—	—	—	—	—	26, G10, CZ, MB
 Torrance <i>p. 87</i>	<b>B</b> 37335	—	—	—	—	—	—	—	—	—	—	—	—	26, G10, CZ, MB
 Triomphe <i>p. 88</i>	—	<b>B</b> 37090	—	<b>B</b> 37091	—	<b>B</b> 37092	<b>B</b> 37093	—	—	—	—	—	—	26, G10, CZ, ORB, MB
 Vaile <i>p. 89-90</i>	<b>A</b> 53014	<b>A</b> 37230	—	<b>A</b> 53003	—	<b>B</b> ★ 37231	<b>B</b> ★ 37232	—	—	—	—	—	—	26, G10, CZ, ORB, FB
 Versa <i>p. 91-95</i>	<b>B</b> 53014	<b>B</b> 55530 <sup>†</sup>	—	<b>B</b> 36912	—	<b>B</b> 36913	<b>C</b> 36914	<b>C</b> 55531 <sup>†</sup>	<b>D</b> 36915	<b>D</b> 55532 <sup>†</sup>	<b>F</b> 55534 <sup>†</sup>	<b>J</b> 55533 <sup>†</sup>	<b>K</b> 55535 <sup>†</sup>	26, PN <sup>†</sup> , G10, BBZ <sup>†</sup> , CZ, FB
 Whistle <i>p. 96</i>	<b>A</b> 37026	—	—	—	—	—	—	—	—	—	—	—	—	26, G10, CZ, MB
 Willow <i>p. 96-97</i>	—	<b>A</b> 37309 <sup>†</sup>	—	<b>A</b> 37310	—	<b>B</b> 37311	<b>B</b> 37312	—	—	—	—	—	—	26, G10, CZ, MB
 Wire Pulls <i>p. 98</i>	—	<b>A</b> 865CS	<b>A</b> 867CS	<b>A</b> ★ 76313CS	<b>A</b> ★ 76312CS	—	—	—	—	—	—	—	—	26, 26D, G10, ORB, MB

Bar Pulls on next page →

### Looking for more options?

Scan here to view Amerock's entire breadth of collections.



# Collections

## QUICK REFERENCE



### BAR PULLS

Base Material: Stainless Steel  
p. 22-31

#### AVAILABLE FINISH

 Stainless Steel (SS)

Knobs	Pulls							
	76mm CTC	96mm CTC	128mm CTC	160mm CTC	192mm CTC	224mm CTC	256mm CTC	320mm CTC
<b>C</b>	<b>C</b>	<b>C</b>	<b>D</b>	<b>D</b>	<b>D</b>	<b>D</b>	<b>D</b>	<b>E</b>
19009	19010	19011	19541	40520 <sup>†</sup>	19012	40521 <sup>†</sup>	19013	19014



### BAR PULLS

Base Material: Carbon Steel  
p. 22-31

#### AVAILABLE FINISH

 Sterling Nickel (CSG9)







Knobs	Pulls							
	76mm CTC	96mm CTC	128mm CTC	160mm CTC	178mm CTC	192mm CTC	224mm CTC	256mm CTC
<b>B</b>	<b>B</b>	<b>B</b>	<b>B</b>	<b>C</b>	<b>C</b>	<b>C</b>	<b>C</b>	<b>C</b>
19009	19010	19011	19541	40520	1178	19012	40521	19013



### BAR PULLS

Base Material: Carbon Steel  
p. 22-31

#### AVAILABLE FINISHES

 Polished Chrome (26)    
  Champagne Bronze (CZ)    
  Gunmetal (GM)  
 Polished Nickel (PN)    
  Oil-Rubbed Bronze (ORB)    
  Black Bronze (BBR)  
 Golden Champagne (BBZ)

Knobs	Pulls							
	76mm CTC	96mm CTC	128mm CTC	160mm CTC	178mm CTC	192mm CTC	224mm CTC	256mm CTC
<b>B</b>	<b>C</b>	<b>C</b>	<b>C</b>	<b>C</b>	<b>D</b>	<b>D</b>	<b>D</b>	<b>D</b>
19009	40515	40516	40517	40520*	1178**	40518	40521	40519

\* 40520: Not available in GM. \*\* 1178: Not available in PN, BBZ or GM.

Example:  
**Amerock**  
**Part No.**



**BP36765BBZ**

Package Type Profile # Finish Code

**PRICE CODE BREAKDOWN • US Dollars**

<b>A</b>	\$5 or less	<b>E</b>	>\$20 to \$30	<b>I</b>	>\$75 to \$100
<b>B</b>	>\$5 to \$10	<b>F</b>	>\$30 to \$40	<b>J</b>	>\$100 to \$150
<b>C</b>	>\$10 to \$15	<b>G</b>	>\$40 to \$50	<b>K</b>	>\$150 to \$200
<b>D</b>	>\$15 to \$20	<b>H</b>	>\$50 to \$75	<b>L</b>	>\$200



† = Coming Soon

Pulls					Appliance Pulls		
416mm CTC	480mm CTC	544mm CTC	640mm CTC	768mm CTC	12in CTC	18in CTC	24in CTC
<b>E</b>	<b>F</b>	<b>F</b>	<b>G</b>	<b>G</b>	<b>J</b>	<b>K</b>	<b>L</b>
19015	19016	19017	19018	19019	54008	54025	54026

Pulls						Appliance Pulls		
320mm CTC	416mm CTC	480mm CTC	544mm CTC	640mm CTC	768mm CTC	12in CTC	18in CTC	24in CTC
<b>C</b>	<b>D</b>	<b>D</b>	<b>E</b>	<b>E</b>	<b>E</b>	<b>G</b>	<b>I</b>	<b>L</b>
19014	19015	19016	19017	19018	19019	54008	54025†	54026





Pulls						Appliance Pulls		
320mm CTC	416mm CTC	480mm CTC	544mm CTC	640mm CTC	768mm CTC	12in CTC	18in CTC	24in CTC
<b>D</b>	<b>E</b>	<b>E</b>	<b>F</b>	<b>F</b>	<b>G</b>	<b>J</b>	<b>K</b>	<b>L</b>
19014	19015†	19016	19017†	19018†	19019†	54008	54025	54026



# Angle

Shown on p. 16-17

## AVAILABLE FINISHES

-  Polished Chrome (26)
-  Champagne Bronze (CZ)
-  Satin Nickel (G10)
-  Matte Black (MB)

PRICE CODE BREAKDOWN • US Dollars			
<b>A</b>	\$5 or less	<b>G</b>	>\$40 to \$50
<b>B</b>	>\$5 to \$10	<b>H</b>	>\$50 to \$75
<b>C</b>	>\$10 to \$15	<b>I</b>	>\$75 to \$100
<b>D</b>	>\$15 to \$20	<b>J</b>	>\$100 to \$150
<b>E</b>	>\$20 to \$30	<b>K</b>	>\$150 to \$200
<b>F</b>	>\$30 to \$40	<b>L</b>	>\$200

## PULLS

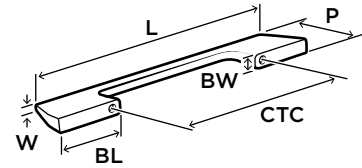

Part No.	Finish	Price Code	Shelf Pk Qty	Wt lbs	CTC in(mm)	L in(mm)	W in(mm)	P in(mm)	BL in(mm)	BW in(mm)	
<b>37299<sup>†</sup></b>	<b>BP3729926<sup>†</sup></b>	<b>1 Polished Chrome</b>	<b>B</b>	<b>10</b>	<b>0.22</b>	<b>3</b> (76)	<b>5</b> (127)	<b>3/16</b> (5)	<b>1-1/4</b> (32)	<b>1-1/4</b> (32)	<b>5/16</b> (8)
	BP37299G10 <sup>†</sup>	Satin Nickel									
	BP37299CZ <sup>†</sup>	Champagne Bronze									
	BP37299MB <sup>†</sup>	Matte Black									
<b>37300</b>	BP3730026	Polished Chrome	<b>B</b>	<b>10</b>	<b>0.26</b>	<b>3-3/4</b> (96)	<b>6-1/4</b> (159)	<b>3/16</b> (5)	<b>1-1/4</b> (32)	<b>1-3/8</b> (35)	<b>5/16</b> (8)
	<b>BP37300G10<sup>†</sup></b>	<b>2 Satin Nickel</b>									
	BP37300CZ	Champagne Bronze									
	BP37300MB	Matte Black									
<b>37301</b>	BP3730126	Polished Chrome	<b>B</b>	<b>10</b>	<b>0.32</b>	<b>5-1/16</b> (128)	<b>7-9/16</b> (192)	<b>3/16</b> (5)	<b>1-1/4</b> (32)	<b>1-3/4</b> (44)	<b>5/16</b> (8)
	BP37301G10	Satin Nickel									
	<b>BP37301CZ</b>	<b>3 Champagne Bronze</b>									
	BP37301MB	Matte Black									
<b>37304<sup>†</sup></b>	BP3730426 <sup>†</sup>	Polished Chrome	<b>B</b>	<b>10</b>	<b>0.34</b>	<b>6-5/16</b> (160)	<b>8-7/8</b> (225)	<b>5/16</b> (8)	<b>1-1/4</b> (32)	<b>1-3/4</b> (44)	<b>5/16</b> (8)
	BP37304G10 <sup>†</sup>	Satin Nickel									
	BP37304CZ <sup>†</sup>	Champagne Bronze									
	<b>BP37304MB<sup>†</sup></b>	<b>4 Matte Black</b>									

<sup>†</sup> Coming Soon • Base Material: Zinc

Hardware Included: Truss Head Machine Screw(s): #8-32 x 1in • #8-32 x 1-1/2in



LEGEND			
L	Length	BL	Base Length
W	Width	BW	Base Width
P	Projection	CTC	Center-to-Center

Shown on p. 16-17

# Angle



## AVAILABLE FINISHES

- Polished Chrome (26)
- Champagne Bronze (CZ)
- Satin Nickel (G10)
- Matte Black (MB)

## PULLS (cont'd)

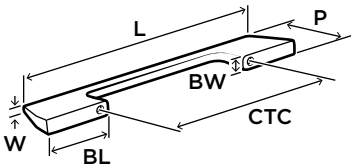

BW in(mm)	BL in(mm)	P in(mm)	W in(mm)	L in(mm)	CTC in(mm)	Wt lbs	Shelf Pk Qty	Price Code	Finish	Part No.
5/16 (8)	1-3/4 (44)	1-1/4 (32)	3/16 (5)	10-1/8 (257)	7-9/16 (192)	0.40	10	C	1 Polished Chrome	BP3730226
									2 Satin Nickel	BP37302G10
									Champagne Bronze	BP37302CZ
									Matte Black	BP37302MB
5/16 (8)	1-3/4 (44)	1-1/4 (32)	3/16 (5)	12-5/8 (321)	10-1/16 (256)	0.41	10	C	Polished Chrome	BP3730326
									Satin Nickel	BP37303G10
									3 Champagne Bronze	BP37303CZ
									4 Matte Black	BP37303MB

37302

37303

**Base Material:** Zinc

**Hardware Included:** Truss Head Machine Screw(s): #8-32 x 1in • #8-32 x 1-1/2in



## AVAILABLE FINISHES

-  Polished Chrome (26)
-  Champagne Bronze (CZ)
-  Satin Nickel (G10)
-  Oil-Rubbed Bronze (ORB)
-  Polished Brass (3)
-  Matte Black (MB)

PRICE CODE BREAKDOWN • US Dollars			
<b>A</b>	\$5 or less	<b>G</b>	>\$40 to \$50
<b>B</b>	>\$5 to \$10	<b>H</b>	>\$50 to \$75
<b>C</b>	>\$10 to \$15	<b>I</b>	>\$75 to \$100
<b>D</b>	>\$15 to \$20	<b>J</b>	>\$100 to \$150
<b>E</b>	>\$20 to \$30	<b>K</b>	>\$150 to \$200
<b>F</b>	>\$30 to \$40	<b>L</b>	>\$200

## PULLS

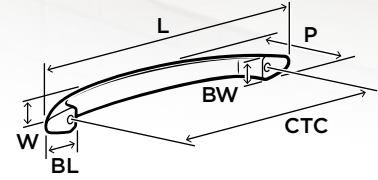

Part No.	Finish	Price Code	Shelf Pk Qty	Wt lbs	CTC in(mm)	L in(mm)	W in(mm)	P in(mm)	BL in(mm)	BW in(mm)
<b>3416</b>	<b>1</b> Polished Chrome	<b>A</b>	25							
	<b>2</b> Polished Brass									
<b>37355</b>	<b>4</b> Champagne Bronze	<b>A</b>	10	0.08	3 (76)	4-1/16 (103)	7/16 (11)	3/4 (19)	11/16 (17)	3/8 (10)
	BP37355ORB Oil-Rubbed Bronze									
	BP37355MB Matte Black									
<b>69153</b>	<b>3</b> Satin Nickel	<b>A</b>	25							
<b>37356</b>	BP3735626 Polished Chrome	<b>A</b>	10	0.09	3-3/4 (96)	4-15/16 (125)	7/16 (11)	7/8 (22)	11/16 (17)	7/16 (11)
	BP37356G10 Satin Nickel									
	BP37356CZ Champagne Bronze									
	<b>5</b> BP37356ORB Oil-Rubbed Bronze									
	<b>6</b> BP37356MB Matte Black									

Base Material: Zinc

Hardware Included: Truss Head Machine Screw(s): #8-32 x 1in • #8-32 x 1-1/2in

LEGEND			
L	Length	BL	Base Length
W	Width	BW	Base Width
P	Projection	CTC	Center-to-Center

Shown on p. 18-19

Arc



AVAILABLE FINISHES

- Polished Chrome (26)
- Champagne Bronze (CZ)
- Satin Nickel (G10)
- Oil-Rubbed Bronze (ORB)
- Matte Black (MB)

PULLS (cont'd)

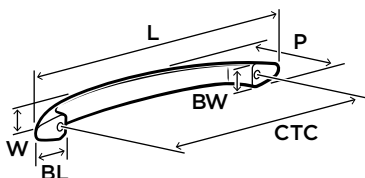

BW in(mm)	BL in(mm)	P in(mm)	W in(mm)	L in(mm)	CTC in(mm)	Wt lbs	Shelf Pk Qty	Price Code	Finish	Part No.
7/16 (11)	11/16 (17)	1 (25)	7/16 (11)	6-1/4 (159)	5-1/16 (128)	0.11	10	B	1 Polished Chrome	BP3735726
									2 Satin Nickel	BP37357G10
									Champagne Bronze	BP37357CZ
									Oil-Rubbed Bronze	BP37357ORB
									Matte Black	BP37357MB
7/16 (11)	7/8 (22)	1 (25)	1/2 (13)	7-13/16 (198)	6-5/16 (160)	0.13	10	B	Polished Chrome	BP6915826 <sup>†</sup>
									Satin Nickel	BP69158G10 <sup>†</sup>
									3 Champagne Bronze	BP69158CZ <sup>†</sup>
									4 Oil-Rubbed Bronze	BP69158ORB <sup>†</sup>
									5 Matte Black	BP69158MB <sup>†</sup>

★ 37357

★ 69158<sup>†</sup>





<sup>†</sup> Coming Soon • Base Material: Zinc  
 Hardware Included: Truss Head Machine Screw(s): #8-32 x 1in • #8-32 x 1-1/2in





# Arden

## AVAILABLE FINISHES

-  Polished Chrome (26)
-  Champagne Bronze (CZ)
-  Satin Nickel (G10)
-  Matte Black (MB)

PRICE CODE BREAKDOWN • US Dollars			
<b>A</b>	\$5 or less	<b>G</b>	>\$40 to \$50
<b>B</b>	>\$5 to \$10	<b>H</b>	>\$50 to \$75
<b>C</b>	>\$10 to \$15	<b>I</b>	>\$75 to \$100
<b>D</b>	>\$15 to \$20	<b>J</b>	>\$100 to \$150
<b>E</b>	>\$20 to \$30	<b>K</b>	>\$150 to \$200
<b>F</b>	>\$30 to \$40	<b>L</b>	>\$200

## KNOBS

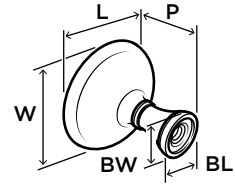
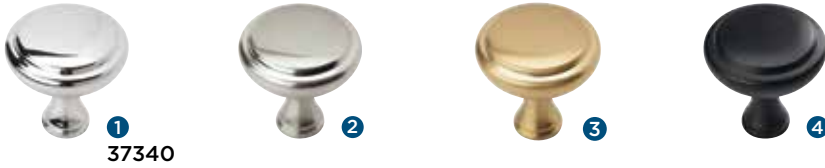

Part No.	Finish	Price Code	Shelf Pk Qty	Wt lbs	L in(mm)	W in(mm)	P in(mm)	BL in(mm)	BW in(mm)
BP3734026	① Polished Chrome	<b>B</b>	10	0.14	1-1/4 (32)	1-1/4 (32)	1-1/4 (32)	1/2 (13)	1/2 (13)
BP37340G10	② Satin Nickel								
BP37340CZ	③ Champagne Bronze								
BP37340MB	④ Matte Black								

37340

Base Material: Zinc

Hardware Included: Truss Head Machine Screw(s): #8-32 x 1in • #8-32 x 1-1/2in



# Augment

Shown on p. 20-21

## AVAILABLE FINISHES

-  Polished Chrome (26)
-  Satin Nickel (G10)
-  Champagne Bronze (CZ)
-  Matte Black (MB)

## PULLS

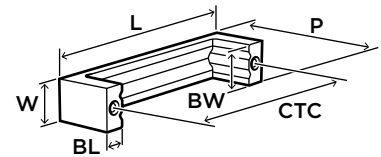
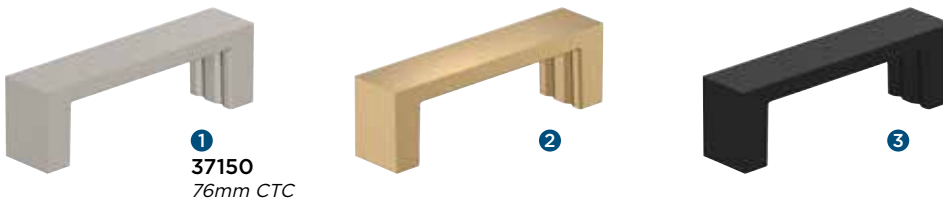

Part No.	Finish	Price Code	Shelf Pk Qty	Wt lbs	CTC in(mm)	L in(mm)	W in(mm)	P in(mm)	BL in(mm)	BW in(mm)
BP3715026	Polished Chrome	<b>A</b>	10	0.12	3 (76)	3-3/8 (86)	11/16 (17)	1 (25)	3/8 (10)	3/4 (19)
BP37150G10	① Satin Nickel									
BP37150CZ	② Champagne Bronze									
BP37150MB	③ Matte Black									

37150

Base Material: Zinc

Hardware Included: Truss Head Machine Screw(s): #8-32 x 1in • #8-32 x 1-1/2in

LEGEND			
L	Length	BL	Base Length
W	Width	BW	Base Width
P	Projection	CTC	Center-to-Center

Shown on p. 20-21

# Augment



## AVAILABLE FINISHES

Polished Chrome (26) Satin Nickel (G10) Champagne Bronze (CZ) Matte Black (MB)

## PULLS (cont'd)

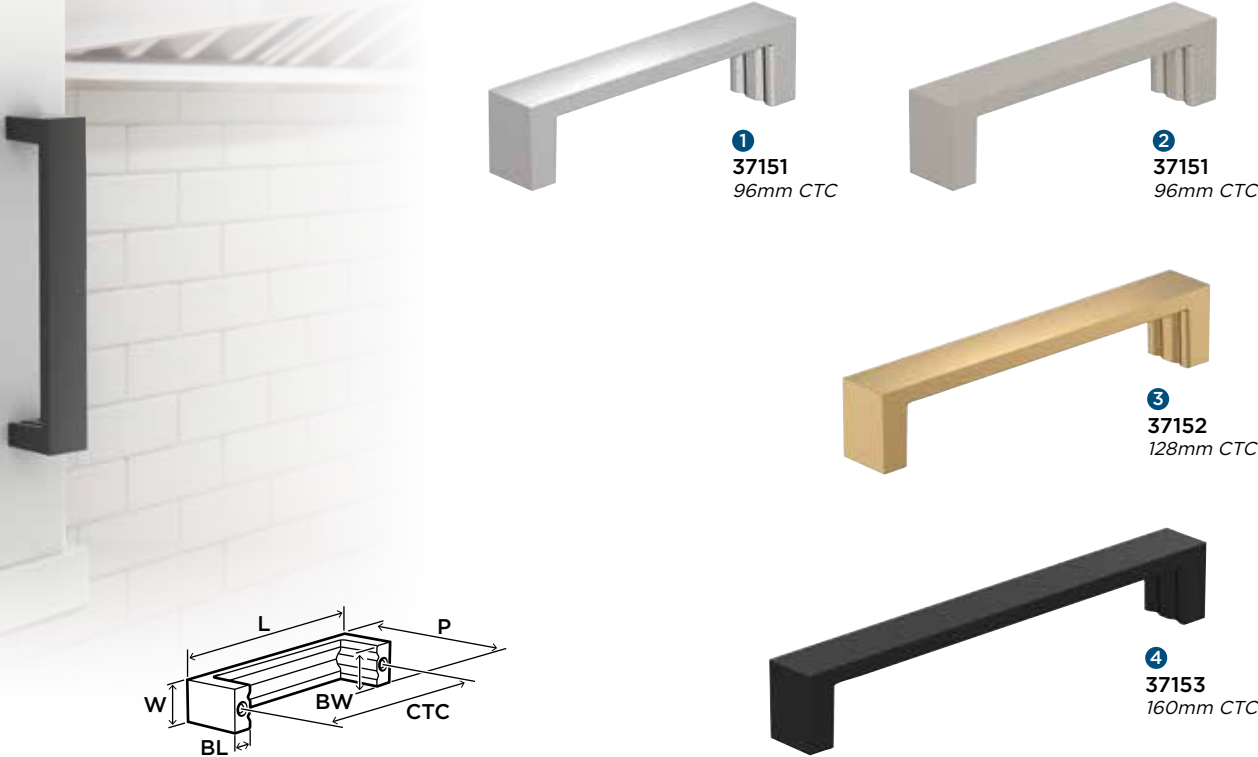

BW in(mm)	BL in(mm)	P in(mm)	W in(mm)	L in(mm)	CTC in(mm)	Wt lbs	Shelf Pk Qty	Price Code	Finish	Part No.
3/4 (19)	3/8 (10)	1 (25)	11/16 (17)	4-3/16 (106)	3-3/4 (96)	0.13	10	B	1 Polished Chrome	BP3715126
									2 Satin Nickel	BP37151G10
									Champagne Bronze	BP37151CZ
									Matte Black	BP37151MB
3/4 (19)	3/8 (10)	1 (25)	11/16 (17)	5-7/16 (138)	5-1/16 (128)	0.15	10	B	Polished Chrome	BP3715226
									Satin Nickel	BP37152G10
									3 Champagne Bronze	BP37152CZ
									Matte Black	BP37152MB
3/4 (19)	3/8 (10)	1 (25)	11/16 (17)	6-11/16 (170)	6-5/16 (160)	0.17	10	B	Polished Chrome	BP3715326
									Satin Nickel	BP37153G10
									Champagne Bronze	BP37153CZ
									4 Matte Black	BP37153MB

Base Material: Zinc

Hardware Included: Truss Head Machine Screw(s): #8-32 x 1in • #8-32 x 1-1/2in





# Bar Pulls

Shown on p. 22-31

## AVAILABLE FINISHES

- Polished Chrome (26)
- Stainless Steel (SS)
- Oil-Rubbed Bronze (ORB)
- Polished Nickel (PN)
- Golden Champagne (BBZ)
- Gunmetal (GM)
- Sterling Nickel (CSG9)
- Champagne Bronze (CZ)
- Black Bronze (BBR)

## PRICE CODE BREAKDOWN US Dollars

<b>A</b>	\$5 or less
<b>B</b>	>\$5 to \$10
<b>C</b>	>\$10 to \$15
<b>D</b>	>\$15 to \$20
<b>E</b>	>\$20 to \$30
<b>F</b>	>\$30 to \$40
<b>G</b>	>\$40 to \$50
<b>H</b>	>\$50 to \$75
<b>I</b>	>\$75 to \$100
<b>J</b>	>\$100 to \$150
<b>K</b>	>\$150 to \$200
<b>L</b>	>\$200

## KNOBS

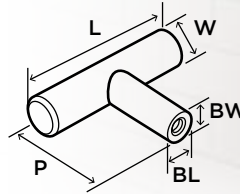

Part No.	Finish	Price Code	Shelf Pk Qty	Wt lbs	L in(mm)	W in(mm)	P in(mm)	BL in(mm)	BW in(mm)
BP1900926	1 Polished Chrome	B	10	0.12	1-15/16 (49)	1/2 (13)	1-3/8 (35)	3/8 (10)	3/8 (10)
BP19009PN	2 Polished Nickel								
BP19009CSG9	3 Sterling Nickel								
BP19009SS	4 Stainless Steel	C							
BP19009BBZ	5 Golden Champagne	B							
BP19009CZ	6 Champagne Bronze								
BP19009ORB	7 Oil-Rubbed Bronze								
BP19009GM	8 Gunmetal								
BP19009BBR	9 Black Bronze								

**Base Material:** Stainless Steel finish: Stainless Steel • **All other finishes:** Carbon Steel  
**Hardware Included:** Truss Head Machine Screw(s): #8-32 x 1in • #8-32 x 1-1/2in

LEGEND			
L	Length	BL	Base Length
W	Width	BW	Base Width
P	Projection	CTC	Center-to-Center

Shown on p. 22-31

# Bar Pulls



## AVAILABLE FINISHES

- |                        |  |                        |  |                         |  |
|------------------------|--|------------------------|--|-------------------------|--|
| Polished Chrome (26)   |  | Stainless Steel (SS)   |  | Oil-Rubbed Bronze (ORB) |  |
| Polished Nickel (PN)   |  | Golden Champagne (BBZ) |  | Gunmetal (GM)           |  |
| Sterling Nickel (CSG9) |  | Champagne Bronze (CZ)  |  | Black Bronze (BBR)      |  |

## PULLS

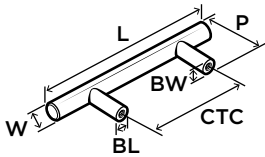

BW in(mm)	BL in(mm)	P in(mm)	W in(mm)	L in(mm)	CTC in(mm)	Wt lbs	Shelf Pk Qty	Price Code	Finish	Part No.	
3/8 (10)	3/8 (10)	1-3/8 (35)	1/2 (13)	5-3/8 (137)	3 (76)	0.32	10	B	Sterling Nickel	BP19010CSG9	19010
									1 Stainless Steel	BP19010SS	
								C	Polished Chrome	BP4051526	40515
									Polished Nickel	BP40515PN	
									2 Golden Champagne	BP40515BBZ	
									Champagne Bronze	BP40515CZ	
									Oil-Rubbed Bronze	BP40515ORB	
									Gunmetal	BP40515GM	
									Black Bronze	BP40515BBR	
									3/8 (10)	3/8 (10)	
Stainless Steel	BP19011SS										
C	Polished Chrome	BP4051626	40516								
	Polished Nickel	BP40516PN									
	Golden Champagne	BP40516BBZ									
	Champagne Bronze	BP40516CZ									
	Oil-Rubbed Bronze	BP40516ORB									
	Gunmetal	BP40516GM									
	4 Black Bronze	BP40516BBR									

**Base Material:** Stainless Steel **finish:** Stainless Steel • **All other finishes:** Carbon Steel  
**Hardware Included:** Truss Head Machine Screw(s): #8-32 x 1in • #8-32 x 1-1/2in



# Bar Pulls

Shown on p. 22-31

### PRICE CODE BREAKDOWN US Dollars

<b>A</b>	\$5 or less
<b>B</b>	>\$5 to \$10
<b>C</b>	>\$10 to \$15
<b>D</b>	>\$15 to \$20
<b>E</b>	>\$20 to \$30
<b>F</b>	>\$30 to \$40
<b>G</b>	>\$40 to \$50
<b>H</b>	>\$50 to \$75
<b>I</b>	>\$75 to \$100
<b>J</b>	>\$100 to \$150
<b>K</b>	>\$150 to \$200
<b>L</b>	>\$200

## AVAILABLE FINISHES

- Polished Chrome (26)
- Stainless Steel (SS)
- Oil-Rubbed Bronze (ORB)
- Polished Nickel (PN)
- Golden Champagne (BBZ)
- Gunmetal (GM)
- Sterling Nickel (CSG9)
- Champagne Bronze (CZ)
- Black Bronze (BBR)

## PULLS (cont'd)



**1**  
19541  
128mm CTC



**2**  
40517  
128mm CTC



**3**  
40520  
160mm CTC



**4**  
40520  
160mm CTC

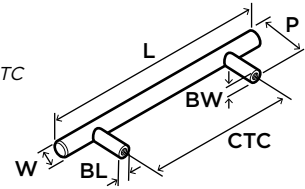

Part No.	Finish	Price Code	Shelf Pk Qty	Wt lbs	CTC in(mm)	L in(mm)	W in(mm)	P in(mm)	BL in(mm)	BW in(mm)
<b>19541</b>	BP19541CSG9	<b>1</b> Sterling Nickel	10	0.42	5-1/16 (128)	7-3/8 (187)	1/2 (13)	1-3/8 (35)	3/8 (10)	3/8 (10)
	BP19541SS	Stainless Steel								
<b>40517</b>	BP4051726	Polished Chrome	10	0.42	5-1/16 (128)	7-3/8 (187)	1/2 (13)	1-3/8 (35)	3/8 (10)	3/8 (10)
	BP40517PN	<b>2</b> Polished Nickel								
	BP40517BBZ	Golden Champagne								
	BP40517CZ	Champagne Bronze								
	BP40517ORB	Oil-Rubbed Bronze								
	BP40517GM	Gunmetal								
BP40517BBR	Black Bronze									
<b>40520</b>	BP4052026	Polished Chrome	10	0.49	6-5/16 (160)	8-5/8 (219)	1/2 (13)	1-3/8 (35)	3/8 (10)	3/8 (10)
	BP40520PN <sup>†</sup>	Polished Nickel								
	BP40520CSG9	Sterling Nickel								
	BP40520SS <sup>†</sup>	Stainless Steel								
	BP40520BBZ <sup>†</sup>	Golden Champagne								
	BP40520CZ	<b>3</b> Champagne Bronze								
BP40520ORB	<b>4</b> Oil-Rubbed Bronze									
BP40520BBR	Black Bronze									

<sup>†</sup> Coming Soon • Base Material: Stainless Steel finish: Stainless Steel • All other finishes: Carbon Steel  
 Hardware Included: Truss Head Machine Screw(s): #8-32 x 1in • #8-32 x 1-1/2in



LEGEND			
L	Length	BL	Base Length
W	Width	BW	Base Width
P	Projection	CTC	Center-to-Center

Shown on p. 22-31

# Bar Pulls



## AVAILABLE FINISHES

- |                        |  |                        |  |                         |  |
|------------------------|--|------------------------|--|-------------------------|--|
| Polished Chrome (26)   |  | Stainless Steel (SS)   |  | Oil-Rubbed Bronze (ORB) |  |
| Polished Nickel (PN)   |  | Golden Champagne (BBZ) |  | Gunmetal (GM)           |  |
| Sterling Nickel (CSG9) |  | Champagne Bronze (CZ)  |  | Black Bronze (BBR)      |  |

## PULLS (cont'd)



1  
**1178**  
178mm CTC



2  
**19012**  
192mm CTC

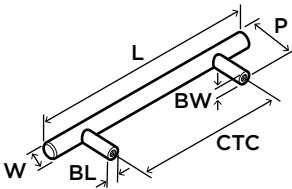

3  
**40518**  
192mm CTC

BW in(mm)	BL in(mm)	P in(mm)	W in(mm)	L in(mm)	CTC in(mm)	Wt lbs	Shelf Pk Qty	Price Code	Finish	Part No.	
3/8 (10)	3/8 (10)	1-3/8 (35)	1/2 (13)	9-3/8 (238)	7 (178)	0.53	10	D	1 Polished Chrome	BP117826	1178
								C	Sterling Nickel	BP1178CSG9	
								D	Champagne Bronze	BP1178CZ	
								D	Oil-Rubbed Bronze	BP1178ORB	
								D	Black Bronze	BP1178BBR	
3/8 (10)	3/8 (10)	1-3/8 (35)	1/2 (13)	9-15/16 (252)	7-9/16 (192)	0.55	10	C	Sterling Nickel	BP19012CSG9	19012
								C	2 Stainless Steel	BP19012SS	
								D	Polished Chrome	BP4051826	40518
									Polished Nickel	BP40518PN	
									Golden Champagne	BP40518BBZ	
									Champagne Bronze	BP40518CZ	
									Oil-Rubbed Bronze	BP40518ORB	
									Gunmetal	BP40518GM	
									3 Black Bronze	BP40518BBR	

Base Material: Stainless Steel finish: Stainless Steel • All other finishes: Carbon Steel

Hardware Included: Truss Head Machine Screw(s): #8-32 x 1in • #8-32 x 1-1/2in



# Bar Pulls

Shown on p. 22-31

## AVAILABLE FINISHES

- Polished Chrome (26)
- Stainless Steel (SS)
- Oil-Rubbed Bronze (ORB)
- Polished Nickel (PN)
- Golden Champagne (BBZ)
- Gunmetal (GM)
- Sterling Nickel (CSG9)
- Champagne Bronze (CZ)
- Black Bronze (BBR)

## PRICE CODE BREAKDOWN US Dollars

<b>A</b>	\$5 or less
<b>B</b>	>\$5 to \$10
<b>C</b>	>\$10 to \$15
<b>D</b>	>\$15 to \$20
<b>E</b>	>\$20 to \$30
<b>F</b>	>\$30 to \$40
<b>G</b>	>\$40 to \$50
<b>H</b>	>\$50 to \$75
<b>I</b>	>\$75 to \$100
<b>J</b>	>\$100 to \$150
<b>K</b>	>\$150 to \$200
<b>L</b>	>\$200

## PULLS (cont'd)

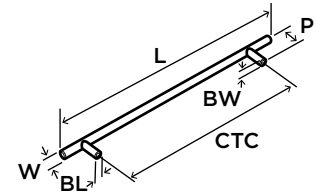

Part No.	Finish	Price Code	Shelf Pk Qty	Wt lbs	CTC in(mm)	L in(mm)	W in(mm)	P in(mm)	BL in(mm)	BW in(mm)
<b>40521</b>	<b>BP4052126</b> ① Polished Chrome	<b>D</b>	10	0.62	8-13/16 (224)	11-3/16 (284)	1/2 (13)	1-3/8 (35)	3/8 (10)	3/8 (10)
	BP40521PN† Polished Nickel									
	BP40521CSG9 Sterling Nickel	<b>C</b>								
	BP40521SS† Stainless Steel	<b>D</b>								
	BP40521BBZ† Golden Champagne									
	BP40521CZ Champagne Bronze									
	BP40521ORB Oil-Rubbed Bronze									
	BP40521BBR Black Bronze									
<b>19013</b>	BP19013CSG9 Sterling Nickel	<b>C</b>	10	0.70	10-1/16 (256)	13-1/4 (337)	1/2 (13)	1-3/8 (35)	3/8 (10)	3/8 (10)
	BP19013SS Stainless Steel									
<b>40519</b>	BP4051926 Polished Chrome	<b>D</b>	10	0.70	10-1/16 (256)	13-1/4 (337)	1/2 (13)	1-3/8 (35)	3/8 (10)	3/8 (10)
	BP40519PN Polished Nickel									
	<b>BP40519BBZ</b> ② Golden Champagne									
	BP40519CZ Champagne Bronze									
	BP40519ORB Oil-Rubbed Bronze									
	BP40519GM Gunmetal									
BP40519BBR Black Bronze										

† Coming Soon • Base Material: Stainless Steel finish: Stainless Steel • All other finishes: Carbon Steel  
 Hardware Included: Truss Head Machine Screw(s): #8-32 x 1in • #8-32 x 1-1/2in

LEGEND			
L	Length	BL	Base Length
W	Width	BW	Base Width
P	Projection	CTC	Center-to-Center

Shown on p. 22-31

# Bar Pulls



## AVAILABLE FINISHES

- |                        |                        |                         |
|------------------------|------------------------|-------------------------|
| Polished Chrome (26)   | Stainless Steel (SS)   | Oil-Rubbed Bronze (ORB) |
| Polished Nickel (PN)   | Golden Champagne (BBZ) | Gunmetal (GM)           |
| Sterling Nickel (CSG9) | Champagne Bronze (CZ)  | Black Bronze (BBR)      |

## PULLS (cont'd)

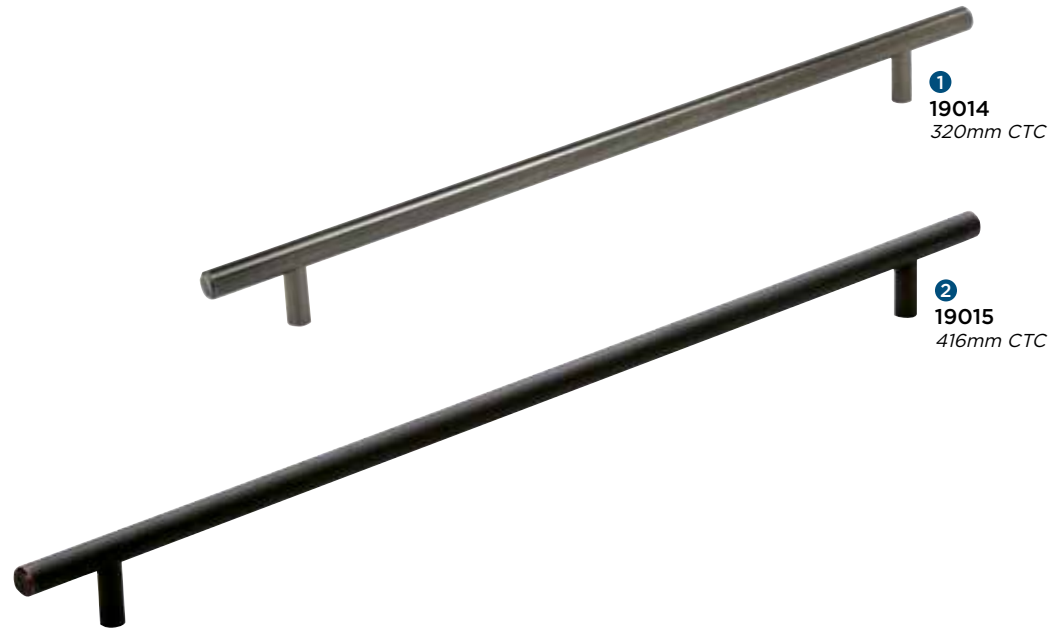
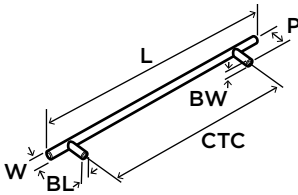

BW in(mm)	BL in(mm)	P in(mm)	W in(mm)	L in(mm)	CTC in(mm)	Wt lbs	Shelf Pk Qty	Price Code	Finish	Part No.
3/8 (10)	3/8 (10)	1-3/8 (35)	1/2 (13)	15-3/4 (400)	12-5/8 (320)	0.83	10	D	Polished Chrome	BP1901426
									Polished Nickel	BP19014PN
									Sterling Nickel	BP19014CSG9
									Stainless Steel	BP19014SS
									Golden Champagne	BP19014BBZ
									Champagne Bronze	BP19014CZ
									Oil-Rubbed Bronze	BP19014ORB
									1 Gunmetal	BP19014GM
									Black Bronze	BP19014BBR
									3/8 (10)	3/8 (10)
Polished Nickel	BP19015PN+									
Sterling Nickel	BP19015CSG9									
Stainless Steel	BP19015SS									
Golden Champagne	BP19015BBZ+									
Champagne Bronze	BP19015CZ+									
2 Oil-Rubbed Bronze	BP19015ORB									
Black Bronze	BP19015BBR+									

† **Coming Soon** • **Base Material:** Stainless Steel **finish:** Stainless Steel • **All other finishes:** Carbon Steel

**Hardware Included:** Truss Head Machine Screw(s): #8-32 x 1in • #8-32 x 1-1/2in



# Bar Pulls

Shown on p. 22-31

## AVAILABLE FINISHES

- Polished Chrome (26)
- Stainless Steel (SS)
- Oil-Rubbed Bronze (ORB)
- Polished Nickel (PN)
- Golden Champagne (BBZ)
- Gunmetal (GM)
- Sterling Nickel (CSG9)
- Champagne Bronze (CZ)
- Black Bronze (BBR)

## PRICE CODE BREAKDOWN US Dollars

<b>A</b>	\$5 or less
<b>B</b>	>\$5 to \$10
<b>C</b>	>\$10 to \$15
<b>D</b>	>\$15 to \$20
<b>E</b>	>\$20 to \$30
<b>F</b>	>\$30 to \$40
<b>G</b>	>\$40 to \$50
<b>H</b>	>\$50 to \$75
<b>I</b>	>\$75 to \$100
<b>J</b>	>\$100 to \$150
<b>K</b>	>\$150 to \$200
<b>L</b>	>\$200

## PULLS (cont'd)

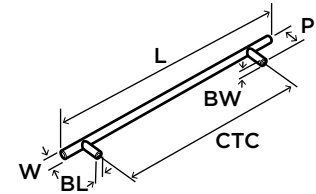
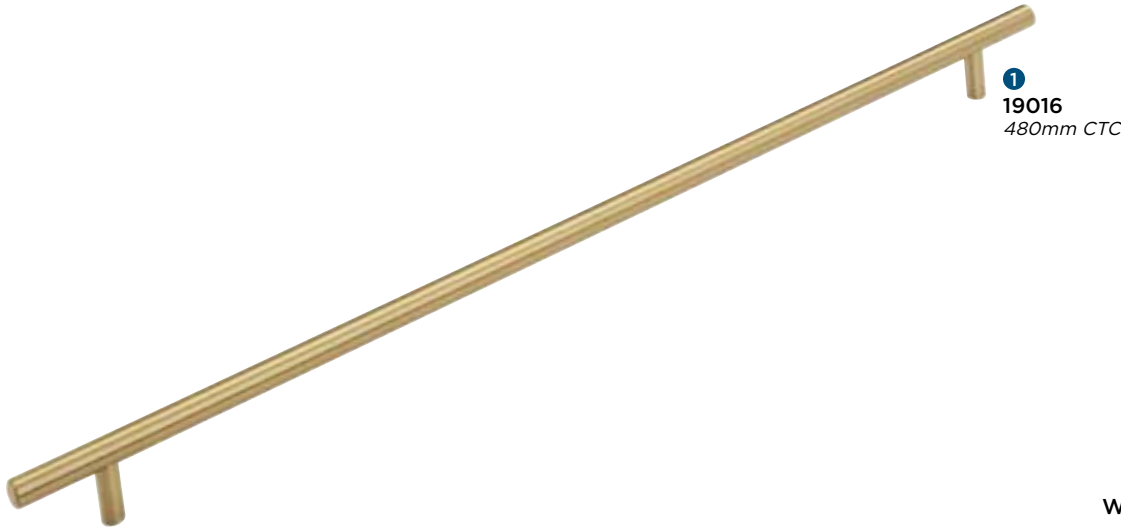

Part No.	Finish	Price Code	Shelf Pk Qty	Wt lbs	CTC in(mm)	L in(mm)	W in(mm)	P in(mm)	BL in(mm)	BW in(mm)	
<b>19016</b>	BP1901626	Polished Chrome	10	1.10	18-7/8 (480)	22-1/16 (560)	1/2 (13)	1-3/8 (35)	3/8 (10)	3/8 (10)	
	BP19016PN	Polished Nickel									<b>E</b>
	BP19016CSG9	Sterling Nickel									<b>D</b>
	BP19016SS	Stainless Steel									<b>F</b>
	BP19016BBZ	Golden Champagne									
	<b>BP19016CZ</b>	<b>1 Champagne Bronze</b>									
	BP19016ORB	Oil-Rubbed Bronze									<b>E</b>
	BP19016GM	Gunmetal									
	BP19016BBR	Black Bronze									
<b>19017</b>	BP1901726 <sup>†</sup>	Polished Chrome	10	1.30	21-7/16 (544)	24-9/16 (624)	1/2 (13)	1-3/8 (35)	3/8 (10)	3/8 (10)	
	BP19017PN <sup>†</sup>	Polished Nickel									<b>F</b>
	BP19017CSG9	Sterling Nickel									<b>E</b>
	BP19017SS	Stainless Steel									
	BP19017BBZ <sup>†</sup>	Golden Champagne									
	BP19017CZ <sup>†</sup>	Champagne Bronze									<b>F</b>
	BP19017ORB	Oil-Rubbed Bronze									
	BP19017BBR <sup>†</sup>	Black Bronze									

<sup>†</sup> Coming Soon • Base Material: Stainless Steel finish: Stainless Steel • All other finishes: Carbon Steel  
 Hardware Included: Truss Head Machine Screw(s): #8-32 x 1in • #8-32 x 1-1/2in

LEGEND			
L	Length	BL	Base Length
W	Width	BW	Base Width
P	Projection	CTC	Center-to-Center

Shown on p. 22-31

# Bar Pulls



## AVAILABLE FINISHES

- Polished Chrome (26)
- Sterling Nickel (CSG9)
- Champagne Bronze (CZ)
- Polished Nickel (PN)
- Stainless Steel (SS)
- Oil-Rubbed Bronze (ORB)
- Golden Champagne (BBZ)
- Black Bronze (BBR)

## PULLS (cont'd)

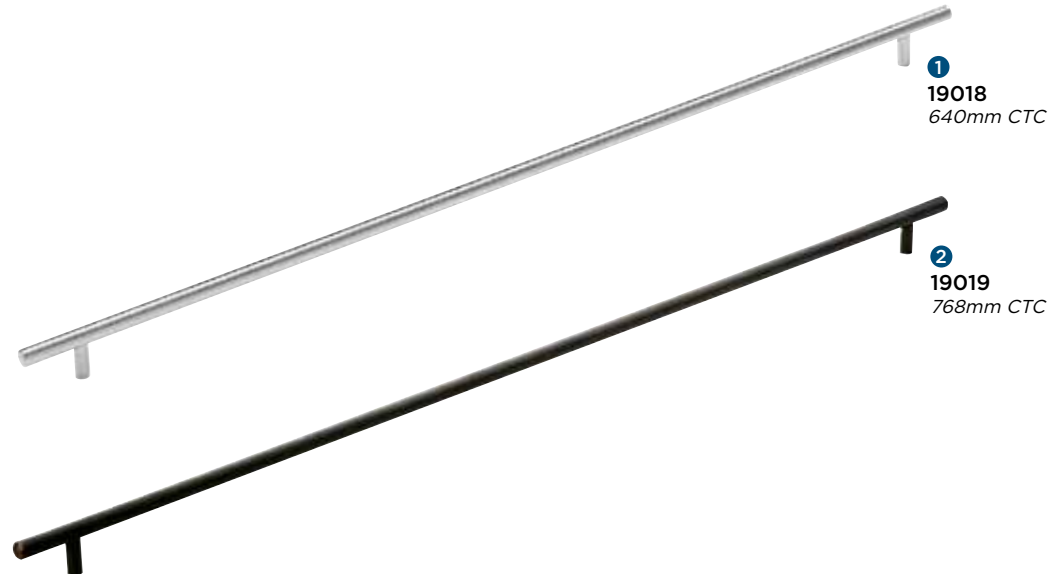
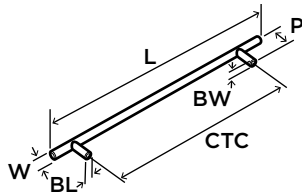

BW in(mm)	BL in(mm)	P in(mm)	W in(mm)	L in(mm)	CTC in(mm)	Wt lbs	Shelf Pk Qty	Price Code	Finish	Part No.
3/8 (10)	3/8 (10)	1-3/8 (35)	1/2 (13)	28-5/16 (719)	25-3/16 (640)	1.40	10	F	Polished Chrome	BP1901826 <sup>†</sup>
								E	Polished Nickel	BP19018PN <sup>†</sup>
								G	1 Stainless Steel	BP19018CSG9
								F	Golden Champagne	BP19018BBZ <sup>†</sup>
									Champagne Bronze	BP19018CZ <sup>†</sup>
									Oil-Rubbed Bronze	BP19018ORB
									Black Bronze	BP19018BBR <sup>†</sup>
3/8 (10)	3/8 (10)	1-3/8 (35)	1/2 (13)	33-7/16 (849)	30-1/4 (768)	1.54	10	G	Polished Chrome	BP1901926 <sup>†</sup>
								E	Polished Nickel	BP19019PN <sup>†</sup>
								G	Sterling Nickel	BP19019CSG9
									Stainless Steel	BP19019SS
									Golden Champagne	BP19019BBZ <sup>†</sup>
									Champagne Bronze	BP19019CZ <sup>†</sup>
									2 Oil-Rubbed Bronze	BP19019ORB
Black Bronze	BP19019BBR <sup>†</sup>									

19018

19019

<sup>†</sup> Coming Soon • Base Material: Stainless Steel finish: Stainless Steel • All other finishes: Carbon Steel

Hardware Included: Truss Head Machine Screw(s): #8-32 x 1in • #8-32 x 1-1/2in



# Bar Pulls

Shown on p. 22-31

## AVAILABLE FINISHES

- Polished Chrome (26)
- Stainless Steel (SS)
- Oil-Rubbed Bronze (ORB)
- Polished Nickel (PN)
- Golden Champagne (BBZ)
- Gunmetal (GM)
- Sterling Nickel (CSG9)
- Champagne Bronze (CZ)
- Black Bronze (BBR)

## APPLIANCE PULLS

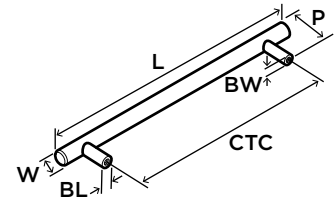

### PRICE CODE BREAKDOWN US Dollars

<b>A</b>	\$5 or less
<b>B</b>	>\$5 to \$10
<b>C</b>	>\$10 to \$15
<b>D</b>	>\$15 to \$20
<b>E</b>	>\$20 to \$30
<b>F</b>	>\$30 to \$40
<b>G</b>	>\$40 to \$50
<b>H</b>	>\$50 to \$75
<b>I</b>	>\$75 to \$100
<b>J</b>	>\$100 to \$150
<b>K</b>	>\$150 to \$200
<b>L</b>	>\$200

Part No.	Finish	Price Code	Shelf Pk Qty	Wt lbs	CTC in(mm)	L in(mm)	W in(mm)	P in(mm)	BL in(mm)	BW in(mm)
BP5400826	Polished Chrome	<b>J</b>	1	2.23	12 (305)	14-5/8 (371)	3/4 (19)	2 (51)	5/8 (16)	5/8 (16)
BP54008PN	Polished Nickel									
BP54008CSG9	Sterling Nickel									
<b>BP54008SS</b>	<b>1 Stainless Steel</b>									
BP54008BBZ	Golden Champagne									
BP54008CZ	Champagne Bronze									
BP54008ORB	Oil-Rubbed Bronze									
BP54008GM	Gunmetal									
BP54008BBR	Black Bronze									
BP5402526	Polished Chrome	<b>K</b>	1	2.96	18 (457)	20-5/8 (524)	3/4 (19)	2 (51)	5/8 (16)	5/8 (16)
BP54025PN	Polished Nickel									
BP54025CSG9†	Sterling Nickel									
BP54025SS	Stainless Steel									
BP54025BBZ	Golden Champagne									
<b>BP54025CZ</b>	<b>2 Champagne Bronze</b>									
BP54025ORB	Oil-Rubbed Bronze									
BP54025BBR	Black Bronze									

† **Coming Soon** • **Base Material:** Stainless Steel **finish:** Stainless Steel • **All other finishes:** Carbon Steel  
**Hardware Included:** Washers & Truss Head Machine Screw(s):  
 #10-24 x 3/4in • #10-24 x 1in • #10-24 x 1-1/4in • #10-24 x 1-1/2in • #10-24 x 1-3/4in • #10-24 x 2-1/8in

LEGEND			
L	Length	BL	Base Length
W	Width	BW	Base Width
P	Projection	CTC	Center-to-Center

Shown on p. 22-31

# Bar Pulls



## AVAILABLE FINISHES

- |                        |  |                        |  |                         |  |
|------------------------|--|------------------------|--|-------------------------|--|
| Polished Chrome (26)   |  | Stainless Steel (SS)   |  | Oil-Rubbed Bronze (ORB) |  |
| Polished Nickel (PN)   |  | Golden Champagne (BBZ) |  | Gunmetal (GM)           |  |
| Sterling Nickel (CSG9) |  | Champagne Bronze (CZ)  |  | Black Bronze (BBR)      |  |

## APPLIANCE PULLS (cont'd)

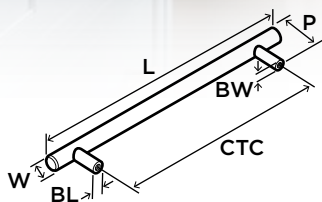

BW in(mm)	BL in(mm)	P in(mm)	W in(mm)	L in(mm)	CTC in(mm)	Wt lbs	Shelf Pk Qty	Price Code	Finish	Part No.
5/8 (16)	5/8 (16)	2 (51)	3/4 (19)	26-5/8 (676)	24 (610)	3.69	1	L	Polished Chrome	BP5402626
									Polished Nickel	BP54026PN
									Sterling Nickel	BP54026CSG9
									Stainless Steel	BP54026SS
									① Golden Champagne	BP54026BBZ
									Champagne Bronze	BP54026CZ
									Gunmetal	BP54026GM
									② Oil-Rubbed Bronze	BP54026ORB
									③ Black Bronze	BP54026BBR

54026

**Base Material:** Carbon Steel

**Hardware Included:** Washers & Truss Head Machine Screw(s):

#10-24 x 3/4in • #10-24 x 1in • #10-24 x 1-1/4in • #10-24 x 1-1/2in • #10-24 x 1-3/4in • #10-24 x 2-1/8in



# Bar Pulls Hollow

Shown on p. 32-33

## AVAILABLE FINISHES

- Polished Chrome (26)
- Stainless Steel (SS)
- Matte Black (MB)

## PRICE CODE BREAKDOWN • US Dollars

<b>A</b>	\$5 or less	<b>G</b>	>\$40 to \$50
<b>B</b>	>\$5 to \$10	<b>H</b>	>\$50 to \$75
<b>C</b>	>\$10 to \$15	<b>I</b>	>\$75 to \$100
<b>D</b>	>\$15 to \$20	<b>J</b>	>\$100 to \$150
<b>E</b>	>\$20 to \$30	<b>K</b>	>\$150 to \$200
<b>F</b>	>\$30 to \$40	<b>L</b>	>\$200

## KNOBS

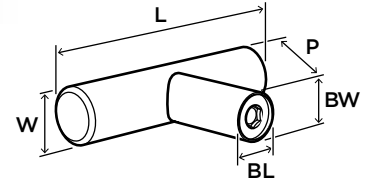

Part No.	Finish	Price Code	Shelf Pk Qty	Wt lbs	L in(mm)	W in(mm)	P in(mm)	BL in(mm)	BW in(mm)
<b>37029</b> BP3702926	① Polished Chrome	<b>A</b>	10	0.05	2 (51)	7/16 (11)	1-1/4 (32)	3/8 (10)	3/8 (10)
	② Stainless Steel								
	③ Matte Black								

Base Material: Zinc

Hardware Included: Truss Head Machine Screw(s): #8-32 x 1in • #8-32 x 1-1/2in

## PULLS

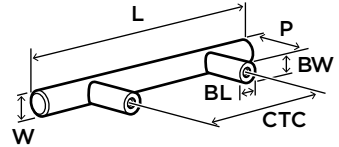

Part No.	Finish	Price Code	Shelf Pk Qty	Wt lbs	CTC in(mm)	L in(mm)	W in(mm)	P in(mm)	BL in(mm)	BW in(mm)	
<b>37240</b> BP3724026	Polished Chrome	<b>A</b>	10	0.11	3 (76)	5-5/16 (135)	7/16 (11)	1-3/8 (35)	3/8 (10)	3/8 (10)	
	BP37240SS										Stainless Steel
	BP37240MB										Matte Black
<b>37241</b> BP3724126	① Polished Chrome	<b>A</b>	10	0.11	3-3/4 (96)	6-1/8 (156)	7/16 (11)	1-3/8 (35)	3/8 (10)	3/8 (10)	
	BP37241SS										Stainless Steel
	BP37241MB										Matte Black
<b>37242</b> BP3724226	Polished Chrome	<b>A</b>	10	0.12	5-1/16 (128)	7-3/8 (187)	7/16 (11)	1-3/8 (35)	3/8 (10)	3/8 (10)	
	BP37242SS										Stainless Steel
	BP37242MB										② Matte Black

Base Material: Stainless Steel

Hardware Included: Truss Head Machine Screw(s): #8-32 x 1in • #8-32 x 1-1/2in



LEGEND			
L	Length	BL	Base Length
W	Width	BW	Base Width
P	Projection	CTC	Center-to-Center

Shown on p. 32-33

# Bar Pulls Hollow



## AVAILABLE FINISHES

Polished Chrome (26)



Stainless Steel (SS)



Matte Black (MB)



## PULLS (cont'd)

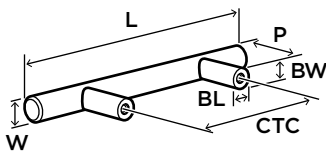

BW in(mm)	BL in(mm)	P in(mm)	W in(mm)	L in(mm)	CTC in(mm)	Wt lbs	Shelf Pk Qty	Price Code	Finish	Part No.
3/8 (10)	3/8 (10)	1-3/8 (35)	7/16 (11)	8-5/8 (219)	6-5/16 (160)	0.13	10	A	1 Polished Chrome	BP3724326
									Stainless Steel	BP37243SS
									Matte Black	BP37243MB
3/8 (10)	3/8 (10)	1-3/8 (35)	7/16 (11)	9-15/16 (252)	7-9/16 (192)	0.14	10	A	Polished Chrome	BP3724426
									2 Stainless Steel	BP37244SS
									Matte Black	BP37244MB
3/8 (10)	3/8 (10)	1-3/8 (35)	7/16 (11)	11-3/16 (284)	8-13/16 (224)	0.16	10	B	Polished Chrome	BP3724526
									Stainless Steel	BP37245SS
									Matte Black	BP37245MB
3/8 (10)	3/8 (10)	1-3/8 (35)	7/16 (11)	12-7/16 (316)	10-1/16 (256)	0.17	10	B	Polished Chrome	BP3724626
									Stainless Steel	BP37246SS
									3 Matte Black	BP37246MB
3/8 (10)	3/8 (10)	1-3/8 (35)	7/16 (11)	13-11/16 (348)	11-5/16 (288)	0.18	10	B	Polished Chrome	BP3724726
									Stainless Steel	BP37247SS
									Matte Black	BP37247MB





Base Material: Stainless Steel

Hardware Included: Truss Head Machine Screw(s): #8-32 x 1in • #8-32 x 1-1/2in



# Bar Pulls Square

## AVAILABLE FINISHES

-  Polished Chrome (26)
-  Champagne Bronze (CZ)
-  Satin Nickel (G10)
-  Matte Black (MB)

PRICE CODE BREAKDOWN • US Dollars			
<b>A</b>	\$5 or less	<b>G</b>	>\$40 to \$50
<b>B</b>	>\$5 to \$10	<b>H</b>	>\$50 to \$75
<b>C</b>	>\$10 to \$15	<b>I</b>	>\$75 to \$100
<b>D</b>	>\$15 to \$20	<b>J</b>	>\$100 to \$150
<b>E</b>	>\$20 to \$30	<b>K</b>	>\$150 to \$200
<b>F</b>	>\$30 to \$40	<b>L</b>	>\$200

## PULLS

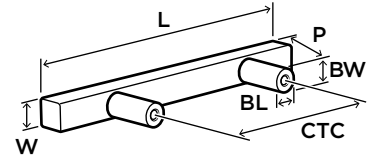

Part No.	Finish	Price Code	Shelf Pk Qty	Wt lbs	CTC in(mm)	L in(mm)	W in(mm)	P in(mm)	BL in(mm)	BW in(mm)	
<b>37175</b>	<b>1</b> Polished Chrome	<b>A</b>	10	0.16	3 (76)	5-5/16 (135)	7/16 (11)	1-3/8 (35)	3/8 (10)	3/8 (10)	
	BP37175G10										Satin Nickel
	BP37175CZ										Champagne Bronze
	BP37175MB										Matte Black
<b>37176</b>	Polished Chrome	<b>B</b>	10	0.18	3-3/4 (96)	6-1/16 (154)	7/16 (11)	1-3/8 (35)	3/8 (10)	3/8 (10)	
	BP37176G10										Satin Nickel
	<b>2</b> Champagne Bronze										Champagne Bronze (CZ)
	BP37176MB										Matte Black
<b>37177</b>	Polished Chrome	<b>B</b>	10	0.21	5-1/16 (128)	7-3/8 (187)	7/16 (11)	1-3/8 (35)	3/8 (10)	3/8 (10)	
	BP37177G10										Satin Nickel
	BP37177CZ										Champagne Bronze
	<b>3</b> Matte Black										Matte Black (MB)
<b>37178</b>	Polished Chrome	<b>B</b>	10	0.24	6-5/16 (160)	8-5/8 (219)	7/16 (11)	1-3/8 (35)	3/8 (10)	3/8 (10)	
	<b>4</b> Satin Nickel										Satin Nickel (G10)
	BP37178CZ										Champagne Bronze
	BP37178MB										Matte Black

Base Material: Zinc

Hardware Included: Truss Head Machine Screw(s): #8-32 x 1in • #8-32 x 1-1/2in

LEGEND			
L	Length	BL	Base Length
W	Width	BW	Base Width
P	Projection	CTC	Center-to-Center



## AVAILABLE FINISHES

Polished Chrome (26) 

Satin Nickel (G10) 

Oil-Rubbed Bronze (ORB) 

Champagne Bronze (CZ) 

Matte Black (MB) 

## PULLS



**1**  
**37030**  
76mm CTC



**2**  
**37031**  
96mm CTC



**3**  
**37032**  
128mm CTC



**5**  
**37033**  
160mm CTC



**4**  
**37032**  
128mm CTC

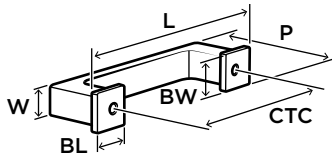

BW in(mm)	BL in(mm)	P in(mm)	W in(mm)	L in(mm)	CTC in(mm)	Wt lbs	Shelf Pk Qty	Price Code	Finish	Part No.
5/8 (16)	5/8 (16)	1-1/16 (27)	7/16 (11)	3-11/16 (94)	3 (76)	0.20	10	B	<b>1 Polished Chrome</b>	<b>BP3703026</b>
									Satin Nickel	BP37030G10
									Champagne Bronze	BP37030CZ
									Oil-Rubbed Bronze	BP37030ORB
									Matte Black	BP37030MB
5/8 (16)	5/8 (16)	1-1/16 (27)	7/16 (11)	4-1/2 (114)	3-3/4 (96)	0.23	10	B	Polished Chrome	BP3703126
									<b>2 Satin Nickel</b>	<b>BP37031G10</b>
									Champagne Bronze	BP37031CZ
									Oil-Rubbed Bronze	BP37031ORB
									Matte Black	BP37031MB
5/8 (16)	5/8 (16)	1-1/16 (27)	7/16 (11)	5-3/4 (146)	5-1/16 (128)	0.25	10	B	Polished Chrome	BP3703226
									Satin Nickel	BP37032G10
									<b>3 Champagne Bronze</b>	<b>BP37032CZ</b>
									<b>4 Oil-Rubbed Bronze</b>	<b>BP37032ORB</b>
									Matte Black	BP37032MB
5/8 (16)	5/8 (16)	1-1/16 (27)	7/16 (11)	7-1/16 (179)	6-5/16 (160)	0.29	10	B	Polished Chrome	BP3703326
									Satin Nickel	BP37033G10
									Champagne Bronze	BP37033CZ
									Oil-Rubbed Bronze	BP37033ORB
									<b>5 Matte Black</b>	<b>BP37033MB</b>

Base Material: Zinc





Hardware Included: Truss Head Machine Screw(s): #8-32 x 1in • #8-32 x 1-1/2in





# Central

## AVAILABLE FINISHES

-  Polished Chrome (26)
-  Champagne Bronze (CZ)
-  Satin Nickel (G10)
-  Matte Black (MB)

PRICE CODE BREAKDOWN • US Dollars			
<b>A</b>	\$5 or less	<b>G</b>	>\$40 to \$50
<b>B</b>	>\$5 to \$10	<b>H</b>	>\$50 to \$75
<b>C</b>	>\$10 to \$15	<b>I</b>	>\$75 to \$100
<b>D</b>	>\$15 to \$20	<b>J</b>	>\$100 to \$150
<b>E</b>	>\$20 to \$30	<b>K</b>	>\$150 to \$200
<b>F</b>	>\$30 to \$40	<b>L</b>	>\$200

## PULLS

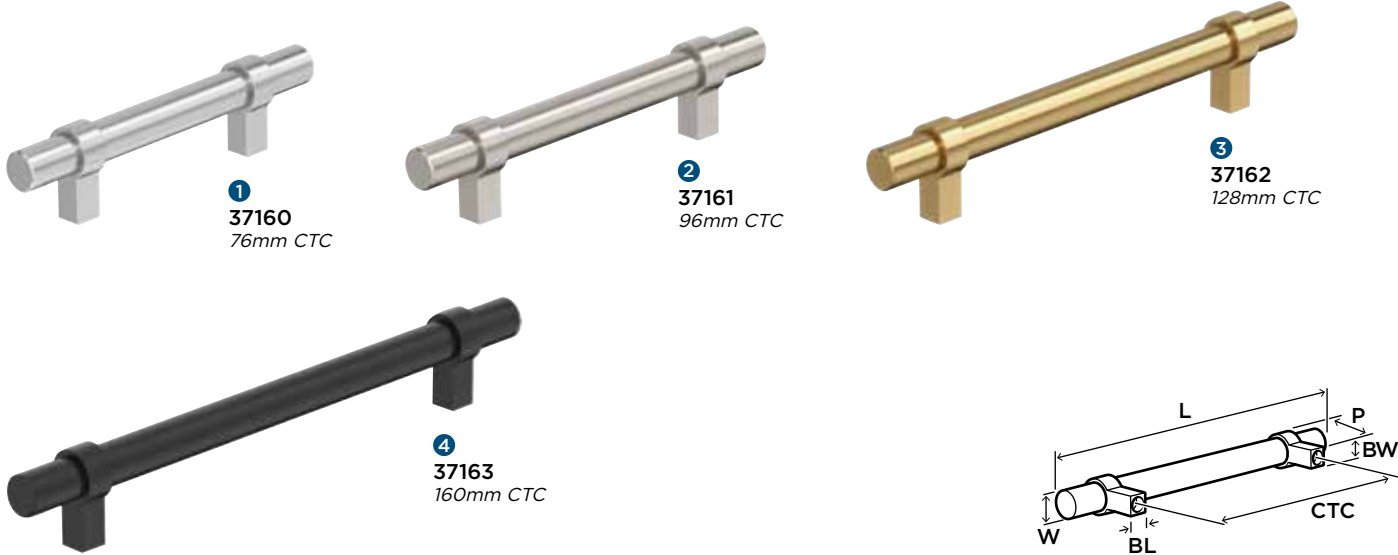

Part No.	Finish	Price Code	Shelf Pk Qty	Wt lbs	CTC in(mm)	L in(mm)	W in(mm)	P in(mm)	BL in(mm)	BW in(mm)
<b>37160</b>	<b>BP3716026</b> ① Polished Chrome	<b>B</b>	10	0.13	3 (76)	4-15/16 (125)	11/16 (17)	1-1/4 (32)	5/16 (8)	3/8 (10)
	BP37160G10 Satin Nickel									
	BP37160CZ Champagne Bronze									
	BP37160MB Matte Black									
<b>37161</b>	BP3716126 Polished Chrome	<b>B</b>	10	0.14	3-3/4 (96)	5-3/4 (146)	11/16 (17)	1-1/4 (32)	5/16 (8)	3/8 (10)
	<b>BP37161G10</b> ② Satin Nickel									
	BP37161CZ Champagne Bronze									
	BP37161MB Matte Black									
<b>37162</b>	BP3716226 Polished Chrome	<b>B</b>	10	0.15	5-1/16 (128)	7 (178)	11/16 (17)	1-1/4 (32)	5/16 (8)	3/8 (10)
	BP37162G10 Satin Nickel									
	<b>BP37162CZ</b> ③ Champagne Bronze									
	BP37162MB Matte Black									
<b>37163</b>	BP3716326 Polished Chrome	<b>B</b>	10	0.16	6-5/16 (160)	8-1/4 (210)	11/16 (17)	1-1/4 (32)	5/16 (8)	3/8 (10)
	BP37163G10 Satin Nickel									
	BP37163CZ Champagne Bronze									
	<b>BP37163MB</b> ④ Matte Black									

Base Material: Zinc

Hardware Included: Truss Head Machine Screw(s): #8-32 x 1in • #8-32 x 1-1/2in

LEGEND			
L	Length	BL	Base Length
W	Width	BW	Base Width
P	Projection	CTC	Center-to-Center

# Chalice





## AVAILABLE FINISHES

Polished Chrome (26) 

Satin Nickel (G10) 

Oil-Rubbed Bronze (ORB) 

Champagne Bronze (CZ) 

Matte Black (MB) 

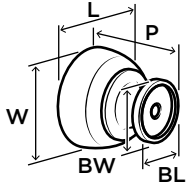

1  
37022



2



3



4



5

## KNOB

BW in(mm)	BL in(mm)	P in(mm)	W in(mm)	L in(mm)	Wt lbs	Shelf Pk Qty	Price Code	Finish	Part No.
3/4 (19)	3/4 (19)	1-1/8 (29)	1-1/4 (32)	1-1/4 (32)	0.19	10	A	<ul style="list-style-type: none"> <li>1 Polished Chrome</li> <li>2 Satin Nickel</li> <li>3 Champagne Bronze</li> <li>4 Oil-Rubbed Bronze</li> <li>5 Matte Black</li> </ul>	<ul style="list-style-type: none"> <li>BP3702226</li> <li>BP37022G10</li> <li>BP37022CZ</li> <li>BP37022ORB</li> <li>BP37022MB</li> </ul>

37022

**Base Material:** Zinc

**Hardware Included:** Truss Head Machine Screw(s): #8-32 x 1in • #8-32 x 1-1/2in

# Chamfered Edge



## AVAILABLE FINISHES

Polished Chrome (26) 

Satin Nickel (G10) 

Oil-Rubbed Bronze (ORB) 

Matte Black (MB) 

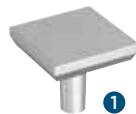
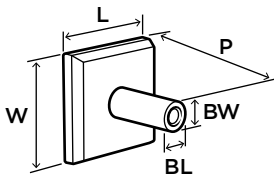

1  
37028



2



3



4

## KNOB

BW in(mm)	BL in(mm)	P in(mm)	W in(mm)	L in(mm)	Wt lbs	Shelf Pk Qty	Price Code	Finish	Part No.
1/4 (6)	1/4 (6)	1 (25)	1-1/16 (27)	1-1/16 (27)	0.09	10	A	<ul style="list-style-type: none"> <li>1 Polished Chrome</li> <li>2 Satin Nickel</li> <li>3 Oil-Rubbed Bronze</li> <li>4 Matte Black</li> </ul>	<ul style="list-style-type: none"> <li>BP3702826</li> <li>BP37028G10</li> <li>BP37028ORB</li> <li>BP37028MB</li> </ul>

37028

**Base Material:** Zinc

**Hardware Included:** Truss Head Machine Screw(s): #8-32 x 1in • #8-32 x 1-1/2in



## AVAILABLE FINISHES

- Polished Chrome (26)
- Oil-Rubbed Bronze (ORB)
- Satin Nickel (G10)
- Matte Black (MB)
- Champagne Bronze (CZ)

PRICE CODE BREAKDOWN • US Dollars			
<b>A</b>	\$5 or less	<b>G</b>	>\$40 to \$50
<b>B</b>	>\$5 to \$10	<b>H</b>	>\$50 to \$75
<b>C</b>	>\$10 to \$15	<b>I</b>	>\$75 to \$100
<b>D</b>	>\$15 to \$20	<b>J</b>	>\$100 to \$150
<b>E</b>	>\$20 to \$30	<b>K</b>	>\$150 to \$200
<b>F</b>	>\$30 to \$40	<b>L</b>	>\$200

## PULLS



Part No.	Finish	Price Code	Shelf Pk Qty	Wt lbs	CTC in(mm)	L in(mm)	W in(mm)	P in(mm)	BL in(mm)	BW in(mm)	
<b>37130</b>	BP3713026	<b>A</b>	10	0.17	3 (76)	4-1/16 (103)	5/16 (8)	1-1/16 (27)	7/8 (22)	5/16 (8)	
	BP37130G10										1 Polished Chrome
	BP37130CZ										2 Satin Nickel
	BP37130ORB										Champagne Bronze
	BP37130MB										Oil-Rubbed Bronze
<b>37131</b>	BP3713126	<b>B</b>	10	0.18	3-3/4 (96)	4-7/8 (124)	5/16 (8)	1-1/16 (27)	7/8 (22)	5/16 (8)	
	BP37131G10										3 Champagne Bronze
	BP37131CZ										4 Oil-Rubbed Bronze
	BP37131ORB										Matte Black
	BP37131MB										Polished Chrome
<b>37132</b>	BP3713226	<b>B</b>	10	0.20	5-1/16 (128)	6-1/8 (156)	5/16 (8)	1-1/16 (27)	7/8 (22)	5/16 (8)	
	BP37132G10										5 Matte Black
	BP37132CZ										Polished Chrome
	BP37132ORB										Satin Nickel
	BP37132MB										Champagne Bronze



Base Material: Zinc  
 Hardware Included: Truss Head Machine Screw(s): #8-32 x 1in • #8-32 x 1-1/2in

LEGEND			
L	Length	BL	Base Length
W	Width	BW	Base Width
P	Projection	CTC	Center-to-Center

Shown on p. 38-39

Cityscape



AVAILABLE FINISHES

- Polished Chrome (26)
- Champagne Bronze (CZ)
- Satin Nickel (G10)
- Oil-Rubbed Bronze (ORB)
- Matte Black (MB)

PULLS (cont'd)

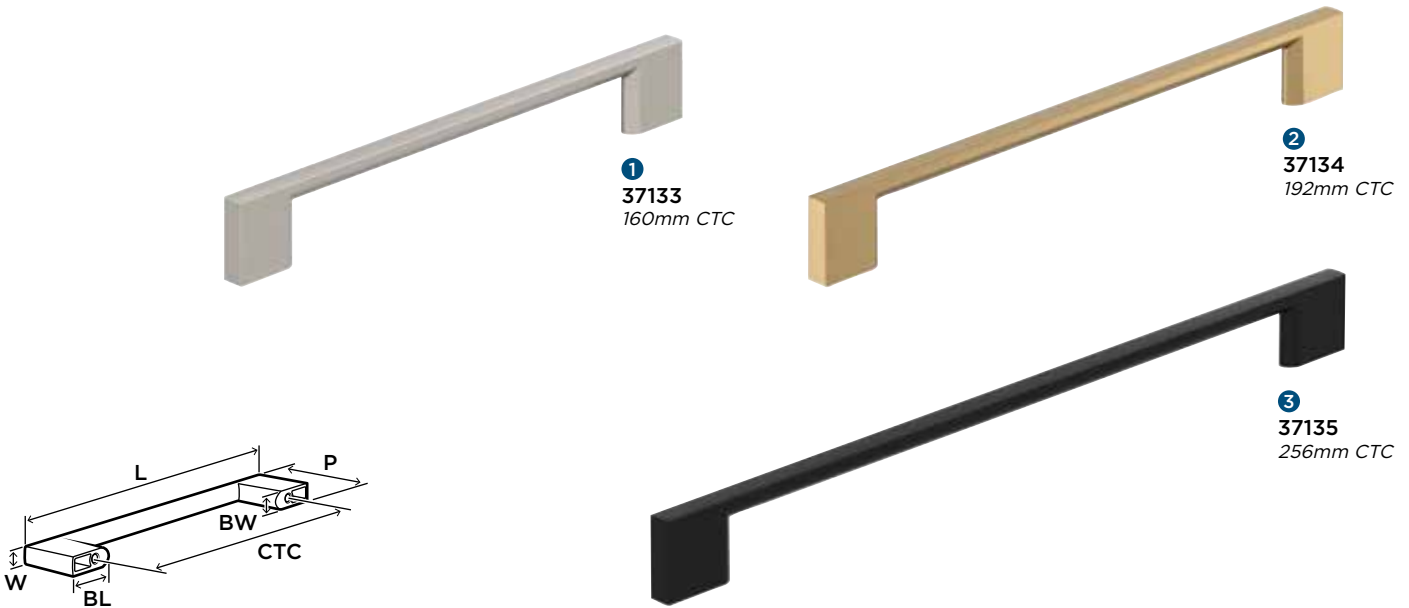

BW in(mm)	BL in(mm)	P in(mm)	W in(mm)	L in(mm)	CTC in(mm)	Wt lbs	Shelf Pk Qty	Price Code	Finish	Part No.
5/16 (8)	7/8 (22)	1-1/16 (27)	5/16 (8)	7-3/8 (187)	6-5/16 (160)	0.22	10	B	Polished Chrome	BP3713326
									① Satin Nickel	BP37133G10
									Champagne Bronze	BP37133CZ
									Oil-Rubbed Bronze	BP37133ORB
									Matte Black	BP37133MB
5/16 (8)	7/8 (22)	1-1/16 (27)	5/16 (8)	8-5/8 (219)	7-9/16 (192)	0.26	10	B	Polished Chrome	BP3713426
									Satin Nickel	BP37134G10
									② Champagne Bronze	BP37134CZ
									Oil-Rubbed Bronze	BP37134ORB
									Matte Black	BP37134MB
5/16 (8)	1-1/16 (27)	1-1/16 (27)	5/16 (8)	11-9/16 (294)	10-1/16 (256)	0.33	10	C	Polished Chrome	BP3713526
									Satin Nickel	BP37135G10
									Champagne Bronze	BP37135CZ
									Oil-Rubbed Bronze	BP37135ORB
									③ Matte Black	BP37135MB

Base Material: Zinc

Hardware Included: Truss Head Machine Screw(s): #8-32 x 1in • #8-32 x 1-1/2in





# Composite

Shown on p. 40-41

## AVAILABLE FINISHES

- Polished Chrome (26)
- Champagne Bronze (CZ)
- Satin Nickel (G10)
- Matte Black (MB)

PRICE CODE BREAKDOWN • US Dollars			
<b>A</b>	\$5 or less	<b>G</b>	>\$40 to \$50
<b>B</b>	>\$5 to \$10	<b>H</b>	>\$50 to \$75
<b>C</b>	>\$10 to \$15	<b>I</b>	>\$75 to \$100
<b>D</b>	>\$15 to \$20	<b>J</b>	>\$100 to \$150
<b>E</b>	>\$20 to \$30	<b>K</b>	>\$150 to \$200
<b>F</b>	>\$30 to \$40	<b>L</b>	>\$200

## PULLS

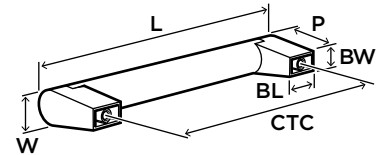

Part No.	Finish	Price Code	Shelf Pk Qty	Wt lbs	CTC in(mm)	L in(mm)	W in(mm)	P in(mm)	BL in(mm)	BW in(mm)	
<b>37140</b>	BP3714026	① Polished Chrome	<b>B</b>	10	0.18	3 (76)	3-5/8 (92)	5/8 (16)	1-3/8 (35)	11/16 (17)	3/8 (10)
	BP37140G10	Satin Nickel									
	BP37140CZ	Champagne Bronze									
	BP37140MB	Matte Black									
<b>37141</b>	BP3714126	Polished Chrome	<b>B</b>	10	0.19	3-3/4 (96)	4-7/16 (113)	5/8 (16)	1-3/8 (35)	11/16 (17)	3/8 (10)
	BP37141G10	② Satin Nickel									
	BP37141CZ	③ Champagne Bronze									
	BP37141MB	Matte Black									
<b>37142</b>	BP3714226	Polished Chrome	<b>B</b>	10	0.20	5-1/16 (128)	5-11/16 (144)	5/8 (16)	1-3/8 (35)	11/16 (17)	3/8 (10)
	BP37142G10	Satin Nickel									
	BP37142CZ	Champagne Bronze									
	BP37142MB	④ Matte Black									

Base Material: Zinc

Hardware Included: Truss Head Machine Screw(s): #8-32 x 1in • #8-32 x 1-1/2in



LEGEND			
L	Length	BL	Base Length
W	Width	BW	Base Width
P	Projection	CTC	Center-to-Center

Shown on p. 40-41

# Composite



## AVAILABLE FINISHES

- Polished Chrome (26)
- Champagne Bronze (CZ)
- Satin Nickel (G10)
- Matte Black (MB)

## PULLS (cont'd)



**1**  
**37143**  
160mm CTC



**2**  
**37143**  
160mm CTC



**3**  
**37144**  
192mm CTC



**4**  
**37144**  
192mm CTC

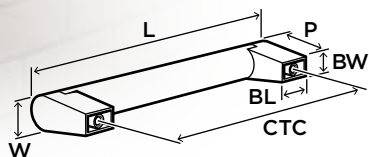

BW in(mm)	BL in(mm)	P in(mm)	W in(mm)	L in(mm)	CTC in(mm)	Wt lbs	Shelf Pk Qty	Price Code	Finish	Part No.
3/8 (10)	11/16 (17)	1-3/8 (35)	5/8 (16)	6-15/16 (176)	6-5/16 (160)	0.21	10	<b>B</b>	<b>1</b> Polished Chrome	BP3714326
									<b>2</b> Satin Nickel	BP37143G10
									Champagne Bronze	BP37143CZ
									Matte Black	BP37143MB
3/8 (10)	11/16 (17)	1-3/8 (35)	5/8 (16)	8-3/16 (208)	7-9/16 (192)	0.23	10	<b>C</b>	Polished Chrome	BP3714426
									Satin Nickel	BP37144G10
									<b>3</b> Champagne Bronze	BP37144CZ
									<b>4</b> Matte Black	BP37144MB

37143

37144

**Base Material:** Zinc

**Hardware Included:** Truss Head Machine Screw(s): #8-32 x 1in • #8-32 x 1-1/2in



# Cup Pulls

## AVAILABLE FINISHES

- Polished Chrome (26)
- Golden Champagne (BBZ)
- Oil-Rubbed Bronze (ORB)
- Polished Nickel (PN)
- Champagne Bronze (CZ)
- Matte Black (FB)
- Satin Nickel (G10)

## PRICE CODE BREAKDOWN

US Dollars

<b>A</b>	\$5 or less
<b>B</b>	>\$5 to \$10
<b>C</b>	>\$10 to \$15
<b>D</b>	>\$15 to \$20
<b>E</b>	>\$20 to \$30
<b>F</b>	>\$30 to \$40
<b>G</b>	>\$40 to \$50
<b>H</b>	>\$50 to \$75
<b>I</b>	>\$75 to \$100
<b>J</b>	>\$100 to \$150
<b>K</b>	>\$150 to \$200
<b>L</b>	>\$200

## CUP PULLS

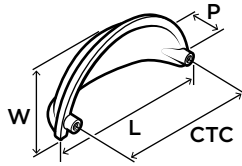

### Correct Installation

Requires counterbore drilling



### Incorrect Installation



Part No.	Finish	Price Code	Shelf Pk Qty	Wt lbs	CTC in(mm)	L in(mm)	W in(mm)	P in(mm)	BL in(mm)	BW in(mm)
BP5301026	<b>1</b> Polished Chrome	<b>B</b>	25	0.17	3 (76)	3-7/16 (87)	1-5/8 (41)	1 (25)	3-7/16 (87)	1-5/8 (41)
BP53010PN	<b>2</b> Polished Nickel									
BP53010G10	<b>3</b> Satin Nickel									
BP53010BBZ	<b>4</b> Golden Champagne	<b>B</b>	10							
BP53010CZ	<b>5</b> Champagne Bronze	<b>B</b>	25							
BP53010ORB	<b>6</b> Oil-Rubbed Bronze	<b>B</b>								
BP53010FB	<b>7</b> Matte Black									

Base Material: Zinc

Hardware Included: Truss Head Machine Screw(s): #8-32 x 1in • #8-32 x 1-1/2in

53010

LEGEND			
L	Length	BL	Base Length
W	Width	BW	Base Width
P	Projection	CTC	Center-to-Center

# Current



## AVAILABLE FINISHES

- Polished Chrome (26)
- Champagne Bronze (CZ)
- Satin Nickel (G10)
- Matte Black (MB)

## PULLS

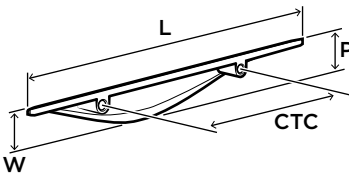

BW in(mm)	BL in(mm)	P in(mm)	W in(mm)	L in(mm)	CTC in(mm)	Wt lbs	Shelf Pk Qty	Price Code	Finish	Part No.
7/8 (22)	5-7/8 (149)	3/4 (19)	7/8 (22)	5-7/8 (149)	3 (76)	0.12	10	<b>A</b>	<b>1 Polished Chrome</b>	<b>BP3721026</b>
					Satin Nickel				BP37210G10	
					Champagne Bronze				BP37210CZ	
					Matte Black				BP37210MB	
7/8 (22)	6-11/16 (170)	3/4 (19)	7/8 (22)	6-11/16 (170)	3-3/4 (96)	0.14	10	<b>B</b>	Polished Chrome	BP3721126
					<b>2 Satin Nickel</b>				<b>BP37211G10</b>	
					Champagne Bronze				BP37211CZ	
					Matte Black				BP37211MB	
7/8 (22)	7-15/16 (202)	3/4 (19)	7/8 (22)	7-15/16 (202)	5-1/16 (128)	0.17	10	<b>B</b>	Polished Chrome	BP3721226
					Satin Nickel				BP37212G10	
					<b>3 Champagne Bronze</b>				<b>BP37212CZ</b>	
					Matte Black				BP37212MB	
7/8 (22)	9-3/16 (233)	3/4 (19)	7/8 (22)	9-3/16 (233)	6-5/16 (160)	0.20	10	<b>B</b>	Polished Chrome	BP3721326
					Satin Nickel				BP37213G10	
					Champagne Bronze				BP37213CZ	
					<b>4 Matte Black</b>				<b>BP37213MB</b>	

**Base Material:** Zinc  
**Hardware Included:** Truss Head Machine Screw(s): #8-32 x 1in • #8-32 x 1-1/2in



# Cyprus

Shown on p. 44-47

## PRICE CODE BREAKDOWN US Dollars

<b>A</b>	\$5 or less
<b>B</b>	>\$5 to \$10
<b>C</b>	>\$10 to \$15
<b>D</b>	>\$15 to \$20
<b>E</b>	>\$20 to \$30
<b>F</b>	>\$30 to \$40
<b>G</b>	>\$40 to \$50
<b>H</b>	>\$50 to \$75
<b>I</b>	>\$75 to \$100
<b>J</b>	>\$100 to \$150
<b>K</b>	>\$150 to \$200
<b>L</b>	>\$200

## AVAILABLE FINISHES

- Polished Chrome (26)
- Golden Champagne (BBZ)
- Oil-Rubbed Bronze (ORB)
- Polished Nickel (PN)
- Champagne Bronze (CZ)
- Black Bronze (BBR)
- Satin Nickel (G10)

## PULLS

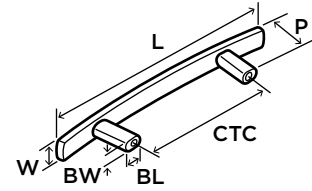

Part No.	Finish	Price Code	Shelf Pk Qty	Wt lbs	CTC in(mm)	L in(mm)	W in(mm)	P in(mm)	BL in(mm)	BW in(mm)	
<b>26201</b>	BP2620126	Polished Chrome	<b>B</b>	10	0.16	3 (76)	5-1/4 (133)	3/8 (10)	1-1/16 (27)	3/8 (10)	1/4 (6)
	<b>BP26201PN</b>	<b>1</b> Polished Nickel	<b>B</b>	25							
	BP26201G10	Satin Nickel	<b>B</b>	25							
	BP26201BBZ	Golden Champagne	<b>B</b>	10							
	BP26201CZ	Champagne Bronze	<b>B</b>	10							
	BP26201ORB	Oil-Rubbed Bronze	<b>B</b>	25							
	BP26201BBR	Black Bronze	<b>B</b>	25							
<b>26203</b>	BP2620326	Polished Chrome	<b>C</b>	10	0.21	3-3/4 (96)	6-9/16 (167)	1/2 (13)	1-1/8 (29)	3/8 (10)	5/16 (8)
	BP26203PN	Polished Nickel	<b>C</b>	25							
	<b>BP26203G10</b>	<b>2</b> Satin Nickel	<b>C</b>	25							
	BP26203BBZ	Golden Champagne	<b>C</b>	10							
	BP26203CZ	Champagne Bronze	<b>C</b>	10							
	BP26203ORB	Oil-Rubbed Bronze	<b>C</b>	25							
	BP26203BBR	Black Bronze	<b>C</b>	25							
<b>9362</b>	BP936226	Polished Chrome	<b>C</b>	10	0.28	5-1/16 (128)	7-13/16 (198)	1/2 (13)	1-3/16 (30)	7/16 (11)	5/16 (8)
	BP9362PN	Polished Nickel									
	BP9362G10	Satin Nickel									
	BP9362BBZ	Golden Champagne									
	<b>BP9362CZ</b>	<b>3</b> Champagne Bronze									
	BP9362ORB	Oil-Rubbed Bronze									
	<b>BP9362BBR</b>	<b>4</b> Black Bronze									

Base Material: Zinc

Hardware Included: Truss Head Machine Screw(s): #8-32 x 1in • #8-32 x 1-1/2in

LEGEND			
L	Length	BL	Base Length
W	Width	BW	Base Width
P	Projection	CTC	Center-to-Center

Shown on p. 44-47

Cyprus



AVAILABLE FINISHES

- Polished Chrome (26)
- Satin Nickel (G10)
- Champagne Bronze (CZ)
- Polished Nickel (PN)
- Golden Champagne (BBZ)
- Oil-Rubbed Bronze (ORB)
- Black Bronze (BBR)

PULLS (cont'd)



1  
26204  
160mm CTC



2  
26204  
160mm CTC



3  
26208+  
192mm CTC

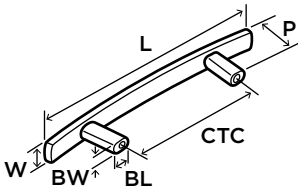

BW in(mm)	BL in(mm)	P in(mm)	W in(mm)	L in(mm)	CTC in(mm)	Wt lbs	Shelf Pk Qty	Price Code	Finish	Part No.
5/16 (8)	7/16 (11)	1-1/4 (32)	1/2 (13)	9-1/16 (230)	6-5/16 (160)	0.31	10	D	1 Polished Chrome	BP2620426
									Polished Nickel	BP26204PN
									Satin Nickel	BP26204G10
									2 Golden Champagne	BP26204BBZ
									Champagne Bronze	BP26204CZ
									Oil-Rubbed Bronze	BP26204ORB
									Black Bronze	BP26204BBR
3/8 (10)	1/2 (13)	1-7/16 (37)	9/16 (14)	10-7/8 (276)	7-9/16 (192)	0.47	10	D	Polished Chrome	BP2620826+
									Polished Nickel	BP26208PN+
									Satin Nickel	BP26208G10+
									Golden Champagne	BP26208BBZ+
									Champagne Bronze	BP26208CZ+
									3 Oil-Rubbed Bronze	BP26208ORB+
									Black Bronze	BP26208BBR+

26204

26208+

† Coming Soon • Base Material: Zinc

Hardware Included: Truss Head Machine Screw(s): #8-32 x 1in • #8-32 x 1-1/2in



## AVAILABLE FINISHES

- Polished Chrome (26)
- Golden Champagne (BBZ)
- Oil-Rubbed Bronze (ORB)
- Polished Nickel (PN)
- Champagne Bronze (CZ)
- Black Bronze (BBR)
- Satin Nickel (G10)

## PULLS (cont'd)



1  
26209+  
224mm CTC



2  
26210+  
256mm CTC

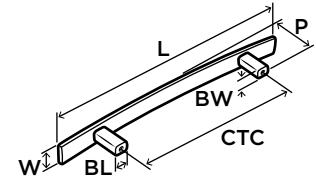

## PRICE CODE BREAKDOWN US Dollars

A	\$5 or less
B	>\$5 to \$10
C	>\$10 to \$15
D	>\$15 to \$20
E	>\$20 to \$30
F	>\$30 to \$40
G	>\$40 to \$50
H	>\$50 to \$75
I	>\$75 to \$100
J	>\$100 to \$150
K	>\$150 to \$200
L	>\$200

Part No.	Finish	Price Code	Shelf Pk Qty	Wt lbs	CTC in(mm)	L in(mm)	W in(mm)	P in(mm)	BL in(mm)	BW in(mm)
26209+	BP2620926+	Polished Chrome	10	0.50	8-13/16 (224)	12-1/8 (308)	9/16 (14)	1-9/16 (40)	1/2 (13)	3/8 (10)
	BP26209PN+	1 Polished Nickel								
	BP26209G10+	Satin Nickel								
	BP26209BBZ+	Golden Champagne								
	BP26209CZ+	Champagne Bronze								
	BP26209ORB+	Oil-Rubbed Bronze								
BP26209BBR+	Black Bronze									
26210+	BP2621026+	Polished Chrome	10	0.56	10-1/16 (256)	13-7/16 (341)	9/16 (14)	1-9/16 (40)	9/16 (14)	3/8 (10)
	BP26210PN+	Polished Nickel								
	BP26210G10+	Satin Nickel								
	BP26210BBZ+	Golden Champagne								
	BP26210CZ+	Champagne Bronze								
	BP26210ORB+	Oil-Rubbed Bronze								
BP26210BBR+	2 Black Bronze									

† Coming Soon • Base Material: Zinc

Hardware Included: Truss Head Machine Screw(s): #8-32 x 1in • #8-32 x 1-1/2in

LEGEND			
L	Length	BL	Base Length
W	Width	BW	Base Width
P	Projection	CTC	Center-to-Center

Shown on p. 44-47

Cyprus



AVAILABLE FINISHES

- Polished Chrome (26)
- Satin Nickel (G10)
- Champagne Bronze (CZ)
- Polished Nickel (PN)
- Golden Champagne (BBZ)
- Oil-Rubbed Bronze (ORB)
- Black Bronze (BBR)

APPLIANCE PULLS

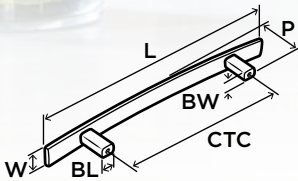

BW in(mm)	BL in(mm)	P in(mm)	W in(mm)	L in(mm)	CTC in(mm)	Wt lbs	Shelf Pk Qty	Price Code	Finish	Part No.
7/16 (11)	9/16 (14)	1-11/16 (43)	7/8 (22)	16 (406)	12 (305)	1.70	1	J	Polished Chrome	BP2620626†
									Polished Nickel	BP26206PN
									Satin Nickel	BP26206G10
									① Golden Champagne	BP26206BBZ
									Champagne Bronze	BP26206CZ†
									Oil-Rubbed Bronze	BP26206ORB
									Black Bronze	BP26206BBR
7/16 (11)	9/16 (14)	1-11/16 (43)	7/8 (22)	22 (559)	18 (457)	2.20	1	K	Polished Chrome	BP2620726†
									Polished Nickel	BP26207PN
									Satin Nickel	BP26207G10
									Golden Champagne	BP26207BBZ
									Champagne Bronze	BP26207CZ†
									② Oil-Rubbed Bronze	BP26207ORB
Black Bronze	BP26207BBR									

26206

26207

† Coming Soon • Base Material: Zinc

Hardware Included: Washers & Truss Head Machine Screw(s):

#10-24 x 3/4in • #10-24 x 1in • #10-24 x 1-1/4in • #10-24 x 1-1/2in • #10-24 x 1-3/4in • #10-24 x 2-1/8in



# Edge Pulls

## AVAILABLE FINISHES

- Polished Chrome (26)
- Satin Nickel (G10)
- Oil-Rubbed Bronze (ORB)
- Polished Nickel (PN)
- Champagne Bronze (CZ)
- Matte Black (FB)

## PRICE CODE BREAKDOWN

US Dollars

<b>A</b>	\$5 or less
<b>B</b>	>\$5 to \$10
<b>C</b>	>\$10 to \$15
<b>D</b>	>\$15 to \$20
<b>E</b>	>\$20 to \$30
<b>F</b>	>\$30 to \$40
<b>G</b>	>\$40 to \$50
<b>H</b>	>\$50 to \$75
<b>I</b>	>\$75 to \$100
<b>J</b>	>\$100 to \$150
<b>K</b>	>\$150 to \$200
<b>L</b>	>\$200

## EDGE PULLS

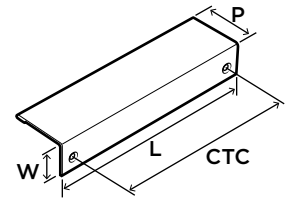
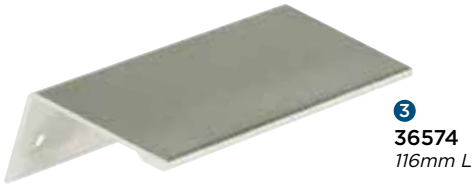

Part No.	Finish	Price Code	Shelf Pk Qty	Wt lbs	CTC in(mm)	L in(mm)	W in(mm)	P in(mm)	BL in(mm)	BW in(mm)
<b>36573</b>	BP3657326	<b>A</b>	50	0.07	3 (76)	3-3/4 (96)	1 (25)	1-5/8 (41)	3-3/4 (96)	15/16 (24)
	BP36573PN									
	BP36573G10									
	BP36573CZ									
	BP36573ORB									
	BP36573FB									
<b>36574</b>	BP3657426	<b>B</b>	50	0.09	3-3/4 (96)	4-9/16 (116)	1 (25)	1-5/8 (41)	4-9/16 (116)	15/16 (24)
	BP36574PN									
	BP36574G10									
	BP36574CZ									
	BP36574ORB									
	BP36574FB									
<b>36575</b>	BP3657526	<b>B</b>	40	0.11	5-1/16 (128)	5-13/16 (148)	1 (25)	1-5/8 (41)	5-13/16 (148)	15/16 (24)
	BP36575PN									
	BP36575G10									
	BP36575CZ									
	BP36575ORB									
	BP36575FB									

Base Material: Aluminum

Hardware Included: Flat Head Wood Screw(s): #4 x 16mm



LEGEND			
L	Length	BL	Base Length
W	Width	BW	Base Width
P	Projection	CTC	Center-to-Center

# Edona



## AVAILABLE FINISHES

- Polished Chrome (26)
- Antique Silver (AS)
- Champagne Bronze (CZ)
- Polished Nickel (PN)
- Polished Brass (3)
- Burnished Brass (BB)
- Satin Nickel (G10)
- Golden Champagne (BBZ)
- Oil-Rubbed Bronze (ORB)
- Matte Black (FB)



## KNOB

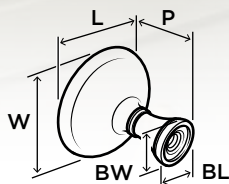

BW in(mm)	BL in(mm)	P in(mm)	W in(mm)	L in(mm)	Wt lbs	Shelf Pk Qty	Price Code	Finish	Part No.
5/8 (16)	5/8 (16)	1-1/8 (29)	1-1/4 (32)	1-1/4 (32)	0.12	25	A	1 Polished Chrome	BP5300526
						10	A	2 Polished Nickel	BP53005PN†
								3 Satin Nickel	BP53005G10
								4 Antique Silver	BP53005AS
								5 Polished Brass	BP530053
								6 Golden Champagne	BP53005BBZ
								7 Champagne Bronze	BP53005CZ
								8 Burnished Brass	BP53005BB
								9 Oil-Rubbed Bronze	BP53005ORB
								25	A

53005

† Coming Soon • Base Material: Zinc

Hardware Included: Truss Head Machine Screw(s): #8-32 x 1in • #8-32 x 1-1/2in



# Eleva

## AVAILABLE FINISHES

-  Polished Chrome (26)
-  Oil-Rubbed Bronze (ORB)
-  Satin Nickel (G10)
-  Matte Black (MB)
-  Champagne Bronze (CZ)

## PRICE CODE BREAKDOWN • US Dollars

<b>A</b>	\$5 or less	<b>G</b>	>\$40 to \$50
<b>B</b>	>\$5 to \$10	<b>H</b>	>\$50 to \$75
<b>C</b>	>\$10 to \$15	<b>I</b>	>\$75 to \$100
<b>D</b>	>\$15 to \$20	<b>J</b>	>\$100 to \$150
<b>E</b>	>\$20 to \$30	<b>K</b>	>\$150 to \$200
<b>F</b>	>\$30 to \$40	<b>L</b>	>\$200

## KNOBS

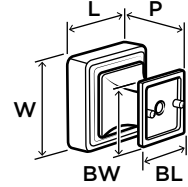

Part No.	Finish	Price Code	Shelf Pk Qty	Wt lbs	L in(mm)	W in(mm)	P in(mm)	BL in(mm)	BW in(mm)
37021	BP3702126	B	10	0.22	1-3/16 (30)	1-3/16 (30)	1-3/16 (30)	7/8 (22)	7/8 (22)
	BP37021G10								
	BP37021CZ								
	BP37021ORB								
	BP37021MB								

Base Material: Zinc

Hardware Included: Truss Head Machine Screw(s): #8-32 x 1in • #8-32 x 1-1/2in



# Era

## AVAILABLE FINISHES

-  Polished Chrome (26)
-  Satin Nickel (G10)
-  Oil-Rubbed Bronze (ORB)
-  Matte Black (FB)

## KNOBS

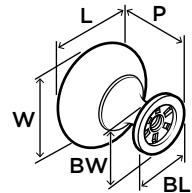

Part No.	Finish	Price Code	Shelf Pk Qty	Wt lbs	L in(mm)	W in(mm)	P in(mm)	BL in(mm)	BW in(mm)
36907	BP3690726	A	100	0.05	1-1/4 (32)	1-1/4 (32)	1-1/8 (29)	5/8 (16)	5/8 (16)
	BP36907G10								
	BP36907ORB								
	BP36907FB								

Base Material: Zinc

Hardware Included: Truss Head Machine Screw(s): #8-32 x 1in • #8-32 x 1-1/2in

LEGEND			
L	Length	BL	Base Length
W	Width	BW	Base Width
P	Projection	CTC	Center-to-Center

# Evolve



## AVAILABLE FINISHES

Polished Chrome (26)

Satin Nickel (G10)

Oil-Rubbed Bronze (ORB)

Champagne Bronze (CZ)

Matte Black (MB)

## PULLS

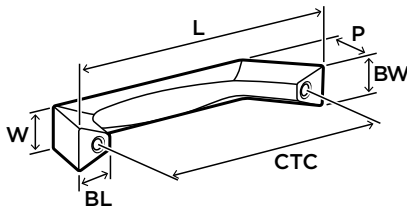
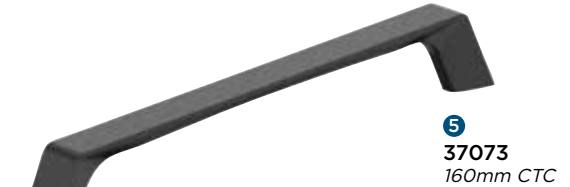

BW in(mm)	BL in(mm)	P in(mm)	W in(mm)	L in(mm)	CTC in(mm)	Wt lbs	Shelf Pk Qty	Price Code	Finish	Part No.
1/2 (13)	1/2 (13)	1 (25)	1/2 (13)	3-5/8 (92)	3 (76)	0.15	10	B	1 Polished Chrome	BP3707026
									2 Satin Nickel	BP37070G10
									Champagne Bronze	BP37070CZ
									Oil-Rubbed Bronze	BP37070ORB
									Matte Black	BP37070MB
1/2 (13)	1/2 (13)	1 (25)	1/2 (13)	4-3/8 (111)	3-3/4 (96)	0.17	10	B	Polished Chrome	BP3707126
									Satin Nickel	BP37071G10
									3 Champagne Bronze	BP37071CZ
									Oil-Rubbed Bronze	BP37071ORB
									Matte Black	BP37071MB
1/2 (13)	1/2 (13)	1 (25)	1/2 (13)	5-11/16 (144)	5-1/16 (128)	0.20	10	B	Polished Chrome	BP3707226
									Satin Nickel	BP37072G10
									Champagne Bronze	BP37072CZ
									4 Oil-Rubbed Bronze	BP37072ORB
									Matte Black	BP37072MB
1/2 (13)	1/2 (13)	1 (25)	1/2 (13)	6-15/16 (176)	6-5/16 (160)	0.23	10	B	Polished Chrome	BP3707326
									Satin Nickel	BP37073G10
									Champagne Bronze	BP37073CZ
									Oil-Rubbed Bronze	BP37073ORB
									5 Matte Black	BP37073MB

37070

37071

37072

37073

Base Material: Zinc

Hardware Included: Truss Head Machine Screw(s): #8-32 x 1in • #8-32 x 1-1/2in





PRICE CODE BREAKDOWN US Dollars	
<b>A</b>	\$5 or less
<b>B</b>	>\$5 to \$10
<b>C</b>	>\$10 to \$15
<b>D</b>	>\$15 to \$20
<b>E</b>	>\$20 to \$30
<b>F</b>	>\$30 to \$40
<b>G</b>	>\$40 to \$50
<b>H</b>	>\$50 to \$75
<b>I</b>	>\$75 to \$100
<b>J</b>	>\$100 to \$150
<b>K</b>	>\$150 to \$200
<b>L</b>	>\$200

## AVAILABLE FINISHES

- Polished Chrome (26)
- Champagne Bronze (CZ)
- Matte Black (FB)
- Satin Nickel (G10)
- Oil-Rubbed Bronze (ORB)

## KNOBS

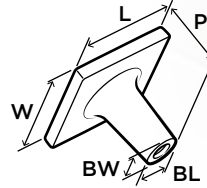
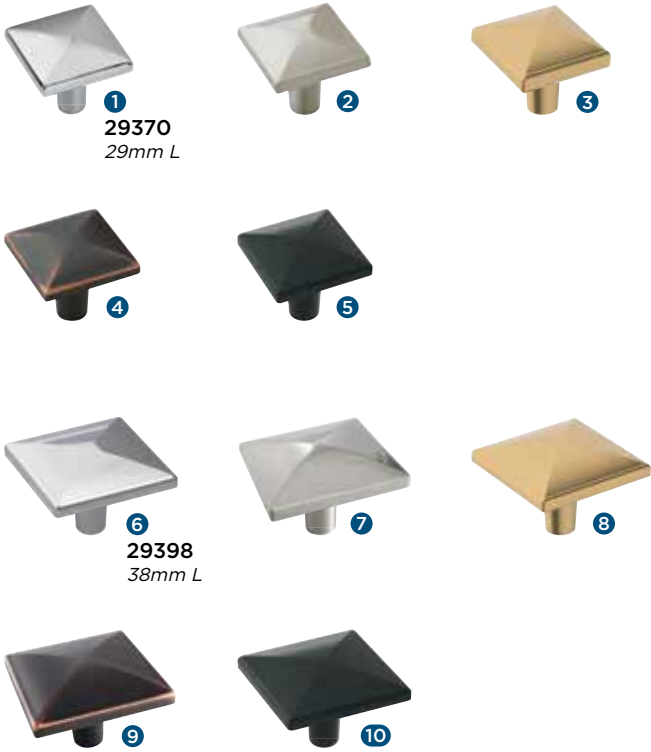

Part No.	Finish	Price Code	Shelf Pk Qty	Wt lbs	L in(mm)	W in(mm)	P in(mm)	BL in(mm)	BW in(mm)
<b>29370</b>	BP2937026	1 Polished Chrome	10	0.11	1-1/8 (29)	1-1/8 (29)	1-1/16 (27)	5/16 (8)	5/16 (8)
	BP29370G10	2 Satin Nickel							
	BP29370CZ	3 Champagne Bronze							
	BP29370ORB	4 Oil-Rubbed Bronze							
	BP29370FB	5 Matte Black							
<b>29398</b>	BP2939826	6 Polished Chrome	10	0.16	1-1/2 (38)	1-1/2 (38)	1-1/8 (29)	5/16 (8)	5/16 (8)
	BP29398G10	7 Satin Nickel							
	BP29398CZ	8 Champagne Bronze							
	BP29398ORB	9 Oil-Rubbed Bronze							
	BP29398FB	10 Matte Black							

Base Material: Zinc

Hardware Included: Truss Head Machine Screw(s): #8-32 x 1in • #8-32 x 1-1/2in

LEGEND			
L	Length	BL	Base Length
W	Width	BW	Base Width
P	Projection	CTC	Center-to-Center

Shown on p. 52-53

# Extensity





## AVAILABLE FINISHES

Polished Chrome (26) 

Satin Nickel (G10) 

Oil-Rubbed Bronze (ORB) 

Champagne Bronze (CZ) 

Matte Black (FB) 

## PULLS

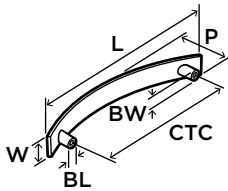

BW in(mm)	BL in(mm)	P in(mm)	W in(mm)	L in(mm)	CTC in(mm)	Wt lbs	Shelf Pk Qty	Price Code	Finish	Part No.
5/16 (8)	5/16 (8)	1-5/16 (33)	11/16 (17)	4-1/8 (105)	3 (76)	0.16	10	B	<b>1</b> Polished Chrome	BP2937926
									<b>2</b> Satin Nickel	BP29379G10
									Champagne Bronze	BP29379CZ
									Oil-Rubbed Bronze	BP29379ORB
									Matte Black	BP29379FB
5/16 (8)	5/16 (8)	1-5/16 (33)	11/16 (17)	4-15/16 (125)	3-3/4 (96)	0.19	10	B	Polished Chrome	BP2938526
									Satin Nickel	BP29385G10
									<b>3</b> Champagne Bronze	BP29385CZ
									Oil-Rubbed Bronze	BP29385ORB
									Matte Black	BP29385FB
5/16 (8)	5/16 (8)	1-7/16 (37)	11/16 (17)	6-1/4 (159)	5-1/16 (128)	0.27	10	B	Polished Chrome	BP2939326
									Satin Nickel	BP29393G10
									Champagne Bronze	BP29393CZ
									<b>4</b> Oil-Rubbed Bronze	BP29393ORB
									Matte Black	BP29393FB
5/16 (8)	5/16 (8)	1-1/2 (38)	11/16 (17)	7-1/2 (191)	6-5/16 (160)	0.38	10	C	Polished Chrome	BP2939426
									Satin Nickel	BP29394G10
									Champagne Bronze	BP29394CZ
									Oil-Rubbed Bronze	BP29394ORB
									<b>5</b> Matte Black	BP29394FB

Base Material: Zinc

Hardware Included: Truss Head Machine Screw(s): #8-32 x 1in • #8-32 x 1-1/2in



# Fairfield

## AVAILABLE FINISHES

- Polished Chrome (CH)
- Oil-Rubbed Bronze (ORB)
- Satin Nickel (G10)
- Matte Black (FB)
- Champagne Bronze (CZ)

## PRICE CODE BREAKDOWN • US Dollars

<b>A</b>	\$5 or less	<b>G</b>	>\$40 to \$50
<b>B</b>	>\$5 to \$10	<b>H</b>	>\$50 to \$75
<b>C</b>	>\$10 to \$15	<b>I</b>	>\$75 to \$100
<b>D</b>	>\$15 to \$20	<b>J</b>	>\$100 to \$150
<b>E</b>	>\$20 to \$30	<b>K</b>	>\$150 to \$200
<b>F</b>	>\$30 to \$40	<b>L</b>	>\$200

## PULLS



Part No.	Finish	Price Code	Shelf Pk Qty	Wt lbs	CTC in(mm)	L in(mm)	W in(mm)	P in(mm)	BL in(mm)	BW in(mm)
<b>173</b>	<b>173CH</b> ① Polished Chrome	<b>A</b>	25							
	BP173G10 Satin Nickel	<b>A</b>	10	0.10	3 (76)	4-5/8 (117)	7/8 (22)	1 (25)	15/16 (24)	13/16 (21)
	BP173CZ Champagne Bronze	<b>A</b>	10							
	BP173ORB Oil-Rubbed Bronze	<b>A</b>	25							
	BP173FB Matte Black	<b>A</b>	10							
<b>37220</b>	BP37220CH Polished Chrome									
	<b>BP37220G10</b> ② Satin Nickel	<b>B</b>	10	0.12	3-3/4 (96)	5-3/8 (137)	7/16 (11)	1 (25)	7/8 (22)	13/16 (21)
	<b>BP37220CZ</b> ③ Champagne Bronze									
	BP37220ORB Oil-Rubbed Bronze									
	BP37220FB Matte Black									
<b>37221</b>	BP37221CH Polished Chrome									
	BP37221G10 Satin Nickel									
	BP37221CZ Champagne Bronze	<b>B</b>	10	0.13	5-1/16 (128)	6-5/8 (168)	7/16 (11)	1-1/16 (27)	7/8 (22)	13/16 (21)
	<b>BP37221ORB</b> ④ Oil-Rubbed Bronze									
	BP37221FB Matte Black									
<b>37222</b>	BP37222CH Polished Chrome									
	BP37222G10 Satin Nickel									
	BP37222CZ Champagne Bronze	<b>B</b>	10	0.17	6-5/16 (160)	7-7/8 (201)	1/2 (13)	1-1/16 (27)	7/8 (22)	13/16 (21)
	BP37222ORB Oil-Rubbed Bronze									
	<b>BP37222FB</b> ⑤ Matte Black									



Base Material: Zinc  
 Hardware Included: Truss Head Machine Screw(s): #8-32 x 1in • #8-32 x 1-1/2in

LEGEND			
L	Length	BL	Base Length
W	Width	BW	Base Width
P	Projection	CTC	Center-to-Center

# Franklin



## AVAILABLE FINISHES

Polished Chrome (26)

Satin Nickel (G10)

Oil-Rubbed Bronze (ORB)

Champagne Bronze (CZ)

Matte Black (MB)

## PULLS



**1**  
**37050**  
76mm CTC



**2**  
**37051**  
96mm CTC



**3**  
**37051**  
96mm CTC

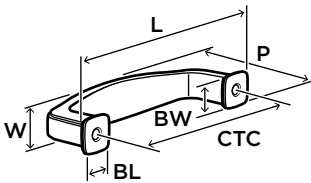

**4**  
**37052**  
128mm CTC



**5**  
**37053**  
160mm CTC

BW in(mm)	BL in(mm)	P in(mm)	W in(mm)	L in(mm)	CTC in(mm)	Wt lbs	Shelf Pk Qty	Price Code	Finish	Part No.
7/16 (11)	7/16 (11)	1-1/16 (27)	9/16 (14)	3-7/16 (87)	3 (76)	0.14	10	B	1 Polished Chrome	BP3705026
									Satin Nickel	BP37050G10
									Champagne Bronze	BP37050CZ
									Oil-Rubbed Bronze	BP37050ORB
									Matte Black	BP37050MB
7/16 (11)	7/16 (11)	1-1/16 (27)	9/16 (14)	4-1/4 (108)	3-3/4 (96)	0.17	10	B	Polished Chrome	BP3705126
									2 Satin Nickel	BP37051G10
									3 Champagne Bronze	BP37051CZ
									Oil-Rubbed Bronze	BP37051ORB
									Matte Black	BP37051MB
7/16 (11)	7/16 (11)	1-1/16 (27)	5/8 (16)	5-1/2 (140)	5-1/16 (128)	0.20	10	B	Polished Chrome	BP3705226
									Satin Nickel	BP37052G10
									Champagne Bronze	BP37052CZ
									4 Oil-Rubbed Bronze	BP37052ORB
									Matte Black	BP37052MB
7/16 (11)	7/16 (11)	1 (25)	5/8 (16)	6-13/16 (173)	6-5/16 (160)	0.22	10	B	Polished Chrome	BP3705326
									Satin Nickel	BP37053G10
									Champagne Bronze	BP37053CZ
									Oil-Rubbed Bronze	BP37053ORB
									5 Matte Black	BP37053MB

Base Material: Zinc

Hardware Included: Truss Head Machine Screw(s): #8-32 x 1in • #8-32 x 1-1/2in





# Garfield

## AVAILABLE FINISHES

- Polished Chrome (26)
- Oil-Rubbed Bronze (ORB)
- Satin Nickel (G10)
- Matte Black (MB)
- Champagne Bronze (CZ)

## PRICE CODE BREAKDOWN • US Dollars

<b>A</b>	\$5 or less	<b>G</b>	>\$40 to \$50
<b>B</b>	>\$5 to \$10	<b>H</b>	>\$50 to \$75
<b>C</b>	>\$10 to \$15	<b>I</b>	>\$75 to \$100
<b>D</b>	>\$15 to \$20	<b>J</b>	>\$100 to \$150
<b>E</b>	>\$20 to \$30	<b>K</b>	>\$150 to \$200
<b>F</b>	>\$30 to \$40	<b>L</b>	>\$200

## KNOBS

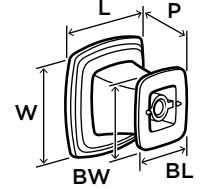

Part No.	Finish	Price Code	Shelf Pk Qty	Wt lbs	L in(mm)	W in(mm)	P in(mm)	BL in(mm)	BW in(mm)
<b>37020</b>	BP3702026	① Polished Chrome	10	0.12	1-3/16 (30)	1-3/16 (30)	1 (25)	3/4 (19)	3/4 (19)
	BP37020G10	② Satin Nickel							
	BP37020CZ	③ Champagne Bronze							
	BP37020ORB	④ Oil-Rubbed Bronze							
	BP37020MB	⑤ Matte Black							

Base Material: Zinc

Hardware Included: Truss Head Machine Screw(s): #8-32 x 1in • #8-32 x 1-1/2in



# Grail

## AVAILABLE FINISHES

- Polished Chrome (26)
- Satin Nickel (G10)
- Champagne Bronze (CZ)
- Matte Black (MB)

## KNOBS

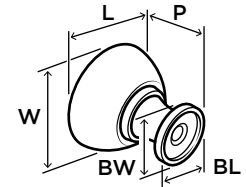

Part No.	Finish	Price Code	Shelf Pk Qty	Wt lbs	L in(mm)	W in(mm)	P in(mm)	BL in(mm)	BW in(mm)
<b>37330</b>	BP3733026	① Polished Chrome	10	0.18	1-5/16 (33)	1-5/16 (33)	1-5/16 (33)	11/16 (17)	11/16 (17)
	BP37330G10	② Satin Nickel							
	BP37330CZ	③ Champagne Bronze							
	BP37330MB	④ Matte Black							

Base Material: Zinc

Hardware Included: Truss Head Machine Screw(s): #8-32 x 1in • #8-32 x 1-1/2in



LEGEND			
L	Length	BL	Base Length
W	Width	BW	Base Width
P	Projection	CTC	Center-to-Center

Shown on p. 57-58

# Granby



## AVAILABLE FINISHES

- Polished Chrome (26)
- Champagne Bronze (CZ)
- Polished Nickel (PN)
- Oil-Rubbed Bronze (ORB)
- Satin Nickel (G10)
- Matte Black (FB)

## PULLS



**1**  
**53013**  
76mm CTC



**2**  
**53013**  
76mm CTC



**3**  
**53013**  
76mm CTC



**4**  
**55243**  
96mm CTC



**5**  
**55243**  
96mm CTC

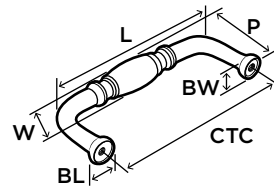

**6**  
**55243**  
96mm CTC

BW in(mm)	BL in(mm)	P in(mm)	W in(mm)	L in(mm)	CTC in(mm)	Wt lbs	Shelf Pk Qty	Price Code	Finish	Part No.
3/8 (10)	3/8 (10)	1-5/16 (33)	9/16 (14)	3-3/8 (86)	3 (76)	0.11	25	A	1 Polished Chrome	BP5301326
								A	2 Polished Nickel	BP53013PN
								A	3 Satin Nickel	BP53013G10
							10	A	Champagne Bronze	BP53013CZ
								A	Oil-Rubbed Bronze	BP53013ORB
								A	Matte Black	BP53013FB
7/16 (11)	7/16 (11)	1-7/16 (37)	5/8 (16)	4-3/16 (106)	3-3/4 (96)	0.16	25	B	Polished Chrome	BP5524326
								B	Polished Nickel	BP55243PN
								B	Satin Nickel	BP55243G10
							10	B	4 Champagne Bronze	BP55243CZ
								B	5 Oil-Rubbed Bronze	BP55243ORB
								B	6 Matte Black	BP55243FB
25	B									

53013

★ 55243

Base Material: Zinc

Hardware Included: Truss Head Machine Screw(s): #8-32 x 1in • #8-32 x 1-1/2in











### PRICE CODE BREAKDOWN US Dollars

<b>A</b>	\$5 or less
<b>B</b>	>\$5 to \$10
<b>C</b>	>\$10 to \$15
<b>D</b>	>\$15 to \$20
<b>E</b>	>\$20 to \$30
<b>F</b>	>\$30 to \$40
<b>G</b>	>\$40 to \$50
<b>H</b>	>\$50 to \$75
<b>I</b>	>\$75 to \$100
<b>J</b>	>\$100 to \$150
<b>K</b>	>\$150 to \$200
<b>L</b>	>\$200

## AVAILABLE FINISHES

-  Polished Chrome (26)
-  Satin Nickel (G10)
-  Oil-Rubbed Bronze (ORB)
-  Polished Nickel (PN)
-  Champagne Bronze (CZ)
-  Matte Black (FB)

## PULLS (cont'd)

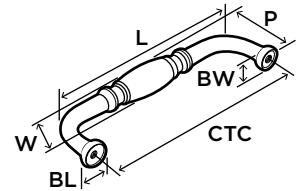

Part No.	Finish	Price Code	Shelf Pk Qty	Wt lbs	CTC in(mm)	L in(mm)	W in(mm)	P in(mm)	BL in(mm)	BW in(mm)
BP5524426	<b>1</b> Polished Chrome	<b>B</b>	10	0.27	5-1/16 (128)	5-9/16 (141)	3/4 (19)	1-9/16 (40)	1/2 (13)	1/2 (13)
BP55244PN	<b>2</b> Polished Nickel									
BP55244G10	<b>3</b> Satin Nickel									
BP55244CZ	Champagne Bronze									
BP55244ORB	Oil-Rubbed Bronze									
BP55244FB	Matte Black									
BP5524526	Polished Chrome	<b>C</b>	10	0.45	6-5/16 (160)	6-7/8 (175)	7/8 (22)	1-3/4 (44)	5/8 (16)	5/8 (16)
BP55245PN	Polished Nickel									
BP55245G10	Satin Nickel									
<b>BP55245CZ</b>	<b>4</b> Champagne Bronze									
BP55245ORB	<b>5</b> Oil-Rubbed Bronze									
BP55245FB	<b>6</b> Matte Black									







**Base Material:** Zinc  
**Hardware Included:** Truss Head Machine Screw(s): #8-32 x 1in • #8-32 x 1-1/2in

LEGEND			
L	Length	BL	Base Length
W	Width	BW	Base Width
P	Projection	CTC	Center-to-Center

# Hatfield



## AVAILABLE FINISHES

Polished Chrome (26)  Satin Nickel (G10)  Oil-Rubbed Bronze (ORB)  Matte Black (MB) 

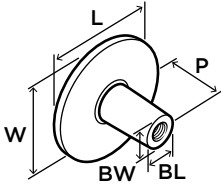

## KNOB



BW in(mm)	BL in(mm)	P in(mm)	W in(mm)	L in(mm)	Wt lbs	Shelf Pk Qty	Price Code	Finish	Part No.
5/16 (8)	5/16 (8)	7/8 (22)	1-1/4 (32)	1-1/4 (32)	0.08	10	A	1 Polished Chrome	BP2911326
						25	A	2 Satin Nickel	BP29113G10
							A	3 Oil-Rubbed Bronze	BP29113ORB
						10	A	4 Matte Black	BP29113MB

29113





**Base Material:** Zinc

**Hardware Included:** Truss Head Machine Screw(s): #8-32 x 1in • #8-32 x 1-1/2in

# Haven



## AVAILABLE FINISHES

Polished Chrome (26)  Satin Nickel (G10)  Oil-Rubbed Bronze (ORB)   
 Champagne Bronze (CZ)  Matte Black (MB) 

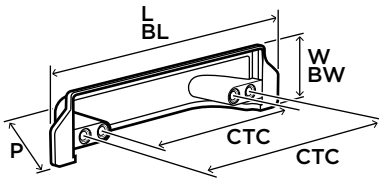

## CUP PULLS



BW in(mm)	BL in(mm)	P in(mm)	W in(mm)	L in(mm)	CTC in(mm)	Wt lbs	Shelf Pk Qty	Price Code	Finish	Part No.
1-1/16 (27)	5-1/16 (128)	1 (25)	1-1/16 (27)	5-1/16 (128)	3 & 3-3/4 (76 & 96)	0.22	10	B	1 Polished Chrome	BP3718026
									Satin Nickel	BP37180G10
									2 Champagne Bronze	BP37180CZ
									Oil-Rubbed Bronze	BP37180ORB
									Matte Black	BP37180MB

37180

**Base Material:** Zinc

**Hardware Included:** Truss Head Machine Screw(s): #8-32 x 1in • #8-32 x 1-1/2in



# Hybridize

## AVAILABLE FINISHES

- Polished Chrome (26)
- Champagne Bronze (CZ)
- Matte Black (MB)
- Satin Nickel (G10)
- Oil-Rubbed Bronze (ORB)

## PULLS

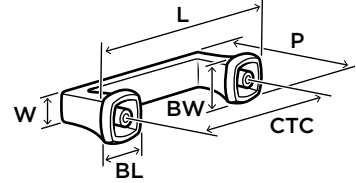

## PRICE CODE BREAKDOWN

US Dollars

<b>A</b>	\$5 or less
<b>B</b>	>\$5 to \$10
<b>C</b>	>\$10 to \$15
<b>D</b>	>\$15 to \$20
<b>E</b>	>\$20 to \$30
<b>F</b>	>\$30 to \$40
<b>G</b>	>\$40 to \$50
<b>H</b>	>\$50 to \$75
<b>I</b>	>\$75 to \$100
<b>J</b>	>\$100 to \$150
<b>K</b>	>\$150 to \$200
<b>L</b>	>\$200

Part No.	Finish	Price Code	Shelf Pk Qty	Wt lbs	CTC in(mm)	L in(mm)	W in(mm)	P in(mm)	BL in(mm)	BW in(mm)
<b>37060</b>	<b>BP3706026</b> ① Polished Chrome	<b>B</b>	10	0.23	3 (76)	3-3/4 (96)	7/16 (11)	1-3/16 (30)	3/4 (19)	3/4 (19)
	BP37060G10 Satin Nickel									
	BP37060CZ Champagne Bronze									
	BP37060ORB Oil-Rubbed Bronze									
	BP37060MB Matte Black									
<b>37061</b>	BP3706126 Polished Chrome	<b>B</b>	10	0.29	3-3/4 (96)	4-9/16 (116)	7/16 (11)	1-3/16 (30)	3/4 (19)	3/4 (19)
	<b>BP37061G10</b> ② Satin Nickel									
	<b>BP37061CZ</b> ③ Champagne Bronze									
	BP37061ORB Oil-Rubbed Bronze									
	BP37061MB Matte Black									
<b>37062</b>	BP3706226 Polished Chrome	<b>B</b>	10	0.30	5-1/16 (128)	5-13/16 (148)	7/16 (11)	1-3/16 (30)	3/4 (19)	3/4 (19)
	BP37062G10 Satin Nickel									
	BP37062CZ Champagne Bronze									
	<b>BP37062ORB</b> ④ Oil-Rubbed Bronze									
	BP37062MB Matte Black									
<b>37063</b>	BP3706326 Polished Chrome	<b>B</b>	10	0.34	6-5/16 (160)	7-1/16 (179)	7/16 (11)	1-3/16 (30)	3/4 (19)	3/4 (19)
	BP37063G10 Satin Nickel									
	BP37063CZ Champagne Bronze									
	BP37063ORB Oil-Rubbed Bronze									
	<b>BP37063MB</b> ⑤ Matte Black									



Base Material: Zinc  
 Hardware Included: Truss Head Machine Screw(s): #8-32 x 1in • #8-32 x 1-1/2in

LEGEND			
L	Length	BL	Base Length
W	Width	BW	Base Width
P	Projection	CTC	Center-to-Center



## AVAILABLE FINISHES

Polished Chrome (26) 

Satin Nickel (G10) 

Oil-Rubbed Bronze (ORB) 

Champagne Bronze (CZ) 

Matte Black (MB) 

## PULLS



**1**  
**37120**  
76mm CTC



**2**  
**37121**  
96mm CTC



**3**  
**37121**  
96mm CTC

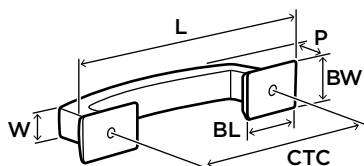

**4**  
**37122**  
128mm CTC



**5**  
**37123**  
160mm CTC

BW in(mm)	BL in(mm)	P in(mm)	W in(mm)	L in(mm)	CTC in(mm)	Wt lbs	Shelf Pk Qty	Price Code	Finish	Part No.
5/8 (16)	15/16 (24)	1-3/16 (30)	3/8 (10)	3-15/16 (100)	3 (76)	0.21	10	B	<b>1 Polished Chrome</b>	BP3712026
									Satin Nickel	BP37120G10
									Champagne Bronze	BP37120CZ
									Oil-Rubbed Bronze	BP37120ORB
									Matte Black	BP37120MB
5/8 (16)	15/16 (24)	1-3/16 (30)	3/8 (10)	4-11/16 (119)	3-3/4 (96)	0.24	10	B	Polished Chrome	BP3712126
									<b>2 Satin Nickel</b>	BP37121G10
									<b>3 Champagne Bronze</b>	BP37121CZ
									Oil-Rubbed Bronze	BP37121ORB
									Matte Black	BP37121MB
5/8 (16)	15/16 (24)	1-3/16 (30)	3/8 (10)	6 (152)	5-1/16 (128)	0.28	10	B	Polished Chrome	BP3712226
									Satin Nickel	BP37122G10
									Champagne Bronze	BP37122CZ
									<b>4 Oil-Rubbed Bronze</b>	BP37122ORB
									Matte Black	BP37122MB
5/8 (16)	15/16 (24)	1-3/16 (30)	3/8 (10)	7-1/4 (184)	6-5/16 (160)	0.32	10	B	Polished Chrome	BP3712326
									Satin Nickel	BP37123G10
									Champagne Bronze	BP37123CZ
									Oil-Rubbed Bronze	BP37123ORB
									<b>5 Matte Black</b>	BP37123MB

37120

★ 37121

★ 37122

★ 37123

Base Material: Zinc

Hardware Included: Truss Head Machine Screw(s): #8-32 x 1in • #8-32 x 1-1/2in





PRICE CODE BREAKDOWN • US Dollars			
<b>A</b>	\$5 or less	<b>G</b>	>\$40 to \$50
<b>B</b>	>\$5 to \$10	<b>H</b>	>\$50 to \$75
<b>C</b>	>\$10 to \$15	<b>I</b>	>\$75 to \$100
<b>D</b>	>\$15 to \$20	<b>J</b>	>\$100 to \$150
<b>E</b>	>\$20 to \$30	<b>K</b>	>\$150 to \$200
<b>F</b>	>\$30 to \$40	<b>L</b>	>\$200

## AVAILABLE FINISHES

- Polished Chrome (26)
- Oil-Rubbed Bronze (ORB)
- Satin Nickel (G10)
- Matte Black (FB)
- Champagne Bronze (CZ)

## KNOBS



	Part No.	Finish	Price Code	Shelf Pk Qty	Wt lbs	L in(mm)	W in(mm)	P in(mm)	BL in(mm)	BW in(mm)
<b>1586</b>	BP158626	① Polished Chrome	<b>B</b>	10	0.12	1-5/16 (33)	1-5/16 (33)	1 (25)	3/4 (19)	3/4 (19)
	BP1586G10	② Satin Nickel	<b>B</b>	25						
	BP1586CZ	③ Champagne Bronze	<b>B</b>	10						
	BP1586ORB	Oil-Rubbed Bronze	<b>B</b>	25						
	BP1586FB	Matte Black								
<b>15862</b>	BP1586226 <sup>†</sup>	Polished Chrome	<b>C</b>	10	0.28	1-3/4 (44)	1-3/4 (44)	1-5/16 (33)	1 (25)	1 (25)
	BP15862G10	Satin Nickel								
	BP15862CZ	Champagne Bronze								
	BP15862ORB	④ Oil-Rubbed Bronze								
	BP15862FB	⑤ Matte Black								

<sup>†</sup> Coming Soon • Base Material: Zinc

Hardware Included: Truss Head Machine Screw(s): #8-32 x 1in • #8-32 x 1-1/2in

## FINGER PULLS



	Part No.	Finish	Price Code	Shelf Pk Qty	Wt lbs	L in(mm)	W in(mm)	P in(mm)	BL in(mm)	BW in(mm)
<b>1593</b>	BP159326 <sup>†</sup>	① Polished Chrome	<b>B</b>	10	0.16	1-7/8 (48)	1-1/16 (27)	1-1/16 (27)	1-7/8 (48)	1-1/16 (27)
	BP1593G10	② Satin Nickel								
	BP1593CZ	③ Champagne Bronze								
	BP1593ORB	④ Oil-Rubbed Bronze								
	BP1593FB	⑤ Matte Black								

<sup>†</sup> Coming Soon • Base Material: Zinc

Hardware Included: Truss Head Machine Screw(s): #8-32 x 1in • #8-32 x 1-1/2in

LEGEND			
L	Length	BL	Base Length
W	Width	BW	Base Width
P	Projection	CTC	Center-to-Center

Shown on p. 62-64

# Inspirations



## AVAILABLE FINISHES

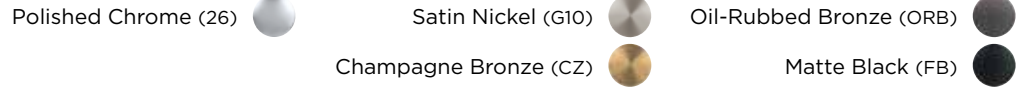

## PULLS

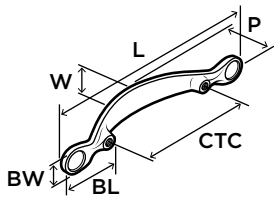

BW in(mm)	BL in(mm)	P in(mm)	W in(mm)	L in(mm)	CTC in(mm)	Wt lbs	Shelf Pk Qty	Price Code	Finish	Part No.
5/8 (16)	1-7/16 (37)	1 (25)	11/16 (17)	5-1/2 (140)	3 (76)	0.18	10	B	1 Polished Chrome	BP159026
									Satin Nickel	BP1590G10
								B	Champagne Bronze	BP1590CZ
									Oil-Rubbed Bronze	BP1590ORB
									Matte Black	BP1590FB
5/8 (16)	1-3/8 (35)	1-1/16 (27)	11/16 (17)	6-1/4 (159)	3-3/4 (96)	0.19	10	B	Polished Chrome	BP158726
									2 Satin Nickel	BP1587G10
								B	3 Champagne Bronze	BP1587CZ
									Oil-Rubbed Bronze	BP1587ORB
									Matte Black	BP1587FB
11/16 (17)	1-3/8 (35)	1-1/8 (29)	3/4 (19)	7-1/2 (191)	5-1/16 (128)	0.27	10	B	Polished Chrome	BP158826
									Satin Nickel	BP1588G10
									Champagne Bronze	BP1588CZ
								B	4 Oil-Rubbed Bronze	BP1588ORB
									Matte Black	BP1588FB
11/16 (17)	1-5/16 (33)	1-3/16 (30)	3/4 (19)	8-5/8 (219)	6-5/16 (160)	0.29	10	C	Polished Chrome	BP158926†
									Satin Nickel	BP1589G10†
									Champagne Bronze	BP1589CZ†
									Oil-Rubbed Bronze	BP1589ORB†
									5 Matte Black	BP1589FB†

† Coming Soon • Base Material: Zinc

Hardware Included: Truss Head Machine Screw(s): #8-32 x 1in • #8-32 x 1-1/2in





# Inspirations

Shown on p. 62-64

## PRICE CODE BREAKDOWN US Dollars

A	\$5 or less
B	>\$5 to \$10
C	>\$10 to \$15
D	>\$15 to \$20
E	>\$20 to \$30
F	>\$30 to \$40
G	>\$40 to \$50
H	>\$50 to \$75
I	>\$75 to \$100
J	>\$100 to \$150
K	>\$150 to \$200
L	>\$200

## AVAILABLE FINISHES

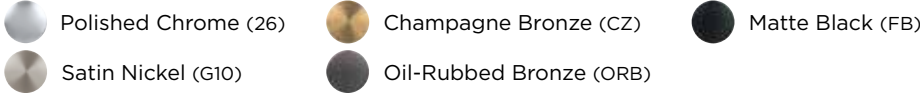

## CUP PULLS

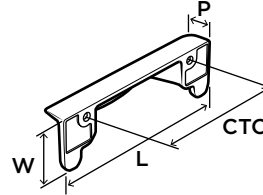

Part No.	Finish	Price Code	Shelf Pk Qty	Wt lbs	CTC in(mm)	L in(mm)	W in(mm)	P in(mm)	BL in(mm)	BW in(mm)
BP159226 <sup>†</sup>	Polished Chrome	C	10	0.32	3 (76)	4-1/4 (108)	1-5/16 (33)	1 (25)	4-1/4 (108)	1-5/16 (33)
BP1592G10	1 Satin Nickel									
BP1592CZ	Champagne Bronze									
BP1592ORB	Oil-Rubbed Bronze									
BP1592FB	2 Matte Black									

<sup>†</sup> Coming Soon • Base Material: Zinc

Hardware Included: Truss Head Machine Screw(s): #8-32 x 1in • #8-32 x 1-1/2in



# Intersect

## AVAILABLE FINISHES



## KNOBS

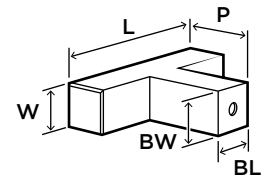

Part No.	Finish	Price Code	Shelf Pk Qty	Wt lbs	L in(mm)	W in(mm)	P in(mm)	BL in(mm)	BW in(mm)
BP3702726	1 Polished Chrome	A	10	0.16	1-15/16 (49)	7/16 (11)	1-3/8 (35)	7/16 (11)	7/16 (11)
BP37027G10	2 Satin Nickel								
BP37027CZ	3 Champagne Bronze								
BP37027MB	4 Matte Black								

Base Material: Zinc

Hardware Included: Truss Head Machine Screw(s): #8-32 x 1in • #8-32 x 1-1/2in



LEGEND			
L	Length	BL	Base Length
W	Width	BW	Base Width
P	Projection	CTC	Center-to-Center



## AVAILABLE FINISHES

Polished Chrome (26) 

Satin Nickel (G10) 

Oil-Rubbed Bronze (ORB) 

Champagne Bronze (CZ) 

Matte Black (FB) 

## PULLS



BW in(mm)	BL in(mm)	P in(mm)	W in(mm)	L in(mm)	CTC in(mm)	Wt lbs	Shelf Pk Qty	Price Code	Finish	Part No.
9/16 (14)	15/16 (24)	15/16 (24)	9/16 (14)	4-1/2 (114)	3 (76)	0.06	10	A	1 Polished Chrome	BP2117126
									Satin Nickel	BP21171G10
									Champagne Bronze	BP21171CZ
									Oil-Rubbed Bronze	BP21171ORB
									Matte Black	BP21171FB
9/16 (14)	15/16 (24)	1 (25)	1/2 (13)	5-5/16 (135)	3-3/4 (96)	0.07	10	B	Polished Chrome	BP2117226
									2 Satin Nickel	BP21172G10
									3 Champagne Bronze	BP21172CZ
									Oil-Rubbed Bronze	BP21172ORB
									Matte Black	BP21172FB
9/16 (14)	15/16 (24)	1 (25)	1/2 (13)	6-9/16 (167)	5-1/16 (128)	0.08	10	B	Polished Chrome	BP2117326
									Satin Nickel	BP21173G10
									Champagne Bronze	BP21173CZ
									4 Oil-Rubbed Bronze	BP21173ORB
									Matte Black	BP21173FB
9/16 (14)	15/16 (24)	1-1/16 (27)	1/2 (13)	7-13/16 (198)	6-5/16 (160)	0.09	10	B	Polished Chrome	BP2117426
									Satin Nickel	BP21174G10
									Champagne Bronze	BP21174CZ
									Oil-Rubbed Bronze	BP21174ORB
									5 Matte Black	BP21174FB

Base Material: Aluminum

Hardware Included: Truss Head Machine Screw(s): #8-32 x 1in • #8-32 x 1-1/2in





# Loop

## AVAILABLE FINISHES

- Polished Chrome (26)
- Oil-Rubbed Bronze (ORB)
- Satin Nickel (G10)
- Matte Black (MB)
- Champagne Bronze (CZ)

PRICE CODE BREAKDOWN • US Dollars			
<b>A</b>	\$5 or less	<b>G</b>	>\$40 to \$50
<b>B</b>	>\$5 to \$10	<b>H</b>	>\$50 to \$75
<b>C</b>	>\$10 to \$15	<b>I</b>	>\$75 to \$100
<b>D</b>	>\$15 to \$20	<b>J</b>	>\$100 to \$150
<b>E</b>	>\$20 to \$30	<b>K</b>	>\$150 to \$200
<b>F</b>	>\$30 to \$40	<b>L</b>	>\$200

## KNOBS

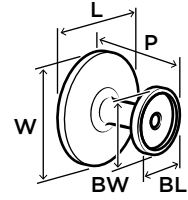

Part No.	Finish	Price Code	Shelf Pk Qty	Wt lbs	L in(mm)	W in(mm)	P in(mm)	BL in(mm)	BW in(mm)	
<b>37025</b>	BP3702526	1 Polished Chrome	A	10	0.08	1-3/16 (30)	1-3/16 (30)	1 (25)	11/16 (17)	11/16 (17)
	BP37025G10	2 Satin Nickel								
	BP37025CZ	3 Champagne Bronze								
	BP37025ORB	4 Oil-Rubbed Bronze								
	BP37025MB	5 Matte Black								

Base Material: Zinc

Hardware Included: Truss Head Machine Screw(s): #8-32 x 1in • #8-32 x 1-1/2in



# Metro

Shown on p. 66-68

## AVAILABLE FINISHES

- Polished Chrome (26)
- Satin Nickel (G10)
- Champagne Bronze (CZ)
- Matte Black (MB)

## PULLS

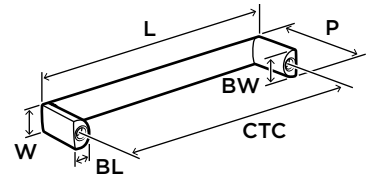

Part No.	Finish	Price Code	Shelf Pk Qty	Wt lbs	CTC in(mm)	L in(mm)	W in(mm)	P in(mm)	BL in(mm)	BW in(mm)
<b>37289+</b>	BP3728926+	1 Polished Chrome	B	10	3 (76)	3-3/16 (81)	7/16 (11)	13/16 (21)	1/4 (6)	7/16 (11)
	BP37289G10+	Satin Nickel								
	BP37289CZ+	2 Champagne Bronze								
	BP37289MB+	3 Matte Black								

+ Coming Soon • Base Material: Zinc

Hardware Included: Truss Head Machine Screw(s): #8-32 x 1in • #8-32 x 1-1/2in

LEGEND			
L	Length	BL	Base Length
W	Width	BW	Base Width
P	Projection	CTC	Center-to-Center

Shown on p. 66-68

Metro



AVAILABLE FINISHES

- Polished Chrome (26)
- Champagne Bronze (CZ)
- Satin Nickel (G10)
- Matte Black (MB)

PULLS (cont'd)



1  
37290  
96mm CTC



2  
37290  
96mm CTC



3  
37291  
128mm CTC



4  
37292  
160mm CTC

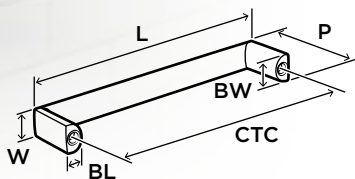

BW in(mm)	BL in(mm)	P in(mm)	W in(mm)	L in(mm)	CTC in(mm)	Wt lbs	Shelf Pk Qty	Price Code	Finish	Part No.
7/16 (11)	1/4 (6)	13/16 (21)	7/16 (11)	4 (102)	3-3/4 (96)	0.10	10	B	1 Polished Chrome	BP3729026
									2 Satin Nickel	BP37290G10
									Champagne Bronze	BP37290CZ
									Matte Black	BP37290MB
7/16 (11)	1/4 (6)	13/16 (21)	7/16 (11)	5-5/16 (135)	5-1/16 (128)	0.12	10	B	Polished Chrome	BP3729126
									Satin Nickel	BP37291G10
									3 Champagne Bronze	BP37291CZ
									Matte Black	BP37291MB
7/16 (11)	1/4 (6)	13/16 (21)	7/16 (11)	6-1/2 (165)	6-5/16 (160)	0.14	10	B	Polished Chrome	BP3729226
									Satin Nickel	BP37292G10
									Champagne Bronze	BP37292CZ
									4 Matte Black	BP37292MB

37290

37291

37292

Base Material: Zinc  
 Hardware Included: Truss Head Machine Screw(s): #8-32 x 1in • #8-32 x 1-1/2in



## AVAILABLE FINISHES

- Polished Chrome (26)
- Champagne Bronze (CZ)
- Satin Nickel (G10)
- Matte Black (MB)

PRICE CODE BREAKDOWN • US Dollars			
<b>A</b>	\$5 or less	<b>G</b>	>\$40 to \$50
<b>B</b>	>\$5 to \$10	<b>H</b>	>\$50 to \$75
<b>C</b>	>\$10 to \$15	<b>I</b>	>\$75 to \$100
<b>D</b>	>\$15 to \$20	<b>J</b>	>\$100 to \$150
<b>E</b>	>\$20 to \$30	<b>K</b>	>\$150 to \$200
<b>F</b>	>\$30 to \$40	<b>L</b>	>\$200

## PULLS (cont'd)

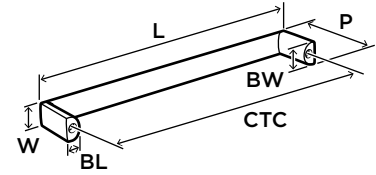

Part No.	Finish	Price Code	Shelf Pk Qty	Wt lbs	CTC in(mm)	L in(mm)	W in(mm)	P in(mm)	BL in(mm)	BW in(mm)
<b>37293</b>	BP3729326	<b>1</b> Polished Chrome	10	0.17	7-9/16 (192)	7-13/16 (198)	7/16 (11)	7/8 (22)	1/4 (6)	7/16 (11)
	BP37293G10	<b>2</b> Satin Nickel								
	BP37293CZ	Champagne Bronze								
	BP37293MB	Matte Black								
<b>37294</b>	BP3729426	Polished Chrome	10	0.20	8-13/16 (224)	9-1/16 (230)	7/16 (11)	7/8 (22)	1/4 (6)	7/16 (11)
	BP37294G10	Satin Nickel								
	BP37294CZ	<b>3</b> Champagne Bronze								
	BP37294MB	<b>4</b> Matte Black								

Base Material: Zinc

Hardware Included: Truss Head Machine Screw(s): #8-32 x 1in • #8-32 x 1-1/2in

LEGEND			
L	Length	BL	Base Length
W	Width	BW	Base Width
P	Projection	CTC	Center-to-Center

Shown on p. 69-74

# Monument



## AVAILABLE FINISHES

- Polished Chrome (26) Polished Nickel (PN) Golden Champagne (BBZ) Oil-Rubbed Bronze (ORB)   
 Satin Nickel (G10) Champagne Bronze (CZ) Matte Black (FB)

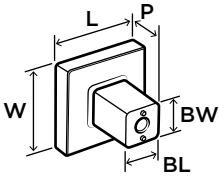

## KNOB

BW in(mm)	BL in(mm)	P in(mm)	W in(mm)	L in(mm)	Wt lbs	Shelf Pk Qty	Price Code	Finish	Part No.
1/2 (13)	1/2 (13)	1 (25)	1-3/16 (30)	1-3/16 (30)	0.15	25	B	<ul style="list-style-type: none"> <li>1 Polished Chrome</li> <li>2 Polished Nickel</li> <li>3 Satin Nickel</li> <li>4 Golden Champagne</li> <li>5 Champagne Bronze</li> <li>6 Oil-Rubbed Bronze</li> <li>7 Matte Black</li> </ul>	<ul style="list-style-type: none"> <li>BP3690526</li> <li>BP36905PN</li> <li>BP36905G10</li> <li>BP36905BBZ</li> <li>BP36905CZ</li> <li>BP36905ORB</li> <li>BP36905FB</li> </ul>

36905

Base Material: Zinc

Hardware Included: Truss Head Machine Screw(s): #8-32 x 1in • #8-32 x 1-1/2in

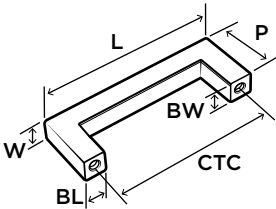

## PULLS

BW in(mm)	BL in(mm)	P in(mm)	W in(mm)	L in(mm)	CTC in(mm)	Wt lbs	Shelf Pk Qty	Price Code	Finish	Part No.
3/8 (10)	3/8 (10)	1-3/16 (30)	3/8 (10)	3-3/8 (86)	3 (76)	0.12	25	<ul style="list-style-type: none"> <li>A Polished Chrome</li> <li>1 Polished Nickel</li> <li>Satin Nickel</li> <li>B 2 Golden Champagne</li> <li>Champagne Bronze</li> <li>A Oil-Rubbed Bronze</li> <li>3 Matte Black</li> </ul>	<ul style="list-style-type: none"> <li>BP3657826</li> <li>BP36578PN</li> <li>BP36578G10</li> <li>BP36578BBZ</li> <li>BP36578CZ</li> <li>BP36578ORB</li> <li>BP36578FB</li> </ul>	

36578

Base Material: Aluminum

Hardware Included: Truss Head Machine Screw(s): #8-32 x 1in • #8-32 x 1-1/2in



# Monument

Shown on p. 69-74

## AVAILABLE FINISHES

-  Polished Chrome (26)
-  Polished Nickel (PN)
-  Satin Nickel (G10)
-  Golden Champagne (BBZ)
-  Champagne Bronze (CZ)
-  Oil-Rubbed Bronze (ORB)
-  Matte Black (FB)

PRICE CODE BREAKDOWN • US Dollars			
<b>A</b>	\$5 or less	<b>G</b>	>\$40 to \$50
<b>B</b>	>\$5 to \$10	<b>H</b>	>\$50 to \$75
<b>C</b>	>\$10 to \$15	<b>I</b>	>\$75 to \$100
<b>D</b>	>\$15 to \$20	<b>J</b>	>\$100 to \$150
<b>E</b>	>\$20 to \$30	<b>K</b>	>\$150 to \$200
<b>F</b>	>\$30 to \$40	<b>L</b>	>\$200

## PULLS (cont'd)

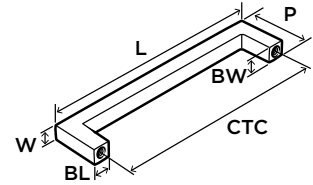

Part No.	Finish	Price Code	Shelf Pk Qty	Wt lbs	CTC in(mm)	L in(mm)	W in(mm)	P in(mm)	BL in(mm)	BW in(mm)	
★ <b>36570</b>	BP3657026	<b>1</b> Polished Chrome	<b>B</b>	20	0.13	3-3/4 (96)	4-1/8 (105)	3/8 (10)	1-3/16 (30)	3/8 (10)	3/8 (10)
	BP36570PN	Polished Nickel									
	BP36570G10	<b>2</b> Satin Nickel									
	BP36570BBZ	<b>3</b> Golden Champagne									
	BP36570CZ	Champagne Bronze									
	BP36570ORB	Oil-Rubbed Bronze									
BP36570FB	Matte Black										
★ <b>36571</b>	BP3657126	Polished Chrome	<b>B</b>	20	5-1/16 (128)	5-7/16 (138)	3/8 (10)	1-3/16 (30)	3/8 (10)	3/8 (10)	
	BP36571PN	Polished Nickel									
	BP36571G10	Satin Nickel									
	BP36571BBZ	Golden Champagne									
	BP36571CZ	<b>4</b> Champagne Bronze									
	BP36571ORB	<b>5</b> Oil-Rubbed Bronze									
BP36571FB	Matte Black										



Base Material: Aluminum

Hardware Included: Truss Head Machine Screw(s): #8-32 x 1in • #8-32 x 1-1/2in

LEGEND			
L	Length	BL	Base Length
W	Width	BW	Base Width
P	Projection	CTC	Center-to-Center

Shown on p. 69-74

# Monument



## AVAILABLE FINISHES

- Polished Chrome (26)
- Polished Nickel (PN)
- Satin Nickel (G10)
- Golden Champagne (BBZ)
- Champagne Bronze (CZ)
- Oil-Rubbed Bronze (ORB)
- Matte Black (FB)

## PULLS (cont'd)



**1**  
**36572**  
160mm CTC



**2**  
**36572**  
160mm CTC



**3**  
**36908**  
192mm CTC

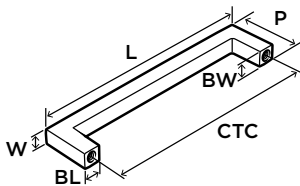

BW in(mm)	BL in(mm)	P in(mm)	W in(mm)	L in(mm)	CTC in(mm)	Wt lbs	Shelf Pk Qty	Price Code	Finish	Part No.
3/8 (10)	3/8 (10)	1-3/16 (30)	3/8 (10)	6-11/16 (170)	6-5/16 (160)	0.17	25	B	Polished Chrome	BP3657226
									<b>1 Polished Nickel</b>	<b>BP36572PN</b>
									Satin Nickel	BP36572G10
									<b>2 Golden Champagne</b>	<b>BP36572BBZ</b>
									Champagne Bronze	BP36572CZ
									Oil-Rubbed Bronze	BP36572ORB
									Matte Black	BP36572FB
3/8 (10)	3/8 (10)	1-3/16 (30)	3/8 (10)	7-15/16 (202)	7-9/16 (192)	0.19	10	B	Polished Chrome	BP3690826
									Polished Nickel	BP36908PN
									Satin Nickel	BP36908G10
									Golden Champagne	BP36908BBZ
									Champagne Bronze	BP36908CZ
									Oil-Rubbed Bronze	BP36908ORB
									<b>3 Matte Black</b>	<b>BP36908FB</b>

★ 36572

★ 36908

Base Material: Aluminum

Hardware Included: Truss Head Machine Screw(s): #8-32 x 1in • #8-32 x 1-1/2in





# Monument

Shown on p. 69-74

## AVAILABLE FINISHES

- Polished Chrome (26)
- Polished Nickel (PN)
- Satin Nickel (G10)
- Golden Champagne (BBZ)
- Champagne Bronze (CZ)
- Oil-Rubbed Bronze (ORB)
- Matte Black (FB)

PRICE CODE BREAKDOWN • US Dollars			
<b>A</b>	\$5 or less	<b>G</b>	>\$40 to \$50
<b>B</b>	>\$5 to \$10	<b>H</b>	>\$50 to \$75
<b>C</b>	>\$10 to \$15	<b>I</b>	>\$75 to \$100
<b>D</b>	>\$15 to \$20	<b>J</b>	>\$100 to \$150
<b>E</b>	>\$20 to \$30	<b>K</b>	>\$150 to \$200
<b>F</b>	>\$30 to \$40	<b>L</b>	>\$200

## PULLS (cont'd)

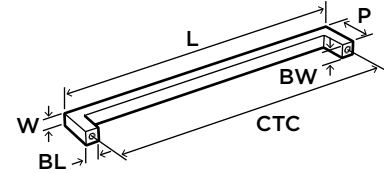

Part No.	Finish	Price Code	Shelf Pk Qty	Wt lbs	CTC in(mm)	L in(mm)	W in(mm)	P in(mm)	BL in(mm)	BW in(mm)
BP3690926	Polished Chrome									
<b>BP36909PN</b>	<b>1 Polished Nickel</b>	<b>B</b>								
BP36909G10	Satin Nickel									
<b>BP36909BBZ</b>	<b>2 Golden Champagne</b>	<b>D</b>	10	0.20	8-13/16 (224)	9-3/16 (233)	3/8 (10)	1-3/16 (30)	3/8 (10)	3/8 (10)
BP36909CZ	Champagne Bronze									
BP36909ORB	Oil-Rubbed Bronze	<b>B</b>								
BP36909FB	Matte Black									
BP3691026	Polished Chrome									
BP36910PN	Polished Nickel									
BP36910G10	Satin Nickel									
<b>BP36910BBZ</b>	<b>Golden Champagne</b>	<b>D</b>	10	0.24	10-1/16 (256)	10-7/16 (265)	3/8 (10)	1-3/16 (30)	3/8 (10)	3/8 (10)
BP36910CZ	Champagne Bronze									
BP36910ORB	Oil-Rubbed Bronze									
<b>BP36910FB</b>	<b>3 Matte Black</b>									



Base Material: **36909**: Aluminum; **36910**: Zinc

Hardware Included: Truss Head Machine Screw(s): #8-32 x 1in • #8-32 x 1-1/2in



LEGEND			
L	Length	BL	Base Length
W	Width	BW	Base Width
P	Projection	CTC	Center-to-Center

Shown on p. 69-74

# Monument



## AVAILABLE FINISHES

- Polished Chrome (26) Golden Champagne (BBZ)
- Polished Nickel (PN) Champagne Bronze (CZ)
- Satin Nickel (G10) Oil-Rubbed Bronze (ORB)
- Matte Black (FB)



## PULLS (cont'd)

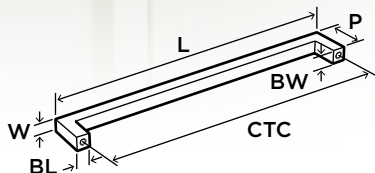

BW in(mm)	BL in(mm)	P in(mm)	W in(mm)	L in(mm)	CTC in(mm)	Wt lbs	Shelf Pk Qty	Price Code	Finish	Part No.
7/16 (11)	7/16 (11)	1-3/16 (30)	3/8 (10)	13 (330)	12-5/8 (320)	0.26	10	<b>E</b>	<b>1 Polished Chrome</b> Polished Nickel Satin Nickel Golden Champagne	<b>BP3691126</b> BP36911PN BP36911G10 BP36911BBZ
									<b>2 Champagne Bronze</b> <b>3 Oil-Rubbed Bronze</b> Matte Black	<b>BP36911CZ</b> <b>BP36911ORB</b> BP36911FB

★ 36911

**Base Material:** Aluminum

**Hardware Included:** Truss Head Machine Screw(s): #8-32 x 1in • #8-32 x 1-1/2in





# Monument

Shown on p. 69-74

### PRICE CODE BREAKDOWN US Dollars

<b>A</b>	\$5 or less
<b>B</b>	>\$5 to \$10
<b>C</b>	>\$10 to \$15
<b>D</b>	>\$15 to \$20
<b>E</b>	>\$20 to \$30
<b>F</b>	>\$30 to \$40
<b>G</b>	>\$40 to \$50
<b>H</b>	>\$50 to \$75
<b>I</b>	>\$75 to \$100
<b>J</b>	>\$100 to \$150
<b>K</b>	>\$150 to \$200
<b>L</b>	>\$200

## AVAILABLE FINISHES

- Polished Chrome (26)
- Golden Champagne (BBZ)
- Oil-Rubbed Bronze (ORB)
- Polished Nickel (PN)
- Champagne Bronze (CZ)
- Matte Black (FB)
- Satin Nickel (G10)

## APPLIANCE PULLS

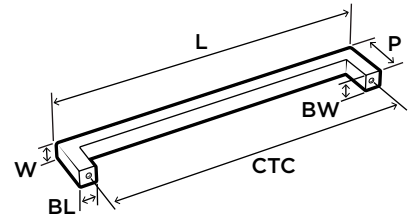
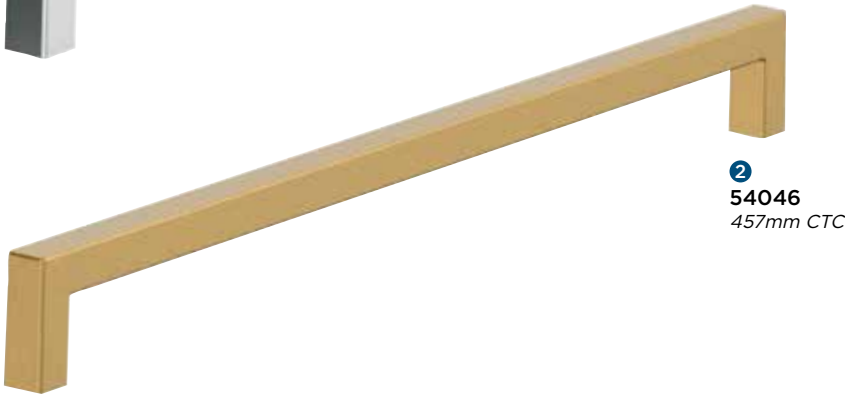

Part No.	Finish	Price Code	Shelf Pk Qty	Wt lbs	CTC in(mm)	L in(mm)	W in(mm)	P in(mm)	BL in(mm)	BW in(mm)
<b>BP5404526</b>	<b>1 Polished Chrome</b>	<b>J</b>	1	1.50	12 (305)	12-11/16 (322)	5/8 (16)	1-15/16 (49)	5/8 (16)	11/16 (17)
BP54045PN	Polished Nickel									
BP54045G10	Satin Nickel									
BP54045BBZ	Golden Champagne									
BP54045CZ	Champagne Bronze									
BP54045ORB	Oil-Rubbed Bronze									
BP54045FB	Matte Black									
<b>BP5404626</b>	Polished Chrome	<b>K</b>	1	1.85	18 (457)	18-11/16 (475)	5/8 (16)	1-15/16 (49)	5/8 (16)	11/16 (17)
BP54046PN	Polished Nickel									
BP54046G10	Satin Nickel									
BP54046BBZ	Golden Champagne									
<b>BP54046CZ</b>	<b>2 Champagne Bronze</b>									
BP54046ORB	Oil-Rubbed Bronze									
BP54046FB	Matte Black									

★ 54045

★ 54046



Base Material: Zinc

Hardware Included: Washers & Truss Head Machine Screw(s):

#10-24 x 3/4in • #10-24 x 1in • #10-24 x 1-1/4in • #10-24 x 1-1/2in • #10-24 x 1-3/4in • #10-24 x 2-1/8in

LEGEND			
L	Length	BL	Base Length
W	Width	BW	Base Width
P	Projection	CTC	Center-to-Center



## AVAILABLE FINISHES

Polished Chrome (26)



Satin Nickel (G10)



Champagne Bronze (CZ)



Matte Black (MB)



## PULLS



1  
37322  
96mm CTC



2  
37323  
128mm CTC



3  
37323  
128mm CTC



4  
37324  
160mm CTC

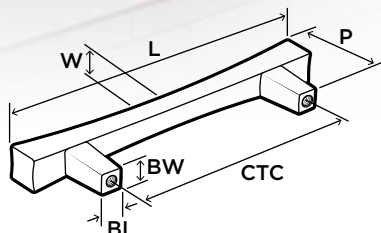

BW in(mm)	BL in(mm)	P in(mm)	W in(mm)	L in(mm)	CTC in(mm)	Wt lbs	Shelf Pk Qty	Price Code	Finish	Part No.
5/16 (8)	5/16 (8)	1-1/4 (32)	5/16 (8)	5-5/16 (135)	3-3/4 (96)	0.25	10	B	1 Polished Chrome	BP3732226
									Satin Nickel	BP37322G10
									Champagne Bronze	BP37322CZ
									Matte Black	BP37322MB
5/16 (8)	5/16 (8)	1-1/4 (32)	5/16 (8)	6-9/16 (167)	5-1/16 (128)	0.29	10	B	Polished Chrome	BP3732326
									2 Satin Nickel	BP37323G10
									3 Champagne Bronze	BP37323CZ
									Matte Black	BP37323MB
5/16 (8)	5/16 (8)	1-1/4 (32)	5/16 (8)	7-13/16 (198)	6-5/16 (160)	0.34	10	B	Polished Chrome	BP3732426
									Satin Nickel	BP37324G10
									Champagne Bronze	BP37324CZ
									4 Matte Black	BP37324MB

37322

37323

37324

Base Material: Zinc

Hardware Included: Truss Head Machine Screw(s): #8-32 x 1in • #8-32 x 1-1/2in



# Parabolic

## AVAILABLE FINISHES

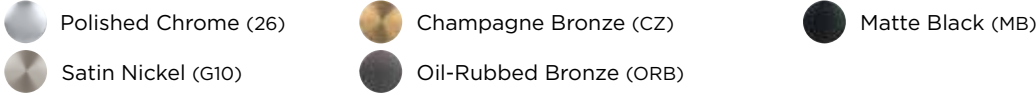

## PRICE CODE BREAKDOWN

US Dollars

A	\$5 or less
B	>\$5 to \$10
C	>\$10 to \$15
D	>\$15 to \$20
E	>\$20 to \$30
F	>\$30 to \$40
G	>\$40 to \$50
H	>\$50 to \$75
I	>\$75 to \$100
J	>\$100 to \$150
K	>\$150 to \$200
L	>\$200

## PULLS

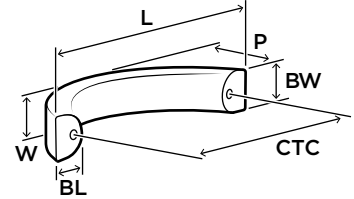

Part No.	Finish	Price Code	Shelf Pk Qty	Wt lbs	CTC in(mm)	L in(mm)	W in(mm)	P in(mm)	BL in(mm)	BW in(mm)	
★ 37345	BP3734526	① Polished Chrome	A	10	0.21	3 (76)	3-5/8 (92)	9/16 (14)	1-3/16 (30)	7/16 (11)	9/16 (14)
	BP37345G10	Satin Nickel									
	BP37345CZ	Champagne Bronze									
	BP37345ORB	Oil-Rubbed Bronze									
	BP37345MB	Matte Black									
★ 37346	BP3734626	Polished Chrome	B	10	0.24	3-3/4 (96)	4-1/2 (114)	9/16 (14)	1-3/16 (30)	7/16 (11)	9/16 (14)
	BP37346G10	② Satin Nickel									
	BP37346CZ	③ Champagne Bronze									
	BP37346ORB	Oil-Rubbed Bronze									
	BP37346MB	Matte Black									
★ 37347	BP3734726	Polished Chrome	B	10	0.33	5-1/16 (128)	5-7/8 (149)	9/16 (14)	1-3/16 (30)	7/16 (11)	9/16 (14)
	BP37347G10	Satin Nickel									
	BP37347CZ	Champagne Bronze									
	BP37347ORB	④ Oil-Rubbed Bronze									
	BP37347MB	Matte Black									
★ 37348+	BP3734826+	Polished Chrome	B	10	0.34	6-5/16 (160)	7-3/16 (183)	9/16 (14)	1-3/8 (35)	5/8 (16)	9/16 (14)
	BP37348G10+	Satin Nickel									
	BP37348CZ+	Champagne Bronze									
	BP37348ORB+	Oil-Rubbed Bronze									
	BP37348MB+	⑤ Matte Black									



+ Coming Soon • Base Material: Zinc

Hardware Included: Truss Head Machine Screw(s): #8-32 x 1in • #8-32 x 1-1/2in

LEGEND			
L	Length	BL	Base Length
W	Width	BW	Base Width
P	Projection	CTC	Center-to-Center

# Pedestal



## AVAILABLE FINISHES

Polished Chrome (26)

Satin Nickel (G10)

Oil-Rubbed Bronze (ORB)

Champagne Bronze (CZ)

Matte Black (MB)

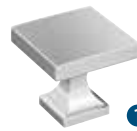
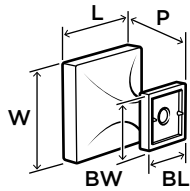

1  
37024

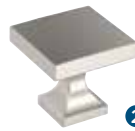

2

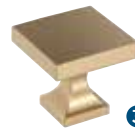

3

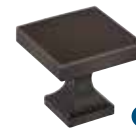

4

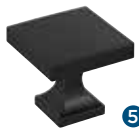

5

## KNOB

BW in(mm)	BL in(mm)	P in(mm)	W in(mm)	L in(mm)	Wt lbs	Shelf Pk Qty	Price Code	Finish	Part No.
5/8 (16)	5/8 (16)	1 (25)	1-1/16 (27)	1-1/16 (27)	0.10	10	A	<ul style="list-style-type: none"> <li>1 Polished Chrome</li> <li>2 Satin Nickel</li> <li>3 Champagne Bronze</li> <li>4 Oil-Rubbed Bronze</li> <li>5 Matte Black</li> </ul>	<ul style="list-style-type: none"> <li>BP3702426</li> <li>BP37024G10</li> <li>BP37024CZ</li> <li>BP37024ORB</li> <li>BP37024MB</li> </ul>

37024

Base Material: Zinc

Hardware Included: Truss Head Machine Screw(s): #8-32 x 1in • #8-32 x 1-1/2in

# Prominence



## AVAILABLE FINISHES

Polished Chrome (26)

Satin Nickel (G10)

Champagne Bronze (CZ)

Matte Black (MB)

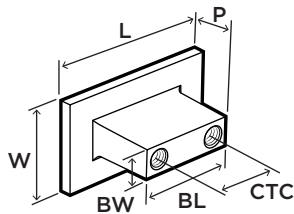

1  
37321



2



3



4

## KNOB

BW in(mm)	BL in(mm)	P in(mm)	W in(mm)	L in(mm)	CTC in(mm)	Wt lbs	Shelf Pk Qty	Price Code	Finish	Part No.
1/4 (6)	7/8 (22)	11/16 (17)	7/8 (22)	1-9/16 (40)	5/8 (16)	0.10	10	A	<ul style="list-style-type: none"> <li>1 Polished Chrome</li> <li>2 Satin Nickel</li> <li>3 Champagne Bronze</li> <li>4 Matte Black</li> </ul>	<ul style="list-style-type: none"> <li>BP3732126</li> <li>BP37321G10</li> <li>BP37321CZ</li> <li>BP37321MB</li> </ul>

37321

Base Material: Zinc

Hardware Included: Truss Head Machine Screw(s): #8-32 x 1in • #8-32 x 1-1/2in



## AVAILABLE FINISHES

- Polished Chrome (26)
- Oil-Rubbed Bronze (ORB)
- Satin Nickel (G10)
- Matte Black (FB)
- Champagne Bronze (CZ)

PRICE CODE BREAKDOWN • US Dollars			
<b>A</b>	\$5 or less	<b>G</b>	>\$40 to \$50
<b>B</b>	>\$5 to \$10	<b>H</b>	>\$50 to \$75
<b>C</b>	>\$10 to \$15	<b>I</b>	>\$75 to \$100
<b>D</b>	>\$15 to \$20	<b>J</b>	>\$100 to \$150
<b>E</b>	>\$20 to \$30	<b>K</b>	>\$150 to \$200
<b>F</b>	>\$30 to \$40	<b>L</b>	>\$200

## KNOBS



1  
53012



2



3



4



5

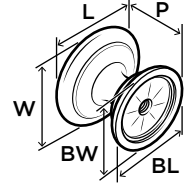

Part No.	Finish	Price Code	Shelf Pk Qty	Wt lbs	L in(mm)	W in(mm)	P in(mm)	BL in(mm)	BW in(mm)
BP5301226	1 Polished Chrome	A	25	0.11	1-1/4 (32)	1-1/4 (32)	1-1/16 (27)	15/16 (24)	15/16 (24)
BP53012G10	2 Satin Nickel								
BP53012CZ	3 Champagne Bronze								
BP53012ORB	4 Oil-Rubbed Bronze								
BP53012FB	5 Matte Black								

53012

Base Material: Zinc

Hardware Included: Truss Head Machine Screw(s): #8-32 x 1in • #8-32 x 1-1/2in

## PULLS



1  
21935  
76mm CTC



2



3

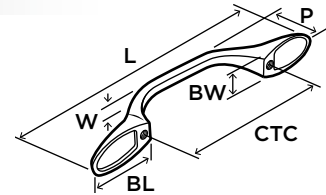

Part No.	Finish	Price Code	Shelf Pk Qty	Wt lbs	CTC in(mm)	L in(mm)	W in(mm)	P in(mm)	BL in(mm)	BW in(mm)
BP2193526	1 Polished Chrome	A	10	0.11	3 (76)	5 (127)	1/4 (6)	1 (25)	1-1/8 (29)	11/16 (17)
BP21935G10	Satin Nickel									
BP21935CZ	2 Champagne Bronze									
BP21935ORB	Oil-Rubbed Bronze									
BP21935FB	3 Matte Black									

21935

Base Material: Zinc

Hardware Included: Truss Head Machine Screw(s): #8-32 x 1in • #8-32 x 1-1/2in

LEGEND			
L	Length	BL	Base Length
W	Width	BW	Base Width
P	Projection	CTC	Center-to-Center

Shown on p. 78-80

# Ravino



## AVAILABLE FINISHES

Polished Chrome (26) 

Satin Nickel (G10) 

Oil-Rubbed Bronze (ORB) 

Champagne Bronze (CZ) 

Matte Black (FB) 

## PULLS (cont'd)

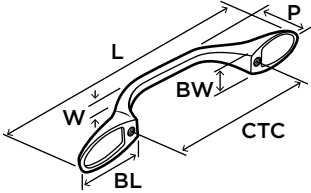

BW in(mm)	BL in(mm)	P in(mm)	W in(mm)	L in(mm)	CTC in(mm)	Wt lbs	Shelf Pk Qty	Price Code	Finish	Part No.
11/16 (17)	1-1/8 (29)	1-1/16 (27)	1/4 (6)	5-3/4 (146)	3-3/4 (96)	0.14	10	A	1 Polished Chrome	BP2193626
									2 Satin Nickel	BP21936G10
									3 Champagne Bronze	BP21936CZ
									Oil-Rubbed Bronze	BP21936ORB
									Matte Black	BP21936FB
11/16 (17)	1-1/8 (29)	1-1/16 (27)	1/4 (6)	7-1/16 (179)	5-1/16 (128)	0.18	10	B	Polished Chrome	BP2193726
									Satin Nickel	BP21937G10
									Champagne Bronze	BP21937CZ
									4 Oil-Rubbed Bronze	BP21937ORB
									Matte Black	BP21937FB
11/16 (17)	1-1/8 (29)	1-1/16 (27)	1/4 (6)	8-5/16 (211)	6-5/16 (160)	0.20	10	B	Polished Chrome	BP2193826
									Satin Nickel	BP21938G10
									Champagne Bronze	BP21938CZ
									Oil-Rubbed Bronze	BP21938ORB
									5 Matte Black	BP21938FB

Base Material: Zinc

Hardware Included: Truss Head Machine Screw(s): #8-32 x 1in • #8-32 x 1-1/2in





# Ravino

Shown on p. 78-80

## AVAILABLE FINISHES

-  Polished Chrome (26)
-  Satin Nickel (G10)
-  Champagne Bronze (CZ)
-  Oil-Rubbed Bronze (ORB)
-  Matte Black (FB)

PRICE CODE BREAKDOWN • US Dollars			
<b>A</b>	\$5 or less	<b>G</b>	>\$40 to \$50
<b>B</b>	>\$5 to \$10	<b>H</b>	>\$50 to \$75
<b>C</b>	>\$10 to \$15	<b>I</b>	>\$75 to \$100
<b>D</b>	>\$15 to \$20	<b>J</b>	>\$100 to \$150
<b>E</b>	>\$20 to \$30	<b>K</b>	>\$150 to \$200
<b>F</b>	>\$30 to \$40	<b>L</b>	>\$200

## CUP PULLS

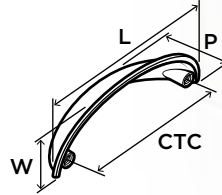

Part No.	Finish	Price Code	Shelf Pk Qty	Wt lbs	CTC in(mm)	L in(mm)	W in(mm)	P in(mm)	BL in(mm)	BW in(mm)
BP2209426	① Polished Chrome	<b>A</b>	10	0.12	3 (76)	3-11/16 (94)	1-1/4 (32)	1-1/8 (29)	3-11/16 (94)	1-1/4 (32)
BP22094G10	② Satin Nickel									
BP22094CZ	③ Champagne Bronze									
BP22094ORB	④ Oil-Rubbed Bronze									
BP22094FB	⑤ Matte Black									

22094

Base Material: Zinc

Hardware Included: Truss Head Machine Screw(s): #8-32 x 1in • #8-32 x 1-1/2in



LEGEND			
L	Length	BL	Base Length
W	Width	BW	Base Width
P	Projection	CTC	Center-to-Center

# Revolve



## AVAILABLE FINISHES

- Polished Chrome (26)
- Champagne Bronze (CZ)
- Satin Nickel (G10)
- Matte Black (FB)

## PULLS

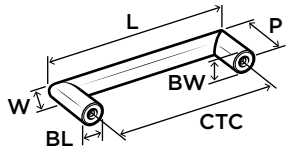

BW in(mm)	BL in(mm)	P in(mm)	W in(mm)	L in(mm)	CTC in(mm)	Wt lbs	Shelf Pkg Qty	Price Code	Finish	Part No.	
7/16 (11)	7/16 (11)	1-1/4 (32)	7/16 (11)	3-7/16 (87)	3 (76)	0.08	10	B	1 Polished Chrome	BP3685126 <sup>†</sup>	36851 <sup>†</sup>
									Satin Nickel	BP36851G10 <sup>†</sup>	
									Champagne Bronze	BP36851CZ <sup>†</sup>	
									Matte Black	BP36851FB <sup>†</sup>	
7/16 (11)	7/16 (11)	1-1/4 (32)	7/16 (11)	4-1/4 (108)	3-3/4 (96)	0.10	25	B	Polished Chrome	BP3685226	36852
									2 Satin Nickel	BP36852G10	
									Champagne Bronze	BP36852CZ	
									Matte Black	BP36852FB	
7/16 (11)	7/16 (11)	1-1/4 (32)	7/16 (11)	5-1/2 (140)	5-1/16 (128)	0.12	25	B	Polished Chrome	BP3685326	36853
									Satin Nickel	BP36853G10	
									3 Champagne Bronze	BP36853CZ	
									Matte Black	BP36853FB	
7/16 (11)	7/16 (11)	1-1/4 (32)	7/16 (11)	6-3/4 (171)	6-5/16 (160)	0.14	25	C	Polished Chrome	BP3685426 <sup>†</sup>	36854 <sup>†</sup>
									Satin Nickel	BP36854G10 <sup>†</sup>	
									Champagne Bronze	BP36854CZ <sup>†</sup>	
									4 Matte Black	BP36854FB <sup>†</sup>	

<sup>†</sup> **Coming Soon** • Base Material: Stainless Steel  
**Hardware Included:** Truss Head Machine Screw(s): #8-32 x 1in • #8-32 x 1-1/2in



# Rift

## AVAILABLE FINISHES

- Polished Chrome (26)
- Champagne Bronze (CZ)
- Satin Nickel (G10)
- Matte Black (FB)

PRICE CODE BREAKDOWN • US Dollars			
<b>A</b>	\$5 or less	<b>G</b>	>\$40 to \$50
<b>B</b>	>\$5 to \$10	<b>H</b>	>\$50 to \$75
<b>C</b>	>\$10 to \$15	<b>I</b>	>\$75 to \$100
<b>D</b>	>\$15 to \$20	<b>J</b>	>\$100 to \$150
<b>E</b>	>\$20 to \$30	<b>K</b>	>\$150 to \$200
<b>F</b>	>\$30 to \$40	<b>L</b>	>\$200

## PULLS

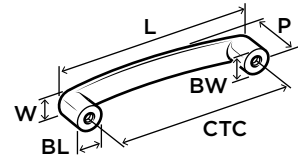

Part No.	Finish	Price Code	Shelf Pk Qty	Wt lbs	CTC in(mm)	L in(mm)	W in(mm)	P in(mm)	BL in(mm)	BW in(mm)
<b>36898+</b>	<b>BP3689826+</b> ① Polished Chrome	<b>B</b>	10	0.10	<b>3</b> (76)	<b>3-1/2</b> (89)	<b>1/2</b> (13)	<b>7/8</b> (22)	<b>1/2</b> (13)	<b>1/2</b> (13)
	BP36898G10+ Satin Nickel									
	BP36898CZ+ Champagne Bronze									
	BP36898FB+ Matte Black									
<b>36899</b>	BP3689926 Polished Chrome	<b>B</b>	25	0.13	<b>3-3/4</b> (96)	<b>4-1/4</b> (108)	<b>1/2</b> (13)	<b>15/16</b> (24)	<b>1/2</b> (13)	<b>1/2</b> (13)
	<b>BP36899G10</b> ② Satin Nickel									
	BP36899CZ Champagne Bronze									
	BP36899FB Matte Black									
<b>36900</b>	BP3690026 Polished Chrome	<b>B</b>	10	0.15	<b>5-1/16</b> (128)	<b>5-1/2</b> (140)	<b>1/2</b> (13)	<b>15/16</b> (24)	<b>1/2</b> (13)	<b>1/2</b> (13)
	BP36900G10 Satin Nickel									
	<b>BP36900CZ</b> ③ Champagne Bronze									
	BP36900FB Matte Black									
<b>36906+</b>	BP3690626+ Polished Chrome	<b>C</b>	10	0.15	<b>6-5/16</b> (160)	<b>6-13/16</b> (173)	<b>1/2</b> (13)	<b>15/16</b> (24)	<b>1/2</b> (13)	<b>1/2</b> (13)
	BP36906G10+ Satin Nickel									
	BP36906CZ+ Champagne Bronze									
	<b>BP36906FB+</b> ④ Matte Black									



\* Coming Soon • Base Material: Zinc

Hardware Included: Truss Head Machine Screw(s): #8-32 x 1in • #8-32 x 1-1/2in

LEGEND			
L	Length	BL	Base Length
W	Width	BW	Base Width
P	Projection	CTC	Center-to-Center





## AVAILABLE FINISHES

Polished Chrome (26) 

Satin Nickel (G10) 

Oil-Rubbed Bronze (ORB) 

Champagne Bronze (CZ) 

Matte Black (MB) 

## PULLS

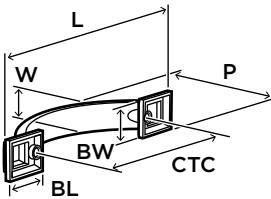

BW in(mm)	BL in(mm)	P in(mm)	W in(mm)	L in(mm)	CTC in(mm)	Wt lbs	Shelf Pk Qty	Price Code	Finish	Part No.
11/16 (17)	13/16 (21)	1-1/16 (27)	7/16 (11)	4-3/8 (111)	3 (76)	0.12	10	A	<b>1</b> Polished Chrome	BP3704026
									Satin Nickel	BP37040G10
									Champagne Bronze	BP37040CZ
									Oil-Rubbed Bronze	BP37040ORB
									Matte Black	BP37040MB
11/16 (17)	13/16 (21)	1-1/16 (27)	7/16 (11)	5-1/16 (128)	3-3/4 (96)	0.14	10	B	Polished Chrome	BP3704126
									<b>2</b> Satin Nickel	BP37041G10
									<b>3</b> Champagne Bronze	BP37041CZ
									Oil-Rubbed Bronze	BP37041ORB
									Matte Black	BP37041MB
11/16 (17)	13/16 (21)	1-1/4 (32)	7/16 (11)	6-3/8 (162)	5-1/16 (128)	0.18	10	B	Polished Chrome	BP3704226
									Satin Nickel	BP37042G10
									Champagne Bronze	BP37042CZ
									<b>4</b> Oil-Rubbed Bronze	BP37042ORB
									Matte Black	BP37042MB
11/16 (17)	13/16 (21)	1-1/4 (32)	7/16 (11)	7-11/16 (195)	6-5/16 (160)	0.19	10	B	Polished Chrome	BP3704326
									Satin Nickel	BP37043G10
									Champagne Bronze	BP37043CZ
									Oil-Rubbed Bronze	BP37043ORB
									<b>5</b> Matte Black	BP37043MB

Base Material: Zinc

Hardware Included: Truss Head Machine Screw(s): #8-32 x 1in • #8-32 x 1-1/2in





# Socle

## AVAILABLE FINISHES

-  Polished Chrome (26)
-  Satin Nickel (G10)
-  Champagne Bronze (CZ)
-  Oil-Rubbed Bronze (ORB)
-  Matte Black (MB)

## PRICE CODE BREAKDOWN • US Dollars

<b>A</b>	\$5 or less	<b>G</b>	>\$40 to \$50
<b>B</b>	>\$5 to \$10	<b>H</b>	>\$50 to \$75
<b>C</b>	>\$10 to \$15	<b>I</b>	>\$75 to \$100
<b>D</b>	>\$15 to \$20	<b>J</b>	>\$100 to \$150
<b>E</b>	>\$20 to \$30	<b>K</b>	>\$150 to \$200
<b>F</b>	>\$30 to \$40	<b>L</b>	>\$200

## KNOBS

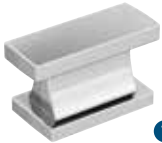

1  
37023

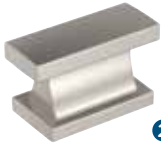

2

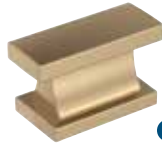

3



4



5

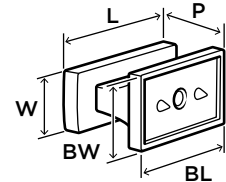

Part No.	Finish	Price Code	Shelf Pk Qty	Wt lbs	L in(mm)	W in(mm)	P in(mm)	BL in(mm)	BW in(mm)
BP3702326	1 Polished Chrome	A	10	0.08	1-7/16 (37)	9/16 (14)	13/16 (21)	1-3/16 (30)	11/16 (17)
BP37023G10	2 Satin Nickel								
BP37023CZ	3 Champagne Bronze								
BP37023ORB	4 Oil-Rubbed Bronze								
BP37023MB	5 Matte Black								

37023

Base Material: Zinc

Hardware Included: Truss Head Machine Screw(s): #8-32 x 1in • #8-32 x 1-1/2in



# Streamline II

Shown on p. 84-85

## AVAILABLE FINISHES

-  Polished Chrome (26)
-  Satin Nickel (G10)
-  Champagne Bronze (CZ)
-  Matte Black (MB)

## EDGE PULLS

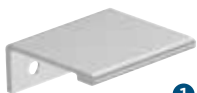

1  
37190  
44mm L

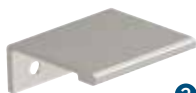

2

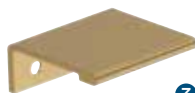

3

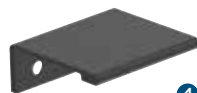

4

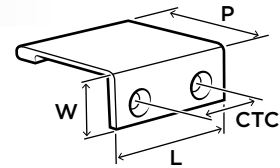

Part No.	Finish	Price Code	Shelf Pk Qty	Wt lbs	CTC in(mm)	L in(mm)	W in(mm)	P in(mm)	BL in(mm)	BW in(mm)
BP3719026	1 Polished Chrome	A	10	0.08	1 (25)	1-3/4 (44)	11/16 (17)	1-5/8 (41)	1-3/4 (44)	11/16 (17)
BP37190G10	2 Satin Nickel									
BP37190CZ	3 Champagne Bronze									
BP37190MB	4 Matte Black									

37190

Base Material: Zinc

Hardware Included: Flat Head Wood Screw(s): #4 x 16mm

LEGEND			
L	Length	BL	Base Length
W	Width	BW	Base Width
P	Projection	CTC	Center-to-Center

Shown on p. 84-85

# Streamline II



## AVAILABLE FINISHES

Polished Chrome (26)  Satin Nickel (G10)  Champagne Bronze (CZ)  Matte Black (MB) 

## EDGE PULLS (cont'd)

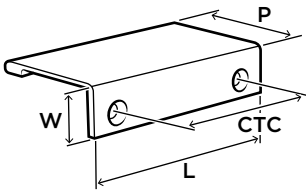

1  
37191  
76mm L



2  
37192  
102mm L



3  
37193  
127mm L

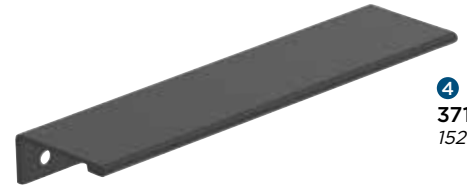

4  
37194  
152mm L

BW in(mm)	BL in(mm)	P in(mm)	W in(mm)	L in(mm)	CTC in(mm)	Wt lbs	Shelf Pk Qty	Price Code	Finish	Part No.
11/16 (17)	3 (76)	1-5/8 (41)	11/16 (17)	3 (76)	2-3/16 (56)	0.14	10	B	1 Polished Chrome	BP3719126
									Satin Nickel	BP37191G10
									Champagne Bronze	BP37191CZ
									Matte Black	BP37191MB
11/16 (17)	4 (102)	1-5/8 (41)	11/16 (17)	4 (102)	3-3/16 (81)	0.18	10	B	Polished Chrome	BP3719226
									2 Satin Nickel	BP37192G10
									Champagne Bronze	BP37192CZ
									Matte Black	BP37192MB
11/16 (17)	5 (127)	1-5/8 (41)	11/16 (17)	5 (127)	4-3/16 (106)	0.23	10	B	Polished Chrome	BP3719326
									Satin Nickel	BP37193G10
									3 Champagne Bronze	BP37193CZ
									Matte Black	BP37193MB
11/16 (17)	6 (152)	1-5/8 (41)	11/16 (17)	6 (152)	5-3/16 (132)	0.27	10	B	Polished Chrome	BP3719426
									Satin Nickel	BP37194G10
									Champagne Bronze	BP37194CZ
									4 Matte Black	BP37194MB





Base Material: Zinc

Hardware Included: Flat Head Wood Screw(s): #4 x 16mm



# Streamline Tab

## AVAILABLE FINISHES

-  Polished Chrome (26)
-  Champagne Bronze (CZ)
-  Satin Nickel (G10)
-  Matte Black (MB)

## PRICE CODE BREAKDOWN • US Dollars

<b>A</b>	\$5 or less	<b>G</b>	>\$40 to \$50
<b>B</b>	>\$5 to \$10	<b>H</b>	>\$50 to \$75
<b>C</b>	>\$10 to \$15	<b>I</b>	>\$75 to \$100
<b>D</b>	>\$15 to \$20	<b>J</b>	>\$100 to \$150
<b>E</b>	>\$20 to \$30	<b>K</b>	>\$150 to \$200
<b>F</b>	>\$30 to \$40	<b>L</b>	>\$200

## EDGE PULLS

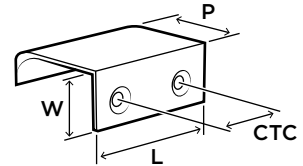
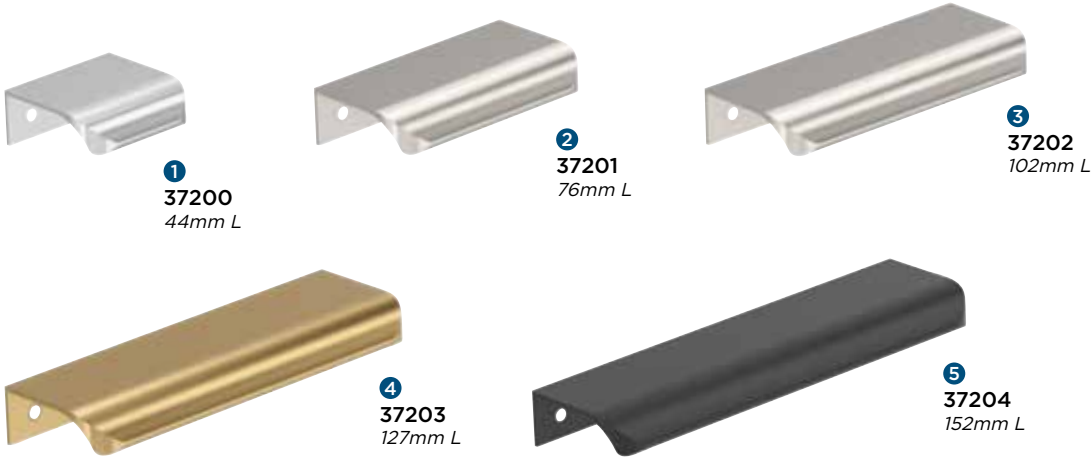

Part No.	Finish	Price Code	Shelf Pk Qty	Wt lbs	CTC in(mm)	L in(mm)	W in(mm)	P in(mm)	BL in(mm)	BW in(mm)
<b>37200</b>	BP3720026	① Polished Chrome	10	0.04	1 (25)	1-3/4 (44)	11/16 (17)	1-5/8 (41)	1-3/4 (44)	11/16 (17)
	BP37200G10	Satin Nickel								
	BP37200CZ	Champagne Bronze								
	BP37200MB	Matte Black								
<b>37201</b>	BP3720126	Polished Chrome	10	0.06	2-3/16 (56)	3 (76)	11/16 (17)	1-5/8 (41)	3 (76)	11/16 (17)
	BP37201G10	② Satin Nickel								
	BP37201CZ	Champagne Bronze								
	BP37201MB	Matte Black								
<b>37202</b>	BP3720226	Polished Chrome	10	0.08	3-3/16 (81)	4 (102)	11/16 (17)	1-5/8 (41)	4 (102)	11/16 (17)
	BP37202G10	③ Satin Nickel								
	BP37202CZ	Champagne Bronze								
	BP37202MB	Matte Black								
<b>37203</b>	BP3720326	Polished Chrome	10	0.10	4-3/16 (106)	5 (127)	11/16 (17)	1-5/8 (41)	5 (127)	11/16 (17)
	BP37203G10	Satin Nickel								
	BP37203CZ	④ Champagne Bronze								
	BP37203MB	Matte Black								
<b>37204</b>	BP3720426	Polished Chrome	10	0.12	5-3/16 (132)	6 (152)	11/16 (17)	1-5/8 (41)	6 (152)	11/16 (17)
	BP37204G10	Satin Nickel								
	BP37204CZ	Champagne Bronze								
	BP37204MB	⑤ Matte Black								

Base Material: Zinc

Hardware Included: Flat Head Wood Screw(s): #4 x 16mm

LEGEND			
L	Length	BL	Base Length
W	Width	BW	Base Width
P	Projection	CTC	Center-to-Center

## AVAILABLE FINISHES

Polished Chrome (26)  Satin Nickel (G10)  Champagne Bronze (CZ)  Matte Black (MB) 

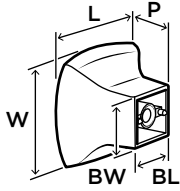

## KNOB





BW in(mm)	BL in(mm)	P in(mm)	W in(mm)	L in(mm)	Wt lbs	Shelf Pk Qty	Price Code	Finish	Part No.
9/16 (14)	9/16 (14)	7/8 (22)	1-3/16 (30)	1-3/16 (30)	0.13	10	B	<ul style="list-style-type: none"> <li>1 Polished Chrome</li> <li>2 Satin Nickel</li> <li>3 Champagne Bronze</li> <li>4 Matte Black</li> </ul>	<ul style="list-style-type: none"> <li>BP3729526</li> <li>BP37295G10</li> <li>BP37295CZ</li> <li>BP37295MB</li> </ul>

37295

**Base Material:** Zinc

**Hardware Included:** Truss Head Machine Screw(s): #8-32 x 1in • #8-32 x 1-1/2in

## AVAILABLE FINISHES

Polished Chrome (26)  Satin Nickel (G10)  Champagne Bronze (CZ)  Matte Black (MB) 

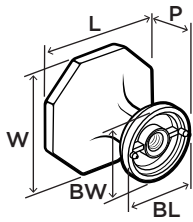

## KNOB

BW in(mm)	BL in(mm)	P in(mm)	W in(mm)	L in(mm)	Wt lbs	Shelf Pk Qty	Price Code	Finish	Part No.
11/16 (17)	11/16 (17)	1 (25)	1-3/16 (30)	1-3/16 (30)	0.10	10	B	<ul style="list-style-type: none"> <li>1 Polished Chrome</li> <li>2 Satin Nickel</li> <li>3 Champagne Bronze</li> <li>4 Matte Black</li> </ul>	<ul style="list-style-type: none"> <li>BP3733526</li> <li>BP37335G10</li> <li>BP37335CZ</li> <li>BP37335MB</li> </ul>

37335

**Base Material:** Zinc

**Hardware Included:** Truss Head Machine Screw(s): #8-32 x 1in • #8-32 x 1-1/2in



# Triomphe

## AVAILABLE FINISHES

- Polished Chrome (26)
- Champagne Bronze (CZ)
- Matte Black (MB)
- Satin Nickel (G10)
- Oil-Rubbed Bronze (ORB)

## PULLS

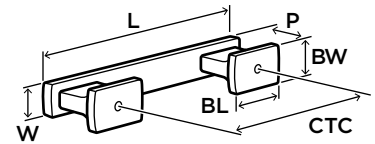

PRICE CODE BREAKDOWN	
US Dollars	
A	\$5 or less
B	>\$5 to \$10
C	>\$10 to \$15
D	>\$15 to \$20
E	>\$20 to \$30
F	>\$30 to \$40
G	>\$40 to \$50
H	>\$50 to \$75
I	>\$75 to \$100
J	>\$100 to \$150
K	>\$150 to \$200
L	>\$200

Part No.	Finish	Price Code	Shelf Pk Qty	Wt lbs	CTC in(mm)	L in(mm)	W in(mm)	P in(mm)	BL in(mm)	BW in(mm)	
<b>37090</b>	BP3709026	① Polished Chrome	<b>B</b>	10	0.25	3 (76)	4 (102)	1/2 (13)	1-1/16 (27)	15/16 (24)	5/8 (16)
	BP37090G10	Satin Nickel									
	BP37090CZ	Champagne Bronze									
	BP37090ORB	Oil-Rubbed Bronze									
	BP37090MB	Matte Black									
<b>37091</b>	BP3709126	Polished Chrome	<b>B</b>	10	0.27	3-3/4 (96)	4-13/16 (122)	1/2 (13)	1-1/16 (27)	15/16 (24)	5/8 (16)
	BP37091G10	② Satin Nickel									
	BP37091CZ	③ Champagne Bronze									
	BP37091ORB	Oil-Rubbed Bronze									
	BP37091MB	Matte Black									
<b>37092</b>	BP3709226	Polished Chrome	<b>B</b>	10	0.31	5-1/16 (128)	6-1/16 (154)	1/2 (13)	1-1/16 (27)	15/16 (24)	5/8 (16)
	BP37092G10	Satin Nickel									
	BP37092CZ	Champagne Bronze									
	BP37092ORB	④ Oil-Rubbed Bronze									
	BP37092MB	Matte Black									
<b>37093</b>	BP3709326	Polished Chrome	<b>B</b>	10	0.34	6-5/16 (160)	7-5/16 (186)	1/2 (13)	1-1/16 (27)	15/16 (24)	5/8 (16)
	BP37093G10	Satin Nickel									
	BP37093CZ	Champagne Bronze									
	BP37093ORB	Oil-Rubbed Bronze									
	BP37093MB	⑤ Matte Black									

Base Material: Zinc

Hardware Included: Truss Head Machine Screw(s): #8-32 x 1in • #8-32 x 1-1/2in



LEGEND			
L	Length	BL	Base Length
W	Width	BW	Base Width
P	Projection	CTC	Center-to-Center

Shown on p. 89-90

Vaile



AVAILABLE FINISHES

- Polished Chrome (26)
- Champagne Bronze (CZ)
- Satin Nickel (G10)
- Oil-Rubbed Bronze (ORB)
- Matte Black (FB)

KNOBBS

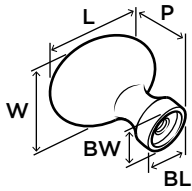

1  
53014



2



3



4



5

BW in(mm)	BL in(mm)	P in(mm)	W in(mm)	L in(mm)	Wt lbs	Shelf Pk Qty	Price Code	Finish	Part No.
9/16 (14)	9/16 (14)	1-3/8 (35)	1 (25)	1-3/8 (35)	0.16	25	A	1 Polished Chrome	BP5301426
								2 Satin Nickel	BP53014G10
								3 Champagne Bronze	BP53014CZ
								4 Oil-Rubbed Bronze	BP53014ORB
								5 Matte Black	BP53014FB

53014

Base Material: Zinc

Hardware Included: Truss Head Machine Screw(s): #8-32 x 1in • #8-32 x 1-1/2in

PULLS

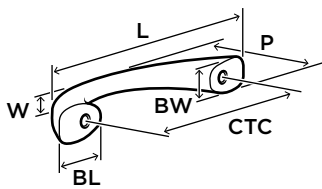

1  
37230  
76mm CTC



2



3

BW in(mm)	BL in(mm)	P in(mm)	W in(mm)	L in(mm)	CTC in(mm)	Wt lbs	Shelf Pk Qty	Price Code	Finish	Part No.
1/2 (13)	13/16 (21)	1-1/16 (27)	1/4 (6)	3-15/16 (100)	3 (76)	0.14	10	A	Polished Chrome	BP3723026
									1 Satin Nickel	BP37230G10
									2 Champagne Bronze	BP37230CZ
									3 Oil-Rubbed Bronze	BP37230ORB
									Matte Black	BP37230FB

37230

Base Material: Zinc

Hardware Included: Truss Head Machine Screw(s): #8-32 x 1in • #8-32 x 1-1/2in



# Vaile

Shown on p. 89-90

## AVAILABLE FINISHES

- Polished Chrome (26)
- Satin Nickel (G10)
- Oil-Rubbed Bronze (ORB)
- Champagne Bronze (CZ)
- Matte Black (FB)

## PRICE CODE BREAKDOWN

US Dollars

A	\$5 or less
B	>\$5 to \$10
C	>\$10 to \$15
D	>\$15 to \$20
E	>\$20 to \$30
F	>\$30 to \$40
G	>\$40 to \$50
H	>\$50 to \$75
I	>\$75 to \$100
J	>\$100 to \$150
K	>\$150 to \$200
L	>\$200

## PULLS (cont'd)

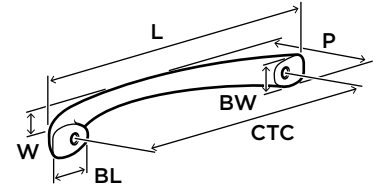

Part No.	Finish	Price Code	Shelf Pk Qty	Wt lbs	CTC in(mm)	L in(mm)	W in(mm)	P in(mm)	BL in(mm)	BW in(mm)
<b>53003</b>	BP5300326	1 Polished Chrome	25	0.16	3-3/4 (96)	4-13/16 (122)	1/4 (6)	1-1/16 (27)	13/16 (21)	1/2 (13)
	BP53003G10	2 Satin Nickel								
	BP53003CZ	Champagne Bronze								
	BP53003ORB	Oil-Rubbed Bronze								
	BP53003FB	Matte Black								
<b>37231</b>	BP3723126	Polished Chrome	10	0.18	5-1/16 (128)	6 (152)	1/4 (6)	1-3/16 (30)	13/16 (21)	1/2 (13)
	BP37231G10	Satin Nickel								
	BP37231CZ	3 Champagne Bronze								
	BP37231ORB	4 Oil-Rubbed Bronze								
	BP37231FB	Matte Black								
<b>37232</b>	BP3723226	Polished Chrome	10	0.21	6-5/16 (160)	7-1/4 (184)	1/4 (6)	1-5/16 (33)	13/16 (21)	1/2 (13)
	BP37232G10	Satin Nickel								
	BP37232CZ	Champagne Bronze								
	BP37232ORB	Oil-Rubbed Bronze								
	BP37232FB	5 Matte Black								



Base Material: Zinc  
Hardware Included: Truss Head Machine Screw(s): #8-32 x 1in • #8-32 x 1-1/2in

LEGEND			
L	Length	BL	Base Length
W	Width	BW	Base Width
P	Projection	CTC	Center-to-Center

Shown on p. 91-95

Versa



AVAILABLE FINISHES

- Polished Chrome (26)
- Satin Nickel (G10)
- Champagne Bronze (CZ)
- Polished Nickel (PN)
- Golden Champagne (BBZ)
- Matte Black (FB)

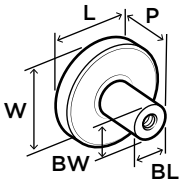

KNOB

BW in(mm)	BL in(mm)	P in(mm)	W in(mm)	L in(mm)	Wt lbs	Shelf Pk Qty	Price Code	Finish	Part No.
7/16 (11)	7/16 (11)	1 (25)	1-3/8 (35)	1-3/8 (35)	0.13	10	<b>B</b>	<ul style="list-style-type: none"> <li>1 Polished Chrome</li> <li>2 Polished Nickel</li> <li>3 Satin Nickel</li> <li>4 Golden Champagne</li> <li>5 Champagne Bronze</li> <li>6 Matte Black</li> </ul>	<ul style="list-style-type: none"> <li>BP3690426</li> <li>BP36904PN<sup>†</sup></li> <li>BP36904G10</li> <li>BP36904BBZ<sup>†</sup></li> <li>BP36904CZ</li> <li>BP36904FB</li> </ul>

36904

<sup>†</sup> Coming Soon • Base Material: Zinc

Hardware Included: Truss Head Machine Screw(s): #8-32 x 1in • #8-32 x 1-1/2in

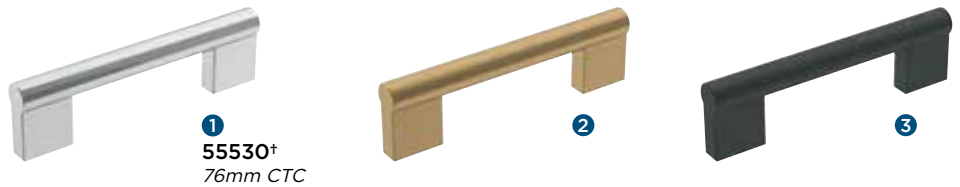
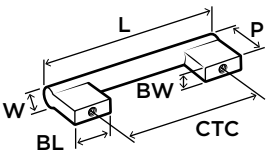

PULLS

BW in(mm)	BL in(mm)	P in(mm)	W in(mm)	L in(mm)	CTC in(mm)	Wt lbs	Shelf Pk Qty	Price Code	Finish	Part No.
5/16 (8)	15/16 (24)	1-5/16 (33)	1/2 (13)	3-15/16 (100)	3 (76)	0.61	10	<b>B</b>	<ul style="list-style-type: none"> <li>1 Polished Chrome</li> <li>Polished Nickel</li> <li>Satin Nickel</li> <li>Golden Champagne</li> <li>2 Champagne Bronze</li> <li>3 Matte Black</li> </ul>	<ul style="list-style-type: none"> <li>BP5553026<sup>†</sup></li> <li>BP55530PN<sup>†</sup></li> <li>BP55530G10<sup>†</sup></li> <li>BP55530BBZ<sup>†</sup></li> <li>BP55530CZ<sup>†</sup></li> <li>BP55530FB<sup>†</sup></li> </ul>

55530<sup>†</sup>

<sup>†</sup> Coming Soon • Base Material: Zinc

Hardware Included: Truss Head Machine Screw(s): #8-32 x 1in • #8-32 x 1-1/2in



# Versa

Shown on p. 91-95

## AVAILABLE FINISHES

- Polished Chrome (26)
- Satin Nickel (G10)
- Champagne Bronze (CZ)
- Polished Nickel (PN)
- Golden Champagne (BBZ)
- Matte Black (FB)

## PULLS (cont'd)

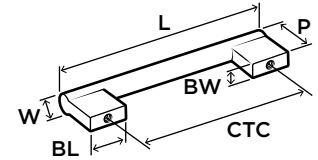
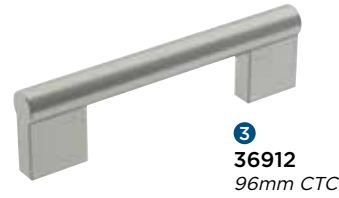
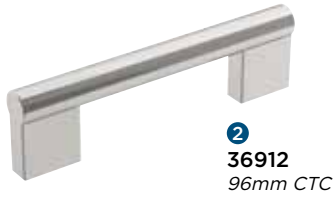

## PRICE CODE BREAKDOWN

US Dollars

<b>A</b>	\$5 or less
<b>B</b>	>\$5 to \$10
<b>C</b>	>\$10 to \$15
<b>D</b>	>\$15 to \$20
<b>E</b>	>\$20 to \$30
<b>F</b>	>\$30 to \$40
<b>G</b>	>\$40 to \$50
<b>H</b>	>\$50 to \$75
<b>I</b>	>\$75 to \$100
<b>J</b>	>\$100 to \$150
<b>K</b>	>\$150 to \$200
<b>L</b>	>\$200

Part No.	Finish	Price Code	Shelf Pk Qty	Wt lbs	CTC in(mm)	L in(mm)	W in(mm)	P in(mm)	BL in(mm)	BW in(mm)	
★ 36912	BP3691226	① Polished Chrome	<b>B</b>	25	0.38	3-3/4 (96)	4-11/16 (119)	1/2 (13)	1-5/16 (33)	15/16 (24)	3/8 (10)
	BP36912PN <sup>†</sup>	② Polished Nickel	<b>B</b>	10							
	BP36912G10	③ Satin Nickel	<b>B</b>	25							
	BP36912BBZ <sup>†</sup>	Golden Champagne	<b>B</b>	10							
	BP36912CZ	Champagne Bronze	<b>B</b>	25							
	BP36912FB	Matte Black	<b>B</b>	25							
★ 36913	BP3691326	Polished Chrome	<b>B</b>	10	0.44	5-1/16 (128)	5-15/16 (151)	1/2 (13)	1-5/16 (33)	15/16 (24)	3/8 (10)
	BP36913PN <sup>†</sup>	Polished Nickel									
	BP36913G10	Satin Nickel									
	BP36913BBZ <sup>†</sup>	④ Golden Champagne									
	BP36913CZ	Champagne Bronze									
	BP36913FB	Matte Black									
★ 36914	BP3691426	Polished Chrome	<b>C</b>	10	0.50	6-5/16 (160)	7-3/16 (183)	1/2 (13)	1-5/16 (33)	15/16 (24)	3/8 (10)
	BP36914PN <sup>†</sup>	Polished Nickel									
	BP36914G10	Satin Nickel									
	BP36914BBZ <sup>†</sup>	Golden Champagne									
	BP36914CZ	Champagne Bronze									
	BP36914FB	⑤ Matte Black									

<sup>†</sup> Coming Soon • Base Material: Zinc

Hardware Included: Truss Head Machine Screw(s): #8-32 x 1in • #8-32 x 1-1/2in



LEGEND			
L	Length	BL	Base Length
W	Width	BW	Base Width
P	Projection	CTC	Center-to-Center

Shown on p. 91-95



### AVAILABLE FINISHES

- Polished Chrome (26)
- Satin Nickel (G10)
- Champagne Bronze (CZ)
- Polished Nickel (PN)
- Golden Champagne (BBZ)
- Matte Black (FB)

### PULLS (cont'd)



BW in(mm)	BL in(mm)	P in(mm)	W in(mm)	L in(mm)	CTC in(mm)	Wt lbs	Shelf Pk Qty	Price Code	Finish	Part No.
5/16 (8)	15/16 (24)	1-5/16 (33)	1/2 (13)	8-1/2 (216)	7-9/16 (192)	0.79	10	C	1 Polished Chrome	BP5553126+
									Polished Nickel	BP55531PN+
									Satin Nickel	BP55531G10+
									Golden Champagne	BP55531BBZ+
									Champagne Bronze	BP55531CZ+
									Matte Black	BP55531FB+
3/8 (10)	15/16 (24)	1-5/16 (33)	1/2 (13)	9-3/4 (248)	8-13/16 (224)	0.62	10	D	Polished Chrome	BP3691526
									Polished Nickel	BP36915PN+
									Satin Nickel	BP36915G10
									Golden Champagne	BP36915BBZ+
									2 Champagne Bronze	BP36915CZ
									3 Matte Black	BP36915FB

† Coming Soon • Base Material: Zinc  
 Hardware Included: Truss Head Machine Screw(s): #8-32 x 1in • #8-32 x 1-1/2in











### PRICE CODE BREAKDOWN US Dollars

<b>A</b>	\$5 or less
<b>B</b>	>\$5 to \$10
<b>C</b>	>\$10 to \$15
<b>D</b>	>\$15 to \$20
<b>E</b>	>\$20 to \$30
<b>F</b>	>\$30 to \$40
<b>G</b>	>\$40 to \$50
<b>H</b>	>\$50 to \$75
<b>I</b>	>\$75 to \$100
<b>J</b>	>\$100 to \$150
<b>K</b>	>\$150 to \$200
<b>L</b>	>\$200

## AVAILABLE FINISHES

-  Polished Chrome (26)
-  Satin Nickel (G10)
-  Champagne Bronze (CZ)
-  Polished Nickel (PN)
-  Golden Champagne (BBZ)
-  Matte Black (FB)

## PULLS (cont'd)



**1**  
**55532<sup>+</sup>**  
256mm CTC



**2**  
**55534<sup>+</sup>**  
320mm CTC

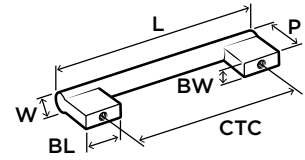

Part No.	Finish	Price Code	Shelf Pk Qty	Wt lbs	CTC in(mm)	L in(mm)	W in(mm)	P in(mm)	BL in(mm)	BW in(mm)
<b>BP5553226<sup>+</sup></b>	<b>1</b> Polished Chrome	<b>D</b>	10	0.89	10-1/16 (256)	11 (279)	1/2 (13)	1-5/16 (33)	15/16 (24)	3/8 (10)
BP55532PN <sup>+</sup>	Polished Nickel									
BP55532G10 <sup>+</sup>	Satin Nickel									
BP55532BBZ <sup>+</sup>	Golden Champagne									
BP55532CZ <sup>+</sup>	Champagne Bronze									
BP55532FB <sup>+</sup>	Matte Black									
<b>BP5553426<sup>+</sup></b>	Polished Chrome	<b>F</b>	10	0.99	12-5/8 (320)	13-1/2 (343)	1/2 (13)	1-5/16 (33)	15/16 (24)	3/8 (10)
BP55534PN <sup>+</sup>	Polished Nickel									
BP55534G10 <sup>+</sup>	Satin Nickel									
BP55534BBZ <sup>+</sup>	Golden Champagne									
<b>BP55534CZ<sup>+</sup></b>	<b>2</b> Champagne Bronze									
BP55534FB <sup>+</sup>	Matte Black									

★ 55532<sup>+</sup>

★ 55534<sup>+</sup>



<sup>+</sup> Coming Soon • Base Material: Zinc

Hardware Included: Truss Head Machine Screw(s): #8-32 x 1in • #8-32 x 1-1/2in

LEGEND			
L	Length	BL	Base Length
W	Width	BW	Base Width
P	Projection	CTC	Center-to-Center

Shown on p. 91-95

Versa



AVAILABLE FINISHES

- Polished Chrome (26)
- Satin Nickel (G10)
- Champagne Bronze (CZ)
- Polished Nickel (PN)
- Golden Champagne (BBZ)
- Matte Black (FB)

APPLIANCE PULLS



1  
55533<sup>†</sup>  
305mm CTC



2  
55535<sup>†</sup>  
457mm CTC

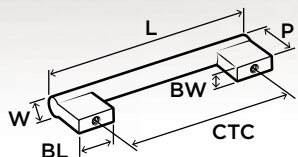

BW in(mm)	BL in(mm)	P in(mm)	W in(mm)	L in(mm)	CTC in(mm)	Wt lbs	Shelf Pk Qty	Price Code	Finish	Part No.
9/16 (14)	1-3/8 (35)	2 (51)	3/4 (19)	13-3/8 (340)	12 (305)	1.86	1	J	Polished Chrome	BP5553326 <sup>†</sup>
									Polished Nickel	BP55533PN <sup>†</sup>
									1 Satin Nickel	BP55533G10 <sup>†</sup>
									Golden Champagne	BP55533BBZ <sup>†</sup>
									Champagne Bronze	BP55533CZ <sup>†</sup>
									Matte Black	BP55533FB <sup>†</sup>
9/16 (14)	1-3/8 (35)	2 (51)	3/4 (19)	19-3/8 (492)	18 (457)	2.49	1	K	Polished Chrome	BP5553526 <sup>†</sup>
									Polished Nickel	BP55535PN <sup>†</sup>
									Satin Nickel	BP55535G10 <sup>†</sup>
									Golden Champagne	BP55535BBZ <sup>†</sup>
									Champagne Bronze	BP55535CZ <sup>†</sup>
									2 Matte Black	BP55535FB <sup>†</sup>

★ 55533<sup>†</sup>

★ 55535<sup>†</sup>

<sup>†</sup> Coming Soon • Base Material: Zinc  
 Hardware Included: Washers & Truss Head Machine Screw(s):  
 #10-24 x 3/4in • #10-24 x 1in • #10-24 x 1-1/4in • #10-24 x 1-1/2in • #10-24 x 1-3/4in • #10-24 x 2-1/8in





# Whistle

## AVAILABLE FINISHES

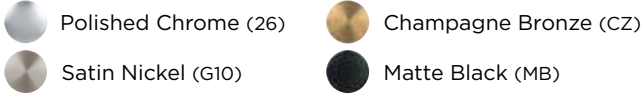

## PRICE CODE BREAKDOWN • US Dollars

<b>A</b>	\$5 or less	<b>G</b>	>\$40 to \$50
<b>B</b>	>\$5 to \$10	<b>H</b>	>\$50 to \$75
<b>C</b>	>\$10 to \$15	<b>I</b>	>\$75 to \$100
<b>D</b>	>\$15 to \$20	<b>J</b>	>\$100 to \$150
<b>E</b>	>\$20 to \$30	<b>K</b>	>\$150 to \$200
<b>F</b>	>\$30 to \$40	<b>L</b>	>\$200

## KNOBS

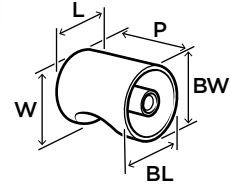

Part No.	Finish	Price Code	Shelf Pk Qty	Wt lbs	L in(mm)	W in(mm)	P in(mm)	BL in(mm)	BW in(mm)
<b>37026</b>	BP3702626 ① Polished Chrome	<b>A</b>	10	0.06	11/16 (17)	11/16 (17)	15/16 (24)	11/16 (17)	11/16 (17)
	BP37026G10 ② Satin Nickel								
	BP37026CZ ③ Champagne Bronze								
	BP37026MB ④ Matte Black								

Base Material: Zinc

Hardware Included: Truss Head Machine Screw(s): #8-32 x 1in • #8-32 x 1-1/2in



# Willow

Shown on p. 96-97

## AVAILABLE FINISHES



## PULLS

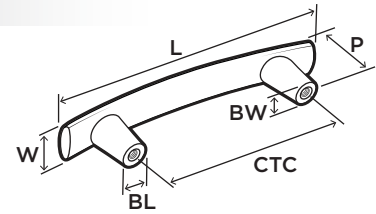

Part No.	Finish	Price Code	Shelf Pk Qty	Wt lbs	CTC in(mm)	L in(mm)	W in(mm)	P in(mm)	BL in(mm)	BW in(mm)
<b>37309<sup>†</sup></b>	BP3730926 <sup>†</sup> ① Polished Chrome	<b>A</b>	10	0.13	3 (76)	6-5/8 (168)	11/16 (17)	1-3/8 (35)	7/16 (11)	7/16 (11)
	BP37309G10 <sup>†</sup> Satin Nickel									
	BP37309CZ <sup>†</sup> ② Champagne Bronze									
	BP37309MB <sup>†</sup> Matte Black									

<sup>†</sup> Coming Soon • Base Material: Zinc

Hardware Included: Truss Head Machine Screw(s): #8-32 x 1in • #8-32 x 1-1/2in



LEGEND			
L	Length	BL	Base Length
W	Width	BW	Base Width
P	Projection	CTC	Center-to-Center

Shown on p. 96-97

# Willow



## AVAILABLE FINISHES

Polished Chrome (26)  Satin Nickel (G10)  Champagne Bronze (CZ)  Matte Black (MB) 

## PULLS (cont'd)

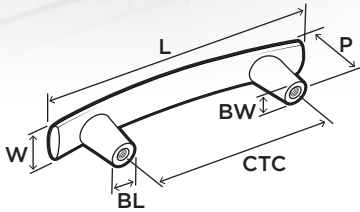

BW in(mm)	BL in(mm)	P in(mm)	W in(mm)	L in(mm)	CTC in(mm)	Wt lbs	Shelf Pk Qty	Price Code	Finish	Part No.
7/16 (11)	7/16 (11)	1-3/8 (35)	11/16 (17)	5-7/16 (138)	3-3/4 (96)	0.16	10	A	1 Polished Chrome	BP3731026
									Satin Nickel	BP37310G10
									Champagne Bronze	BP37310CZ
									Matte Black	BP37310MB
7/16 (11)	7/16 (11)	1-3/8 (35)	11/16 (17)	6-5/8 (168)	5-1/16 (128)	0.19	10	B	Polished Chrome	BP3731126
									2 Satin Nickel	BP37311G10
									Champagne Bronze	BP37311CZ
									Matte Black	BP37311MB
7/16 (11)	7/16 (11)	1-3/8 (35)	11/16 (17)	7-15/16 (202)	6-5/16 (160)	0.22	10	B	Polished Chrome	BP3731226
									Satin Nickel	BP37312G10
									3 Champagne Bronze	BP37312CZ
									4 Matte Black	BP37312MB





Base Material: Zinc

Hardware Included: Truss Head Machine Screw(s): #8-32 x 1in • #8-32 x 1-1/2in



# Wire Pulls

## AVAILABLE FINISHES

-  Polished Chrome (26)
-  Oil-Rubbed Bronze (ORB)
-  Brushed Chrome (26D)
-  Matte Black (MB)
-  Satin Nickel (G10)

PRICE CODE BREAKDOWN • US Dollars			
<b>A</b>	\$5 or less	<b>G</b>	>\$40 to \$50
<b>B</b>	>\$5 to \$10	<b>H</b>	>\$50 to \$75
<b>C</b>	>\$10 to \$15	<b>I</b>	>\$75 to \$100
<b>D</b>	>\$15 to \$20	<b>J</b>	>\$100 to \$150
<b>E</b>	>\$20 to \$30	<b>K</b>	>\$150 to \$200
<b>F</b>	>\$30 to \$40	<b>L</b>	>\$200

## PULLS

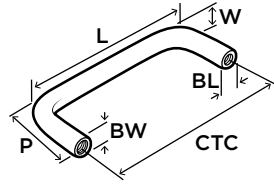

Part No.	Finish	Price Code	Shelf Pk Qty	Wt lbs	CTC in(mm)	L in(mm)	W in(mm)	P in(mm)	BL in(mm)	BW in(mm)
<b>865</b>	<b>BP865CS26</b> ① Polished Chrome	<b>A</b>	25	0.12	3 (76)	3-5/16 (84)	5/16 (8)	1-1/4 (32)	1/4 (6)	1/4 (6)
	BP865CS26D Brushed Chrome									
	BP865CSG10 Satin Nickel									
	BP865ORB Oil-Rubbed Bronze									
	BP865MB Matte Black									
<b>867</b>	<b>BP867CS26D</b> ② Brushed Chrome	<b>A</b>	25	0.13	3-1/2 (89)	3-13/16 (97)	5/16 (8)	1-1/4 (32)	1/4 (6)	1/4 (6)
	BP867CSG10 Satin Nickel									
<b>★ 76313</b>	BP76313CS26 Polished Chrome	<b>A</b>	25	0.14	3-3/4 (96)	4-1/8 (105)	5/16 (8)	1-1/4 (32)	1/4 (6)	1/4 (6)
	BP76313CS26D Brushed Chrome									
	<b>BP76313CSG10</b> ③ Satin Nickel									
	BP76313ORB Oil-Rubbed Bronze									
	BP76313MB Matte Black									
<b>★ 76312</b>	BP76312CS26 Polished Chrome	<b>A</b>	25	0.14	4 (102)	4-5/16 (110)	5/16 (8)	1-1/4 (32)	1/4 (6)	1/4 (6)
	BP76312CS26D Brushed Chrome									
	BP76312CSG10 Satin Nickel									
	<b>BP76312ORB</b> ④ Oil-Rubbed Bronze									
	<b>BP76312MB</b> ⑤ Matte Black									



**Base Material:** Carbon Steel  
**Hardware Included:** Truss Head Machine Screw(s): #8-32 x 1in • #8-32 x 1-1/2in

# Product Index

Product No.	Type	Pg	Product No.	Type	Pg	Product No.	Type	Pg
173CH	Pull	54	BP173G10	Pull	54	BP19017CSG9	Pull	28
BP117826	Pull	25	BP173ORB	Pull	54	BP19017CZ†	Pull	28
BP1178BBR	Pull	25	BP1900926	Knob	22	BP19017ORB	Pull	28
BP1178CSG9	Pull	25	BP19009BBR	Knob	22	BP19017PN†	Pull	28
BP1178CZ	Pull	25	BP19009BBZ	Knob	22	BP19017SS	Pull	28
BP1178ORB	Pull	25	BP19009CSG9	Knob	22	BP1901826†	Pull	29
BP1586226†	Knob	62	BP19009CZ	Knob	22	BP19018BBR†	Pull	29
BP158626	Knob	62	BP19009GM	Knob	22	BP19018BBZ†	Pull	29
BP15862CZ	Knob	62	BP19009ORB	Knob	22	BP19018CSG9	Pull	29
BP15862FB	Knob	62	BP19009PN	Knob	22	BP19018CZ†	Pull	29
BP15862G10	Knob	62	BP19009SS	Knob	22	BP19018ORB	Pull	29
BP15862ORB	Knob	62	BP19010CSG9	Pull	23	BP19018PN†	Pull	29
BP1586CZ	Knob	62	BP19010SS	Pull	23	BP19018SS	Pull	29
BP1586FB	Knob	62	BP19011CSG9	Pull	23	BP1901926†	Pull	29
BP1586G10	Knob	62	BP19011SS	Pull	23	BP19019BBR†	Pull	29
BP1586ORB	Knob	62	BP19012CSG9	Pull	25	BP19019BBZ†	Pull	29
BP158726	Pull	63	BP19012SS	Pull	25	BP19019CSG9	Pull	29
BP1587CZ	Pull	63	BP19013CSG9	Pull	26	BP19019CZ†	Pull	29
BP1587FB	Pull	63	BP19013SS	Pull	26	BP19019ORB	Pull	29
BP1587G10	Pull	63	BP1901426	Pull	27	BP19019PN†	Pull	29
BP1587ORB	Pull	63	BP19014BBR	Pull	27	BP19019SS	Pull	29
BP158826	Pull	63	BP19014BBZ	Pull	27	BP19541CSG9	Pull	24
BP1588CZ	Pull	63	BP19014CSG9	Pull	27	BP19541SS	Pull	24
BP1588FB	Pull	63	BP19014CZ	Pull	27	BP2117126	Pull	65
BP1588G10	Pull	63	BP19014GM	Pull	27	BP21171CZ	Pull	65
BP1588ORB	Pull	63	BP19014ORB	Pull	27	BP21171FB	Pull	65
BP158926†	Pull	63	BP19014PN	Pull	27	BP21171G10	Pull	65
BP1589CZ†	Pull	63	BP19014SS	Pull	27	BP21171ORB	Pull	65
BP1589FB†	Pull	63	BP1901526†	Pull	27	BP2117226	Pull	65
BP1589G10†	Pull	63	BP19015BBR†	Pull	27	BP21172CZ	Pull	65
BP1589ORB†	Pull	63	BP19015BBZ†	Pull	27	BP21172FB	Pull	65
BP159026	Pull	63	BP19015CSG9	Pull	27	BP21172G10	Pull	65
BP1590CZ	Pull	63	BP19015CZ†	Pull	27	BP21172ORB	Pull	65
BP1590FB	Pull	63	BP19015ORB	Pull	27	BP2117326	Pull	65
BP1590G10	Pull	63	BP19015PN†	Pull	27	BP21173CZ	Pull	65
BP1590ORB	Pull	63	BP19015SS	Pull	27	BP21173FB	Pull	65
BP159226†	Cup Pull	64	BP1901626	Pull	28	BP21173G10	Pull	65
BP1592CZ	Cup Pull	64	BP19016BBR	Pull	28	BP21173ORB	Pull	65
BP1592FB	Cup Pull	64	BP19016BBZ	Pull	28	BP2117426	Pull	65
BP1592G10	Cup Pull	64	BP19016CSG9	Pull	28	BP21174CZ	Pull	65
BP1592ORB	Cup Pull	64	BP19016CZ	Pull	28	BP21174FB	Pull	65
BP159326†	Finger Pull	62	BP19016GM	Pull	28	BP21174G10	Pull	65
BP1593CZ	Finger Pull	62	BP19016ORB	Pull	28	BP21174ORB	Pull	65
BP1593FB	Finger Pull	62	BP19016PN	Pull	28	BP2193526	Pull	78
BP1593G10	Finger Pull	62	BP19016SS	Pull	28	BP21935CZ	Pull	78
BP1593ORB	Finger Pull	62	BP1901726†	Pull	28	BP21935FB	Pull	78
BP173CZ	Pull	54	BP19017BBR†	Pull	28	BP21935G10	Pull	78
BP173FB	Pull	54	BP19017BBZ†	Pull	28	BP21935ORB	Pull	78

† Coming Soon

Mounting hardware included.  
Please direct any questions to Amerock Customer Care.

# Product Index

Product No.	Type	Pg	Product No.	Type	Pg	Product No.	Type	Pg
BP2193626	Pull	79	BP26206PN	Appliance Pull	47	BP2939326	Pull	53
BP21936CZ	Pull	79	BP2620726†	Appliance Pull	47	BP29393CZ	Pull	53
BP21936FB	Pull	79	BP26207BBR	Appliance Pull	47	BP29393FB	Pull	53
BP21936G10	Pull	79	BP26207BBZ	Appliance Pull	47	BP29393G10	Pull	53
BP21936ORB	Pull	79	BP26207CZ†	Appliance Pull	47	BP29393ORB	Pull	53
BP2193726	Pull	79	BP26207G10	Appliance Pull	47	BP2939426	Pull	53
BP21937CZ	Pull	79	BP26207ORB	Appliance Pull	47	BP29394CZ	Pull	53
BP21937FB	Pull	79	BP26207PN	Appliance Pull	47	BP29394FB	Pull	53
BP21937G10	Pull	79	BP2620826†	Pull	45	BP29394G10	Pull	53
BP21937ORB	Pull	79	BP26208BBR†	Pull	45	BP29394ORB	Pull	53
BP2193826	Pull	79	BP26208BBZ†	Pull	45	BP2939826	Knob	52
BP21938CZ	Pull	79	BP26208CZ†	Pull	45	BP29398CZ	Knob	52
BP21938FB	Pull	79	BP26208G10†	Pull	45	BP29398FB	Knob	52
BP21938G10	Pull	79	BP26208ORB†	Pull	45	BP29398G10	Knob	52
BP21938ORB	Pull	79	BP26208PN†	Pull	45	BP29398ORB	Knob	52
BP2209426	Cup Pull	80	BP2620926†	Pull	46	BP341626	Pull	18
BP22094CZ	Cup Pull	80	BP26209BBR†	Pull	46	BP34163	Pull	18
BP22094FB	Cup Pull	80	BP26209BBZ†	Pull	46	BP3657026	Pull	70
BP22094G10	Cup Pull	80	BP26209CZ†	Pull	46	BP36570BBZ	Pull	70
BP22094ORB	Cup Pull	80	BP26209G10†	Pull	46	BP36570CZ	Pull	70
BP2620126	Pull	44	BP26209ORB†	Pull	46	BP36570FB	Pull	70
BP26201BBR	Pull	44	BP26209PN†	Pull	46	BP36570G10	Pull	70
BP26201BBZ	Pull	44	BP2621026†	Pull	46	BP36570ORB	Pull	70
BP26201CZ	Pull	44	BP26210BBR†	Pull	46	BP36570PN	Pull	70
BP26201G10	Pull	44	BP26210BBZ†	Pull	46	BP3657126	Pull	70
BP26201ORB	Pull	44	BP26210CZ†	Pull	46	BP36571BBZ	Pull	70
BP26201PN	Pull	44	BP26210G10†	Pull	46	BP36571CZ	Pull	70
BP2620326	Pull	44	BP26210ORB†	Pull	46	BP36571FB	Pull	70
BP26203BBR	Pull	44	BP26210PN†	Pull	46	BP36571G10	Pull	70
BP26203BBZ	Pull	44	BP2911326	Knob	59	BP36571ORB	Pull	70
BP26203CZ	Pull	44	BP29113G10	Knob	59	BP36571PN	Pull	70
BP26203G10	Pull	44	BP29113MB	Knob	59	BP3657226	Pull	71
BP26203ORB	Pull	44	BP29113ORB	Knob	59	BP36572BBZ	Pull	71
BP26203PN	Pull	44	BP2937026	Knob	52	BP36572CZ	Pull	71
BP2620426	Pull	45	BP29370CZ	Knob	52	BP36572FB	Pull	71
BP26204BBR	Pull	45	BP29370FB	Knob	52	BP36572G10	Pull	71
BP26204BBZ	Pull	45	BP29370G10	Knob	52	BP36572ORB	Pull	71
BP26204CZ	Pull	45	BP29370ORB	Knob	52	BP36572PN	Pull	71
BP26204G10	Pull	45	BP2937926	Pull	53	BP3657326	Edge Pull	48
BP26204ORB	Pull	45	BP29379CZ	Pull	53	BP36573CZ	Edge Pull	48
BP26204PN	Pull	45	BP29379FB	Pull	53	BP36573FB	Edge Pull	48
BP2620626	Appliance Pull	47	BP29379G10	Pull	53	BP36573G10	Edge Pull	48
BP2620626†	Appliance Pull	47	BP29379ORB	Pull	53	BP36573ORB	Edge Pull	48
BP26206BBR	Appliance Pull	47	BP2938526	Pull	53	BP36573PN	Edge Pull	48
BP26206BBZ	Appliance Pull	47	BP29385CZ	Pull	53	BP3657426	Edge Pull	48
BP26206CZ†	Appliance Pull	47	BP29385FB	Pull	53	BP36574CZ	Edge Pull	48
BP26206G10	Appliance Pull	47	BP29385G10	Pull	53	BP36574FB	Edge Pull	48
BP26206ORB	Appliance Pull	47	BP29385ORB	Pull	53	BP36574G10	Edge Pull	48

Mounting hardware included.  
Please direct any questions to Amerock Customer Care.

† Coming Soon

# Product Index

Product No.	Type	Pg	Product No.	Type	Pg	Product No.	Type	Pg
BP36574ORB	Edge Pull	48	BP36904PN <sup>†</sup>	Knob	91	BP36912G10	Pull	92
BP36574PN	Edge Pull	48	BP3690526	Knob	69	BP36912PN <sup>†</sup>	Pull	92
BP3657526	Edge Pull	48	BP36905BBZ	Knob	69	BP3691326	Pull	92
BP36575CZ	Edge Pull	48	BP36905CZ	Knob	69	BP36913BBZ <sup>†</sup>	Pull	92
BP36575FB	Edge Pull	48	BP36905FB	Knob	69	BP36913CZ	Pull	92
BP36575G10	Edge Pull	48	BP36905G10	Knob	69	BP36913FB	Pull	92
BP36575ORB	Edge Pull	48	BP36905ORB	Knob	69	BP36913G10	Pull	92
BP36575PN	Edge Pull	48	BP36905PN	Knob	69	BP36913PN <sup>†</sup>	Pull	92
BP3657826	Pull	69	BP3690626 <sup>†</sup>	Pull	82	BP3691426	Pull	92
BP36578BBZ	Pull	69	BP36906CZ <sup>†</sup>	Pull	82	BP36914BBZ <sup>†</sup>	Pull	92
BP36578CZ	Pull	69	BP36906FB <sup>†</sup>	Pull	82	BP36914CZ	Pull	92
BP36578FB	Pull	69	BP36906G10 <sup>†</sup>	Pull	82	BP36914FB	Pull	92
BP36578G10	Pull	69	BP3690726	Knob	50	BP36914G10	Pull	92
BP36578ORB	Pull	69	BP36907FB	Knob	50	BP36914PN <sup>†</sup>	Pull	92
BP36578PN	Pull	69	BP36907G10	Knob	50	BP3691526	Pull	93
BP3685126 <sup>†</sup>	Pull	81	BP36907ORB	Knob	50	BP36915BBZ <sup>†</sup>	Pull	93
BP36851CZ <sup>†</sup>	Pull	81	BP3690826	Pull	71	BP36915CZ	Pull	93
BP36851FB <sup>†</sup>	Pull	81	BP36908BBZ	Pull	71	BP36915FB	Pull	93
BP36851G10 <sup>†</sup>	Pull	81	BP36908CZ	Pull	71	BP36915G10	Pull	93
BP3685226	Pull	81	BP36908FB	Pull	71	BP36915PN <sup>†</sup>	Pull	93
BP36852CZ	Pull	81	BP36908G10	Pull	71	BP3702026	Knob	56
BP36852FB	Pull	81	BP36908ORB	Pull	71	BP37020CZ	Knob	56
BP36852G10	Pull	81	BP36908PN	Pull	71	BP37020G10	Knob	56
BP3685326	Pull	81	BP3690926	Pull	72	BP37020MB	Knob	56
BP36853CZ	Pull	81	BP36909BBZ	Pull	72	BP37020ORB	Knob	56
BP36853FB	Pull	81	BP36909CZ	Pull	72	BP3702126	Knob	50
BP36853G10	Pull	81	BP36909FB	Pull	72	BP37021CZ	Knob	50
BP3685426 <sup>†</sup>	Pull	81	BP36909G10	Pull	72	BP37021G10	Knob	50
BP36854CZ <sup>†</sup>	Pull	81	BP36909ORB	Pull	72	BP37021MB	Knob	50
BP36854FB <sup>†</sup>	Pull	81	BP36909PN	Pull	72	BP37021ORB	Knob	50
BP36854G10 <sup>†</sup>	Pull	81	BP3691026	Pull	72	BP3702226	Knob	37
BP3689826 <sup>†</sup>	Pull	82	BP36910BBZ	Pull	72	BP37022CZ	Knob	37
BP36898CZ <sup>†</sup>	Pull	82	BP36910CZ	Pull	72	BP37022G10	Knob	37
BP36898FB <sup>†</sup>	Pull	82	BP36910FB	Pull	72	BP37022MB	Knob	37
BP36898G10 <sup>†</sup>	Pull	82	BP36910G10	Pull	72	BP37022ORB	Knob	37
BP3689926	Pull	82	BP36910ORB	Pull	72	BP3702326	Knob	84
BP36899CZ	Pull	82	BP36910PN	Pull	72	BP37023CZ	Knob	84
BP36899FB	Pull	82	BP3691126	Pull	73	BP37023G10	Knob	84
BP36899G10	Pull	82	BP36911BBZ	Pull	73	BP37023MB	Knob	84
BP3690026	Pull	82	BP36911CZ	Pull	73	BP37023ORB	Knob	84
BP36900CZ	Pull	82	BP36911FB	Pull	73	BP3702426	Knob	77
BP36900FB	Pull	82	BP36911G10	Pull	73	BP37024CZ	Knob	77
BP36900G10	Pull	82	BP36911ORB	Pull	73	BP37024G10	Knob	77
BP3690426	Knob	91	BP36911PN	Pull	73	BP37024MB	Knob	77
BP36904BBZ <sup>†</sup>	Knob	91	BP3691226	Pull	92	BP37024ORB	Knob	77
BP36904CZ	Knob	91	BP36912BBZ <sup>†</sup>	Pull	92	BP3702526	Knob	66
BP36904FB	Knob	91	BP36912CZ	Pull	92	BP37025CZ	Knob	66
BP36904G10	Knob	91	BP36912FB	Pull	92	BP37025G10	Knob	66

<sup>†</sup> Coming Soon

Mounting hardware included.  
Please direct any questions to Amerock Customer Care.

# Product Index

Product No.	Type	Pg	Product No.	Type	Pg	Product No.	Type	Pg
BP37025MB	Knob	66	BP37042CZ	Pull	83	BP37063ORB	Pull	60
BP37025ORB	Knob	66	BP37042G10	Pull	83	BP3707026	Pull	51
BP3702626	Knob	96	BP37042MB	Pull	83	BP37070CZ	Pull	51
BP37026CZ	Knob	96	BP37042ORB	Pull	83	BP37070G10	Pull	51
BP37026G10	Knob	96	BP3704326	Pull	83	BP37070MB	Pull	51
BP37026MB	Knob	96	BP37043CZ	Pull	83	BP37070ORB	Pull	51
BP3702726	Knob	64	BP37043G10	Pull	83	BP3707126	Pull	51
BP37027CZ	Knob	64	BP37043MB	Pull	83	BP37071CZ	Pull	51
BP37027G10	Knob	64	BP37043ORB	Pull	83	BP37071G10	Pull	51
BP37027MB	Knob	64	BP3705026	Pull	55	BP37071MB	Pull	51
BP3702826	Knob	37	BP37050CZ	Pull	55	BP37071ORB	Pull	51
BP37028G10	Knob	37	BP37050G10	Pull	55	BP3707226	Pull	51
BP37028MB	Knob	37	BP37050MB	Pull	55	BP37072CZ	Pull	51
BP37028ORB	Knob	37	BP37050ORB	Pull	55	BP37072G10	Pull	51
BP3702926	Knob	32	BP3705126	Pull	55	BP37072MB	Pull	51
BP37029MB	Knob	32	BP37051CZ	Pull	55	BP37072ORB	Pull	51
BP37029SS	Knob	32	BP37051G10	Pull	55	BP3707326	Pull	51
BP3703026	Pull	35	BP37051MB	Pull	55	BP37073CZ	Pull	51
BP37030CZ	Pull	35	BP37051ORB	Pull	55	BP37073G10	Pull	51
BP37030G10	Pull	35	BP3705226	Pull	55	BP37073MB	Pull	51
BP37030MB	Pull	35	BP37052CZ	Pull	55	BP37073ORB	Pull	51
BP37030ORB	Pull	35	BP37052G10	Pull	55	BP3709026	Pull	88
BP3703126	Pull	35	BP37052MB	Pull	55	BP37090CZ	Pull	88
BP37031CZ	Pull	35	BP37052ORB	Pull	55	BP37090G10	Pull	88
BP37031G10	Pull	35	BP3705326	Pull	55	BP37090MB	Pull	88
BP37031MB	Pull	35	BP37053CZ	Pull	55	BP37090ORB	Pull	88
BP37031ORB	Pull	35	BP37053G10	Pull	55	BP3709126	Pull	88
BP3703226	Pull	35	BP37053MB	Pull	55	BP37091CZ	Pull	88
BP37032CZ	Pull	35	BP37053ORB	Pull	55	BP37091G10	Pull	88
BP37032G10	Pull	35	BP3706026	Pull	60	BP37091MB	Pull	88
BP37032MB	Pull	35	BP37060CZ	Pull	60	BP37091ORB	Pull	88
BP37032ORB	Pull	35	BP37060G10	Pull	60	BP3709226	Pull	88
BP3703326	Pull	35	BP37060MB	Pull	60	BP37092CZ	Pull	88
BP37033CZ	Pull	35	BP37060ORB	Pull	60	BP37092G10	Pull	88
BP37033G10	Pull	35	BP3706126	Pull	60	BP37092MB	Pull	88
BP37033MB	Pull	35	BP37061CZ	Pull	60	BP37092ORB	Pull	88
BP37033ORB	Pull	35	BP37061G10	Pull	60	BP3709326	Pull	88
BP3704026	Pull	83	BP37061MB	Pull	60	BP37093CZ	Pull	88
BP37040CZ	Pull	83	BP37061ORB	Pull	60	BP37093G10	Pull	88
BP37040G10	Pull	83	BP3706226	Pull	60	BP37093MB	Pull	88
BP37040MB	Pull	83	BP37062CZ	Pull	60	BP37093ORB	Pull	88
BP37040ORB	Pull	83	BP37062G10	Pull	60	BP3712026	Pull	61
BP3704126	Pull	83	BP37062MB	Pull	60	BP37120CZ	Pull	61
BP37041CZ	Pull	83	BP37062ORB	Pull	60	BP37120G10	Pull	61
BP37041G10	Pull	83	BP3706326	Pull	60	BP37120MB	Pull	61
BP37041MB	Pull	83	BP37063CZ	Pull	60	BP37120ORB	Pull	61
BP37041ORB	Pull	83	BP37063G10	Pull	60	BP3712126	Pull	61
BP3704226	Pull	83	BP37063MB	Pull	60	BP37121CZ	Pull	61

Mounting hardware included.  
Please direct any questions to Amerock Customer Care.

† Coming Soon

# Product Index

Product No.	Type	Pg	Product No.	Type	Pg	Product No.	Type	Pg
BP37121G10	Pull	61	BP37141CZ	Pull	40	BP37175CZ	Pull	34
BP37121MB	Pull	61	BP37141G10	Pull	40	BP37175G10	Pull	34
BP37121ORB	Pull	61	BP37141MB	Pull	40	BP37175MB	Pull	34
BP3712226	Pull	61	BP3714226	Pull	40	BP3717626	Pull	34
BP37122CZ	Pull	61	BP37142CZ	Pull	40	BP37176CZ	Pull	34
BP37122G10	Pull	61	BP37142G10	Pull	40	BP37176G10	Pull	34
BP37122MB	Pull	61	BP37142MB	Pull	40	BP37176MB	Pull	34
BP37122ORB	Pull	61	BP3714326	Pull	41	BP3717726	Pull	34
BP3712326	Pull	61	BP37143CZ	Pull	41	BP37177CZ	Pull	34
BP37123CZ	Pull	61	BP37143G10	Pull	41	BP37177G10	Pull	34
BP37123G10	Pull	61	BP37143MB	Pull	41	BP37177MB	Pull	34
BP37123MB	Pull	61	BP3714426	Pull	41	BP3717826	Pull	34
BP37123ORB	Pull	61	BP37144CZ	Pull	41	BP37178CZ	Pull	34
BP3713026	Pull	38	BP37144G10	Pull	41	BP37178G10	Pull	34
BP37130CZ	Pull	38	BP37144MB	Pull	41	BP37178MB	Pull	34
BP37130G10	Pull	38	BP3715026	Pull	20	BP3718026	Cup Pull	59
BP37130MB	Pull	38	BP37150CZ	Pull	20	BP37180CZ	Cup Pull	59
BP37130ORB	Pull	38	BP37150G10	Pull	20	BP37180G10	Cup Pull	59
BP3713126	Pull	38	BP37150MB	Pull	20	BP37180MB	Cup Pull	59
BP37131CZ	Pull	38	BP3715126	Pull	21	BP37180ORB	Cup Pull	59
BP37131G10	Pull	38	BP37151CZ	Pull	21	BP3719026	Edge Pull	84
BP37131MB	Pull	38	BP37151G10	Pull	21	BP37190CZ	Edge Pull	84
BP37131ORB	Pull	38	BP37151MB	Pull	21	BP37190G10	Edge Pull	84
BP3713226	Pull	38	BP3715226	Pull	21	BP37190MB	Edge Pull	84
BP37132CZ	Pull	38	BP37152CZ	Pull	21	BP3719126	Edge Pull	85
BP37132G10	Pull	38	BP37152G10	Pull	21	BP37191CZ	Edge Pull	85
BP37132MB	Pull	38	BP37152MB	Pull	21	BP37191G10	Edge Pull	85
BP37132ORB	Pull	38	BP3715326	Pull	21	BP37191MB	Edge Pull	85
BP3713326	Pull	39	BP37153CZ	Pull	21	BP3719226	Edge Pull	85
BP37133CZ	Pull	39	BP37153G10	Pull	21	BP37192CZ	Edge Pull	85
BP37133G10	Pull	39	BP37153MB	Pull	21	BP37192G10	Edge Pull	85
BP37133MB	Pull	39	BP3716026	Pull	36	BP37192MB	Edge Pull	85
BP37133ORB	Pull	39	BP37160CZ	Pull	36	BP3719326	Edge Pull	85
BP3713426	Pull	39	BP37160G10	Pull	36	BP37193CZ	Edge Pull	85
BP37134CZ	Pull	39	BP37160MB	Pull	36	BP37193G10	Edge Pull	85
BP37134G10	Pull	39	BP3716126	Pull	36	BP37193MB	Edge Pull	85
BP37134MB	Pull	39	BP37161CZ	Pull	36	BP3719426	Edge Pull	85
BP37134ORB	Pull	39	BP37161G10	Pull	36	BP37194CZ	Edge Pull	85
BP3713526	Pull	39	BP37161MB	Pull	36	BP37194G10	Edge Pull	85
BP37135CZ	Pull	39	BP3716226	Pull	36	BP37194MB	Edge Pull	85
BP37135G10	Pull	39	BP37162CZ	Pull	36	BP3720026	Edge Pull	86
BP37135MB	Pull	39	BP37162G10	Pull	36	BP37200CZ	Edge Pull	86
BP37135ORB	Pull	39	BP37162MB	Pull	36	BP37200G10	Edge Pull	86
BP3714026	Pull	40	BP3716326	Pull	36	BP37200MB	Edge Pull	86
BP37140CZ	Pull	40	BP37163CZ	Pull	36	BP3720126	Edge Pull	86
BP37140G10	Pull	40	BP37163G10	Pull	36	BP37201CZ	Edge Pull	86
BP37140MB	Pull	40	BP37163MB	Pull	36	BP37201G10	Edge Pull	86
BP3714126	Pull	40	BP3717526	Pull	34	BP37201MB	Edge Pull	86

† Coming Soon

Mounting hardware included.  
Please direct any questions to Amerock Customer Care.

# Product Index

Product No.	Type	Pg	Product No.	Type	Pg	Product No.	Type	Pg
BP3720226	Edge Pull	86	BP3723126	Pull	90	BP37292G10	Pull	67
BP37202CZ	Edge Pull	86	BP37231CZ	Pull	90	BP37292MB	Pull	67
BP37202G10	Edge Pull	86	BP37231FB	Pull	90	BP3729326	Pull	68
BP37202MB	Edge Pull	86	BP37231G10	Pull	90	BP37293CZ	Pull	68
BP3720326	Edge Pull	86	BP37231ORB	Pull	90	BP37293G10	Pull	68
BP37203CZ	Edge Pull	86	BP3723226	Pull	90	BP37293MB	Pull	68
BP37203G10	Edge Pull	86	BP37232CZ	Pull	90	BP3729426	Pull	68
BP37203MB	Edge Pull	86	BP37232FB	Pull	90	BP37294CZ	Pull	68
BP3720426	Edge Pull	86	BP37232G10	Pull	90	BP37294G10	Pull	68
BP37204CZ	Edge Pull	86	BP37232ORB	Pull	90	BP37294MB	Pull	68
BP37204G10	Edge Pull	86	BP3724026	Pull	32	BP3729526	Knob	87
BP37204MB	Edge Pull	86	BP37240MB	Pull	32	BP37295CZ	Knob	87
BP3721026	Pull	43	BP37240SS	Pull	32	BP37295G10	Knob	87
BP37210CZ	Pull	43	BP3724126	Pull	32	BP37295MB	Knob	87
BP37210G10	Pull	43	BP37241MB	Pull	32	BP3729926†	Pull	16
BP37210MB	Pull	43	BP37241SS	Pull	32	BP37299CZ†	Pull	16
BP3721126	Pull	43	BP3724226	Pull	32	BP37299G10†	Pull	16
BP37211CZ	Pull	43	BP37242MB	Pull	32	BP37299MB†	Pull	16
BP37211G10	Pull	43	BP37242SS	Pull	32	BP3730026	Pull	16
BP37211MB	Pull	43	BP3724326	Pull	33	BP37300CZ	Pull	16
BP3721226	Pull	43	BP37243MB	Pull	33	BP37300G10	Pull	16
BP37212CZ	Pull	43	BP37243SS	Pull	33	BP37300MB	Pull	16
BP37212G10	Pull	43	BP3724426	Pull	33	BP3730126	Pull	16
BP37212MB	Pull	43	BP37244MB	Pull	33	BP37301CZ	Pull	16
BP3721326	Pull	43	BP37244SS	Pull	33	BP37301G10	Pull	16
BP37213CZ	Pull	43	BP3724526	Pull	33	BP37301MB	Pull	16
BP37213G10	Pull	43	BP37245MB	Pull	33	BP3730226	Pull	17
BP37213MB	Pull	43	BP37245SS	Pull	33	BP37302CZ	Pull	17
BP37220CH	Pull	54	BP3724626	Pull	33	BP37302G10	Pull	17
BP37220CZ	Pull	54	BP37246MB	Pull	33	BP37302MB	Pull	17
BP37220FB	Pull	54	BP37246SS	Pull	33	BP3730326	Pull	17
BP37220G10	Pull	54	BP3724726	Pull	33	BP37303CZ	Pull	17
BP37220ORB	Pull	54	BP37247MB	Pull	33	BP37303G10	Pull	17
BP37221CH	Pull	54	BP37247SS	Pull	33	BP37303MB	Pull	17
BP37221CZ	Pull	54	BP3728926†	Pull	66	BP3730426†	Pull	16
BP37221FB	Pull	54	BP37289CZ†	Pull	66	BP37304CZ†	Pull	16
BP37221G10	Pull	54	BP37289G10†	Pull	66	BP37304G10†	Pull	16
BP37221ORB	Pull	54	BP37289MB†	Pull	66	BP37304MB†	Pull	16
BP37222CH	Pull	54	BP3729026	Pull	67	BP3730926†	Pull	96
BP37222CZ	Pull	54	BP37290CZ	Pull	67	BP37309CZ†	Pull	96
BP37222FB	Pull	54	BP37290G10	Pull	67	BP37309G10†	Pull	96
BP37222G10	Pull	54	BP37290MB	Pull	67	BP37309MB†	Pull	96
BP37222ORB	Pull	54	BP3729126	Pull	67	BP3731026	Pull	97
BP3723026	Pull	89	BP37291CZ	Pull	67	BP37310CZ	Pull	97
BP37230CZ	Pull	89	BP37291G10	Pull	67	BP37310G10	Pull	97
BP37230FB	Pull	89	BP37291MB	Pull	67	BP37310MB	Pull	97
BP37230G10	Pull	89	BP3729226	Pull	67	BP3731126	Pull	97
BP37230ORB	Pull	89	BP37292CZ	Pull	67	BP37311CZ	Pull	97

Mounting hardware included.  
Please direct any questions to Amerock Customer Care.

† Coming Soon



# Product Index

Product No.	Type	Pg	Product No.	Type	Pg	Product No.	Type	Pg
BP37311G10	Pull	97	BP37347ORB	Pull	76	BP40518PN	Pull	25
BP37311MB	Pull	97	BP3734826†	Pull	76	BP4051926	Pull	26
BP3731226	Pull	97	BP37348CZ†	Pull	76	BP40519BBR	Pull	26
BP37312CZ	Pull	97	BP37348G10†	Pull	76	BP40519BBZ	Pull	26
BP37312G10	Pull	97	BP37348MB†	Pull	76	BP40519CZ	Pull	26
BP37312MB	Pull	97	BP37348ORB†	Pull	76	BP40519GM	Pull	26
BP3732126	Knob	77	BP37355CZ	Pull	18	BP40519ORB	Pull	26
BP37321CZ	Knob	77	BP37355MB	Pull	18	BP40519PN	Pull	30
BP37321G10	Knob	77	BP37355ORB	Pull	18	BP4052026	Pull	24
BP37321MB	Knob	77	BP3735626	Pull	18	BP40520BBR	Pull	24
BP3732226	Pull	75	BP37356CZ	Pull	18	BP40520BBZ†	Pull	24
BP37322CZ	Pull	75	BP37356G10	Pull	18	BP40520CSG9	Pull	24
BP37322G10	Pull	75	BP37356MB	Pull	18	BP40520CZ	Pull	24
BP37322MB	Pull	75	BP37356ORB	Pull	18	BP40520ORB	Pull	24
BP3732326	Pull	75	BP3735726	Pull	19	BP40520PN†	Pull	24
BP37323CZ	Pull	75	BP37357CZ	Pull	19	BP40520SS†	Pull	24
BP37323G10	Pull	75	BP37357G10	Pull	19	BP4052126	Pull	26
BP37323MB	Pull	75	BP37357MB	Pull	19	BP40521BBR	Pull	26
BP3732426	Pull	75	BP37357ORB	Pull	19	BP40521BBZ†	Pull	26
BP37324CZ	Pull	75	BP4051526	Pull	23	BP40521CSG9	Pull	26
BP37324G10	Pull	75	BP40515BBR	Pull	23	BP40521CZ	Pull	26
BP37324MB	Pull	75	BP40515BBZ	Pull	23	BP40521ORB	Pull	26
BP3733026	Knob	56	BP40515CZ	Pull	23	BP40521PN†	Pull	26
BP37330CZ	Knob	56	BP40515GM	Pull	23	BP40521SS†	Pull	26
BP37330G10	Knob	56	BP40515ORB	Pull	23	BP5300326	Pull	90
BP37330MB	Knob	57	BP40515PN	Pull	23	BP53003CZ	Pull	90
BP3733526	Knob	87	BP4051626	Pull	23	BP53003FB	Pull	90
BP37335CZ	Knob	87	BP40516BBR	Pull	23	BP53003G10	Pull	90
BP37335G10	Knob	87	BP40516BBZ	Pull	23	BP53003ORB	Pull	90
BP37335MB	Knob	87	BP40516CZ	Pull	23	BP5300526	Knob	49
BP3734026	Knob	20	BP40516GM	Pull	23	BP530053	Knob	49
BP37340CZ	Knob	20	BP40516ORB	Pull	23	BP53005AS	Knob	49
BP37340G10	Knob	20	BP40516PN	Pull	23	BP53005BB	Knob	49
BP37340MB	Knob	20	BP4051726	Pull	24	BP53005BBZ	Knob	49
BP3734526	Pull	76	BP40517BBR	Pull	24	BP53005CZ	Knob	49
BP37345CZ	Pull	76	BP40517BBZ	Pull	24	BP53005FB	Knob	49
BP37345G10	Pull	76	BP40517CZ	Pull	24	BP53005G10	Knob	49
BP37345MB	Pull	76	BP40517GM	Pull	24	BP53005ORB	Knob	49
BP37345ORB	Pull	76	BP40517ORB	Pull	24	BP53005PN	Knob	49
BP3734626	Pull	76	BP40517PN	Pull	24	BP5301026	Cup Pull	42
BP37346CZ	Pull	76	BP4051826	Pull	25	BP53010BBZ	Cup Pull	42
BP37346G10	Pull	76	BP40518BBR	Pull	25	BP53010CZ	Cup Pull	42
BP37346MB	Pull	76	BP40518BBZ	Pull	25	BP53010FB	Cup Pull	42
BP37346ORB	Pull	76	BP40518CZ	Pull	25	BP53010G10	Cup Pull	42
BP3734726	Pull	76	BP40518GM	Pull	25	BP53010ORB	Cup Pull	42
BP37347CZ	Pull	76	BP40518ORB	Pull	25	BP53010PN	Cup Pull	42
BP37347G10	Pull	76						
BP37347MB	Pull	76						

† Coming Soon

Mounting hardware included.  
Please direct any questions to Amerock Customer Care.

# Product Index

Product No.	Type	Pg	Product No.	Type	Pg	Product No.	Type	Pg
BP5301226	Knob	78	BP54045ORB	Appliance Pull	74	BP55533CZ†	Appliance Pull	95
BP53012CZ	Knob	78	BP54045PN	Appliance Pull	74	BP55533FB†	Appliance Pull	95
BP53012FB	Knob	78	BP5404626	Appliance Pull	74	BP55533G10†	Appliance Pull	95
BP53012G10	Knob	78	BP54046BBZ	Appliance Pull	74	BP55533PN†	Appliance Pull	95
BP53012ORB	Knob	78	BP54046CZ	Appliance Pull	74	BP5553426†	Pull	94
BP5301326	Pull	57	BP54046FB	Appliance Pull	74	BP55534BBZ†	Pull	94
BP53013CZ	Pull	57	BP54046G10	Appliance Pull	74	BP55534CZ†	Pull	94
BP53013FB	Pull	57	BP54046ORB	Appliance Pull	74	BP55534FB†	Pull	94
BP53013G10	Pull	57	BP54046PN	Appliance Pull	74	BP55534G10†	Pull	94
BP53013ORB	Pull	57	BP5524326	Pull	57	BP55534PN†	Pull	94
BP53013PN	Pull	57	BP55243CZ	Pull	57	BP5553526†	Appliance Pull	95
BP5301426	Knob	89	BP55243FB	Pull	57	BP55535BBZ†	Appliance Pull	95
BP53014CZ	Knob	89	BP55243G10	Pull	57	BP55535CZ†	Appliance Pull	95
BP53014FB	Knob	89	BP55243ORB	Pull	57	BP55535FB†	Appliance Pull	95
BP53014G10	Knob	89	BP55243PN	Pull	57	BP55535G10†	Appliance Pull	95
BP53014ORB	Knob	89	BP5524426	Pull	58	BP55535PN†	Appliance Pull	95
BP5400826	Appliance Pull	30	BP55244CZ	Pull	58	BP69153G10	Pull	18
BP54008BBR	Appliance Pull	30	BP55244FB	Pull	58	BP6915826†	Pull	19
BP54008BBZ	Appliance Pull	30	BP55244G10	Pull	58	BP69158CZ†	Pull	19
BP54008CSG9	Appliance Pull	30	BP55244ORB	Pull	58	BP69158G10†	Pull	19
BP54008CZ	Appliance Pull	30	BP55244PN	Pull	58	BP69158MB†	Pull	19
BP54008GM	Appliance Pull	30	BP5524526	Pull	58	BP69158ORB†	Pull	19
BP54008ORB	Appliance Pull	30	BP55245CZ	Pull	58	BP76312CS26	Pull	98
BP54008PN	Appliance Pull	30	BP55245FB	Pull	58	BP76312CS26D	Pull	98
BP54008SS	Appliance Pull	30	BP55245G10	Pull	58	BP76312CSG10	Pull	98
BP5402526	Appliance Pull	30	BP55245ORB	Pull	58	BP76312MB	Pull	98
BP54025BBR	Appliance Pull	30	BP55245PN	Pull	58	BP76312ORB	Pull	98
BP54025BBZ	Appliance Pull	30	BP5553026†	Pull	91	BP76313CS26	Pull	98
BP54025CSG9†	Appliance Pull	30	BP55530BBZ†	Pull	91	BP76313CS26D	Pull	98
BP54025CZ	Appliance Pull	30	BP55530CZ†	Pull	91	BP76313CSG10	Pull	98
BP54025ORB	Appliance Pull	30	BP55530FB†	Pull	91	BP76313MB	Pull	98
BP54025PN	Appliance Pull	30	BP55530G10†	Pull	91	BP76313ORB	Pull	98
BP54025SS	Appliance Pull	30	BP55530PN†	Pull	91	BP865CS26	Pull	98
BP5402626	Appliance Pull	31	BP5553126†	Pull	93	BP865CS26D	Pull	98
BP54026BBR	Appliance Pull	31	BP55531BBZ†	Pull	93	BP865CSG10	Pull	98
BP54026BBZ	Appliance Pull	31	BP55531CZ†	Pull	93	BP865MB	Pull	98
BP54026CSG9	Appliance Pull	31	BP55531FB†	Pull	93	BP865ORB	Pull	98
BP54026CZ	Appliance Pull	31	BP55531G10†	Pull	93	BP867CS26D	Pull	98
BP54026GM	Appliance Pull	31	BP55531PN†	Pull	93	BP867CSG10	Pull	98
BP54026ORB	Appliance Pull	31	BP5553226†	Pull	94	BP936226	Pull	44
BP54026PN	Appliance Pull	31	BP55532BBZ†	Pull	94	BP9362BBR	Pull	44
BP54026SS	Appliance Pull	31	BP55532CZ†	Pull	94	BP9362BBZ	Pull	44
BP5404526	Appliance Pull	74	BP55532FB†	Pull	94	BP9362CZ	Pull	44
BP54045BBZ	Appliance Pull	74	BP55532G10†	Pull	94	BP9362G10	Pull	44
BP54045CZ	Appliance Pull	74	BP55532PN†	Pull	94	BP9362ORB	Pull	44
BP54045FB	Appliance Pull	74	BP5553326†	Appliance Pull	95	BP9362PN	Pull	44
BP54045G10	Appliance Pull	74	BP55533BBZ†	Appliance Pull	95			

Mounting hardware included.  
Please direct any questions to Amerock Customer Care.

† Coming Soon

# Center-to-Center Measuring Tool



Replacing a pull,  
**but not sure what  
size you need?**

**Place the pull's screw holes on  
the ruler** on the right to find its  
center-to-center (CTC).

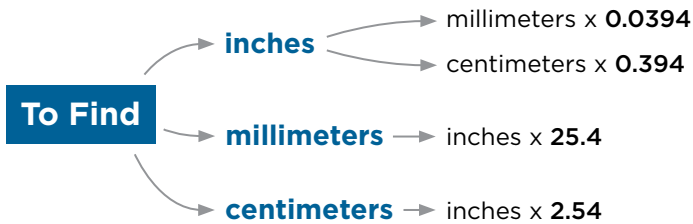
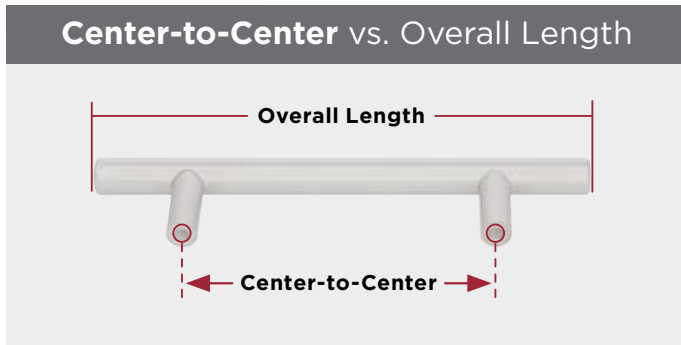
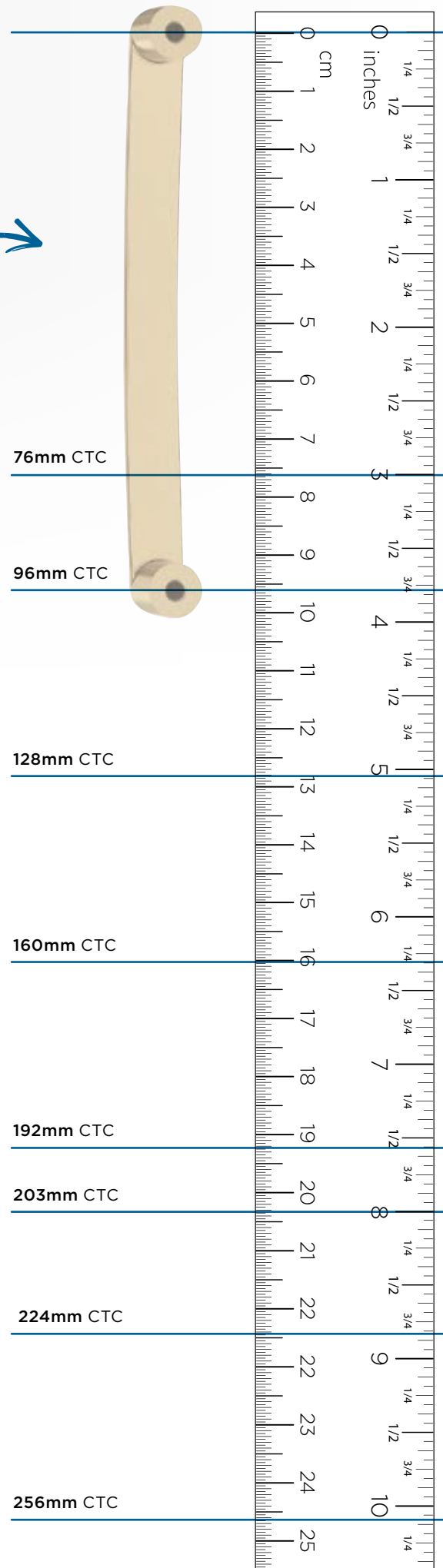

**Metric & U.S. Conversions**

mm	inch	mm	inch
1	1/32	0.031	
1.5	1/16	0.063	
3	1/8	0.125	
5	3/16	0.188	
6	1/4	0.250	
8	5/16	0.313	
9.5	3/8	0.375	
11	7/16	0.438	
13	1/2	0.500	
		14	9/16
		16	5/8
		17.5	11/16
		19	3/4
		20.5	13/16
		22	7/8
		24	15/16
		25.4	1



## Contact us.

[amerock.customersupport@amerock.com](mailto:amerock.customersupport@amerock.com)

P: 1-800-435-6959

F: 1-800-618-6733

10115 Kinsey Ave, Suite 210  
Huntersville, NC 28078

[Amerock.com](http://Amerock.com)



©2023