

# CL Series Residential Locks

## Value Product

The return of the Comet brings with it the exceptional value and quality required to meet the demands of the single and multi-family housing markets, as well as light commercial applications.

Combining a variety of lever designs, convenient installation and the Arrow benchmark for dependability, the CL Series is perfect in most any space.

### Certification:

The CL Series has been designed to meet the requirements of ANSI, A156.2, Series 4000, Grade 2.

### Features:

**Construction** – Tubular chassis

**Backset** – Universal latch is standard. Adjustable for both 2-3/8" (60mm) or 2-3/4" (70mm).

**Latch** – Brass front. Supplied standard with 1" x 2-1/4" (25mm x 57mm) square corner, 1" x 2-1/4" radius corner and 1-1/8" x 2-1/4" (29mm x 57mm) square corner latch fronts. Available with drive-in latches.

**Strike** – 1-5/8" x 2-1/4" (41mm x 57mm) full lip strike standard. Available with 1-1/8" x 2-3/4" (29mm x 70mm) "T" strike, or 1-1/4" x 4-7/8" (32mm x 124mm) ANSI strike.

**Door Thickness** – Fits 1-3/8" to 1-3/4" (35mm-44mm) doors standard.

**Exposed Trim** – Levers are zinc based and are plated to match finish requirements.

### Finishes:

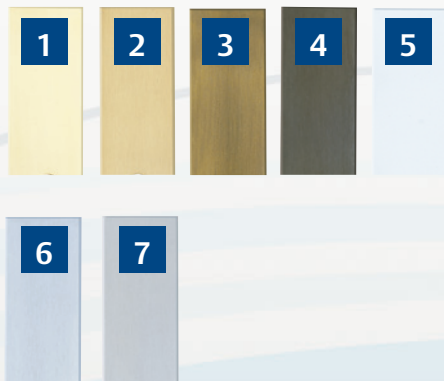

### ADA/Americans with Disabilities Act:

#### Acceptable Door Hardware: Section 4.13.9

Handles, pulls, latches and other operating devices on accessible doors shall have a shape that is easy to grasp with one hand and does not require grasping, tight pinching or twisting of the wrist to operate. Lever operated mechanisms, push-type mechanisms and "U" shaped handles are acceptable designs.

 Look for the universal symbol next to Arrow products that comply with ADA accessibility requirements.

**Mounting** – Leversets are supplied with concealed screws on inside rose.

**Cylinder** – Standard: Solid brass, 6-pin, pinned 5, 2 brass keys. Options: Arrow A or sectional keyways, Schlage C keyway.

**Finishes** – US3, US5, US26, US26D, US15.

**Packaging** – Leversets are packed 1 per box, 20 per carton.

**Warranty** – 5 year mechanical, 5 year finish.

	BMHA	U.S. Equiv	Arrow Equiv	Finish
1	605	US3	03	Bright Brass
2	606	US4	04	Satin Brass
3	609	US5	05A	Satin Brass, Blackened
4	614	US10BL	10BP	Dark Oxide Bronze, Clear Coated
5	625	US26	26	Bright Chromium Plated
6	626	US26D	26D	Satin Chromium Plated
7	619	US15	15	Nickel Plated

Experience a safer  
and more open world



**ASSA ABLOY**

# CL Series Residential Locks

Value Product

## Lever designs

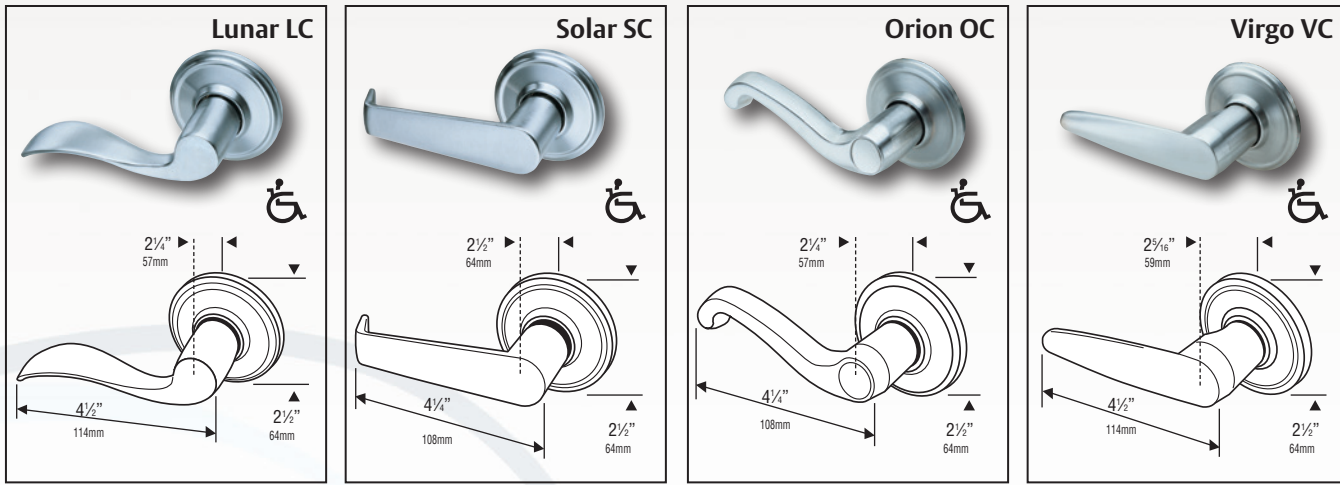

## CL Series cylinders

**Cylinder** – Standard: Solid brass, 6-pin, pinned 5, 2 brass keys. Options: Arrow A or sectional keyways, Schlage C keyway.

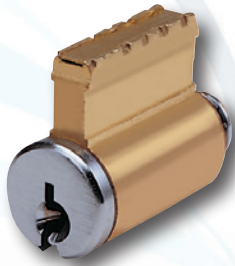

Experience a safer  
and more open world

**ARROW**<sup>™</sup>  
LOCK & DOOR HARDWARE  
**ASSA ABLOY**

# CL Series Residential Locks

## Value Product

### Latches & Strikes:

#### Latches

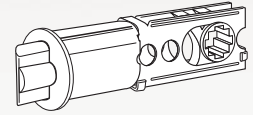
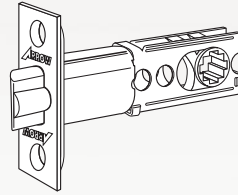
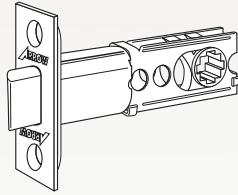

**Spring Latch**

**Dead Latch**

**Drive-In**

2-3/8" - 2-3/4"  
Adjustable Backset

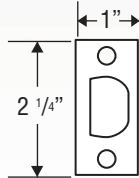

#501 Standard

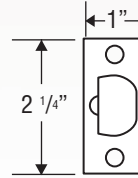

#511 Standard



Spring Latch  
#505



Dead Latch  
#515

Note: Standard latch provided with these three faceplates.

- 1" x 2-1/4" square corner
- 1" x 2-1/4" radius corner
- 1-1/8" x 2-1/4" square corner

Note: Standard latch provided with these three faceplates.

- 1" x 2-1/4" square corner
- 1" x 2-1/4" radius corner
- 1-1/8" x 2-1/4" square corner

### Accessories:

#### Strikes

#502-Standard

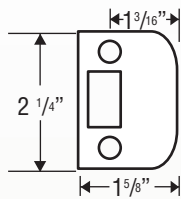

#506-Optional

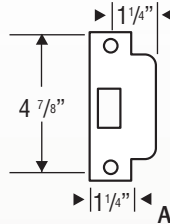

ASA  
ANSI 115.2

#500-Optional

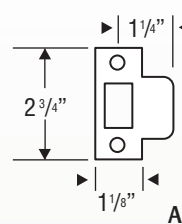

T  
ANSI 115.3

#503-Optional

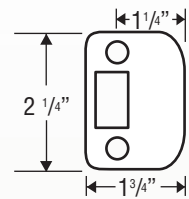

### Installation:



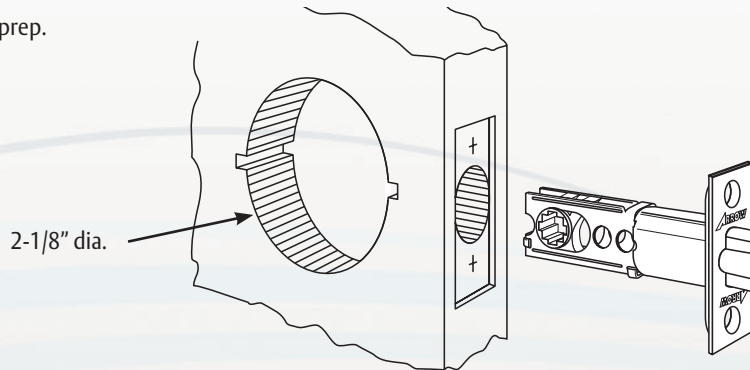

Standard 2-1/8" door prep.

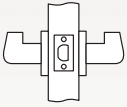
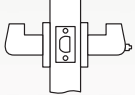
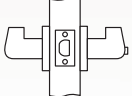

Experience a safer  
and more open world

# CL Series Residential Locks

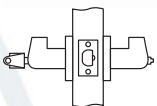
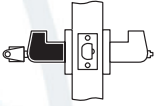
## Value Product

ARROW STANDARD	FUNCTION		DESCRIPTION
CL01	Passage		Latchbolt operated by knob/lever either side.
CL02	Privacy		Latchbolt operated by knob/lever either side except when inside turnbutton locks outside. Unlocked by rotating button or by using tool outside.
CL04	Patio		Both knob/levers locked by inside button. Deadlocking latch standard.
CL08	1/2 Dummy Trim		Rigid trim for one side of door only. Used as pull or to match active trim.
CL11	Entrance		Latchbolt operated by knob/lever either side except when outside knob/lever is locked by turn-button inside. When outside knob/lever is locked, latchbolt operated by key outside or turning inside knob/lever. Inside button must be manually released.
CL12	Storeroom		Outside knob/lever always rigid. Latchbolt operated by key in outside knob/lever, or by turning inside knob/lever.
			Indicates knob/lever rigid at all times.

### Order Example:

**Example:** To order a CL Series entry function lockset with a Virgo design lever, satin chrome finish, with a full lip strike and adjustable backset, keyed different:

Specify:

Standard:	<u>CL</u>	<u>11</u>	<u>VC</u>	<u>26D</u>	<u>502</u>	<u>511</u>	<u>KD</u>	<u>XXX</u>
	Series	Function	Design	Finish	Strike	Latch	Keying	Options (if required)

Experience a safer  
and more open world