

# RK Series Cylindrical Locksets

## Value Product

The RK Series has been enhanced to offer a wide variety of finishes and functions. The RK Series cylindrical locksets are an economical value for a variety of application. Perfect for multi-family housing markets, as well as light commercial applications.



### Certification:

The RK Series has been designed to meet the requirements of ANSI, A156.2, Series 4000, Grade 2 UL Listed for use on 3 hour, A label single swinging doors.



### Features:

**Construction** – Cold rolled steel with zinc dichromate finish for corrosion resistance. Requires standard 2-1/8" (54mm) bore through door.

**Backset** – 2-3/8" (60mm) or 2-3/4" (70mm).

**Door Thickness** – Fits 1-3/8" (35mm) to 1-3/4" (44mm) doors standard.

**Latch** – Brass 1/2" (13mm) throw, UL Listed, guarded latchbolt on all locking functions.

**Latch Front** – 1" x 2-1/4" (25mm x 57mm) for 2-3/8" backset (60mm) or 1-1/8" x 2-1/4" for 2-3/4" (70mm) backset.

**Exposed Trim** – Brass or stainless steel. Roses are 2-1/2" (64mm) diameter. Total projection from face of door is 2-3/4" (70mm).

**Strike** – 4-7/8" ANSI (124mm), 2-3/4" (70mm) T strike, or 2-1/4" (57mm) full lip strike.

**Cylinder** – Standard: solid brass, 6-pin, keyed different, Arrow A or Schlage C keyway. Optional: prep for small format interchangeable.

**Keys** – 2 brass keys.

**Handing** – Non-handed.

**Thru-bolts** – Removable thru-bolts standard on RL Series.

**Packaging** – 10 per case.

**Warranty** – Five Year Mechanical Warranty.

### Finishes:



	BHMA	U.S. Equivalent	Arrow Equivalent	Finish
1	605	US3	03	Bright Brass
2	606	US4	04	Satin Brass
3	613	US10B	10B	Dark Oxide Bronze, Oil Rubbed
4	629	US32	32	Bright Stainless Steel
5	630	US32D	32D	Satin Stainless Steel

Experience a safer  
and more open world



# RK Series Cylindrical Locksets

## Value Product

RK Series knob designs:

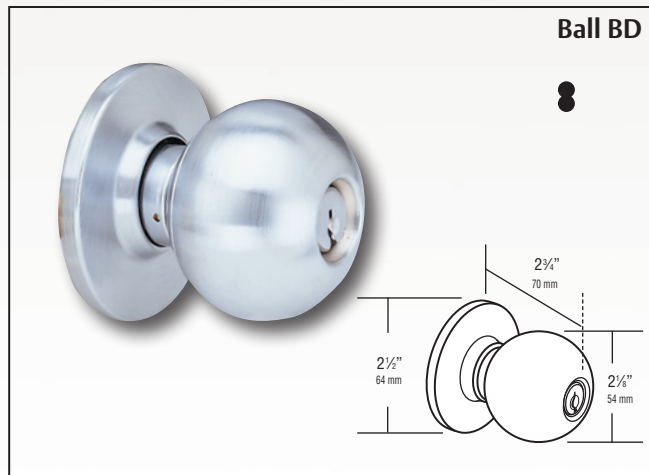

## R Series cylinders:

Solid Brass 6 pin cylinder pinned 5 for RK, pinned 6 for RL.  
"A" Keyway standard. Arrow sectional keyways available.  
US4, US26D finish.

## Tailpieces:

PART #	SERIES
1001-44	RL Series
550RK-44	RK Series

## Interchangeable Core:

Look for this symbol to indicate availability of product with interchangeable core design.

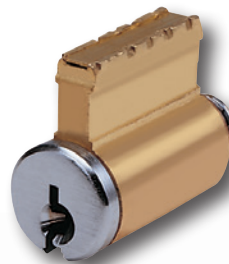

## Cylinder Part

#100C-RK – RK Series

#600HD – RL Series

# RK Series Cylindrical Locksets

## Value Product

### Latches & Strikes:

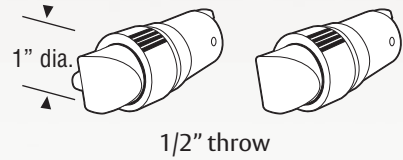
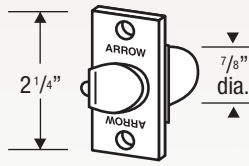
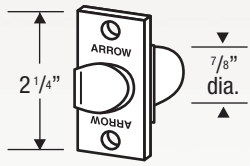

#### Latch Standards

#### UL Spring Latches

#### UL Dead Latches

#### Drive-In Latches

#### 2-3/8" Backset



#### 2-3/4" Backset

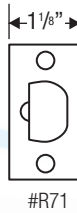

### Accessories:

#### Strikes

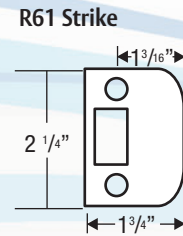
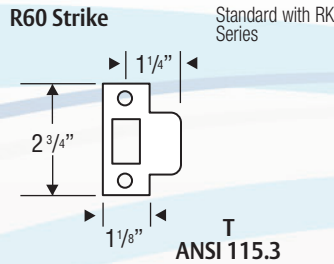
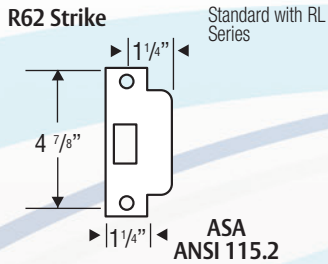

### Installation:



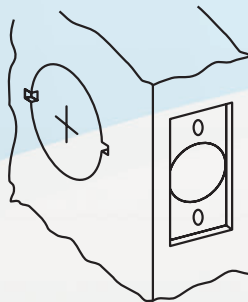

161 prep for retrofit and secure installation.

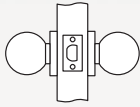
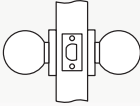

Experience a safer  
and more open world

# RK Series Cylindrical Locksets

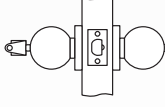
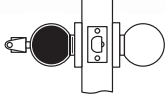
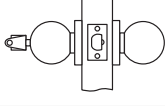
## Value Product

ARROW STANDARD	FUNCTION		DESCRIPTION
RK01	Passage		Latchbolt operated by knob either side.
RK02	Privacy		Latch operated by knob either side except when outside knob is locked by pushing inside button. Outside knob unlocked by turning inside knob, using emergency key, or closing door. Inside knob always operates latch.
RK08	1/2 Dummy Trim		Rigid trim for one side of door only. Used as pull or to match active trim.
RK11	Entrance		Latchbolt operated by knob either side except when outside knob is locked by turn-button inside. When outside knob is locked, latchbolt operated by key outside or turning inside knob. Inside button must be manually released.
RK12	Storeroom		Outside knob always rigid. Latchbolt operated by key in outside knob, or by turning inside knob.
RK17	Classroom		Latchbolt operated by knob either side except when key outside locks outside knob. Inside knob always free. Key outside locks/unlocks outside knob only.
			Indicates knob rigid at all times.

## Order Example:

**Example:** To order a RK Series entry function lockset with a Ball design knob, satin stainless steel finish, with a R60 strike, and 2-3/4" deadlocking latch, keyed different:

Specify:

Standard:	<u>RK</u>	<u>11</u>	<u>BD</u>	<u>32D</u>	<u>R60</u>	<u>R71</u>	<u>KD</u>	<u>XXX</u>
	Series	Function	Design	Finish	Strike	Latch	Keying	Options (if required)

Experience a safer  
and more open world