

DON-JO MFG., INC.

ARCHITECTURAL HARDWARE & ACCESSORIES

WRAP-AROUND PLATES



PHONE: 978.422.3377
FAX: 978.422.3467
Toll Free: 800.628.8389
Toll Free Fax: 800.278.8202

www.don-jo.com
info@don-jo.com
Section F, Version 2



New Products from **DON-JO** MFG., INC.

Inactive Door Wrap Around with ASA Strike Prep

An Industry First!

Wrap Around for the inactive door. Prepared and reinforced to accept 4 7/8" ASA Strike or 2 3/4" T-Strike.*
Ready out of the box. No additional assembly required.



478-CW



478-FE

NUMBER	DOOR	DIMENSIONS
478-CW	1 3/4"	5" x 12"
478-FE	1 3/4"	1" x 12"
234-CW	1 3/4"	5" x 4 1/2"
234-FE	1 3/4"	1" x 4 1/2"

SHELF PACK: 1 Box Pack
GAUGE: 22 (.032)
FEATURES: Non-Handed
FINISHES: 10B (613), PB (605), S (630)
*strike sold separately

Hinge Side Wrap Around with Integral Hinge Reinforcement

Wrap Around to repair hinge side of door. Prepared and reinforced to accept 4 1/2" and 5" commercial hinge.*
Ready out of the box. No additional assembly required.

NUMBER	DOOR THICKNESS	HINGE HEIGHT	SIZE
45-CW	1 3/4"	4 1/2"	3" x 12"
50-CW	1 3/4"	5"	3" x 12"
45-FE	1 3/4"	4 1/2"	1" x 12"
50-FE	1 3/4"	5"	1" x 12"

SHELF PACK: 1 Box Pack
GAUGE: 22 (.032)
FEATURES: Non-Handed
FINISHES: 10B (613), PB (605), S (630)
*hinge sold separately



45-FE

INDEX

MODEL	PAGE #	MODEL	PAGE #	MODEL	PAGE #	MODEL	PAGE #
1-CW	3f	20B-CW	6f	61-CW	3f	478-FE	1f
2-CW	3f	20C-CW	6f	70-CW	5f	481-CW	4f
3-CW	3f	20-FE	11f	71-CW	3f	484-CW	4f
4-CW	3f	21-CW	9f	75-CW	6f	486-CW	5f
4-2-CW	6f	22-CW	9f	80-CW	5f	504-CW	10f
4U-2-CW	10f	23-CW	9f	81-CW	3f	504-FE	10f
5-CW	3f	24-CW	9f	81-2-CW	6f	504AD-CW	9f
5K-CW	6f	25-CW	8f	90-CW	5f	504CO-CW	9f
6-CW	3f	26AD-CW	9f	93-KV-CW	8f	514-CW	10f
7-CW	3f	26CO-CW	9f	95-CW	6f	518-CW	8f
8-CW	3f	27-CW	7f	151-CW	4f	942-CW	4f
9-CW	7f	28-CW	8f	154-CW	4f	943-CW	4f
9K-CW	6f	30-CW	5f	200-CW	11f	946-CW	5f
10-FE	11f	33-CW	11f	200C-CW	11f	4000-2-CW	7f
12-CW	5f	33A-CW	11f	212-CW	11f	4000-4-CW	7f
12-2-CW	5f	33A-2-CW	11f	212C-CW	11f	4500-CW	10f
14-CW	7f	40-CW	5f	214-CW	11f	4550-CW	10f
14-2-CW	7f	45-CW	1f	214C-CW	11f	5000-CW	7f
15-CW	7f	45-FE	1f	234-CW	1f	5100-CW	9f
16-CW	8f	50-CW	1f	234-FE	1f	6200-CW	7f
17-CW	8f	50-FE	1f	256-CW	5f	7100-CW	7f
18-CW	8f	51-CW	3f	258-CW	5f	E2000-CW	7f
19-CW	9f	55-CW	11f	261-CW	4f	Flat Fronts	12f
20-CW	6f	55A-CW	11f	264-CW	4f	Quote Form	13f
20-2-CW	6f	55A-2-CW	11f	478-CW	1f		

FASTENERS

PRODUCT	FASTENING TYPE
All Wrap-Arounds	Trim Screws: 4 ea. #8 x 3/4" Phillips Truss Head Latch Screws: 2 ea. #8-32 x 1/4" Flat Head (per latch)
CW-504 & CW-514	Trim Screws: 2 ea. 1/4-20 x 3/4" MS Truss Head and 1/4-20 x 1 1/2" Sex Nut Latch Screws: #12-24 x 1/2" FHMS

CLASSIC WRAP-AROUNDS

For **CYLINDRICAL DOOR LOCKS** with 2 1/8" hole

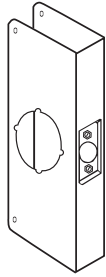

**1-CW
2-CW
3-CW
4-CW**

Display Packaged also available. When ordering indicate by replacing the letters "CW" with "V" after the item number.

Display Package Size - 5 1/4" x 11"

NUMBER	BACKSET	DOOR	DIMENSIONS
1-CW	2 3/8"	1 3/8"	4" x 9"
2-CW	2 3/8"	1 3/4"	4" x 9"
3-CW	2 3/4"	1 3/8"	4 1/4" x 9"
4-CW	2 3/4"	1 3/4"	4 1/4" x 9"

SHELF PACK: 1

GAUGE: 22 (.032)

FINISHES: 10B (613), AB (609),

BZ (612), PB (605), S (630)

Box Size - 4 1/2" x 9 3/4"

CW comes box packaged as standard.

For **DEADBOLTS** with 1 1/2" hole

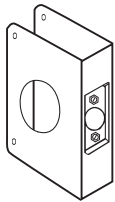

**5-CW
6-CW
7-CW
8-CW**

Display Packaged also available. When ordering indicate by replacing the letters "CW" with "V" after the item number.

Display Package Size - 5 1/4" x 6 1/2"

NUMBER	BACKSET	DOOR	DIMENSIONS
5-CW	2 3/8"	1 3/8"	4" x 4 5/16"
6-CW	2 3/8"	1 3/4"	4" x 4 5/16"
7-CW	2 3/4"	1 3/8"	4 1/4" x 4 5/16"
8-CW	2 3/4"	1 3/4"	4 1/4" x 4 5/16"

SHELF PACK: 1

GAUGE: 22 (.032)

FINISHES: 10B (613), AB (609),

BZ (612), PB (605), S (630)

Box Size - 5 1/4" x 4 1/2"

CW comes box packaged as standard.

For **CYLINDRICAL DOOR LOCKS** with 2 1/8" hole

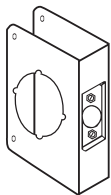

**51-CW
61-CW
71-CW
81-CW**

Display Packaged also available. When ordering indicate by replacing the letters "CW" with "V" after the item number.

Display Package Size - 5 1/4" x 6 1/2"

NUMBER	BACKSET	DOOR	DIMENSIONS
51-CW	2 3/8"	1 3/8"	4" x 4 5/16"
61-CW	2 3/8"	1 3/4"	4" x 4 5/16"
71-CW	2 3/4"	1 3/8"	4 1/4" x 4 5/16"
81-CW	2 3/4"	1 3/4"	4 1/4" x 4 5/16"

SHELF PACK: 1

GAUGE: 22 (.032)

FINISHES: 10B (613), AB (609),

BZ (612), PB (605), S (630)

Box Size - 5 1/4" x 4 1/2"

CW comes box packaged as standard.

For **DOUBLE LOCK COMBINATION LOCKSETS** with 2 1/8" holes with 3 5/8" centers

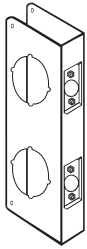

151-CW
261-CW
481-CW

Display Packaged also available. When ordering indicate by replacing the letters "CW" with "V" after the item number.

Display Package Size - 5 1/4" x 11"

NUMBER	BACKSET	DOOR	DIMENSIONS
151-CW	2 3/8"	1 3/8"	4" x 9"
261-CW	2 3/8"	1 3/4"	4" x 9"
481-CW	2 3/4"	1 3/4"	4 1/4" x 9"

SHELF PACK: 1

GAUGE: 22 (.032)

FINISHES: 10B (613), AB (609),

BZ (612), PB (605), S (630)

Box Size - 4 1/2" x 9 3/4"

CW comes box packaged as standard.

For **DOUBLE LOCK COMBINATION LOCKSETS** with 1 1/2" hole on top and 2 1/8" hole on bottom with 4" centers

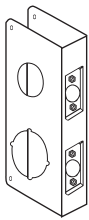

154-CW
264-CW
484-CW

Display Packaged also available. When ordering indicate by replacing the letters "CW" with "V" after the item number.

Display Package Size - 5 1/4" x 11"

NUMBER	BACKSET	DOOR	DIMENSIONS
154-CW	2 3/8"	1 3/8"	4" x 9"
264-CW	2 3/8"	1 3/4"	4" x 9"
484-CW	2 3/4"	1 3/4"	4 1/4" x 9"

SHELF PACK: 1

GAUGE: 22 (.032)

FINISHES: 10B (613), AB (609),

BZ (612), PB (605), S (630)

Box Size: 4 1/2" x 9 3/4"

CW comes box packaged as standard

For **DOUBLE LOCK COMBINATION LOCKSETS** with 2 1/8" holes with 4" centers

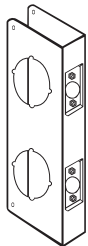

942-CW
943-CW

Display Packaged also available. When ordering indicate by replacing the letters "CW" with "V" after the item number.

Display Package Size - 5 1/4" x 11"

NUMBER	BACKSET	DOOR	DIMENSIONS
942-CW	2 3/8"	1 3/4"	4" x 9"
943-CW	2 3/4"	1 3/4"	4 1/4" x 9"

SHELF PACK: 1

GAUGE: 22 (.032)

FINISHES: 10B (613), AB (609),

BZ (612), PB (605), S (630)

Box Size: 4 1/2" x 9 3/4"

CW comes box packaged as standard

For **DOUBLE LOCK COMBINATION LOCKSETS**

with 2 1/8" holes with 5 1/2" centers

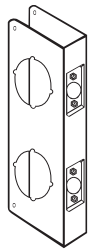

256-CW
258-CW

NUMBER	BACKSET	DOOR	DIMENSIONS
256-CW	2 3/8"	1 3/4"	4 5/16" x 12"
258-CW	2 3/4"	1 3/4"	4 1/4" x 12"

SHELF PACK: 1 Box Pack
GAUGE: 22 (.032)
FINISHES: 10B (613), AB (609), BZ (612), PB (605), S (630)

For **DOUBLE LOCK COMBINATION LOCKSETS** with 6" centers

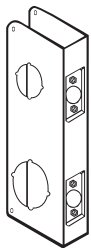

486-CW
hole sizes
1 1/2" over 2 1/8"

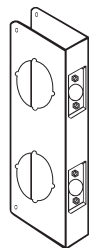

946-CW
hole sizes
2 1/8" over 2 1/8"

NUMBER	BACKSET	DOOR	DIMENSIONS
486-CW	2 3/4"	1 3/4"	4 1/2" x 12"
946-CW	2 3/4"	1 3/4"	4 1/2" x 12"

SHELF PACK: 1 Box Pack
GAUGE: 22 (.032)
FINISHES: 10B (613), PB (605), S (630)

BLANK WRAP-AROUND with **TRIM SCREWS**



30-CW
40-CW
70-CW
80-CW
90-CW

NUMBER	DOOR	DIMENSIONS
30-CW	1 3/8"	4 1/4" x 9"
40-CW	1 3/4"	4 1/4" x 9"
70-CW	1 3/8"	4 1/4" x 4 1/2"
80-CW	1 3/4"	4 1/4" x 4 1/2"
90-CW	1 3/4"	5" x 12"

SHELF PACK: 1 Box Size: 5 1/4" x 4 1/2" and 4 1/2" x 9 3/4"
Gauge: 22 (.032) CW comes box packaged as standard
FINISHES: 10B (613), AB (609), 90-CW Box Pack Only
BZ (612), PB (605), S (630)

For **CYLINDRICAL DOOR LOCKS** with 2 1/8" hole, 12" height

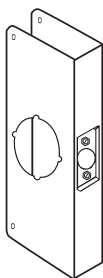

12-CW

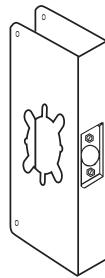

12-2-CW

NUMBER	BACKSET	DOOR	DIMENSIONS
12-CW	2 3/4"	1 3/4"	5 1/8" x 12"
12-2-CW	2 3/4"	1 3/4"	5 1/8" x 12"

SHELF PACK: 1 Box Pack
GAUGE: 22 (.032)
FINISHES: 10B (613), PB (605), S (630)

20" WRAP-AROUND

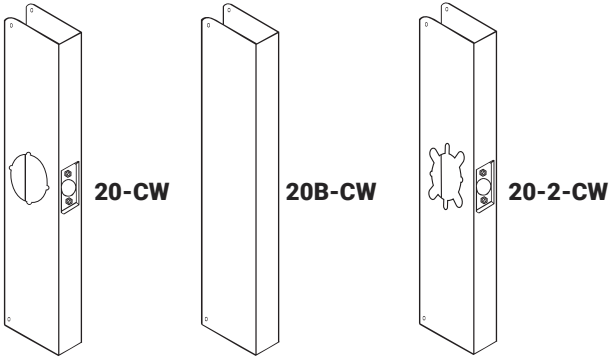

NUMBER	BACKSET	DOOR	DIMENSIONS
20-CW	2 3/4"	1 3/4"	5" x 20"
20B-CW	-	1 3/4"	5" x 20"
20C-CW	2 3/8"	1 3/4"	5" x 20"
20-2-CW	2 3/4"	1 3/4"	5 1/8" x 20"

SHELF PACK: 1 Box Pack
 GAUGE: 22 (.032)
 FEATURES: Non-handed
 FINISHES: 10B (613), PB (605), S (630)

For installing the MARKS LEVERS

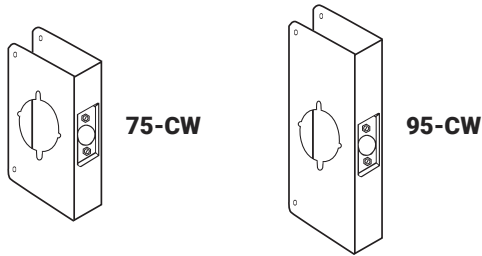

NUMBER	BACKSET	DOOR	DIMENSIONS
75-CW	2 3/4"	1 3/4"	4 3/4" x 5 1/2"
95-CW	2 3/4"	1 3/4"	4 3/4" x 9"

SHELF PACK: 1 Box Pack
 GAUGE: 22 (.032)
 FINISHES: 10B (613), AB (609), BZ (612), PB (605), S (630)

For installing the BEST & SARGENT LEVER LOCKS

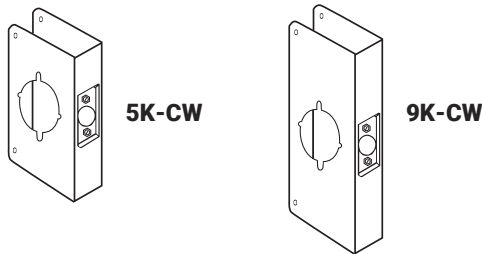

NUMBER	BACKSET	DOOR	DIMENSIONS
5K-CW	2 3/4"	1 3/4"	4 3/4" x 5 1/2"
9K-CW	2 3/4"	1 3/4"	4 3/4" x 9"

SHELF PACK: 1 Box Pack
 GAUGE: 22 (.032)
 FINISHES: 10B (613), AB (609), BZ (612), PB (605), S (630)

For use with HEAVY DUTY GRADE 1 & GRADE 2 key-in-levers

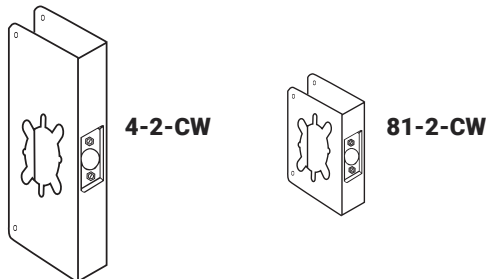

NUMBER	BACKSET	DOOR	DIMENSIONS
1-2-CW	2 3/8"	1 3/8"	4 9/16" x 9"
2-2-CW	2 3/8"	1 3/4"	4 9/16" x 9"
3-2-CW	2 3/4"	1 3/8"	4 3/4" x 9"
4-2-CW	2 3/4"	1 3/4"	4 3/4" x 9"
81-2-CW	2 3/4"	1 3/4"	4 3/4" x 4 1/2"

SHELF PACK: 1 Box Pack
 GAUGE: 22 (.032)
 FEATURES: Works with Schlage, Arrow, Yale, Sargent, Corbin Russwin & Falcon T
 FINISHES: 10B (613), AB (609), BZ (612), PB (605), S (630)

For **KABA/SIMPLEX 1000, E-2000, 4000, 5000 6200 & 7100 SERIES**

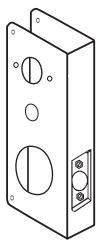

9-CW

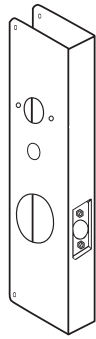

15-CW

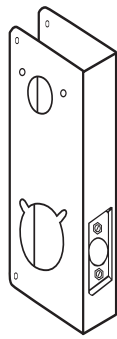

4000-CW

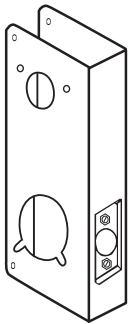

5000-CW

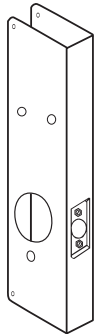

E-2000-CW

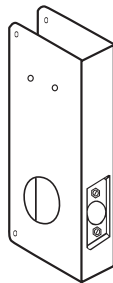

6200-CW

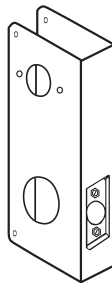

7100-CW

NUMBER	BACKSET	DOOR	DIMENSIONS
9-CW	2 3/4"	1 3/4"	5" x 9"
15-CW	2 3/4"	1 3/4"	5" x 15"
4000-2-CW	2 3/8"	1 3/4"	5" x 15"
4000-4-CW	2 3/4"	1 3/4"	5" x 15"
5000-CW	2 3/4"	1 3/4"	5" x 15"
E2000-CW	2 3/4"	1 3/4"	5" x 15"
6200-CW	2 3/4"	1 3/4"	5 1/8" x 9"
7100-CW	2 3/4"	1 3/4"	5 1/8" x 9"

SHELF PACK: 1 Box Pack

GAUGE: 22 (.032)

FEATURES: (9-CW & 15-CW) Works with Simplex 1000 Lock
 (E2000-CW) Works with Simplex E-2000 Lock
 (4000-CW) Works with Simplex 4000 Lock
 (5000-CW) Works with Simplex 5000 Lock
 (6200-CW) Works with Simplex 6200
 (7100-CW) Works with Simplex 7100

FINISHES: (9-CW, 15-CW, 4000-2-CW, 4000-4-CW): 10B (613), AB (609), PB (605), S (630)
 (5000-CW, E2000-CW, 6200-CW, 7100-CW): 10B (613), PB (605), S (630)

For **ALARM LOCK 2700/T2, 3000 & DL 4100 SERIES TRILOGY LOCK**

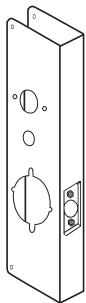

27-CW

NUMBER	BACKSET	DOOR	DIMENSIONS
27-CW	2 3/4"	1 3/4"	5" x 15"

SHELF PACK: 1 Box Pack

GAUGE: 22 (.032)

FINISHES: (27-CW) 10B (613), AB (609), PB (605), S (630)

For conversion of **SIMPLEX 1000 SERIES & ALARM LOCK DL2500, 2700/T2 & 3000 SERIES** to cylindrical locks

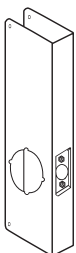

14-CW

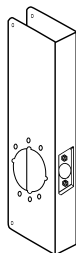

14-2-CW

NUMBER	BACKSET	DOOR	DIMENSIONS
14-CW	2 3/4"	1 3/4"	5" x 14"
14-2-CW	2 3/4"	1 3/4"	5" x 14"

SHELF PACK: 1 Box Pack

GAUGE: 22 (.032)

FINISHES: 10B (613), AB (609), PB (605), S (630)

For **SECURITRON SABLE LOCK**

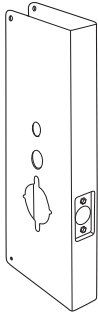

28-CW

NUMBER	BACKSET	DOOR	DIMENSIONS
28-CW	2 3/4"	1 3/4"	5" x 15"

SHELF PACK: 1 Box Pack
 GAUGE: 22 (.032)
 FEATURES: Works with Securiton Sable Lock
 FINISHES: (28-CW) 10B (613), PB (605), S (630)

For **BEST 93-KV LOCKS & MAS-HAMILTON POWER LEVERS**

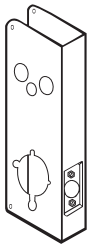

93-KV-CW

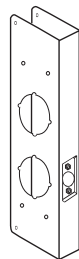

16-CW

NUMBER	BACKSET	DOOR	DIMENSIONS
93-KV-CW	2 3/4"	1 3/4"	5 1/2" x 12 3/4"
16-CW	2 3/4"	1 3/4"	5" x 15"

SHELF PACK: 1 Box Pack
 GAUGE: 22 (.032)
 FINISHES: 10B (613), PB (605), S (630)

For **ARROW REVOLUTION & YALE IN TOUCH LOCKS**

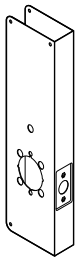

25-CW

NUMBER	BACKSET	DOOR	DIMENSIONS
25-CW	2 3/4"	1 3/4"	5 1/8" x 15"

SHELF PACK: 1 Box Pack
 GAUGE: 22 (.032)
 FINISHES: 10B (613), PB (605), S (630)

For **SCHLAGE COBRA LOCKS**

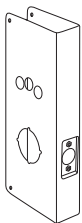

17-CW

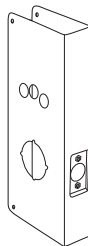

18-CW

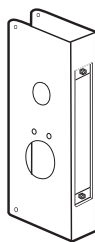

518-CW

NUMBER	BACKSET	DOOR	DIMENSIONS
17-CW	2 3/4"	1 3/4"	5" x 12"
18-CW	2 3/4"	1 3/4"	5" x 15"
518-CW	2 3/4"	1 3/4"	5" x 12"

SHELF PACK: 1 Box Pack
 GAUGE: 22 (.032)
 FEATURES: Works with Schlage King Cobra Cylindrical and Mortise Lock
 FINISHES: (17-CW, 18-CW) 10B (613), BZ (612), PB (605), S (630)
 (518-CW) 10B (613), PB (605), S (630)

For **SCHLAGE PRO SERIES**

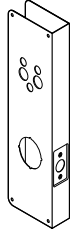

5100-CW

NUMBER	BACKSET	DOOR	DIMENSIONS
5100-CW	2 3/4"	1 3/4"	5 1/8" x 15"

SHELF PACK: 1 Box Pack
 GAUGE: 22 (.032)
 FEATURES: Works with Schlage/Locknetics pro series
 FINISHES: 10B (613), PB (605), S (630)

For **SCHLAGE AD & CO LOCKETS**

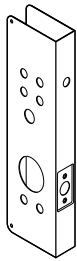

26AD-CW

NUMBER	BACKSET	DOOR	DIMENSIONS
26AD-CW	2 3/4"	1 3/4"	5" x 16"
504AD-CW	2 3/4"	1 3/4"	5" x 16"
26CO-CW	2 3/4"	1 3/4"	5" x 16"
504CO-CW	2 3/4"	1 3/4"	5" x 14"

SHELF PACK: 1 Box Pack
 GAUGE: 22 (.032)
 FINISHES: DU, PB, S

For **MARKS I-Q LOCKS**

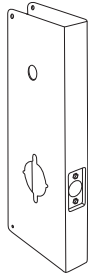

19-CW

NUMBER	BACKSET	DOOR	DIMENSIONS
19-CW	2 3/4"	1 3/4"	5" x 15"

SHELF PACK: 1 Box Pack
 GAUGE: 22 (.032)
 FINISHES: 10B (613), PB (605), S (630)

For **CODELOCKS 2010, 4010 & 5000 SERIES**

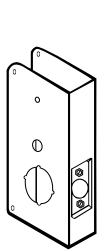

21-CW

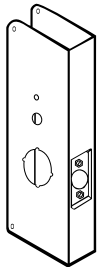

22-CW

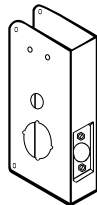

23-CW

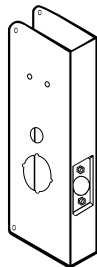

24-CW

NUMBER	BACKSET	DOOR	DIMENSIONS
21-CW	2 3/8"	1 3/4"	5" x 9"
22-CW	2 3/8"	1 3/4"	5" x 15"
23-CW	2 3/4"	1 3/4"	5" x 9"
24-CW	2 3/4"	1 3/4"	5" x 15"

SHELF PACK: 1 Box Pack
 GAUGE: 22 (.032)
 FEATURES: (21-CW, 22-CW) Works with 2010 and 4010 series lock
 (23-CW, 24-CW) Works with 5000 series lock
 FINISHES: 10B (613), PB (605), S (630)

MORTISE LOCK wrap-around plate for 86 cut-out

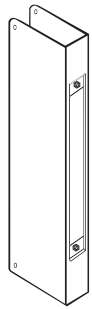

504-CW

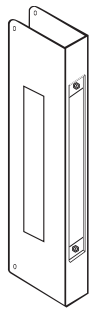

514-CW

NUMBER	BACKSET	DOOR	DIMENSIONS
504-CW	-	1 3/4"	5" x 12"
514-CW	2 3/4"	1 3/4"	5" x 12"

SHELF PACK: 1 Box Pack
 GAUGE: 22 (.032)
 FEATURES: • 8" x 1 1/4" Recess
 • Drill spindle and thumb turn holes in field
 • Rectangle size 1 5/8" x 7 5/16"
 • 8" x 1 1/4" Recess
 FINISHES: 10B (613), BZ (612), PB (605), S (630)

MORTISE LOCK wrap-around plate for 86 cut-out

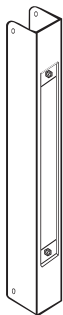

504-FE

NUMBER	BACKSET	DOOR	DIMENSIONS
504-FE	-	1 3/4"	12" x 1"

SHELF PACK: 1 Box Pack
 GAUGE: 22 (.032)
 FEATURES: 8" x 1 1/4" Recess
 FINISHES: 10B (613), S (630)

For CONVERTING UNIT LOCKS to LEVER LOCKS

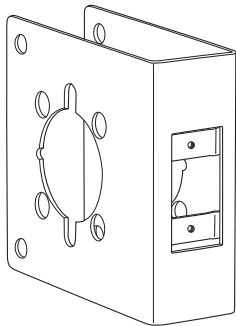

NUMBER	BACKSET	DOOR	DIMENSIONS
4U-2-CW	2 3/4"	1 3/4"	5" x 5"

SHELF PACK: 1 Box Pack
 GAUGE: 13 (.095) heavy gauge material
 FEATURES: • Converts unit locks to lever locks
 • Prepped to accept grade 1 & 2 levers
 • Sex bolts used to secure plate to door
 FINISHES: BP, DU, S

For DON-JO HOSPITAL PUSH/PULL LATCHES

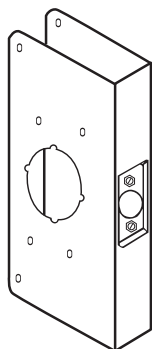

4500-CW
4550-CW

NUMBER	BACKSET	DOOR	DIMENSIONS
4500-CW	2 3/4"	1 3/4"	4 3/4" x 9"
4550-CW	5"	1 3/4"	6 1/2" x 9"

SHELF PACK: 1 Box Pack
 GAUGE: 22 (.032)
 FEATURES: Also works with ABH 6100 Series, Glenn Johnson HL6 & Hager 311
 FINISHES: 10B (613), PB (605), S (630)

For **LOCKS** with **EXTENDED** or **CONVERTED BACKSETS**

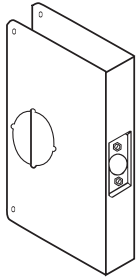

Extended
33-CW
55-CW

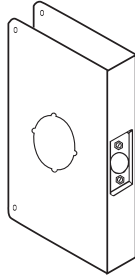

Converted
33A-CW
55A-CW

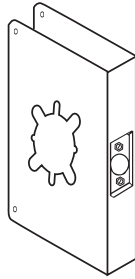

Converted
33A-2-CW
55A-2-CW

NUMBER	BACKSET	DOOR	DIMENSIONS
33-CW	3 3/4"	1 3/4"	5 1/2" x 9"
33A-2-CW	2 3/4"	1 3/4"	6 1/2" x 9"
33A-CW	2 3/4"	1 3/4"	6 1/2" x 9"
55-CW	5"	1 3/4"	6 1/2" x 9"
55A-2-CW	2 3/4"	1 3/4"	6 1/2" x 9"
55A-CW	2 3/4"	1 3/4"	6 1/2" x 9"

SHELF PACK: 1 Box Pack
GAUGE: 22 (.032)
FINISHES: 10B (613), AB (609), BZ (612), PB (605), S (630)

For **THICKER DOORS**

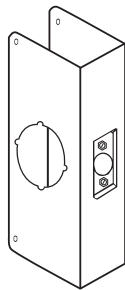

200-CW
200C-CW
212-CW
212C-CW
214-CW
214C-CW

NUMBER	BACKSET	DOOR	DIMENSIONS
200-CW	2 3/4"	2"	4 1/4" x 9"
200C-CW	2 3/8"	2"	4 1/4" x 9"
212-CW	2 3/4"	2 1/2"	4 1/4" x 9"
212C-CW	2 3/8"	2 1/2"	4 1/4" x 9"
214-CW	2 3/4"	2 1/4"	4 1/4" x 9"
214C-CW	2 3/8"	2 1/4"	4 1/4" x 9"

SHELF PACK: 1 Box Pack
GAUGE: 22 (.032)
FEATURES: • Latch hole centered in door
 • Available with lever Prep. - Custom order only
FINISHES: 10B (613), PB (605), S (630)

DOOR REINFORCER for deadbolts & key-in-knob locks

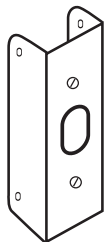

10-FE
20-FE

NUMBER	BACKSET	DOOR	DIMENSIONS
10-FE	-	1 3/8"	4 1/2" x 1"
20-FE	-	1 3/4"	4 1/2" x 1"

SHELF PACK: 10 Display Package Size - 4" x 7 3/4"
GAUGE: 22 (.032)
FINISHES: 10B (613), AB (609), PB (605), S (630)

FLAT FRONT WRAP-AROUNDS

DON-JO MFG., INC. also offers a complete line of “original” Flat Front Wrap-Arounds. They are perfect for repairing, reinforcing or remodeling doors. Speed nuts are supplied with all Flat Front Wrap-Arounds and can be used in certain conditions when door is severely damaged or when replacing a mortise lock.

**Works
great
on metal
doors**

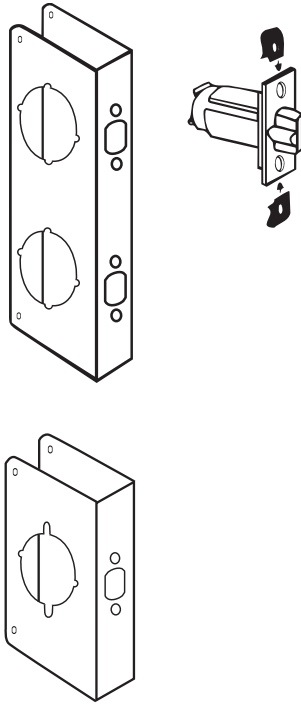

MODEL	BACKSET	DOOR	DIMENSIONS
1	2 3/8"	1 3/8"	4" x 9"
2	2 3/8"	1 3/4"	4" x 9"
3	2 3/4"	1 3/8"	4 1/4" x 9"
4	2 3/4"	1 3/4"	4 1/4" x 9"
5	2 3/8"	1 3/8"	4" x 4 1/2"
6	2 3/8"	1 3/4"	4" x 4 1/2"
7	2 3/4"	1 3/8"	4 1/4" x 4 1/2"
8	2 3/4"	1 3/4"	4 1/4" x 4 1/2"
51	2 3/8"	1 3/8"	4" x 4 1/2"
61	2 3/8"	1 3/4"	4" x 4 1/2"
71	2 3/4"	1 3/8"	4 1/4" x 4 1/2"
81	2 3/4"	1 3/4"	4 1/4" x 4 1/2"
30	-	1 3/8"	4" x 9"
40	-	1 3/4"	4" x 9"
70	-	1 3/8"	4 1/4" x 4 1/2"
80	-	1 3/4"	4 1/4" x 4 1/2"
154	2 3/8"	1 3/8"	4" x 9"
264	2 3/8"	1 3/4"	4" x 9"
484	2 3/4"	1 3/4"	4 1/4" x 9"
151	2 3/8"	1 3/8"	4" x 9"
261	2 3/8"	1 3/4"	4" x 9"
481	2 3/4"	1 3/4"	4 1/4" x 9"
258	2 3/4"	1 3/4"	4 1/4" x 12"
942	2 3/8"	1 3/4"	4" x 9"
943	2 3/4"	1 3/4"	4 1/4" x 9"

HOW TO ORDER:

MODEL #	FINISH	SUFFIX:VF	
4	S	VF	(4 S VF)

1 Company Information

Qty: _____

Company _____

Address _____ City _____ State _____ Zip _____

Phone _____ Email _____

Distributor to Bill Through _____

Phone _____ Email _____ Contact _____

2 Finish Circle Selection 605 606 609 612 613 622 629 630

3 Latch Prep Circle Selection

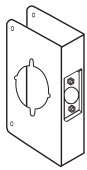

Single Indent

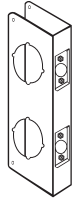

Double Indent

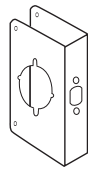

Single Flat Front



Double Flat Front

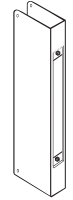

Mortise Prep

- _____ Blank
- _____ Hinge (size)
- _____ ANSI Strike
- _____ Custom

4 Lock Prep Circle Selection

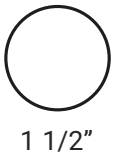

1 1/2"



2 1/8"

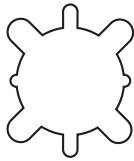

Fits: Schlage, Corbin/Ruswin, Arrow, Sargent, Yale, Falcon and other Grade 1 & 2 cylindrical lock with min. 3 5/16" rose

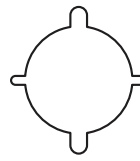

Fits: Best 93K Best 73K Sargent 6500

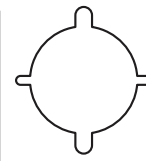

Fits: Marks Medeco Levers

5 Details Please complete all necessary measurements

Height (up to 20") _____ Width (6 1/2" Max) _____ Backset _____ Door Thickness _____
1 3/8" 1 3/4" 2" 2 1/4" 2 1/2"

Bottom of plate to center of lock prep _____ Center to center of lock preps _____

6 Multiple Holes

Show all hole with their center to center dimensions as well as their location on the plate

Show center to center dimensions to the nearest hole

For larger template contact factory

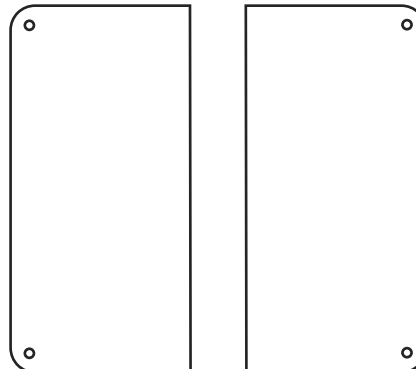

The Industry Leader in Architectural Hardware and Door Security Products

DON-JO MFG., INC.

Driven by family values and an independent spirit, Don-Jo has set the industry standard for service, quality, innovation and value since 1981.

Headquartered in the Boston suburb of Sterling, MA, our inhouse engineering and manufacturing capabilities give us the flexibility to create innovative, cutting edge products that meet and exceed our customers' continually-evolving architectural hardware and door security and accessory needs.

From Custom Architectural Hardware to industry leading door security, protection and repair products, Don-Jo prides itself on developing world-class, commercial grade solutions that reliably deliver the confidence and control you need to effectively satisfy your architectural and security needs.

Our success comes from listening to you.



DON-JO MFG., INC.

ARCHITECTURAL HARDWARE & ACCESSORIES

**Stock and Custom Wrap Around Plates for retrofitting
or replacing Stand Alone Access Control Products**

Contact us at 800-628-8389 or visit www.don-jo.com for more information



**Visit www.don-jo.com to explore our entire offering of
Architectural Hardware & Door Safety and Security Products**



PHONE: 978.422.3377
FAX: 978.422.3467
Toll Free: 800.628.8389
Toll Free Fax: 800.278.8202

www.don-jo.com
info@don-jo.com
Section F, Version 2

