



INDOOR & OUTDOOR

PROFESSIONAL
LIGHTING
SOLUTIONS

2024 / 2025

KICHLER





All the support you need

From corridors to common areas, you need light fixtures you can trust; fixtures that stand up to time, traffic and everyday wear and tear. We are committed to supporting your project's success every step of the way—from localized service to inventory and on-time delivery.

Navigating the Catalog

Search by Category

The Professional Lighting Solutions Catalog presents select Kichler® and élan® fixtures by product category. From indoor ceiling and wall fixtures like downlights, pendants, and sconces, to LED tape, ceiling fans and outdoor products, the pages that follow are designed to help narrow your search to exactly what you need.

Locate LED

You will find integrated LED fixtures at the beginning of each product category. Many of these fixtures were designed for 24/7-use and are in compliance with the latest Title 24 standards.

This catalog also presents a broad selection of our top, tried-and-true socketed fixtures—featured just after our LED options in each product category.











Additional LED Options

We offer a selection of fixtures that come packaged with compatible LED bulbs included. Bundled together, the product + bulbs are Title 24 compliant.

These LED options are denoted with “L18” in the model number, and typically appear just after the integrated LED options in each section.

Symbol Guide

FIXTURE

-  Damp
-  Wet
-  Climates™
-  Mounts Up or Down
-  Mounts Horizontal or Vertical
-  Mount Ceiling or Wall
-  Dark Sky Compliant
-  2019 Title 24, Part 6 is a document that contains the California Building Energy Efficiency Standards for Residential and Nonresidential Buildings as regulated by the California Energy Commission. Products marked with this logo and labeled as JA8-2019 or JA8-2019-E have been found to meet the requirements stated in 2019 Title 24, Part 6. For more information, visit www.energy.ca.gov/title24.
-  ADA Compliant
-  DC Motor (Ceiling Fans)

LIGHT SOURCE







-  Dimmable
-  Integrated LED
-  LED Energy Efficient Bulb Included
-  Energy Star
(phasing out in lighting at the end of 2024, except for select downlights)
-  When electrical connection is made inside the fixture, supply wire must be rated at least 75° C. When electrical connection is made in an outlet box, supply wire must be rated at least 60° C.
-  Fixture requires supply wire rated for at least 75° C.
-  Fixture requires supply wire rated for at least 90° C

Table of Contents

INDOOR LIGHTING.....	12	UNDER CABINET LIGHTING	118
INDOOR COLLECTIONS	14	LED TAPE & ACCENT LIGHTING ...	126
LED DOWNLIGHTS	32	Tape Light - 24V / 12V	130
Low Profile (Gen)	34	Accent Discs - 24V / 12V	138
Horizon	36	Power Supplies.....	140
Zeo.....	38	LED Driver + Dimmer	141
Ara	40	Low Voltage Wire	143
Direct-to-Ceiling (DtC) Slim	41	TE Series Channels	146
Direct-to-Ceiling (DtC) Recessed	44	Channel Accessories.....	152
Direct-to-Ceiling (DtC) Mini Recessed / Gimbal	46	Tracks & Splice Box.....	153
Direct-to-Ceiling (DtC) Accessories	47		
CEILING LIGHTS	48	CEILING FANS	156
Integrated LED & LED Bulb Included.....	48	Indoor	156
Socketed (Bulb not Included)	54	Indoor / Outdoor	165
WALL SCONCES	60	Accessories.....	166
Integrated LED & LED Bulb Included.....	60		
Socketed (Bulb not Included)	62		
BATH & VANITY	66	OUTDOOR LIGHTING	168
Integrated LED & LED Bulb Included.....	66	Integrated LED & LED Bulb Included.....	170
Socketed (Bulb not Included)	75	Socketed (Bulb not Included).....	175
Mirrors	94		
PENDANTS	98		
Integrated LED & LED Bulb Included.....	98		
Socketed (Bulb not Included)	100		

Lighting Solutions For Work, Dine, Play & Stay



For more than 85 years, we've built a reputation as a leader in designing, manufacturing, and standing behind all types of lighting fixtures, including fixtures for:



Quality Fixtures and So Much More

VARIETY

Whether you need volume and variety for a multi-family structure, or style and efficiency for the high-use needs of a hotel or restaurant, we offer solutions that perform through it all. Our integrated LED fixtures are designed for 24/7 operation and feature dependable materials like rust-resistant cast aluminum housings, durable acrylic or polycarbonate diffusers, and sturdy powder coated finishes.

Integrated LED

High-quality integrated LED fixtures that have been tested and re-tested to ensure they will withstand the test of time.

Title 24

Products designed to meet Title 24 standards offer an ideal lumen output to wattage used ratio for optimal efficiency.

Universal Voltage

New opportunities for projects requiring universal voltage (120V-277V) with select sconces, vanity or outdoor fixtures.

Light Output Options

Options to suit a variety of kelvin, CRI and lumen output requirements.

For more information on Title 24, DLC and more, see pages 196-197.



AVAILABILITY

Our nationwide network of distribution centers covers more than 1 million square feet of warehouse space and have an extensive inventory to meet your lighting needs.

Strategically Located

Our distribution centers are strategically located across the country to help expedite shipping and keep costs in check.

Quick Shipping

We're ready to accommodate your timetable with inventory available for quick ship needs, or staggered shipments for large-scale projects.

Order Accuracy

Our orders ship timely and accurately to align to your production schedules.





SUPPORT

Whether in the field, over the phone, or online, we offer world-class customer care and support, including:

Call Center

Domestically based call center

In-Field Representatives

Access to in-field representatives for local, personalized attention and service

Web-Based Access

Web-based access to IES files, videos, and more

Product Technical Support

We're here to support you with all your pre-and post-installation questions. Our team of experts will help guide you with complete step-by-step instructions and troubleshooting tips. Contact our team at 844-KICHLER (844-542-4537) or email techsupport@kichler.com.

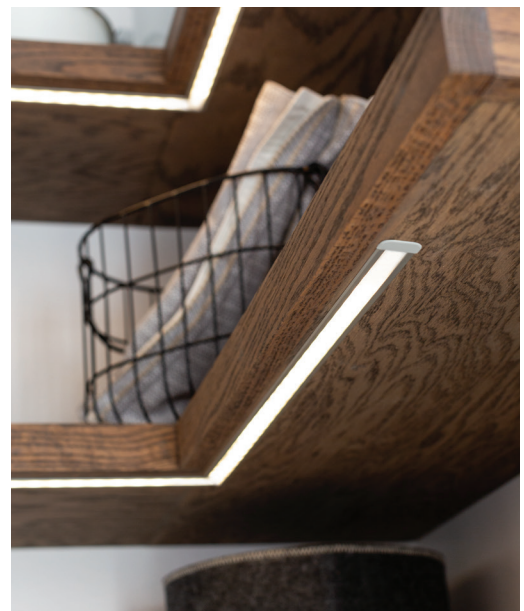

Whole Home & Project Solutions

Our breadth and depth of product paired with our exceptional service bring you confidence and success as you close out your project.



Room-to-Room Coordination

We offer complete families for room-to-room coordination, forecasting and inventory planning for items selected for home packages, and localized service to assist builders on the spot.



Multi-Family & Hospitality

With multi-family and hospitality our décor line brings life to lobbies and corridors, while our array of ceiling, pendant, and vanity lights create a warm and welcoming atmosphere within the living spaces.

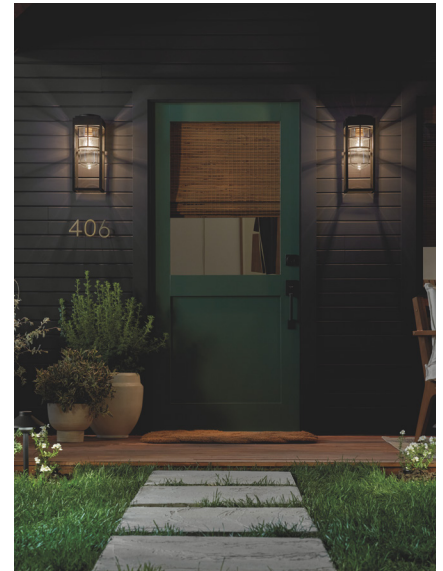

Outdoor Illumination

Our exterior and landscape lines offer both curb appeal and security as guests drive up and enter the property.



LANDSCAPE LIGHTING

For more information on Kichler landscape lighting, visit [Kichler.com](https://www.kichler.com), or request our landscape catalog through your rep or customer care.



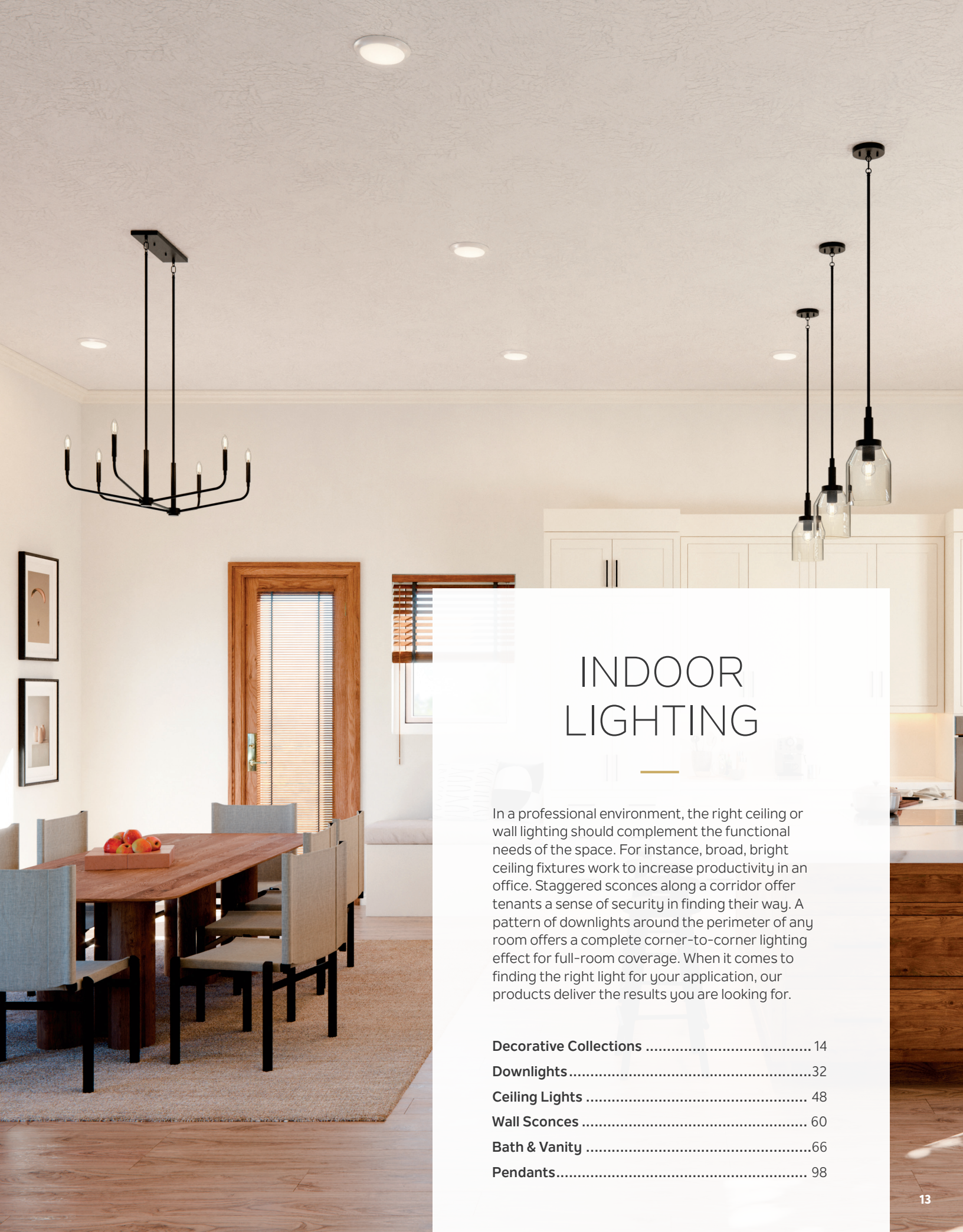

INDOOR LIGHTING

In a professional environment, the right ceiling or wall lighting should complement the functional needs of the space. For instance, broad, bright ceiling fixtures work to increase productivity in an office. Staggered sconces along a corridor offer tenants a sense of security in finding their way. A pattern of downlights around the perimeter of any room offers a complete corner-to-corner lighting effect for full-room coverage. When it comes to finding the right light for your application, our products deliver the results you are looking for.

- Decorative Collections** 14
- Downlights** 32
- Ceiling Lights** 48
- Wall Sconces** 60
- Bath & Vanity** 66
- Pendants** 98





Indoor Lighting Collections

Ensure room-to-room cohesion with these indoor lighting collections. From single-family to multi-family, these coordinated styles can light up any room.

Find more room-to-room inspiration at [Kichler.com](https://www.kichler.com)



Welcome to a visual guide of single-family and multi-family package selection.

These collections offer coordinating fixtures and an array of finish options for homeowners and tenants to select from as they finalize their space.

Additional specifications and package details can be provided.

Wynberg™



2093 NI, OZ
5 Light Chandelier
24.5"W x 13.75"H



3293 NI
3 Light Chandelier
22"W x 13.25"H



2693 NI, OZ
1 Light Mini Pendant
6"W x 6.25"H
page 107



3694 NI, OZ
2 Light Pendant / Semi Flush
15"W x 15.25"H

FEATURE
Semi flush converts
to pendant



Stamos™



52436 NI, OZ, BK
5 Light Chandelier
24"W x 15.5"H



52435 NI, OZ, BK
3 Light Chandelier
18"W x 15.5"H



52437 NI, OZ, BK
1 Light Wall Sconce
5"W x 8"H
page 65



55120 NI, OZ, BK
2 Light Vanity
13.25"W x 8.25"H
page 85



55121 NI, OZ, BK
3 Light Vanity
22.25"W x 8.25"H
page 85



55122 NI, OZ, BK
4 Light Vanity
31.25"W x 8.25"H
page 85

Erma™



52443 NI, OZ, BK
5 Light Chandelier
24"W x 19.25"H



52442 NI, OZ, BK
3 Light Chandelier
18"W x 18.5"H



52444 NI, OZ, BK
1 Light Mini Pendant
4"W x 7.5"H
page 106



52445 NI, OZ, BK
1 Light Wall Sconce
4.25"W x 8"H
page 65



55125 NI, OZ, BK
2 Light Vanity Light
13.75"W x 8.5"H
page 84



55126 NI, OZ, BK
3 Light Vanity Light
23.25"W x 8.5"H
page 84



55127 NI, OZ, BK
4 Light Vanity Light
32.5"W x 8.5"H
page 84



44035 NI, OZ, NBR, BK
8 Light Chandelier
20"W x 14.75"H x 44.5"L



44031 NI, OZ, NBR, BK
9 Light Chandelier
27" Dia. x 27" H



52616 NI, OZ, NBR, BK
6 Light Chandelier
26" Dia. x 16.5"H



44030 NI, OZ, NBR, BK
5 Light Chandelier
19.75" Dia. x 16.25"H



44029 NI, OZ, NBR, BK
3 Light Chandelier
18" Dia. x 15.5"H



44034 NI, OZ, NBR, BK
3 Light Chandelier
24.5" Dia. x 31"H



44033 NI, OZ, NBR, BK
1 Light Semi Flush
8.5" Dia. x 10.75"H
page 57



44032 NI, OZ, NBR, BK
1 Light Mini Pendant
4.25" Dia. x 7.5" H
page 105



45910 NI, OZ, NBR, BK
1 Light Wall Sconce
4.75"W x 9.25"H
page 64



45885 NI, OZ, NBR, BK
2 Light Vanity Light
13"W x 9.25"H
page 83



45886 NI, OZ, NBR, BK
3 Light Vanity Light
21.5"W x 9.25"H
page 83



45887 NI, OZ, NBR, BK
4 Light Vanity Light
30"W x 9.25"H
page 83

Jolie



43639 NI, OZ
9 Light Chandelier
28" Dia. x 28"H



43638 NI, OZ
5 Light Chandelier
22" Dia. x 18.5"H



43637 NI, OZ
3 Light Chandelier
18" Dia. x 18"H



43640 NI, OZ
1 Light Mini Pendant
4.75" Dia. x 6.75"H
page 99



43641 NI, OZ
2 Light Semi Flush / Pendant
15"W x 13.75"H
page 57



45637 CH, NI, OZ
1 Light Wall Sconce
5"W x 9"H
page 62



45638 CH, NI, OZ
2 Light Wall Sconce
13"W x 9.25"H
page 74



45639 CH, NI, OZ
3 Light Wall Sconce
20.5"W x 9.25"H
page 74



45640 CH, NI, OZ
4 Light Wall Sconce
28"W x 9.25"H
page 74

**LED OPTION
AVAILABLE**

See Symbol Guide
for more information



FEATURE

Semi flush converts
to pendant





2031 NI, TZ
9 Light Chandelier
32"W x 29"H



2021 NI, TZ
5 Light Chandelier
25"W x 24.5"H



2520 NI
9 Light Chandelier
27.75"W x 37"H



2020 AB, NI, TZ
5 Light Chandelier
24"W x 23"H



2019 NI
4 Light Mini Chandelier
18"W x 16"H



3502 NI, TZ
3 Light Inverted Pendant
17.75"W x 19"H
page 117



2771 NI, TZ
1 Light Mini Pendant
6.25"W x 5.5"H
page 107



3623 NI
3 Light Semi Flush
15.25"W x 14"H
page 57



8064 NI, TZ
2 Light Flush Mount
13.25"W x 6.25"H
page 57



8065 NI
3 Light Flush Mount
15.25"W x 7.75"H
page 57



6719 NI
1 Light Wall Sconce
6.25"W x 6.5"H
page 65



6322 NI
2 Light Vanity
14.25"W x 9"H
page 89



6323 NI
3 Light Vanity
22.5"W x 8"H
page 89



6324 NI
4 Light Vanity
30.5"W x 9"H
page 89



52720 NI, CPZ, BK
9 Light Chandelier
32" Dia. x 25.5"H



52721 NI, CPZ, BK
6 Light Chandelier
17.75"W x 17.5"H x 45"L



52718 NI, CPZ, BK
6 Light Chandelier
32" Dia. x 17.5"H



52719 NI, CPZ, BK
6 Light Chandelier
38" Dia. x 18.25"H



52717 NI, CPZ, BK
5 Light Chandelier
26" Dia. x 17"H



52716 NI, CPZ, BK
4 Light Chandelier
20" Dia. x 16.75"H



52725 NI, CPZ, CH, BK
1 Light Mini Pendant
7"W x 15"H
page 105



55183 NI, CPZ, CH, BK
1 Light Wall Sconce
5"W x 14.75"H
page 64



55184 NI, CPZ, CH, BK
2 Light Vanity
14.25"W x 10.5"H
page 82



55185 NI, CPZ, CH, BK
3 Light Vanity
24"W x 10.5"H
page 82



55186 NI, CPZ, CH, BK
4 Light Vanity
34"W x 10.5"H
page 82



COMING SOON
Q4 2024

52724 NI, CPZ, BK
Large Foyer Pendant
24.25"W x 43"H



COMING SOON
Q4 2024

52723 NI, CPZ, BK
Large Foyer Pendant
20"W x 36"H



COMING SOON
Q4 2024

52722 NI, CPZ, BK
Pendant
16"W x 25.25"H

Shailene™



43672 NI, NICS, OZ, OZCS,
NBR, NBRCS, BK, BKCS
9 Light Chandelier
26.5"W x 26.5"H



43671 NI, NICS, NBR,
NBRCS, BK, BKCS
5 Light Chandelier
23.75"W x 15.25"H



43670 NI, NICS, OZ, OZCS,
NBR, NBRCS, BK, BKCS
3 Light Mini Chandelier
17.5"W x 15.25"H



43674 NI, NICS, OZ, OZCS,
NBR, NBRCS, BK, BKCS
1 Light Mini Pendant | 4.5"W x 11"H
page 106



43675 NI, NICS, OZ, OZCS,
NBR, NBRCS, BK, BKCS
3 Light Semi Flush | 14"W x 10"H
page 56



43691 NI, NICS, OZ, OZCS,
NBR, NBRCS, BK, BKCS
3 Light Semi Flush | 14"W x 10.25"H
page 56



43692 NI, NICS, OZ, OZCS,
NBR, NBRCS, BK, BKCS
3 Light Semi Flush | 18"W x 11.5"H
page 56



43693 NI, NICS, OZ, OZCS,
NBR, NBRCS, BK, BKCS
3 Light Square Semi Flush | 18"W x 11"H
page 56



45572 CH, CHCLR, NI, NICLR, OZ,
OZCLR, NBR, NBRCLR, BK, BKCLR
1 Light Wall Sconce | 5"W x 8.25"H
page 80



45573 CH, CHCLR, NI, NICLR, OZ,
OZCLR, NBR, NBRCLR, BK, BKCLR
2 Light Vanity Light | 12.5"W x 8.25"H
page 80



45574 CH, CHCLR, NI, NICLR, OZ,
OZCLR, NBR, NBRCLR, BK, BKCLR
3 Light Vanity Light | 21"W x 8.25"H
page 80



45575 CH, CHCLR, NI, NICLR, OZ,
OZCLR, NBR, NBRCLR, BK, BKCLR
4 Light Vanity Light | 29.75"W x 8.25"H
page 80





43666 NI, OZ
9 Light Chandelier
28.75"W x 31.25"H



43665 NI, OZ
5 Light Chandelier
25"W x 23"H



43664 NI, OZ
3 Light Chandelier
21.5"W x 19.25"H



43668 NI, OZ
1 Light Mini Pendant
4.75"W x 12.75"H
page 99



43669 NI, OZ
3 Light Semi Flush
15"W x 13"H
page 52



45568 NI, OZ
1 Light Wall Sconce
5.5"W x 10.75"H
page 62



45569 NI, OZ
2 Light Vanity
13"W x 10.75"H
page 71



45570 NI, OZ
3 Light Vanity
21"W x 11"H
page 71



45571 NI, OZ
4 Light Vanity
29"W x 10.75"H
page 71



LED OPTION
AVAILABLE
See Symbol Guide
for more information





42884 NI
5 Light Chandelier
25"W x 21.5"H



42882 NI
1 Light Foyer Pendant
13"W x 21.75"H
page 117



42880 NI
1 Light Mini Pendant
6"W x 8"H
page 107



42881 NI
1 Light Pendant
16"W x 10"H
page 117



42879 NI
3 Light Semi Flush
16"W x 13.25"H
page 54



45881 NI
1 Light Wall Sconce
6"W x 10"H
page 65



45882 NI
2 Light Vanity
16"W x 10"H
page 89



45883 NI
3 Light Vanity
24"W x 10"H
page 89



45884 NI
4 Light Vanity
33"W x 10"H
page 89





44378 NI, NICS, BK, BKCS
9 Light Chandelier
31.75"W x 29.5"H



44377 NI, NICS, BK, BKCS
5 Light Chandelier
24.25"W x 22.75"H



44379 NI, BK
3 Light Linear Chandelier
5"W x 16.25"H x 31"L



44380 NI, NICS, BK, BKCS
1 Light Mini Pendant
5"W x 7.75"H
page 105



44381 NI, NICS, BK, BKCS
1 Light Wall Sconce
5"W x 10.25"H
page 63



45128 NI, NICS, BK, BKCS
2 Light Vanity
14.5"W x 10.25"H
page 88



45129 NI, NICS, BK, BKCS
3 Light Vanity
24"W x 10.25"H
page 88



45130 NI, NICS, BK, BKCS
4 Light Vanity
33.5"W x 10.25"H
page 88





43924 NI, OZ
9 Light Chandelier
32"W x 33"H



43923 NI, OZ
5 Light Chandelier
24"W x 19.75"H



43922 NI, OZ
3 Light Chandelier
20"W x 18.5"H



43925 NI, OZ
3 Light Semi Flush / Pendant
17.75"W x 16.75"H
page 52



43926 NI, OZ
3 Light Semi Flush
14.25"W x 11.75"H
page 52



43927 NI, OZ
1 Light Mini Pendant
4"W x 19"H
page 99



45921 NI, OZ
1 Light Wall Sconce
5"W x 18.25"H
page 62



45922 NI, OZ
2 Light Vanity
14"W x 9.25"H
page 73



45923 NI, OZ
3 Light Vanity
24"W x 9.25"H
page 73



45924 NI, OZ
4 Light Vanity
34"W x 9.25"H
page 73



LED OPTION AVAILABLE
See Symbol Guide for more information



FEATURE
Semi flush converts to pendant





52388 NI, OZ, BK
8 Light Chandelier
27.25"W x 25"H



52386 NI, OZ, BK
5 Light Chandelier
18.5"W x 17"H



52385 NI, OZ, BK
5 Light Chandelier
18"W x 17"H



52384 NI, OZ, BK
3 Light Chandelier
20"W x 15"H



52383 NI, OZ, BK
3 Light Chandelier
16"W x 14.75"H



55085 NI, OZ, BK
1 Light Wall Sconce
4.75"W x 9.75"H
page 63



55086 NI, OZ, BK
2 Light Vanity
13.25"W x 9.75"H
page 78



55087 NI, OZ, BK
3 Light Vanity
22.75"W x 9.75"H
page 78



55088 NI, OZ, BK
4 Light Vanity
32"W x 9.75"H
page 78



Crosby



43999 CH, NI, OZ, NBR, BK
5 Light Chandelier
26.25"W x 22.25"H



43997 CH, NI, OZ, NBR, BK
3 Light Chandelier
18"W x 13.75"H



43998 CH, NI, OZ, NBR, BK
4 Light Foyer Pendant | 16"W x 31"H
page 84



43995 CH, NI, OZ, NBR, BK
5 Light Linear Chandelier
10"W x 13.5"H x 41.25"L



43996 CH, NI, OZ, NBR, BK
1 Light Mini Pendant | 6"W x 10.75"H
page 104



45495 CH, CHCLR, NI, NICLR,
OZ, OZCLR, NBR, NBRCLR, BK, BKCLR
1 Light Wall Sconce | 4.5"W x 9.25"H
page 62



45496 CH, CHCLR, NI, NICLR,
OZ, OZCLR, NBR, NBRCLR, BK, BKCLR
2 Light Vanity | 15"W x 8.75"H
page 76



45497 CH, CHCLR, NI, NICLR,
OZ, OZCLR, NBR, NBRCLR, BK, BKCLR
3 Light Vanity | 23"W x 8.75"H
page 76



45498 CH, CHCLR, NI, NICLR,
OZ, OZCLR, NBR, NBRCLR, BK, BKCLR
4 Light Vanity | 31"W x 8.75"H
page 76



FEATURE
Pendant converts
to semi flush

Deryn™



43036 DAG
8 Light Chandelier
29.75"W x 36.5"H



43035 DAG
5 Light Chandelier
24"W x 21"H



43034 DAG
4 Light Chandelier
24.25"W x 30.25"H



43037 DAG
3 Light Chandelier
22"W x 18.25"H

Eileen™



1897 NI
9 Light Chandelier
30"W x 28.25"H



1896 NI
5 Light Chandelier
24"W x 16.5"H



3299 NI
4 Light Pendant
25.75"W x 26.25"H



3797 NI
3 Light / Semi Flush / Pendant
17.25"W x 14.5"H
page 54



3497 NI
1 Light Mini Pendant
4.5"W x 8"H
page 105



5096 NI
1 Light Wall Sconce
4.5"W x 10.75"H
page 63



5097 CH, NI
2 Light Vanity
14.25"W x 9"H
page 70



5098 CH, NI
3 Light Vanity
24"W x 9"H
page 70



5099 CH, NI
4 Light Vanity
33.75"W x 9.25"H
page 70



44043 AUB
5 Light Linear Chandelier
4.25"W x 12.75"H x 38.5"L



44044 AUB
4 Light Pendant
21.75"W x 22.75"H



44045 AUB
1 Light Mini Pendant
3.75"W x 14.75"H x 10.5"L
page 103



44046 AUB
4 Light Chandelier/Semi Flush
18"W x 14"H



Morrigan™



42497 NBR, NI, OZ
8 Light Chandelier
12.5"W x 19"H x 40.5"L



42498 NBR, NI, OZ
8 Light Chandelier
19"W x 34"H



42496 NBR, NI, OZ
4 Light Chandelier
15"W x 24.25"H



42499 NBR, NI, OZ
3 Light Pendant
10"W x 21"H









ACTUAL SIZE
Horizon Select

Downlights | Overview

Which Downlight series is right for your project?

Downlight Comparison		 Gen Page 34	 Horizon Page 36	 Zeo Page 38	 Ara Page 40	 DtC Page 41
LIGHT OUTPUT	Color Temp	2700K 3000K & Selectable (2700K-5000K)	2700K 3000K & Selectable (2700K-5000K)	3000K 4000K	3000K	2700K 3000K
	Delivered Lumens	Up to 1000lm	Up to 1180lm	Up to 1500lm	Up to 1650lm	Up to 900lm
DIMENSIONS	Diameter	6" 7"	6.5"	7" 10" 13"	5" 7" 9" 11"	3" 4" 5" 6" 7"
	Distance from Ceiling	1.19" or less	.87" or less	1"	.77" or less	.16" or less
STYLE	Finishes	White Olde Bronze®	White	White Brushed Nickel	White	Textured White
	Shapes	Round	Round	Round Square	Round	Round Square
INSTALLATION	Location	Wet	Wet	Damp Wet	Damp Wet	Damp Wet
	Box Type	4" Round or Hexagonal & Pancake	4" Round or Hexagonal & Pancake	4" Round or Hexagonal & Pancake	4" Round or Hexagonal & Pancake	4" Round or Hexagonal & Pancake



Ara Downlight

LED Downlights | Low Profile Generations

Gen Select

AVAILABLE Q4 2024



43849WH5CCT

43849WH5CCTB (24-Count Bulk Pack)

LIGHT OUTPUT	Selectable Color Temp	2700K 3000K 3500K 4000K 5000K
	Total Watts	15W
	CRI	90 CRI
	LPW	67 LPW
	Delivered Lumens	1000lm (@3000K)
SIZE	Diameter	7.4"
	Overall Height	1.35"
	Distance from Ceiling	1.19"
STYLE	Finish	White
	Diffuser	Polycarbonate
ACCESSORIES		Retrofit Can Kit 4146LED
FEATURES		

How-to Switch Color Temperatures





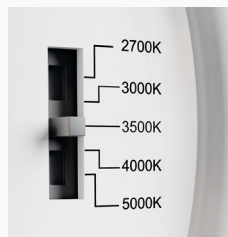



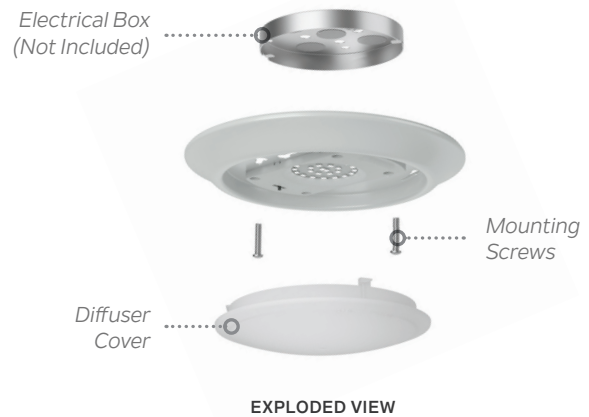

















Remove Diffuser Cover
(Apply Pressure and Twist)
No Tools Needed!





Select Color Option
(Factory Set at 3000K)



Gen II						
		43848WHLED27T	43848OZLED27T	43848WHLED30T	43848OZLED30T	43848WHLED40T
		N/A	N/A	43848WHLED30TB (24-Count Bulk Pack)	N/A	N/A
LIGHT OUTPUT	Color Temp	2700K		3000K		4000K
	Total Watts	16W				
	CRI	90 CRI				
	LPW	59 LPW		63 LPW		62.5 LPW
	Delivered Lumens	950lm		1000lm		
SIZE	Diameter	7.4"				
	Overall Height	1.28"				
	Distance from Ceiling	1.12"				
STYLE	Finish	White	Olde Bronze®	White	Olde Bronze®	White
	Diffuser	Polycarbonate				
ACCESSORIES		Retrofit Can Kit 4146LED				
FEATURES		      				

Gen I						
		43846WHLED27	43878WHLED27	43846WHLED30	43878WHLED30	43846WHLED40
		43846WHLED27B (24-Count Bulk Pack)	N/A	43846WHLED30B (24-Count Bulk Pack)	N/A	N/A
LIGHT OUTPUT	Color Temp	2700K		3000K		4000K
	Total Watts	14W	11W	14W	11W	14W
	CRI	90 CRI				
	LPW	60.7 LPW	54 LPW	60.7 LPW	54 LPW	61 LPW
	Delivered Lumens	850lm	600lm	850lm	600lm	850lm
SIZE	Diameter	7.4"	5.9"	7.4"	5.9"	7.4"
	Overall Height	1.35"				
	Distance from Ceiling	1.19"				
STYLE	Finish	White				
	Diffuser	Polycarbonate				
ACCESSORIES		Retrofit Can Kit 4146LED	Retrofit Can Kit 4145LED	Retrofit Can Kit 4146LED	Retrofit Can Kit 4145LED	Retrofit Can Kit 4146LED
FEATURES		      				

LED Downlights | Horizon

Horizon Select		 43874WH5CCT	
		43874WH5CCTB (24-Count Bulk Pack)	
LIGHT OUTPUT	Selectable Color Temp	2700K 3000K 3500K 4000K 5000K	
	Total Watts	15W	
	CRI	90 CRI	
	LPW	74 LPW	
	Delivered Lumens	1110lm (@3000K)	
SIZE	Diameter	6.5"	
	Overall Height	.87"	
	Distance from Ceiling	.87"	
STYLE	Finish	White	
	Diffuser	Polycarbonate	
ACCESSORIES		Retrofit Can Kit 4146LED	
FEATURES			

How-to Switch Color Temperatures



Remove Diffuser Cover
(Apply Pressure and Twist)
No Tools Needed!

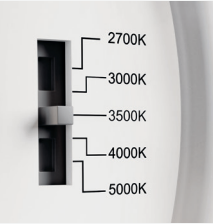

Select Color Option
(Factory Set at 3000K)

EXPLODED VIEW

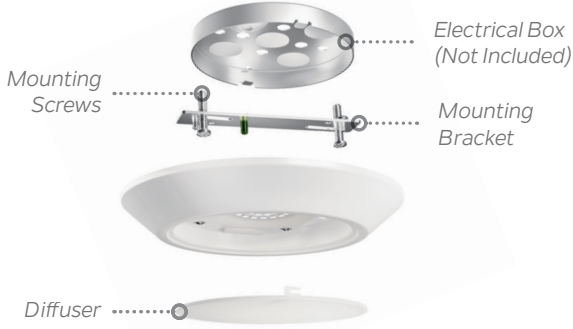

Electrical Box (Not Included)

Mounting Screws

Mounting Bracket









Diffuser

Consistent Dimming
Offers consistent dimming, down to 10%, to accommodate the lighting needs of a space throughout the day.

Better Power Regulation
Provides a wider input range of 108VAC-132VAC for better power regulation and improved LED consistency.

Enhanced Surge Protection
Enhanced surge protection (2.5KV) to protect the core components of the fixture from unexpected power surges.

Placement Flexibility
Simply snaps into an array of 4" J-box options, including a pancake box, for optimal placement flexibility.

Horizon III			
		43873WHLED27	43873WHLED30
		43873WHLED27B (24-Count Bulk Pack)	43873WHLED27B (24-Count Bulk Pack)
LIGHT OUTPUT	Color Temp	2700K	3000K
	Total Watts	14.5W	
	CRI	90 CRI	
	LPW	68 LPW	
	Delivered Lumens	1000lm	
SIZE	Diameter	6.4"	
	Overall Height	1.3"	
	Distance from Ceiling	.83"	
STYLE	Finish	White	
	Diffuser	Polycarbonate	
FEATURES		      	

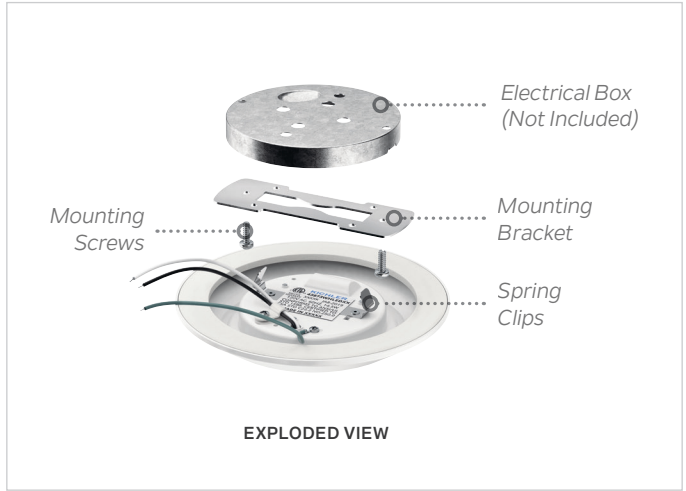







Consistent Dimming
Offers consistent dimming, down to 10%, to accommodate the lighting needs of a space throughout the day.









Better Power Regulation
Provides a wider input range of 108VAC-132VAC for better power regulation and improved LED consistency.

Enhanced Surge Protection
Enhanced surge protection (2.5KV) to protect the core components of the fixture from unexpected power surges.

Placement Flexibility
Simply snaps into an array of 4" J-box options, including a pancake box, for optimal placement flexibility.

LED Downlights | Zeo









<p>Zeo 7" Round</p>					
		<p>44244WHLED30</p>		<p>44244NILED30</p>	
LIGHT OUTPUT	Color Temp	3000K			
	Total Watts	14.5W			
	CRI	90 CRI			
	LPW	57 LPW			
	Delivered Lumens	820lm			
SIZE	Diameter	7"			
	Overall Height	1"			
	Distance from Ceiling	.93"			
STYLE	Finish	White		Brushed Nickel	
	Diffuser	White Acrylic			
FEATURES		    			

<p>Zeo 10" Round</p>							
		<p>44246WHLED30</p>		<p>44246NILED30</p>		<p>44246NILED40</p>	
LIGHT OUTPUT	Color Temp	3000K				4000K	
	Total Watts	18.5W					
	CRI	90 CRI					
	LPW	59 LPW					
	Delivered Lumens	1100lm					
SIZE	Diameter	10"					
	Overall Height	1"					
	Distance from Ceiling	.96"					
STYLE	Finish	White			Brushed Nickel		
	Diffuser	White Acrylic					
FEATURES		     					

<p style="text-align: center;">Zeo 13" Round</p>							
		44248WHLED30		44248NILED30		44248NILED40	
LIGHT OUTPUT	Color Temp	3000K				4000K	
	Total Watts	24W					
	CRI	90 CRI					
	LPW	62 LPW					
	Delivered Lumens	1500lm					
SIZE	Diameter	13"					
	Overall Height	1"					
	Distance from Ceiling	1"					
STYLE	Finish	White			Brushed Nickel		
	Diffuser	White Acrylic					
FEATURES							





<p style="text-align: center;">Zeo 13" Square</p>					
		44249WHLED30		44249NILED30	
LIGHT OUTPUT	Color Temp	3000K			
	Total Watts	24W			
	CRI	90 CRI			
	LPW	62 LPW			
	Delivered Lumens	1500lm			
SIZE	Width	13"			
	Overall Height	1"			
	Distance from Ceiling	1"			
STYLE	Finish	White		Brushed Nickel	
	Diffuser	White Acrylic			
FEATURES					





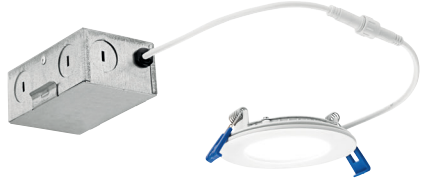
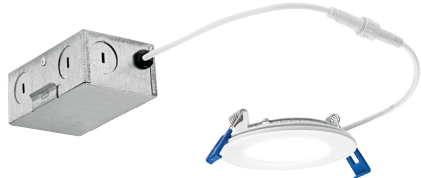



LED Downlights | Ara

<p>Ara</p> <p>AVAILABLE Q3 2024</p>					
		53005WH30	53007WH30	53009WH30	53011WH30
		N/A	53007WH30B (12-Count Bulk Pack)	N/A	53011WH30B (6-Count Bulk Pack)
LIGHT OUTPUT	Color Temp	3000K			
	Total Watts	11W	15W	18W	26W
	CRI	90 CRI			
	LPW	73 LPW	63 LPW	64 LPW	63 LPW
	Delivered Lumens	750lm	950lm	1100m	1600lm
SIZE	Diameter	5"	7"	9"	11"
	Overall Height	1.15"		1.17"	1.22"
	Distance from Ceiling	.71"		.75"	.77"
STYLE	Finish	White			
	Diffuser	Polycarbonate			
FEATURES		    			



LED Downlights | Direct-to-Ceiling (DtC) Slim





Slim 3.75" Round					
		DLSSL03R2790WHT		DLSSL03R3090WHT	
LIGHT OUTPUT	Color Temp	2700K		3000K	
	Total Watts	9W			
	CRI	90 CRI			
	LPW	55 LPW			
	Delivered Lumens	500lm			
SIZE	Diameter	4.1"			
	Overall Height	.8"			
	Distance from Ceiling	.1"			
	Ceiling Opening	3.63"			
STYLE	Finish	Textured White			
	Diffuser	Acrylic			
FEATURES		   			



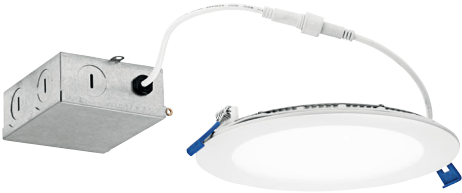
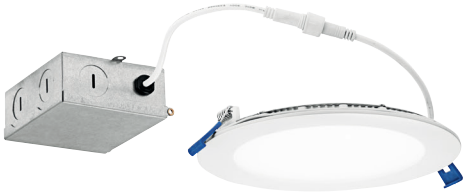

Slim 5" Round 6" Round									
		DLSSL04R2790WHT		DLSSL04R3090WHT		DLSSL05R2790WHT		DLSSL05R3090WHT	
LIGHT OUTPUT	Color Temp	2700K				3000K			
	Total Watts	12.5W				14W			
	CRI	90 CRI							
	LPW	56 LPW				57 LPW			
	Delivered Lumens	700lm				810lm			
SIZE	Diameter	5"				6.2"			
	Overall Height	.8"							
	Distance from Ceiling	.1"							
	Ceiling Opening	4.25"				5.5"			
STYLE	Finish	Textured White							
	Diffuser	Acrylic				Glass			
FEATURES		   							

Cord and box included with all DtC fixtures

 Wet
  Title 24 Compliant
  Dimmable
  Integrated LED

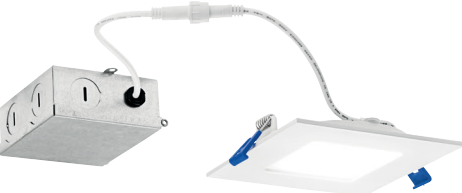
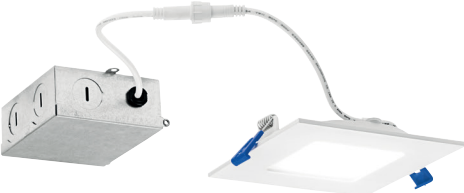
LED Downlights | Direct-to-Ceiling (DtC) Slim

Slim 7" Round					
		DLSSL06R2790WHT		DLSSL06R3090WHT	
LIGHT OUTPUT	Color Temp	2700K		3000K	
	Total Watts	14W			
	CRI	90 CRI			
	LPW	64 LPW			
	Delivered Lumens	900lm			
SIZE	Diameter	7"			
	Overall Height	.8"			
	Distance from Ceiling	.1"			
	Ceiling Opening	6.25"			
STYLE	Finish	Textured White			
	Diffuser	Glass			
FEATURES		   			

Slim 5" Square					
		DLSSL04S2790WHT		DLSSL04S3090WHT	
LIGHT OUTPUT	Color Temp	2700K		3000K	
	Total Watts	9W			
	CRI	90 CRI			
	LPW	55 LPW			
	Delivered Lumens	500lm			
SIZE	Width	4.9"			
	Overall Height	.8"			
	Distance from Ceiling	.1"			
	Ceiling Opening	4.25"			
STYLE	Finish	Textured White			
	Diffuser	Acrylic			
FEATURES		   			

Slim
7" Square

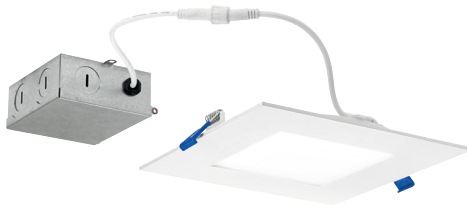

DLSSL06S2790WHT





DLSSL06S3090WHT



LIGHT OUTPUT	Color Temp	2700K	3000K
	Total Watts	12.5W	
	CRI	90 CRI	
	LPW	60 LPW	
	Delivered Lumens	750lm	
SIZE	Width	6.9"	
	Overall Height	.8"	
	Distance from Ceiling	.1"	
	Ceiling Opening	6.25"	
STYLE	Finish	Textured White	
	Diffuser	Glass	
FEATURES			









Cord and box included with all Dtc fixtures

LED Downlights | Direct-to-Ceiling (DtC) Recessed

<p>Recessed 5" Round</p>					
		<p>DLRC04R2790WHT</p>		<p>DLRC04R3090WHT</p>	
LIGHT OUTPUT	Color Temp	2700K		3000K	
	Total Watts	11.5W			
	CRI	90 CRI			
	LPW	60 LPW			
	Delivered Lumens	700lm			
SIZE	Diameter	5.1"			
	Overall Height	1.9"			
	Distance from Ceiling	.2"			
	Ceiling Opening	4"			
STYLE	Finish	Textured White			
	Diffuser	Acrylic			
FEATURES					

<p>Recessed 7" Round</p>					
		<p>DLRC06R2790WHT</p>		<p>DLRC06R3090WHT</p>	
LIGHT OUTPUT	Color Temp	2700K		3000K	
	Total Watts	13W			
	CRI	90 CRI			
	LPW	69 LPW			
	Delivered Lumens	900lm			
SIZE	Diameter	7.4"			
	Overall Height	1.9"			
	Distance from Ceiling	.2"			
	Ceiling Opening	5.25"			
STYLE	Finish	Textured White			
	Diffuser	Acrylic			
FEATURES					

<p style="text-align: center;">Recessed 5" Square</p>					
		DLRC04S2790WHT		DLRC04S3090WHT	
LIGHT OUTPUT	Color Temp	2700K		3000K	
	Total Watts	11.5W			
	CRI	90 CRI			
	LPW	60 LPW			
	Delivered Lumens	700lm			
SIZE	Width	4.9"			
	Overall Height	1.9"			
	Distance from Ceiling	.1"			
	Ceiling Opening	4"			
STYLE	Finish	Textured White			
	Diffuser	Acrylic			
FEATURES					

<p style="text-align: center;">Recessed 7" Square</p>					
		DLRC06S2790WHT		DLRC06S3090WHT	
LIGHT OUTPUT	Color Temp	2700K		3000K	
	Total Watts	13W			
	CRI	90 CRI			
	LPW	69 LPW			
	Delivered Lumens	900lm			
SIZE	Width	7.3"			
	Overall Height	1.9"			
	Distance from Ceiling	.1"			
	Ceiling Opening	6"			
STYLE	Finish	Textured White			
	Diffuser	Acrylic			
FEATURES					

Cord and box included with all Dtc fixtures

LED Downlights | Direct-to-Ceiling (DtC) Mini

Mini Recessed 3" Round



DLMN02R2790WHT



DLMN02R3090WHT

LIGHT OUTPUT	Color Temp	2700K	3000K
	Total Watts	8W	
	CRI	90 CRI	
	LPW	68 LPW	
	Delivered Lumens	550lm	
SIZE	Diameter	3.2"	
	Overall Height	2.4"	
	Distance from Ceiling	.1"	
	Ceiling Opening	2.875"	
STYLE	Finish	Textured White	
	Diffuser	Frosted	
FEATURES			

Mini Gimbal 2.5" Round





DLMG02R2790WHT



DLMG02R3090WHT

LIGHT OUTPUT	Color Temp	2700K	3000K
	Total Watts	5W	
	CRI	90 CRI	
	LPW	72 LPW	
	Delivered Lumens	360lm	
SIZE	Diameter	2.6"	
	Overall Height	1.5"	
	Distance from Ceiling	.2"	
	Ceiling Opening	2.125"	
STYLE	Finish	Textured White	
	Diffuser	Etched	
FEATURES			

Direct-to-Ceiling (DtC) | Accessories

Optional Accessories		Trim Rings		Goof Rings	Rough-In Plate	Extension Cables		
		BKT	NBR			6'	10'	20'
 <p>SLIM</p>	Slim Round	3"	DLTSL03RBKT	DLGR03WH	DLRP01ST	DLE06WH	DLE10WH	DLE20WH
		4"	DLTSL04RBKT DLTSL04RNBR	DLGR05WH	DLRP02ST			
		5"	DLTSL05RBKT	DLGR06AWH	DLRP02ST			
		6"	DLTSL06RBKT DLTSL06RNBR	DLGR07WH	DLRP02ST			
	Slim Square	4"	DLTSL04SBKT	-	DLRP02ST	DLE06WH	DLE10WH	DLE20WH
		6"	DLTSL06SBKT	-	DLRP02ST			
 <p>RECESSED</p>	Recessed Round	4"	DLTRC04RBKT	DLGR05WH	DLRP02ST	DLE06WH	DLE10WH	DLE20WH
		6"	DLTRC06RBKT	DLGR06BWH	DLRP02ST			
	Recessed Square	4"	-	-	DLRP02ST	DLE06WH	DLE10WH	DLE20WH
		6"	-	-	DLRP02ST			
	Recessed Mini	2"	-	DLGR02WH	DLRP01ST	DLE06WH	DLE10WH	DLE20WH
 <p>GIMBAL</p>	Gimbal Mini	2"	-	DLGR01WH	DLRP01ST	DLE06WH	DLE10WH	DLE20WH

LED Ceiling Lights



10784NILED
Brushed Nickel | White Acrylic
(1), 23W, 1280lm, 3000K, 90 CRI, 56 LPW
11.75"W x 3.5"H
D F T24 LED



10769NILED | Avon
Brushed Nickel | Acrylic Diffuser
(1), 28.5W, 1900lm, 3000K, 90 CRI, 66 LPW
14"W x 3.75"H
D F T24 LED



10786NILED
Brushed Nickel | White Acrylic
(1), 34W, 1790lm, 3000K, 90 CRI, 53 LPW
17.75"W x 4.25"H
D F T24 LED



10788NILED | Avon
Brushed Nickel | White Acrylic
(1), 48W, 3725lm, 3000K, 90 CRI, 78 LPW
24"W x 4.75"H
D F T24 LED



10784OZLED
Olde Bronze® | White Acrylic
(1), 23W, 1280lm, 3000K, 90 CRI, 56 LPW
11.75"W x 3.5"H
D F T24 LED



10769OZLED | Avon
Olde Bronze® | Acrylic Diffuser
(1), 28.5W, 1900lm, 3000K, 90 CRI, 66 LPW
14"W x 3.75"H
D F T24 LED



10786OZLED
Olde Bronze® | White Acrylic
(1), 34W, 1790lm, 3000K, 90 CRI, 53 LPW
17.75"W x 4.25"H
D F T24 LED



10788OZLED | Avon
Olde Bronze® | White Acrylic
(1), 48W, 3725lm, 3000K, 90 CRI, 78 LPW
24"W x 4.75"H
D F T24 LED

Our lighting exceeds the standards for efficiency, reliability and beauty.

- Long-life light emitting diodes (LED) provide approx. 40,000-hour life span to L70 (70% initial lumens) – about 5 years of standard operation
- True optics: pure white light and controlled beam spread with no fade or drop off of light
- High Color Rendering Index (CRI)
- Standard installation



10789NILED | Avon
Brushed Nickel | White Acrylic
(1), 54W, 3750lm, 3000K, 90 CRI, 69 LPW
18"W x 4.75"H x 32.5"L
D F T24 LED







10789OZLED | Avon
Olde Bronze® | White Acrylic
(1), 54W, 3750lm, 3000K, 90 CRI, 69 LPW
18"W x 4.75"H x 32.5"L
D F T24 LED



LED Ceiling Lights







11302CPLED | Pira
Champagne

Acrylic Applied Tint w/Painted Linen
(1) 19W, 1150lm, 3000K, 90 CRI, 62 LPW
12"W x 3.75"H     







11302NILED | Pira
Brushed Nickel

Acrylic Applied Tint w/Painted Linen
(1) 19W, 1150lm, 3000K, 90 CRI, 62 LPW
12"W x 3.75"H     







11303CPLED | Pira
Champagne

Acrylic Applied Tint w/Painted Linen
(1) 28.5W, 1800lm, 3000K, 90 CRI, 63 LPW
15"W x 4.5"H     



11303NILED | Pira
Brushed Nickel

Acrylic Applied Tint w/Painted Linen
(1) 28.5W, 1800lm, 3000K, 90 CRI, 63 LPW
15"W x 4.5"H     



10885NILED

Brushed Nickel | White Acrylic
(1), 23W, 1070lm, 3000K, 90 CRI, 47 LPW
13"W x 4.25"H
     







10886NILED

Brushed Nickel | White Acrylic
(1), 34W, 1500lm, 3000K, 90 CRI, 44 LPW
17.25"W x 4.25"H
     



42379NILED

Brushed Nickel | Etched Opal
(1), 22W, 1675lm, 3000K, 90 CRI, 76 LPW
13.25"W x 3.25"H
   







42379OZLEDR

Olde Bronze® | Etched Opal
(1), 22W, 1675lm, 3000K, 90 CRI, 76 LPW
13.25"W x 3.25"H
   







42379BKLEDR

Black | Etched Opal
(1), 22W, 1675lm, 3000K, 90 CRI, 76 LPW
13.25"W x 3.25"H
   







42380NILED

Brushed Nickel | Etched Opal
(1), 22W, 1675lm, 3000K, 90 CRI, 76 LPW
14"W x 3.25"H
   



10763NILED

Brushed Nickel | White Acrylic
(1), 15W, 930lm, 3000K, 90 CRI, 62 LPW
11.5"W x 3"H
     



10764NILED

Brushed Nickel | White Acrylic
(1), 23W, 1300lm, 3000K, 90 CRI, 57 LPW
14.5"W x 3.75"H
     



10765NILED

Brushed Nickel | White Acrylic
(1), 34W, 1860lm, 3000K, 90 CRI, 55 LPW
17.75"W x 4.5"H
    

LED Ceiling & Wall Lights



10766WHLED
White | Acrylic Diffuser
(1), 15W, 1080lm, 3000K, 90 CRI, 72 LPW
10.75"W x 3.75"H
D F T24 ADA Dimmable LED



10767WHLED
White | Acrylic Diffuser
(1), 20W, 1450lm, 3000K, 90 CRI, 73 LPW
13.5"W x 3.75"H
D F T24 ADA Dimmable LED



10768WHLED
White | Acrylic Diffuser
(1), 25W, 1850lm, 3000K, 90 CRI, 74 LPW
16"W x 3.75"H
D F T24 ADA Dimmable LED



10755WHLED
White | White Acrylic
(1), 15W, 1080lm, 3000K, 90 CRI, 72 LPW
10.75"W x 4"H
D F T24 ADA Dimmable LED



10760WHLED
White | White Acrylic
(1), 20W, 1470lm, 3000K, 90 CRI, 74 LPW
14"W x 4"H
D F T24 ADA Dimmable LED



10761WHLED
White | White Acrylic
(1), 25W, 1850lm, 3000K, 90 CRI, 74 LPW
16"W x 4.25"H
D F T24 ADA Dimmable LED



10301WHLED
White | White Acrylic
(1), 61W, 4350lm, 3000K, 90 CRI, 71 LPW
10.25"W x 3.25"H x 51"L
D F T24 ADA Dimmable LED



10303WH
White | White Acrylic
(2), 32W, BIPI
16.75"W x 5"H x 51.5"L
D F T24 ADA Dimmable LED



10303WHLED
White | White Acrylic
(1), 80W, 5725lm, 3000K, 90 CRI, 72 LPW
16.75"W x 5"H x 51.5"L
D F T24 ADA Dimmable LED



11304NILED
Brushed Nickel | White Acrylic
(1), 55W, 3400lm, 3000K, 90 CRI, 62 LPW
11.5"W x 4.75"H x 49.25"L
D F T24 ADA Dimmable LED



10315WH
White | Clear Prismatic Acrylic
(2), 32W, BIPI
7.5"W x 2.5"H x 48"L
D F T24 ADA Dimmable LED



10315WHLED
White | Textured Acrylic Diffuser
(1), 39W, 2800lm, 3000K, 90 CRI, 72 LPW
7.5"W x 2.5"H x 48"L
D F T24 ADA Dimmable LED

LED Ceiling Lights



43641NI | Jolie
Brushed Nickel | Satin Etched
(2), 100W, E26 (Medium)
15"W x 13.75"H
Converts to Pendant

43641NIL18
(2), 10W, 800lm, E26, 3000K
92 CRI, 80 LPW
T24 LED Dimmable LED Bulb Included



43641OZ | Jolie
Olde Bronze® | Satin Etched
(2), 100W, E26 (Medium)
15"W x 13.75"H
Converts to Pendant

43641OZL18
(2), 10W, 800lm, E26, 3000K
92 CRI, 80 LPW
T24 LED Dimmable LED Bulb Included



43669NI | Aubrey™
Brushed Nickel
Satin Etched Painted White Inside
(3), 100W, E26 (Medium)
15"W x 13"H

43669NIL18
(3), 10W, 800lm, E26, 3000K
92 CRI, 80 LPW
T24 LED Dimmable LED Bulb Included



43669OZ | Aubrey™
Olde Bronze®
Satin Etched Painted White Inside
(3), 100W, E26 (Medium)
15"W x 13"H

43669OZL18
(3), 10W, 800lm, E26, 3000K
92 CRI, 80 LPW
T24 LED Dimmable LED Bulb Included



43925NI | Joelson™
Brushed Nickel
Satin Etched Painted White Inside
(3), 100W, E26 (Medium)
17.75"W x 16.75"H | Converts to Pendant

43925NIL18
(3), 10W, 800lm, E26, 3000K
92 CRI, 80 LPW
T24 LED Dimmable LED Bulb Included



43925OZ | Joelson™
Olde Bronze®
Satin Etched Painted White Inside
(3), 100W, E26 (Medium)
17.75"W x 16.75"H | Converts to Pendant

43925OZL18
(3), 10W, 800lm, E26, 3000K
92 CRI, 80 LPW
T24 LED Dimmable LED Bulb Included



43926NI | Joelson™
Brushed Nickel
Satin Etched Painted White Inside
(3), 75W, E26 (Medium)
14.25"W x 11.75"H

43926NIL18
(3), 10W, 800lm, E26, 3000K
92 CRI, 80 LPW
T24 LED Dimmable LED Bulb Included



43926OZ | Joelson™
Olde Bronze®
Satin Etched Painted White Inside
(3), 75W, E26 (Medium)
14.25"W x 11.75"H

43926OZL18
(3), 10W, 800lm, E26, 3000K
92 CRI, 80 LPW
T24 LED Dimmable LED Bulb Included

For fixtures with LED, Title 24 Rated light bulbs included, look for "L18" in the model number.





Ceiling Lights



3122NI
Brushed Nickel | Satin Etched
(3), 100W, E26 (Medium)
15"W x 9.75"H

⊗



3797NI | Eileen™
Brushed Nickel | Satin Etched White
(3), 100W, E26 (Medium)
17.25"W x 14.5"H Converts to Pendant

⊗



3694NIW | Armida™
Brushed Nickel | Satin Etched White
(2), 100W, E26 (Medium)
15"W x 15.25"H Converts to Pendant

⊗



3694OZW | Armida™
Olde Bronze® | Satin Etched White
(2), 100W, E26 (Medium)
15"W x 15.25"H Converts to Pendant

⊗



3623NI | Dover™
Brushed Nickel | Etched Seeded
(3), 60W, E26 (Medium)
15.25"W x 14"H

⊗



42879NI | Nicholson™
Brushed Nickel | Satin Etched
(3), 100W, E26 (Medium)
16"W x 13.25"H

⊗



3627NI
Brushed Nickel | White Etched
(3), 100W, E26 (Medium)
15.5"W x 7.75"H

⊗ ⊗



8405NI
Brushed Nickel | Etched White
(2), 75W, E26 (Medium)
15"W x 6"H

⊗ ⊗



8406NI
Brushed Nickel | Etched White
(3), 60W, E26 (Medium)
17"W x 6.5"H

⊗ ⊗



Ceiling Lights



43675NBR | Shailene™
Natural Brass | Satin Etched
(3), 100W, E26 (Medium)
14"W x 10"H



43692NBR | Shailene™
Natural Brass | Satin Etched Diffuser
(3), 75W, E26 (Medium)
18"W x 11.5"H



43691NBR | Shailene™
Natural Brass | Satin Etched Diffuser
(3), 75W, E26 (Medium)
14"W x 10.25"H



43693NBR | Shailene™
Natural Brass | Satin Etched Diffuser
(3), 75W, E26 (Medium)
18"W x 11"H



43675BK | Shailene™
Black | Satin Etched
(3), 100W, E26 (Medium)
14"W x 10"H



43692BK | Shailene™
Black | Satin Etched Diffuser
(3), 75W, E26 (Medium)
18"W x 11.5"H



43691BK | Shailene™
Black | Satin Etched Diffuser
(3), 75W, E26 (Medium)
14"W x 10.25"H



43693BK | Shailene™
Black | Satin Etched Diffuser
(3), 75W, E26 (Medium)
18"W x 11"H



43675OZ | Shailene™
Olde Bronze® | Satin Etched
(3), 100W, E26 (Medium)
14"W x 10"H



43692OZ | Shailene™
Olde Bronze® | Satin Etched Diffuser
(3), 75W, E26 (Medium)
18"W x 11.5"H



43691OZ | Shailene™
Olde Bronze® | Satin Etched Diffuser
(3), 75W, E26 (Medium)
14"W x 10.25"H



43693OZ | Shailene™
Olde Bronze® | Satin Etched Diffuser
(3), 75W, E26 (Medium)
18"W x 11"H



43675NI | Shailene™
Brushed Nickel | Satin Etched
(3), 100W, E26 (Medium)
14"W x 10"H



43692NI | Shailene™
Brushed Nickel | Satin Etched Diffuser
(3), 75W, E26 (Medium)
18"W x 11.5"H



43691NI | Shailene™
Brushed Nickel | Satin Etched Diffuser
(3), 75W, E26 (Medium)
14"W x 10.25"H



43693NI | Shailene™
Brushed Nickel | Satin Etched Diffuser
(3), 75W, E26 (Medium)
18"W x 11"H





42296BK | Avery
Black | Clear Seeded
(1), 100W, E26 (Medium)
9.75"W x 11"H



42296NBR | Avery
Natural Brass | Clear Seeded
(1), 100W, E26 (Medium)
9.75"W x 11"H



42296NI | Avery
Brushed Nickel | Clear Seeded
(1), 100W, E26 (Medium)
9.75"W x 11"H



42296OZ | Avery
Olde Bronze® | Clear Seeded
(1), 100W, E26 (Medium)
9.75"W x 11"H



44033BK | Winslow
Black | Clear Seeded
(1), 75W, E26 (Medium)
8.5"W x 10.75"H



44033NBR | Winslow
Natural Brass | Clear Seeded
(1), 75W, E26 (Medium)
8.5"W x 10.75"H



44033NI | Winslow
Brushed Nickel | Clear Seeded
(1), 75W, E26 (Medium)
8.5"W x 10.75"H



44033OZ | Winslow
Olde Bronze® | Clear Seeded
(1), 75W, E26 (Medium)
8.5"W x 10.75"H



8064NI | Dover™
Brushed Nickel | Etched Seeded
(2), 60W, E26 (Medium)
13.25"W x 6.25"H



8065NI | Dover™
Brushed Nickel | Etched Seeded
(3), 60W, E26 (Medium)
15.25"W x 7.75"H



8064TZ | Dover™
Tannery Bronze | Etched Seeded
(2), 60W, E26 (Medium)
13.25"W x 6.25"H



8108NI
Brushed Nickel | Alabaster Swirl
(2), 60W, E26 (Medium)
11.25"W x 5"H



8109NI
Brushed Nickel | Alabaster Swirl
(2), 60W, E26 (Medium)
13.25"W x 5.25"H



8108TZ
Tannery Bronze | Alabaster Swirl
(2), 60W, E26 (Medium)
11.25"W x 5"H



8109TZ
Tannery Bronze | Alabaster Swirl
(2), 60W, E26 (Medium)
13.25"W x 5.25"H



Ceiling Lights



8111NI
Brushed Nickel | Satin Etched
(2), 60W, E26 (Medium)
11.25\"/>



8112NI
Brushed Nickel | Satin Etched
(2), 60W, E26 (Medium)
13.25\"/>



8110NI
Brushed Nickel | Alabaster Swirl
(3), 60W, E26 (Medium)
15.25\"/>



8116NI
Brushed Nickel | Satin Etched
(3), 60W, E26 (Medium)
15.25\"/>



8111BK
Black | Satin Etched
(2), 60W, E26 (Medium)
11.25\"/>



8112BK
Black | Satin Etched
(2), 60W, E26 (Medium)
13.25\"/>



8116BK
Black | Satin Etched
(3), 60W, E26 (Medium)
15.25\"/>



8111OZ
Olde Bronze® | Satin Etched
(2), 60W, E26 (Medium)
11.25\"/>



8112OZ
Olde Bronze® | Satin Etched
(2), 60W, E26 (Medium)
13.25\"/>



8116OZ
Olde Bronze® | Satin Etched
(3), 60W, E26 (Medium)
15.25\"/>



8653NI
Brushed Nickel | Satin Etched
(2), 60W, E26 (Medium)
11.25\"/>



8112CH
Chrome | Satin Etched
(2), 60W, E26 (Medium)
13.25\"/>



8110TZ
Tannery Bronze | Alabaster Swirl
(3), 60W, E26 (Medium)
15.25\"/>



8880NI
 Brushed Nickel | Satin Etched Cased Opal Twist On
 (1), 75W, E26 (Medium)
 10"W x 4.25"H
 D ⊗ ⊗



8881NI
 Brushed Nickel
 Satin Etched Cased Opal Twist On
 (1), 100W, E26 (Medium)
 14"W x 4.5"H D ⊗ ⊗



8882NI
 Brushed Nickel | Satin Etched Cased Opal Twist On
 (2), 60W, E26 (Medium)
 16.5"W x 5.5"H
 D ⊗ ⊗



206WH
 White | White
 (1), 60W, E26 (Medium)
 7.25"W x 4.75"H
 ⊗ ⊗



209WH
 White | White
 (2), 60W, E26 (Medium)
 8.75"W x 5.25"H
 ⊗ ⊗



208WH
 White | White
 (1), 60W, E26 (Medium)
 9"W x 5"H
 ⊗ ⊗



206NI
 Brushed Nickel | White
 (1), 60W, E26 (Medium)
 7.25"W x 4.75"H
 ⊗ ⊗



8206NI
 Brushed Nickel | Alabaster Swirl
 (1), 60W, E26 (Medium)
 7.25"W x 4.75"H
 ⊗ ⊗



209NI
 Brushed Nickel | White
 (2), 60W, E26 (Medium)
 8.75"W x 5.25"H
 ⊗ ⊗



8209NI
 Brushed Nickel | Alabaster Swirl
 (2), 60W, E26 (Medium)
 9.25"W x 5.5"H
 ⊗ ⊗



209OZ
 Olde Bronze® | White
 (2), 60W, E26 (Medium)
 8.75"W x 5.25"H
 ⊗ ⊗



216WH
 White | White Glass
 (1), 75W, E26 (Medium)
 5.75"W x 7"H
 ⊗ ⊗



7260WH
 White | White Glass
 (2), 60W, E26 (Medium)
 11.75"W x 5.5"H
 ⊗ ⊗

LED Wall Sconces



83837 | Izza
Black | Etched Opal Glass
(1), 21W, 850lm, 3000K, 91 CRI, 40 LPW
4.75"W x 13"H | Ext. 4.35"
D LED



83745 | Izza
Chrome | Etched Opal Glass
(1), 21W, 850lm, 3000K, 91 CRI, 40 LPW
4.75"W x 13"H | Ext. 4.35"
D LED



83757 | Traverso
Brushed Nickel | Etched Opal Glass
(1), 21W, 1100lm, 3000K, 91 CRI, 52 LPW
4.5"W x 13"H | Ext. 3.86"
D LED



83944 | Traverso
Chrome | Etched Opal Glass
(1), 21W, 1100lm, 3000K, 91 CRI, 52 LPW
4.5"W x 13"H | Ext. 3.86"
D LED



84186 | Neltev
Black | White Polycarbonate
(2), 18W, 625lm, 3000K, 92 CRI, 34 LPW
5"W x 14.5"H | Ext. 3"
D LED



83792 | Neltev
Chrome | White Polycarbonate
(2), 18W, 625lm, 3000K, 92 CRI, 34 LPW
5"W x 14.5"H | Ext. 3"
D LED



83793 | Neltev
Brushed Nickel | White Polycarbonate
(2), 18W, 625lm, 3000K, 90 CRI, 34 LPW
5"W x 14.5"H | Ext. 3"
D LED



42372NILED | Vego
Brushed Nickel
Clear Glass (Painted White Inside)
(1), 20W, 300lm, 3000K, 90 CRI, 15 LPW
5"W x 12"H | Ext. 3" D LED



45686NBRLED | Indeco
Natural Brass | Satin Etched White
(1), 16W, 1090lm, 3000K, 90 CRI, 68 LPW
5"W x 14.5"H | Ext. 3.5"
D LED



45686PNLED | Indeco
Polished Nickel | Satin Etched White
(1), 16W, 1090lm, 3000K, 90 CRI, 68 LPW
5"W x 14.5"H | Ext. 3.5"
D LED



45656CHLED | Trinsic™
Chrome | Satin Etched White
(1), 34.9W, 625lm, 3000K, 90 CRI, 23 LPW
4.5"W x 12"H | Ext. 3.5"
D LED



45656MBKLED | Trinsic™
Matte Black | Satin Etched White
(1), 34.9W, 625lm, 3000K, 90 CRI, 23 LPW
4.5"W x 12"H | Ext. 3.5"
D LED



45656NILED | Trinsic™
Brushed Nickel | Satin Etched White
(1), 34.9W, 625lm, 3000K, 90 CRI, 23 LPW
4.5"W x 12"H | Ext. 3.5"
D LED



120V-277V

11315NILED
Brushed Nickel | White Acrylic
(1), 22W, 1375lm, 3000K, 90 CRI, 62 LPW
7"W x 16"H | Ext. 3.75"
D LED



120V-277V

11315OZLED
Olde Bronze® | White Acrylic
(1), 22W, 1375lm, 3000K, 90 CRI, 62 LPW
7"W x 16"H | Ext. 3.75"
D LED



120V-277V

11319NILED
Brushed Nickel | White Acrylic
(1), 15W, 925lm, 3000K, 90 CRI, 62 LPW
9.5"W x 10.75"H | Ext. 3.75"
D LED



120V-277V

11319OZLED

Olde Bronze® | White Acrylic
(1), 15W, 925lm, 3000K, 90 CRI, 62 LPW
9.5"W x 10.75"H | Ext. 3.75"



10421SNLED

Satin Nickel | White Acrylic
(1), 16W, 910lm, 3000K, 90 CRI, 57 LPW
12"W x 10"H | Ext. 4"



10438NCHLED

Brushed Nickel & Chrome | White Acrylic
(1), 8W, 420lm, 3000K, 90 CRI, 53 LPW
5.5"W x 14.25"H | Ext. 3.75"



10439NCHLED

Brushed Nickel & Chrome | White Acrylic
(1), 16W, 880lm, 3000K, 90 CRI, 55 LPW
11"W x 14.25"H | Ext. 3.75"



10620NILED | Nobu

Brushed Nickel | White Acrylic
(1), 16W, 790lm, 3000K, 90 CRI, 50 LPW
13"W x 9.5"H | Ext. 4"



10795NILED

Brushed Nickel | White Acrylic
(1), 16W, 910lm, 3000K, 90 CRI, 57 LPW
11"W x 11.75"H | Ext. 4"



10797NILED

Brushed Nickel | White Acrylic
(1), 16W, 870lm, 3000K, 90 CRI, 54 LPW
8.25"W x 8"H | Ext. 3.5"



10630PNLED

Polished Nickel | White Acrylic
(1), 16W, 770lm, 3000K, 90 CRI, 48 LPW
15"W x 5.5"H | Ext. 4"



10790NILED

Brushed Nickel | White Acrylic
(1), 15W, 900lm, 3000K, 90 CRI, 60 LPW
3.5"W x 6"H x 11.75"L | Ext. 3.5"



10790OZLED

Olde Bronze® | White Acrylic
(1), 15W, 900lm, 3000K, 90 CRI, 60 LPW
3.5"W x 6"H x 11.75"L | Ext. 3.5"



Sleek, stylish and efficient, our LED Wall Sconces include:

- Universal Voltage (120V-277V) on select Sconce and Vanity fixtures
- Title 24 qualified fixtures to ensure quality light output and efficiency
- Durable components that have been tested and re-tested to withstand 24/7 illumination

LED Wall Sconces



45921NI | Joelson
Brushed Nickel

Satin Etched Cased Opal
(1), 100W, E26 (Medium)

5"W x 18.25"H | Ext. 5.25" **D** **↕** **⊕**

45921NIL18

(1), 10W, 800lm, E26, 3000K
92 CRI, 80 LPW

D **T24** **↕** **⊕**



45921OZ | Joelson

Olde Bronze® | Satin Etched Cased Opal
(1), 100W, E26 (Medium)

5"W x 18.25"H | Ext. 5.25"

D **↕** **⊕**

45921OZL18

(1), 10W, 800lm, E26, 3000K
92 CRI, 80 LPW

D **T24** **↕** **⊕**



45568NI | Aubrey™
Brushed Nickel

Satin Etched Cased Opal
(1), 100W, E26 (Medium)

5.5"W x 10.75"H | Ext. 7.25" **D** **↕** **⊕**

45568NIL18

(1), 10W, 800lm, E26, 3000K
92 CRI, 80 LPW

D **T24** **↕** **⊕**



45568OZ | Aubrey™

Olde Bronze® | Satin Etched Cased Opal
(1), 100W, E26 (Medium)

5.5"W x 10.75"H | Ext. 7.25"

D **↕** **⊕**

45568OZL18

(1), 10W, 800lm, E26, 3000K
92 CRI, 80 LPW

D **T24** **↕** **⊕**



45637CH | Jolie

Chrome | Satin Etched
(1), 100W, E26 (Medium)

5"W x 9"H | Ext. 6.25"

D **↕** **⊕**

45637CHL18

(1), 10W, 800lm, E26, 3000K
92 CRI, 80 LPW

D **T24** **↕** **⊕**



45637NI | Jolie

Brushed Nickel | Satin Etched
(1), 100W, E26 (Medium)

5"W x 9"H | Ext. 6.25"

D **↕** **⊕**

45637NIL18

(1), 10W, 800lm, E26, 3000K
92 CRI, 80 LPW

D **T24** **↕** **⊕**



45637OZ | Jolie

Olde Bronze® | Satin Etched
(1), 100W, E26 (Medium)

5"W x 9"H | Ext. 6.25"

D **↕** **⊕**

45637OZL18

(1), 10W, 800lm, E26, 3000K
92 CRI, 80 LPW

D **T24** **↕** **⊕**

Wall Sconces



45495BK | Crosby

Black | Satin Etched Cased Opal
(1), 100W, E26 (Medium)

4.5"W x 9.25"H | Ext. 6.25"

D **↕** **⊕**



45495NBR | Crosby

Natural Brass | Satin Etched Cased Opal
(1), 100W, E26 (Medium)

4.5"W x 9.25"H | Ext. 6.25"

D **↕** **⊕**



45495NI | Crosby

Brushed Nickel
Satin Etched Cased Opal
(1), 100W, E26 (Medium)

4.5"W x 9.25"H | Ext. 6.25" **D** **↕** **⊕**



45495CH | Crosby

Chrome | Satin Etched Cased Opal
(1), 100W, E26 (Medium)

4.5"W x 9.25"H | Ext. 6.25"

D **↕** **⊕**



45495OZ | Crosby
Olde Bronze® | Satin Etched Cased Opal
(1), 100W, E26 (Medium)
4.5"W x 9.25"H | Ext. 6.25"
D ↕ *



45495NBRCLR | Crosby
Natural Brass | Clear
(1), 100W, E26 (Medium)
4.5"W x 9.25"H | Ext. 6.25"
D ↕ *



45495CHCLR | Crosby
Chrome | Clear
(1), 100W, E26 (Medium)
4.5"W x 9.25"H | Ext. 6.25"
D ↕ *



45495NICLR | Crosby
Brushed Nickel | Clear
(1), 100W, E26 (Medium)
4.5"W x 9.25"H | Ext. 6.25"
D ↕ *



45495OZCLR | Crosby
Olde Bronze® | Clear
(1), 100W, E26 (Medium)
4.5"W x 9.25"H | Ext. 6.25"
D ↕ *



45495BKCLR | Crosby
Black | Clear
(1), 100W, E26 (Medium)
4.5"W x 9.25"H | Ext. 6.25"
D ↕ *



55085BK | Kennewick
Black | Clear
(1), 75W, E26 (Medium)
4.75"W x 9.75"H | Ext. 6.55"
D ↕ *



55085NI | Kennewick
Brushed Nickel | Clear
(1), 75W, E26 (Medium)
4.75"W x 9.75"H | Ext. 6.55"
D ↕ *



55085OZ | Kennewick
Olde Bronze® | Clear
(1), 75W, E26 (Medium)
4.75"W x 9.75"H | Ext. 6.55"
D ↕ *



44381BK | Valserrano™
Black | Satin Etched
(1), 75W, E26 (Medium)
5"W x 10.25"H | Ext. 7.25"
D ↕ *



44381NI | Valserrano™
Brushed Nickel | Satin Etched
(1), 75W, E26 (Medium)
5"W x 10.25"H | Ext. 7.25"
D ↕ *



44381BKCS | Valserrano™
Black | Clear Seeded
(1), 75W, E26 (Medium)
5"W x 10.25"H | Ext. 7.25"
D ↕ *



44381NICS | Valserrano™
Brushed Nickel | Clear Seeded
(1), 75W, E26 (Medium)
5"W x 10.25"H | Ext. 7.25"
D ↕ *



5096NI | Eileen™
Brushed Nickel
Satin Etched Cased Opal
(1), 100W, E26 (Medium)
4.5"W x 10.75"H | Ext. 7" D ↕ *



45572BK | Shailene™
Black | Satin Etched
(1), 100W, E26 (Medium)
5"W x 8.25"H | Ext. 6"
D ↕ *



45572NBR | Shailene™
Natural Brass | Satin Etched
(1), 100W, E26 (Medium)
5"W x 8.25"H | Ext. 6"
D ↕ *

Wall Sconces



45572NI | Shailene™
Brushed Nickel | Satin Etched
(1), 100W, E26 (Medium)
5"W x 8.25"H | Ext. 6"
D M Dim



45572CH | Shailene™
Chrome | Satin Etched
(1), 100W, E26 (Medium)
5"W x 8.25"H | Ext. 6"
D M Dim



45572OZ | Shailene™
Olde Bronze® | Satin Etched
(1), 100W, E26 (Medium)
5"W x 8.25"H | Ext. 6"
D M Dim



45572BKCLR | Shailene™
Black | Clear
(1), 100W, E26 (Medium)
5"W x 8.25"H | Ext. 6"
D M Dim



45572NBRCLR | Shailene™
Natural Brass | Clear
(1), 100W, E26 (Medium)
5"W x 8.25"H | Ext. 6"
D M Dim



45572NICLR | Shailene™
Brushed Nickel | Clear
(1), 100W, E26 (Medium)
5"W x 8.25"H | Ext. 6"
D M Dim



45572CHCLR | Shailene™
Chrome | Clear
(1), 100W, E26 (Medium)
5"W x 8.25"H | Ext. 6"
D M Dim



45572OZCLR | Shailene™
Olde Bronze® | Clear
(1), 100W, E26 (Medium)
5"W x 8.25"H | Ext. 6"
D M Dim



55183BK | Madden
Black | Clear
(1) 75W, E26 (Medium)
5"W x 14.75"H | Ext. 5.25"
D M Dim



55183CPZ | Madden
Champagne Bronze™ | Clear
(1) 75W, E26 (Medium)
5"W x 14.75"H | Ext. 5.25"
D M Dim



55183NI | Madden
Brushed Nickel | Clear
(1) 75W, E26 (Medium)
5"W x 14.75"H | Ext. 5.25"
D M Dim



55183CH | Madden
Chrome | Clear
(1) 75W, E26 (Medium)
5"W x 14.75"H | Ext. 5.25"
D M Dim



45910BK | Winslow
Black | Clear Seeded
(1), 75W, E26 (Medium)
4.75"W x 9.25"H | Ext. 6.5"
D M Dim



45910NBR | Winslow
Natural Brass | Clear Seeded
(1), 75W, E26 (Medium)
4.75"W x 9.25"H | Ext. 6.5"
D M Dim



45910NI | Winslow
Brushed Nickel | Clear Seeded
(1), 75W, E26 (Medium)
4.75"W x 9.25"H | Ext. 6.5"
D M Dim



45910OZ | Winslow
Olde Bronze® | Clear Seeded
(1), 75W, E26 (Medium)
4.75"W x 9.25"H | Ext. 6.5"
D M Dim



45892NI | Harmony
Brushed Nickel | Clear
(1), 75W, E26 (Medium)
6.5"W x 8"H | Ext. 8.25"
D ↕ ⊛



45892OZ | Harmony
Olde Bronze® | Clear
(1), 75W, E26 (Medium)
6.5"W x 8"H | Ext. 8.25"
D ↕ ⊛



45971BK | Avery
Black | Clear Seeded
(1), 75W, E26 (Medium)
5.5"W x 9.25"H | Ext. 8"
D ↕ ⊛



45971NBR | Avery
Natural Brass | Clear Seeded
(1), 75W, E26 (Medium)
5.5"W x 9.25"H | Ext. 8"
D ↕ ⊛



45971NI | Avery
Brushed Nickel | Clear Seeded
(1), 75W, E26 (Medium)
5.5"W x 9.25"H | Ext. 8"
D ↕ ⊛



45971OZ | Avery
Olde Bronze® | Clear Seeded
(1), 75W, E26 (Medium)
5.5"W x 9.25"H | Ext. 8"
D ↕ ⊛



52445BK | Erma
Black | Satin Etched
(1), 60W, E26 (Medium)
5"W x 8"H | Ext. 6"
D ↕ ⊛



52445NI | Erma
Brushed Nickel | Satin Etched
(1), 60W, E26 (Medium)
5"W x 8"H | Ext. 6"
D ↕ ⊛



52445OZ | Erma
Olde Bronze® | Satin Etched
(1), 60W, E26 (Medium)
5"W x 8"H | Ext. 6"
D ↕ ⊛



52437BK | Stamos
Black | Satin Etched
(1), 60W, E26 (Medium)
5"W x 8"H | Ext. 6.2"
D ↕ ⊛



52437NI | Stamos
Brushed Nickel | Satin Etched
(1), 60W, E26 (Medium)
5"W x 8"H | Ext. 6.2"
D ↕ ⊛



52437OZ | Stamos
Olde Bronze® | Satin Etched
(1), 60W, E26 (Medium)
5"W x 8"H | Ext. 6.2"
D ↕ ⊛



6520NI | Swiss Passport™
Brushed Nickel
Satin Etched Cased Opal
(1), 75W, E26 (Medium)
6"W x 8"H | Ext. 4" D ⊛



6719NI | Dover™
Brushed Nickel | Etched Seeded
(1), 100W, E26 (Medium)
6.25"W x 6.5"H | Ext. 6.75"
D ⊛



45881NI | Nicholson™
Brushed Nickel | Satin Etched
(1), 100W, E26 (Medium)
6"W x 10"H | Ext. 8.5"
D ↕ ⊛

LED Bath & Vanity



83743 | Izza
Brushed Nickel | Etched Opal Glass
(1), 42W, 2100lm, 3000K, 90 CRI, 50 LPW
25.25"W x 4.75"H | Ext. 4.35"



83838 | Izza
Black | Etched Opal Glass
(1), 42W, 2100lm, 3000K, 90 CRI, 50 LPW
25.25"W x 4.75"H | Ext. 4.35"



83742 | Izza
Chrome | Etched Opal Glass
(1), 42W, 2100lm, 3000K, 90 CRI, 50 LPW
25.25"W x 4.75"H | Ext. 4.35"



83756 | Traverso
Brushed Nickel | Etched Opal Glass
(1), 37W, 1900lm, 3000K, 90 CRI, 51 LPW
22"W x 4.5"H | Ext. 3.86"



83943 | Traverso
Chrome | Etched Opal Glass
(1), 37W, 1900lm, 3000K, 90 CRI, 51 LPW
22"W x 4.5"H | Ext. 3.86"



83759 | Rowan
Brushed Nickel | Etched Opal Glass
(1), 42W, 2400lm, 3000K, 90 CRI, 57 LPW
25.25"W x 4.75"H | Ext. 3.13"



83758 | Rowan
Chrome | Etched Opal Glass
(1), 42W, 2400lm, 3000K, 90 CRI, 57 LPW
25.25"W x 4.75"H | Ext. 3.13"



84129 | Rowan
Matte Black | Etched Opal Glass
(1), 42W, 2400lm, 3000K, 90 CRI, 57 LPW
25.25"W x 4.75"H | Ext. 3.13"

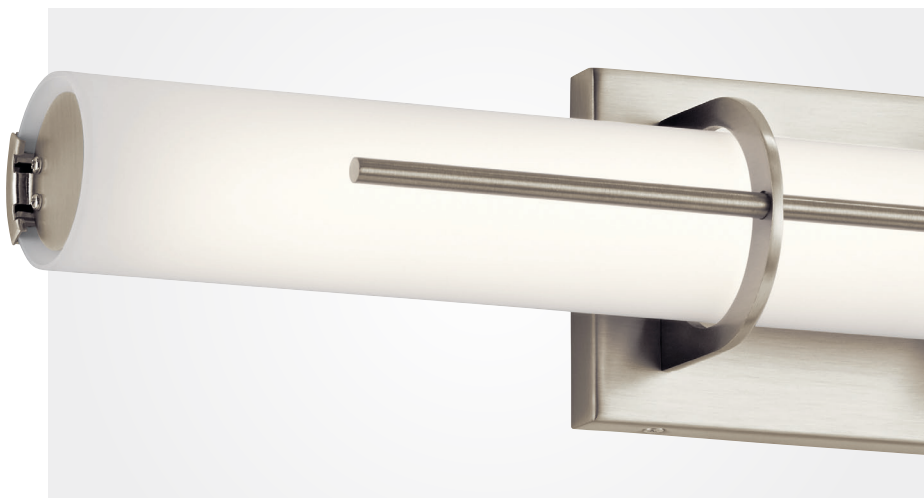



83736 | Neltev
 Chrome | Etched Opal Glass
 (1), 24W, 1300lm, 3000K, 90 CRI, 54 LPW
 24"W x 5"H | Ext. 3"
 [D] [M] [LED]

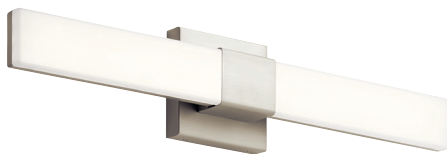

83737 | Neltev
 Satin Nickel | Etched Opal Glass
 (1), 24W, 1300lm, 3000K, 90 CRI, 54 LPW
 24"W x 5"H | Ext. 3"
 [D] [M] [LED]



84187 | Neltev
 Matte Black | Etched Opal Glass
 (1), 24W, 1300lm, 3000K, 90 CRI, 54 LPW
 24"W x 5"H | Ext. 3"
 [D] [M] [LED]



45657CHLED | Trinsic
 Chrome | Satin Etched White
 (2), 23W, 1350lm, 3000K, 90 CRI, 55 LPW
 22"W x 4.5"H | Ext. 3.5"
 [D] [M] [A] [LED]



45657MBKLED | Trinsic
 Matte Black | Satin Etched White
 (2), 23W, 1350lm, 3000K, 90 CRI, 55 LPW
 22"W x 4.5"H | Ext. 3.5"
 [D] [M] [A] [LED]



45657NILED | Trinsic
 Nickel | Satin Etched White
 (2), 23W, 1350lm, 3000K, 90 CRI, 55 LPW
 22"W x 4.5"H | Ext. 3.5"
 [D] [M] [A] [LED]



45658MBKLED | Trinsic
 Matte Black | Satin Etched White
 (3), 104.7W, 2200lm, 3000K, 90 CRI, 55 LPW
 32"W x 4.5"H | Ext. 3.5"
 [D] [M] [A] [LED]

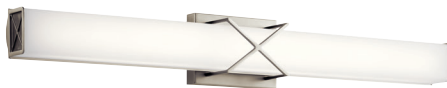

45658NILED | Trinsic
 Nickel | Satin Etched White
 (3), 104.7W, 2200lm, 3000K, 90 CRI, 55 LPW
 32"W x 4.5"H | Ext. 3.5"
 [D] [M] [A] [LED]

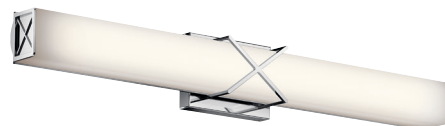

45658CHLED | Trinsic
 Chrome | Satin Etched White
 (3), 104.7W, 2200lm, 3000K, 90 CRI, 55 LPW
 32"W x 4.5"H | Ext. 3.5"
 [D] [M] [A] [LED]



LED Bath & Vanity

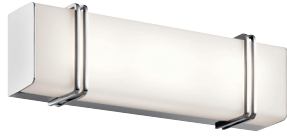

45801CHLED | Impello™
 Chrome | Satin Etched White
 (1), 20W, 900lm, 3000K, 90 CRI, 45 LPW
 18.25"W x 5.5"H | Ext. 3.5"



45838CHLED | Impello™
 Chrome | Satin Etched White
 (1), 25W, 1200lm, 3000K, 90 CRI, 46 LPW
 24.25"W x 5.5"H | Ext. 3.5"



45839CHLED | Impello™
 Chrome | Satin Etched White
 (1), 30W, 1275lm, 3000K, 90 CRI, 43 LPW
 30.25"W x 5.5"H | Ext. 3.5"



45838OZLED | Impello™
 Olde Bronze® | Satin Etched White
 (1), 25W, 1200lm, 3000K, 90 CRI, 46 LPW
 24.25"W x 5.5"H | Ext. 3.5"



45839OZLED | Impello™
 Olde Bronze® | Satin Etched White
 (1), 30W, 1275lm, 3000K, 90 CRI, 43 LPW
 30.25"W x 5.5"H | Ext. 3.5"



10798NILED
 Brushed Nickel | White Acrylic Diffuser
 (1), 32W, 1740lm, 3000K, 90 CRI, 54 LPW
 19.25"W x 6"H | Ext. 3.5"



10799NILED
 Brushed Nickel | White Acrylic Diffuser
 (1), 48W, 2640lm, 3000K, 90 CRI, 54 LPW
 30"W x 6"H | Ext. 3.5"



10800NILED
 Brushed Nickel | White Acrylic Diffuser
 (1), 64W, 3540lm, 3000K, 90 CRI, 55 LPW
 40.75"W x 6"H | Ext. 3.5"



45685NBRLED | Indeco™
 Natural Brass | Satin Etched White
 (2), 31W, 1915lm, 3000K, 90 CRI, 61 LPW
 27"W x 5"H | Ext. 3.75"

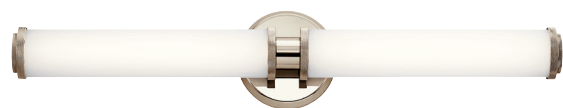

45685PNLED | Indeco™
 Polished Nickel | Satin Etched White
 (2), 31W, 1915lm, 3000K, 90 CRI, 61 LPW
 27"W x 5"H | Ext. 3.75"





11142NILED
 Brushed Nickel | White Polycarbonate
 (1), 20W, 1410lm, 3000K, 90 CRI, 71 LPW
 24.75"W x 4.5"H | Ext. 4"
 D + T24 ADA Dimmable LED



11143NILED
 Brushed Nickel | White Polycarbonate
 (1), 25.5W, 1960lm, 3000K, 90 CRI, 77 LPW
 36.5"W x 4.5"H | Ext. 4"
 D + T24 ADA Dimmable LED

120V-277V



11253NILED | Korona
 Brushed Nickel | White Acrylic Diffuser
 (1), 22W, 1425lm, 3000K, 90 CRI, 65 LPW
 24.75"W x 4.75"H | Ext. 3.75"
 D + T24 ADA Dimmable LED

120V-277V



11254NILED | Korona
 Brushed Nickel | White Acrylic Diffuser
 (1), 25W, 1725lm, 3000K, 90 CRI, 69 LPW
 36.75"W x 4.75"H | Ext. 3.75"
 D + T24 ADA Dimmable LED

120V-277V



11255NILED | Korona
 Brushed Nickel | White Acrylic Diffuser
 (1), 38W, 2525lm, 3000K, 90 CRI, 70 LPW
 48.5"W x 4.75"H | Ext. 3.75"
 D + T24 ADA Dimmable LED

120V-277V



11146NILED
 Brushed Nickel | White Acrylic Diffuser
 (1), 19W, 1420lm, 3000K, 90 CRI, 75 LPW
 25.75"W x 4.75"H | Ext. 4.25"
 D + T24 ADA Dimmable LED

120V-277V



11147NILED
 Brushed Nickel | White Acrylic Diffuser
 (1), 23W, 1850lm, 3000K, 90 CRI, 75 LPW
 37.5"W x 4.75"H | Ext. 4.25"
 D + T24 ADA Dimmable LED

120V-277V



11148NILED
 Brushed Nickel | White Acrylic Diffuser
 (1), 38W, 2680lm, 3000K, 90 CRI, 71 LPW
 49.25"W x 4.75"H | Ext. 4.25"
 D + T24 ADA Dimmable LED

120V-277V



11149NILED
 Brushed Nickel | White Acrylic Diffuser
 (1), 19W, 1440lm, 3000K, 90 CRI, 76 LPW
 25.5"W x 4.75"H | Ext. 4"
 D + T24 ADA Dimmable LED

120V-277V



11150NILED
 Brushed Nickel | White Acrylic Diffuser
 (1), 23W, 1890lm, 3000K, 90 CRI, 82 LPW
 37.25"W x 4.75"H | Ext. 4"
 D + T24 ADA Dimmable LED

120V-277V



11151NILED
 Brushed Nickel | White Acrylic Diffuser
 (1), 38W, 2750lm, 3000K, 90 CRI, 72 LPW
 49"W x 4.75"H | Ext. 4"
 D + T24 ADA Dimmable LED

LED Bath & Vanity



5097CH | Eileen™
 Chrome | Satin Etched Cased Opal
 (2), 100W, E26 (Medium)
 14.25"W x 9"H | Ext. 6"
 D ↕

5097CHL18
 (2), 10W, 800lm, E26, 3000K, 92 CRI, 80 LPW
 D ↕ T24



5098CH | Eileen™
 Chrome | Satin Etched Cased Opal
 (3), 100W, E26 (Medium)
 24"W x 9"H | Ext. 6"
 D ↕

5098CHL18
 (3), 10W, 800lm, E26, 3000K, 92 CRI, 80 LPW
 D ↕ T24



5099CH | Eileen™
 Chrome | Satin Etched Cased Opal
 (4), 100W, E26 (Medium)
 33.75"W x 9.25"H | Ext. 6"
 D ↕

5099CHL18
 (4), 10W, 800lm, E26, 3000K, 92 CRI, 80 LPW
 D ↕ T24



5097NI | Eileen™
 Brushed Nickel | Satin Etched Cased Opal
 (2), 100W, E26 (Medium)
 14.25"W x 9"H | Ext. 6"
 D ↕

5097NIL18
 (2), 10W, 800lm, E26, 3000K, 92 CRI, 80 LPW
 D ↕ T24



5098NI | Eileen™
 Brushed Nickel | Satin Etched Cased Opal
 (3), 100W, E26 (Medium)
 24"W x 9"H | Ext. 6"
 D ↕

5098NIL18
 (3), 10W, 800lm, E26, 3000K, 92 CRI, 80 LPW
 D ↕ T24



5099NI | Eileen™
 Brushed Nickel | Satin Etched Cased Opal
 (4), 100W, E26 (Medium)
 33.75"W x 9.25"H | Ext. 6"
 D ↕

5099NIL18
 (4), 10W, 800lm, E26, 3000K, 92 CRI, 80 LPW
 D ↕ T24

For fixtures with LED, Title 24 Rated light bulbs included, look for "L18" in the model number.





45569NI | Aubrey™
 Brushed Nickel | Satin Etched Cased Opal
 (2), 100W, E26 (Medium)
 13"W x 10.75"H | Ext. 6.5"
 D → *

45569NIL18
 (2), 10W, 800lm, E26, 3000K, 92 CRI, 80 LPW
 D → T24 *



45570NI | Aubrey™
 Brushed Nickel | Satin Etched Cased Opal
 (3), 100W, E26 (Medium)
 21"W x 11"H | Ext. 7.25"
 D → *

45570NIL18
 (3), 10W, 800lm, E26, 3000K, 92 CRI, 80 LPW
 D → T24 *



45571NI | Aubrey™
 Brushed Nickel | Satin Etched Cased Opal
 (4), 100W, E26 (Medium)
 29"W x 10.75"H | Ext. 6.5"
 D → *

45571NIL18
 (4), 10W, 800lm, E26, 3000K, 92 CRI, 80 LPW
 D → T24 *



45569OZ | Aubrey™
 Olde Bronze® | Satin Etched Cased Opal
 (2), 100W, E26 (Medium)
 13"W x 10.75"H | Ext. 6.5"
 D → *

45569OZL18
 (2), 10W, 800lm, E26, 3000K, 92 CRI, 80 LPW
 D → T24 *



45570OZ | Aubrey™
 Olde Bronze® | Satin Etched Cased Opal
 (3), 100W, E26 (Medium)
 21"W x 11"H | Ext. 7.25"
 D → *

45570OZL18
 (3), 10W, 800lm, E26, 3000K, 92 CRI, 80 LPW
 D → T24 *



45571OZ | Aubrey™
 Olde Bronze® | Satin Etched Cased Opal
 (4), 100W, E26 (Medium)
 29"W x 10.75"H | Ext. 6.5"
 D → *

45571OZL18
 (4), 10W, 800lm, E26, 3000K, 92 CRI, 80 LPW
 D → T24 *



LED Bath & Vanity



45375NI | Armida™
Brushed Nickel | Satin Etched White
(2), 100W, E26 (Medium)
14"W x 8.75"H | Ext. 5.75"



45375NIL18
(2), 10W, 800lm, E26, 3000K, 92 CRI, 80 LPW



45376NI | Armida™
Brushed Nickel | Satin Etched White
(3), 100W, E26 (Medium)
23"W x 8.5"H | Ext. 5.75"



45376NIL18
(3), 10W, 800lm, E26, 3000K, 92 CRI, 80 LPW



45377NI | Armida™
Brushed Nickel | Satin Etched White
(4), 100W, E26 (Medium)
32.25"W x 9"H | Ext. 5.75"



45377NIL18
(4), 10W, 800lm, E26, 3000K, 92 CRI, 80 LPW



45375OZ | Armida™
Olde Bronze® | Satin Etched White
(2), 100W, E26 (Medium)
14"W x 8.75"H | Ext. 5.75"



45375OZL18
(2), 10W, 800lm, E26, 3000K, 92 CRI, 80 LPW



45376OZ | Armida™
Olde Bronze® | Satin Etched White
(3), 100W, E26 (Medium)
23"W x 8.5"H | Ext. 5.75"



45376OZL18
(3), 10W, 800lm, E26, 3000K, 92 CRI, 80 LPW



45377OZ | Armida™
Olde Bronze® | Satin Etched White
(4), 100W, E26 (Medium)
32.25"W x 9"H | Ext. 5.75"



45377OZL18
(4), 10W, 800lm, E26, 3000K, 92 CRI, 80 LPW



For fixtures with LED, Title 24 Rated light bulbs included, look for "L18" in the model number.





45922NI | Joelson™
Brushed Nickel | Satin Etched Cased Opal
(2), 100W, E26 (Medium)
14"W x 9.25"H | Ext. 5.25"



45922NIL18
(2), 10W, 800lm, E26, 3000K, 92 CRI, 80 LPW



45923NI | Joelson™
Brushed Nickel | Satin Etched Cased Opal
(3), 100W, E26 (Medium)
24"W x 9.25"H | Ext. 5.25"



45923NIL18
(3), 10W, 800lm, E26, 3000K, 92 CRI, 80 LPW



45924NI | Joelson™
Brushed Nickel | Satin Etched Cased Opal
(4), 100W, E26 (Medium)
34"W x 9.25"H | Ext. 5.25"



45924NIL18
(4), 10W, 800lm, E26, 3000K, 92 CRI, 80 LPW



45922OZ | Joelson™
Olde Bronze® | Satin Etched Cased Opal
(2), 100W, E26 (Medium)
14"W x 9.25"H | Ext. 5.25"



45922OZL18
(2), 10W, 800lm, E26, 3000K, 92 CRI, 80 LPW



45923OZ | Joelson™
Olde Bronze® | Satin Etched Cased Opal
(3), 100W, E26 (Medium)
24"W x 9.25"H | Ext. 5.25"



45923OZL18
(3), 10W, 800lm, E26, 3000K, 92 CRI, 80 LPW



45924OZ | Joelson™
Olde Bronze® | Satin Etched Cased Opal
(4), 100W, E26 (Medium)
34"W x 9.25"H | Ext. 5.25"



45924OZL18
(4), 10W, 800lm, E26, 3000K, 92 CRI, 80 LPW

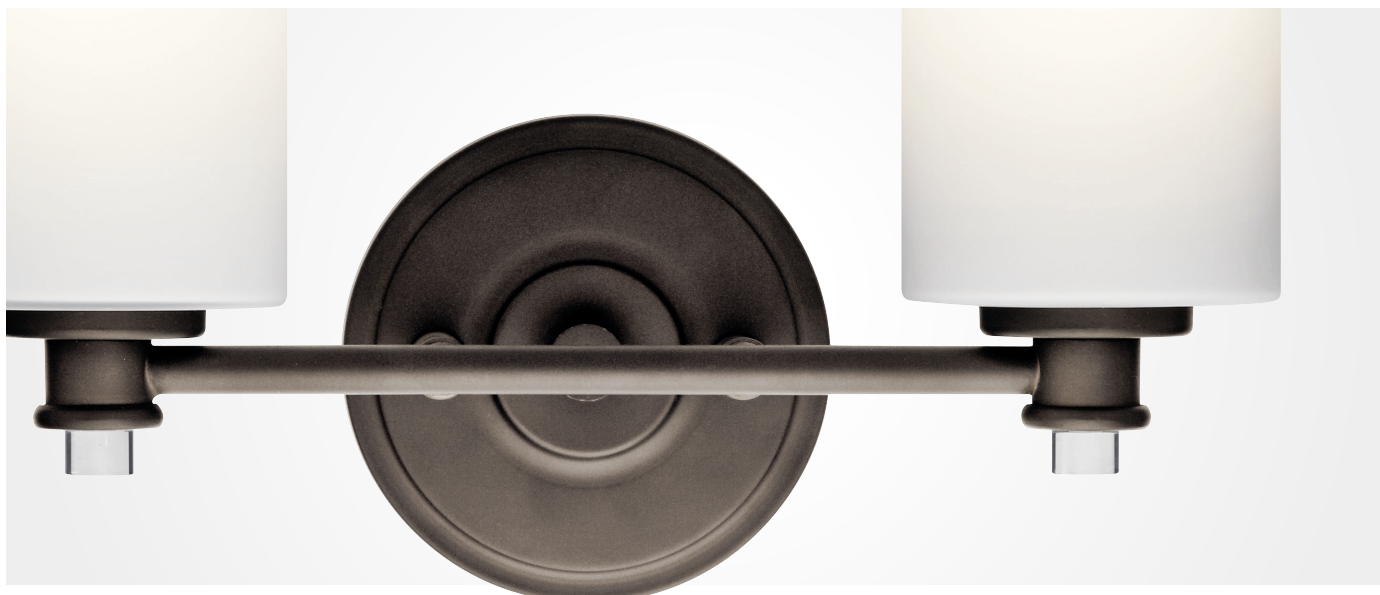

LED Bath & Vanity



45638CH | Jolie
Chrome | Satin Etched
(2), 100W, E26 (Medium)
13"W x 9.25"H | Ext. 8"



45638CHL18
(2), 10W, 800lm, E26, 3000K, 92 CRI, 80 LPW



45639CH | Jolie
Chrome | Satin Etched
(3), 100W, E26 (Medium)
20.25"W x 9.25"H | Ext. 8"



45639CHL18
(3), 10W, 800lm, E26, 3000K, 92 CRI, 80 LPW



45640CH | Jolie
Chrome | Satin Etched
(4), 100W, E26 (Medium)
28"W x 9.25"H | Ext. 8"



45640CHL18
(4), 10W, 800lm, E26, 3000K, 92 CRI, 80 LPW



45638NI | Jolie
Brushed Nickel | Satin Etched
(2), 100W, E26 (Medium)
13"W x 9.25"H | Ext. 8"



45638NIL18
(2), 10W, 800lm, E26, 3000K, 92 CRI, 80 LPW



45639NI | Jolie
Brushed Nickel | Satin Etched
(3), 100W, E26 (Medium)
20.25"W x 9.25"H | Ext. 8"



45639NIL18
(3), 10W, 800lm, E26, 3000K, 92 CRI, 80 LPW



45640NI | Jolie
Brushed Nickel | Satin Etched
(4), 100W, E26 (Medium)
28"W x 9.25"H | Ext. 8"



45640NIL18
(4), 10W, 800lm, E26, 3000K, 92 CRI, 80 LPW



45638OZ | Jolie
Olde Bronze® | Satin Etched
(2), 100W, E26 (Medium)
13"W x 9.25"H | Ext. 8"



45638OZL18
(2), 10W, 800lm, E26, 3000K, 92 CRI, 80 LPW



45639OZ | Jolie
Olde Bronze® | Satin Etched
(3), 100W, E26 (Medium)
20.25"W x 9.25"H | Ext. 8"



45639OZL18
(3), 10W, 800lm, E26, 3000K, 92 CRI, 80 LPW



45640OZ | Jolie
Olde Bronze® | Satin Etched
(4), 100W, E26 (Medium)
28"W x 9.25"H | Ext. 8"



45640OZL18
(4), 10W, 800lm, E26, 3000K, 92 CRI, 80 LPW



Bath & Vanity



45496BK | Crosby
Black | Satin Etched Cased Opal
(2), 100W, E26 (Medium)
15"W x 8.75"H | Ext. 6.75"



45497BK | Crosby
Black | Satin Etched Cased Opal
(3), 100W, E26 (Medium)
23"W x 8.75"H | Ext. 7"



45498BK | Crosby
Black | Satin Etched Cased Opal
(4), 100W, E26 (Medium)
31"W x 8.75"H | Ext. 6.75"



45496CH | Crosby
Chrome | Satin Etched Cased Opal
(2), 100W, E26 (Medium)
15"W x 8.75"H | Ext. 6.5"



45497CH | Crosby
Chrome | Satin Etched Cased Opal
(3), 100W, E26 (Medium)
23"W x 8.75"H | Ext. 7"



45498CH | Crosby
Chrome | Satin Etched Cased Opal
(4), 100W, E26 (Medium)
31"W x 8.75"H | Ext. 6.75"



45496NI | Crosby
Brushed Nickel | Satin Etched Cased Opal
(2), 100W, E26 (Medium)
15"W x 8.75"H | Ext. 6.75"



45497NI | Crosby
Brushed Nickel | Satin Etched Cased Opal
(3), 100W, E26 (Medium)
23"W x 8.75"H | Ext. 7"



45498NI | Crosby
Brushed Nickel | Satin Etched Cased Opal
(4), 100W, E26 (Medium)
31"W x 8.75"H | Ext. 6.75"



45496OZ | Crosby
Olde Bronze® | Satin Etched Cased Opal
(2), 100W, E26 (Medium)
15"W x 8.75"H | Ext. 6.75"



45497OZ | Crosby
Olde Bronze® | Satin Etched Cased Opal
(3), 100W, E26 (Medium)
23"W x 8.75"H | Ext. 7"



45498OZ | Crosby
Olde Bronze® | Satin Etched Cased Opal
(4), 100W, E26 (Medium)
31"W x 8.75"H | Ext. 6.75"



Bath & Vanity



45496NBR | Crosby
Natural Brass | Satin Etched Cased Opal
(2), 100W, E26 (Medium)
15"W x 8.75"H | Ext. 6.75"
D ↕ ⊛



45497NBR | Crosby
Natural Brass | Satin Etched Cased Opal
(3), 100W, E26 (Medium)
23"W x 8.75"H | Ext. 7"
D ↕ ⊛



45498NBR | Crosby
Natural Brass | Satin Etched Cased Opal
(4), 100W, E26 (Medium)
31"W x 8.75"H | Ext. 6.75"
D ↕ ⊛



45496NBRCLR | Crosby
Natural Brass | Clear
(2), 100W, E26 (Medium)
15"W x 8.75"H | Ext. 6.75"
D ↕ ⊛



45497NBRCLR | Crosby
Natural Brass | Clear
(3), 100W, E26 (Medium)
23"W x 8.75"H | Ext. 7"
D ↕ ⊛



45498NBRCLR | Crosby
Natural Brass | Clear
(4), 100W, E26 (Medium)
31"W x 8.75"H | Ext. 6.75"
D ↕ ⊛



45496CHCLR | Crosby
Chrome | Clear
(2), 100W, E26 (Medium)
15"W x 8.75"H | Ext. 6.75"
D ↕ ⊛



45497CHCLR | Crosby
Chrome | Clear
(3), 100W, E26 (Medium)
23"W x 8.75"H | Ext. 7"
D ↕ ⊛



45498CHCLR | Crosby
Chrome | Clear
(4), 100W, E26 (Medium)
31"W x 8.75"H | Ext. 6.75"
D ↕ ⊛



45496NICLR | Crosby
Brushed Nickel | Clear
(2), 100W, E26 (Medium)
15"W x 8.75"H | Ext. 6.75"
D ↕ ⊛



45497NICLR | Crosby
Brushed Nickel | Clear
(3), 100W, E26 (Medium)
23"W x 8.75"H | Ext. 7"
D ↕ ⊛



45498NICLR | Crosby
Brushed Nickel | Clear
(4), 100W, E26 (Medium)
31"W x 8.75"H | Ext. 6.75"
D ↕ ⊛



45496OZCLR | Crosby
 Olde Bronze® | Clear
 (2), 100W, E26 (Medium)
 15"W x 8.75"H | Ext. 6.75"
 D ↕ Ⓢ



45497OZCLR | Crosby
 Olde Bronze® | Clear
 (3), 100W, E26 (Medium)
 23"W x 8.75"H | Ext. 7"
 D ↕ Ⓢ



45498OZCLR | Crosby
 Olde Bronze® | Clear
 (4), 100W, E26 (Medium)
 31"W x 8.75"H | Ext. 6.75"
 D ↕ Ⓢ



45496BKCLR | Crosby
 Black | Clear
 (2), 100W, E26 (Medium)
 15"W x 8.75"H | Ext. 6.75"
 D ↕ Ⓢ



45497BKCLR | Crosby
 Black | Clear
 (3), 100W, E26 (Medium)
 23"W x 8.75"H | Ext. 7"
 D ↕ Ⓢ



45498BKCLR | Crosby
 Black | Clear
 (4), 100W, E26 (Medium)
 31"W x 8.75"H | Ext. 6.75"
 D ↕ Ⓢ



Bath & Vanity



55086BK | Kennewick™
Black | Satin Etched
(2) 75W Medium
13.25"W x 9.75"H | Ext. 6.75"
D → ⊕



55087BK | Kennewick™
Black | Satin Etched
(3) 75W Medium
22.75"W x 9.75"H | Ext. 6.75"
D → ⊕



55088BK | Kennewick™
Black | Satin Etched
(4) 75W Medium
32.25"W x 9.75"H | Ext. 6.75"
D → ⊕



55086NI | Kennewick™
Brushed Nickel | Satin Etched
(2) 75W Medium
13.25"W x 9.75"H | Ext. 6.75"
D → ⊕



55087NI | Kennewick™
Brushed Nickel | Satin Etched
(3) 75W Medium
22.75"W x 9.75"H | Ext. 6.75"
D → ⊕



55088NI | Kennewick™
Brushed Nickel | Satin Etched
(4) 75W Medium
32.25"W x 9.75"H | Ext. 6.75"
D → ⊕



55086OZ | Kennewick™
Olde Bronze® | Satin Etched
(2) 75W Medium
13.25"W x 9.75"H | Ext. 6.75"
D → ⊕



55087OZ | Kennewick™
Olde Bronze® | Satin Etched
(3) 75W Medium
22.75"W x 9.75"H | Ext. 6.75"
D → ⊕



55088OZ | Kennewick™
Olde Bronze® | Satin Etched
(4) 75W Medium
32.25"W x 9.75"H | Ext. 6.75"
D → ⊕



45573CH | Shailene™
Chrome | Satin Etched
(2), 100W, E26 (Medium)
12.5"W x 8.25"H | Ext. 6.25"
D → ⊕



45574CH | Shailene™
Chrome | Satin Etched
(3), 100W, E26 (Medium)
21"W x 8.25"H | Ext. 6.25"
D → ⊕



45575CH | Shailene™
Chrome | Satin Etched
(4), 100W, E26 (Medium)
29.75"W x 8.25"H | Ext. 6.25"
D → ⊕



45573NI | Shailene™
 Brushed Nickel | Satin Etched
 (2), 100W, E26 (Medium)
 12.5"W x 8.25"H | Ext. 6.25"
 D ↕ ⊛



45574NI | Shailene™
 Brushed Nickel | Satin Etched
 (3), 100W, E26 (Medium)
 21"W x 8.25"H | Ext. 6.25"
 D ↕ ⊛



45575NI | Shailene™
 Brushed Nickel | Satin Etched
 (4), 100W, E26 (Medium)
 29.75"W x 8.25"H | Ext. 6.25"
 D ↕ ⊛



45573OZ | Shailene™
 Olde Bronze® | Satin Etched
 (2), 100W, E26 (Medium)
 12.5"W x 8.25"H | Ext. 6.25"
 D ↕ ⊛



45574OZ | Shailene™
 Olde Bronze® | Satin Etched
 (3), 100W, E26 (Medium)
 21"W x 8.25"H | Ext. 6.25"
 D ↕ ⊛



45575OZ | Shailene™
 Olde Bronze® | Satin Etched
 (4), 100W, E26 (Medium)
 29.75"W x 8.25"H | Ext. 6.25"
 D ↕ ⊛



45573BK | Shailene™
 Black | Satin Etched
 (2), 100W, E26 (Medium)
 12.5"W x 8.25"H | Ext. 6.25"
 D ↕ ⊛



45574BK | Shailene™
 Black | Satin Etched
 (3), 100W, E26 (Medium)
 21"W x 8.25"H | Ext. 6.25"
 D ↕ ⊛



45575BK | Shailene™
 Black | Satin Etched
 (4), 100W, E26 (Medium)
 29.75"W x 8.25"H | Ext. 6.25"
 D ↕ ⊛



45573NBR | Shailene™
 Natural Brass | Satin Etched
 (2), 100W, E26 (Medium)
 12.5"W x 8.25"H | Ext. 6.25"
 D ↕ ⊛



45574NBR | Shailene™
 Natural Brass | Satin Etched
 (3), 100W, E26 (Medium)
 21"W x 8.25"H | Ext. 6.25"
 D ↕ ⊛



45575NBR | Shailene™
 Natural Brass | Satin Etched
 (4), 100W, E26 (Medium)
 29.75"W x 8.25"H | Ext. 6.25"
 D ↕ ⊛

Bath & Vanity



45573CHCLR | Shailene™
Chrome | Satin Etched
(2), 100W, E26 (Medium)
12.5"W x 8.25"H | Ext. 6.25"



45574CHCLR | Shailene™
Chrome | Satin Etched
(3), 100W, E26 (Medium)
21"W x 8.25"H | Ext. 6.25"



45575CHCLR | Shailene™
Chrome | Satin Etched
(4), 100W, E26 (Medium)
29.75"W x 8.25"H | Ext. 6.25"



45573NICLR | Shailene™
Brushed Nickel | Satin Etched
(2), 100W, E26 (Medium)
12.5"W x 8.25"H | Ext. 6.25"



45574NICLR | Shailene™
Brushed Nickel | Satin Etched
(3), 100W, E26 (Medium)
21"W x 8.25"H | Ext. 6.25"



45575NICLR | Shailene™
Brushed Nickel | Satin Etched
(4), 100W, E26 (Medium)
29.75"W x 8.25"H | Ext. 6.25"



45573OZCLR | Shailene™
Olde Bronze® | Satin Etched
(2), 100W, E26 (Medium)
12.5"W x 8.25"H | Ext. 6.25"



45574OZCLR | Shailene™
Olde Bronze® | Satin Etched
(3), 100W, E26 (Medium)
21"W x 8.25"H | Ext. 6.25"



45575OZCLR | Shailene™
Olde Bronze® | Satin Etched
(4), 100W, E26 (Medium)
29.75"W x 8.25"H | Ext. 6.25"



45573BKCLR | Shailene™
Black | Satin Etched
(2), 100W, E26 (Medium)
12.5"W x 8.25"H | Ext. 6.25"



45574BKCLR | Shailene™
Black | Satin Etched
(3), 100W, E26 (Medium)
21"W x 8.25"H | Ext. 6.25"



45575BKCLR | Shailene™
Black | Satin Etched
(4), 100W, E26 (Medium)
29.75"W x 8.25"H | Ext. 6.25"





45573NBRLR | Shailene™
 Natural Brass | Satin Etched
 (2), 100W, E26 (Medium)
 12.5"W x 8.25"H | Ext. 6.25"



45574NBRLR | Shailene™
 Natural Brass | Satin Etched
 (3), 100W, E26 (Medium)
 21"W x 8.25"H | Ext. 6.25"



45575NBRLR | Shailene™
 Natural Brass | Satin Etched
 (4), 100W, E26 (Medium)
 29.75"W x 8.25"H | Ext. 6.25"



Bath & Vanity



55184BK | Madden
Black | Clear
(2) 75W, E26 (Medium)
14.25"W x 10.5"H | Ext. 5.25"
D ↕ *



55185BK | Madden
Black | Clear
(3) 75W, E26 (Medium)
24"W x 10.5"H | Ext. 5.25"
D ↕ *



55186BK | Madden
Black | Clear
(4) 75W, E26 (Medium)
34"W x 10.5"H | Ext. 5"
D ↕ *



55184CPZ | Madden
Champagne Bronze™ | Clear
(2) 75W, E26 (Medium)
14.25"W x 10.5"H | Ext. 5.25"
D ↕ *



55185CPZ | Madden
Champagne Bronze™ | Clear
(3) 75W, E26 (Medium)
24"W x 10.5"H | Ext. 5.25"
D ↕ *



55186CPZ | Madden
Champagne Bronze™ | Clear
(4) 75W, E26 (Medium)
34"W x 10.5"H | Ext. 5"
D ↕ *



55184NI | Madden
Brushed Nickel | Clear
(2) 75W, E26 (Medium)
14.25"W x 10.5"H | Ext. 5.25"
D ↕ *



55185NI | Madden
Brushed Nickel | Clear
(3) 75W, E26 (Medium)
24"W x 10.5"H | Ext. 5.25"
D ↕ *



55186NI | Madden
Brushed Nickel | Clear
(4) 75W, E26 (Medium)
34"W x 10.5"H | Ext. 5"
D ↕ *



55184CH | Madden
Chrome | Clear
(2) 75W, E26 (Medium)
14.25"W x 10.5"H | Ext. 5.25"
D ↕ *



55185CH | Madden
Chrome | Clear
(3) 75W, E26 (Medium)
24"W x 10.5"H | Ext. 5.25"
D ↕ *



55186CH | Madden
Chrome | Clear
(4) 75W, E26 (Medium)
34"W x 10.5"H | Ext. 5"
D ↕ *



45885BK | Winslow
Black | Clear Seeded
(2), 75W, E26 (Medium)
13"W x 9.25"H | Ext. 6.5"



45886BK | Winslow
Black | Clear Seeded
(3), 75W, E26 (Medium)
21.5"W x 9.25"H | Ext. 6.5"



45887BK | Winslow
Black | Clear Seeded
(4), 75W, E26 (Medium)
30"W x 9.25"H | Ext. 6.5"



45885NBR | Winslow
Natural Brass | Clear Seeded
(2), 75W, E26 (Medium)
13"W x 9.25"H | Ext. 6.5"



45886NBR | Winslow
Natural Brass | Clear Seeded
(3), 75W, E26 (Medium)
21.5"W x 9.25"H | Ext. 6.5"



45887NBR | Winslow
Natural Brass | Clear Seeded
(4), 75W, E26 (Medium)
30"W x 9.25"H | Ext. 6.5"



45885NI | Winslow
Brushed Nickel | Clear Seeded
(2), 75W, E26 (Medium)
13"W x 9.25"H | Ext. 6.5"



45886NI | Winslow
Brushed Nickel | Clear Seeded
(3), 75W, E26 (Medium)
21.5"W x 9.25"H | Ext. 6.5"



45887NI | Winslow
Brushed Nickel | Clear Seeded
(4), 75W, E26 (Medium)
30"W x 9.25"H | Ext. 6.5"



45885OZ | Winslow
Olde Bronze® | Clear Seeded
(2), 75W, E26 (Medium)
13"W x 9.25"H | Ext. 6.5"



45886OZ | Winslow
Olde Bronze® | Clear Seeded
(3), 75W, E26 (Medium)
21.5"W x 9.25"H | Ext. 6.5"



45887OZ | Winslow
Olde Bronze® | Clear Seeded
(4), 75W, E26 (Medium)
30"W x 9.25"H | Ext. 6.5"



Bath & Vanity



55125BK | Erma
 Black | Clear Satin Etched
 (2) 60W, E26 (Medium)
 13.5"W x 8.5"H | Ext. 6"
 D ↕ ⚡



55126BK | Erma
 Black | Clear Satin Etched
 (3) 60W, E26 (Medium)
 23"W x 8.5"H | Ext. 6"
 D ↕ ⚡



55127BK | Erma
 Black | Clear Satin Etched
 (4) 60W, E26 (Medium)
 32.5"W x 8.5"H | Ext. 6"
 D ↕ ⚡



55125NI | Erma
 Brushed Nickel | Clear Satin Etched
 (2) 60W, E26 (Medium)
 13.5"W x 8.5"H | Ext. 6"
 D ↕ ⚡



55126NI | Erma
 Brushed Nickel | Clear Satin Etched
 (3) 60W, E26 (Medium)
 23"W x 8.5"H | Ext. 6"
 D ↕ ⚡



55127NI | Erma
 Brushed Nickel | Clear Satin Etched
 (4) 60W, E26 (Medium)
 32.5"W x 8.5"H | Ext. 6"
 D ↕ ⚡



55125OZ | Erma
 Olde Bronze® | Clear Satin Etched
 (2) 60W, E26 (Medium)
 13.5"W x 8.5"H | Ext. 6"
 D ↕ ⚡



55126OZ | Erma
 Olde Bronze® | Clear Satin Etched
 (3) 60W, E26 (Medium)
 23"W x 8.5"H | Ext. 6"
 D ↕ ⚡



55127OZ | Erma
 Olde Bronze® | Clear Satin Etched
 (4) 60W, E26 (Medium)
 32.5"W x 8.5"H | Ext. 6"
 D ↕ ⚡

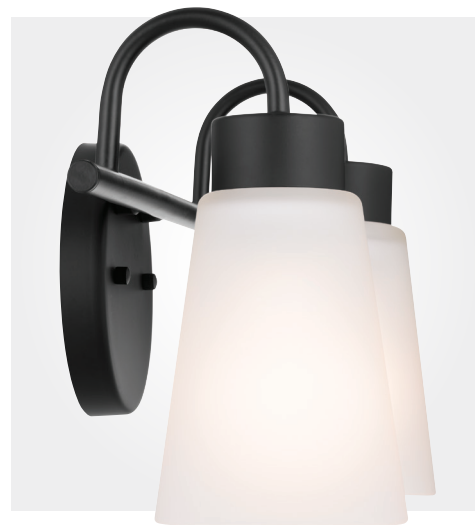



55120BK | Stamos
Black | Satin Etched
(2) 60W, E26 (Medium)
13"W x 8"H | Ext. 5"
D ↕ Ⓢ



55121BK | Stamos
Black | Satin Etched
(3) 60W, E26 (Medium)
22"W x 8"H | Ext. 5"
D ↕ Ⓢ



55122BK | Stamos
Black | Satin Etched
(4) 60W, E26 (Medium)
31"W x 8"H | Ext. 5"
D ↕ Ⓢ



55120NI | Stamos
Brushed Nickel | Satin Etched
(2) 60W, E26 (Medium)
13"W x 8"H | Ext. 5"
D ↕ Ⓢ



55121NI | Stamos
Brushed Nickel | Satin Etched
(3) 60W, E26 (Medium)
22"W x 8"H | Ext. 5"
D ↕ Ⓢ



55122NI | Stamos
Brushed Nickel | Satin Etched
(4) 60W, E26 (Medium)
31"W x 8"H | Ext. 5"
D ↕ Ⓢ



55120OZ | Stamos
Olde Bronze® | Satin Etched
(2) 60W, E26 (Medium)
13"W x 8"H | Ext. 5"
D ↕ Ⓢ



55121OZ | Stamos
Olde Bronze® | Satin Etched
(3) 60W, E26 (Medium)
22"W x 8"H | Ext. 5"
D ↕ Ⓢ



55122OZ | Stamos
Olde Bronze® | Satin Etched
(4) 60W, E26 (Medium)
31"W x 8"H | Ext. 5"
D ↕ Ⓢ



Bath & Vanity



45893NI | Harmony
Brushed Nickel | Clear
(2), 75W, E26 (Medium)
15.5"W x 8.25"H | Ext. 7.75"
D ↕ *



45894NI | Harmony
Brushed Nickel | Clear
(3), 75W, E26 (Medium)
24.5"W x 8.25"H | Ext. 7.5"
D ↕ *



45895NI | Harmony
Brushed Nickel | Clear
(4), 75W, E26 (Medium)
33.5"W x 8.25"H | Ext. 7.5"
D ↕ *



45893OZ | Harmony
Olde Bronze® | Clear
(2), 75W, E26 (Medium)
15.5"W x 8.25"H | Ext. 7.75"
D ↕ *



45894OZ | Harmony
Olde Bronze® | Clear
(3), 75W, E26 (Medium)
24.5"W x 8.25"H | Ext. 7.5"
D ↕ *



45895OZ | Harmony
Olde Bronze® | Clear
(4), 75W, E26 (Medium)
33.5"W x 8.25"H | Ext. 7.5"
D ↕ *





45972BK | Avery
Black | Clear Seeded
(2), 75W, E26 (Medium)
14.75"W x 9.25"H | Ext. 8"



45973BK | Avery
Black | Clear Seeded
(3), 75W, E26 (Medium)
24"W x 9.25"H | Ext. 8"



45974BK | Avery
Black | Clear Seeded
(4), 75W, E26 (Medium)
33.25"W x 9.25"H | Ext. 8"



45972NI | Avery
Brushed Nickel | Clear Seeded
(2), 75W, E26 (Medium)
14.75"W x 9.25"H | Ext. 8"



45973NI | Avery
Brushed Nickel | Clear Seeded
(3), 75W, E26 (Medium)
24"W x 9.25"H | Ext. 8"



45974NI | Avery
Brushed Nickel | Clear Seeded
(4), 75W, E26 (Medium)
33.25"W x 9.25"H | Ext. 8"



45972OZ | Avery
Olde Bronze® | Clear Seeded
(2), 75W, E26 (Medium)
14.75"W x 9.25"H | Ext. 8"



45973OZ | Avery
Olde Bronze® | Clear Seeded
(3), 75W, E26 (Medium)
24"W x 9.25"H | Ext. 8"



45974OZ | Avery
Olde Bronze® | Clear Seeded
(4), 75W, E26 (Medium)
33.25"W x 9.25"H | Ext. 8"



45972NBR | Avery
Natural Brass | Clear Seeded
(2), 75W, E26 (Medium)
14.75"W x 9.25"H | Ext. 8"



45973NBR | Avery
Natural Brass | Clear Seeded
(3), 75W, E26 (Medium)
24"W x 9.25"H | Ext. 8"



45974NBR | Avery
Natural Brass | Clear Seeded
(4), 75W, E26 (Medium)
33.25"W x 9.25"H | Ext. 8"



Bath & Vanity



45128BK | Valserrano™
 Black | Satin Etched
 (2), 75W, E26 (Medium)
 14.5"W x 10.25"H | Ext. 6.75"
 D ↕ *



45129BK | Valserrano™
 Black | Satin Etched
 (3), 75W, E26 (Medium)
 24"W x 10.25"H | Ext. 6.75"
 D ↕ *



45130BK | Valserrano™
 Black | Satin Etched
 (4), 75W, E26 (Medium)
 33.5"W x 10.25"H | Ext. 6.75"
 D ↕ *



45128NI | Valserrano™
 Brushed Nickel | Satin Etched
 (2), 75W, E26 (Medium)
 14.5"W x 10.25"H | Ext. 6.75"
 D ↕ *



45129NI | Valserrano™
 Brushed Nickel | Satin Etched
 (3), 75W, E26 (Medium)
 24"W x 10.25"H | Ext. 6.75"
 D ↕ *



45130NI | Valserrano™
 Brushed Nickel | Satin Etched
 (4), 75W, E26 (Medium)
 33.5"W x 10.25"H | Ext. 6.75"
 D ↕ *



45128BKCS | Valserrano™
 Black | Clear Seeded
 (2), 75W, E26 (Medium)
 14.5"W x 10.25"H | Ext. 6.75"
 D ↕ *



45129BKCS | Valserrano™
 Black | Clear Seeded
 (3), 75W, E26 (Medium)
 24"W x 10.25"H | Ext. 6.75"
 D ↕ *



45130BKCS | Valserrano™
 Black | Clear Seeded
 (4), 75W, E26 (Medium)
 33.5"W x 10.25"H | Ext. 6.75"
 D ↕ *



45128NICS | Valserrano™
 Brushed Nickel | Clear Seeded
 (2), 75W, E26 (Medium)
 14.5"W x 10.25"H | Ext. 6.75"
 D ↕ *



45129NICS | Valserrano™
 Brushed Nickel | Clear Seeded
 (3), 75W, E26 (Medium)
 24"W x 10.25"H | Ext. 6.75"
 D ↕ *



45130NICS | Valserrano™
 Brushed Nickel | Clear Seeded
 (4), 75W, E26 (Medium)
 33.5"W x 10.25"H | Ext. 6.75"
 D ↕ *



6322NI | Dover™
 Brushed Nickel | Etched Seeded
 (2), 100W, E26 (Medium)
 14.25"W x 8.75"H | Ext. 8"
 D D



6323NI | Dover™
 Brushed Nickel | Etched Seeded
 (3), 100W, E26 (Medium)
 22.5"W x 7.75"H | Ext. 8"
 D D



6324NI | Dover™
 Brushed Nickel | Etched Seeded
 (4), 100W, E26 (Medium)
 30.5"W x 8.75"H | Ext. 8"
 D D



45882NI | Nicholson™
 Brushed Nickel | Satin Etched
 (2), 100W, E26 (Medium)
 16"W x 10"H | Ext. 8.5"
 D D



45883NI | Nicholson™
 Brushed Nickel | Satin Etched
 (3), 100W, E26 (Medium)
 24"W x 10"H | Ext. 8.5"
 D D



45884NI | Nicholson™
 Brushed Nickel | Satin Etched
 (4), 100W, E26 (Medium)
 33"W x 10"H | Ext. 8.5"
 D D



Bath & Vanity



6122CH
 Chrome | Cased Opal
 (2), 100W, E26 (Medium)
 13.5"W x 8.5"H | Ext. 6.75"



6123CH
 Chrome | Cased Opal
 (3), 100W, E26 (Medium)
 18"W x 8.75"H | Ext. 9.25"



6124CH
 Chrome | Cased Opal
 (4), 100W, E26 (Medium)
 25.5"W x 8.5"H | Ext. 10.25"



6122NI
 Brushed Nickel | Cased Opal
 (2), 100W, E26 (Medium)
 13.5"W x 8.5"H | Ext. 6.75"



6123NI
 Brushed Nickel | Cased Opal
 (3), 100W, E26 (Medium)
 18"W x 8.75"H | Ext. 9.25"



6124NI
 Brushed Nickel | Cased Opal
 (4), 100W, E26 (Medium)
 25.5"W x 8.5"H | Ext. 10.25"



5336CHS
 Chrome | Satin Etched
 (2), 100W, E26 (Medium)
 12.25"W x 8"H | Ext. 8"



5337CHS
 Chrome | Satin Etched
 (3), 100W, E26 (Medium)
 24"W x 8"H | Ext. 8"



5336NIS
 Brushed Nickel | Satin Etched
 (2), 100W, E26 (Medium)
 12.25"W x 8"H | Ext. 8"



5337NIS
 Brushed Nickel | Satin Etched
 (3), 100W, E26 (Medium)
 24"W x 8"H | Ext. 8"



5336Tzs
 Tannery Bronze | Satin Etched
 (2), 100W, E26 (Medium)
 12.25"W x 8"H | Ext. 8"



5337Tzs
 Tannery Bronze | Satin Etched
 (3), 100W, E26 (Medium)
 24"W x 8"H | Ext. 8"





5338CHS
 Chrome | Satin Etched
 (4), 100W, E26 (Medium)
 30"W x 8"H | Ext. 8"
 D ↕ ⚡



5339CHS
 Chrome | Satin Etched
 (5), 100W, E26 (Medium)
 36"W x 8"H | Ext. 8"
 D ↕ ⚡



5338NIS
 Brushed Nickel | Satin Etched
 (4), 100W, E26 (Medium)
 30"W x 8"H | Ext. 8"
 D ↕ ⚡



5339NIS
 Brushed Nickel | Satin Etched
 (5), 100W, E26 (Medium)
 36"W x 8"H | Ext. 8"
 D ↕ ⚡



5338TZS
 Tannery Bronze | Satin Etched
 (4), 100W, E26 (Medium)
 30"W x 8"H | Ext. 8"
 D ↕ ⚡



5339TZS
 Tannery Bronze | Satin Etched
 (5), 100W, E26 (Medium)
 36"W x 8"H | Ext. 8"
 D ↕ ⚡



Bath & Vanity



5003CH
Chrome
(3), 60W, E26 (Medium)
18"W x 4.75"H | Ext. 5.5" (if w/ G25 bulb)
⊕ ⊕ ⊕



5017CH
Chrome
(4), 60W, E26 (Medium)
24"W x 4.75"H | Ext. 5.5" (if w/ G25 bulb)
ⓓ ⊕ ⊕ ⊕



5018CH
Chrome
(6), 60W, E26 (Medium)
36"W x 4.75"H | Ext. 5.5" (if w/ G25 bulb)
ⓓ ⊕ ⊕ ⊕



5019CH
Chrome
(8), 60W, E26 (Medium)
48"W x 4.75"H | Ext. 5.5" (if w/ G25 bulb)
ⓓ ⊕ ⊕ ⊕



5003NI
Brushed Nickel
(3), 60W, E26 (Medium)
18"W x 4.75"H | Ext. 5.5" (if w/ G25 bulb)
⊕ ⊕ ⊕



5017NI
Brushed Nickel
(4), 60W, E26 (Medium)
24"W x 4.75"H | Ext. 5.5" (if w/ G25 bulb)
ⓓ ⊕ ⊕ ⊕





5018NI
Brushed Nickel
(6), 60W, E26 (Medium)
36"W x 4.75"H | Ext. 5.5" (if w/ G25 bulb)
ⓓ ⊕ ⊕ ⊕





5019NI
Brushed Nickel
(8), 60W, E26 (Medium)
48"W x 4.75"H | Ext. 5.5" (if w/ G25 bulb)
ⓓ ⊕ ⊕ ⊕





623CH
 Chrome
 (3), 60W, E26 (Medium)
 18"W x 4.25"H | Ext. 5.5" (if w/ G25 bulb)
 





624CH
 Chrome
 (4), 60W, E26 (Medium)
 24"W x 4.25"H | Ext. 5.5" (if w/ G25 bulb)
 





625CH
 Chrome
 (5), 60W, E26 (Medium)
 30"W x 4.25"H | Ext. 5.5" (if w/ G25 bulb)
 



626CH
 Chrome
 (6), 60W, E26 (Medium)
 36"W x 4.25"H | Ext. 5.5" (if w/ G25 bulb)
 



628CH
 Chrome
 (8), 60W, E26 (Medium)
 48"W x 4.25"H | Ext. 5.5" (if w/ G25 bulb)
 



623NI
 Brushed Nickel
 (3), 60W, E26 (Medium)
 18"W x 4.25"H | Ext. 5.5" (if w/ G25 bulb)
 



624NI
 Brushed Nickel
 (4), 60W, E26 (Medium)
 24"W x 4.25"H | Ext. 5.5" (if w/ G25 bulb)
 



625NI
 Brushed Nickel
 (5), 60W, E26 (Medium)
 30"W x 4.25"H | Ext. 5.5" (if w/ G25 bulb)
 



626NI
 Brushed Nickel
 (6), 60W, E26 (Medium)
 36"W x 4.25"H | Ext. 5.5" (if w/ G25 bulb)
 



628NI
 Brushed Nickel
 (8), 60W, E26 (Medium)
 48"W x 4.25"H | Ext. 5.5" (if w/ G25 bulb)
 

LED Mirrors



83993
3000K, 80 CRI
19.75"W x 35.5"H | Ext. 2"
D + LED

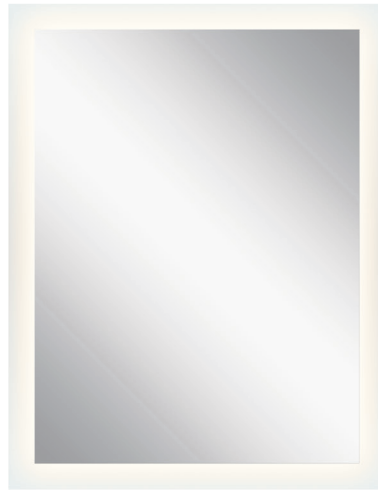

83992
(4), 3000K, 80 CRI
27"W x 42"H | Ext. 3"
D + I + LED



84003
(4), 3000K, 80 CRI
42"H x 54"W | Ext. 3"
D + I + LED



83997
3000K, 80 CRI
27"H x 39"W | Ext. 1"
D + I + LED



83998
3000K, 80 CRI
25"H x 39"W | Ext. 1"
D + I + LED

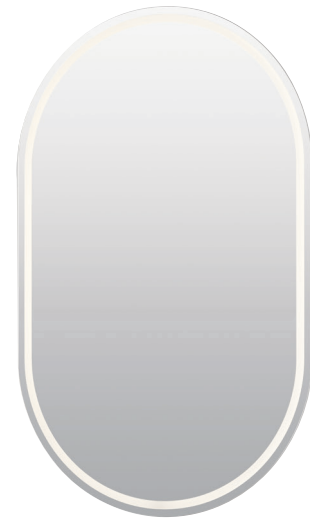

86008
3000K, 90 CRI
24"H x 40"W | Ext. 1"
D + I + LED ✓



For additional mirror style and finish options, visit [Kichler.com](https://www.kichler.com).

D Damp + Mounts Horizontal Or Vertical I Must be supported independently of the outlet box

94 * Dimmable LED Integrated LED ✓ Requires supply wire rated for 75°C



LED Mirrors



83994
3000K, 80 CRI
24"W x 30"H | Ext. 2"
D + LED



83995
3000K, 80 CRI
32"W x 40"H | Ext. 2"
D + LED

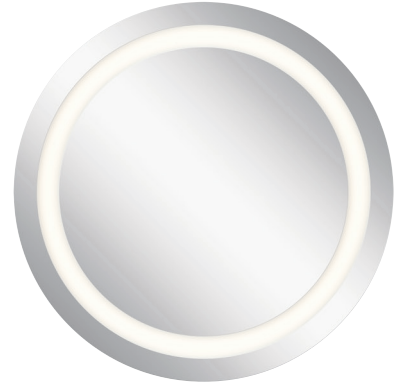

83996
3000K, 80 CRI
33.5"Dia. | Ext. 2"
D + LED



84173
3000K, 90 CRI
20"W x 59"H | Ext. 1"
D + LED



84168
3000K, 90 CRI
23.5"W x 31.5"H | Ext. 1"
D + LED



84167
3000K, 90 CRI
23.5"W x 31.5"H | Ext. 1"
D + LED

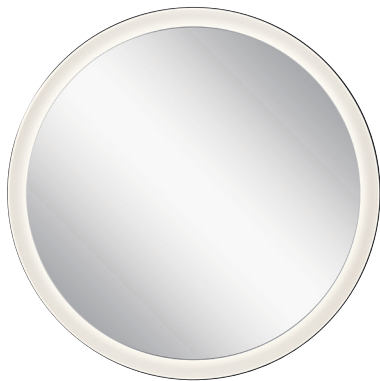

84169
3000K, 90 CRI
31.5"Dia. | Ext. 2"
D + LED



84171
3000K, 90 CRI
30"W x 60"H | Ext. 2"
D + LED

Mirrors



41011NI
24"W x 30"H | Ext. 1.5"
+



41011BK
24"W x 30"H | Ext. 1.5"
+



41011OZ
24"W x 30"H | Ext. 1.5"
+



41011CH
24"W x 30"H | Ext. 1.5"
+



41011CPZ
24"W x 30"H | Ext. 1.5"
+



LED Pendants



83454 | Fornello
Textured White
(1), 38W, 950lm, 4000K, 80 CRI, 25 LPW
23.5"W x 2.75"H
Overall Ht. 112.92"
Ⓣ24 Ⓝ LED



83455 | Fornello
Textured Black
(1), 38W, 950lm, 4000K, 80 CRI, 25 LPW
23.5"W x 2.75"H
Overall Ht. 112.92"
Ⓣ24 Ⓝ LED



83261 | Fornello
Brushed Nickel
(1), 38W, 950lm, 4000K, 80 CRI, 25 LPW
23.5"W x 2.75"H
Overall Ht. 112.92"
Ⓣ24 Ⓝ LED



83791 | Rendo
Chrome | Smoke Glass
(1), 5W, 200lm, 3000K, 90 CRI, 40 LPW
12"W x 12.25"H
Overall Ht. 120.5"
Ⓣ24 Ⓝ LED



11301NILED
Brushed Nickel
(1), 10W, 500lm, 3000K, 90 CRI, 63 LPW
7"W x 7.25"H | Stem Tilt 90°
Overall Ht. 45" | Chain/Stem 36" **
Ⓣ24 Ⓝ LED



11314NILED
Brushed Nickel
(1), 10W, 375lm, 3000K, 90 CRI, 47 LPW
6"W x 9"H | Stem Tilt 90°
Overall Ht. 47" | Chain/Stem 36" **
Ⓣ24 Ⓝ LED



11305NILED
Brushed Nickel
Satin Etched Cased Opal
(1), 10W, 450lm, 3000K, 90 CRI, 56 LPW
4.5"W x 9.25"H | Stem Tilt 90°
Overall Ht. 47" | Chain/Stem 36" **
Ⓣ24 Ⓝ LED



Add an efficient light source to any reception desk, restaurant bar, or kitchen island with integrated LED Pendants

Offering excellent light output, these seemingly simple styles each offer a subtle design element – making them both unique and universally appealing



43927NI | Joelson™
 Brushed Nickel
 Satin Etched Cased Opal
 (1), 100W, E26 (Medium)
 4"W x 19"H | Stem Tilt 90°
 Overall Ht. 57"
 Chain/Stem 36", Add'l Stem 4935

43927NIL18
 (1), 10W, 800lm, E26, 3000K
 92 CRI, 80 LPW



43927OZ | Joelson™
 Olde Bronze® | Satin Etched Cased Opal
 (1), 100W, E26 (Medium)
 4"W x 19"H | Stem Tilt 90°
 Overall Ht. 57"
 Chain/Stem 36", Add'l Stem 4935

43927OZL18
 (1), 10W, 800lm, E26, 3000K
 92 CRI, 80 LPW



43668NI | Aubrey™
 Brushed Nickel
 Satin Etched Cased Opal
 (1), 100W, E26 (Medium)
 4.75"W x 12.75"H
 Overall Ht. 51" | Chain/Stem 36" *

43668NIL18
 (1), 10W, 800lm, E26, 3000K
 92 CRI, 80 LPW



43668OZ | Aubrey™
 Olde Bronze® | Satin Etched Cased Opal
 (1), 100W, E26 (Medium)
 4.75"W x 12.75"H
 Overall Ht. 51" | Chain/Stem 36" *

43668OZL18
 (1), 10W, 800lm, E26, 3000K
 92 CRI, 80 LPW



43640NI | Jolie
 Brushed Nickel | Satin Etched
 (1), 100W, E26 (Medium)
 4.75"W x 6.75"H
 Overall Ht. 51" | Chain/Stem 36" *

43640NIL18
 (1), 10W, 800lm, E26, 3000K
 92 CRI, 80 LPW



43640OZ | Jolie
 Olde Bronze® | Satin Etched
 (1), 100W, E26 (Medium)
 4.75"W x 6.75"H
 Overall Ht. 51" | Chain/Stem 36" *

43640OZL18
 (1), 10W, 800lm, E26, 3000K
 92 CRI, 80 LPW



For fixtures with LED, Title 24 Rated light bulbs included, look for "L18" in the model number.



Pendants



42588NI | Holbrook
Brushed Nickel | Clear Seeded
(2), 60W, E12 (Candelabra)
10"W x 12"H
Overall Ht. 50" | Chain/Stem 36" *
⊗



42588OZ | Holbrook
Olde Bronze® | Clear Seeded
(2), 60W, E12 (Candelabra)
10"W x 12"H
Overall Ht. 50" | Chain/Stem 36" *
⊗



43905BK | Avery
Black | Clear Seeded
(1), 40W, E26 (Medium)
14"Dia. x 11.75"H
Overall Ht. 50.5" | On/Off Turn Switch
⊗



43906BK | Avery
Black | Clear Seeded
(1), 40W, E26 (Medium)
14.5"Dia. x 11.25"H
Overall Ht. 50" | On/Off Turn Switch
⊗



43911BK | Avery
Black | Clear Seeded
(1), 40W, E26 (Medium)
14.5"Dia. x 14"H
Overall Ht. 52.75" | On/Off Turn Switch
⊗



43912BK | Avery
Black | Clear Seeded
(1), 40W, E26 (Medium)
14"Dia. x 11"H
Overall Ht. 49.75" | On/Off Turn Switch
⊗



43850BK | Avery
Black | Clear Seeded
(1), 40W, E26 (Medium)
8"W x 8.5"H
Overall Ht. 125" | On/Off Turn Switch
⊗



43851BK | Avery
Black | Clear Seeded
(1), 40W, E26 (Medium)
8.25"W x 8.75"H
Overall Ht. 125" | On/Off Turn Switch
⊗



43853BK | Avery
Black | Clear Seeded
(1), 40W, E26 (Medium)
10"W x 9.25"H
Overall Ht. 125" | On/Off Turn Switch
⊗



43852BK | Avery
Black | Clear Seeded
(1), 40W, E26 (Medium)
9.75"W x 11.25"H
Overall Ht. 128" | On/Off Turn Switch
⊗



43905NI | Avery
Brushed Nickel | Clear Seeded
(1), 40W, E26 (Medium)
14"Dia. x 11.75"H
Overall Ht. 50.5" | On/Off Turn Switch
⊗



43906NI | Avery
Brushed Nickel | Clear Seeded
(1), 40W, E26 (Medium)
14.5"Dia. x 11.25"H
Overall Ht. 50" | On/Off Turn Switch
⊗



43911NI | Avery
Brushed Nickel | Clear Seeded
(1), 40W, E26 (Medium)
14.5"Dia. x 14"H
Overall Ht. 52.75" | On/Off Turn Switch



43912NI | Avery
Brushed Nickel | Clear Seeded
(1), 40W, E26 (Medium)
14"Dia. x 11"H
Overall Ht. 49.75" | On/Off Turn Switch



43850NI | Avery
Brushed Nickel | Clear Seeded
(1), 40W, E26 (Medium)
8"W x 8.5"H
Overall Ht. 125" | On/Off Turn Switch



43851NI | Avery
Brushed Nickel | Clear Seeded
(1), 40W, E26 (Medium)
8.25"W x 8.75"H
Overall Ht. 125" | On/Off Turn Switch



43853NI | Avery
Brushed Nickel | Clear Seeded
(1), 40W, E26 (Medium)
10"W x 9.25"H
Overall Ht. 125" | On/Off Turn Switch



43852NI | Avery
Brushed Nickel | Clear Seeded
(1), 40W, E26 (Medium)
9.75"W x 11.25"H
Overall Ht. 128" | On/Off Turn Switch



43905NBR | Avery
Natural Brass | Clear Seeded
(1), 40W, E26 (Medium)
14"Dia. x 11.75"H
Overall Ht. 50.5" | On/Off Turn Switch



43906NBR | Avery
Natural Brass | Clear Seeded
(1), 40W, E26 (Medium)
14.5"Dia. x 11.25"H
Overall Ht. 50" | On/Off Turn Switch



43911NBR | Avery
Natural Brass | Clear Seeded
(1), 40W, E26 (Medium)
14.5"Dia. x 14"H
Overall Ht. 52.75" | On/Off Turn Switch



43912NBR | Avery
Natural Brass | Clear Seeded
(1), 40W, E26 (Medium)
14"Dia. x 11"H
Overall Ht. 49.75" | On/Off Turn Switch



43850NBR | Avery
Natural Brass | Clear Seeded
(1), 40W, E26 (Medium)
8"W x 8.5"H
Overall Ht. 125" | On/Off Turn Switch



43851NBR | Avery
Natural Brass | Clear Seeded
(1), 40W, E26 (Medium)
8.25"W x 8.75"H
Overall Ht. 125" | On/Off Turn Switch

Pendants



43853NBR | Avery
Natural Brass | Clear Seeded
(1), 40W, E26 (Medium)
10"W x 9.25"H
Overall Ht. 125" | On/Off Turn Switch
⊗



43852NBR | Avery
Natural Brass | Clear Seeded
(1), 40W, E26 (Medium)
9.75"W x 11.25"H
Overall Ht. 128" | On/Off Turn Switch
⊗



43905OZ | Avery
Olde Bronze® | Clear Seeded
(1), 40W, E26 (Medium)
14"Dia. x 11.75"H
Overall Ht. 50.5" | On/Off Turn Switch
⊗



43906OZ | Avery
Olde Bronze® | Clear Seeded
(1), 40W, E26 (Medium)
14.5"Dia. x 11.25"H
Overall Ht. 50" | On/Off Turn Switch
⊗



43911OZ | Avery
Olde Bronze® | Clear Seeded
(1), 40W, E26 (Medium)
14.5"Dia. x 14"H
Overall Ht. 52.75" | On/Off Turn Switch
⊗



43912OZ | Avery
Olde Bronze® | Clear Seeded
(1), 40W, E26 (Medium)
14"Dia. x 11"H
Overall Ht. 49.75" | On/Off Turn Switch
⊗



43850OZ | Avery
Olde Bronze® | Clear Seeded
(1), 40W, E26 (Medium)
8"W x 8.5"H
Overall Ht. 125" | On/Off Turn Switch
⊗



43851OZ | Avery
Olde Bronze® | Clear Seeded
(1), 40W, E26 (Medium)
8.25"W x 8.75"H
Overall Ht. 125" | On/Off Turn Switch
⊗



43853OZ | Avery
Olde Bronze® | Clear Seeded
(1), 40W, E26 (Medium)
10"W x 9.25"H
Overall Ht. 125" | On/Off Turn Switch
⊗



43852OZ | Avery
Olde Bronze® | Clear Seeded
(1), 40W, E26 (Medium)
9.75"W x 11.25"H
Overall Ht. 128" | On/Off Turn Switch
⊗



43850CH | Avery
Chrome | Clear Seeded
(1), 40W, E26 (Medium)
8"W x 8.5"H
Overall Ht. 125" | On/Off Turn Switch
⊗



43853CH | Avery
Chrome | Clear Seeded
(1), 40W, E26 (Medium)
10"W x 9.25"H
Overall Ht. 125" | On/Off Turn Switch
⊗



42878NI | Brinley™
Brushed Nickel | Clear
(1), 100W, E26 (Medium)
4.75"W x 7.75"H
Overall Ht. 113"



42878OZ | Brinley™
Olde Bronze® | Clear
(1), 100W, E26 (Medium)
4.75"W x 7.75"H
Overall Ht. 113"



2664OZ | Hatteras Bay
Olde Bronze®
(1), 100W, E26 (Medium)
8"W x 10.25"H
Overall Ht. 49" | Chain/Stem 36" *



2664PN | Hatteras Bay
Polished Nickel
(1), 100W, E26 (Medium)
8"W x 10.25"H
Overall Ht. 49" | Chain/Stem 36" *



43597BK | Piston™
Black
(1), 75W, E26 (Medium)
8"W x 11.25"H
Overall Ht. 49" | Chain/Stem 36" *



44045AUB | Marimount™
Auburn Stained Finish | Clear
(1), 60W, E12 (Candelabra)
10.5"W (3.86"W glass) x 14.75"H
Overall Ht. 53" | Chain/Stem 36"



42798NI
Brushed Nickel | Clear
(1), 75W, E26 (Medium)
9.5"W x 10.75"H | Stem Tilt 90°
Overall Ht. 49" | Chain/Stem 36" **



Mini Pendants



42565BK | Larkin™
Black
(2), 60W, E12 (Candelabra)
8"W x 14.75"H x 11.25"L
Overall Ht. 63" | Chain/Stem 36" [^]



42565NI | Larkin™
Brushed Nickel
(2), 60W, E12 (Candelabra)
8"W x 14.75"H x 11.25"L
Overall Ht. 63" | Chain/Stem 36" [^]



42565OZ | Larkin™
Olde Bronze®
(2), 60W, E12 (Candelabra)
8"W x 14.75"H x 11.25"L
Overall Ht. 63" | Chain/Stem 36" [^]



43996BK | Crosby
Black | Clear
(1), 100W, E26 (Medium)
6"W x 10.75"H | Stem Tilt 90°
Overall Ht. 49" | Chain/Stem 36" ^{**}



43996NBR | Crosby
Natural Brass | Clear
(1), 100W, E26 (Medium)
6"W x 10.75"H | Stem Tilt 90°
Overall Ht. 49" | Chain/Stem 36" ^{**}



43996NI | Crosby
Brushed Nickel | Clear
(1), 100W, E26 (Medium)
6"W x 10.75"H | Stem Tilt 90°
Overall Ht. 49" | Chain/Stem 36" ^{**}



43996CH | Crosby
Chrome | Clear
(1), 100W, E26 (Medium)
6"W x 10.75"H | Stem Tilt 90°
Overall Ht. 49" | Chain/Stem 36" ^{**}



43996OZ | Crosby
Olde Bronze® | Clear
(1), 100W, E26 (Medium)
6"W x 10.75"H | Stem Tilt 90°
Overall Ht. 49" | Chain/Stem 36" ^{**}



52725BK | Madden
Black | Clear
(1) 75W, E26 (Medium)
7"Dia. x 15"H
Overall Ht. 55.25", Stem 36"



52725CPZ | Madden
Champagne Bronze™ | Clear
(1) 75W, E26 (Medium)
7"Dia. x 15"H
Overall Ht. 55.25", Stem 36"



52725NI | Madden
Brushed Nickel | Clear
(1) 75W, E26 (Medium)
7"Dia. x 15"H
Overall Ht. 55.25", Stem 36"



52725CH | Madden
Chrome | Clear
(1) 75W, E26 (Medium)
7"Dia. x 15"H
Overall Ht. 55.25", Stem 36"



44032BK | Winslow
Black | Clear Seeded
(1), 75W, E26 (Medium)
4.25"W x 7.5"H | Stem Tilt 90°
Overall Ht. 45" | Chain/Stem 36" **



44032NBR | Winslow
Natural Brass | Clear Seeded
(1), 75W, E26 (Medium)
4.25"W x 7.5"H | Stem Tilt 90°
Overall Ht. 45" | Chain/Stem 36" **



44032NI | Winslow
Brushed Nickel | Clear Seeded
(1), 75W, E26 (Medium)
4.25"W x 7.5"H | Stem Tilt 90°
Overall Ht. 45" | Chain/Stem 36" **



44032OZ | Winslow
Olde Bronze® | Clear Seeded
(1), 75W, E26 (Medium)
4.25"W x 7.5"H | Stem Tilt 90°
Overall Ht. 45" | Chain/Stem 36" **



44380BK | Valserrano™
Black | Satin Etched
(1), 75W, E26 (Medium)
5"W x 7.75"H
Overall Ht. 46" | Chain/Stem 36" **



44380NI | Valserrano™
Brushed Nickel | Satin Etched
(1), 75W, E26 (Medium)
5"W x 7.75"H
Overall Ht. 46" | Chain/Stem 36" **



44380BKCS | Valserrano™
Black | Satin Etched
(1), 75W, E26 (Medium)
5"W x 7.75"H
Overall Ht. 46" | Chain/Stem 36" **



44380NICS | Valserrano™
Brushed Nickel | Satin Etched
(1), 75W, E26 (Medium)
5"W x 7.75"H
Overall Ht. 46" | Chain/Stem 36" **



3497NI | Eileen™
Brushed Nickel
Satin Etched Cased Opal
(1), 100W, E26 (Medium)
4.5"W x 8"H
Overall Ht. 46" | Chain/Stem 36" * *



44053NI | Tao
Brushed Nickel
Satin Etched Cased Opal
(1), 75W, E26 (Medium)
4.75"W x 7.25"H | Stem Tilt 90°
Overall Ht. 45" | Chain/Stem 36" ** *



Mini Pendants



43674BKCS | Shailene™
Black | Clear
(1), 100W, E26 (Medium)
4.5"W x 11"H
Overall Ht. 49" | Chain/Stem 36" *
⊗



43674NBRC | Shailene™
Brushed Nickel | Clear
(1), 100W, E26 (Medium)
4.5"W x 11"H
Overall Ht. 49" | Chain/Stem 36" *
⊗



43674NICS | Shailene™
Brushed Nickel | Clear
(1), 100W, E26 (Medium)
4.5"W x 11"H
Overall Ht. 49" | Chain/Stem 36" *
⊗



43674OZCS | Shailene™
Olde Bronze® | Clear
(1), 100W, E26 (Medium)
4.5"W x 11"H
Overall Ht. 49" | Chain/Stem 36" *
⊗



43674BK | Shailene™
Black | Satin Etched
(1), 100W, E26 (Medium)
4.5"W x 11"H
Overall Ht. 49" | Chain/Stem 36" *
⊗



43674NBR | Shailene™
Brushed Nickel | Satin Etched
(1), 100W, E26 (Medium)
4.5"W x 11"H
Overall Ht. 49" | Chain/Stem 36" *
⊗



43674NI | Shailene™
Brushed Nickel | Satin Etched
(1), 100W, E26 (Medium)
4.5"W x 11"H
Overall Ht. 49" | Chain/Stem 36" *
⊗



43674OZ | Shailene™
Olde Bronze® | Satin Etched
(1), 100W, E26 (Medium)
4.5"W x 11"H
Overall Ht. 49" | Chain/Stem 36" *
⊗



52444BK | Erma™
Black | Satin Etched
(1) 60W, E26 (Medium), 7.5"H x 4"Dia.
Overall Ht. 79.5", Chain/Stem 36"
⊗



52444NI | Erma™
Brushed Nickel | Satin Etched
(1) 60W, E26 (Medium), 7.5"H x 4"Dia.
Overall Ht. 79.5", Chain/Stem 36"
⊗



52444OZ | Erma™
Olde Bronze® | Satin Etched
(1) 60W, E26 (Medium), 7.5"H x 4"Dia.
Overall Ht. 79.5", Chain/Stem 36"
⊗



42880NI | Nicholson™
 Brushed Nickel | Satin Etched
 (1), 100W, E26 (Medium)
 6"W x 8"H
 Overall Ht. 46" | Chain/Stem 36" ^



2771NI | Dover™
 Brushed Nickel | Etched Seeded
 (1), 100W, E26 (Medium)
 6.25"W x 5.5"H
 Overall Ht. 46" | Chain/Stem 36" *



2771TZ | Dover™
 Tannery Bronze | Etched Seeded
 (1), 100W, E26 (Medium)
 6.25"W x 5.5"H
 Overall Ht. 46" | Chain/Stem 36" *



2693NI | Wynberg™
 Brushed Nickel | Satin Etched
 (1), 100W, E26 (Medium)
 6"W x 6.25"H | Stem Tilt 90°
 Overall Ht. 44" | Chain/Stem 36" **



2693OZ | Wynberg™
 Olde Bronze® | Satin Etched
 (1), 100W, E26 (Medium)
 6"W x 6.25"H | Stem Tilt 90°
 Overall Ht. 44" | Chain/Stem 36" **



43953NI | Riviera™
 Brushed Nickel | Clear Ribbed
 (1), 100W, E26 (Medium)
 9"W x 16"H
 Overall Ht. 46" | Chain/Stem 36" *



43953OZ | Riviera™
 Olde Bronze® | Clear Ribbed
 (1), 100W, E26 (Medium)
 9"W x 16"H
 Overall Ht. 46" | Chain/Stem 36" *



43954NI | Riviera™
 Brushed Nickel | Clear Ribbed
 (1), 100W, E26 (Medium)
 7.75"W x 13.75"H
 Overall Ht. 52" | Chain/Stem 36" *



43954OZ | Riviera™
 Olde Bronze® | Clear Ribbed
 (1), 100W, E26 (Medium)
 7.75"W x 13.75"H
 Overall Ht. 52" | Chain/Stem 36" *



43955NI | Riviera™
 Brushed Nickel | Clear Ribbed
 (1), 100W, E26 (Medium)
 11.5"W x 12.5"H
 Overall Ht. 51" | Chain/Stem 36" *



43955OZ | Riviera™
 Olde Bronze® | Clear Ribbed
 (1), 100W, E26 (Medium)
 11.5"W x 12.5"H
 Overall Ht. 51" | Chain/Stem 36" *

Pendants



42200BKCS | Everly™
 Black | Clear Seeded
 (1), 100W, E26 (Medium)
 14.25"Dia. x 15.5"H | Stem Tilt 90°
 Overall Ht. 54.25" | Chain/Stem 36" **



42199BKCS | Everly™
 Black | Clear Seeded
 (1), 100W, E26 (Medium)
 10.25"Dia. x 15.25"H | Stem Tilt 90°
 Overall Ht. 54.25" | Chain/Stem 36" **



42456BKCS | Everly™
 Black | Clear Seeded
 (1), 100W, E26 (Medium)
 7"W x 13.75"H | Stem Tilt 90°
 Overall Ht. 52" | Chain/Stem 36" **





42141BKCS | Everly™
 Black | Clear Seeded
 (1), 100W, E26 (Medium)
 10.5"W x 15.25"H | Stem Tilt 90°
 Overall Ht. 54" | Chain/Stem 36" **





42200CHCS | Everly™
 Chrome | Clear Seeded
 (1), 100W, E26 (Medium)
 14.25"Dia. x 15.5"H | Stem Tilt 90°
 Overall Ht. 54.25" | Chain/Stem 36" **





42199CHCS | Everly™
 Chrome | Clear Seeded
 (1), 100W, E26 (Medium)
 10.25"Dia. x 15.25"H | Stem Tilt 90°
 Overall Ht. 54.25" | Chain/Stem 36" **





42456CHCS | Everly™
 Chrome | Clear Seeded
 (1), 100W, E26 (Medium)
 7"W x 13.75"H | Stem Tilt 90°
 Overall Ht. 52" | Chain/Stem 36" **





42141CHCS | Everly™
 Chrome | Clear Seeded
 (1), 100W, E26 (Medium)
 10.5"W x 15.25"H | Stem Tilt 90°
 Overall Ht. 54" | Chain/Stem 36" **





42200NBRCs | Everly™
 Natural Brass | Clear Seeded
 (1), 100W, E26 (Medium)
 14.25"Dia. x 15.5"H | Stem Tilt 90°
 Overall Ht. 54.25" | Chain/Stem 36" **





42199NBRCs | Everly™
 Natural Brass | Clear Seeded
 (1), 100W, E26 (Medium)
 10.25"Dia. x 15.25"H | Stem Tilt 90°
 Overall Ht. 54.25" | Chain/Stem 36" **



42456NBRCs | Everly™
 Natural Brass | Clear Seeded
 (1), 100W, E26 (Medium)
 7"W x 13.75"H | Stem Tilt 90°
 Overall Ht. 52" | Chain/Stem 36" **



42141NBRCs | Everly™
 Natural Brass | Clear Seeded
 (1), 100W, E26 (Medium)
 10.5"W x 15.25"H | Stem Tilt 90°
 Overall Ht. 54" | Chain/Stem 36" **



42200NICS | Everly™
 Brushed Nickel | Clear Seeded
 (1), 100W, E26 (Medium)
 14.25"Dia. x 15.5"H | Stem Tilt 90°
 Overall Ht. 54.25" | Chain/Stem 36" **



42199NICS | Everly™
 Brushed Nickel | Clear Seeded
 (1), 100W, E26 (Medium)
 10.25"Dia. x 15.25"H | Stem Tilt 90°
 Overall Ht. 54.25" | Chain/Stem 36" **



42456NICS | Everly™
 Brushed Nickel | Clear Seeded
 (1), 100W, E26 (Medium)
 7"W x 13.75"H | Stem Tilt 90°
 Overall Ht. 52" | Chain/Stem 36" **



42141NICS | Everly™
 Brushed Nickel | Clear Seeded
 (1), 100W, E26 (Medium)
 10.5"W x 15.25"H | Stem Tilt 90°
 Overall Ht. 54" | Chain/Stem 36" **



42200BK | Everly™
 Black | Clear
 (1), 100W, E26 (Medium)
 14.25"Dia. x 15.5"H | Stem Tilt 90°
 Overall Ht. 54.25" | Chain/Stem 36" **



42199BK | Everly™
 Black | Clear
 (1), 100W, E26 (Medium)
 10.25"Dia. x 15.25"H | Stem Tilt 90°
 Overall Ht. 54.25" | Chain/Stem 36" **



42141BK | Everly™
 Black | Clear
 (1), 100W, E26 (Medium)
 10.5"W x 15.25"H | Stem Tilt 90°
 Overall Ht. 54" | Chain/Stem 36" **



42200CH | Everly™
 Chrome | Clear
 (1), 100W, E26 (Medium)
 14.25"Dia. x 15.5"H | Stem Tilt 90°
 Overall Ht. 54.25" | Chain/Stem 36" **



Pendants



42199CH | Everly™
 Chrome | Clear
 (1), 100W, E26 (Medium)
 10.25"Dia. x 15.25"H | Stem Tilt 90°
 Overall Ht. 54.25" | Chain/Stem 36" **



42200NBR | Everly™
 Natural Brass | Clear
 (1), 100W, E26 (Medium)
 14.25"Dia. x 15.5"H | Stem Tilt 90°
 Overall Ht. 54.25" | Chain/Stem 36" **



42199NBR | Everly™
 Natural Brass | Clear
 (1), 100W, E26 (Medium)
 10.25"Dia. x 15.25"H | Stem Tilt 90°
 Overall Ht. 54.25" | Chain/Stem 36" **



42456NBR | Everly™
 Natural Brass | Clear
 (1), 100W, E26 (Medium)
 7"W x 13.75"H | Stem Tilt 90°
 Overall Ht. 52" | Chain/Stem 36" **



42141NBR | Everly™
 Natural Brass | Clear
 (1), 100W, E26 (Medium)
 10.5"W x 15.25"H | Stem Tilt 90°
 Overall Ht. 54" | Chain/Stem 36" **



42200OZ | Everly™
 Olde Bronze® | Clear
 (1), 100W, E26 (Medium)
 14.25"Dia. x 15.5"H | Stem Tilt 90°
 Overall Ht. 54.25" | Chain/Stem 36" **



42199OZ | Everly™
 Olde Bronze® | Clear
 (1), 100W, E26 (Medium)
 10.25"Dia. x 15.25"H | Stem Tilt 90°
 Overall Ht. 54.25" | Chain/Stem 36" **



42200NI | Everly™
 Brushed Nickel | Clear
 (1), 100W, E26 (Medium)
 14.25"Dia. x 15.5"H | Stem Tilt 90°
 Overall Ht. 54.25" | Chain/Stem 36" **



42199NI | Everly™
 Brushed Nickel | Clear
 (1), 100W, E26 (Medium)
 10.25"Dia. x 15.25"H | Stem Tilt 90°
 Overall Ht. 54.25" | Chain/Stem 36" **



42456NI | Everly™
 Brushed Nickel | Clear
 (1), 100W, E26 (Medium)
 7"W x 13.75"H | Stem Tilt 90°
 Overall Ht. 52" | Chain/Stem 36" **



42141NI | Everly™
 Brushed Nickel | Clear
 (1), 100W, E26 (Medium)
 10.5"W x 15.25"H | Stem Tilt 90°
 Overall Ht. 54" | Chain/Stem 36" **



42475CHCLR | Everly™
 Chrome | Clear
 (1), 100W, E26 (Medium)
 11"W x 29.5"H | Stem Tilt 90°
 Overall Ht. 68" | Chain/Stem 36" **





42456CHCLR | Everly™
 Chrome | Clear
 (1), 100W, E26 (Medium)
 7"W x 13.75"H | Stem Tilt 90°
 Overall Ht. 52" | Chain/Stem 36" **



42141CHCLR | Everly™
 Chrome | Clear
Also available in OZCLR
 (1), 100W, E26 (Medium)
 10.5"W x 15.25"H | Stem Tilt 90°
 Overall Ht. 54" | Chain/Stem 36" **



42456OZCLR | Everly™
 Olde Bronze® | Clear
 (1), 100W, E26 (Medium)
 7"W x 13.75"H | Stem Tilt 90°
 Overall Ht. 52" | Chain/Stem 36" **



42141OZCLR | Everly™
 Olde Bronze® | Clear
 (1), 100W, E26 (Medium)
 10.5"W x 15.25"H | Stem Tilt 90°
 Overall Ht. 54" | Chain/Stem 36" **



42200OZCS | Everly™
 Olde Bronze® | Clear Seeded
 (1), 100W, E26 (Medium)
 14.25"Dia. x 15.5"H | Stem Tilt 90°
 Overall Ht. 54.25" | Chain/Stem 36" **



42199OZCS | Everly™
 Olde Bronze® | Clear Seeded
 (1), 100W, E26 (Medium)
 10.25"Dia. x 15.25"H | Stem Tilt 90°
 Overall Ht. 54.25" | Chain/Stem 36" **



42456OZCS | Everly™
 Olde Bronze® | Clear Seeded
 (1), 100W, E26 (Medium)
 7"W x 13.75"H | Stem Tilt 90°
 Overall Ht. 52" | Chain/Stem 36" **



42141OZCS | Everly™
 Olde Bronze® | Clear Seeded
Also available in NICS
 (1), 100W, E26 (Medium)
 10.5"W x 15.25"H | Stem Tilt 90°
 Overall Ht. 54" | Chain/Stem 36" **



43594BK | Piston™
 Black
 (6), 75W, E26 (Medium)
 22"W x 12.75"H
 Overall Ht. 51" | Chain/Stem 36" *



43982BK | Taubert™
 Black
 (1), 100W, E26 (Medium)
 12"W x 13"H
 Overall Ht. 51" | Chain/Stem 36", Add'l Chain 4927 *



43984BK | Taubert™
 Black
 (4), 100W, E26 (Medium)
 18"W x 16.5"H
 Overall Ht. 55" | Chain/Stem 36", Add'l Chain 4927 *

Pendants



42890NI | Brinley™
Brushed Nickel | Clear
(8), 100W, E26 (Medium)
10.25"W x 7.75"H x 25.5"L
Overall Ht. 124"
⊗ ⊙



42890OZ | Brinley™
Olde Bronze® | Clear
(8), 100W, E26 (Medium)
10.25"W x 7.75"H x 25.5"L
Overall Ht. 124"
⊗ ⊙



42877OZ | Brinley™
Olde Bronze® | Clear
(6), 100W, E26 (Medium)
11.75"W x 7.75"H
Overall Ht. 124"
⊗



42877NI | Brinley™
Brushed Nickel | Clear
(6), 100W, E26 (Medium)
11.75"W x 7.75"H
Overall Ht. 124"
⊗



42869NI | Brinley™
Brushed Nickel | Clear
(3), 100W, E26 (Medium)
8.5"W x 7.75"H
Overall Ht. 124"
⊗



42869OZ | Brinley™
Olde Bronze® | Clear
(3), 100W, E26 (Medium)
8.5"W x 7.75"H
Overall Ht. 124"
⊗



52177BK | Zailey™
Black
(1), 100W, E26 (Medium)
16"Dia. x 14.25"H
Overall Ht. 121.5"
⊗



52177NBR | Zailey™
Natural Brass
(1), 100W, E26 (Medium)
16"Dia. x 14.25"H
Overall Ht. 121.5"
⊗



52177WH | Zailey™
White
(1), 100W, E26 (Medium)
16"Dia. x 14.25"H
Overall Ht. 121.5"
⊗



52152BK | Zailey™
Black
(1), 100W, E26 (Medium)
11.5"W x 9"H
Overall Ht. 124"



52152NBR | Zailey™
Natural Brass
(1), 100W, E26 (Medium)
11.5"W x 9"H
Overall Ht. 124"



52152WH | Zailey™
White
(1), 100W, E26 (Medium)
11.5"W x 9"H
Overall Ht. 124"



52153BK | Zailey™
Black
(1), 150W, E26 (Medium)
15.75"W x 12.5"H
Overall Ht. 124.5"



52153NBR | Zailey™
Natural Brass
(1), 150W, E26 (Medium)
15.75"W x 12.5"H
Overall Ht. 124.5"



52153WH | Zailey™
White
(1), 150W, E26 (Medium)
15.75"W x 12.5"H
Overall Ht. 124.5"



52176BK | Zailey™
Black
(1), 100W, E26 (Medium)
10.75"W x 9.5"H
Overall Ht. 124.5"



52176NBR | Zailey™
Natural Brass
(1), 100W, E26 (Medium)
10.75"W x 9.5"H
Overall Ht. 124.5"



52176WH | Zailey™
White
(1), 100W, E26 (Medium)
10.75"W x 9.5"H
Overall Ht. 124.5"



Pendants



2666OZ | Hatteras Bay
Olde Bronze® | Fresnel Lens
(1), 150W, E26 (Medium)
13.25"W x 12"H
Overall Ht. 50" | Chain/Stem 36" *
⊗



2666PN | Hatteras Bay
Polished Nickel | Fresnel Lens
(1), 150W, E26 (Medium)
13.25"W x 12"H
Overall Ht. 50" | Chain/Stem 36" *
⊗



2665OZ | Hatteras Bay
Olde Bronze® | Fresnel Lens
(1), 100W, E26 (Medium)
11.75"W x 11"H
Overall Ht. 49" | Chain/Stem 36" *
⊗



2665PN | Hatteras Bay
Polished Nickel | Fresnel Lens
(1), 100W, E26 (Medium)
11.75"W x 11"H
Overall Ht. 49" | Chain/Stem 36" *
⊗



42649OZ | Cobson
Olde Bronze®
(3), 100W, E26 (Medium)
20"W x 9.5"H
Overall Ht. 48" | Chain/Stem 36" *
⊗



43998CH | Crosby
Chrome
(4), 60W, E12 (Candelabra)
16"W x 31"H
Overall Ht. 105" | Chain/Stem 72" ^
⊗



43998BK | Crosby
Black
(4), 60W, E12 (Candelabra)
16"W x 31"H
Overall Ht. 105" | Chain/Stem 72" ^
⊗



43998NI | Crosby
Brushed Nickel
(4), 60W, E12 (Candelabra)
16"W x 31"H
Overall Ht. 105" | Chain/Stem 72" ^
⊗



43998OZ | Crosby
Olde Bronze®
(4), 60W, E12 (Candelabra)
16"W x 31"H
Overall Ht. 105" | Chain/Stem 72" ^
⊗



43998NBR | Crosby
Natural Brass
(4), 60W, E12 (Candelabra)
16"W x 31"H
Overall Ht. 105" | Chain/Stem 72" ^
⊗



42496NBR | Morrigan
Natural Brass
(4), 60W, E12 (Candelabra)
15"W x 24.25"H
Overall Ht. 98" | Chain/Stem 72" ^
⊗



42496NI | Morrigan
Brushed Nickel
(4), 60W, E12 (Candelabra)
15"W x 24.25"H
Overall Ht. 98" | Chain/Stem 72" ^
⊗



42496OZ | Morrigan
Olde Bronze®
(4), 60W, E12 (Candelabra)
15"W x 24.25"H
Overall Ht. 98" | Chain/Stem 72" ^
⊗



42499NBR | Morrigan
Natural Brass
(3), 60W, E12 (Candelabra)
10"W x 21"H
Overall Ht. 95" | Chain/Stem 72" ^
⊗



42499NI | Morrigan
Brushed Nickel
(3), 60W, E12 (Candelabra)
10"W x 21"H
Overall Ht. 95" | Chain/Stem 72" ^
⊗



42499OZ | Morrigan
Olde Bronze®
(3), 60W, E12 (Candelabra)
10"W x 21"H
Overall Ht. 95" | Chain/Stem 72" ^
⊗



42140NBR | Voleta
Natural Brass
(3), 60W, E12 (Candelabra)
16.5"W x 20.75"H
Overall Ht. 95" | Chain/Stem 72" ^
⊗



42140NI | Voleta
Brushed Nickel
(3), 60W, E12 (Candelabra)
16.5"W x 20.75"H
Overall Ht. 95" | Chain/Stem 72" ^
⊗



42140BK | Voleta
Black
(3), 60W, E12 (Candelabra)
16.5"W x 20.75"H
Overall Ht. 95" | Chain/Stem 72" ^
⊗

Pendants



42121BK
Black
Satin Etched w/ White Microfiber
(3), 100W, E26 (Medium)
20"W x 5.5"H
Overall Ht. 44" | Chain/Stem 36"



42121CLZ
Classic Bronze
Satin Etched w/ White Microfiber
(3), 100W, E26 (Medium)
20"W x 5.5"H
Overall Ht. 44" | Chain/Stem 36"



42121NI
Brushed Nickel
Satin Etched w/ White Microfiber
(3), 100W, E26 (Medium)
20"W x 5.5"H
Overall Ht. 44" | Chain/Stem 36"



42121OZ
Olde Bronze®
Satin Etched w/ White Microfiber
(3), 100W, E26 (Medium)
20"W x 5.5"H
Overall Ht. 44" | Chain/Stem 36"



42122BK
Black
Satin Etched w/ White Microfiber
(3), 150W, E26 (Medium)
24"W x 6"H
Overall Ht. 44" | Chain/Stem 36"



42122CLZ
Classic Bronze
Satin Etched w/ White Microfiber
(3), 150W, E26 (Medium)
24"W x 6"H
Overall Ht. 44" | Chain/Stem 36"



42122NI
Brushed Nickel
Satin Etched w/ White Microfiber
(3), 150W, E26 (Medium)
24"W x 6"H
Overall Ht. 44" | Chain/Stem 36"



42122OZ
Olde Bronze®
Satin Etched w/ White Microfiber
(3), 150W, E26 (Medium)
24"W x 6"H
Overall Ht. 44" | Chain/Stem 36"



42196BK
Black
Satin Etched w/ White Microfiber
(5), 100W, E26 (Medium)
30"W x 12"H
Overall Ht. 50" | Chain/Stem 36"



42196CLZ
Classic Bronze
Satin Etched w/ White Microfiber
(5), 100W, E26 (Medium)
30"W x 12"H
Overall Ht. 50" | Chain/Stem 36"



42196NI
Brushed Nickel
Satin Etched w/ White Microfiber
(5), 100W, E26 (Medium)
30"W x 12"H
Overall Ht. 50" | Chain/Stem 36"



42196OZ
Olde Bronze®
Satin Etched w/ White Microfiber
(5), 100W, E26 (Medium)
30"W x 12"H
Overall Ht. 50" | Chain/Stem 36"



3502NI | Dover™
 Brushed Nickel | Etched Seeded
 (3), 100W, E26 (Medium)
 17.75"W x 19"H
 Overall Ht. 93" | Chain/Stem 36" ^



3502TZ | Dover™
 Tannery Bronze | Etched Seeded
 (3), 100W, E26 (Medium)
 17.75"W x 19.5"H
 Overall Ht. 93" | Chain/Stem 36" ^





3299NI | Eileen™
 Brushed Nickel | Satin Etched White
 (4), 150W, E26 (Medium)
 25.75"W x 26.25"H
 Overall Ht. 64" | Chain/Stem 36" *



42881NI | Nicholson™
 Brushed Nickel | Satin Etched
 (1), 150W, E26 (Medium)
 16"W x 10"H
 Overall Ht. 48" | Chain/Stem 36" ^



42882NI | Nicholson™
 Brushed Nickel | Satin Etched
 (1), 150W, E26 (Medium)
 13"W x 21.75"H
 Overall Ht. 96" | Chain/Stem 72" ^

Additional Chain and Stem

CHAIN

2996 NI, OZ	Standard Gauge 36"
-------------	--------------------

STEM

2999 AP, BK, CH, NBR, NI, OZ, PN	.5" x 12"
3036 NI	.5" x 36"
3048 NI	.5 x 48"









UNDER CABINET LIGHTING

Our cabinet lighting provides useful illumination for everyday tasks and brings depth to a room, making it feel larger. Plus, these inconspicuous lights help highlight decorative items, enhance architectural details, and provide soft lighting and safe navigation during the evening hours.

6U Series | LED Under Cabinet Lighting

Take the guesswork out of choosing the right lighting: the 6U Series LED allows you to choose a warm or pure white light with the flip of a switch. You get variety and customization that can change easily to enhance your decor in different ways throughout the day.

Selectable 2700K & 3000K					
		8" - 6UCSK08WHT	12" - 6UCSK12WHT	22" - 6UCSK22WHT	30" - 6UCSK30WHT
LIGHT OUTPUT	Total Watts	7W	9W	16W	19W
	Delivered Lumens	270lm	400lm	735lm	1000lm
	CRI	90			
	Dimmable	Yes			
LOCATION		Dry			
DIMENSIONS		8" L x 4.2" W x 1" H	12" L x 4.2" W x 1" H	22" L x 4.2" W x 1" H	30" L x 4.2" W x 1" H

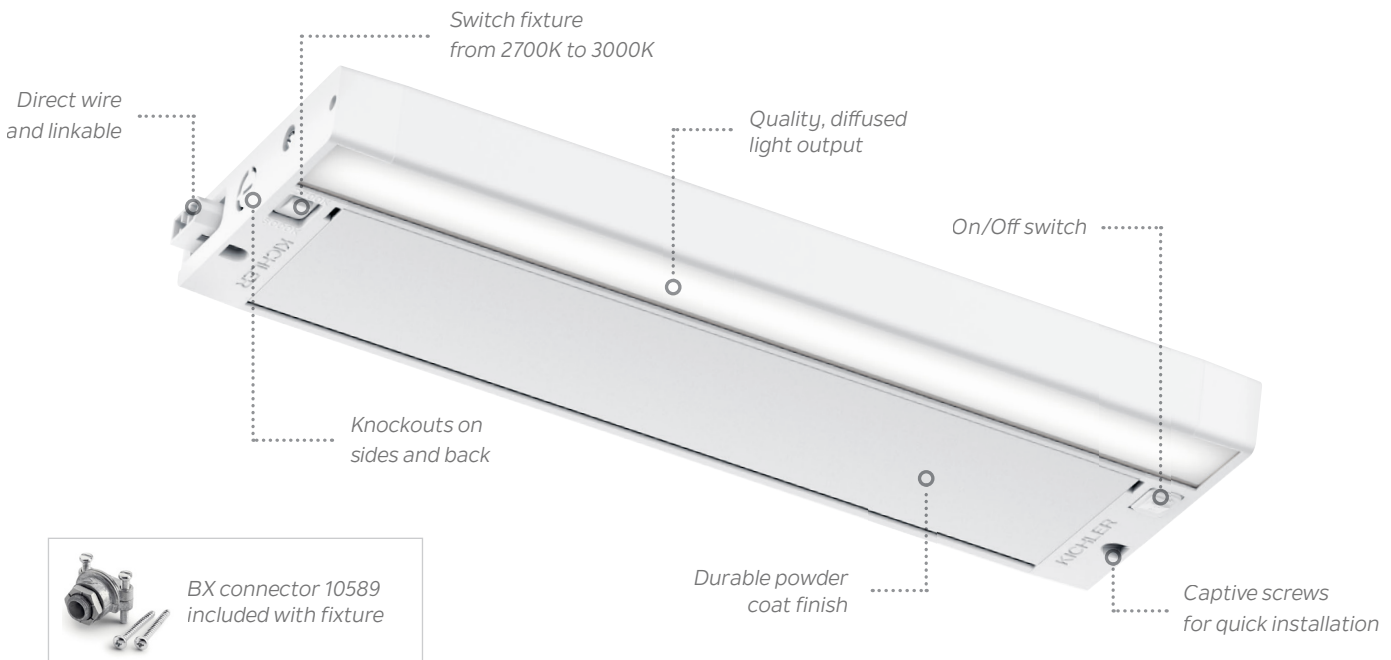

Certifications

FCC compliant and can be used to comply with 2019 Title 24, Part 6 High efficacy LED light source requirements.



Accessories

Available cables, connectors and cords on page 124.



Dimmers

For recommended dimmers visit Kichler.com/dimming.





Warranty

5-year residential warranty. 3-year commercial warranty. See Kichler.com/warranty for complete details.



4U Series | LED Under Cabinet Lighting

A low-profile design, durable finish and gently diffused light output make these LED fixtures a true value—ideal for a variety of applications, from single-family homes to multi-unit structures.

2700K Textured White					
		8" - 4U27K08WH	12" - 4U27K12WH	22" - 4U27K22WH	30" - 4U27K30WH
LIGHT OUTPUT	Total Watts	4W	6W	10W	14W
	Delivered Lumens	177lm	262lm	492lm	702lm
	CRI	90			
	Dimmable	Yes			
LOCATION		Dry			
DIMENSIONS		8" L x 4.5" W x 1.1" H	12" L x 4.5" W x 1.1" H	22" L x 4.5" W x 1.1" H	30" L x 4.5" W x 1.1" H

2700K Textured Bronze					
		8" - 4U27K08BZT	12" - 4U27K12BZT	22" - 4U27K22BZT	30" - 4U27K30BZT
LIGHT OUTPUT	Total Watts	4W	6W	10W	14W
	Delivered Lumens	177lm	262lm	492lm	702lm
	CRI	90			
	Dimmable	Yes			
LOCATION		Dry			
DIMENSIONS		8" L x 4.5" W x 1.1" H	12" L x 4.5" W x 1.1" H	22" L x 4.5" W x 1.1" H	30" L x 4.5" W x 1.1" H



Certifications

FCC compliant and can be used to comply with 2019 Title 24, Part 6 High efficacy LED light source requirements.



Accessories

Available cables, connectors and cords on page 124.



Dimmers

For recommended dimmers visit Kichler.com/dimming.

Warranty

5-year residential warranty.
3-year commercial warranty.
See Kichler.com/warranty for complete details.

3000K Textured White					
		8" - 4U30K08WH	12" - 4U30K12WH	22" - 4U30K22WH	30" - 4U30K30WH
LIGHT OUTPUT	Total Watts	4W	6W	10W	14W
	Delivered Lumens	200lm	285lm	560lm	750lm
	CRI	90			
	Dimmable	Yes			
LOCATION		Dry			
DIMENSIONS		8" L x 4.5" W x 1.1" H	12" L x 4.5" W x 1.1" H	22" L x 4.5" W x 1.1" H	30" L x 4.5" W x 1.1" H

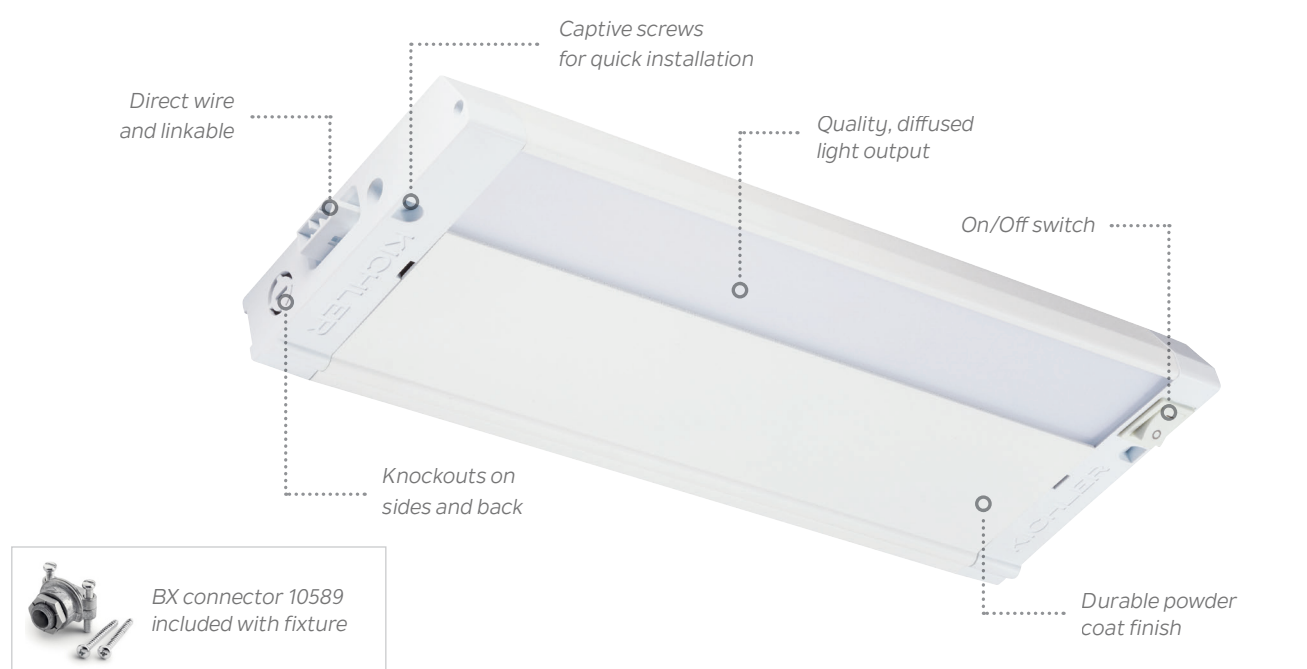

3000K Textured Bronze					
		8" - 4U30K08BZT	12" - 4U30K12BZT	22" - 4U30K22BZT	30" - 4U30K30BZT
LIGHT OUTPUT	Total Watts	4W	6W	10W	14W
	Delivered Lumens	200lm	285lm	560lm	750lm
	CRI	90			
	Dimmable	Yes			
LOCATION		Dry			
DIMENSIONS		8" L x 4.5" W x 1.1" H	12" L x 4.5" W x 1.1" H	22" L x 4.5" W x 1.1" H	30" L x 4.5" W x 1.1" H



4U & 6U Series Accessories

Link with ease. Our 4U and 6U Series LED accessories are available in an array of durable cables and connectors to create an interconnected, evenly powered under cabinet system design.

Interconnect Cable						
	10571WH	10571BK	10572WH	10572BK	10573WH	10573BK
Length	9"		14"		21"	
Compatible Fixtures	4U Series 6U Series					

Wire Module		
	10570WH	10570BK
Description	Use for Hard Wire Installations. Use with sheathed cable (12/2 or 14/2 with ground).	
Dimensions	7" L x 2.75" W x 1" H	
Compatible Fixtures	4U Series 6U Series	

Interconnect Prong Cord		
	6UCORDWH	6UCORDBK
Length	62"	
Compatible Fixtures	4U Series 6U Series	

Installation options that add versatility.

Our 4U and 6U LED under cabinet fixtures can be installed two different ways: either direct wired for installation closer to the wall, or linked together using accessories for installation near the front face of cabinets.



Back of Cabinet Installation – Direct wire connect.

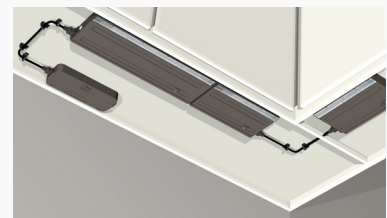

Front Mount – Use wire module and interconnect cable.





LED TAPE & ACCENT

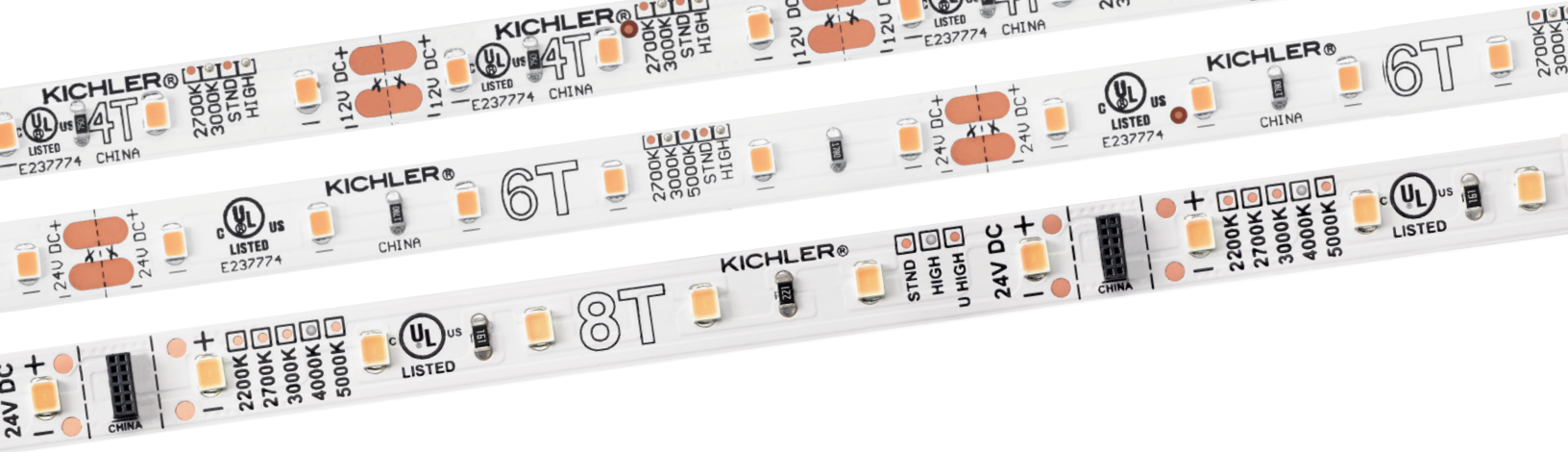

Versatile LED tape and accent lighting brings illumination to small or unique spaces. LED tape is ideal for lining a cove ceiling or shelving whereas LED accent discs are perfect for illuminating architectural niches. Plus, low voltage fixtures can also be used in the same design, with the same voltage. So, you can mix and match LED accent discs, and LED tape on the same power supply—saving you time and materials on the job.

Tape Light - 12V, 24V	128
Accent Discs - 12V, 24V	138
Power Supplies	140
LED Driver + Dimmer	141
TE Series Channels	146
Additional Accessories	152



Tape Light | Overview

Which Tape Light series is right for your project?

Tape Light Series Comparison		 8T Series Commercial Grade Page 130	 6T Series Premium Residential Page 132	 4T Series Residential Page 134
LIGHT OUTPUT	Color Temp	2700K 3000K 4000K	2700K 3000K 5000K	2700K 3000K
	Volts	24V		12V
	Outputs	Standard High Ultra-High	Standard High	
	CRI	90		
	Delivered Lumens	Up to 565lm Per Ft.	Up to 270lm Per Ft.	Up to 240lm Per Ft.
	Dimmable	Yes		
SIZE	Length	10' 33' 67' 100'	10' 16' 100'	16' 100'
	Width	0.4" (10mm)		
INSTALLATION	Location	Dry		
	Max Run Length	Up to 67'	Up to 32'	Up to 16'
	Cut Length	Every 4"		Every 2"
	Connector Types	8T Push-in Connectors	Terminal Block Connectors	
WARRANTY	5-year residential and commercial warranty.	5-year residential warranty. 3-year commercial warranty.	3-year residential warranty. 1-year commercial warranty.	

5000K
STND
HIGH
24V
E237774
DC
+
300K
00K
100K
000K
LISTED
81





LED TAPE & ACCENT





6T Series | 24V LED



8T Series | 24V LED

The 8T Series of Commercial Grade LED Tape Light is designed to integrate with our patented connector accessory system to simplify and speed up the installation of even the most complicated tape light design configurations.

Standard Output							
		8T1010S27WH		8T1067S27WH		8T1100S27WH	
LIGHT OUTPUT	Color Temp	2700K					
	Watt Per Ft.	1.5W					
	CRI	90					
	Delivered Lumens	120lm Per Ft.					
	Dimmable	Yes					
SIZE	Length	10'		67'		100'	
	Width	0.4" (10mm)					
INSTALLATION	Location	Dry					
	Max Run Length	67'					
	Cut Length	Every 4"					

Standard Output									
		8T1010S30WH		8T1067S30WH		8T1100S30WH		8T1100S40WH	
LIGHT OUTPUT	Color Temp	3000K				4000K			
	Watt Per Ft.	1.5W							
	CRI	90							
	Delivered Lumens	125lm Per Ft.				130lm Per Ft.			
	Dimmable	Yes							
SIZE	Length	10'		67'		100'		100'	
	Width	0.4" (10mm)							
INSTALLATION	Location	Dry							
	Max Run Length	67'							
	Cut Length	Every 4"							

Supply Wire

Tape light rolls come with a 2' supply wire soldered to the beginning and end of each roll.

Connectors

For compatible connectors see page 136.









Power Supplies

For compatible power supplies see page 140.



Warranty

5-year residential and commercial warranty. See Kichler.com/warranty for complete details.

High Output															
		8T1010H27WH	8T1033H27WH	8T1100H27WH	8T1010H30WH	8T1033H30WH	8T1100H30WH	8T1100H40WH							
LIGHT OUTPUT	Color Temp	2700K				3000K				4000K					
	Watt Per Ft.	3W													
	CRI	90													
	Delivered Lumens	205lm Per Ft.				210lm Per Ft.				220lm Per Ft.					
	Dimmable	Yes													
SIZE	Length	10'	33'	100'	10'	33'	100'	100'							
	Width	0.4" (10mm)													
INSTALLATION	Location	Dry													
	Max Run Length	33'													
	Cut Length	Every 4"													

Ultra High Output*		
		8T1010U30WH
LIGHT OUTPUT	Color Temp	3000K
	Watt Per Ft.	7.2W
	CRI	90
	Delivered Lumens	565lm Per Ft.
	Dimmable	Yes
SIZE	Length	10'
	Width	0.4" (10mm)
INSTALLATION	Location	Dry
	Max Run Length	10'
	Cut Length	Every 4"

*Ultra-High cannot be used TE Series Extruded Channels.



8T Series | 24V LED



6T Series | 24V LED

Choose your color temperature, your ideal wattage and more. The 6T Series brings a lengthy run of illumination to a variety of dry locations and features 3M™ adhesive backing for secure placement, every time.

Standard Output		KICHLER® 6T		KICHLER® 6T		KICHLER® 6T		KICHLER® 6T		KICHLER® 6T		KICHLER® 6T	
		6T110S27WH	6T116S27WH	6T1100S27WH	6T110S30WH	6T116S30WH	6T1100S30WH	6T116S50WH	6T1100S50WH				
LIGHT OUTPUT	Color Temp	2700K			3000K			5000K					
	Watt Per Ft.	1.5W											
	CRI	90											
	Delivered Lumens	120lm Per Ft.			125lm Per Ft.			145lm Per Ft.					
	Dimmable	Yes											
SIZE	Length	10'	16'	100'	10'	16'	100'	16'					
	Width	0.4" (10mm)											
INSTALLATION	Location	Dry											
	Max Run Length	32'											
	Cut Length	Every 4"											

High Output		KICHLER® 6T		KICHLER® 6T		KICHLER® 6T		KICHLER® 6T		KICHLER® 6T	
		6T110H27WH	6T120H27WH	6T1100H27WH	6T110H30WH	6T120H30WH	6T1100H30WH	6T1100H50WH			
LIGHT OUTPUT	Color Temp	2700K			3000K			5000K			
	Watt Per Ft.	3W									
	CRI	90									
	Delivered Lumens	215lm Per Ft.			245lm Per Ft.			270lm Per Ft.			
	Dimmable	Yes									
SIZE	Length	10'	20'	100'	10'	20'	100'	100'			
	Width	0.4" (10mm)									
INSTALLATION	Location	Dry									
	Max Run Length	20'									
	Cut Length	Every 4"									

Supply Wire

Tape light rolls come with a 2' supply wire soldered to the beginning and end of each roll.

Connectors

For compatible connectors see page 136.



Power Supplies

For compatible power supplies see page 140.



Warranty

3-year residential warranty.
1-year commercial warranty.
See Kichler.com/warranty for complete details.



6T Series | 24V LED



4T Series | 12V LED

A low voltage design and the ability to cut to 2" increments makes the 4T Series ideal for short runs and smaller spaces, like lining shelves or cabinets.

Standard Output		4T116S27WH	4T116S30WH	4T1100S30WH
		LIGHT OUTPUT		2700K
		1.5W per foot		
		90		
		120lm Per Ft.	130lm Per Ft.	
		Yes		
SIZE	Length	16'	16'	100'
	Width	0.4" (10mm)		
INSTALLATION	Location	Dry		
	Max Run Length	16'		
	Cut Length	Every 2"		

High Output		4T116H27WH	4T116H30WH	4T1100H30WH
		LIGHT OUTPUT		2700K
		3W per foot		
		90		
		210lm Per Ft.	240lm Per Ft.	
		Yes		
SIZE	Length	16'	16'	100'
	Width	0.4" (10mm)		
INSTALLATION	Location	Dry		
	Max Run Length	16'		
	Cut Length	Every 2"		

Supply Wire

Tape light rolls come with a 2' supply wire soldered to the beginning and end of each roll.

Connectors

For compatible connectors see page 136.



Power Supplies

For compatible power supplies see page 140.





Warranty



3-year residential warranty, 1-year commercial warranty. See Kichler.com/warranty for complete details.



4T Series, 12V LED

Tape Light Connectors

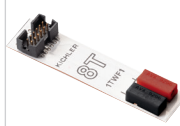
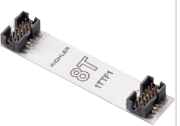
Terminal Block Connectors			
	1BTBT1CLR	1BTBW1CLR	1BTWWSCLR
Connection Type	Tape to Tape	Tape to Wire	Tape to Supply Lead
Compatible Tape Light	4T Series 12V Tape 6T Series 24V Tape		
Compatible Power Supplies	N/A	4TD, 4DD 12V 6TD, 6DD 24V 8TD 24V	
Features	Helps connect two pieces of tape together to continue a run or can be used as a patch.	Allows you to supply your own wire (18-22 AWG) at the desired length necessary for your installation	Comes with 6' of supply lead wire already affixed so you can save a step in connecting the tape back to the power supply.

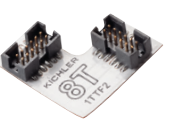
8T Series Pluggable Connectors						
	8T1TWR1WH	8T1TWF1WH	8T1TTF1WH	8T1TTR1WH	8T1TWRSWH	8T1TTF2WH
Connection Type	Tape to Wire	Tape to Wire Flex	Tape to Tape Flex	Tape to Tape	Tape to Supply Lead (72" - 18AWG)	90° Tape to Tape Flex
Compatible Tape Light	8T Series 24V Tape					
Compatible Power Supplies	6TD 24V 6DD 24V 8TD 24V					
Features	<ul style="list-style-type: none"> • Push in, reliable connection • Universal polarity at the connector for ease of installation • Provides 0-180 degree connection • Tape-to-wire connectors allow the installer to utilize their preferred 20-22AWG wire to make custom length supply leads and jumpers • Flexible connectors allow connections to bend around corners for new unique installation solutions • Designed to carry the full load of Standard, High and Ultra High tape light outputs. 					







Durable powder-coated finish



Premium frosted lens diffuses light cleanly and seamlessly for a "spotlight-free" effect

ACTUAL SIZE

Accent Discs

Get a stunning 190 lumens of output with just 4 Watts of power. Our LED Accent Discs can be surface or recess mounted and deliver a softly diffused infusion of light inside cabinetry or under shelving.

4D Series 12V LED		 4D12V27WHT	 4D12V30WHT
LIGHT OUTPUT	Color Temp	2700K	3000K
	Total Watts	4 Watts	
	CRI	90(+)	
	Delivered Lumens	150	
	Dimmable	Yes	
SIZE	Diameter	2.7"	
	Height	0.5"	
INSTALLATION	Location	Damp Rated (Enclosed Cabinets must be at least 12" D x 12" W x 12" H)	

6D Series 24V LED		 6D24V27WHT	 6D24V30WHT	 6D24V30BKT
LIGHT OUTPUT	Color Temp	2700K	3000K	3000K
	Total Watts	4 Watts		
	CRI	90(+)		
	Delivered Lumens	190		
	Dimmable	Yes		
SIZE	Diameter	2.7"		
	Height	0.5"		
INSTALLATION	Location	Damp Rated (Enclosed Cabinets must be at least 12" D x 12" W x 12" H)		

Wire Management

Each puck comes with 6' of blunt-cut wire; customize your length as needed — no bunching up the wires in tight spaces.

Connections

Use a splice box to connect multiple pucks, or to combine with LED tape, on the same power supply (12V-to-12V, 24V-to-24V).



Eliminate Voltage Drops

Eliminate voltage drops on long runs; use the wire that matches your needs: 24 AWG wire allows for a 40-foot run 18 AWG wire allows for a 170-foot run (best used as a trunk wire to allow for longer runs)

Warranty

3-year residential warranty. 1-year commercial warranty. See Kichler.com/warranty for complete details.



Surface Mount

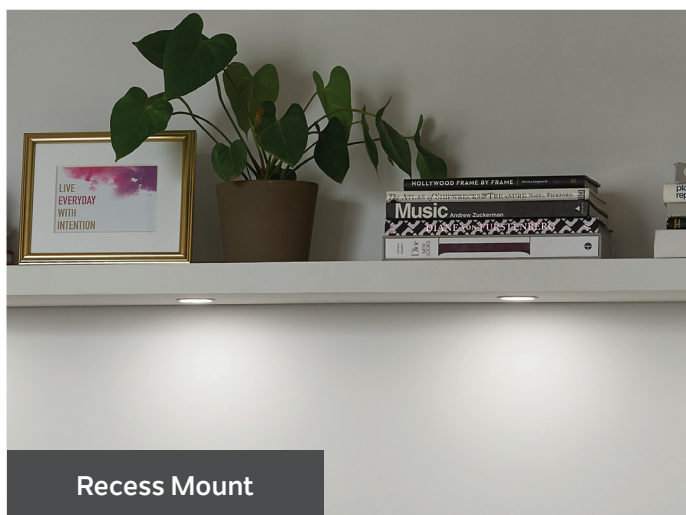

Recess Mount

Direct Wire Dimmable Power Supplies*

Whether you choose to hardwire your system or plug it in to an existing outlet, our power supplies deliver consistent, reliable energy, helping to maintain the life of the lighting fixtures.

12V	 4TD12V40BKT	 4TD12V060BKT		
Description	Lower Watt: Economical driver ideal for smaller, direct wire, low voltage system projects. CL and ELV dimmer compatible.	Higher Watt: Ideal for larger direct wire projects (i.e., combining multiple products). CL and ELV dimmer compatible.		
Total Watts	40 Watts	60 Watts		
Volts	12V			
Dimmable	Yes			
Dimensions	2.8" W x 1.4" H x 8.7" L			
Compatible Fixtures	4T Series 12V 4D Series 12V	4T Series 12V 4D Series 12V		
24V	 6TD24V10BKT	 6TD24V40BKT	 6TD24V060BKT	 6TD24V096BKT
Description	Lower Watt: Economical driver ideal for smaller, direct wire, low voltage system projects. CL and ELV dimmer compatible.		Higher Watt: Ideal for larger direct wire projects (i.e., combining multiple products). CL and ELV dimmer compatible.	
Total Watts	10 Watts	40 Watts	60 Watts	96 Watts
Volts	24V			
Dimmable	Yes			
Dimensions	2.8" W x 1.4" H x 8.7" L			
Compatible Fixtures	6T Series 24V 6D Series 24V 8T Series 24V		6T Series 24V 6D Series 24V 8T Series 24V	
24V Commercial Grade	 8TD24V060BKT	 8TD24V090BKT		
Description	The 8TD Series is a 0-10V dimmable, 120-277 input voltage power supply that can dim to 1.5%. Ideal for use in Commercial or Residential applications.			
Total Watts	60 Watts		90 Watts	
Dimmable	Yes (0-10V)			
Dimensions	2.6" W x 1.4" H x 8.7" L			
Compatible Fixtures	6T Series 24V 6D Series 24V 8T Series 24V			

Wiring Compartments

All of our Direct Wire Dimmable power supplies include wiring compartments. No additional NEMA enclosure required.

Dimmers

Compatible dimmers will vary based on selected power supply. For recommended dimmers visit Kichler.com/dimming.

LED Driver + Dimmer*

Simplify your lighting systems installation.

By integrating the driver with the dimmer switch, this one product can convert 120V AC to either 12V or 24V DC, as well as dim from 100% to 1%. Simply connect this one device to both your high voltage input and low voltage output, and install with a standard single gang box to the wall – saving time on installation.

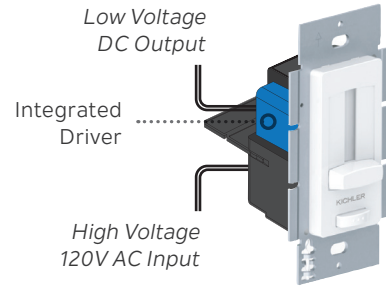

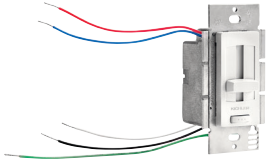
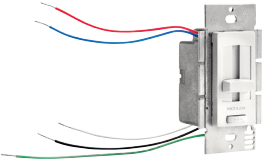
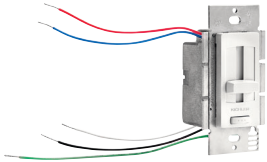
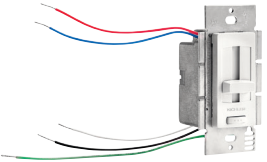
12V		
	4DD12V040WH	4DD12V060WH
	Total Watts	40 Watts
Compatible Fixtures	4T Series 12V 4D Series 12V	
24V		
	6DD24V060WH	6DD24V100WH
	Total Watts	60 Watts
Compatible Fixtures	6T Series 24V 6D Series 24V 8T Series 24V	

TRIM & FACE PLATE ACCESSORIES



White (WH)
1DDTRIMWH



Almond (ALM)
1DDTRIMALM



Brown (BW)
1DDTRIMBW



Black (BK)
1DDTRIMBK



Compatibility

All-in-one integrated LED Driver + Dimmer switch eliminates switch/driver compatibility issues.

Dimming Performance

Pre-set dimmer with on/off switch offers excellent dimming performance: 100%-1%.

Save Time

All-in-one product saves time in ordering, tracking, and installing over multiple components

Warranty

5-year limited warranty. See Kichler.com/warranty for complete details.

Power Supply Planning

To select a power supply, you must plan your project first and identify everything you need. This will help you see which power supply will work best for your project.

1
CHOOSE LIGHTING

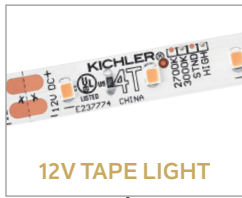

2
DETERMINE LOAD SIZE

Consider the total combined feet (Tape Light) and/or number (Accent Disc) being utilized in your project, and what that equates to in watts.

DETERMINE LOAD SIZE (Tape Light)
Total Watts Per Foot \times Total Combined Feet

EXAMPLE
If planning a tape light project that will use 12ft. of 6T120H30WH, multiply the watts/ft. (3W/ft.) by the total length needed (12ft.) $3 \times 12 = 36$, or 36 watts. This project will require a power supply with a wattage rating greater than 36W.

DETERMINE LOAD SIZE (Accent Disc)
Total Watts Per Disc \times Total Number of Discs

EXAMPLE
If planning an accent disc project that requires 6 accents discs, multiply the watts of the disc (4W/disc) \times the total number of discs (6) = 24W Total. This project will require a power supply with a wattage rating greater than 24W.

3
IDENTIFY LOCATION & DETERMINE WIRE GAUGE

Identifying your location and what is needed will help you plan out your runs better.

IDENTIFY BEST LOCATION FOR POWER SUPPLY

Where you want or need to place your power supply to best accommodate your project can factor into which power supply you choose. For instance, a remote island or china cabinet may work best with a low-watt Direct Wire Dimmable power supply tucked away nicely within to manage a smaller load without having to run and hide additional wiring to that location. When working on larger projects, it's important to think through whether a centralized Direct Wire Dimmable power supply placed above or within a cabinet is ideal. Or maybe leading back to the LED Driver + Dimmer installed in a nearby wall is better.

Where you decide to install the power supply can also potentially impact your wire gauge. Wire runs are relatively short in most cases, but if your only option is a long run, the Voltage Drop and Wire Gauge charts to the right can be your guide to determining what wire you will need.

If possible, consider a location that could be most central to your project. This will help with those long runs while also getting the most from one power supply. See page 66 for ways to optimize a centralized power supply fully.

DETERMINE WIRE GAUGE & VOLTAGE DROP (See Chart on page 143)

4
CHOOSE POWER SUPPLY

See pages 140-141 for an overview of each available power supply.

Keep in mind; the power supply must be the same voltage as the tape light and accent discs you are using for the project.

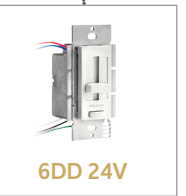
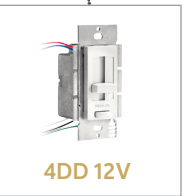

Voltage Drops

For best performance and lumen output, ensure proper wire gauge is installed to compensate for voltage drop of low voltage circuits.

12V Voltage Drop & Wire Length Distance Chart

	5W 0.42A	10W 0.83A	20W 1.67A	30W 2.5A	40W 3.33A	50W 4.17A	60W 5A
18 AWG	65 ft.	32 ft.	16 ft.	10 ft.	8 ft.	6 ft.	5 ft.
16 AWG	100 ft.	50 ft.	25 ft.	16 ft.	12 ft.	10 ft.	8 ft.
14 AWG	160 ft.	79 ft.	39 ft.	26 ft.	20 ft.	16 ft.	13 ft.
12 AWG	240 ft.	120 ft.	59 ft.	39 ft.	30 ft.	24 ft.	20 ft.
10 AWG	392 ft.	196 ft.	98 ft.	65 ft.	49 ft.	39 ft.	32 ft.

- Determine load size.** Lets assume the load is 55W. Round up to the nearest load.
- Determine distance from power supply to load.** Let's assume the distance is 32 ft. Round up to the nearest distance.
- See the recommended wire gauge** to install to eliminate excess voltage drop. Recommended wire gauge is 10AWG.

24V Voltage Drop & Wire Length Distance Chart

	5W 0.21A	10W 0.42A	20W 0.83A	30W 1.25A	40W 1.67A	50W 2.08A	60W 2.5A	70W 2.92A	80W 3.33A	90W 3.75A	100W 4.17A
18 AWG	261 ft.	130 ft.	65 ft.	43 ft.	32 ft.	26 ft.	21 ft.	18 ft.	16 ft.	14 ft.	13 ft.
16 AWG	401 ft.	200 ft.	100 ft.	66 ft.	50 ft.	40 ft.	33 ft.	28 ft.	25 ft.	22 ft.	20 ft.
14 AWG	639 ft.	319 ft.	160 ft.	106 ft.	79 ft.	63 ft.	53 ft.	45 ft.	39 ft.	35 ft.	31 ft.
12 AWG	959 ft.	479 ft.	240 ft.	160 ft.	120 ft.	95 ft.	79 ft.	68 ft.	59 ft.	53 ft.	47 ft.
10 AWG	1570 ft.	785 ft.	392 ft.	261 ft.	196 ft.	157 ft.	130 ft.	112 ft.	98 ft.	87 ft.	78 ft.

Low Voltage Wire - Class 2 Rated

The best choice outside of the wall: 24 AWG

This low voltage wire works perfectly for any Class 2 wiring project, since the 24 AWG wire is durable enough to be soldered when you choose not to use connectors. It's also the best option for our ultra-high output tape.

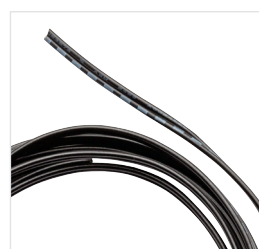

5W24G250 BK
24 AWG low voltage wire
250'
CL2 rated
Not for in-wall use

Power Supply Optimization

Get more from your power supply.

The diagrams below illustrate ways to break up your runs into multiples, which will ultimately result in additional inches of tape or accent lighting operating from one power supply. In addition to efficiencies gained in materials, the shorter linear runs will also help to maximize the light output potential for a beautiful end effect.

Maximize Light Output and the Power Supply

12V HIGH OUTPUT

Max. linear run length is 16', but connecting two 10' lengths in parallel increases total run to 20' using a 60W power supply.

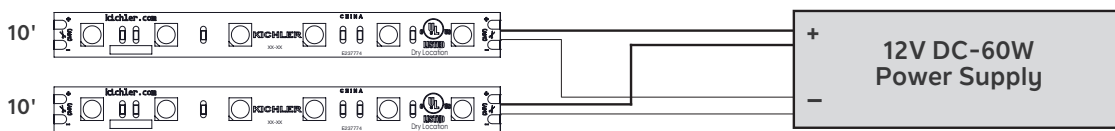

12V STANDARD OUTPUT

Max. linear run length is 16', connecting four 10' lengths in parallel increases total run to 40' using a 60W power supply.

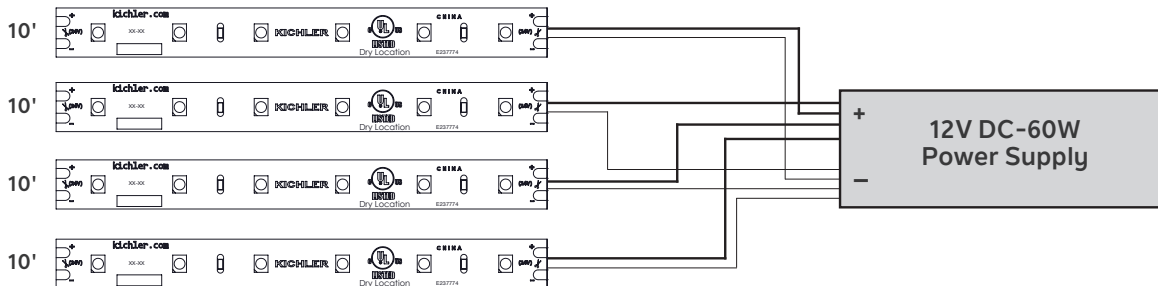

24V ULTRA-HIGH OUTPUT

Max. linear run length is 10', but connecting two 6.5' lengths in parallel increases total run to 13' using a 96W power supply.

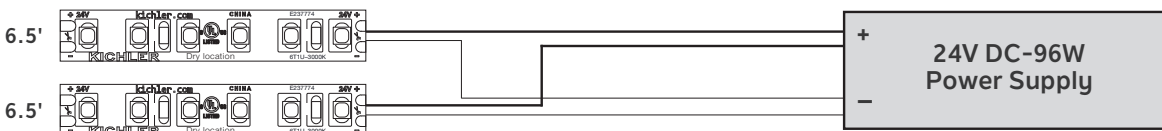

24V HIGH OUTPUT*:

Max. linear run length is 20', but connecting two 15' lengths in parallel increases total run to 30' using a 96W power supply.

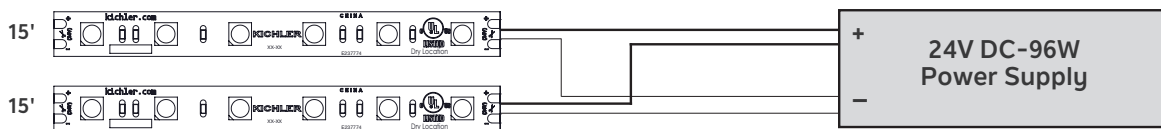

24V STANDARD OUTPUT*

Max. linear run length is 32', but connecting two 32' or four 16' lengths in parallel increases total run to 64' using a 96W power supply.

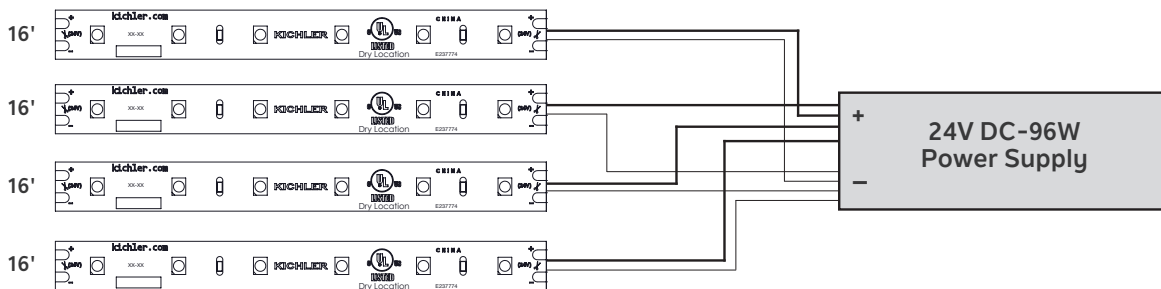

*With 8T tape you can run 33' and 67' as a single length, further reducing installation time.

12V ACCENT DISC

The ideal way to maximize your power supply on an accent disc installation is to combine with our 12V LED tape (4T Series).

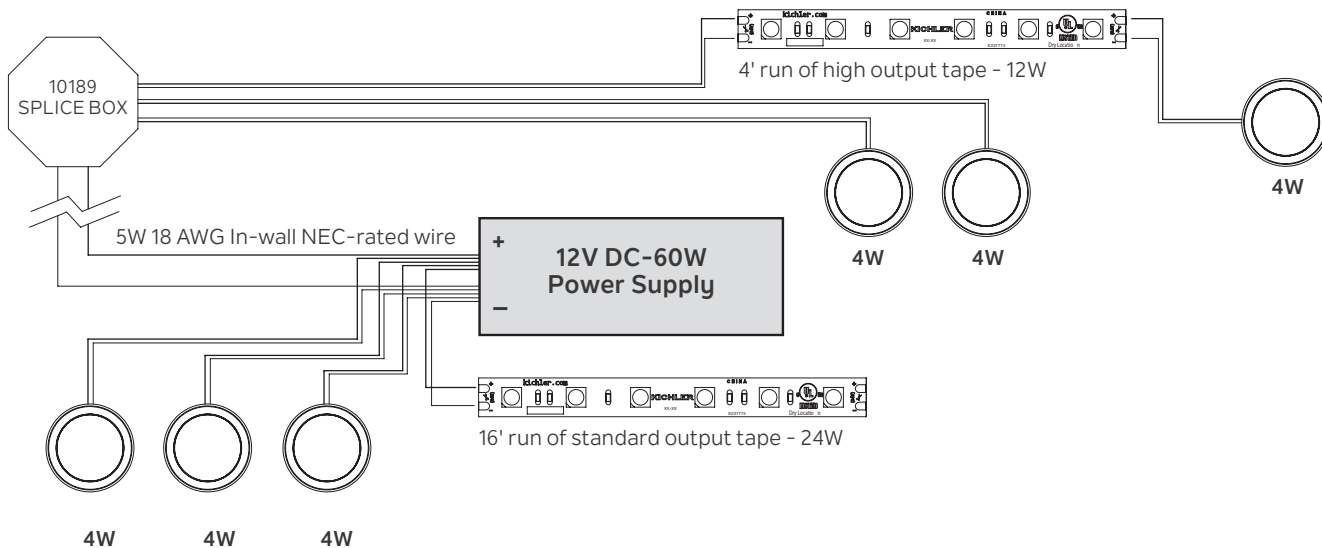

TIP

Center your Power Supply if possible

By centralizing the power supply within your project, you can maximize the total wattage of the power supply. For example, when laying out your wiring plan, consider splitting your installation into smaller runs (multiple independent runs to the driver), so you can take full advantage of the power supply without sacrificing voltage drop. This can help your lighting system perform better than one long run.



Check your polarity



Be sure to always check that your polarity is aligned back to the power supply – consistency in polarity direction is key in powering up your lighting system! In some instances, like kitchen islands, curio, or china, it may work best to plan for an additional, low-watt power supply to better manage wiring to those remote installations.

TE Standard Series Channels | Overview

Elevates your kitchen and shelving projects.

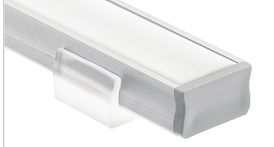
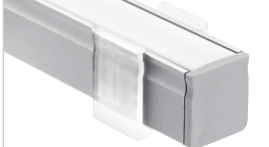
With simple mounting clips, varying depths for desired light diffusion and snap-in lenses, these channels offer a polished look while simplifying the installation process. The TE Standard Series is available a la carte or in kit forms for ease in ordering.

<p>Surface Mount page 148</p>	 <p>45-Degree</p>	 <p>Shallow</p>	 <p>Standard</p>	 <p>Deep</p>
<p>Installation</p>	<p>Install onto a surface to create sturdy under-cabinet, shelving or even step lighting. Miter cut and connect for custom shapes. Requires mounting clips and end caps.</p>			
<p>Location</p>	<ul style="list-style-type: none"> • Under cabinets • Under steps • Drawers 	<ul style="list-style-type: none"> • Under cabinets • Above cabinets or along toe kicks • Shelves 		

<p>Recessed Mount page 150</p>	 <p>Shallow</p>	 <p>Standard</p>	 <p>Deep</p>
<p>Installation</p>	<p>Recessed channels can then be inset for a seamless, built-in lighting effect. Miter cut and connect for custom shapes. Requires routing into wood or drywall.</p>		
<p>Location</p>	<ul style="list-style-type: none"> • Recessed under cabinets • Recessed into shelving or under a kitchen island • Wall or niche accent 		

CHANNEL DEPTH

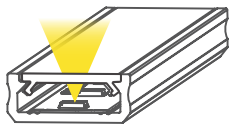

Shallow Channel

Sleek, cost effective, and presents a light distribution that's true to its source.

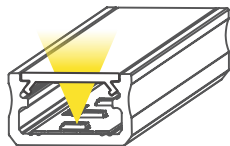

Standard Channel

Common depth offers a light distribution that is gently diffused.

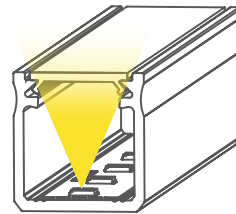



Deep Channel

Allows the light to blend within the channel, resulting in a greater diffused light.

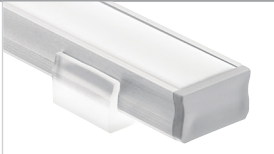
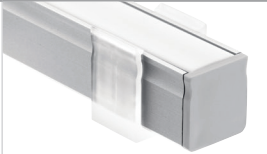
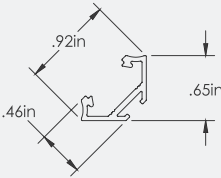
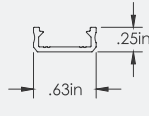
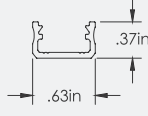
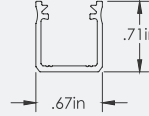

TE Standard Series | Surface Mount Channels

<p>Full Kits</p> <p>Tape Light Sold Separately</p>	 <p>45-Degree</p>	 <p>Shallow</p>	 <p>Standard</p>	 <p>Deep</p>
<p>Kit Models</p> <p>Includes: Channel, Lens (White Opaque), End Caps (2) and Mounting Clips (3, 5 or 9 for 2', 4' and 8' Kits respectively).</p>	<p>2' - 1TEK145SF2SIL</p>	<p>2' - 1TEK1SWSF2SIL</p>	<p>2' - 1TEK1STSF2SIL</p>	<p>2' - 1TEK1DWSF2SIL</p>
	<p>4' - 1TEK145SF4SIL</p>	<p>4' - 1TEK1SWSF4SIL</p>	<p>4' - 1TEK1STSF4SIL</p>	<p>4' - 1TEK1DWSF4SIL</p>
	<p>8' - 1TEK145SF8SIL</p>	<p>8' - 1TEK1SWSF8SIL</p>	<p>8' - 1TEK1STSF8SIL</p>	<p>8' - 1TEK1DWSF8SIL</p>
<p>Channel Depth</p>	<p>N/A</p>	<p>Sleek, cost effective, and presents a light distribution that's true to its source</p>	<p>Common depth offers a light distribution that is gently diffused</p>	<p>Allows the light to blend within the channel, resulting in a greater diffused light</p>
<p>Installation</p>	<p>Install onto a surface to create sturdy under-cabinet, shelving or even step lighting. Miter cut and connect for custom shapes. Requires mounting clips and end caps.</p>			
<p>Location</p>	<ul style="list-style-type: none"> • Under cabinets • Under steps • Drawers 	<ul style="list-style-type: none"> • Under cabinets • Above cabinets or along toe kicks • Shelves 		
<p>Dimensions</p>				



A La Carte To Build a Channel



Tape Light Sold Separately



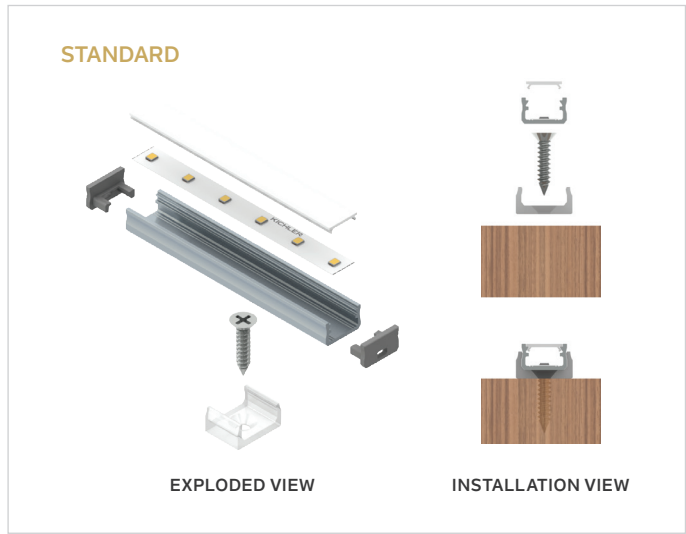
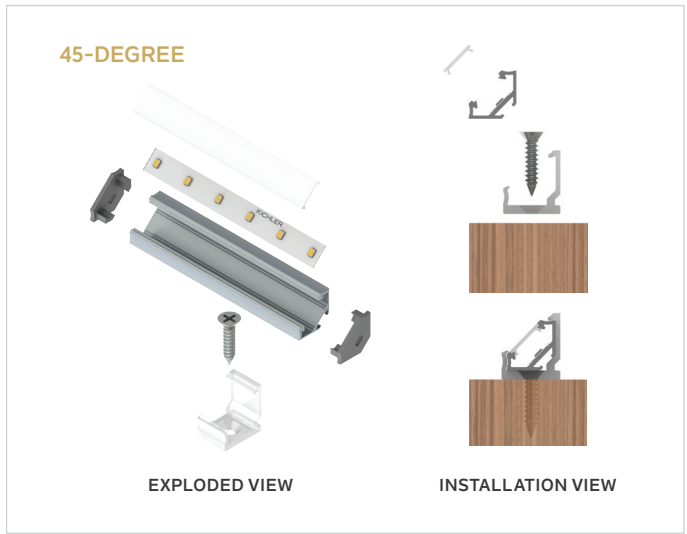

<p>1</p>  <p>Channels 8ft (See page 148)</p>	<p>45-Degree</p> <p>1TEC145SF8SIL</p>	<p>Shallow</p> <p>1TEC1SWSF8SIL</p>	<p>Standard</p> <p>1TEC1STSF8SIL</p>	<p>Deep</p> <p>1TEC1DWSF8SIL</p>
<p>2</p>  <p>Lenses 8ft (See page 152)</p>	<p>1TEL0018WHO Flat White Opaque</p>			
		<p>1TEL0018CLR Flat Clear</p>		
		<p>1TEL3018CLR Medium Beam Lens, Clear</p>		
		<p>N/A</p>	<p>1TEH018WHO High Diffusion, White Opaque</p>	<p>N/A</p>
<p>3</p>  <p>End Caps 10 total: 5 with Wiring Hole, 5 without</p>	<p>1TEE145SFSSIL</p>	<p>1TEE1SWSFSSIL</p>	<p>1TEE1STSFSSIL</p>	<p>1TEE1DWSFSSIL</p>
		<p>1TEE1SWSFHSL Pairs with High Diffusion Lens</p>	<p>1TEE1STSFHSL Pairs with High Diffusion Lens</p>	
<p>4</p>  <p>Mounting Clips 10 total</p>	<p>1TEM145SFCLR</p>	<p>1TEM1SWSFMCLR</p>	<p>1TEM1STSFMCLR</p>	<p>1TEM1DWSFCLR</p>

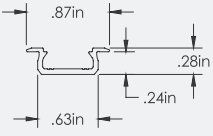
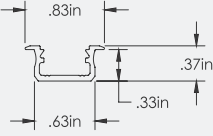
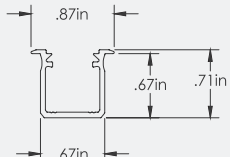

TE Standard Series | Recessed Mount Channels



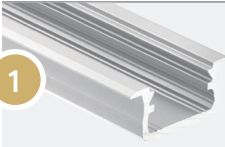

Full Kits Tape Light Sold Separately	 Shallow	 Standard	 Deep
Kit Models Includes: Channel, Lens (White Opaque), End Caps (2) and Mounting Clips (3, 5 or 9 for 2', 4' and 8' Kits respectively).	2' - 1TEK1SWRC2SIL	2' - 1TEK1STRC2SIL	2' - 1TEK1DWRC2SIL
	4' - 1TEK1SWRC4SIL	4' - 1TEK1STRC4SIL	4' - 1TEK1DWRC4SIL
	8' - 1TEK1SWRC8SIL	8' - 1TEK1STRC8SIL	8' - 1TEK1DWRC8SIL
Channel Depth	Sleek, cost effective, and presents a light distribution that's true to its source	Common depth offers a light distribution that is gently diffused	Allows the light to blend within the channel, resulting in a greater diffused light
Installation	Recessed channels can then be inset for a seamless, built-in lighting effect. Miter cut and connect for custom shapes. Requires routing into wood or drywall.		
Location	<ul style="list-style-type: none"> • Recessed under cabinets • Recessed into shelving or under a kitchen island • Wall or niche accent 		
Dimensions			

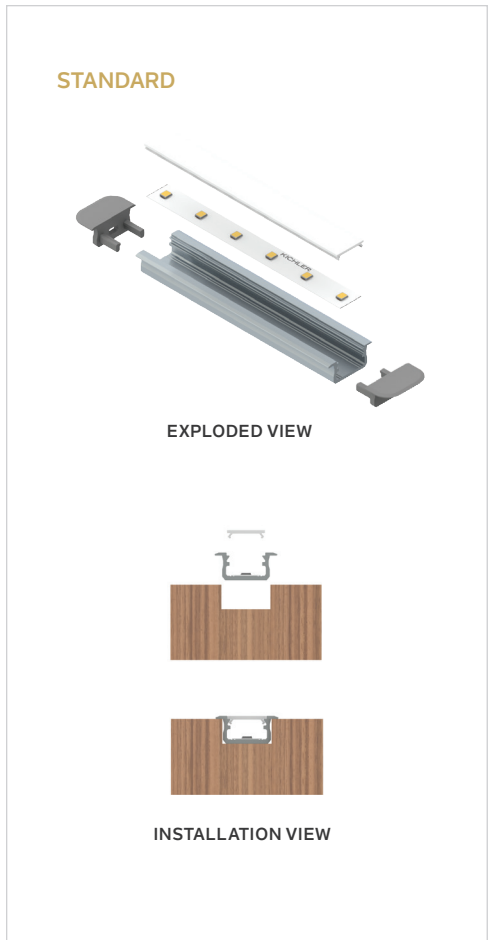

A La Carte To Build a Channel Tape Light Sold Separately		Shallow	Standard	Deep
1	 Channels 8ft (See page 150)	1TEC1SWRC8SIL	1TEC1STRC8SIL	1TEC1DWRC8SIL
2	 Lenses 8ft (See page 152)	1TEL0018WHO Flat White Opaque		
		1TEL0018CLR Flat Clear		
		1TEL3018CLR Medium Beam Lens, Clear		
3	 End Caps 10—all with Wiring Hole	1TEE1SWSFSSIL	1TEE1STSFSSIL	1TEE1DWSFSSIL



Channel Accessories

Lenses	 1TEL0018CLR	 1TEL0018WHO	 1TEL3018CLR	 1TELH018WHO
Description	Flat, Clear	Flat, White Opaque	Medium Beam, Clear	High Diffusion, White Opaque
Lighting Effect	Allows the most light through, noting that diodes will be more visible.	Diffuses the diodes more, as well as disperses the light output.	Utilized to create a thinner, more direct beam for a desired end effect.	Sits up higher, creating more of a beam angle. The added height of the lens also works to disperse more light.
Dimensions	0.5" W x 96" L			
Compatible Channels	All Standard surface mount channels			Shallow and Standard surface mount channels.



Tracks & Splice Box

Broaden your installation options with track and diffusers that allow you to customize the direction and appearance of your tape light.

<p>U-Channel Aluminum Track</p>	 <p>10174WH</p>	 <p>10174BK</p>
<p>Description</p>	<p>10-Pack. Includes 11 end caps and has pre-installed screws every 6 inches. Recommended for ultra-high output tape installations</p>	
<p>Dimensions</p>	<p>0.75" W x 0.5" H x 36" L</p>	
<p>Compatible Fixtures</p>	<p>4T Series 12V 6T Series 24V 8T Series 24V</p>	
<p>Accessories</p>	 <p>10176WH U-Channel End Caps - 5 Pack</p>	 <p>10176BK U-Channel End Caps - 5 Pack</p>
	<p>10179 Diffuser 36" Cut to Size</p>	
<p>Aluminum Splice Box</p>	 <p>10189WH</p>	 <p>10189BK</p>
<p>Location</p>	<p>Dry</p>	
<p>Installation</p>	<p>Splice LED tape light to Romex or another wire up to a max 14 gauge max. Intended for low voltage connections only. (4) 3/8" size K.O</p>	
<p>Dimensions</p>	<p>2.375" L x 2.375" W x 1" H</p>	
<p>Compatible Fixtures</p>	<p>4T Series 12V 4D Series 12V 6T Series 24V 6D Series 24V 8T Series 24V</p>	

How to Build Your System

1 LED Light Sources

8-SERIES

Commercial
Grade

Voltage - 24V



8T LED Tape Light – 100' Roll *(See page 130 for more options)*

Standard Output	2700K 8T1100S27WH	3000K 8T1100S30WH	4000K 8T1100S40WH
High Output	2700K 8T1100H27WH	3000K 8T1100H30WH	4000K 8T1100H40WH
Ultra High Output	3000K 8T1010U30WH <i>(*Ultra-High cannot be used TE Series Extruded Channels.)</i>		

6-SERIES

Premium
Residential

Voltage - 24V



6T LED Tape Light – 100' Roll *(See pages 132 for more options)*

Standard Output	2700K 6T1100S27 WH	3000K 6T1100S30 WH
High Output	2700K 6T1100H27 WH	3000K 6T1100H30 WH



6D Accent Disc *(See page 138 for more options)*

Textured Black	3000K 6D24V30BKT	
Textured White	2700K 6D24V27WHT	3000K 6D24V30WHT

4-SERIES

Residential

Voltage - 12V



4T LED Tape Light – 100' Roll *(See page 134 for more options)*

Standard Output	3000K 4T1100S30WH
-----------------	-----------------------------



4D Accent Disc *(See page 138 for more options)*

Textured White	2700K 4D12V27WHT	3000K 4D12V30WHT
----------------	----------------------------	----------------------------

Below are components frequently purchased together to create an accent lighting system. Utilize this guide to draft a quick spec, or refer to the pages that follow for additional sizes or models available in each category.

2 Connectors & Leads

8T Tape Light Connectors



8T1TWR1WH
Tape to Wire



8T1TTR1WH
Tape to Tape



8T1TWRSWH
Tape to Supply Lead

(See page 136 for more options)

Terminal Block Connectors



1TBT1CLR
Tape to Tape Connector



1TBTW1CLR
Tape to Wire Connector



1TBTWSCLR
Tape to Supply Lead Connector

(See page 136 for more details)

N/A

Terminal Block Connectors



1TBT1CLR
Tape to Tape Connector



1TBTW1CLR
Tape to Wire Connector



1TBTWSCLR
Tape to Supply Lead Connector

(See page 136 for more details)

N/A

3 Power Supplies

Learn more about Powers Supply planning starting on page 142



Direct Wire Dimmable Drivers
COMMERCIAL GRADE
8TD24V060BKT – 60W
8TD24V090BKT – 90W



Direct Wire Dimmable Drivers
6TD24V096BKTV2 – 96W
6TD24V060BKTV2 – 60W
6TD24V40BKT – 40W
6TD24V10BKT – 10W

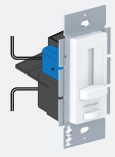

Driver + Dimmer All-in-one Driver and Dimmer Switch
6DD24V100WH – 100W
6DD24V060WH – 60W
(See pages 140 for more options)



Direct Wire Dimmable Drivers
4TD12V060BKTV2 – 60W
4TD12V40BKT – 40W

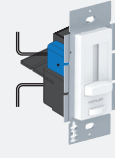

Driver + Dimmer All-in-one Driver and Dimmer Switch
4DD12V060WH – 60W
4DD12V040WH – 40W
(See pages 140 for more options)

4 Accessories

TE-Series Extruded Channels for Tape Light



Standard Depth Surface Mount Kits
1TEK1STSF2SIL – 2'
1TEK1STSF4SIL – 4'
1TEK1STSF8SIL – 8'



Standard Depth Recessed Mount Kits
1TEK1STRC2SIL – 2'
1TEK1STRC4SIL – 4'
1TEK1STRC8SIL – 8'



45-Degree Surface Mount Kits
1TEK145SF2SIL – 2'
1TEK145SF4SIL – 4'
1TEK145SF8SIL – 8'

(See page 146 for more options)



Power supply accessories
10189 BK, WH – Splice Box
(See page 153 for more options)



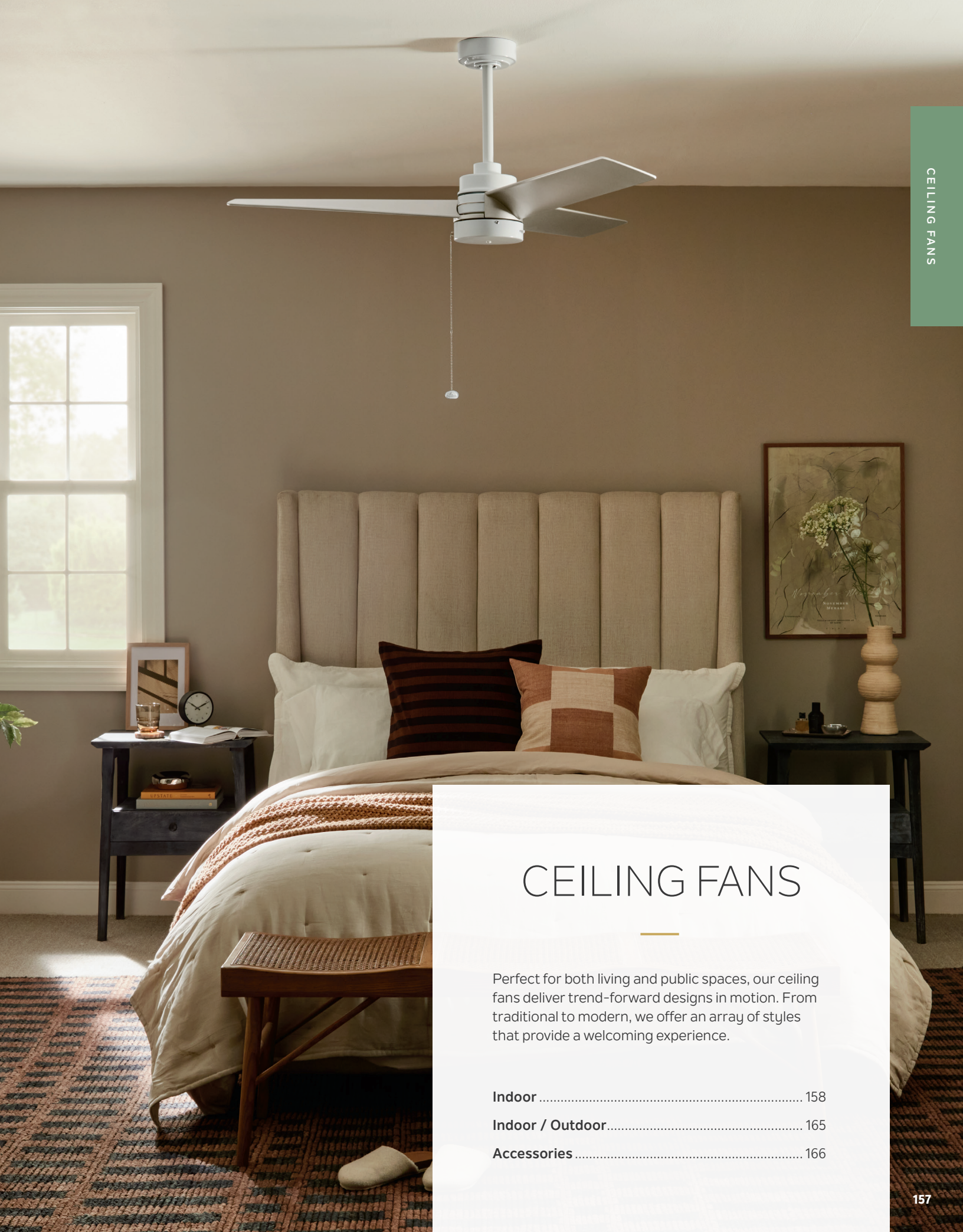

CEILING FANS

Perfect for both living and public spaces, our ceiling fans deliver trend-forward designs in motion. From traditional to modern, we offer an array of styles that provide a welcoming experience.

Indoor	158
Indoor / Outdoor	165
Accessories	166

Ceiling Fans | Indoor

15"



Terna™ LED 300230 NI (shown), WH

Finishes	– (NI) Brushed Nickel Finish, Champagne Blades – (WH) White Finish, White Blades		
Blades	(5) Included, Variable Pitch, 15" Sweep, Non-Reversible, Polycarbonate		
Downlight	Integrated LED, (1) 17W, 1600 Lumens, 80 CRI, 3000 CCT		
Glass	Etched Cased Opal		
Low Ceiling Adaptable	No	Hanging Weight	15.87 lbs.
Mounting Slope	Pitch 22°	Motor Size/Type	153mm x 15mm, AC
Lead Wire	78"	Amps	0.25 on High
cETLus Listed	Dry	RPM	318 on High
Included Control	CoolTouch™ Handheld Control System – Full Function		
Optional Controls	370038, 371045MUL, 371085		

AIRFLOW
359
Cubic Ft. Per Minute on High

POWER USAGE
32
Watts on High (Excludes Lights)

AIRFLOW EFFICIENCY
11
Cubic Ft. Per Minute Per Watt



60"



Lucian™ Elite XL 330060 NI, OZ, PN (shown), SBK

Finishes	– Brushed Nickel Finish, Walnut/Silver Blades – Olde Bronze® Finish, Walnut/Cherry Blades – Polished Nickel Finish, Black/Silver Blades – Satin Black Finish, Silver/Black Blades		
Blades	(5) Included, 14° Pitch, 60" Sweep, Reversible, Wood		
Downlight	Integrated LED, (1) 17W, 1600 Lumens, 80 CRI, 3000 CCT		
Glass	Etched Cased Opal		
Low Ceiling Adaptable	No	Hanging Weight	19.7 lbs.
Mounting Slope	Pitch 18°	Motor Size/Type	172mm x 20mm, AC
Lead Wire	78"	Amps	0.74 on High
cULus Listed	Dry	RPM	128 on High
Included Control	Wall Control System – Limited Function (16 freq.)		
Optional Controls	337214, 371042, 371082		

AIRFLOW
5840
Cubic Ft. Per Minute on High

POWER USAGE
85.5
Watts on High (Excludes Lights)

AIRFLOW EFFICIENCY
68
Cubic Ft. Per Minute Per Watt



52"



Lucian™ Elite 330000 NI, OZ, PN, SBK (shown)

Finishes	– Brushed Nickel Finish, Walnut/Silver Blades – Olde Bronze® Finish, Walnut/Cherry Blades – Polished Nickel Finish, Black/Silver Blades – Satin Black Finish, Silver/Black Blades		
Blades	(5) Included, 14° Pitch, 52" Sweep, Reversible, Wood		
Downlight	Integrated LED, (1) 17W, 1600 Lumens, 80 CRI, 3000 CCT		
Glass	Etched Cased Opal		
Low Ceiling Adaptable	No	Hanging Weight	21.8 lbs.
Mounting Slope	Pitch 18°	Motor Size/Type	172mm x 20mm, AC
Lead Wire	78"	Amps	0.6 on High
cULus Listed	Dry	RPM	155 on High
Included Control	Wall Control System – Limited Function (16 freq.)		
Optional Controls	337214, 371042, 371082		

AIRFLOW
5020
Cubic Ft. Per Minute on High

POWER USAGE
73.1
Watts on High (Excludes Lights)

AIRFLOW EFFICIENCY
68
Cubic Ft. Per Minute Per Watt



60"



Lucian™ II 330243 MWH, NI, SBK (shown)

Finishes	– Matte White Finish, Matte White Blades – Brushed Nickel Finish, Walnut/Silver Blades – Satin Black Finish, Silver/Black Blades		
Blades	(5) Included, 14° Pitch, 60" Sweep, Reversible (Finish Dependent), Wood		
Downlight	N/A		
Glass	N/A		
Low Ceiling Adaptable	No	Hanging Weight	27.5 lbs.
Mounting Slope	Pitch 18°	Motor Size/Type	188mm x 25mm, AC
Lead Wire	78"	Amps	0.57 on High
cULus Listed	Dry	RPM	111 on High
Included Control	Pull Chain		
Optional Controls	371042, 371082, 337001		

AIRFLOW
5200
Cubic Ft. Per Minute on High

POWER USAGE
64.8
Watts on High (Excludes Lights)

AIRFLOW EFFICIENCY
80
Cubic Ft. Per Minute Per Watt



52"



Lucian™ II 330242 MWH, NI (shown), SBK

Finishes	– Matte White Finish, Matte White Blades – Brushed Nickel Finish, Walnut/Silver Blades – Satin Black Finish, Silver/Black Blades		
Blades	(5) Included, 14° Pitch, 52" Sweep, Reversible (Finish Dependent), Wood		
Downlight	N/A		
Glass	N/A		
Low Ceiling Adaptable	No	Hanging Weight	16.0875 lbs.
Mounting Slope	Pitch 18°	Motor Size/Type	172mm x 14mm, AC
Lead Wire	78"	Amps	0.55 on High
cULus Listed	Dry	RPM	159 on High
Included Control	Pull Chain		
Optional Controls	371042, 371082, 337001		

AIRFLOW
5060
Cubic Ft. Per Minute on High

POWER USAGE
66.3
Watts on High (Excludes Lights)

AIRFLOW EFFICIENCY
76
Cubic Ft. Per Minute Per Watt



42"



Lucian™ II 330241 MWH (shown), NI, SBK

Finishes	– Matte White Finish, Matte White Blades – Brushed Nickel Finish, Walnut/Silver Blades – Satin Black Finish, Silver/Black Blades		
Blades	(5) Included, 14° Pitch, 42" Sweep, Reversible (Finish Dependent), Wood		
Downlight	N/A		
Glass	N/A		
Low Ceiling Adaptable	No	Hanging Weight	14.775 lbs.
Mounting Slope	Pitch 18°	Motor Size/Type	153mm x 15mm, AC
Lead Wire	78"	Amps	0.41 on High
cULus Listed	Dry	RPM	199 on High
Included Control	Pull Chain		
Optional Controls	371042, 371082, 337001		

AIRFLOW
3800
Cubic Ft. Per Minute on High

POWER USAGE
47.5
Watts on High (Excludes Lights)

AIRFLOW EFFICIENCY
80
Cubic Ft. Per Minute Per Watt



54"



Geno™ 330001 BSS (shown), MWH, SBK

Finishes	– Brushed Stainless Steel Finish, Silver/Walnut Blades – Matte White Finish, Matte White Blades – Satin Black Finish, Silver/Black Blades		
Blades	(5) Included, 14° Pitch, 54" Sweep, Reversible (Finish Dependent), Wood/Wood Veneer		
Downlight	Integrated LED, (1) 17W, 1600 Lumens, 80 CRI, 3000 CCT		
Glass	Etched Cased Opal		
Low Ceiling Adaptable	Yes, with 337008 Kit	Hanging Weight	24.5 lbs.
Mounting Slope	Pitch 18°	Motor Size/Type	188mm x 25mm, AC
Lead Wire	78"	Amps	0.65 on High
cULus Listed	Dry	RPM	160 on High
Included Control	Handheld Control System – Basic Function		
Optional Controls	370039, 371042, 371082		

AIRFLOW
5400
Cubic Ft. Per Minute on High

POWER USAGE
77
Watts on High (Excludes Lights)

AIRFLOW EFFICIENCY
70
Cubic Ft. Per Minute Per Watt



52"



Vassar™ 330002 NI (shown), SBK, WH

Finishes	– Brushed Nickel Finish, Silver/Walnut Blades – Satin Black Finish, Silver/Black Blades – White Finish, White/Silver Blades		
Blades	(3) Included, 14° Pitch, 52" Sweep, Reversible, Wood		
Downlight	Integrated LED, (1) 17W, 1600 Lumens, 80 CRI, 3000 CCT		
Glass	Etched Cased Opal		
Low Ceiling Adaptable	No	Hanging Weight	17.2 lbs.
Mounting Slope	Pitch 18°	Motor Size/Type	153mm x 17mm, AC
Lead Wire	78"	Amps	0.52 on High
cULus Listed	Dry	RPM	182 on High
Included Control	Wall Control System – Limited Function (16 freq.)		
Optional Controls	337214, 371042, 371082		

AIRFLOW
4811
Cubic Ft. Per Minute on High

POWER USAGE
59
Watts on High (Excludes Lights)

AIRFLOW EFFICIENCY
81
Cubic Ft. Per Minute Per Watt



Ceiling Fans | Indoor



60"

Starkk™ 330180 MWH (shown), NI, SBK

Finishes	– Matte White Finish, Matte White Blades – Brushed Nickel Finish, Silver/Walnut Blades – Satin Black Finish, Black/Silver Blades		
Blades	(5) Included, 14° Pitch, 60" Sweep, Reversible (Finish Dependent), Wood		
Downlight	Integrated LED, (1) 17W, 1600 Lumens, 80 CRI, 3000 CCT		
Glass	Etched Cased Opal		
Low Ceiling Adaptable	No	Hanging Weight	26.3 lbs.
Mounting Slope	Pitch 18°	Motor Size/Type	188mm x 25mm, AC
Lead Wire	78"	Amps	0.64 on High
cULus Listed	Dry	RPM	109 on High
Included Control	Pull Chain		
Optional Controls	371042, 371082, 337001		

AIRFLOW
5100
Cubic Ft. Per Minute on High

POWER USAGE
77.2
Watts on High (Excludes Lights)

AIRFLOW EFFICIENCY
66
Cubic Ft. Per Minute Per Watt



52"

Starkk™ 330174 MWH, NBR NI, OZ (shown), PN, SBK

Finishes	– Matte White Finish, Matte White Blades – Natural Brass Finish – Dark Cherry/Medium Cherry Blades – Brushed Nickel Finish, Walnut/Silver Blades – Olde Bronze® Finish, Cherry/Walnut Blades – Polished Nickel Finish, Silver/Walnut Blades – Satin Black Finish, Silver/Black Blades		
Blades	(5) Included, 12° Pitch, 52" Sweep, Reversible (Finish Dependent), Wood		
Downlight	Integrated LED, (1) 17W, 1600 Lumens, 80 CRI, 3000 CCT		
Glass	Etched Cased Opal		
Low Ceiling Adaptable	No	Hanging Weight	24.2 lbs.
Mounting Slope	Pitch 18°	Motor Size/Type	153mm x 17mm, AC
Lead Wire	78"	Amps	0.49 on High
cULus Listed	Dry	RPM	154 on High
Included Control	Pull Chain		
Optional Controls	371042, 371082, 337001		

AIRFLOW
4400
Cubic Ft. Per Minute on High

POWER USAGE
65
Watts on High (Excludes Lights)

AIRFLOW EFFICIENCY
67
Cubic Ft. Per Minute Per Watt



42"

Starkk™ 330171 MWH, NBR NI, SBK (shown)

Finishes	– Matte White Finish, Matte White Blades – Natural Brass Finish – Medium Cherry/Dark Cherry Blades – Brushed Nickel Finish, Silver/Walnut Blades – Satin Black Finish, Black/Silver Blades		
Blades	(5) Included, 12° Pitch, 42" Sweep, Reversible (Finish Dependent), Wood		
Downlight	Integrated LED, (1) 17W, 1600 Lumens, 80 CRI, 3000 CCT		
Glass	Etched Cased Opal		
Low Ceiling Adaptable	No	Hanging Weight	24.2 lbs.
Mounting Slope	Pitch 18°	Motor Size/Type	153mm x 12mm, AC
Lead Wire	78"	Amps	0.43 on High
cULus Listed	Dry	RPM	222 on High
Included Control	Pull Chain		
Optional Controls	371042, 371082, 337001		

AIRFLOW
3320
Cubic Ft. Per Minute on High

POWER USAGE
58.5
Watts on High (Excludes Lights)

AIRFLOW EFFICIENCY
56
Cubic Ft. Per Minute Per Watt



54"

Spyn Lite 300375 NI, SBK (shown), WH

Finishes	– Brushed Nickel Finish, Satin Black Blades – Satin Black Finish, Silver Blades – White Finish, Silver Blades		
Blades	(3) Included, 13° Pitch, 54" Sweep, Non-Reversible, ABS		
Downlight	N/A		
Glass	N/A		
Low Ceiling Adaptable	No	Hanging Weight	14.3 lbs.
Mounting Slope	Pitch 22°	Motor Size/Type	153mm x 17mm, AC
Lead Wire	78"	Amps	0.54 on High
cETLus Listed	Dry	RPM	157 on High
Included Control	Pull Chain		
Optional Controls	371042, 371082, 337001		

AIRFLOW
5050
Cubic Ft. Per Minute on High

POWER USAGE
63.7
Watts on High (Excludes Lights)

AIRFLOW EFFICIENCY
79
Cubic Ft. Per Minute Per Watt



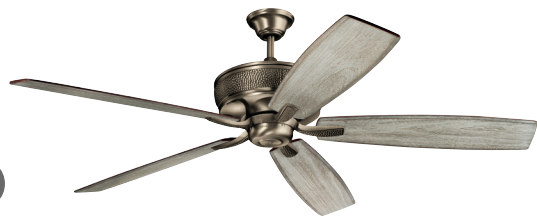

70"

Monarch™ 300206 BAP (shown), TZ

Finishes	– Burnished Antique Pewter Finish, Weathered White Walnut/Dark Cherry Blades – Tannery Bronze™ Finish, Teak/Dark Cherry Blades		
Blades	(5) Included, 16° Pitch, 70" Sweep, Reversible, Wood		
Downlight	N/A		
Glass	N/A		
Low Ceiling Adaptable	Yes, with 337008 Kit	Hanging Weight	30.8 lbs.
Mounting Slope	Pitch 18°	Motor Size/Type	212mm x 25mm, AC
Lead Wire	78"	Amps	0.8 on High
cULus Listed	Dry	RPM	128 on High
Included Control	Wall Control System – Full Function		
Optional Controls	337009, 371045, 371085		

AIRFLOW

9411
Cubic Ft. Per Minute on High

POWER USAGE

97
Watts on High (Excludes Lights)

AIRFLOW EFFICIENCY

97
Cubic Ft. Per Minute Per Watt



52"

Canfield™ 300117 OBB (shown), WH

Finishes	– Oil Brushed Bronze™ Finish, Cherry/Walnut Blades – White Finish, White Blades		
Blades	(5) Included, 14° Pitch, 52" Sweep, Reversible (Finish Dependent), Wood		
Downlight	N/A		
Glass	N/A		
Low Ceiling Adaptable	Yes, with 337008 Kit	Hanging Weight	19.7 lbs.
Mounting Slope	Pitch 18°	Motor Size/Type	172mm x 20mm, AC
Lead Wire	78"	Amps	0.54 on High
cULus Listed	Dry	RPM	155 on High
Included Control	Pull Chain		
Optional Controls	371042, 371082, 337001		

AIRFLOW

4868
Cubic Ft. Per Minute on High

POWER USAGE

66
Watts on High (Excludes Lights)

AIRFLOW EFFICIENCY

74
Cubic Ft. Per Minute Per Watt



Ceiling Fans | Indoor



30"

Canfield™ 300103 OBB (shown), WH

Finishes	– Oil Brushed Bronze™ Finish, Cherry/Walnut Blades – White Finish, White Blades		
Blades	(5) Included, 24° Pitch, 30" Sweep, Reversible (Finish Dependent), UVC Coated Wood		
Downlight	N/A		
Glass	N/A		
Low Ceiling Adaptable	Yes, with 337008 Kit	Hanging Weight	14.8 lbs.
Mounting Slope	Pitch 18°	Motor Size/Type	153mm x 17mm, AC
Lead Wire	78"	Amps	0.33 on High
cULus Listed	Damp	RPM	232 on High
Included Control	Pull Chain		
Optional Controls	371042, 371082, 337001		

AIRFLOW
2439
Cubic Ft. Per Minute on High

POWER USAGE
40
Watts on High (Excludes Lights)

AIRFLOW EFFICIENCY
61
Cubic Ft. Per Minute Per Watt



52"

Renew™ Premier 330162 BSS, MWH, OBB (shown), SBK

Finishes	– Brushed Stainless Steel Finish, Silver/Satin Black Blades – Matte White Finish, Matte White/Distressed Antique Gray Blades – Oil Brushed Bronze™ Finish, Walnut/Cherry Blades – Satin Black Finish, Satin Black/Silver Blades		
Blades	(5) Included, 12° Pitch, 52" Sweep, Reversible, Wood Hybrid		
Downlight	Bulb, (4) 9W, 3600 Lumens, 90 CRI, 3000 CCT		
Glass	White Etched Opal		
Low Ceiling Adaptable	Yes, Dual Mount Incl.	Hanging Weight	23.3 lbs.
Mounting Slope	Pitch 22°	Motor Size/Type	153mm x 18mm, AC
Lead Wire	78"	Amps	0.5 on High
cULus Listed	Dry	RPM	145 on High
Included Control	Pull Chain		
Optional Controls	371042, 371082, 337001		

AIRFLOW
4573
Cubic Ft. Per Minute on High

POWER USAGE
59
Watts on High (Excludes Lights)

AIRFLOW EFFICIENCY
78
Cubic Ft. Per Minute Per Watt



52"

Renew™ Designer 330163 MWH, NI, SBK, SNB (shown)

Finishes	– Matte White Finish, Matte White/Distressed Antique Gray – Painted Brushed Nickel Finish, Silver/Satin Black – Satin Black Finish, Satin Black/Silver Blades – Satin Natural Bronze Finish, Walnut/Cherry Blades		
Blades	(5) Included, 12° Pitch, 52" Sweep, Reversible, Wood Hybrid		
Downlight	Integrated LED, (1) 17W, 1400 Lumens, 90 CRI, 3000 CCT		
Glass	White Etched Opal		
Low Ceiling Adaptable	Yes, Dual Mount Incl.	Hanging Weight	19.1 lbs.
Mounting Slope	Pitch 22°	Motor Size/Type	153mm x 18mm, AC
Lead Wire	78"	Amps	0.49 on High
cULus Listed	Damp	RPM	142 on High
Included Control	Handheld Control System – Basic Function		
Optional Controls	370039, 371042, 371082		

AIRFLOW
4380
Cubic Ft. Per Minute on High

POWER USAGE
58
Watts on High (Excludes Lights)

AIRFLOW EFFICIENCY
75
Cubic Ft. Per Minute Per Watt



52"

Renew™ Select 330161 BSS, MWH, OBB, SBK (shown)

Finishes	– Brushed Stainless Steel Finish, Silver/Satin Black Blades – Matte White Finish, Matte White/Distressed Antique Gray Blades – Oil Brushed Bronze™ Finish, Walnut/Cherry Blades – Satin Black Finish, Satin Black/Silver Blades		
Blades	(5) Included, 12° Pitch, 52" Sweep, Reversible, Wood Hybrid		
Downlight	Integrated LED, (1) 17W, 1400 Lumens, 90 CRI, 3000 CCT		
Glass	White Etched Opal		
Low Ceiling Adaptable	Yes, Dual Mount Incl.	Hanging Weight	23.3 lbs.
Mounting Slope	Pitch 22°	Motor Size/Type	153mm x 18mm, AC
Lead Wire	78"	Amps	0.5 on High
cULus Listed	Dry	RPM	148 on High
Included Control	Pull Chain		
Optional Controls	371042, 371082, 337001		

AIRFLOW
4537
Cubic Ft. Per Minute on High

POWER USAGE
59
Watts on High (Excludes Lights)

AIRFLOW EFFICIENCY
77
Cubic Ft. Per Minute Per Watt



52"



(shown)

Renew™ Energy Star® 330164 BSS, MWH, OBB, SBK

Finishes	<ul style="list-style-type: none"> – Brushed Stainless Steel Finish, Silver/Satin Black Blades – Matte White Finish, Matte White/Distressed Antique Gray Blades – Oil Brushed Bronze™ Finish, Walnut/Cherry Blades – Satin Black Finish, Satin Black/Silver Blades 		
Blades	(5) Included, 12° Pitch, 52" Sweep, Reversible, Wood Hybrid		
Downlight	N/A		
Glass	N/A		
Low Ceiling Adaptable	Yes, Dual Mount Incl.	Hanging Weight	16.1 lbs.
Mounting Slope	Pitch 22°	Motor Size/Type	155mm x 16mm, DC
Lead Wire	78"	Amps	0.35 on High
cULus Listed	Dry	RPM	165 on High
Included Control	Pull Chain		
Optional Controls	N/A		

AIRFLOW

5123

Cubic Ft. Per Minute on High

POWER USAGE

30

Watts on High (Excludes Lights)

AIRFLOW EFFICIENCY

168

Cubic Ft. Per Minute Per Watt



52"



Renew™ 330160 BSS, MWH (shown), OBB, SBK

Finishes	<ul style="list-style-type: none"> – Brushed Stainless Steel Finish, Silver/Satin Black Blades – Matte White Finish, Matte White/Distressed Antique Gray Blades – Oil Brushed Bronze™ Finish, Walnut/Cherry Blades – Satin Black Finish, Satin Black/Silver Blades 		
Blades	(5) Included, 12° Pitch, 52" Sweep, Reversible, Wood Hybrid		
Downlight	N/A		
Glass	N/A		
Low Ceiling Adaptable	Yes, Dual Mount Incl.	Hanging Weight	18.3 lbs.
Mounting Slope	Pitch 22°	Motor Size/Type	153mm x 18mm, AC
Lead Wire	78"	Amps	0.5 on High
cULus Listed	Dry	RPM	147 on High
Included Control	Pull Chain		
Optional Controls	371042, 371082, 337001		

AIRFLOW

4484

Cubic Ft. Per Minute on High

POWER USAGE

59

Watts on High (Excludes Lights)

AIRFLOW EFFICIENCY

76

Cubic Ft. Per Minute Per Watt



Ceiling Fans | Indoor

52"



(shown)

Basics Pro Designer 330019 MWH, SBK, SNB, WH

Finishes	<ul style="list-style-type: none"> – Matte White Finish, Matte White Blades – Satin Black Finish, Satin Black Blades – Satin Natural Bronze Finish, Walnut Blades – White Finish, White Blades 		
Blades	(5) Included, 12° Pitch, 52" Sweep, Non-Reversible, ABS		
Downlight	Integrated LED, (1) 17W, 1400 Lumens, 90 CRI, 3000 CCT		
Lens	Frosted White Polycarbonate		
Low Ceiling Adaptable	Yes, Dual Mount Incl.	Hanging Weight	17.6 lbs.
Mounting Slope	Pitch 22°	Motor Size/Type	153mm x 15mm, AC
Lead Wire	78"	Amps	0.43 on High
cULus Listed	Damp	RPM	167 on High
Included Control	Handheld Control System – Basic Function		
Optional Controls	370039, 371042, 371082		

AIRFLOW
4190
Cubic Ft. Per Minute on High

POWER USAGE
61.1
Watts on High (Excludes Lights)

AIRFLOW EFFICIENCY
68
Cubic Ft. Per Minute Per Watt



52"



(shown)

Basics Pro Premier 330016 MWH, NI, NIS, SBK, SBKS, SNB, SNBS, WH

Finishes	<ul style="list-style-type: none"> – Matte White Finish, Matte White/Silver Blades – Brushed Nickel Finish, Walnut/Silver Blades – Satin Black Finish, Satin Black/Silver Blades – Satin Natural Bronze Finish, Walnut/Cherry Blades – White Finish, White/Silver Blades 		
Blades	(5) Included, 12° Pitch, 52" Sweep, Reversible, Wood		
Downlight	Bulb, (4) 9W, 3200 Lumens, 80 CRI, 3000 CCT		
Glass	Etched Cased Opal or Clear Seeded (for Clear Seeded, add "S" to the end of the SKU Number)		
Low Ceiling Adaptable	Yes, Dual Mount Incl.	Hanging Weight	19 lbs.
Mounting Slope	Pitch 22°	Motor Size/Type	153mm x 15mm, AC
Lead Wire	78"	Amps	0.46 on High
cULus Listed	Dry	RPM	180 on High
Included Control	Pull Chain		
Optional Controls	371042, 371082, 337001		

AIRFLOW
4110
Cubic Ft. Per Minute on High

POWER USAGE
58
Watts on High (Excludes Lights)

AIRFLOW EFFICIENCY
71
Cubic Ft. Per Minute Per Watt



52"



(shown)

Basics Pro Select 330017 MWH, NI, SBK, SNB, WH

Finishes	<ul style="list-style-type: none"> – Matte White Finish, Matte White/Silver Blades – Brushed Nickel Finish, Walnut/Silver Blades – Satin Black Finish, Satin Black/Silver Blades – Satin Natural Bronze Finish, Walnut/Cherry Blades – White Finish, White/Silver Blades 		
Blades	(5) Included, 12° Pitch, 52" Sweep, Reversible, Wood		
Downlight	Bulb, (3) 4W, 900 Lumens, 80 CRI, 2700 CCT		
Glass	White Etched		
Low Ceiling Adaptable	Yes, Dual Mount Incl.	Hanging Weight	19.71 lbs.
Mounting Slope	Pitch 22°	Motor Size/Type	153mm x 15mm, AC
Lead Wire	78"	Amps	0.43 on High
cULus Listed	Dry	RPM	161 on High
Included Control	Pull Chain		
Optional Controls	371042, 371082, 337001		

AIRFLOW
4160
Cubic Ft. Per Minute on High

POWER USAGE
60.2
Watts on High (Excludes Lights)

AIRFLOW EFFICIENCY
69
Cubic Ft. Per Minute Per Watt



Ceiling Fans | Indoor/Outdoor



52"

(shown)

Basics Pro Legacy 330020 MWH, NI, SBK, SNB, WH

Finishes	– Matte White Finish, Matte White/Silver Blades		
	– Brushed Nickel Finish, Walnut/Silver Blades		
	– Satin Black Finish, Satin Black/Silver Blades		
	– Satin Natural Bronze Finish, Walnut/Cherry Blades		
	– White Finish, White/Silver Blades		
Blades	(5) Included, 12° Pitch, 52" Sweep, Reversible, Wood		
Downlight	N/A		
Glass	N/A		
Low Ceiling Adaptable	N/A	Hanging Weight	15.32 lbs.
Mounting Slope	N/A	Motor Size/Type	153mm x 15mm, AC
Lead Wire	12"	Amps	0.57 on High
cULus Listed	Dry	RPM	152 on High
Included Control	Pull Chain		
Optional Controls	371042, 371082, 337001		

AIRFLOW
3120
Cubic Ft. Per Minute on High

POWER USAGE
57.3
Watts on High (Excludes Lights)

AIRFLOW EFFICIENCY
54
Cubic Ft. Per Minute Per Watt



52"

Basics Pro 330018 MWH, NI (shown), SBK, SNB, WH

Finishes	– Matte White Finish, Matte White/Silver Blades		
	– Brushed Nickel Finish, Walnut/Silver Blades		
	– Satin Black Finish, Satin Black/Silver Blades		
	– Satin Natural Bronze Finish, Walnut/Cherry Blades		
	– White Finish, White/Silver Blades		
Blades	(5) Included, 12° Pitch, 52" Sweep, Reversible, Wood		
Downlight	N/A		
Glass	N/A		
Low Ceiling Adaptable	Yes, Dual Mount Incl.	Hanging Weight	17.09 lbs.
Mounting Slope	Pitch 22°	Motor Size/Type	153mm x 15mm, AC
Lead Wire	78"	Amps	0.46 on High
cETLus Listed	Dry	RPM	174 on High
Included Control	Pull Chain		
Optional Controls	371042, 371082, 337001		

AIRFLOW
4100
Cubic Ft. Per Minute on High

POWER USAGE
58
Watts on High (Excludes Lights)

AIRFLOW EFFICIENCY
71
Cubic Ft. Per Minute Per Watt



52"

Basics Pro Patio 330015 MWH, SBK, SNB (shown), WH

Finishes	– Matte White Finish, Matte White Blades		
	– Satin Black Finish, Satin Black Blades		
	– Satin Natural Bronze Finish, Walnut Blades		
	– White Finish, White Blades		
Blades	(5) Included, 12° Pitch, 52" Sweep, Reversible (Finish Dependent), ABS		
Downlight	N/A		
Glass	N/A		
Low Ceiling Adaptable	Yes, Dual Mount Incl.	Hanging Weight	17.92 lbs.
Mounting Slope	Pitch 22°	Motor Size/Type	153mm x 15mm, AC
Lead Wire	78"	Amps	0.43 on High
cETLUS Listed	Damp	RPM	181 on High
Included Control	Pull Chain		
Optional Controls	371042, 371082, 337001		

AIRFLOW
4263
Cubic Ft. Per Minute on High

POWER USAGE
56.8
Watts on High (Excludes Lights)

AIRFLOW EFFICIENCY
75
Cubic Ft. Per Minute Per Watt



52"

Renew™ Patio 330165 MWH, NI, SBK (shown), SNB

Finishes	– Matte White Finish, Matte White/Distressed Antique Gray Blades		
	– Brushed Nickel Finish, Silver/Satin Black Blades		
	– Satin Black Finish, Satin Black/Silver Blades		
	– Satin Natural Bronze Finish, Walnut/Cherry Blades		
Blades	(5) Included, 12° Pitch, 52" Sweep, Reversible, Wood Hybrid		
Downlight	N/A		
Glass	N/A		
Low Ceiling Adaptable	Yes, Dual Mount Incl.	Hanging Weight	17.2 lbs.
Mounting Slope	Pitch 22°	Motor Size/Type	153mm x 18mm, AC
Lead Wire	78"	Amps	0.5 on High
cULus Listed	Damp	RPM	142 on High
Included Control	Pull Chain		
Optional Controls	371042, 371082, 337001		

AIRFLOW
4581
Cubic Ft. Per Minute on High

POWER USAGE
59
Watts on High (Excludes Lights)

AIRFLOW EFFICIENCY
78
Cubic Ft. Per Minute Per Watt



Ceiling Fans | AC Control Systems (Full Function)

Designed for AC motor fans. Includes transmitter, receiver, and 65K frequency options.
Dry-rated transmitter, Wet-rated receiver.



CoolTouch™ Handheld Control System Full Function

371085 ALM, IV, WH (shown)

- 65K frequency options
- 3 forward speeds, reverse, and motor off.
- Lights on/off with full-range dimming (including LED light sources)*
- Wireless radio frequency operational radius of 30' or less.
- Replaces any single-wall switch or mounts on any flat surface. **Retrofits most pull chain fans and most ceiling fan brands.**
- Includes transmitter and canopy-mounted, learn mode receiver with 65,000 code settings. Also includes wall bracket and mounting hardware, plus replaceable long-life lithium batteries.



Wall Control System Full Function

371045MUL ALM, IV, WH (shown)

- 65K frequency options
- 3 forward speeds, reverse, and motor off.
- Lights on/off with full-range dimming (including LED light sources)*
- Includes transmitter and canopy-mounted, learn-mode receiver with 65,000 code settings. Also includes white, ivory, and almond switch and cover plates, plus mounting hardware.
- Hardwire control, no batteries needed.



Optional Wall Transmitter: 371065MULTR

65K Wall Transmitter - Full Function
Includes almond (ALM), ivory (IV), and white (WH)



Optional Remote Transmitter: 370006WHTR

65K CoolTouch™ Transmitter - Full Function white (WH)

Ceiling Fans – AC Control Systems (Limited Function)

Designed for AC motor fans. Includes transmitter, receiver, and 65K frequency options.
Dry-rated transmitter, Wet-rated receiver.



CoolTouch™ Handheld Control System Limited Function

371082WH

- 65K frequency options
- 3 forward speeds, motor off, manual reverse.
- Lights on/off with full-range dimming (including LED light sources)*
- Wireless radio frequency operational radius of 30' or less.
- Replaces any single-wall switch or mounts on any flat surface. **Retrofits most pull chain fans and most ceiling fan brands.**
- Includes transmitter and canopy-mounted, learn mode receiver with 65,000 code settings. Also includes wall bracket and mounting hardware, plus replaceable long-life lithium batteries.



Wall Control System Limited Function

371042MUL ALM, IV, WH (shown)

- 65K frequency options
- 3 forward speeds, motor off, manual reverse.
- Lights on/off with full-range dimming (including LED light sources)*
- Includes transmitter and canopy-mounted, learn-mode receiver with 65,000 code settings. Also includes white, ivory, and almond switch and cover plates, plus mounting hardware.
- Hardwire control, no batteries needed.



Optional Wall Transmitter: 371062MULTR

65K Wall Transmitter - Limited Function
Includes almond (ALM), ivory (IV), and white (WH)



Optional Remote Transmitter: 370005WHTR

65K CoolTouch™ Transmitter - Limited Function white (WH)







OUTDOOR LIGHTING

Incorporating the right outdoor lighting can make a property inviting, while adding efficiencies to utility and maintenance costs. Our outdoor fixtures are built to perform with sturdy construction and time tested-finishes that stand up to the elements.

Integrated LED & LED Bulb Included	170
Socketed / Bulb not Included	175

LED Outdoor Lighting



59143BKT | Nocar
Textured Black
(1) 19.25W, 676lm, 3000K, 93 CRI, 35.25 LPW
5"W x 16"H | Ext. 3.5"
W T24 ADA LED



59144BKT | Nocar
Textured Black
(1) 19.25W, 1171lm, 3000K, 93 CRI, 60.83 LPW
5"W x 22.25"H | Ext. 3.5"
W T24 ADA LED



59145BKT | Nocar
Textured Black
(1) 37.75W, 1837lm, 3000K, 92 CRI, 48.75 LPW
5"W x 30"H | Ext. 3.5"
W T24 ADA LED



49557AZLED | Dahlia
Architectural Bronze | White Glass
(2), 45.2W, 525lm, 3000K, 90 CRI, 13 LPW
8"W x 18.75"H | Ext. 4"
W T24 LED



49558AZLED | Dahlia
Architectural Bronze | White Glass
(2), 69.8W, 875lm, 3000K, 90 CRI, 15 LPW
8"W x 25.25"H | Ext. 4"
W T24 LED



49557BKLED | Dahlia
Architectural Bronze | White Glass
(2), 45.2W, 525lm, 3000K, 90 CRI, 13 LPW
8"W x 18.75"H | Ext. 4"
W T24 LED



49558BKLED | Dahlia
Architectural Bronze | White Glass
(2), 69.8W, 875lm, 3000K, 90 CRI, 15 LPW
8"W x 25.25"H | Ext. 4"
W T24 LED





49278AZTLED | Wesley
Textured Architectural Bronze
Etched Glass
(1), 10W, 700lm, 3000K, 90 CRI, 90 LPW
7"W x 7.5"H | Ext. 4"
W C T24 LED



49279AZTLED | Wesley
Textured Architectural Bronze
Clear Tempered Glass With Inside Etch
(2), 20W, 800lm, 3000K, 90 CRI, 90 LPW
7"W x 13.75"H | Ext. 4"
W T24 LED



49607AZTLED | Estella
Textured Architectural Bronze
Etched Glass
(1), 8W, 720lm, 3000K, 90 CRI, 80 LPW
6"W x 12"H | Ext. 4.25"
W C T24 LED



49608AZTLED | Estella
Textured Architectural Bronze
Clear Tempered Glass With Inside Etch
(2), 8W, 720lm, 3000K, 90 CRI, 80 LPW
6"W x 16.5"H | Ext. 4.25"
W T24 LED



49278BKLED | Wesley
Textured Architectural Bronze
Etched Glass
(1), 10W, 700lm, 3000K, 90 CRI, 90 LPW
7"W x 7.5"H | Ext. 4"
W C T24 LED



49279BKLED | Wesley
Textured Architectural Bronze
Clear Tempered Glass With Inside Etch
(2), 20W, 800lm, 3000K, 90 CRI, 90 LPW
7"W x 13.75"H | Ext. 4"
W T24 LED



49607BKTLED | Estella
Textured Architectural Bronze
Etched Glass
(1), 8W, 720lm, 3000K, 90 CRI, 80 LPW
6"W x 12"H | Ext. 4.25"
W C T24 LED



49608BKTLED | Estella
Textured Architectural Bronze
Clear Tempered Glass With Inside Etch
(2), 8W, 720lm, 3000K, 90 CRI, 80 LPW
6"W x 16.5"H | Ext. 4.25"
W T24 LED



49278PLED | Wesley
Platinum | Etched Glass
(1), 10W, 700lm, 3000K, 90 CRI, 90 LPW
7"W x 7.5"H | Ext. 4"
W C T24 LED



49279PLED | Wesley
Platinum
Clear Tempered Glass With Inside Etch
(2), 20W, 800lm, 3000K, 90 CRI, 90 LPW
7"W x 13.75"H | Ext. 4"
W T24 LED



LED Outdoor Lighting



11309BKTLED
Textured Black

(1), 10W, 450lm, 3000K, 90 CRI, 50 LPW
5"W x 7"H | Ext. 6.5"



11310BKTLED
Textured Black

(2), 20W, 925lm, 3000K, 90 CRI, 51 LPW
5"W x 12.25"H | Ext. 6.5"



11251BKT30
Textured Black

(1), 15W, 550lm, 3000K, 90 CRI, 37 LPW
5"W x 12"H | Ext. 6.5"



11250BKT30
Textured Black

(1), 11W, 350lm, 3000K, 90 CRI, 33 LPW
5"W x 7"H | Ext. 6.5"



49550BKTLED | Walden
Textured Black

(1), 10W, 200lm, 3000K, 90 CRI, 20 LPW
5"W x 7.25"H | Ext. 3.75"



49551BKTLED | Walden
Textured Black

Clear Tempered Glass With Inside Etch
(2), 20W, 600lm, 3000K, 90 CRI, 30 LPW
5"W x 12"H | Ext. 3.75"



11251AZT30

Textured Architectural Bronze
(1), 15W, 550lm, 3000K, 90 CRI, 37 LPW
5"W x 12"H | Ext. 6.5"



11250AZT30

Textured Architectural Bronze
(1), 11W, 350lm, 3000K, 90 CRI, 33 LPW
5"W x 7"H | Ext. 6.5"



49550AZLED | Walden
Architectural Bronze

(1), 10W, 200lm, 3000K, 90 CRI, 20 LPW
5"W x 7.25"H | Ext. 3.75"



49551AZLED | Walden
Architectural Bronze

Clear Tempered Glass With Inside Etch
(2), 20W, 600lm, 3000K, 90 CRI, 30 LPW
5"W x 12"H | Ext. 3.75"



Our outdoor fixtures are a reliable source of light, style and durability

- Integrated LEDs deliver excellent light distribution and energy savings for 40,000 hours (to L70, or 70% initial lumens)
- Durable materials and finishes, including our Climates™ collections, are quality tested to withstand the elements
- Dark Sky certified options work to accommodate projects in which light pollution is a concern



11320BKTLED

Textured Black | Polycarbonate Diffuser
(1), 16W, 875lm, 3000K, 90 CRI, 55 LPW
10"W x 13"H | Ext. 5.25"



11132AZTLED

Textured Architectural Bronze
White Polycarbonate
(1), 23W, 1220lm, 3000K, 90 CRI, 53 LPW
11"Dia. | Ext. 3"





LED Outdoor Lighting



9794BK | Barrie
Black | Clear Beveled
(1), 100W, E26 (Medium)
4.75"W x 8.5"H | Ext. 5.75"



9794BKL18
(1), 9W, 800lm, E26, 3000K
92 CRI, 80 LPW



49183BK | Barrie
Black | Clear Beveled
(1), 100W, E26 (Medium)
6.25"W x 10.25"H | Ext. 6.5"



49183BKL18
(1), 9W, 800lm, E26, 3000K
92 CRI, 80 LPW



49186BK | Barrie
Black | Clear Beveled
(1), 100W, E26 (Medium)
9.75"W x 18.75"H | Ext. 9.5"



49186BKL18
(1), 9W, 800lm, E26, 3000K
92 CRI, 80 LPW



49187BK | Barrie
Black | Clear Beveled
(1), 100W, E26 (Medium)
9.75"W x 18"H

Shown with Post 9510



49187BKL18
(1), 9W, 800lm, E26, 3000K
92 CRI, 80 LPW



9794TZ | Barrie
Tannery Bronze | Clear Beveled
(1), 100W, E26 (Medium)
4.75"W x 8.5"H | Ext. 5.75"



9794TZL18
(1), 9W, 800lm, E26, 3000K
92 CRI, 80 LPW



49183TZ | Barrie
Tannery Bronze | Clear Beveled
(1), 100W, E26 (Medium)
6.25"W x 10.25"H | Ext. 6.5"



49183TZL18
(1), 9W, 800lm, E26, 3000K
92 CRI, 80 LPW



49186TZ | Barrie
Tannery Bronze | Clear Beveled
(1), 100W, E26 (Medium)
9.75"W x 18.75"H | Ext. 9.5"



49186TZL18
(1), 9W, 800lm, E26, 3000K
92 CRI, 80 LPW



49187TZ | Barrie
Tannery Bronze | Clear Beveled
(1), 100W, E26 (Medium)
9.75"W x 18"H

Shown with Post 9510



49187TZL18
(1), 9W, 800lm, E26, 3000K
92 CRI, 80 LPW



For fixtures with LED, Title 24 Rated light bulbs included, look for "L18" in the model number.



Outdoor Lighting



59111BKT | Branner
Textured Black
(1) 60W, E26 (Medium)
5.75"W x 14"H | Ext. 6.5"
W*



59112BKT | Branner
Textured Black
(1) 60W, E26 (Medium)
7"W x 17.75"H | Ext. 8"
W*



59111OZ | Branner
Olde Bronze®
(1) 60W, E26 (Medium)
5.75"W x 14"H | Ext. 6.5"
W*



59112OZ | Branner
Olde Bronze®
(1) 60W, E26 (Medium)
7"W x 17.75"H | Ext. 8"
W*



59113BKT | Branner
Textured Black
(1) 60W, E26 (Medium)
8.5"W x 24"H | Ext. 9.25"
W*



59114BKT | Branner
Textured Black
(1) 60W, E26 (Medium)
12"W x 30"H | Ext. 13"
W*



59113OZ | Branner
Olde Bronze®
(1) 60W, E26 (Medium)
8.5"W x 24"H | Ext. 9.25"
W*



59114OZ | Branner
Olde Bronze®
(1) 60W, E26 (Medium)
12"W x 30"H | Ext. 13"
W*



59115BKT | Branner
Textured Black
(1) 60W, E26 (Medium), 9.5"W x 25.5"H
Post Not Included
W*



59115OZ | Branner
Olde Bronze®
(1) 60W, E26 (Medium), 9.5"W x 25.5"H
Post Not Included
W*

Outdoor Lighting



49686BK | Toman™
Black | Satin Etched
(1), 75W, E26 (Medium)
6"W x 10.25"H | Ext. 6.5"
W D



49687BK | Toman™
Black | Satin Etched
(1), 100W, E26 (Medium)
8"W x 13.5"H | Ext. 8.75"
W D



49688BK | Toman™
Black | Satin Etched
(1), 150W, E26 (Medium)
10"W x 20"H | Ext. 11"
W D



49690BK | Toman™
Black | Satin Etched
(1), 150W, E26 (Medium)
10"W x 22"H
Shown with Post 9506
W D



49686OZ | Toman™
Olde Bronze® | Satin Etched
(1), 75W, E26 (Medium)
6"W x 10.25"H | Ext. 6.5"
W D



49687OZ | Toman™
Olde Bronze® | Satin Etched
(1), 100W, E26 (Medium)
8"W x 13.5"H | Ext. 8.75"
W D



49688OZ | Toman™
Olde Bronze® | Satin Etched
(1), 150W, E26 (Medium)
10"W x 20"H | Ext. 11"
W D



49690OZ | Toman™
Olde Bronze® | Satin Etched
(1), 150W, E26 (Medium)
10"W x 22"H
Shown with Post 9506
W D



59098BA | Lombard
Brushed Aluminum | Etched Seeded
(1) 100W Medium
5.5"W x 10.5"H | Ext. 6"
W D



59099BA | Lombard
Brushed Aluminum | Etched Seeded
(1) 100W Medium
7"W x 12.75"H | Ext. 7.5"
W D



59100BA | Lombard
Brushed Aluminum | Etched Seeded
(1) 100W Medium
9"W x 16.5"H | Ext. 9.5"
W D



59101BA | Lombard
Brushed Aluminum | Etched Seeded
(1) 100W Medium
9" Dia. x 17.25"H
Post Not Included
W D



59098BK | Lombard
Black | Etched Seeded
(1) 100W Medium
5.5"W x 10.5"H | Ext. 6"
W D



59099BK | Lombard
Black | Etched Seeded
(1) 100W Medium
7"W x 12.75"H | Ext. 7.5"
W D



59100BK | Lombard
Black | Etched Seeded
(1) 100W Medium
9"W x 16.5"H | Ext. 9.5"
W D



59101BK | Lombard
Black | Etched Seeded
(1) 100W Medium
9" Dia. x 17.25"H
Post Not Included
W D



49475RZ | South Hope™

Rubbed Bronze | Satin Etched Cased Opal
(1), 60W, E26 (Medium)
7"W x 17.75"H | Ext. 7.75"



49476RZ | South Hope™

Rubbed Bronze | Satin Etched Cased Opal
(1), 100W, E26 (Medium)
9"W x 19.75"H | Ext. 9.5"



59137BKT | Hone Climates™

Textured Black | Clear
(1) 60W, E26 (Medium)
5.5"W x 13"H | Ext. 6.5"



59138BKT | Hone Climates™

Textured Black | Clear
(1) 60W, E26 (Medium)
7"W x 18"H | Ext. 7.75"



59123BKT | Brix Climates™

Textured Black | Clear Ribbed
(1) 60W, E26 (Medium)
6.5"W x 16"H | Ext. 6.5"



59124BKT | Brix Climates™

Textured Black | Clear Ribbed
(1) 60W, E26 (Medium)
7"W x 19.25"H | Ext. 7.5"



Outdoor Lighting



49829BKT
Beacon Square Climates™
Textured Black | Clear Hammered
(1), 75W, E26 (Medium)
6.5"W x 12"H | Ext. 7.5"
WC



49830BKT
Beacon Square Climates™
Textured Black | Clear Hammered
(1), 100W, E26 (Medium)
8"W x 14.25"H | Ext. 9"
WC



49831BKT
Beacon Square Climates™
Textured Black | Clear Hammered
(1), 150W, E26 (Medium)
9.5"W x 17.5"H | Ext. 10.5"
WC



49832BKT
Beacon Square Climates™
Textured Black | Clear Hammered
(1), 150W, E26 (Medium)
9.5"W x 20.75"H
Shown with Post 9506
WC



49829OZ
Beacon Square Climates™
Olde Bronze® | Clear Hammered
(1), 75W, E26 (Medium)
6.5"W x 12"H | Ext. 7.5"
WC



49830OZ
Beacon Square Climates™
Olde Bronze® | Clear Hammered
(1), 100W, E26 (Medium)
8"W x 14.25"H | Ext. 9"
WC



49831OZ
Beacon Square Climates™
Olde Bronze® | Clear Hammered
(1), 150W, E26 (Medium)
9.5"W x 17.5"H | Ext. 10.5"
WC



49832OZ
Beacon Square Climates™
Olde Bronze® | Clear Hammered
(1), 150W, E26 (Medium)
9.5"W x 20.75"H
Shown with Post 9506
WC



49829WH
Beacon Square Climates™
White | Clear Hammered
(1), 75W, E26 (Medium)
6.5"W x 12"H | Ext. 7.5"
WC



49830WH
Beacon Square Climates™
White | Clear Hammered
(1), 100W, E26 (Medium)
8"W x 14.25"H | Ext. 9"
WC



49831WH
Beacon Square Climates™
White | Clear Hammered
(1), 150W, E26 (Medium)
9.5"W x 17.5"H | Ext. 10.5"
WC



49832WH
Beacon Square Climates™
White | Clear Hammered
(1), 150W, E26 (Medium)
9.5"W x 20.75"H
Shown with Post 9506
WC



Climates™ Outdoor Lighting

Uses a composite material with UV protectant to create an anti-fading finish that's resistant to: acidic and alkali elements, corrosion and rust.



49924BKT | Capanna™
Textured Black | Clear Water
(1), 60W, E26 (Medium)
6.5"W x 10.25"H | Ext. 7.75"
W



49925BKT | Capanna™
Textured Black | Clear Water
(1), 75W, E26 (Medium)
8.5"W x 13.25"H | Ext. 10"
W



49926BKT | Capanna™
Textured Black | Clear Water
(1), 100W, E26 (Medium)
10.5"W x 16"H | Ext. 12"
W



49927BKT | Capanna™
Textured Black | Clear Water
(1), 100W, E26 (Medium)
10.5"W x 18.25"H
Shown with Post 9506
W



49924OZ | Capanna™
Olde Bronze® | Clear Water
(1), 60W, E26 (Medium)
6.5"W x 10.25"H | Ext. 7.75"
W



49925OZ | Capanna™
Olde Bronze® | Clear Water
(1), 75W, E26 (Medium)
8.5"W x 13.25"H | Ext. 10"
W



49926OZ | Capanna™
Olde Bronze® | Clear Water
(1), 100W, E26 (Medium)
10.5"W x 16"H | Ext. 12"
W



49927OZ | Capanna™
Olde Bronze® | Clear Water
(1), 100W, E26 (Medium)
10.5"W x 18.25"H
Shown with Post 9506
W



49834BKT
Beacon Square Climates™
Textured Black | Clear Hammered
(2), 75W, E26 (Medium)
12"W x 5.25"H
DC

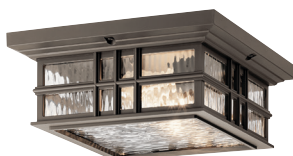

49834OZ
Beacon Square Climates™
Olde Bronze® | Clear Hammered
(2), 75W, E26 (Medium)
12"W x 5.25"H
DC



49834WH
Beacon Square Climates™
White | Clear Hammered
(2), 75W, E26 (Medium)
12"W x 5.25"H
DC



59016BK | Marimount™
Black | Clear Seeded
(1), 75W, E26 (Medium)
6.5"W x 11"H | Ext. 5.75"
W



59017BK | Marimount™
Black | Clear Seeded
(1), 100W, E26 (Medium)
7.5"W x 12.75"H | Ext. 5.75"
W



59018BK | Marimount™
Black | Clear Seeded
(1), 150W, E26 (Medium)
10"W x 17"H | Ext. 7.5"
W



59019BK | Marimount™
Black | Clear Seeded
(1), 150W, E26 (Medium)
6.75"W x 18.25"H x 10"L
Shown with Post 5906
W

Outdoor Lighting



49908RZ | Taden™
 Rubbed Bronze | Clear Seeded
 (1), 75W, E26 (Medium)
 6"W x 12.5"H | Ext. 7"
 W D



49909RZ | Taden™
 Rubbed Bronze | Clear Seeded
 (1), 100W, E26 (Medium)
 8"W x 16.5"H | Ext. 9.25"
 W D



49910RZ | Taden™
 Rubbed Bronze | Clear Seeded
 (1), 150W, E26 (Medium)
 10"W x 20.75"H | Ext. 11.5"
 W D



49911RZ | Taden™
 Rubbed Bronze | Clear Seeded
 (1), 150W, E26 (Medium)
 10"W x 21.5"H
 Shown with Post 5906 W D



59104BK | Noward
 Black | Satin Etched
 (1), 100W, E26 (Medium)
 6.5"W x 8.75"H | Ext. 6.25"
 W D



59105BK | Noward
 Black | Satin Etched
 (1), 100W, E26 (Medium)
 7.5"W x 10.25"H | Ext. 7"
 W D



59106BK | Noward
 Black | Satin Etched
 (1), 100W, E26 (Medium)
 9"W x 12.25"H | Ext. 8.25"
 W D



59107BK | Noward
 Black | Satin Etched
 (1), 100W, E26 (Medium)
 7.5"W x 15"H
 Post Not Included W D



59104OZ | Noward
 Olde Bronze® | Satin Etched
 (1), 100W, E26 (Medium)
 6.5"W x 8.75"H | Ext. 6.25"
 W D



59105OZ | Noward
 Olde Bronze® | Satin Etched
 (1), 100W, E26 (Medium)
 7.5"W x 10.25"H | Ext. 7"
 W D



59106OZ | Noward
 Olde Bronze® | Satin Etched
 (1), 100W, E26 (Medium)
 9"W x 12.25"H | Ext. 8.25"
 W D



59107OZ | Noward
 Olde Bronze® | Satin Etched
 (1), 100W, E26 (Medium)
 7.5"W x 15"H
 Post Not Included W D



Outdoor Lighting



49857BKT | Suri Climates™
Textured Black | Clear Seeded
(1), 75W, E26 (Medium)
5.5"W x 11.25"H | Ext. 6.75"
WC



49858BKT | Suri Climates™
Textured Black | Clear Seeded
(1), 100W, E26 (Medium)
7.75"W x 15.5"H | Ext. 9"
WC



49859BKT | Suri Climates™
Textured Black | Clear Seeded
(1), 150W, E26 (Medium)
9"W x 17.5"H | Ext. 10.25"
WC



49860BKT | Suri Climates™
Textured Black | Clear Seeded
(1), 150W, E26 (Medium)
9"W x 20"H
Shown with Post 9506
WC



49861BKT | Suri Climates™
Textured Black | Clear Seeded
(1), 75W, E26 (Medium)
5.5"Dia. x 11"H
DC



49960AVI | Mill Lane™
Anvil Iron | Clear Seeded
(1), 75W, E26 (Medium)
5.5"W x 10.25"H | Ext. 7"
W



49961AVI | Mill Lane™
Anvil Iron | Clear Seeded
(1), 100W, E26 (Medium)
7"W x 16"H | Ext. 9"
W



49962AVI | Mill Lane™
Anvil Iron | Clear Seeded
(1), 150W, E26 (Medium)
9"W x 21"H | Ext. 12"
W



49963AVI | Mill Lane™
Anvil Iron | Clear Seeded
(1), 150W, E26 (Medium)
9"W x 22.5"H
Shown with Post 9506
W



49965AVI | Mill Lane™
Anvil Iron | Clear Seeded
(2), 60W, E26 (Medium)
12.25"Dia. x 6"H
DC



49444AZ | Lyndon™
Architectural Bronze | Clear Seeded
(1), 75W, E26 (Medium)
5"W x 11.25"H | Ext. 7.5"
W



49445AZ | Lyndon™
Architectural Bronze | Clear Seeded
(1), 100W, E26 (Medium)
6"W x 15"H | Ext. 8"
W



49496AZ | Lyndon™
Architectural Bronze | Clear Seeded
(2), 60W, E12 (Candelabra)
8"W x 18.25"H | Ext. 9.5"
W



49444BA | Lyndon™
Brushed Aluminum | Clear Seeded
(1), 75W, E26 (Medium)
5"W x 11.25"H | Ext. 7.5"
W



49445BA | Lyndon™
Brushed Aluminum | Clear Seeded
(1), 100W, E26 (Medium)
6"W x 15"H | Ext. 8"
W



49496BA | Lyndon™
Brushed Aluminum | Clear Seeded
(2), 60W, E12 (Candelabra)
8"W x 18.25"H | Ext. 9.5"
W



49836BK | Pellinord™
 Black
 (1), 150W, E26 (Medium)
 8"W x 19"H | Ext. 14.75"
 W L D



49837BK | Pellinord™
 Black
 (1), 150W, E26 (Medium)
 10.25"W x 19"H | Ext. 16"
 W L D



49990BK | Pier™
 Black
 (1), 100W, E26 (Medium)
 12.5"W x 16.25"H | Ext. 21"
 W D



49991BK | Pier™
 Black
 (1), 150W, E26 (Medium)
 16.5"W x 16.25"H | Ext. 23.25"
 W D



49992BK | Pier™
 Black
 (1), 100W, E26 (Medium) | 12.5"Dia. x 11"H
 Overall Ht. 49" | Chain/Stem 36"
 D



49993BK | Pier™
 Black
 (1), 150W, E26 (Medium) | 16.5"Dia. x 11"H
 Overall Ht. 49" | Chain/Stem 36"
 D



49990OZ | Pier™
 Olde Bronze®
 (1), 100W, E26 (Medium)
 12.5"W x 16.25"H | Ext. 21"
 W D



49991OZ | Pier™
 Olde Bronze®
 (1), 150W, E26 (Medium)
 16.5"W x 16.25"H | Ext. 23.25"
 W D



49992OZ | Pier™
 Olde Bronze®
 (1), 100W, E26 (Medium) | 12.5"Dia. x 11"H
 Overall Ht. 49" | Chain/Stem 36"
 D



49993OZ | Pier™
 Olde Bronze®
 (1), 150W, E26 (Medium) | 16.5"Dia. x 11"H
 Overall Ht. 49" | Chain/Stem 36"
 D

Outdoor Lighting



49980BKT | Allenbury Climates™
Textured Black
(1), 100W, E26 (Medium)
12"W x 9"H | Ext. 17.25"
W C



49981BKT | Allenbury Climates™
Textured Black
(1), 150W, E26 (Medium)
14"W x 9"H | Ext. 20"
W C



49982BKT | Allenbury Climates™
Textured Black
(1), 100W, E26 (Medium) | 12"Dia. x 8.25"H
Overall Ht. 45" | Chain/Stem 36", Add'l Stem 4935
D C



49980OZ | Allenbury Climates™
Olde Bronze®
(1), 100W, E26 (Medium)
12"W x 9"H | Ext. 17.25"
W C



49981OZ | Allenbury Climates™
Olde Bronze®
(1), 150W, E26 (Medium)
14"W x 9"H | Ext. 20"
W C



49982OZ | Allenbury Climates™
Olde Bronze®
(1), 100W, E26 (Medium) | 12"Dia. x 8.25"H
Overall Ht. 45" | Chain/Stem 36", Add'l Stem 4935
D C



49980WH | Allenbury Climates™
White with Black Accent
(1), 100W, E26 (Medium)
12"W x 9"H | Ext. 17.25"
W C



49981WH | Allenbury Climates™
White with Black Accent
(1), 150W, E26 (Medium)
14"W x 9"H | Ext. 20"
W C



49982WH | Allenbury Climates™
White with Black Accent
(1), 100W, E26 (Medium) | 12"Dia. x 8.25"H
Overall Ht. 45" | Chain/Stem 36", Add'l Stem 4935
D C



49775BK | Northland™
Black
(1), 100W, E26 (Medium)
10"W x 12"H | Ext. 17.25"
W L



49776BK | Northland™
Black
(1), 150W, E26 (Medium)
14"W x 16.75"H | Ext. 24"
W L



9021BK | Seaside™
Black
(1), 60W, E26 (Medium)
6"W x 7.5"H | Ext. 6.5"
W



9022BK | Seaside™
Black
(1), 100W, E26 (Medium)
7.75"W x 12"H | Ext. 9"
W



9023BK | Seaside™
Black
(1), 150W, E26 (Medium)
10.25"W x 14.25"H | Ext. 11.75"
W



9142BK | Seaside™
Black
(1), 150W, E26 (Medium)
12"W x 16.5"H | Ext. 13.5"
W



9021NI | Seaside™
Brushed Nickel
(1), 60W, E26 (Medium)
6"W x 7.5"H | Ext. 6.5"
W



9022NI | Seaside™
Brushed Nickel
(1), 100W, E26 (Medium)
7.75"W x 12"H | Ext. 9"
W



9023NI | Seaside™
Brushed Nickel
(1), 150W, E26 (Medium)
10.25"W x 14.25"H | Ext. 11.75"
W



9142NI | Seaside™
Brushed Nickel
(1), 150W, E26 (Medium)
12"W x 16.5"H | Ext. 13.5"
W



9021OZ | Seaside™
Olde Bronze®
(1), 60W, E26 (Medium)
6"W x 7.5"H | Ext. 6.5"
W



9022OZ | Seaside™
Olde Bronze®
(1), 100W, E26 (Medium)
7.75"W x 12"H | Ext. 9"
W



9023OZ | Seaside™
Olde Bronze®
(1), 150W, E26 (Medium)
10.25"W x 14.25"H | Ext. 11.75"
W



9142OZ | Seaside™
Olde Bronze®
(1), 150W, E26 (Medium)
12"W x 16.5"H | Ext. 13.5"
W



9022OB | Seaside™
Olde Brick
(1), 100W, E26 (Medium)
7.75"W x 12"H | Ext. 9"
W



9023OB | Seaside™
Olde Brick
(1), 150W, E26 (Medium)
10.25"W x 14.25"H | Ext. 11.75"
W



9022WH | Seaside™
White
(1), 100W, E26 (Medium)
7.75"W x 12"H | Ext. 9"
W

Outdoor Lighting



2713NI | Seaside™
Brushed Nickel
(1), 150W, E26 (Medium) | 16"Dia. x 13.25"H
Overall Ht. 87" | Chain/Stem 72",
Add'l chain 2996
D **W** **⊗**



9044NI | Grenoble
Brushed Nickel
(1), 150W, E26 (Medium)
11"W x 8"H | Ext. 11.5"
W **⊗**



49917BK | Harbor Bay
Black | Etched Seeded
(1), 60W, E26 (Medium)
6"W x 12.25"H | Ext. 7.75"
W **⊗**



49918BK | Harbor Bay
Black | Etched Seeded
(1), 75W, E26 (Medium)
8"W x 15.75"H | Ext. 10.25"
W **⊗**



49919BK | Harbor Bay
Black | Etched Seeded
(1), 100W, E26 (Medium)
9.5"W x 18.5"H | Ext. 12"
W **⊗**



49920BK | Harbor Bay
Black | Etched Seeded
(1), 100W, E26 (Medium)
9.5"W x 20.5"H
Shown with Post 9506
W **⊗**



49892BK | Fairfield
Black | Clear Seeded
(1), 60W, E26 (Medium)
6"W x 11"H | Ext. 7"
W **⊗**



49893BK | Fairfield
Black | Clear Seeded
(1), 75W, E26 (Medium)
7.5"W x 14.5"H | Ext. 8.75"
W **⊗**



49894BK | Fairfield
Black | Clear Seeded
(1), 100W, E26 (Medium)
9"W x 17.25"H | Ext. 10.25"
W **⊗**



49895BK | Fairfield
Black | Clear Seeded
(1), 100W, E26 (Medium)
9"W x 19.25"H
Shown with Post 9506
W **⊗**



49892OZ | Fairfield
Olde Bronze® | Clear Seeded
(1), 60W, E26 (Medium)
6"W x 11"H | Ext. 7"
W **⊗**



49893OZ | Fairfield
Olde Bronze® | Clear Seeded
(1), 75W, E26 (Medium)
7.5"W x 14.5"H | Ext. 8.75"
W **⊗**



49894OZ | Fairfield
Olde Bronze® | Clear Seeded
(1), 100W, E26 (Medium)
9"W x 17.25"H | Ext. 10.25"
W **⊗**



49895OZ | Fairfield
Olde Bronze® | Clear Seeded
(1), 100W, E26 (Medium)
9"W x 19.25"H
Shown with Post 9506
W **⊗**



9032BKT | Courtyard™
Textured Black | Clear Seeded
(1), 100W, E26 (Medium)
6.25"W x 11"H | Ext. 7.25"
W



9033BKT | Courtyard™
Textured Black | Clear Seeded
(1), 150W, E26 (Medium)
8.25"W x 18"H | Ext. 11.25"
W



9034BKT | Courtyard™
Textured Black | Clear Seeded
(3), 60W, E12 (Candelabra)
10.5"W x 22.25"H | Ext. 13.5"
W



9035BKT | Courtyard™
Textured Black | Clear Seeded
(3), 60W, E12 (Candelabra)
12.25"W x 26.5"H | Ext. 16.5"
W



9532BKT | Courtyard™
Textured Black | Clear Seeded
(1), 200W, E26 (Medium)
10.25"W x 23.75"H
Shown with Post 9506
W



9533BKT | Courtyard™
Textured Black | Clear Seeded
(3), 60W, E12 (Candelabra)
12.25"W x 27"H
Shown with Post 9506
W



9538BKT | Courtyard™
Textured Black | Clear Seeded
(3), 40W, E12 (Candelabra)
12.25"W x 6.25"H
D W



9032RZ | Courtyard™
Rubbed Bronze | Clear Seeded
(1), 100W, E26 (Medium)
6.25"W x 11"H | Ext. 7.25"
W



9033RZ | Courtyard™
Rubbed Bronze | Clear Seeded
(1), 150W, E26 (Medium)
8.25"W x 18"H | Ext. 11.25"
W



9034RZ | Courtyard™
Rubbed Bronze | Clear Seeded
(3), 60W, E12 (Candelabra)
10.5"W x 22.25"H | Ext. 13.5"
W



9035RZ | Courtyard™
Rubbed Bronze | Clear Seeded
(3), 60W, E12 (Candelabra)
12.25"W x 26.5"H | Ext. 16.5"
W



9532RZ | Courtyard™
Rubbed Bronze | Clear Seeded
(1), 200W, E26 (Medium)
10.25"W x 23.75"H
Shown with Post 9506
W



9533RZ | Courtyard™
Rubbed Bronze | Clear Seeded
(3), 60W, E12 (Candelabra)
12.25"W x 27"H
Shown with Post 9506
W



9538RZ | Courtyard™
Rubbed Bronze | Clear Seeded
(3), 40W, E12 (Candelabra)
12.25"W x 6.25"H
D W

Outdoor Lighting



498400Z | Tangier
Olde Bronze® | Clear Seeded
(1), 75W, E26 (Medium)
5.75"W x 10.25"H | Ext. 6.75"
W



498410Z | Tangier
Olde Bronze® | Clear Seeded
(1), 100W, E26 (Medium)
7.5"W x 13.5"H | Ext. 8.5"
W



498420Z | Tangier
Olde Bronze® | Clear Seeded
(1), 150W, E26 (Medium)
9.5"W x 17"H | Ext. 10.5"
W



498430Z | Tangier
Olde Bronze® | Clear Seeded
(1), 150W, E26 (Medium)
9.5"W x 19.75"H
Shown with Post 9506
W



498440Z | Tangier
Olde Bronze® | Clear Seeded
(1), 150W, E26 (Medium)
9.5"W x 18.75"H
Overall Ht. 93" | Chain/Stem 72"
D





9039BK | Salisbury™
Black | White Linen
(1), 60W, E26 (Medium)
6"W x 10.5"H | Ext. 7.25"
W



9040BK | Salisbury™
Black | White Linen
(1), 100W, E26 (Medium)
8"W x 19.5"H | Ext. 11"
W



9041BK | Salisbury™
Black | White Linen
(1), 100W, E26 (Medium)
8"W x 19.25"H | Ext. 11"
W



9042BK | Salisbury™
Black | White Linen
(1), 150W, E26 (Medium)
10"W x 24.25"H | Ext. 13.5"
W



9043BK | Salisbury™
Black | White Linen
(1), 200W, E26 (Medium)
12"W x 29.25"H | Ext. 16.25"
W



9848BK | Salisbury™
Black | White Linen
(2), 60W, E26 (Medium)
13.5"W x 7.5"H
D



9938BK | Salisbury™
Black | White Linen
(1), 150W, E26 (Medium)
10"W x 21.75"H
Shown with Post 9506
W



9039RZ | Salisbury™
Rubbed Bronze | White Linen
(1), 60W, E26 (Medium)
6"W x 10.5"H | Ext. 7.25"
W



9040RZ | Salisbury™
Rubbed Bronze | White Linen
(1), 100W, E26 (Medium)
8"W x 19.5"H | Ext. 11"
W



9041RZ | Salisbury™
Rubbed Bronze | White Linen
(1), 100W, E26 (Medium)
8"W x 19.25"H | Ext. 11"
W



9042RZ | Salisbury™
Rubbed Bronze | White Linen
(1), 150W, E26 (Medium)
10"W x 24.25"H | Ext. 13.5"
W



9043RZ | Salisbury™
Rubbed Bronze | White Linen
(1), 200W, E26 (Medium)
12"W x 29.25"H | Ext. 16.25"
W



9848RZ | Salisbury™
Rubbed Bronze | White Linen
(2), 60W, E26 (Medium)
13.5"W x 7.5"H
D



9938RZ | Salisbury™
Rubbed Bronze | White Linen
(1), 150W, E26 (Medium)
10"W x 21.75"H
Shown with Post 9506
W



9708OZLED | Mount Vernon
Olde Bronze® | Clear Seeded
(1), 8W, 850lm, 2700K, 99 LPW
7.5"W x 16.75"H | Ext. 8.25"
W T24 LED



9909OZLED | Mount Vernon
Olde Bronze® | Clear Seeded
(1), 8W, 850lm, 2700K, 99 LPW
9.5"W x 20.75"H
Shown with Post 9506
W T24 LED

Outdoor Lighting



49255BK | Chesapeake™
 Black | Clear Beveled
 (1), 100W, E26 (Medium)
 6.5"W x 17"H | Ext. 7.75"
 W Ⓢ



49256BK | Chesapeake™
 Black | Clear Beveled
 (1), 100W, E26 (Medium)
 6.5"W x 18"H
 Shown with Post 5906
 W Ⓢ



9774BK | Chesapeake™
 Black | Clear Beveled
 (1), 60W, E26 (Medium)
 5.5"W x 10.25"H | Ext. 6.25"
 W Ⓢ



9776BK | Chesapeake™
 Black | Clear Beveled
 (1), 100W, E26 (Medium)
 6.5"W x 12"H | Ext. 8"
 W Ⓢ



9777BK | Chesapeake™
 Black | Clear Beveled
 (3), 60W, E12 (Candelabra)
 7.25"W x 13.75"H | Ext. 8.5"
 W Ⓢ



49255BKS | Chesapeake™
 Black | Satin Etched
 (1), 100W, E26 (Medium)
 6.5"W x 17"H | Ext. 7.75"
 W Ⓢ



9776BKS | Chesapeake™
 Black | Satin Etched
 (1), 100W, E26 (Medium)
 6.5"W x 12"H | Ext. 8"
 W Ⓢ



49255WH | Chesapeake™
 White | Clear Beveled
 (1), 100W, E26 (Medium)
 6.5"W x 17"H | Ext. 7.75"
 W Ⓢ



49256WH | Chesapeake™
 White | Clear Beveled
 (1), 100W, E26 (Medium)
 6.5"W x 18"H
 Shown with Post 5906
 W Ⓢ



9774WH | Chesapeake™
 White | Clear Beveled
 (1), 60W, E26 (Medium)
 5.5"W x 10.25"H | Ext. 6.25"
 W Ⓢ



9776WH | Chesapeake™
 White | Clear Beveled
 (1), 100W, E26 (Medium)
 6.5"W x 12"H | Ext. 8"
 W Ⓢ



9777WH | Chesapeake™
 White | Clear Beveled
 (3), 60W, E12 (Candelabra)
 7.25"W x 13.75"H | Ext. 8.5"
 W Ⓢ





9735BK | Barrie
Black | Clear Beveled
(1), 100W, E26 (Medium)
8"W x 15.5"H | Ext. 8"



9736BK | Barrie
Black | Clear Beveled
(1), 100W, E26 (Medium)
8"W x 21.75"H | Ext. 8"



9735TZ | Barrie
Tannery Bronze | Clear Beveled
(1), 100W, E26 (Medium)
8"W x 15.5"H | Ext. 8"



9736TZ | Barrie
Tannery Bronze | Clear Beveled
(1), 100W, E26 (Medium)
8"W x 21.75"H | Ext. 8"



9028BK | Kirkwood™
Black | Clear Seeded
(1), 100W, E26 (Medium)
6.5"W x 13"H | Ext. 7.5"



9029BK | Kirkwood™
Black | Clear Seeded
(1), 150W, E26 (Medium)
8.5"W x 17"H | Ext. 9.5"



9030BK | Kirkwood™
Black | Clear Seeded
(3), 60W, E12 (Candelabra)
9.75"W x 21"H | Ext. 11.5"



9918BK | Kirkwood™
Black | Clear Seeded
(3), 60W, E12 (Candelabra)
9.75"W x 23.25"H
Shown with Post 5906



9788BK | Townhouse™
Black | Clear Beveled
(1), 100W, E26 (Medium)
6.5"W x 11.75"H | Ext. 6.5"



9789BK | Townhouse™
Black | Clear Beveled
(1), 100W, E26 (Medium)
7.25"W x 15.25"H | Ext. 9"



9790BK | Townhouse™
Black | Clear Beveled
(1), 100W, E26 (Medium)
7.25"W x 21.5"H | Ext. 9.75"



9791BK | Townhouse™
Black | Clear Beveled
(1), 100W, E26 (Medium)
9.25"W x 26.75"H | Ext. 10.25"



9992BK | Townhouse™
Black | Clear Beveled
(1), 100W, E26 (Medium)
9.25"W x 24.25"H
Shown with Post 9506



49185BK | Townhouse™
Black | Clear Beveled
(3), 60W, E12 (Candelabra)
12.25"W x 31"H | Ext. 12.25"



Outdoor Lighting



9650BK | Madison
Black | Clear Beveled
(1), 100W, E26 (Medium)
8"W x 14.5"H | Ext. 8.5"
W*



9653BK | Madison
Black | Clear Beveled
(1), 100W, E26 (Medium)
8"W x 19.75"H | Ext. 8.5"
W*



9654BK | Madison
Black | Clear Beveled
(1), 150W, E26 (Medium)
9.5"W x 22.75"H | Ext. 10"
W*



9655BK | Madison
Black | Clear Beveled
(1), 100W, E26 (Medium)
9.25"W x 17"H | Ext. 10.25"
W*



9956BK | Madison
Black | Clear Beveled
(1), 150W, E26 (Medium)
9.5"W x 21.75"H
Shown with Post 9506
W*



9650TZ | Madison
Tannery Bronze | Clear Beveled
(1), 100W, E26 (Medium)
8"W x 14.5"H | Ext. 8.5"
W*



9653TZ | Madison
Tannery Bronze | Clear Beveled
(1), 100W, E26 (Medium)
8"W x 19.75"H | Ext. 8.5"
W*



9654TZ | Madison
Tannery Bronze | Clear Beveled
(1), 150W, E26 (Medium)
9.5"W x 22.75"H | Ext. 10"
W*



9655TZ | Madison
Tannery Bronze | Clear Beveled
(1), 100W, E26 (Medium)
9.25"W x 17"H | Ext. 10.25"
W*



9956TZ | Madison
Tannery Bronze | Clear Beveled
(1), 150W, E26 (Medium)
9.5"W x 21.75"H
Shown with Post 9506
W*





9618OZ
 Olde Bronze® | Clear Beveled
 (1), 100W, E26 (Medium)
 5.75"W x 10"H | Ext. 6.25"
 W



9611OZ
 Olde Bronze® | Clear
 (1), 60W, E26 (Medium)
 5"W x 8.25"H | Ext. 5.75"
 W



9611TZ
 Tannery Bronze | Clear
 (1), 60W, E26 (Medium)
 5"W x 8.25"H | Ext. 5.75"
 W



9611BK
 Black | Clear Beveled
 (1), 60W, E26 (Medium)
 5"W x 8.25"H | Ext. 5.75"
 W



9611SS
 Stainless Steel | Clear
 (1), 60W, E26 (Medium)
 5"W x 8.25"H | Ext. 5.75"
 W



9886BK
 Black | Clear
 (2), 40W, E12 (Candelabra)
 12"W x 7"H
 D



9886TZ
 Tannery Bronze | Clear
 (2), 40W, E12 (Candelabra)
 12"W x 7"H
 D



365BK
 Black | Clear
 (1), 60W, E26 (Medium)
 7.5"W x 5.25"H
 D



345BK
 Black | Clear Beveled
 (2), 60W, E26 (Medium)
 9.5"W x 5"H
 D



9322BK
 Black | Textured Clear
 (2), 60W, E26 (Medium)
 10.5"W x 5.5"H
 D



9320BK
 Black | Clear Textured
 (1), 60W, E26 (Medium)
 8.25"W x 4.75"H
 D



9320WH
 White | Clear Textured
 (1), 60W, E26 (Medium)
 8.25"W x 4.75"H
 D



9859BK
 Black | Frosted
 (1), 100W, E26 (Medium)
 7.25"W x 7.25"H
 D



9850BK | Madison
 Black | Frosted
 (2), 60W, E12 (Candelabra)
 10.75"W x 7.25"H
 D



9850TZ | Madison
 Tannery Bronze | Frosted
 (2), 60W, E12 (Candelabra)
 10.75"W x 7.25"H
 D

Outdoor Lighting



9234AZ
Architectural Bronze | Clear Seeded
(1), 65W, E26 (Medium)
4.75"W x 7"H | Ext. 7"
W L D



9236AZ
Architectural Bronze
(1), 120W, E26 (Medium)
5.75"W x 7.75"H | Ext. 8.5"
W L D



9244AZ
Architectural Bronze
(2), 65W, E26 (Medium)
4.75"W x 12"H | Ext. 7"
*Use Accessory 9534BK on Top of Fixture
D



9246AZ
Architectural Bronze
(2), 120W, E26 (Medium)
5.75"W x 15"H | Ext. 8.5"
*Use Accessory 9536BK on Top of Fixture
D



9234BA
Brushed Aluminum | Clear Beveled
(1), 65W, E26 (Medium)
4.75"W x 7"H | Ext. 7"
W L D



9244BA
Brushed Aluminum
(2), 65W, E26 (Medium)
4.75"W x 12"H | Ext. 7"
*Use Accessory 9534BK on Top of Fixture
D



9246BA
Brushed Aluminum
(2), 120W, E26 (Medium)
5.75"W x 15"H | Ext. 8.5"
*Use Accessory 9536BK on Top of Fixture
D



9234BK
Black | Clear Beveled
(1), 65W, E26 (Medium)
4.75"W x 7"H | Ext. 7"
W L D



9244BK
Black
(2), 65W, E26 (Medium)
4.75"W x 12"H | Ext. 7"
*Use Accessory 9534BK on Top of Fixture
D



9246BK
Black
(2), 120W, E26 (Medium)
5.75"W x 15"H | Ext. 8.5"
*Use Accessory 9536BK on Top of Fixture
D



9234WH
White
(1), 65W, E26 (Medium)
4.75"W x 7"H | Ext. 7"
W L D



9244WH
White
(2), 65W, E26 (Medium)
4.75"W x 12"H | Ext. 7"
*Use Accessory 9534BK on Top of Fixture
D



6052AZ
 Architectural Bronze | White Polycarbonate
 (2), 120W, E26 (Medium)
 6"W x 11.25"H
 W F

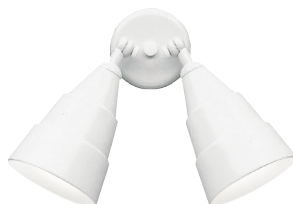

6052WH
 White | White Polycarbonate
 (2), 120W, E26 (Medium)
 6"W x 11.25"H
 W F



1148BK
 Black | Clear
 (1), 75W, E26 (Medium)
 4.5"W x 7.5"H | Ext. 5.5"
 W



43800BKT
 Xenon Address Light
 Textured Black
 (2), 5W, Wedge (Wedge Base),
 2700K
 12.25"W x 7"H | Ext. 2.5"
 D C



43800BKTLED
 LED Address Light
 Textured Black | (1), 4W, 3000K
 12.25"W x 7"H x 12.25"L | Ext.
 2.5"
 D C LED



4301
 Address Light
 Number 1 Panel
 White
 2.25"W x 5"H x 0.25"L



4302
 Address Light
 Number 2 Panel
 White
 2.25"W x 5"H x 0.25"L



4303
 Address Light
 Number 3 Panel
 White
 2.25"W x 5"H x 0.25"L



4304
 Address Light
 Number 4 Panel
 White
 2.25"W x 5"H x 0.25"L



4305
 Address Light
 Number 5 Panel
 White
 2.25"W x 5"H x 0.25"L



4306
 Address Light
 Number 6 Panel
 White
 2.25"W x 5"H x 0.25"L



4307
 Address Light
 Number 7 Panel
 White
 2.25"W x 5"H x 0.25"L



4308
 Address Light
 Number 8 Panel
 White
 2.25"W x 5"H x 0.25"L



4309
 Address Light
 Number 9 Panel
 White
 2.25"W x 5"H x 0.25"L



4300
 Address Light
 Number 0 Panel
 White
 2.25"W x 5"H x 0.25"L

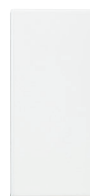

4310
 Address Light
 Full Size Blank Panel
 White
 2.25"W x 5"H x 0.25"L



4311
 Address Light
 Set Of 2 Half Size Blank
 Panels
 White
 2.25"W x 5"H x 0.25"L

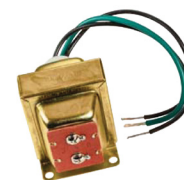

4381
 Xenon Address
 Light Transformer
 2.75"W x 2.5"H x 2"L

Reduce Energy Costs

Kichler Lighting offers many energy efficient rated fixtures that comply with 2019 Title 24, Part 6 High efficacy LED light source requirements.

As legislation changes and evolves, Kichler® makes sure our latest lineup of fixtures offer the features building owners are required to have.



Title 24 (T24)

Title 24 Building Energy Efficiency Standards are designed to reduce energy consumption by mandating that commercial building owners and homeowners use only high-efficacy lamps in both indoor and outdoor fixtures installed during new construction or remodels. The legislation has evolved to outline several requirements for these fixtures, including:

- Light sources must offer “low flicker operation” (an LED must flicker less than 30% at frequencies below 200 Hz).
- LED lamps and luminaires must provide an R9 of at least 50.
- The Color Rendering Index must be equal to or greater than 90, assuring it produces strong, vibrant reds.

California has been paving the way to reduce its greenhouse gas emissions to 1990 levels, and many additional municipalities nationwide have adopted these regulations as well. **All Kichler fixtures featuring the T24 logo meet the latest legislation requirements, including those implemented in January 2019 with JA8.**

www.energy.ca.gov/title24

www.title24express.com



The DesignLights Consortium (DLC)

The DesignLights Consortium® is a non-profit organization that promotes quality, energy-efficient commercial-sector lighting solutions. The high-performance standards of a DLC qualified product are established in collaboration with its federal, regional, state, utility, and energy efficiency program members, manufacturers, lighting designers, and other industry stakeholders throughout the US and Canada. The goal is to identify quality products and program benefits that advance the industry-wide adoption of energy solutions throughout commercial construction.

The DLC reviews:

- Non-residential fixtures not currently covered under the Energy Star program, such as: LED Luminaires like outdoor pole, bollards, landscape accent and flood, wall wash and garage canopies.
- Commercial lighting for industry applications like: roadways and parking garages – primarily outdoor, high-voltage applications
- 3rd party data to ensure fixtures meet stringent output, efficacy, CCT, CRI and warranty standards

www.designlights.org



The Energy Star® program is being phased by the EPA for all lamps and luminaires, with the exception of downlights, by the end of 2024.



illuminating Engineering Society Of North America (iesna) Lm-79-2008

IESNA developed a standardized industry test conducted on all LED light fixtures and light sources to provide universally consistent data that is translated for the benefit of end users. The test measures qualities such as lumens, energy consumed, CRI and color temperature – resulting in an IES file/report. It allows for a true comparison of energy efficiency regardless of the light source and serves as the primary source of data when creating Lighting Facts® labels. IES files are then also utilized by the design community to plot accurate light distribution throughout their plans.

www.ies.org



LEED®

The LEED® (Leadership in Energy & Environmental Design) certification program from the U.S. Green Building Council has become the benchmark for architects, real estate professionals, facility managers, engineers, interior designers, landscape architects, construction managers and government officials who want to design, construct and operate more sustainable buildings. The third-party certification process assigns LEED® points for products and processes used that promote green practices related to site development, water savings, energy efficiency, materials selection and indoor environmental quality.

There are a limited number of possible points available, with a tiered system that certifies buildings with a Platinum, Gold, Silver or Certified status based on points earned. According to leed.usgbc.org/leed, from 2015-2018 LEED-certified buildings are estimated to generate as much as \$1.2 billion in energy savings and \$715.3 million in maintenance. The right lighting can contribute to earning LEED points in new construction.

www.iccsafe.org



ICC

The International Code Council is a member-focused association. It is dedicated to developing model codes and standards used in the design, build and compliance process to construct safe, sustainable, affordable and resilient structures. Most U.S. communities and many global markets follow the International Codes, or I-Codes, published by ICC. The I-Codes are a complete set of comprehensive, coordinated building safety and fire prevention codes that provide minimum safeguards for people at home, at school and in the workplace. For instance, when a light fixture is to be placed in a ceiling filled with insulation, it requires an insulated contact (IC) rating to assure the fixture can be covered with insulation.

www.USGBC.org/leed



FCC

Part 15 of the FCC regulations addresses the Radio Frequency (RF) of LED lighting products to ensure that devices do not cause harmful interference to radio-communications services. In most cases, the driver paired with LED lighting devices operates at RF frequencies similar to those used in digital electronic products. LED fixtures are then subject to the “Verification” or “Certification” equipment authorization procedures. The testing limits radiated emission from 30 MHz to 1000 MHz to ensure overall compliance with radiated emissions requirements. Manufacturers are required to design to these standards, as well as keep validated test reports on file. Wireless or “intentional” devices require reporting be submitted through the FCC.

www.fcc.gov



International Dark Sky Association (IDA)

IDA’s Fixture Seal of Approval program certifies outdoor lighting fixtures as being Dark Sky Friendly, meaning that they minimize glare while reducing light trespass and sky glow. Dark Sky friendly fixtures are designed to reduce light pollution by directing the light down and out, not up. To earn the seal of approval, products are required to be fully shielded and to minimize the amount of blue light in the nighttime environment.

www.darksky.org



ADA Compliant

The Americans with Disabilities Act is a federal anti-discrimination statute designed to ensure equal access to opportunities and benefits for qualified individuals with disabilities. The act seeks to remove barriers to the enjoyment of programs and employment opportunities, independent living, and economical self-sufficiency enjoyed by those without disabilities. The American with Disabilities Act (ADA) limits wall-mounted luminaires to four inches in depth when located between 27 inches and 84 inches from the finished floor level of walks, halls, corridors, passageways, or aisles. Many Kichler Lighting sconces meet this requirement at any mounting height.

www.ada.gov

Navigating the Light

Color	<p>COLOR CORRELATED TEMPERATURE (CCT)</p> <p>Also referred to as Color Temperature and displayed as Kelvin Temperature</p>	<p>Kelvin Temperature (K) indicates the color of the light source or the color you are getting from an LED fixture</p> <ul style="list-style-type: none"> • 2700K is a warmer light, closer to incandescent • 3000K trends warm, but optically closer to a pure white • 4000K trends cooler, but perceived as a bright white • 5000K is cool, perceived often as having a blue hue
	<p>COLOR RENDERING INDEX (CRI)</p> <p>Particularly of importance indoors where there is less natural light</p>	<p>CRI reflects the color that the light brings out of objects</p> <ul style="list-style-type: none"> • 90+ CRI results in a more vibrant and “true” color • A lower CRI (<80) would make seemingly colorful objects appear dull and unappealing.
Brightness	<p>LUMENS (LM)</p> <p>Reflect the amount of light from a fixture</p>	<ul style="list-style-type: none"> • The higher the lumens, the more light you are getting • Lumens in the lower 100s (<550) typically work best for accent or niche lighting • 550 to 850 lumens give light levels equivalent to traditional 40W or 60W incandescent bulbs respectively, and are ideal for downlighting • 850 to 2000 lumens typically work best in spaces with average ceiling height (9' to 12') • 3000 to 5000 lumens are typically best for larger spaces, vaulted ceilings, and more task driven applications that require significant light
Light Delivery	<p>DELIVERED LUMENS</p>	<p>You may see delivered lumens throughout this catalog as we work diligently to provide that level of data</p> <ul style="list-style-type: none"> • Source lumens = the brightness at the source • Delivered lumens = the brightness recognized closer to eye level, or the level in which the light has the most impact in a space
	<p>BEAM SPREAD</p>	<p>Beam spread is an excellent indicator of how wide the light is being dispersed</p> <ul style="list-style-type: none"> • Lower beam spread (60–80 degrees) is indicative of a thinner stream of light—similar to that of a flash light. This is often preferred for task lighting as it offers a stronger stream of light down to the task at hand. • Higher beam spread (100+) is wider—best suited for ambient or general purpose lighting across a room. The light is dispersed broadly, but has less strength as it goes down.
Efficacy	<p>LUMENS PER WATT (LPW)</p>	<p>LPW reflects how many lumens you get per watt—which is a sign of efficiency. Energy Star® standards for indoor fixtures vary based on size and watt criteria:</p> <ul style="list-style-type: none"> • > 50 LPW for all lamp types below 30 total listed lamp watts • > 60 LPW for all lamp types that are < 24 inches and > 30 total listed lamp watts • > 70 LPW for all lamp types that are > 24 inches and > 30 total listed lamp watts



Bring it all together.



1

Low-Profile LED
Downlight 3000K
(43846WHLED30)



2

4U Series LED 12"
Under Cabinet 3000K
(4U30K12BZT, 6UCORDBK)



3

Shailene
Wall Sconce
(45572NI)



4

Shailene
Mini Chandelier
(43670NI)

Index

10174 BK, WH.....	153	11150 NILED	69	1TEK1DWSF4SIL	148
10176 BK, WH	153	11151 NILED	69	1TEK1DWSF8SIL	148
10189 BK, 9WH.....	153	11250 AZT30, BKT30	172	1TEK1STRC2SIL	150
10301 WHLED	51	11251 AZT30, BKT30	172	1TEK1STRC4SIL	150
10303 WH, WHLED	51	11253 NILED	69	1TEK1STRC8SIL	150
10315 WH, WHLED.....	51	11254 NILED.....	69	1TEK1STSF2SIL.....	148
10421 SNLED	61	11255 NILED	69	1TEK1STSF4SIL.....	148
10438 NCHLED	61	11301 NILED	98	1TEK1STSF8SIL.....	148
10439 NCHLED	61	11302 CPLED, NILED.....	50	1TEK1SWRC2SIL	150
10570 BK, WH.....	124	11303 CPLED, NILED.....	50	1TEK1SWRC4SIL	150
10571 BK, WH	124	11304 NILED.....	51	1TEK1SWRC8SIL	150
10572 BK, WH.....	124	11305 NILED	98	1TEK1SWSF2SIL.....	148
10573 BK, WH.....	124	11309 BKTLED	172	1TEK1SWSF4SIL.....	148
10620 NILED	61	11310 BKTLED	172	1TEK1SWSF8SIL.....	148
10630 PNLED	61	11314 NILED	98	1TEL0018CLR.....	149 - 152
10755 WHLED	51	11315 NILED, OZLED	60	1TEL0018WHO	151, 152
10760 WHLED	51	11319 NILED, OZLED	61	1TEL3018CLR.....	149 - 152
10761 WHLED	51	11320 BKTLED	172	1TE LH018WHO	149, 152
10763 NILED	50	1148 BK	195	1TEM145SFSCLR	149
10764 NILED	50	1896 NI.....	29	1TEM1DWSFSCLR	149
10765 NILED	50	1897 NI.....	29	1TEM1STSFMCLR	149
10766 WHLED	51	1TBTT1CLR	136	1TEM1SWSFMCLR	149
10767 WHLED	51	1TBTW1CLR	136	2019 NI.....	20
10768 WHLED	51	1TBTWSCLR	136	2020 AB, NI, TZ.....	20
10769 NILED, OZLED	48	1TEC145SF8SIL	149	2021 NI, TZ.....	20
10784 NILED, OZLED	48	1TEC1DWRC8SIL.....	151	2031 NI, TZ.....	20
10786 NILED, OZLED	48	1TEC1DWSF8SIL	149	206 NI, WH	59
10788 NILED, OZLED	48	1TEC1STRC8SIL	151	208 WH	59
10789 NILED, OZLED	48	1TEC1STSF8SIL.....	149	209 NI, OZ, WH	59
10790 NILED, OZLED	61	1TEC1SWRC8SIL	151	2093 NI, OZ.....	16
10795 NILED.....	61	1TEC1SWSF8SIL	149	216 WH	59
10797 NILED	61	1TEE145SFSSIL	149	2520 NI.....	20
10798 NILED.....	68	1TEE1DWSFSSIL	149, 151	2664 OZ, PN	103
10799 NILED	68	1TEE1STSFHSIL	149	2665 OZ, PN.....	114
10800 NILED	68	1TEE1STSFSSIL	149, 151	2666 OZ, PN	114
10885 NILED	50	1TEE1SWSFHSIL	149	2693 NI, OZ.....	16, 107
10886 NILED	50	1TEE1SWSFSSIL	149, 151	2713 NI	186
11132 AZTLED	172	1TEK145SF2SIL.....	148	2771 NI, TZ	20, 107
11142 NILED	69	1TEK145SF4SIL.....	148	300103 OBB, WH.....	162
11143 NILED	69	1TEK145SF8SIL.....	148	300117 OBB, WH.....	161
11146 NILED	69	1TEK1DWRC2SIL.....	150	300206 BAP, TZ.....	161
11147 NILED	69	1TEK1DWRC4SIL.....	150	300230 NI, WH.....	158
11148 NILED	69	1TEK1DWRC8SIL.....	150	300375 NI, SBK, WH	160
11149 NILED	69	1TEK1DWSF2SIL	148	3122 NI	54

3293 NI.....	16	42140 BK, NBR, NI.....	115	4307.....	195
3299 NI.....	29, 117	42141 BK, BKCS, CHCLR, CHCS, NBR, NBRCS, NI, NICS.....	108-111	4308.....	195
330000 NI, OZ, PN, SBK.....	158	42141 OZCLR, OZCS.....	111	4309.....	195
330001 BSS, MWH, SBK.....	159	42196 BK, CLZ, NI, OZ.....	116	4310.....	195
330002 NI, SBK, WH.....	159	42199 BK, BKCS, CH, CHCS, NBR, NBRCS, NI, NICS, OZ, OZCS... 108-111		4311.....	195
330015 MWH, SBK, SNB, WH.....	165	42200 BK, BKCS, CH, CHCS, NBR, NBRCS, NI, NICS, OZ, OZCS... 108-111		43594 BK.....	111
330016 MWH, NI, NIS, SBK, SBKS, SNB, SNBS, WH.....	164	42296 BK, NBR, NI, OZ.....	57	43597 BK.....	103
330017 MWH, NI, SBK, SNB, WH.....	164	42372 NILED.....	60	43637 NI, OZ.....	19
330018 MWH, NI, SBK, SNB, WH.....	165	42379 BKLEDR, NILED, OZLEDR.....	50	43638 NI, OZ.....	19
330019 MWH, SBK, SNB, WH.....	164	42380 NILED.....	50	43639 NI, OZ.....	19
330020 MWH, NI, SBK, SNB, WH.....	165	42456 BKCS, CHCLR, CHCS NBR, NBRCS, NI, NICS, OZCLR, OZCS.....	108-111	43640 NI, NIL18, OZ, OZL18.....	19, 99
330060 NI, OZ, PN, SBK.....	158	42475 CHCLR Everly™.....	110	43641 NI, OZ, NIL18, OZL18.....	19, 52
330160 BSS, MWH, OBB, SBK.....	163	42496 NBR, NI, OZ.....	31, 115	43664 NI, OZ.....	23
330161 BSS, MWH, OBB, SBK.....	162	42497 NBR, NI, OZ.....	31	43665 NI, OZ.....	23
330162 BSS, MWH, OBB, SBK.....	162	42498 NBR, NI, OZ.....	31	43666 NI, OZ.....	23
330163 MWH, NI, SBK, SNB.....	162	42499 NBR, NI, OZ.....	31, 115	43668 NI, NIL18, OZ, OZL18.....	23, 99
330164 BSS, MWH, OBB, SBK.....	163	42565 BK, NI, OZ™.....	104	43669 NI, NIL18, OZ, OZL18.....	23, 52
330165 MWH, NI, SBK, SNB.....	165	42588 NI, OZ.....	100	43670 NI, NICS, OZ, OZCS, NBR, NBRCS, BK, BKCS.....	22
330171 MWH, NBR NI, SBK.....	160	42649 OZ.....	114	43671 NI, NICS, NBR, NBRCS, BK, BKCS.....	22
330174 MWH, NBR NI, OZ, PN, SBK... 160		42798 NI.....	103	43672 NI, NICS, OZ, OZCS, NBR, NBRCS, BK, BKCS.....	22
330180 MWH, NI, SBK.....	160	42869 NI, OZ.....	112	43674 NI, NICS, OZ, OZCS, NBR, NBRCS, BK, BKCS.....	22, 106
330241 MWH, NI, SBK.....	159	42877 NI, OZ.....	112	43675 NI, NICS, OZ, OZCS, NBR, NBRCS, BK, BKCS.....	22, 56
330242 MWH, NI, SBK.....	159	42878 NI, OZ.....	103	43691 NI, NICS, OZ, OZCS, NBR, NBRCS, BK, BKCS.....	22, 56
330243 MWH, NI, SBK.....	158	42879 NI.....	24, 54	43692 NI, NICS, OZ, OZCS, NBR, NBRCS, BK, BKCS.....	22, 56
345 BK.....	193	42880 NI.....	24, 107	43693 NI, NICS, OZ, OZCS, NBR, NBRCS, BK, BKCS.....	22, 56
3497 NI.....	29, 105	42881 NI.....	24, 117	43800 BKT, BKTLED.....	195
3502 NI, TZ.....	20, 117	42882 NI.....	24, 117	4381.....	195
3623 NI.....	20, 54	42884 NI.....	24	43846WHLED27.....	35
3627 NI.....	54	42890 NI, OZ.....	112	43846WHLED27B.....	35
365 BK.....	193	4300.....	195	43846WHLED30.....	35
3694 NI, OZ.....	16, 54	4301.....	195	43846WHLED30B.....	35
370005WHTR.....	166	4302.....	195	43846WHLED40.....	35
371042MUL ALM, IV, WH.....	166	4303.....	195	43848OZLED27T.....	35
371045MUL ALM, IV, WH.....	166	43034 DAG.....	29	43848OZLED30T.....	35
371062MULTR.....	166	43035 DAG.....	29	43848WHLED27T.....	35
371082 WH.....	166	43036 DAG.....	29	43848WHLED30T.....	35
371085 ALM, IV, WH.....	166	43037 DAG.....	29	43848WHLED30TB.....	35
3797 NI.....	29, 54	4304.....	195		
41011 BK, CH, CPZ, NI, OZ.....	97	4305.....	195		
4145LED.....	35	4306.....	195		
4146LED.....	35				
42121 BK, CLZ, NI, OZ.....	116				
42122 BK, CLZ, NI, OZ.....	116				

Index

43848WHLED40T	35	44045 AUB	30, 103	45574 CH, CHCLR, NI, NICLR, OZ, OZCLR, NBR, NBRCLR, BK, BKCLR	22, 79-81
43849WH5CCT	34	44046 AUB	30	45575 CH, CHCLR, NI, NICLR, OZ, OZCLR, NBR, NBRCLR, BK, BKCLR	22, 79-81
43849WH5CCTB	34	44053 NI	105	45637 CH, NI, OZ, CHL18, NIL18, OZL18°	19, 62
43850 BK, CH, NBR, NI, OZ	100-102	44244NILED30	38	45638 CH, NI, OZ, CHL18, NIL18, OZL18	19, 74
43851 BK, CH, NBR NI, OZ	100-102	44244WHLED30	38	45639 CH, NI, OZ, CHL18, NIL18, OZL18	19, 74
43852 BK, NBR, NI, OZ	100-102	44246NILED30	38	45640 CH, NI, OZ, CHL18, NIL18, OZL18	19, 74
43853 BK, CH, NBR, NI, OZ	102	44246NILED40	38	45656 CHLED, MBKLED, NILED	60
43873WHLED27	37	44246WHLED30	38	45657 CHLED, MBKLED, NILED	67
43873WHLED27B	37	44248NILED30	39	45658 CHLED, MBKLED, NILED	67
43873WHLED27B	37	44248NILED40	39	45685 NBRLED, PNLED	68
43873WHLED30	37	44248WHLED30	39	45686 NBRLED, PNLED	60
43874WH5CCT	36	44249NILED30	39	45801 CHLED	68
43874WH5CCTB	36	44249WHLED30	39	45838 CHLED, OZLED	68
43878WHLED27	35	44377 NI, NICS, BK, BKCS	25	45839 CHLED, OZLED	68
43878WHLED30	35	44378 NI, NICS, BK, BKCS	25	45881 NI	24, 65
43905 BK, NBR, NI, OZ	102	44379 NI, BK	25	45882 NI	24, 89
43906 BK, NBR, NI, OZ	102	44380 NI, NICS, BK, BKCS	25, 105	45883 NI	24, 89
43911 BK, NBR, NI, OZ	102	44381 NI, NICS, BK, BKCS	25, 63	45884 NI	24, 89
43912 BK, NBR, NI, OZ	102	45128 NI, NICS, BK, BKCS	25, 88	45885 NI, OZ, NBR, BK	18, 83
43922 NI, OZ	26	45129 NI, NICS, BK, BKCS	25, 88	45886 NI, OZ, NBR, BK	18, 83
43923 NI, OZ	26	45130 NI, NICS, BK, BKCS	25, 88	45887 NI, OZ, NBR, BK	18, 83
43924 NI, OZ	26	45375 NI, NIL18, OZ, OZL18	72	45892 NI, OZ	65
43925 NI, NIL18, OZ, OZL18	26, 52	45376 NI, NIL18, OZ, OZL18	72	45893 NI, OZ	86
43926 NI, OZ, NIL18, OZL18	26, 52	45377 NI, NIL18, OZ, OZL18	72	45894 NI, OZ	86
43927 NI, OZ, NIL18, OZL18	26, 99	45495 CH, CHCLR, NI, NICLR, OZ, OZCLR, NBR, NBRCLR, BK, BKCLR	28, 62-63	45895 NI, OZ	86
43953 NI, OZ	107	45496 CH, CHCLR, NI, NICLR, OZ, OZCLR, NBR, NBRCLR, BK, BKCLR	28, 75-77	45910 NI, OZ, NBR, BK	18, 64
43954 NI, OZ	107	45497 CH, CHCLR, NI, NICLR, OZ, OZCLR, NBR, NBRCLR, BK, BKCLR	28, 75-77	45921 NI, OZ, NIL18, OZL18	26, 62
43955 NI, OZ	107	45498 CH, CHCLR, NI, NICLR, OZ, OZCLR, NBR, NBRCLR, BK, BKCLR	28, 75-77	45922 NI, OZ, NIL18, OZL18	26, 73
43982 BK	111	45568 NI, OZ, NIL18, OZL18	23, 62	45923 NI, OZ, NIL18, OZL18	26, 73
43984 BK	111	45569 NI, OZ, NIL18, OZL18	23, 71	45924 NI, OZ, NIL18, OZL18	26, 73
43995 CH, NI, OZ, NBR, BK	28	45570 NI, OZ, NIL18, OZL18	23, 71	45971 BK, NBR, NI, OZ	65
43996 CH, NI, OZ, NBR, BK	28, 104	45571 NI, OZ, NIL18, OZL18	23, 71	45972 BK, NBR, NI, OZ	87
43997 CH, NI, OZ, NBR, BK	28	45572 CH, CHCLR, NI, NICLR, OZ, OZCLR, NBR, NBRCLR, BK, BKCLR	22, 63-64	45973 BK, NBR, NI, OZ	87
43998 CH, NI, OZ, NBR, BK	28, 114	45573 CH, CHCLR, NI, NICLR, OZ, OZCLR, NBR, NBRCLR, BK, BKCLR	22, 79-81	49183 BK, BKL18, TZ, TZL18	174
43999 CH, NI, OZ, NBR, BK	28			49185 BK	191
44029 NI, OZ, NBR, BK	18			49186 BK, BKL18, TZ, TZL18	174
44030 NI, OZ, NBR, BK	18				
44031 NI, OZ, NBR, BK	18				
44032 NI, OZ, NBR, BK	18, 105				
44033 NI, OZ, NBR, BK	18, 57				
44034 NI, OZ, NBR, BK	18				
44035 NI, OZ, NBR, BK	18				
44043 AUB	30				
44044 AUB	30				

49187 BK, BKL18, TZ, TZL18.....	174	49909 RZ	180	5017 CH, NI	92
49255 BK, BKS, WH	190	49910 RZ	180	5018 CH, NI	92
49256 BK, WH	190	49911 RZ	180	5019 CH, NI	92
49278 AZTLED, BKLED, PLLED	171	49917 BK.....	186	5096 NI	29, 63
49279 AZTLED, BKLED, PLLED	171	49918 BK	186	5097 CH, NI, CHL18, NIL18	29, 70
49444 AZ, BA	182	49919 BK	186	5098 CH, NI, CHL18, NIL18.....	29, 70
49445 AZ, BA	182	49920 BK.....	186	5099 CH, NI, CHL18, NIL18	29, 70
49475 RZ	177	49924 BKT, OZ	179	52152 BK, NBR, WH	113
49476 RZ	177	49925 BKT, OZ	179	52153 BK, NBR, WH	113
49496 AZ, BA	182	49926 BKT, OZ	179	52176 BK, NBR, WH	113
49550 AZLED, BKTLED.....	172	49927 BKT, OZ	179	52177 BK, NBR, WH	112
49551 AZLED, BKTLED.....	172	49960 AVI	182	52383 NI, OZ, BK.....	27
49557 AZLED, BKLED.....	170	49961 AVI	182	52384 NI, OZ, BK.....	27
49558 AZLE, BKLED	170	49962 AVI.....	182	52385 NI, OZ, BK	27
49607 AZTLED, BKTLED	171	49963 AVI	182	52386 NI, OZ, BK	27
49608 AZTLED, BKTLED.....	171	49965 AVI.....	182	52388 NI, OZ, BK	27
49686 BK, OZ	176	49980 BKT, OZ, WH	184	52435 NI, OZ, BK.....	17
49687 BK, OZ.....	176	49981 BKT, OZ, WH	184	52436 NI, OZ, BK.....	17
49688 BK, OZ	176	49982 BKT, OZ, WH	184	52437 NI, OZ, BK.....	17, 65
49690 BK, OZ	176	49990 BK, OZ	183	52442 NI, OZ, BK.....	17
49775 BK	184	49991 BK, OZ.....	183	52443 NI, OZ, BK	17
49776 BK	184	49992 BK, OZ	183	52444 NI, OZ, BK.....	17, 106
49829 BKT, OZ, WH	178	49993 BK, OZ	183	52445 NI, OZ, BK	17, 65
49830 BKT, OZ, WH	178	4D12V27WHT	138	52616 NI, OZ, NBR, BK	18
49831 BKT, OZ, WH	178	4D12V30WHT	138	52716 NI, CPZ, BK.....	21
49832 BKT, OZ, WH	178	4DD12V040 WH	141	52717 NI, CPZ, BK.....	21
49834 BKT, OZ, WH	179	4DD12V060 WH.....	141	52718 NI, CPZ, BK.....	21
49836 BK.....	183	4T1100H30 WH.....	134	52719 NI, CPZ, BK.....	21
49837 BK	183	4T1100S30 WH.....	134	52720 NI, CPZ, BK.....	21
49840 OZ	188	4T116H27 WH.....	134	52721 NI, CPZ, BK.....	21
49841 OZ	188	4T116H30 WH	134	52722 NI, CPZ, BK	21
49842 OZ	188	4T116S27 WH	134	52723 NI, CPZ, BK	21
49843 OZ.....	188	4T116S30 WH.....	134	52724 NI, CPZ, BK	21
49844 OZ	188	4TD12V060 BKT V2.....	140	52725 NI, CPZ, CH, BK	21, 104
49857 BKT	182	4TD12V40 BKT	140	53005WH30	40
49858 BKT	182	4U27K08 BZT, WH.....	122	53007WH30	40
49859 BKT	182	4U27K12 BZT, WH.....	122	53007WH30B	40
49860 BKT.....	182	4U27K22 BZT, WH	122	53009WH30	40
49861 BKT	182	4U27K30 BZT, WH.....	122	53011WH30.....	40
49892 BK, OZ	186	4U30K08 BZT, WH.....	123	53011WH30B.....	40
49893 BK, OZ	186	4U30K12 BZT, WH.....	123	5336 CHS, NIS, TZS	90
49894 BK, OZ	186	4U30K22 BZT, WH.....	123	5337 CHS, NIS, TZS	90
49895 BK, OZ	186	4U30K30 BZT, WH.....	123	5338 CHS, NIS, TZS	91
49908 RZ	180	5003 CH, NI	92	5339 CHS, NIS, TZS	91

Index

55085 NI, OZ, BK	27, 63	625 CH, NI	93	8116 BK, NI, OZ	58
55086 NI, OZ, BK	27, 78	626 CH, NI	93	8206 NI	59
55087 NI, OZ, BK	27, 78	628 CH, NI	93	8209 NI	59
55088 NI, OZ, BK	27, 78	6322 NI	20, 89	83261	98
55120 NI, OZ, BK	17, 85	6323 NI	20, 89	83454	98
55121 NI, OZ, BK	17, 85	6324 NI	20, 89	83455	98
55122 NI, OZ, BK	17, 85	6520 NI	65	83736	67
55125 NI, OZ, BK	17, 84	6719 NI	20, 65	83737	67
55126 NI, OZ, BK	17, 84	6D24V27 WHT	138	83742	66
55127 NI, OZ, BK	17, 84	6D24V30 BKT, WHT	138	83743	66
55183 NI, CPZ, CH, BK	21, 64	6DD24V060 WH	141	83745	60
55184 NI, CPZ, CH, BK	21, 82	6DD24V100 WH	141	83756	66
55185 NI, CPZ, CH, BK	21, 82	6T1100H27 WH	132	83757	60
55186 NI, CPZ, CH, BK	21, 82	6T1100H30 WH	132	83758	66
59016 BK	179	6T1100H50 WH	132	83759	66
59017 BK	179	6T1100S27 WH	132	83791	98
59018 BK	179	6T1100S30 WH	132	83792	60
59019 BK	179	6T1100S50 WH	132	83793	60
59098 BA, BK	176	6T110H27 WH	132	83837	60
59099 BA, BK	176	6T110H30 WH	132	83838	66
59100 BA, BK	176	6T110S27 WH	132	83943	66
59101 BA, BK	176	6T110S30 WH	132	83944	60
59104 BK, OZ	180	6T116S27 WH	132	83992	94
59105 BK, OZ	180	6T116S30 WH	132	83993	94
59106 BK, OZ	180	6T116S50 WH	132	83994	96
59107 BK, OZ	180	6T120H27 WH	132	83995	96
59111 BKT, OZ	175	6T120H30 WH	132	83996	96
59112 BKT, OZ	175	6TD24V060 BKT V2	140	83997	94
59113 BKT, OZ	175	6TD24V096 BKT V2	140	83998	94
59114 BKT, OZ	175	6TD24V10 BKT	140	84003	94
59115 BKT, OZ	175	6TD24V40 BKT	140	8405 NI	54
59123 BKT	177	6UCORD BK, WH	124	8406 NI	54
59124 BKT	177	6UCSK08 WHT	120	84129	66
59137 BKT	177	6UCSK12 WHT	120	84167	96
59138 BKT	177	6UCSK22 WHT	120	84168	96
59143 BKT	170	6UCSK30 WHT	120	84169	96
59144 BKT	170	7260 WH	59	84171	96
59145 BKT	170	8064 NI, TZ	20, 57	84173	96
6052 AZ, WH	195	8065 NI	20, 57	84186	60
6122 CH, NI	90	8108 NI, TZ	57	84187	67
6123 CH, NI	90	8109 NI, TZ	57	86008	94
6124 CH, NI	90	8110 NI, TZ	58	8653 NI	58
623 CH, NI	93	8111 BK, NI, OZ	58	8880 NI	59
624 CH, NI	93	8112 BK, CH, NI, OZ	58	8881 NI	59

8882 NI	59	9236 AZ	194	DLMG02R2790 WHT	46
8T1010H27 WH	131	9244 AZ, BA, BK, WH	194	DLMG02R3090 WHT	46
8T1010H30 WH	131	9246 AZ, BA, BK	194	DLMN02R2790 WHT	46
8T1010S27 WH	130	9320 BK, WH	193	DLMN02R3090 WHT	46
8T1010S30 WH	130	9322 BK, BKT	187	DLRC04R2790 WHT	44
8T1010U30 WH	131	9532 RZ	187	DLRC04R3090 WHT	44
8T1033H27 WH	131	9533 BKT, RZ	187	DLRC04S2790 WHT	45
8T1033H30 WH	131	9538 BKT, RZ	187	DLRC04S3090 WHT	45
8T1067S27 WH	130	9611 BK, OZ, SS, TZ	193	DLRC06R2790 WHT	44
8T1067S30 WH	130	9618 OZ	193	DLRC06R3090 WHT	44
8T1100H27 WH	131	9650 BK, TZ	192	DLRC06S2790 WHT	45
8T1100H30 WH	131	9653 BK, TZ	192	DLRC06S3090 WHT	45
8T1100H40 WH	131	9654 BK, TZ	192	DLRP01ST	47
8T1100S27 WH	130	9655 BK, TZ	192	DLRP02ST	47
8T1100S30 WH	130	9708 OZLED	189	DLSL03R2790 WHT	41
8T1100S40 WH	130	9735 BK, TZ	191	DLSL03R3090 WHT	41
8T11TTF1 WH	136	9736 BK, TZ	191	DLSL04R2790 WHT	41
8T11TTF2 WH	136	9774 BK, WH	190	DLSL04R3090 WHT	41
8T11TTR1 WH	136	9776 BK, BKS, WH	190	DLSL04S2790 WHT	42
8T11TWF1 WH	136	9777 BK, WH	190	DLSL04S3090 WHT	42
8T11TWR1 WH	136	9788 BK	191	DLSL05R2790 WHT	41
8T11TWRS WH	136	9789 BK	191	DLSL05R3090 WHT	41
8TD24V060 BKT	140	9790 BK	191	DLSL06R2790 WHT	42
8TD24V060 BKT	155	9791 BK	191	DLSL06R3090 WHT	42
8TD24V090 BKT	140	9794 BK, BKL18, TZ, TZL18	174	DLSL06S2790 WHT	43
8TD24V090 BKT	155	9848 BK, RZ	189	DLSL06S3090 WHT	43
9021 BK, NI, OZ	185	9850 BK, TZ	193	DLTRC04R BKT	47
9022 OB, BK, NI, OZ, WH	185	9859 BK	193	DLTRC06R BKT	47
9023 OB, BK, NI, OZ	185	9886 BK, TZ	193	DLTSL03R BKT	47
9028 BK	191	9909 OZLED	189	DLTSL04R BKT, NBR	47
9029 BK	191	9918 BK	191	DLTSL04S BKT	47
9030 BK	191	9938 BK, RZ	189	DLTSL05R BKT	47
9032 BKT, RZ	187	9956 BK, TZ	192	DLTSL06R BKT, NBR	47
9033 BKT, RZ	187	9992 BK	191	DLTSL06S BKT	47
9034 BKT, RZ	187	DLE06 WH	47		
9035 BKT, RZ	187	DLE10 WH	47		
9039 BK, RZ	189	DLE20 WH	47		
9040 BK, RZ	189	DLGR01 WH	47		
9041 BK, RZ	189	DLGR02 WH	47		
9042 BK, RZ	189	DLGR03 WH	47		
9043 BK, RZ	189	DLGR05 WH	47		
9044 NI	186	DLGR06A WH	47		
9142 BK, NI, OZ	185	DLGR06B WH	47		
9234 AZ, BA, BK, WH	194	DLGR07 WH	47		











Legend

- CLR Clear
- CRI Color Rendering Index
- Chain/Stem..... Length of chain or stem supplied with fixture
- D..... Diameter
- Ext..... Extension
- H Height
- K..... Kelvin temperature
- L Length
- LED Light Emitting Diode
- LPW Lumens per Watt
- Overall Ht..... Overall Height
- W..... Width, when paired with L and/or H
- W..... Watts, when directly next to a number







* Kichler Lighting products are not produced or associated with any Native American Indians, nor are they a Native American product or the product of a particular Indian, Indian tribe or Indian arts and crafts organization as defined by 25 U.S.C. §305 et. seq.

Symbol Guide

FIXTURE

-  Damp
-  Wet
-  Climates™
-  Mounts Up or Down
-  Mounts Horizontal or Vertical
-  Mounts Ceiling or Wall
-  IDA Dark Sky Approved
-  2019 Title 24, Part 6 is a document that contains the California Building Energy Efficiency Standards for Residential and Nonresidential Buildings as regulated by the California Energy Commission. Products marked with this logo and labeled as JA8-2019 or JA8-2019-E have been found to meet the requirements stated in 2019 Title 24, Part 6. For more information, visit www.energy.ca.gov/title24.
-  ADA Compliant
-  DC Motor

LIGHT SOURCE

-  Dimmable
-  Integrated LED
-  LED Energy Efficient Bulb Included. Option to purchase specific fixtures that come packaged with compatible LED bulbs
-  LED Bulb Required
-  Fixture requires supply wire rated for at least 75° C
-  Fixture requires supply wire rated for at least 90° C

- Bulbs not included unless otherwise noted.
- Wattages stated are the maximum allowed; however, you may use lower wattage lamps to suit your lighting needs. Some recommended lamps are not available in the maximum allowable wattage.
- All electrical products are rated as 120-volt, AC unless otherwise noted.
- All electrical products are certified and listed to UL/CSA Standards for use in U.S.A. and Canada except where noted.
- All chain drop products equipped with at least 72" of chain unless otherwise noted.
- All products featured in the outdoor section are certified and listed to UL/CSA standards for wet location except where noted.
- Many long-life tungsten halogen capsule lamps are now available as alternates to conventional incandescent light bulbs. The halogen capsule lamps may be used to replace any lamp of a higher wattage, but not to exceed the existing specified maximum wattage, i.e., 72W may replace a 75W.
- On some products, in order to accommodate higher-than-normal ceiling height, extra lead wire is supplied and specified. With additional sections of chain or stems (not included), this allows an added measure of design flexibility.
- Finishes for fixtures installed outdoors are subject to change due to prolonged exposure to sunlight, airborne pollutants, and other forms of weathering.
- To serve you better, Kichler Lighting reserves the right to make improvements to the products in this catalog. Therefore, some products may change during the life of the catalog and the product information contained in this catalog may also have changed.

Consumer Notice

Reese's Law was enacted in October of 2023 with the purpose of reducing the risk of injury from ingestion of button cell or coin batteries by children six years old and younger. Consumer Products using button cell or coin batteries are required to meet their corresponding test standards and shall carry all required markings moving forward. Kichler Lighting is committed to ensuring our products, packaging, and instruction sheets meet these requirements.

For additional information regarding this regulation, please visit: www.ecfr.gov/current/title-16/chapter-II/subchapter-B/part-1263

General Service Lamp (GLS) energy conservation standards became effective in 2023, including an expanded definition of lamps that are now considered general service. With this ruling, the U.S. Department of Energy codified the Code of Federal Regulations to include a 45 lumens per watt (lm/W) efficiency requirement for all GLS lamps moving forward.

For more information on this regulation and the expanded definition of General Service Lamps, please visit: www1.eere.energy.gov/buildings/appliance_standards/standards.aspx?productid=4

We go to great lengths to assure the metal and glass finishes shown in the catalog match the actual products, but printing variations and variations in chemical finishes and the nature of hand-applied finishing will cause some differences between the printed images and actual product, and from one product to another.

We use only non-ferrous materials on the exterior parts of our outdoor lantern products, and use the best available weather-resistant finishes. However, due to some extreme environmental conditions such as acid rain, salt air and ultraviolet exposure, we cannot guarantee our exterior finishes, with the exception of our LifeBrite® lanterns.

Due to environmental conditions such as soil acidity, concrete alkalinity and other corrosive soil and air conditions, we cannot guarantee our direct burial posts.

Finish Abbreviation Key

ACO Antique Copper	GRG Greige
AGZ Aged Bronze	LD Londonderry™
AP Antique Pewter	MBK Matte Black
AUB Auburn Stained Finish	MIZ Mission Bronze™
AVI Anvil Iron	MWH Matte White
AZ Architectural Bronze™	NBR Natural Brass
AZT Textured Architectural Bronze™	NI Brushed Nickel
BA Brushed Aluminum	OB Olde Brick®
BEE Beech	OZ Olde Bronze®
BK Black	PAL Palm
BKT Textured Black	PB Polished Brass
BNB Brushed Natural Brass	PL Platinum
BSL Black with Silver Highlights	PN Polished Nickel
BSS Brushed Stainless Steel	PR Prairie Rock™
BST Brown Stone	RBG Rubbed Gray
BZ Bronze	RZ Rubbed Bronze™
CBL Catalina Blue	SB Satin Bronze
CG Champagne Gold	SBK Satin Black
CH Chrome	SN Satin Nickel
CHZ Character Bronze	SNB Satin Natural Bronze
CLG Classic Gold	SS Stainless Steel
CLP Classic Pewter	TRZ Terrene Bronze™
CLZ Classic Bronze	TZ Tannery Bronze™
CPZ Champagne Bronze™	WBR Weathered Brushed Brass
DAG Distressed Antique Gray	WCP Weathered Copper
DAW Distressed Antique White	WH White
DBK Distressed Black	WMP Warm Maple
ESP Espresso	WMZ Warm Bronze™
GG Gloss Gray	WWW Whitewashed Faux Wood
GRY Gray	WZC Weathered Zinc

CONNECT WITH US



Follow us: [instagram.com/KichlerLighting](https://www.instagram.com/KichlerLighting)
 Like us: [facebook.com/Kichler.Lighting](https://www.facebook.com/Kichler.Lighting)
 Follow us: twitter.com/KichlerLight
 Join us: [houzz.com/pro/KichlerLighting/Kichler](https://www.houzz.com/pro/KichlerLighting/Kichler)
 Find us: [pinterest.com/KichlerStyle](https://www.pinterest.com/KichlerStyle)
 Watch us: [youtube.com/KichlerLighting](https://www.youtube.com/KichlerLighting)
 Find us: [linkedin.com/company/KichlerLighting](https://www.linkedin.com/company/KichlerLighting)

Kichler Lighting
 30455 Solon Road
 Solon, Ohio 44139

To find an Authorized Dealer, visit
[Kichler.com/Where-to-buy](https://www.Kichler.com/Where-to-buy)

PRODUCT TECHNICAL SUPPORT

To take advantage of this free service, call our dedicated technical support line at 844-KICHLER (844-542-4537) or email techsupport@kichler.com.



All electrical products are UL/CSA/ or ETL Listed and Certified to UL/CSA Standards for use in U.S.A. and Canada except where noted.



The IDA (International Dark-Sky Association) Fixture Seal of Approval provides objective, third-party certification for luminaires that minimize glare, reduce light trespass, and don't pollute the night sky.



Kichler Lighting is a member of the American Lighting Association (ALA), a trade association representing the residential lighting and ceiling fan industries in the United States and Canada. Its membership includes leading lighting and fan manufacturers, showrooms (retailers), manufacturers representatives and designers. ALA members are dedicated to providing the public with the proper application of quality residential lighting.

To serve you better, Kichler Lighting reserves the right to make improvements to products in this catalog. Therefore, some products may change during the life of the catalog and the product information contained in this catalog may also have changed.

For warranty information visit [Kichler.com/Warranty](https://www.Kichler.com/Warranty)

KICHLER

— A PROUD NATIONAL SPONSOR —

St. Jude Dream Home® Giveaway

CELEBRATING

85

YEARS

KICHLER LIGHTING EST. 1938



OUR VISION

At Kichler Lighting, everything we do, every single day, is with the intention of creating and delivering products that allow people to see what matters most to them. We will do that by relentlessly pursuing quality, ensuring continued innovation, always going one step further in our commitment to exceptional customer service and education, as well as creating on-trend designs that are both stylish and “life-stylish,” promising to deliver project success for you.

Get inspired at [Kichler.com](https://www.kichler.com)