



MARKS USA

SURVIVOR SERIES LEVERSETS

"THE SURVIVOR SERIES...IT SURVIVES...OTHERS WON'T"

195/26D



395/3



275/10B



475/26

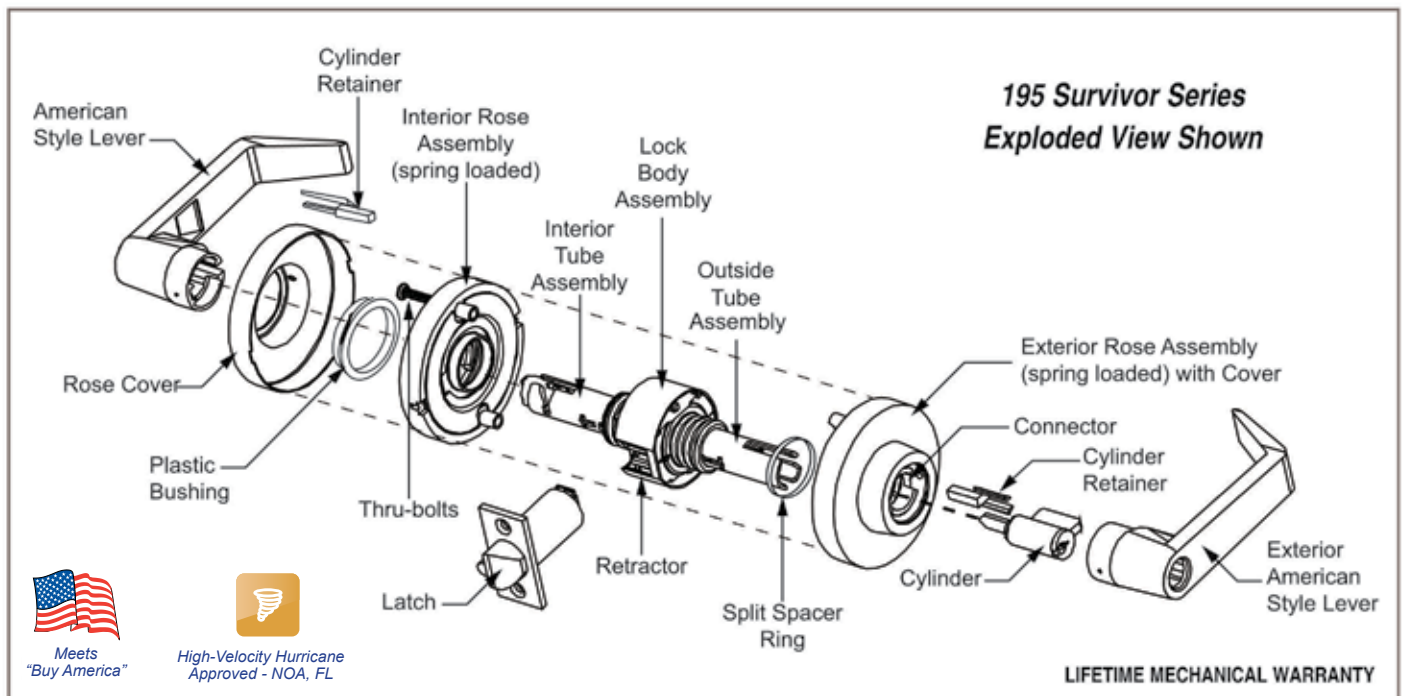

95 Series Grade 1 Cylindrical Survivor Leversets

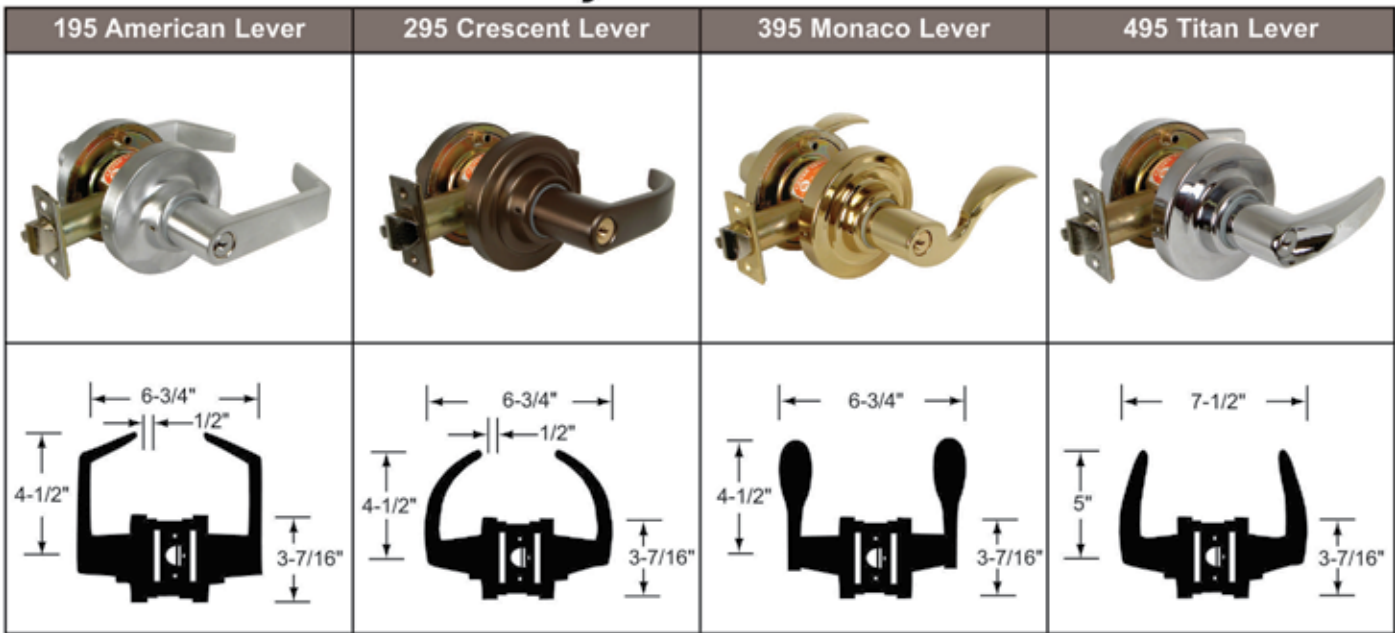

Standard Features

- ANSI-A156.2 Grade 1, UL listed 3 Hr. Fire Rating
- Backset: 2-3/4", 2-3/8" Available
- Latch #1834, Front: 1-1/8" x 2-1/4"; Throw: 9/16"; Stainless steel nose
- Levers: Solid cast Zamac; w/ 1/2" return (except 395 & 495)
- Roses: Thru-bolted, 3-7/16" dia., spring loaded 2-#10 thru-bolts

- Strike: #1135, 4-7/8" ASA curved lip strike
- Door thickness: 1-5/8" to 1-7/8"; For 1-3/8" door use K1904 spacer
- Cylinder: MARKS "C" keyway, 6 pin w/ 2 keys
- Stainless steel retractor
- NOTE: 395 Series is NOT available with IC Core

*** LIFETIME *
MECHANICAL
WARRANTY**

SERIES 195, 295, 395, 495

MARKS #		DESCRIPTION	ANSI #	FINISH GROUPS
COMM. CYL.	IC CORE CYL.*			
N	—	PASSAGE	F75	3, 4, 10, 10B, 26, 26D
L	—	PRIVACY	F76	
LK	—	PRIVACY	F76 MOD.	
P	—	PATIO	F77	
DC	RDC	COMMUNICATING	F80	
A	RA	ENTRY	F81	
B	RB	ENTRY	F82A	
AB	RAB	ENTRANCE	F109	
AQ	—	EXIT	F83	
S	RS	CLASSROOM	F84	
F	RF	STOREROOM	F86	
DW	RDW	INSTITUTION	F87	
DA	RDA	VESTIBULE	F88	
FQ	—	EXIT	F89	
T	RT	CORRIDOR	F90	
TK	RTK	HOSPITAL/PRIV.	F90 MOD.	
GB	RGB	STORE DOOR	F91	
BS	RBS	SVC. STATION LOCK	F92	
H	—	HOTEL	F93	
DB	RDB	CLASSROOM INTRUDER	F110	
DO	—	DUMMY TRIM OUTSIDE	—	
DT	—	FULL DUMMY TRIM	—	
NB	—	COMM. PASSAGE	F111	
FB	RFB	COMM. STOREROOM	F112	
SB	RSB	COMM. CLASSROOM	F113	
FEL	RFEL	ELECTRICALLY LOCKED	—	
FEU	RFEU	ELECTRICALLY UNLOCKED	—	

PACKED 6 PER CASE

NOTE: Split designs and/or finishes are priced at the highest design and/or finish
• Special finishes, consult factory

OPTIONS	CODE
For 2" doors	D1
For 2-1/4" doors	D2
Over 2-1/4" - 4" thickness	D9
2-3/8" backset, 1" x 2-1/4" face	E6
2-3/4" backset, 3/4" throw, Gr. 1	E8
Solid latch for electric strike	E9
3-3/4" backset, 9/16" throw, Gr. 1	E10
Less cylinder	G3
2-3/4" "T" strike	S3

AMERICAN LEVER ONLY Accepts:

Yale conventional	F7
Sargent conventional cylinder	F8
Corbin conventional cylinder	F9
Corbin 6 pin IC core	F12
Corbin 7 pin IC core	F13
Yale 6 pin IC core	F14
Yale 7 pin IC core	F15
Schlage 6 pin IC core (195 Only)	F19
Sargent IC core	F20

AMERICAN & CRESCENT LEVER ONLY Accepts:

Medeco IC core large format	F21
-----------------------------	-----

ELECTRIFIED MODELS AVAILABLE



Electrified Functions:

100% Duty Cycle 24v AC/DC, supplied w/ bridge rectifier
EU - 210 ma; EL - 125 ma

* Standard & HI-SECURITY™ IC Core Models:



Interchangeable Core models for 6 or 7 pin cores (not included).
Accepts: Marks, Marks HI-SECURITY™, Medeco®, KeyMark™, Falcon, Schlage® small format & Best®.

IC Core Tailpieces ARE Included.

75 Series Grade 2 Cylindrical Survivor Leversets

175 American Lever	275 Crescent Lever	375 Monaco Lever	475 Titan Lever
			
			

Standard Features

- ANSI-A156.2 Grade 2 Plus, UL listed 3 Hr. Fire Rating
- Backset: 2-3/4"
- Latch #1134, Front: 1-1/8" x 2-1/4"; Throw: 1/2"; Stainless steel nose
- Levers: Solid cast Zamac; w/ 1/2" return (except 375 & 475)
- Roses: Thru-bolted, 3-1/4" dia., spring loaded 2-#10 thru-bolts

- Strike: #1145, ASA strike
- Door thickness: 1-5/8" to 1-7/8"; For 1-3/8" door use K1704 spacer
- Cylinder: MARKS "C" keyway, 6 pin w/ 2 keys
- Stainless steel retractor
- NOTE: 375 Series is NOT available with IC Core

*** LIFETIME *
MECHANICAL
WARRANTY**

SERIES 175, 275, 375, 475

MARKS #		DESCRIPTION	ANSI #	FINISH GROUPS
COMM. CYL.	IC CORE CYL.*			
N	—	PASSAGE	F75	3, 4, 10, 10B, 26, 26D
L	—	PRIVACY	F76	
P	—	PATIO	F77	
DC	RDC	COMMUNICATING	F80	
A	RA	ENTRY	F81	
B	RB	ENTRY	F82A	
AB	RAB	ENTRANCE	F109	
AQ	—	EXIT	F83	
S	RS	CLASSROOM	F84	
F	RF	STOREROOM	F86	
DW	RDW	INSTITUTION	F87	
DA	RDA	VESTIBULE	F88	
FQ	—	EXIT	F89	
T	RT	CORRIDOR	F90	
BS	RBS	SVC. STATION LOCK	F92	
H	—	HOTEL	F93	
DO	—	DUMMY TRIM OUTSIDE	—	
DT	—	FULL DUMMY TRIM	—	
NB	—	COMM. PASSAGE	F111	
FB	RFB	COMM. STOREROOM	F112	
SB	RSB	COMM. CLASSROOM	F113	

PACKED 6 PER CASE

NOTE: Split designs and/or finishes are priced at the highest design and/or finish
• Special finishes, consult factory

OPTIONS

OPTIONS	CODE
For 2" doors	D1
For 2-1/4" doors	D2
2-3/8" backset, 1" x 2-1/4" face	E6
2-3/4" backset, 9/16" throw, Gr. 1, UL Listed	E7
2-3/4" backset, 3/4" throw, Gr. 1	E8
5" backset, 9/16" throw, Gr. 1	E9
3-3/4" backset, 9/16" throw, Gr. 1	E10
Less cylinder	G3
2-3/4" T strike	S3

AMERICAN LEVER ONLY Accepts:

Yale conventional	F7
Sargent conventional cylinder	F8
Corbin conventional cylinder	F9
Corbin 6 pin IC core	F12
Corbin 7 pin IC core	F13
Yale 6 pin IC core	F14
Yale 7 pin IC core	F15
Schlage 6 pin IC core (175 Only)	F19
Sargent IC core	F20

AMERICAN & CRESCENT LEVER ONLY Accepts:

Medeco IC core large format	F21
-----------------------------	-----















* Standard & HI-SECURITY™ IC Core Models:















Interchangeable Core models for 6 or 7 pin cores (not included).
Accepts: Marks, Marks HI-SECURITY™, Medeco®, KeyMark™, Falcon, Schlage® small format & Best®.

IC Core Tailpieces ARE Included.

CYLINDRICAL LEVER FUNCTIONS

ANSI # CODE	Marks Function	
	I/S	O/S
F75 PASSAGE: Latch by lever either side.		N
F76 PRIVACY: Latch by lever either side unless outside lever locked by push-button from inside. Outside unlocks by turning inside lever, outside emergency turn or closing door.		L
F76 (MOD.) HOSPITAL/PRIVACY: Latch by lever either side unless outside lever locked by push-button from inside. Outside unlocks by turning inside lever, outside emergency turn-knob or closing door.		LK
F77 PATIO: Deadlocking latch by lever either side unless outside lever locked by push-button inside. Unlocks by turning inside lever or closing door.		P
F80 COMMUNICATING: Key both sides. Locks or unlocks either lever independent of the other. Deadlocking latch.		DC
F81 ENTRY: Deadlocking latch bolt by lever either side except when outside locked by turn-button inside. When outside locked, key outside or lever inside opens lock. Turn-button operated manually.		A
F82A ENTRY: Deadlocking latch by lever either side. Outside locked by push-button inside. When outside locked by push-button inside, key opens lock, unlocks push-button. Inside lever always opens latch. Closing door does not release push-button.		B
F83 EXIT: Deadlocking latch by lever either side except when outside locked by turn-button inside. Inside lever always opens latch. Turn-button operated manually.		AQ
F84 CLASSROOM: Deadlocking latch by lever inside. Outside lever locked or unlocked by key.		S
F86 STOREROOM: Deadlocking latch by lever inside, key outside. Outside lever always locked.		F
F87 INSTITUTION: Both levers always locked. Deadlocking latch by key both sides.		DW
F88 VESTIBULE: Deadlocking latch by lever either side, except when outside lever locked by key inside. Key outside retracts deadlocking latch. Inside always open.		DA
F89 EXIT: Deadlocking latch by lever inside. Outside always locked.		FQ
F90 CORRIDOR: Deadlocking latch by lever either side unless outside locked by key or inside push-button. Unlock by key, turning inside lever or closing door.		T

ANSI # CODE	Marks Function	
	I/S	O/S
F90 (MOD.) HOSPITAL/PRIVACY: Deadlocking latch by lever either side unless outside locked by lever or inside push-button. Unlock by turn-knob, turning inside lever or closing door.		TK
F91 STORE DOOR (95 Series Leverset ONLY): Deadlocking latch by lever either side except when both levers are locked by key from either side.		GB
F92 SERVICE STATION LOCK: Deadlocking latch by lever either side unless outside locked by key or inside push-button. Unlock by key, turning inside lever or closing door, except when slotted push-button is turned in locked position. Inside lever always opens latch.		BS
F93 HOTEL: Deadlocking latch by lever inside. Outside lever always locked. Inside push-button projects indicator on cylinder face shutting out all keys except emergency key. Turning inside lever or closing door releases push-button.		H
F109 ENTRY: Outside locked by pushing turn-button inside. Key outside opens lock. Rotating inside lever releases button and outside lever. By pushing and turning inside button, outside lever remains locked. Deadlocking latch.		AB
F110 CLASSROOM INTRUDER: Deadlocking latch by lever either side, except when outside locked by key inside. Key outside locks or unlocks outside. Inside always open		DB
DUMMY TRIM: Outside only, rigid.		DO
DUMMY TRIM: Both sides, rigid.		DT
F111 COMMUNICATING PASSAGE: Blank outside. Deadlocking latch by lever inside.		NB
F112 COMMUNICATING STOREROOM: Blank outside. Deadlocking latch by key only. Lever always locked.		FB
F113 COMMUNICATING CLASSROOM: Blank outside. Inside lever locked or unlocked by key. Deadlocking latch.		SB
ELECTRICALLY LOCKED - FEL (Fail Safe): Outside always locked electrically. Open by key outside, switch or loss of power. Deadlocking latch by lever inside. Lever only.		FEL
ELECTRICALLY UNLOCKED - FEU (Fail Secure): Outside always locked until unlocked by key or electrically energized. Deadlocking latch by lever inside. Lever only.		FEU

Distributed By: