

MAXIM[®]

L I G H T I N G



LED LIGHTING SELECTIONS













TABLE OF CONTENTS

- 4 **COUNTERMAX™**
Slimstick Under Cabinet
- 8 **COUNTERMAX™**
3K Under Cabinet
- 12 SKY
- 14 WAFER LED
- 20 DIVERSE
- 28 COVE

LEGEND

	ADA Compliant
	Title 24
	Wet Location
	Damp Location
	Dimmable
	Energy Star
	LED
	ETL/cETL



SLIMSTICK

Slimstick's narrow aluminum channels of diffused LEDs are brilliantly concealed in an economical manner to tackle all your task lighting.

Installation is made simple with an adjustable bracket that allows you to direct the light where needed. Operates from a plug-in or hard wire power supply. Available in lengths from 6" to 48" with various accessories, Slim Stick is the easy solution for your task lighting applications.



FEATURES

- Aluminum construction
- Opal White acrylic diffuser for uniform reflectance
- Operate up to 20' with 100W driver
- Adjustable mounting clips allow for angled positions
- Dimmable
- Energy Star Certified
- Title 24
- 3000K Color Temperature
- CRI 90+
- 40% greater lumen output at 390LM per ft
- Universal connecting cords for easy installation
- 100-277V input on hardwire drivers
- ETL/ cETL IP65



8935AL
IN-LINE DIMMER

SLIMSTICK SPECIFICATION

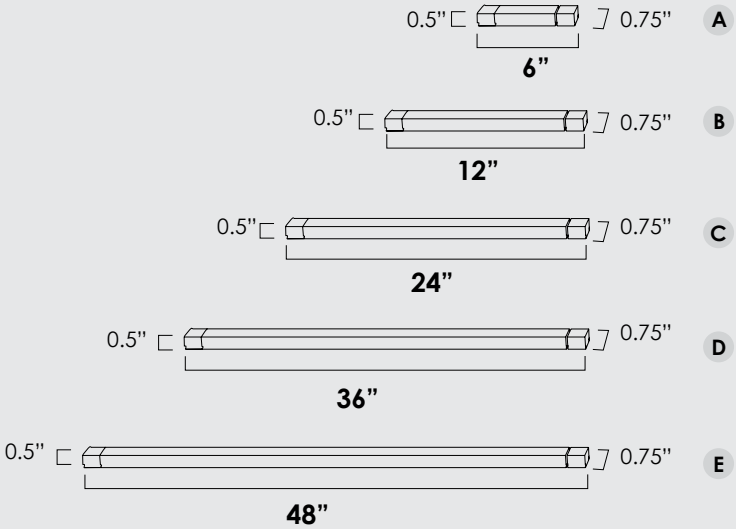

• Includes adjustable mounting clips

	ITEM#	LAMPING	DIMENSIONS	CRI	DELIVERED LUMENS
A	89800	5W LED 3000K (Integrated)	6"L x 0.75"W x 0.5"H	90+	195
B	89801	10W LED 3000K (Integrated)	12"L x 0.75"W x 0.5"H	90+	390
C	89802	15W LED 3000K (Integrated)	24"L x 0.75"W x 0.5"H	90+	780
D	89803	20W LED 3000K (Integrated)	36"L x 0.75"W x 0.5"H	90+	1170
E	89804	20W LED 3000K (Integrated)	48"L x 0.75"W x 0.5"H	90+	1400

Finish: Brushed Aluminium (AL) 



SLIMSTICK ACCESSORIES



89811BK
24V 24W Plug-In Driver
(works with in-line dimmer)



89812BK
24V 60W Plug-In Driver
(works with in-line dimmer)



89814BK
24V 96W Plug-In Driver
(works with in-line dimmer)



89816BK
24V 60W Hardwire
Dimmable 100-277V Driver



89818BK
24V 96W Hardwire Driver
Dimmable 100-277V



89821BK
12" (Includes on/off Switch)



Connecting Cord
2" **89820BK** 18" **89824BK**
6" **89821BK** 36" **89826BK**



89830BK
90° (right hand) Connector



89831BK
90° (left hand) Connector

COUNTERMAX™



MX-L-120-3K

3-in-1 COLOR TEMPERATURES & ADJUSTABLE GIMBAL

The best task light on the market. The 3K has the ability to switch between 3 color temperatures: 4000K, 3000K, and 2700K. With 90+ CRI, this fixture delivers an accurate color rendering. Our patented gimbal design allows the even light to be directed where desired.



High-Low Light Output Toggle Switch

Color Temperature Switch



2700K

3000K

4000K



1" Thick



- Link up to 750 watts on a single power supply
- No Hot Spots: even light
- Patent gimbal rotates 120° to direct illumination
- Dimmable with Triac or ELV Dimmers

FEATURES

- 3-adjustable color temperature options: 4000K, 3000K, and 2700K
- Dimmable using Triac or ELV Dimmers
- Linkable end-to-end or with MX Interlink connecting cord
- Link up to 750 watts per run
- 50,000 hours rated life
- 120° gimbal rotation
- Energy Star Certified
- Title 24
- CRI 90+
- ETL/ cETL IP65

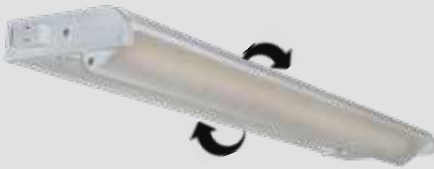

- Patent gimbal rotates 120° to direct illumination



ITEM#	LAMPING	DIMENSIONS	CRI	COL TEMP.	DELIVERED LUMENS	INPUT VOLTAGE
89892	3W PCB LED (Integrated)	6"L x 3.5"W x 1"H	90+	2700/3000/4000K	175	120V
89893	5W PCB LED (Integrated)	12"L x 3.5"W x 1"H	90+	2700 3000/4000K	275	120V
89894	8W PCB LED (Integrated)	18"L x 3.5"W x 1"H	90+	2700/3000/4000K	450	120V
89895	12W PCB LED (Integrated)	24"L x 3.5"W x 1"H	90+	2700/3000/4000K	650	120V
89896	16W PCB LED (Integrated)	30"L x 3.5"W x 1"H	90+	2700/3000/4000K	900	120V
89897	20W PCB LED (Integrated)	36"L x 3.5"W x 1"H	90+	2700/3000/4000K	1100	120V

FINISH OPTIONS:

- White (WT)
 Satin Nickel (SN)
 Bronze (BZ)





6"

89892

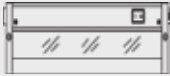

12"

89893

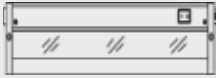

18"

89894

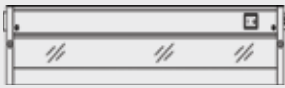

24"

89895

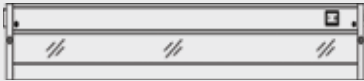

30"

89896

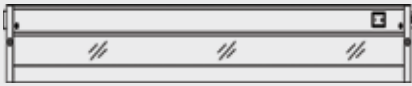

36"

89897

Dimmable with Triac and ELV Dimmers

Suggested Dimmers

- Lutron DVELV 300P WH
- Lutron - CTCL 153P WH

INCLUDES

- 3/8" knockouts on back and bottom
- Romex connector
- Mounting screws

PRODUCT ACCESSORIES

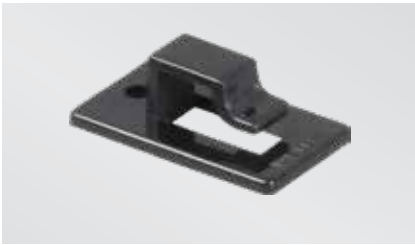

53255

Wire Clip • 0.5"W x 0.25"H x 1"L
(Package of 10)



Connecting Cord

9" **87876BK, WT**

18" **87877BK, WT**

24" **87878BK, WT**



87885BK, WT

4" Direct Wire Box • 2.25"W x 1"H x 5"L



89831BK, WT

72" Power Cord



SKY

EDGE LIT LED FLUSH MOUNT

The Sky edge lit LED flush mount simplifies the installation process for both residential and commercial uses. With a user-friendly mounting bracket and integrated driver, this flush mount provides for a quick installation.

The 120-277V high powered LED light flush mount is dimmable and comes in three finishes to suit your needs.

EASY INSTALLATION

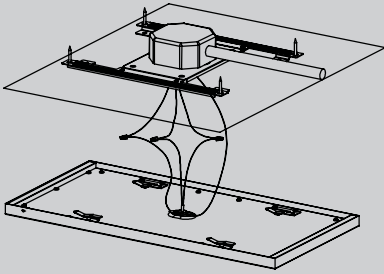

Just slide lamp into clips of bracket to mount

- 120-277V Input
- Dimmable at 120V with ELV Dimmer
- 3000K or 4000K Color Temp.
- 50,000 Hours Rated Life
- Wet Location Rated
- Energy Star Certified
- Title 24
- ETL/ cETL IP65
- CRI 90+



57762
57772

57764
57774

ITEM#	LAMPING	DIMENSIONS	COLOR TEMP.	LUMENS	VOLTAGE
57762	22W LED CRI 90+ (Integrated)	23.5" L x 11.75" W x 0.75" H	3000K	1760	120-277V*
57772	22W LED CRI 90+ (Integrated)	23.5" L x 11.75" W x 0.75" H	4000K	1760	120-277V*
57764	45W LED CRI 90+ (Integrated)	48" L x 11.75" W x 0.75" H	3000K	3600	120-277V*
57774	45W LED CRI 90+ (Integrated)	48" L x 11.75" W x 0.75" H	4000K	3600	120-277V*

* Dimmable at 120V with ELV Dimmer

FINISH OPTIONS:



White (WT)



Brushed Aluminum (AL)



Bronze (BZ)





WAFER LED

Get the sleek look of recessed cans without the expense

Wafer was designed for the discriminate consumer who wants the low profile look of recessed without the high cost. Manufactured of die cast aluminum, Wafer brings ultimate heat dissipation to its edge lit technology. Edge lighting provides even light distribution while dispersing heat over a larger area. The result is a longer LED life and better light diffusion.



The Wafer's LED technology will dramatically reduce your energy costs.

- Top 10 Product of the Year
- Slim profile creating a flush appearance
- LED Edge Lit Technology
- Slim profile makes the Wafer a great substitute for recessed cans
- Can be ceiling or wall mounted
- Easy Installation into 4", or 3.25" J-box where applicable
- Suitable for wet locations
- 40,000 hours rated life
- ADA Compliant
- Energy Star Certified
- Title 24, CRI 90+
- Fully dimmable
- ETL/ cETL IP65

EASY INSTALLATION

Ceiling
J-box
(octagon
or square)

Mounting
Bracket

Spring Clips

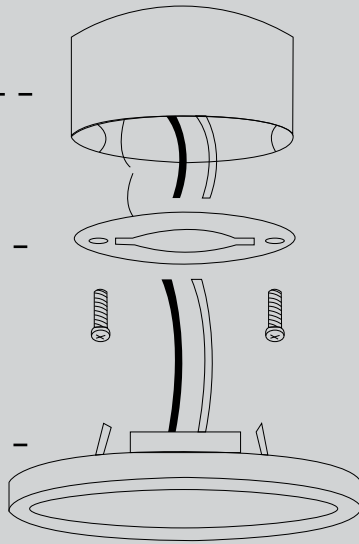

** For the complete IES file,
recommended dimmers,
video and spec sheet visit
maximlighting.com*



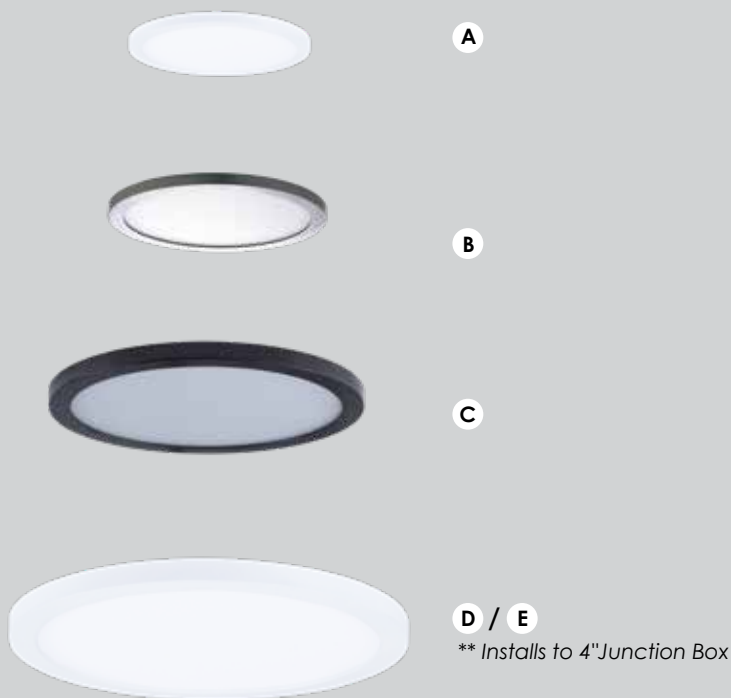

A

B

C

D / E

** Installs to 4" Junction Box

	ITEM#	LAMPING		DIMENSIONS	CRI	DELIVERED LUMENS	INPUT VOLTAGE	TITLE 24
A	57710	10W PCB LED (Integrated) 3000K		5"W x 0.5"H	90+	600	120V	Yes
B	57712	15W PCB LED (Integrated) 3000K		7"W x 0.5"H	90+	900	120V	Yes
C	57714	20W PCB LED (Integrated) 3000K		10"W x 0.5"H	90+	1200	120V	Yes
D	** 57736	36W PCB LED (Integrated) 3000K		15"W x 0.5"H	90+	2200	120-277V	No
E	** 57737	36W PCB LED (Integrated) 4000K		15"W x 0.5"H	90+	2500	120-277V	No

* Only available in White (WT)

** Installs to 4" Junction Box

FINISH OPTIONS:



White (WT)



Brushed Aluminum (AL)



Bronze (BZ)





A

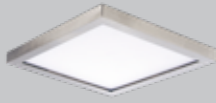

B

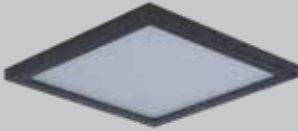

C



D / E

** Installs to 4" Junction Box

	ITEM#	LAMPING		DIMENSIONS	CRI	DELIVERED LUMENS	INPUT VOLTAGE	TITLE 24
A	57720	10W PCB LED (Integrated) 3000K		4.5"W x 0.5"H	90+	600	120V	Yes
B	57722	15W PCB LED (Integrated) 3000K		6.25"W x 0.5"H	90+	900	120V	Yes
C	57724	20W PCB LED (Integrated) 3000K		9"W x 0.5"H	90+	1200	120V	Yes
D	** 57738	36W PCB LED (Integrated) 3000K		15"W x 0.5"H	90+	2200	120-277V	No
E	** 57739	36W PCB LED (Integrated) 4000K		15"W x 0.5"H	90+	2200	120-277V	No

* Only available in White (WT)

** Installs to 4" Junction Box

FINISH OPTIONS:



White (WT)



Brushed Aluminum (AL)



Bronze (BZ)





A / B

** Installs to 4" Junction Box



C / D

** Installs to 4" Junction Box

	ITEM#	LAMPING		DIMENSIONS	CRI	DELIVERED LUMENS	INPUT VOLTAGE
A	57742	10W PCB LED (Integrated) 3000K		4.5"L x 24"W x 0.5"H	90+	1300	120-277V
B	57743	18W PCB LED (Integrated) 4000K		4.5"L x 24"W x 0.5"H	90+	1300	120-277V
C	** 57746	36W PCB LED (Integrated) 3000K		4.5"L x 24"W x 0.5"H	90+	2500	120-277V
D	** 57747	36W PCB LED (Integrated) 4000K		4.5"L x 24"W x 0.5"H	90+	2500	120-277V

** Installs to 4" Junction Box

FINISH OPTIONS:

White (WT)





DIVERSE FLUSH MOUNT

The Diverse LED Flush Mount is constructed of die-cast aluminum and is fully sealed for use in ceiling and wet location installations.

Mounting easily to a 3.25" j-box the Diverse uses its 90+ CRI LED to provide a brighter light while reducing energy consumption. This innovative design reduces operating costs by up to 80% over incandescent downlights.



The Diverse is an energy efficient and environmentally friendly light source.

- Slim design makes it a great substitute for recessed lighting
- Fully dimmable with CL Triac Dimmers
- High powered LEDs create a brighter shine
- Approved for use in closets and storage spaces
- Reduces energy consumption and operating costs by up to 80% over incandescent downlights
- Easy to install: fits all standard 3.25" or 4" J-box
- Suitable for wet locations
- Innovative design runs cooler to maximize energy efficiency
- Energy Star Certified, CRI 90+, Title 24
- ETL/ cETL IP65

DIVERSE FLUSH MOUNT *The Versatile Home Essential*

- Slim 0.75" extension makes it a great substitute for recessed lighting
- Fully dimmable with CL Triac Dimmers
- High-powered LED output creates brighter shine

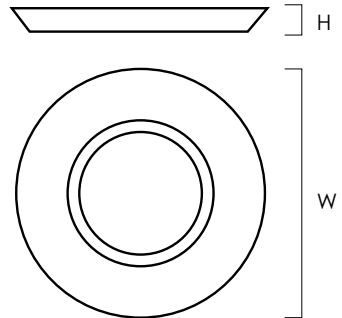



A 57622



B 57624



C 57625



D 57627

ITEM#	LAMPING	DIMENSIONS	CRI	DELIVERED LUMENS	FINISH
A 57622	12W LED 2700K 120V (Integrated)	5.75"W x 1"H	90+	750	WT, SN, BZ
B 57624	12W LED 3000K 120V (Integrated)	5.75"W x 1"H	90+	750	WT, SN, BZ
C 57625	15W LED 2700K 120V (Integrated)	7.5"W x 1.25"H	90+	950	WT, SN, BZ
D 57627	15W LED 3000K 120V (Integrated)	7.5"W x 1.25"H	90+	950	WT, SN, BZ

FINISH OPTIONS:

White (**WT**)
 Satin Nickel (**SN**)
 Bronze (**BZ**)





A / B
57652/ 57647



57652WTWT
57647WTWT
Flush Mount
with a concave lens



C 57640

	ITEM#	LAMPING	DIMENSIONS	CRI	DELIVERED LUMENS	FINISH	TITLE 24
A	57652	12.5W LED 3000K 120V (Integrated)	7.5"W x 0.75"H	90+	950	WT	N
B	57647	15W LED 3000K 120V (Integrated)	7.5"W x 0.75"H	90+	1000	WT	Y
C	57640	28W LED 3000K 120V (Integrated)	13"W x 0.75"H	90+	1320	WT, SN, BZ	Y

FINISH OPTIONS:

- White (**WT**)
- Satin Nickel (**SN**)
- Bronze (**BZ**)



EASY INSTALLATION



57652WTWT

Ceiling
J-box
(octagon
or square)

Screw

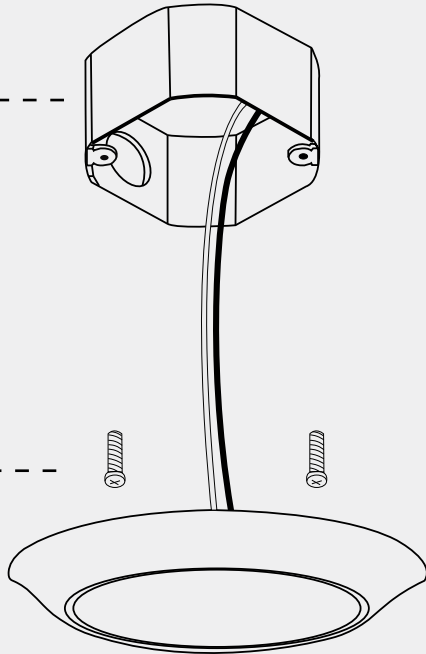



57647WTWT

Ceiling
J-box
(octagon
or square)

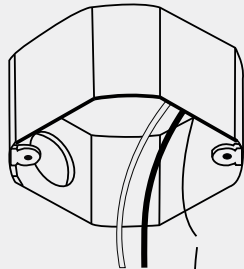

Mounting
Bracket



Spring Clips





COVE

RECESSED DOWNLIGHT

Maxim's Cove Recessed Downlight series includes a UL approved outlet box that is fitted to the fixture for easy installation. The Cove can replace standard recessed lighting without the need of a recessed housing. Available in both 4" or 6" diameters and 90+ CRI, the Cove recessed downlight is the most versatile LED retrofit on the market today.

FEATURES

- LED 3000K, CRI 90+
- 4" and 6" Recessed Can Substitute
- UL Approved Outlet Box fitted on fixture
- Dimmable with Triac Dimmer
- Suitable for new construction and remodels
- Indirect lighting into cove for soft-even illumination
- IC-Rated for direct contact with insulation
- Damp Location Rated
- Fire Rated
- Title 24
- ETL/ cETL IP65

A

57794



B

57796



	ITEM#	LAMPING	DIMENSIONS	CRI	DELIVERED LUMENS
A	57794	9W LED 3000K (Integrated)	4.75" W x 3.25" H	90+	540
B	57796	12W LED 3000K (Integrated)	6.75" W x 3.75" H	90+	720

FINISH OPTIONS:

White (WT)





WESTERN DISTRIBUTION CENTER (HEADQUARTERS)
253 NORTH VINELAND AVE | CITY OF INDUSTRY, CA 91746

EASTERN DISTRIBUTION CENTER
4200 SHIRLEY DR. | ATLANTA, GA 30336

P. 626.956.4200 | F. 626.956.4225

maximlighting.com