

MEDECO XT PRODUCT CATALOG



Canadian Prices Effective March 1, 2024



WHO WHEN WHERE WHY

medeco®

ASSA ABLOY

Experience a safer
and more open world



Medeco® XT

Medeco® XT Intelligent Key Ecosystem

Building on Medeco's 55-year history of creating high security key control products, the Medeco XT Intelligent Key Ecosystem takes key systems to a completely new level.

Medeco XT adds security, regulatory compliance and accountability to practically every opening in a fast, efficient way. A Medeco XT Ecosystem enhances businesses by providing the valuable data and tools needed to be more profitable or meet compliance requirements.

Overview: The Medeco XT Ecosystem consists of a robust electronic locking and access control system that is managed by state-of-the-art web based system software.

Medeco XT overcomes current keying issues by keeping security high even if someone loses a key.

Medeco XT also adds access control capability in hard to reach areas such as safes, cabinets, gates (padlocks), etc. In addition, with the new AIM (Access Interface Module) Device, imagination is your only limitation regarding what to control next with your XT key.



Audit Accountability

Audit information recorded in both the lock and key shows a time- and date-stamped record of every event, including authorized accesses and unauthorized attempts.



Uses Existing Hardware

Medeco XT key provides all power to the cylinder, eliminating the need for any hardwiring or power supply. Simply remove the existing mechanical cylinder and install the Medeco XT cylinder.



Reduces Risk of Lost Keys

Respond quickly to security threats, lost or stolen keys, or personnel changes without the added cost of changing your locks and keys.



Electronic Scheduling

Keys are electronically programmed to open only specific locks during a designated schedule. Schedules may also contain an expiration point to completely disable the key until it is audited and reprogrammed.



Medeco Data Dashboard

System audit data is displayed in a new graphical way on the Medeco dashboard. The 'Glances' display consists of several mini-dashboards that provide insight into your system configuration and audit events.



Data Analytics

The Visual Audit feature of Medeco XT Web manager software converts audit data into a simple graphic dashboard. Security Administrators can see access trends and irregularities at a glance!

Key Features:

- Small, robust electronic key with stainless steel housing
- Intelligent key holds all access and schedule data
- Rechargeable battery
- Stand-alone, network, Web and mobile programming options

Warranty:

Medeco Security Locks warrants Medeco XT products to be free of defects in material and/or workmanship for a period of two (2) years from date of original purchase (except where noted).

- **Extended warranty available at time of purchase, see page 13 (Warranty Information) for additional information.**

Product Specifications:

Lock / Cylinder Features

- No wiring required—all power provided by the key
- Indoor / outdoor use—stainless steel shell construction
- 2,000 audit events
- Unauthorized key list
- Variety of retrofit cylinder formats

XT Software and Options:

XT Software and Options: The Medeco XT Web Manager software is an integral part of the Medeco XT Ecosystem. The software not only helps manage the XT Intelligent Key System in flexible and cost-effective manner, but also provides business-enhancing tools.

The XT Web Manager SaaS (Software as a Service) software is available as either a Medeco-hosted or End-user hosted option. The Medeco-hosted option takes advantage of the power, convenience and security of Amazon Web Services (AWS) and is offered in several pricing levels. This option offers high-availability, secure web access, no start-up fees, and a multitude of AWS optional services to meet any customer’s needs.

All Admin functions are handled by trained and certified IT personnel. Medeco holds ISO 27001 Certification for internal information and asset security.

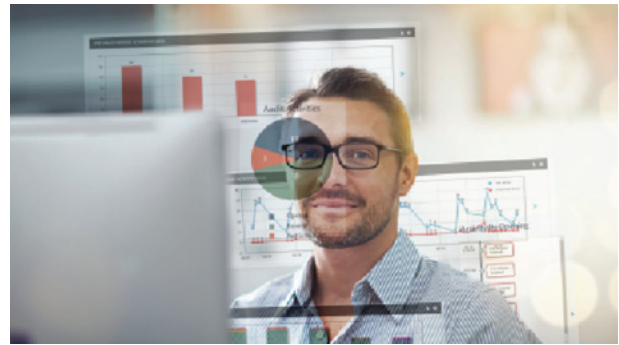

Description	Part Number	Annual License Fee
Enterprise: Medeco can create a custom offering for large enterprise class systems that need more options to support their needs (see Web Hosting below). Speak to your local sales representative for more details.	Note: Depends on options and # of keys	Custom quoted
Premium: Includes all the functionality of Advanced plus, access to other custom AWS services, and Pro Service Remote Training and support (4 hours annually — a \$2,660 value). Limit 1,500 keyholders.	SW-500301-4	\$6,124.00
Advanced: Designed for mid-size systems. Adds Remote & Mobile programming & extended schedules to the Basic version. Limit 750 keyholders.	SW-500301-3	\$3,743.00
Basic: Designed for smaller systems: Effectively manage your XT Intelligent Key system with all the basic functionality which includes Schedules, Audit, Groups, Data Dashboard & Visual Audit. Limit 250 keyholders.	SW-500301-2	\$1,192.00
<p>Web Hosting custom options available at additional cost include: Dedicated Server for very large systems, regulatory compliance configurations, database archiving, Country/Region customization and more. Please contact your local Medeco sales rep for more information.</p> <p>Multi-year hosting available.</p> <ul style="list-style-type: none"> • Dedicated Server for large systems • Country/Region customization • Regulatory compliance configurations • Custom database archiving • Multi-Year Hosting 		
<p><i>These offerings are billed annually.</i></p>		

Medeco XT Self-Hosted Software

These systems are set up and hosted by the End-User: End-User is responsible for supplying all necessary hardware & expertise for server set up, maintenance, backups, etc.

See Professional Services section for assistance with configuration and set up of your XT system.

Description	Part Number	One-Time Fee	Annual Fee
*XT Enterprise Self-Hosted Software. All the features of the Advanced version along with support for very large systems plus more advanced and/or future functionality.	SW-600901-1	\$56,836.00	
Enterprise Self-Hosted Annual Recurring Maintenance Fee – receive all software updates and bug fix releases, installation support, and an additional software license for a test server.	SW-600901-1R		\$8,526.00
XT Enterprise Self-Hosted Software with XT IKC Support	SW-600901-2	\$57,895.00	
*XT Advanced Self-Hosted Software: for mid to large systems. Includes features such as Remote and Mobile programming, Visual Audit, Who has Access reporting, etc.	SW-600901	\$25,981.00	
Advanced Self-Hosted Annual Recurring Maintenance Fee – receive an additional software license, software updates and bug fixes and installation support.	SW-600901-R		\$3,899.00
*XT SOLO – Same interface as our XT Web based software but designed for standalone applications. Does not support Remote or Mobile programming.	SW-500301-1	\$1,582.00	
XT SOLO Software Maintenance Fee – receive software updates and installation support for same	SW-500301-1R		\$316.00
API Interface available for custom applications/integrations	Contact your local sales representative for more details.		
<i>Maintenance fees are billed annually.</i>			
<p>Self-hosted software purchases entitle the user to a single user license with no annual license fees. Purchase also entitles user to an additional license for an on-site test server. (Medeco always recommends introducing a new version of software to a test server before deploying to their live system.)</p> <p>Recurring maintenance is recommended and provides an additional license for test server, regular software program updates, maintenance releases, patches, and basic level technical telephone assistance.</p> <p>Customers who are not paying the recurring maintenance fee but that wish to upgrade their XT Web Manager software must contact their dealer or Medeco Representative for a quote.</p> <p>Note: Medeco Tech support cannot support software versions that are over two years old without the addition of Professional Services</p>			

* Also requires the purchase of a system setup dongle. Part number EA-250059.

Medeco® XT Intelligent Keys

Medeco® XT Electronic Locking Systems

The Medeco XT keys are small, robust, convenient and portable. They are built to withstand even the toughest environments.

The Medeco XT keys have dynamic memory which can adjust the number of audit transactions and cylinder access the key can store. Medeco XT keys also utilize a rechargeable battery and can be purchased with a portable charger to ensure you are never locked out due to a dead battery. The key provides feedback to indicate when a charge is required.

There are two key models in the XT line. The 'Slim Line' key is designed for just about every application except those extreme and abusive environments, where the 'Rugged' key is recommended.



G3R Rugged Key Features:

- Hardened stainless steel housing that will stand up in the toughest environments
- Portable and rechargeable
- Top-mounted LED for convenient access feedback

G3R Rugged Key Applications:

The XT Rugged key was designed for users that want a small, robust credential that will stand up to the most extreme environments. Tested for drop, shock and temperature extremes.

Slim Line Key Features:

- Polished, hardened stainless steel frame for strength and durability
- Soft-touch coating
- Dual-LED indicators for greater visibility
- Raised orientation dimples (allow for feeling the orientation of the key) for easier use
- High-capacity memory

Slim Line Key Applications:

The XT Slim Line key was designed for users that want a small, light credential that will not sacrifice on durability. Created to stand up to all but the most extreme environments but designed to be one of the most portable and desirable keys on the market!

Bluetooth Key Features:

- Utilizes Bluetooth Smart Technology
- Program keys from any location (within cellular coverage area)
- No need to 'dock' key to program
- Works with the latest XT Web Manager software

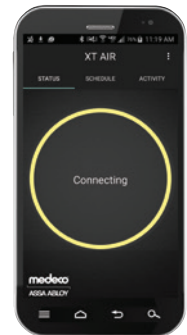

NEW: Slim Rugged



- Intelligent to access up to 16k locks and store 10k audit events
- Extremely durable
- Stainless steel and aluminum construction
- Support for remote and mobile programming
- Rechargeable

Slim Line S



- Higher intelligence to support more advanced features
- Enhanced user experience with faster processing and programming speeds

Slim Line B Bluetooth Key



- All the Slim Line S features and...
- Program anywhere
- Bluetooth communication built-in
- Smartphone app support
- Immediate upload/download of data (if desired)

See page 50 for additional details and technical information.

Keys and Accessories

The Medeco® XT Key is a convenient, robust electronic key with a heavy duty stainless steel housing that fits right on your key ring. A portable key charger and rechargeable battery assures keys are always fully charged for up to 1,800 openings, eliminating the need for battery maintenance. Convenient key programming and flexible system management eliminates the need for removal of cylinder in order to make changes. This key holds operating and expiration schedule and flexible memory allocation lets the user decide how the memory is used; Access: up to 16,000 cylinders. Audit: up to 14,000 events. With Medeco XT, flexible authorization, auditing of use and quick retrofit to existing hardware are all available in one convenient package.



XT Keys

Description	Part Number	Price
XT Slim Line Key Plus (G3S)	EA-100178	\$185.00
XT Slim Line Key Bluetooth (G3B)	EA-100177	\$233.00
XT Rugged Slim Key (G3R)	EA-100254	\$246.00
Slim Line Demo/Install Key	EA-100173	\$297.00
Slim Line Demo/Install Control Key	EA-100174	\$297.00

Medeco® XT Key Bundles

Description	Part Number	Price
XT Slim Line Key (G3S) Charger Bundle. Includes XT Slim Line Key, Charger and USB Cable	94-0307	\$247.00
XT Slim Line Key (G3B) & Charger Bundle. Includes XT Slim Line Key, Charger and USB Cable	94-0306	\$275.00
XT Rugged Key bundle (G3R). Includes XT Rugged Key, Charger and USB Cable	94-0325	\$299.00

	Slim Line S (Gen 3)	Slim Line B (Gen 3)	Rugged (Gen 3R)
Description	Faster processor, faster communication, support for future functionality	Bluetooth version. Faster processor, faster communication, support for future functionality	Same functionality as G3S key with a rugged housing for increased durability.
Part Number	EA-100178	EA-100177	EA-100254
Size	2.65" x 1.25" x .55"	2.65" x 1.25" x .55"	2.65" x 1.25" x .59"
Weight	1.25 oz.	1.25 oz.	1.25 oz.
Openings per charge	1500-1800	1500-1800	1500-1800
Durability	High	High	Very High
Memory	14,000 cylinders	14,000 cylinders	14,000 cylinders
Audit	14,000 events	14,000 events	14,000 events
Battery Level Indicator Expected battery life – 5-10 years*	Percentage	Percentage	Percentage
Warranty	2 years	2 years	2 years

* Depending on amount of usage.

Extended warranty available for purchase. See Page 13 for more details.



IPD – Identification and Programming Device

Medeco XT Programmers

XT IPD - Identify, program and update Medeco XT Keys remotely via internet connection to Web Manager software

XT IPD	Part Number	Price
XT IPD Base unit with power supply	EA-100242-000	\$2,162.00
XT IPD Base unit, desktop mount and power supply bundle	EA-100242-010	\$2,305.00
XT IPD Base unit, wall mount and power supply bundle	EA-100242-100	\$2,305.00
XT IPD Standoff Retrofit Kit - spacer kit for replacing existing Remote Programmer when mounted in a custom enclosure	EA-300241	\$99.90
XT IPD Replacement Touchscreen assembly	EA-100245	\$1,008.00
7/8" Cam Lock – Can be added to IPD for users to test keys. (Optional)	EN-150002-XXX	\$410.00



Desktop Programmer

Desktop	Part Number	Price
XT Desktop USB Programming Station (order cable separately)	EA-100109	\$390.00



Mobile Programmer

Mobile	Part Number	Price
XT Mobile Programmer	EA-100125	\$1,164.00



Multi-Key Programmer/Charger

Multi-key	Part Number	Price
XT Multi-key Programmer/Charger	EA-100232	\$5,455.00

Medeco® XT Kits & Accessories

Description	Part Number	Price
XT Multi-Key Charger - Charge up to 10 Medeco XT Keys simultaneously (does not program keys)	EA-100138	\$892.00
XT Portable Key Charging Adapter only (order cable separately)	EA-100088	\$81.40
XT Key Wall Charger Kit	94-0291	\$142.00
XT Key Vehicle Charger Kit	94-0292	\$140.00
XT Key PC Kit (USB Cable and Charging Adapter)	94-0290	\$104.00
Smart SFIC Solutions Demo Kit (Includes Arrow, Medeco X4, and Medeco XT SFIC cylinders, keys, charger and cable)	940261	\$1,720.00

Medeco® XT Maintenance and Protective Products

Description	Part Number	Price
Fluid Film, 2.25 oz	PX-KYLUBE-02	\$30.29
Fluid Film, 11.75 oz	PX-KYLUBE-11	\$48.10
Small Bristle Brush (non-metallic bristles) for cleaning cylinder & key contacts	CP-286180	\$45.63
Deoxit Contact Cleaning Pen (gold contact cleaner)	CP-301290	\$108.68
Metal cylinder protector cover	CP-287260	\$107.00
Plastic cylinder protector cover	CP-170930	\$78.30

Self-Hosted Software – End User Startup Checklist:

Description	Quantity	Part Number	Price
XT Programming Device	1	EA-100109	\$390.00
USB Cable	1	EA-200058	\$38.10
Enhanced USB System Dongle	1	EA-250059	\$116.00

Web Hosted Service – End User Startup Checklist:

Description	Quantity	Part Number	Price
XT Programming Device	1	EA-100109	\$390.00
USB Cable	1	EA-200058	\$38.10

Professional Services

Planning, design and support are crucial to the successful deployment of an Intelligent Key System. Medeco offers professional services to ensure every installation is planned and executed seamlessly, and the system works effectively to meet current and future needs to protect the investment. See page 19 for details and pricing.

XT Finishes

XT cylinders are available in the finishes shown to the right.

NOTE: For XT SFICs only, due to the complexity of the process, there is a \$42 fee for custom finishes (other than 26, which is standard).



06
(US04)
Satin Brass



12
(US10)
Satin Bronze



13
(US10B)
Dark Bronze/
Oil Rubbed



BB
Matte Black



26
(US26D)
Satin Chrome*

Interchangeable Core Cylinders



SFIC

XT Small Format Interchangeable Core (SFIC) is ideal for access management as a direct replacement for mechanical SFIC without any hardware modifications. An easy-to-upgrade solution, ready to install and use without wiring or power supply, XT SFIC is easily installed or removed to existing hardware with the simple use of a programmed control key. Users can audit keys, program a schedule and track who opens a lock and when – all while eliminating the cost of rekeying mechanical locks. Well suited for facilities with high turnover of employees, such as fast food restaurants, convenience stores, and similar businesses, but is also suitable for apartments, office buildings, schools, and hospitals. Available in custom finishes.

XT Small & Large Format Interchangeable Core

Description	Part Number	Price
Small Format Interchangeable Core (SFIC) Cylinder	EA-100108	\$427.00
Schlage Large Format Interchangeable Core (LFIC) Cylinder*	322201 G	\$395.73
Yale Large Format Interchangeable Core (LFIC) Cylinder* 6 pin	310100 G	\$400.05
Yale Large Format Interchangeable Core (LFIC) Cylinder* 7 pin	310100A G	\$400.05
Sargent Large Format Interchangeable Core (LFIC) Cylinder 6 pin	322401 G	\$402.52
Corbin Large Format Interchangeable Core (LFIC) Cylinder 6 and 7 pin (includes spacer)	322301 G	\$402.52

* Fits LFIC format housing, but is a one-time installation and not removable.

* Fits LFIC format housing, but is a one-time installation and not removable.

Rim and Mortise Cylinders

For availability of cylinder formats not shown, contact Technical Support.

XT Rim and Mortise electronic cylinders are a simple and direct replacement for mechanical cylinders. Ideal for loss & liability management with flexible authorization and auditing capabilities. Respond quickly to security threats, lost or stolen keys, or personnel changes without the added cost of changing your locks and keys. Medeco XT is a complete electronic locking system providing controlled access, accountability, physical security, and system management with no wiring requirements. Cylinders are available in many popular lengths and finishes to fit nearly any application in your office, business and retail applications.



Mortise Cylinder



Rim Cylinder

XT Rim and Mortise Cylinders

Description	Part Number	Price
Rim Cylinder, horizontal tailpiece	100400H G*	\$393.87
Rim Cylinder, vertical tailpiece	100400V G*	\$393.87
1 1/4" Mortise Cylinder	100500 G*	\$397.31
1 3/8" Mortise Cylinder	105100 G*	\$393.25

*Must specify cam (mortise) or tailpiece (rim) when ordering. See pages 82-83 for cam and tailpiece part numbers and descriptions. If not specified, Z01 cam will be supplied for mortise, Y02 tailpiece will be supplied with rim cylinders.

How To Order Rim & Mortise Cylinders

















Complete part numbers are required for all orders. To determine the correct part number, fill in the "X's" in sequential order.

<p>100500 Base Part #</p> <p>Refer to description to find the corresponding base part number.</p>	<p>G Cylinder</p> <p>G = Medeco XT</p>	<p>26 Finish</p> <p>Refer to page 36 for finish options. Include the corresponding two digit finish number.</p>	<p>Z01 Cam/Tailpiece</p> <p>Refer to pages 4-6 for cam options. Include the corresponding three digit number.</p>
--	---	--	--

BUILD A RIM & MORTISE PART #: 100500 G XX XXX

<p>Rim & Mortise Cylinder ————</p> <p>Obtain from Product Listing ————</p> <p>Cylinder Technology ————</p> <p>G = Medeco XT</p>	<p>Cam/Tailpiece</p> <p>See pages 4-6 for options</p> <p>Finish</p> <ul style="list-style-type: none"> 05 = Bright Brass (US03) 06 = Satin Brass (US04) 09 = Antique Brass (US5) 11 = Bright Bronze (US9) 12 = Satin Bronze (US10) 13 = Dark Bronze/Oil Rubbed (US10B) 18 = Bright Nickel (US14) 19 = Satin Nickel (US15) 20 = Antique Nickel (US15A) 22 = Flat Black (US19) 24 = Dk Bronze/Clear Coat (US20A) 25 = Bright Chrome (US26) 26 = Satin Chrome (US26D)
---	--

Mortise Cams









Description	Part Number	Price
 Corbin Russwin® Type	CT-Z00	\$6.93
 Standard Yale® Type	CT-Z01	\$6.93
 Adams Rite® Type	CT-Z02	\$6.93
 Keil® Norwalk Type	CT-Z04	\$6.93
 Schlage® Type	CT-Z05	\$6.93
 Medium Yale® Type	CT-Z06	\$6.93
 Segal® Type	CT-Z07	\$6.93
 Lockwood® Type	CT-Z08	\$6.93
 Corbin Russwin® Type	CT-Z09	\$6.93
 Segal® Deadbolt Type	CT-Z16	\$6.93
 Corbin Russwin® Oversized Jumbo	CT-Z17	\$6.93
 For Night Deposit Lock	CT-Z18	\$6.93
 General® Lock	CT-Z19	\$6.93
 Sargent® Type	CT-Z20	\$6.93
 Ruko® Type	CT-Z21	\$6.93
 Falcon® Type	CT-Z22	\$6.93

(P) = Pinned (combined)

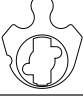
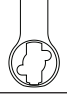
(S) = Sub-assembled (uncombined)

Surcharges for Master Keying, Custom Coining and Custom Stamping apply, see page 195.
Refer to the XT and CLIQ Intelligent Key sections for format availability and pricing.

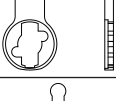
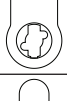
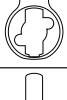
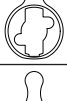
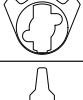
Mortise Cams







Description	Part Number	Price
 Schlage® Type	CT-Z34	\$6.93
 Mogul Lock	CT-Z45	\$6.93
 Yale® Mortise After 1982	CT-Z47	\$6.93
 Dominion®	CT-Z48	\$6.93
 Corbin Russwin® Jumbo	CT-Z55	\$6.93
 Yale® Medium After 1982	CT-Z56	\$6.93
 Medeco Residential	CT-Z57	\$6.93
 Falcon® Type	CT-Z58	\$6.93
 Corbin Russwin® Master Ring clover leaf for deadbolt function locks made since 6/93	CT-Z59	\$6.93
 Hook Type for Detention Locks	CT-Z61	\$8.14
 Mogul clover leaf	CT-Z69	\$19.37
 Best® Hotel Function Reversible Lock	CT-Z70	\$6.93
 Marks® J Type	CT-Z84	\$6.93
 VingCard® Persona®	CT-Z87	\$6.93
 Falcon® Type	CT-Z99	\$6.93
 Sargent Mogul	CT-ZA6	\$6.32

(P) = Pinned (combined)



(S) = Sub-assembled (uncombined)

Surcharges for Master Keying, Custom Coining and Custom Stamping apply, see page 195.
Refer to the XT and CLIQ Intelligent Key sections for format availability and pricing.

Collars & Cylinder Rings

Description	Part Number	Price
 Tapered Cylinder Collar	94-0188-XX	\$25.87
 1/4" Thick Spacer Ring 1.165" Inside Diameter x 1.375 Outside Diameter	CP-070011	\$43.42
 1/8" Thick Spacer Ring 1.165" Inside Diameter x 1.375 Outside Diameter	CP-070451	\$34.71
 Raised Cylinder Ring	CP-180021	\$15.60
 Flush Cylinder Ring	CP-180041	\$15.34
 Adjustable Cylinder Collar	CP-160180	\$43.42

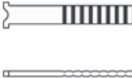
Rim Tailpieces

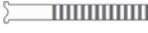
Description	Part Number	Price
 Tailpiece for Rim Cylinder (155/64") Before 1980, After 1983	CT-Y02	\$6.93
 Lazy Motion Tailpiece (2 29/64")	CT-Y08	\$6.93
 Tailpiece for Rim Cylinder (2-9/16")	CT-Y32	\$6.93

(P) = Pinned (combined)

(S) = Sub-assembled (uncombined)

Surcharges for Master Keying, Custom Coining and Custom Stamping apply, see page 195.
Refer to the XT and CLIQ Intelligent Key sections for format availability and pricing.

Key-In-Knob/Lever Cylinders

XT Key-in-Knob/Lever electronic cylinder is a direct replacement for mechanical KIK/KIL cylinders and is ideal for access control management. The cylinder requires no wiring to the door and is powered by the XT rechargeable key. Audit trail, user access schedules and the ability to quickly add or remove a key electronically from a system allow for fast response to security threats, lost or stolen keys, or personnel changes without the added cost of changing locks and keys. Designed for quick retrofit of nearly all popular brands of knob and lever-type cylindrical locksets, making them an ideal application for office doors, storage and file rooms, or residential doors: virtually any door where cylindrical hardware is used.



XT Arrow Cylinders

Description	Part Number	Price
Medeco XT cylinder for all Arrow RK & MK series knobs and GL series levers. For RK & MK series, replace original spacer with Medeco CP-160321 (included)	20200A1 G	\$399.58

XT Cylinders for Cal-Royal

Description	Part Number	Price
Cylinder for Cal-Royal Apollo series SL00 knob lock and LX01 lever lock	2020049 G	\$397.29
Cylinder for Cal-Royal CLS03 classroom function Gr. 2 lever lock	20200V1 G	\$397.29

XT Cylinders for Corbin Russwin

Description	Part Number	Price
Cylinder for Corbin 800 lever lockset CL3300, CL3400, CL3500 & CL3600	2020073 G	\$397.29
Cylinder for Corbin Russwin CL3900 series leversets	20200V9 G	\$397.29

XT Cylinders for Falcon

Description	Part Number	Price
Cylinder for Falcon B, LY, X, S & T series. Includes: CT-V03, CT-Y49, CT-Y54, CT-Y58, CTY68, CT-Y71, CT-Y72, CP-160311	20200F1 G	\$399.58
Cylinder for Falcon F521, F561, F581, and N series knobs	2020051 G	\$397.29
Cylinder for Falcon T-381 (inside)	2020073 G	\$397.29
Cylinder for Falcon T & RU series, T381 (exterior)	20200V3 G	\$397.29

XT Cylinders for KABA-Mas-Hamilton

Description	Part Number	Price
Cylinder for Kaba E-plex 5000	2020000 G	\$397.29
Cylinder for Mas-Hamilton Power Lever	20200V1 G	\$397.29

XT Cylinders for LSDA

Description	Part Number	Price
LSDA cylinder package fits 100, L100, LH1000, LX1000, Includes: CT-Y49, CT-Y70, CT-Y73, CTY78	20200L1 G	\$399.58

XT Cylinder for Marks

Description	Part Number	Price
Cylinder for Marks 110, 170, 180, 190, 195, 295 series Vestibule, Communicating, Classroom, & Classroom Security functions (DA, DC, SB, S).	20200V0 G	\$397.29
Cylinder for Marks Lever 110, 170, 180, 190, 195, 295 series in Entrance, Institution, Storeroom, and Corridor functions (AB, DW, F, T)	20200V1 G	\$397.29

XT Cylinders for Olympus

Description	Part Number	Price
Cylinder for Olympus 700 LCM & 800 LCM Key Retaining	20200S1 G	\$399.58

XT Cylinders for PDQ

Description	Part Number	Price
Cylinder for PDQ Lever SP & ST Series, GT, XGT, & GP Series	20200V2 G	\$397.29

XT Cylinders for Sargent

Description	Part Number	Price
Cylinder for Sargent 10 line locksets, order with '30' option prefix (note: cylinder will extend from lever more than standard cylinder)	20200S1 G	\$399.58

XT Cylinders for Schlage

Description	Part Number	Price
Cylinder Package for Schlage A, AL, C, D, ND & Olympiad lever designs, includes: CT-Y49 (A, AL, & D Olympiad Lever & C & D Plymouth), CT-Y52 (C & D heavy duty knobs Ball, Globe & Sphere designs only), CT-Y53 (A series Orbit), CT-Y73 (ND series Gr. 1 lever & AL thick doors), and CTY74 (45-101 padlock)	20200S1 G	\$399.58
Cylinder for Schlage S Series Lever	2020097 G	\$399.58

XT Cylinders for TACO

Description	Part Number	Price
Cylinder for Olympus 700 LCM & 800 LCM Key Retaining	20200S1 G	\$399.58

XT Cylinders for Yale

Description	Part Number	Price
Cylinder for Yale 6 pin 5300LN, 5400LN and 4300 Knobs	200503 G	\$397.29

How To Order Key-in-Knob/Lever Cylinders

Complete part numbers are required for all orders. To determine the correct part number, fill in the "X's" in sequential order.

<p style="text-align: center;">200200S1 Base Part #</p> <p style="text-align: center; font-size: small;">Refer to description to find the corresponding base part number.</p>	<p style="text-align: center;">G Cylinder</p> <p style="text-align: center; font-size: small;">G = Medeco XT</p>	<p style="text-align: center;">26 Finish</p> <p style="text-align: center; font-size: small;">Refer to page 36 for finish options. Include the corresponding two digit finish number.</p>
--	---	--

<p>Key-in-Knob/Lever PART #:</p> <p>Key-In-Lever Cylinder _____</p> <p>Obtain from Product Listing _____</p> <p>Cylinder Technology _____</p> <p style="font-size: small;">G = Medeco XT</p>	<p>200200S1 G XX</p>	<p>Finish</p> <p>06 = Satin Brass (US04)</p> <p>24 = Dk Bronze/Clear Coat (US20A)</p> <p>26 = Satin Chrome (US26D)</p>
---	-----------------------------	---

All Weather Padlocks

The Medeco All Weather Padlock (AWP) offers the highest level of severe weather protection. The body is solid 303 stainless steel and is available with either stainless steel or boron shackles. A weatherproof cylinder seal cap, attached by a stainless steel cable, seals the cylinder from harsh environments. Multiple mechanical and Intelligent Key technologies are available.

The AWP is not only weatherproof, it is also a high security padlock when a Medeco 4 (M4) cylinder is included. M4 cylinders provide the benefit of patented key control and resistance to surreptitious attacks while both the Medeco CLIQ and Medeco XT cylinders add sophisticated audit and control features.



Benefits:

- 300 Series, solid, machined stainless steel body resists attack and corrosion
- 5/16" and 7/16" diameter, stainless steel and boron shackles
- 1 7/8", 2 3/8", 2", and 2 1/2" shackle lengths
- Padlocks are shipped with a weather proof cylinder seal cap attached by a stainless steel cable
- IP68 Environmental protection rating for harsh environments
- ASTM F883-13 rating for tensile pull, shock, plug pull, plug torque, cutting, and corrosion (salt fog)
- Vibration tested per MIL-STD-202G, method 201A
- Key retaining cylinder design
- O-ring sealed cap, cylinder, and shackles resist grime and water penetration at low temperatures

Warranty:

Warranted for two (2) years against manufacturer's defects. See the Medeco limited warranty for full details.

Applications:

The AWP series is designed for installations requiring service in harsh weather conditions. Applications include outdoor perimeter fencing, gates, tool cabinets, storage, and transportation cargo containers. Ideal for Intelligent Key cylinders in outdoor harsh environments.

All Weather Padlocks

Description	Part No.	Price
All Weather Padlock, 5/16" SS shackle, 1 7/8" Clearance	5005511 G	\$603.47
All Weather Padlock, 5/16" SS shackle, 2 3/8" Clearance	5005521 G	\$608.47
All Weather Padlock, 5/16" Boron shackle, 1 7/8" Clearance	5005531 G	\$603.47
All Weather Padlock, 5/16" Boron shackle, 2 3/8" Clearance	5005541 G	\$608.47
All Weather Padlock, 7/16" SS shackle, 2" Clearance	5005711 G	\$603.47
All Weather Padlock, 7/16" SS shackle, 2 1/2" Clearance	5005721 G	\$608.47
All Weather Padlock, 7/16" Boron shackle, 2" Clearance	5005731 G	\$603.47
All Weather Padlock, 7/16" Boron shackle, 2 1/2" Clearance	5005741 G	\$608.47

All Weather Padlock Cylinders

Description	Part No.	Price
XT All Weather Padlock Cylinder	510800 G	\$344.29

System Series Padlocks

The System Series padlock offers security for a multitude of applications. It has an indoor/outdoor weather resistant design with or without a shrouded shackle. Both models utilize a boron alloy steel shackle which provides protection against cutting and pulling attacks.



Technical Features:

- Available with either a 5/16 inch or a 7/16 inch shackle diameter.
- Available in Indoor/Outdoor weather resistant design or with a shrouded shackle.
- Extended shackles available for Indoor/Outdoor padlocks only.
- The shrouded shackle design provides extra shackle protection against cutting attacks.
- All Medeco® cylinders are constructed of durable machined brass components, designed to last the life of your equipment.
- Boron alloy steel shackle which protects against cutting and pulling attacks.
- Available in a variety of different shackle lengths.

Applications:

Used in a variety of different indoor or outdoor applications where high security and key control are a primary concern.

Warranty:

Warranted for two (2) years against manufacturer's defects. See the Medeco® limited warranty for full details.

Finishes:

The padlock comes in a standard black body cover and the cylinders are furnished in satin brass finish.

System Series Padlocks

Description	Part No.	Price
SS Indoor/Outdoor Padlock, Non-Key Retaining, 1 1/8" Shackle Clearance, 5/16" Shackle Diameter, w/Cylinder	5451500 G	\$537.41
SS Indoor/Outdoor Padlock, Key Retaining, 1 1/8" Shackle Clearance, 5/16" Shackle Diameter, w/Cylinder	54515R0 G	\$537.41
SS Indoor/Outdoor Padlock, Non-Key Retaining, 2 3/8" Shackle Clearance, 5/16" Shackle Diameter, w/Cylinder	5451F00 G	\$541.41
SS Indoor/Outdoor Padlock, Key Retaining, 2 3/8" Shackle Clearance, 5/16" Shackle Diameter, w/Cylinder	5451FR0 G	\$537.41
SS Shrouded Padlock, Non-Key Retaining, 3/4" Shackle Clearance, 5/16" Shackle Diameter, w/Cylinder	5452500 G	\$565.41
SS Shrouded Padlock, Key Retaining, 3/4" Shackle Clearance, 5/16" Shackle Diameter, w/Cylinder	54525R0 G	\$565.41
SS Indoor/Outdoor Padlock, Non-Key Retaining, 1 3/8" Shackle Clearance, 7/16" Shackle Diameter, w/Cylinder	5471500 G	\$565.41
SS Indoor/Outdoor Padlock, Key Retaining, 1 3/8" Shackle Clearance, 7/16" Shackle Diameter, w/Cylinder	54715R0 G	\$565.41
SS Indoor/Outdoor Padlock, Non-Key Retaining, 1 7/8" Shackle Clearance, 7/16" Shackle Diameter, w/Cylinder	5471F00 G	\$577.41
SS Indoor/Outdoor Padlock, Key Retaining, 1 7/8" Shackle Clearance, 7/16" Shackle Diameter, w/Cylinder	5471FR0 G	\$577.41
SS Shrouded Padlock, Non-Key Retaining, 3/4" Shackle Clearance, 7/16" Shackle Diameter, w/Cylinder	5472500 G	\$619.41
SS Shrouded Padlock, Key Retaining, 3/4" Shackle Clearance, 7/16" Shackle Diameter, w/Cylinder	54725R0 G	\$619.41

Note: In this section, "SS" stands for "System Series."

XT Padlock Cylinders

Description	Part Number	Price
XT System Series Padlock, Cylinder Only	510600 G	\$437.36

Hockey Puck Padlocks

Medeco® Hockey Puck style padlocks come with hardened solid steel bodies and a shackle-less design for the highest level of protection against bolt cutter attacks. They are completely serviceable and can be re-keyed in case of lost or stolen keys.

The 304 stainless steel body provides the highest combination of drilling resistance, cutting resistance, and weatherability. The shackle-less design with a hidden bolt provides the highest level of protection against bolt cutter attacks. Hockey puck padlocks are completely serviceable and can be re-keyed in case of lost or stolen keys.



Technical Features:

- Body width: 2-7/8"
- Shackle: 3/8" diameter
- 304 stainless steel body
- LFIC and key-in-knob/lever cylinders
- Requires a key to relock
- Flat-back design or step-back design
- Shackle-less design with a hidden bolt for a high level of protection against bolt cutter attacks
- Pre-machined holes in the back allow for flexible mounting options

Applications:

Hockey Puck style padlocks can be used in a variety of different applications including vending, storage and transportation.

Description	Part Number	Price
Hockey Puck Padlock	5292000 G	\$530.21

Warranty:

Warranted for two (2) years against manufacturer's defects. See the Medeco® limited warranty for full details.

G8R Padlocks

Medeco® offers a variety of High Security Padlocks that are designed to accept both mechanical and Intelligent Key cylinders. With its tough, weather resistant construction, this is the padlock of choice for extreme environments such as trailers, cargo containers, and gates. The Medeco® G8R body is constructed of solid stainless steel. You can choose from either a stainless steel shackle for maximum corrosion resistance, or hardened steel to withstand severe physical attack. Each padlock includes a weather seal cap attached by a cable. The Medeco® G8R will accept either an Intelligent Key or mechanical t-handle cylinder. The mechanical cylinders provide the benefit of patented key control and pick resistance. Intelligent Keys sophisticated audit and control features transforming the G8R into a portable access control system for extreme environments.

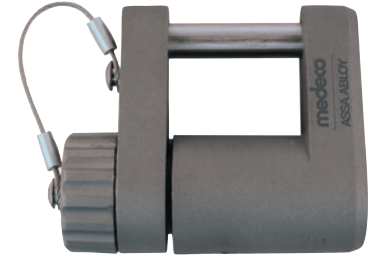

Weather Resistant Construction

Uses a weather seal cap, attached by a cable, to provide protection from water and road grime.

Technical Information:

- 300 series, cast stainless steel body.
- Padlock is sold less cylinder. Compatible with Medeco® mechanical and NEXGEN electronic t-handle cylinders.
- Padlocks are shipped with a weather seal cap attached by a steel cable. A finish plate is included for applications that do not require the weather seal cap.
- Sealed construction protects cylinders from water and road grime.
- Stainless steel body resists attack and corrosion.
- Shackles can be specified in stainless or hardened steel to fit your application.

Applications:

- The G8R Series was designed for locking installations requiring weather resistance and strong physical security. Applications include: cargo containers, trailer doors, gates, vending machines.

Warranty:

Warranted for two (2) years against manufacturer's defects. See the Medeco® limited warranty for full details.

G8R Series Padlock

Description	Part Number	Price
G8R Weather-tight Padlock, 5/16" Stainless Steel Shackle, less pop-out cylinder	52110040	\$196.00
G8R Weather-tight Padlock, 5/16" Hardened Steel Shackle, less pop-out cylinder	52111040	\$196.00
G8R Weather-tight Padlock, 7/16" Stainless Steel Shackle, less pop-out cylinder	52120040	\$196.00
G8R Weather-tight Padlock, 7/16" Hardened Steel Shackle, less pop-out cylinder	52121040	\$196.00
G8R cap and seal kit	94-0213	\$33.20

G8R padlocks are sold less cylinder and use a cam lock style key with pop-out plug.

Keys are charged separately for this style cylinder.

G8R Series Padlock Cylinders

Description	Part Number	Price
G8R Padlock, Pop-Out Cylinder – Round Deadbolt	EV-8501D	\$410.00
G8R Padlock, Pop-Out Cylinder – Round Springbolt	EV-8501S	\$410.00

Specialty Cylinder Formats

The Medeco® XT Electronic T-handle Cylinders are an ideal for loss and liability management and are available for many specialty applications and formats. Pop-Out Cylinders are available in spring-latch and deadbolt configurations. Stainless steel shell and bolt for lasting strength, durability and strong protection against physical attack. Fits all NAMA Standard T-Handles. Ideal for vending & bottling, bill changers, ATM equipment or other custom OEM applications.



Specialty Cylinder Formats

Description	Part Number	Price
Ruko (inside)	230501S G	\$359.00
Ruko (outside)	230601S G	\$359.00
Snowman (padlock)	230801S G	\$359.00
Mul-T-Lock padlock (G47 Series)	490431 G	\$367.00
XT Insert For Enclosure Lock	EA-100219	\$381.00
Safe Deposit Box Single – Left Hand	490428 G	\$397.74
Safe Deposit Box Single – Right Hand	490429 G	\$397.74

Safe Deposit Box also available in Double.

Pop-Out Cylinders

Description	Part Number	Price
Pop-Out Cylinder Deadbolt assembly, round bolt	EV-8501D	\$410.00
Pop-Out Cylinder, springbolt assembly, round bolt	EV-8501S	\$410.00

Retail/Showcase Locks

Medeco® XT has an electronic cylinder for many types of retail applications. Ideal for loss & liability management with flexible authorization and auditing capabilities. Respond quickly to security threats, lost or stolen keys, or personnel changes without the added cost of changing your locks and keys. The cylinder is powered by the rechargeable key so no wiring or power supply is needed. Medeco XT Plunger Locks are specifically designed for use in wooden or metal sliding doors. Cabinet style locks are also available and along with the plunger locks are ideal applications for security merchandise showcases, metal cabinets, and laboratory and office furniture.



XT Retail/Showcase Locks

Description	Part Number	Price
Cabinet Lock, Latchbolt	490359 G	\$489.00
Cabinet Lock, Deadbolt	490366 G	\$489.00
XT Deadbolt Cabinet Lock, KR	6210555 G XX	\$421.74
XT Deadbolt Cabinet Lock, NKR	6212555 G XX	\$421.74
XT Spring Latch Cabinet Lock	6211555 G XX	\$439.74
XT T Bolt Cam Lock, KR	6280550 G	\$394.74
XT T Bolt Cam Lock, NKR	6282550 G	\$394.74

Cam and Utility Locks

Medeco® XT cam locks are built for strong physical security and offer all the benefits of the XT Electronic Locking System. XT cam locks are available in lengths of 7/8" and 1-1/8" with a wide variety of cams and security collars. The cylinder is designed for interior and exterior use and requires no wiring or modification to the door. Audit information recorded in both the lock and key shows a time-and-date stamped record of every event, including authorized accesses and unauthorized attempts. A quick retrofit to existing hardware, XT cam locks are ideal for utility cabinets, retail fixtures, narcotics storage, safes and more.



XT Cam Locks

Description	Part Number	Price
7/8" Cam lock assembly, Key Retaining	EN-150002-XXX (Op Code)	\$410.00
1-1/8" Cam lock assembly, Key Retaining	EN-150003-XXX (Op Code)	\$410.00

Cam Lock Operation Codes

Description	Op Code
2 flat, 1 keypull, clockwise 90 degree	219
2 flat, 1 keypull, counter-clockwise 90 degree	239
2 flat, 1 keypull, clockwise 180 degrees	259

XT T-bolt Cylinders

Description	Part Number	Price
XT T-bolt – Key Retaining, unlocked at 180 degree	6280550 G -XX	\$394.74
XT T-bolt – Non-Key Retaining, unlocked at 360 degree	6282550 G -XX	\$394.74

XT Cam Lock

Description	Part Number	Price
1 1/8" Cam lock assembly, Non-Key Retaining	600650269 G -XX	\$399.30



XT Switch Locks

Description	Part Number	Price
2 Position, Key Retaining	6522560 G -121-XX	\$378.35
2 Position, Non-Key Retaining	6522560 G -122-XX	\$378.35

Medeco® XT Dual-Tech Cylinder

For Rapid-Entry Applications

The patented Medeco XT Dual-Tech retrofit cylinder is designed for both accountability and rapid-entry applications. It combines two cylinder technologies – the Medeco XT electronic cylinder and the Medeco X4 mechanical cylinder – in one mortise cylinder housing. Both cylinders operate independently of one another so access is provided using either the XT Key or the X4 key.



Allows fire department emergency facility access using a familiar mechanical key while the XT Intelligent key is used for daily accountability. In multi-family applications, tenants use the mechanical key and maintenance uses XT key for accountability. Ideal for any application requiring a mechanical key override.

Medeco Dual Tech Cylinder

Description	Part Number	Price
XT Dual Tech 1-1/4" Mortise Cylinder, with Medeco X4	490423 G	\$626.50
XT Dual Tech 1-1/4" Mortise Cylinder for Arrow/Best	490426 G	\$626.50
XT Dual Tech 1-3/4" Mortise Cylinder	490437 G	\$633.50
XT Dual Tech Rim Cylinder	490432 G	\$934.50

XT Dual-Tech Cams

Dual Tech mortise cylinders come complete with a set of 2 specially designed cams, a direct-drive cam operated by the Medeco XT key and an Override cam operated by the Mechanical key. Cam type must be indicated when ordering (Z00, Z01, etc.)

Important Note: The standard cams listed on pages 82-83 cannot be used in Dual-tech cylinders. Replacement cams must be ordered using the chart below. One each direct drive and override cam required per cylinder.

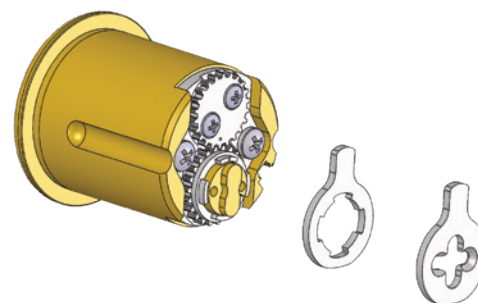

Dual Tech Cams

Description	Part Number	Price
Direct Drive Cam – Russwin	CP-100771-Z00	\$15.34
Override Cam – Russwin Type	CP-100781-Z00	\$15.34
Direct Drive Cam – Yale Type	CP-100771-Z01	\$15.34
Override Cam – Yale Type	CP-100781-Z01	\$15.34
Direct Drive Cam – Adams Rite	CP-100771-Z02	\$15.34
Override Cam – Adams Rite Type	CP-100781-Z02	\$15.34
Direct Drive Cam – Sargent	CP-100771-Z20	\$15.34
Override Cam – Sargent Type	CP-100781-Z20	\$15.34
Direct Drive Cam – Schlage	CP-100771-Z34	\$15.34
Override Cam – Schlage Type	CP-100781-Z34	\$15.34

How to Order a DualTech Cylinder

Technology	Base Part Number	Finish	Keyway	Pinning	Cam
X4	490423G	XX	XX	XX	XX
X4	490437G	XX	XX	XX	XX
X4	490432G	XX	XX	XX	XX
Arrow	490426G	XX	XX	XX	XX

Pinning Options:
 S = Sub Assembled
 P = Pinned
 M = Master Keyed

Medeco XT Traffic Cabinet Lock

The Medeco XT Traffic Cabinet Lock helps to secure our critical infrastructure. The Intelligent Traffic System (ITS) cabinets located at every street corner contain hardware that control our cities streets. Cyber attack is a constant threat. A simple retrofit lock solution like the Medeco XT Traffic Cabinet Lock is the quickest, most cost-effective way to add the accountability necessary to help eliminate tampering with the advanced equipment contained within these cabinets.

Available through specialized resellers only.



Medeco XT Traffic Cabinet Lock:

Description	Part Number	Price
XT Traffic Cabinet Lock – Deadbolt*	EA-100221	\$488.00
XT Traffic Cabinet Lock – Slam bolt*	EA-100220	\$511.00
High Security Mechanical Traffic Cabinet Lock – Deadbolt*	490435	\$230.00
High Security Mechanical Traffic Cabinet Lock – Slam bolt*	490436	\$232.00

* Can be installed in left-hand or right-hand doors.

XT Safe Lock

The Medeco XT Safe Lock is a direct replacement for physical security devices that utilize standard mechanical dial combination locks or digital keypad locks. XT Safe Lock includes a reader with key port mounted on the outside of the safe door, and is available three XT lock configurations deadbolt, spring bolt and swing bolt.

To access the safe, an XT Key is programmed via the Medeco XT Web Management Software system to only open a specific XT Safe Lock and the key is issued to a specific user. The user inserts the XT Key into the key port on the exterior reader. Power is supplied by the key to the lock PCB and authentication is initiated with a secure process over the interface communications cable.

An LED provides visual feedback to the user on the current state of the lock. If the lock PCB and XT Key are in agreement that access is granted, the lock PCB will provide power to the internal motor/bolt blocker and the user is allowed to rotate the key to unlock the lock. If the XT Key is not authorized, the user will be prevented from unlocking the safe lock.



XT Safe Lock:

Description	Part Number	Price
XT Safe Lock – Deadbolt Lock Bundle	EA-100206	\$972.00
XT Safe Lock – Spring Bolt Lock Bundle	EA-100207	\$972.00
XT Safe Lock – Swingbolt Lock Bundle	EA-100208	\$972.00

International Cylinders

The Medeco® XT Modular Half Profile, Euro Double & Thumb Turn electronic cylinders are a direct replacement for like mechanical cylinders and are ideal for loss and liability management. In addition to international uses, many of these cylinders fit imported hardware used in North America. The cylinder requires no wiring or modification to the door or frame and is designed for interior and exterior use. Attack-resistant design and tamper-proof features provide strong protection against forced entry. Flexible key programming and auditing capabilities allow for quick response to security threats, lost or stolen keys, or personnel changes. Cylinders are widely used at government installations, airports, hotels, universities and schools. Medeco XT is a complete electronic locking system providing controlled access, accountability, physical security, and system management.



XT International Cylinders

Description	Part Number	Price
Lockwood Oval	230301S G	\$333.00
Cylinder Module EURO 1/2 Module – 30mm	232201S 300 G	\$312.02
Cylinder Module EURO 1/2 Module – 35mm	232201S 301 G	\$316.27
Cylinder Module EURO 1/2 Module – 40mm	232201S 302 G	\$320.52
Single/Double cylinder Module EURO 1/2 Module – 30mm	232202S 300 G	\$316.27
Single/Double cylinder Module EURO 1/2 Module – 35mm	232202S 301 G	\$316.27
Single/Double cylinder Module EURO 1/2 Module – 40mm	232202S 302 G	\$320.52
Euro T/T Profile – 30mm/30mm Assembled	23230XS X00 G	\$403.60
Euro T/T Profile – 35mm/35mm Assembled	23230XS X11 G	\$412.10
Modular Profile Cylinder – 30mm Half Profile - Assembled	232301S 800 G	\$361.53
Modular Profile Cylinder – 35mm Half Profile - Assembled	232301S 801 G	\$365.78
Euro 1/2 Profile 30mm Assembled (True 30mm)	232301ST 800 G	\$361.53
Euro Double Profile – 30mm/30mm Assembled	23230E5 X00 G	\$477.08
Euro Double Profile – 35mm/35mm Assembled	23230E5 X11 G	\$485.58

XT Guard Tour Reader

The Medeco XT Guard Tour Reader is a simple, yet powerful, user tracking solution that can be added to any XT Intelligent Key system. The reader mounts easily to any interior or exterior flat surface and programs just like a standard XT cylinder. As the designated 'Tour' individual makes their rounds, they simply touch the reader with their XT key which creates an audit event that proves they completed this task. A record of activity is available for audit or reporting at any time.



XT Guard Tour Reader

Description	Part Number	Price
XT Guard Tour Reader	EA-100240	\$467.00

Medeco® XT Access Interface Module (AIM)

The Medeco® XT Access Interface Module – known as “AIM” – allows the user to insert their Medeco XT key to trigger actions in other systems. Using both authorized and unauthorized event conditions, users can unlock doors with electric strikes or maglocks, initiate video cameras and bring attention to unauthorized events by triggering access control or alarm panels.



AIM Features:

- Greatly enhances the capability of the Medeco XT Intelligent Key System
- Key audit tracks events just like an XT cylinder
- Two-person authentication option
- Uses NO – Normally Open and NC – Normally Closed relays to trigger different outputs for Access Granted or Access Denied events
- Can be powered by an XT key or 12-24V Power Supply depending on AIM connection

Warranty:

Medeco Security Locks warrants Medeco® XT products to be free of defects in material and/or workmanship for a period of two (2) years from date of original purchase.

Applications:

Medeco XT AIM module can be used with other Access Control or Alarm Panels to trigger authorized and unauthorized event conditions.

Medeco XT Access Interface Module (AIM):

Description	Part Number	Price
Medeco XT Access Interface Module	EA-100192	\$890.00



Medeco Nexgen

Medeco® Nexgen is a comprehensive loss prevention system incorporating access control, audit capability, physical security, and route management for applications such as parking and vending.

In addition to physical protection, the Medeco® Nexgen system gives you the ability to program who gets into your locks and when they get in. The system will also track all activity, including unauthorized attempts to open the lock.

These functions are integrated into software that provides key management capability and can be customized to meet your specific requirements. The software provides detailed, flexible reports for complete security management.

All Medeco® Nexgen products have the ability to be linked together throughout your system to provide full integration. One key can be programmed to open any combination of locks.



Nexgen Locks/Cylinders

Description	Part Number	Price
Nexgen 7/8" Cam Lock, Cale Style	EN-100000	\$407.00
Nexgen 7/8" Cam Lock	EN-100002-219	\$398.00
Nexgen 1-1/8" Cam Lock	EN-100003-219	\$398.00
Retrofit Parking Cylinder, LA/KABA Style	EN-400001	\$407.00
Retrofit Parking Cylinder, Medeco OEM	EN-400002	\$407.00
Retrofit Parking Cylinder, Medeco VLS Replacement	EN-400004	\$407.00
Retrofit Parking Cylinder, Duncan 76	EN-400005	\$407.00
Retrofit Parking Cylinder – POM	EN-400006	\$407.00
Retrofit Parking Cylinder – Parkeon	EN-400007	\$407.00
Nexgen Deadbolt Popout (G8R)	EV-8000D	\$398.00

Nexgen Door/Lock Assemblies

Description	Part Number	Price
Round Door Assembly (short brackets/low capacity)	EP-1210	\$553.11
Round Door Assembly (long brackets/high capacity)	EP-1211	\$553.11

Nexgen Keys

Description	Part Number	Price
NEW – Nexgen2 Parking Key-extended nose/Bluetooth	EV-5507	\$1,569.00

Nexgen Accessories

Description	Part Number	Price
NEW – NexGen2 USB Desktop Programmer w/USB cable	EA-100235	\$401.00
New NexGen2 Multi-key programmer/charger-wall mountable-daisy chain	EA-100200	\$6,383.00
Same as above no cables	EA-100234	\$5,773.87
Pogo Pin Kit Collector	94-0171	\$107.00
T-Handle 7/64" Screw Removal	CP-284490	\$27.50
T-Handle 3/32" for Screw Removal	CP-286080	\$27.50
Cleaning Cloth	CP-286170	\$10.20
Brush	CP-286180	\$35.10
Needle Nose Pliers	CP-286190	\$62.70
Deburring Tool	CP-286550	\$729.00
Contact Cleaner Pen	CP-301290	\$83.60
Contact Cleaner Spray	CP-301350	\$204.00
Repl Key Tip Package (extended nose key) & Screws	EA-300071	\$331.00

Nexgen Software

Description	Part Number	Price
NEW-XT Web Parking Software (Medeco Hosted)* CHARGED ANNUALLY	SW-500301-3	\$3,743.00
NEW-XT Web Parking Software (User Hosted)	SW-600901	\$25,981.00

Intelligent Key Cabinet (IKC)

The Intelligent Key Cabinet is a complete, electronically-controlled, key management solution that can secure, distribute and audit the use of XT Keys, mechanical keys, or other assets. Only authorized users can gain access to the cabinet via the included biometric fingerprint reader or PIN code pad, or a combination of both. An optional access card reader is also available. IKC is available in configurations to store mechanical keys, XT electronic keys or a combination of both. As an essential addition to any Medeco XT Intelligent Key system, it locks XT keys in place and keeps them charged and ready for use. The IKC can improve employee efficiency and increase accountability which translates into a more secure facility with lower operating costs.



Benefits:

- **Accountability:** No more wondering who has checked out keys or for how long. Complete audit trail and reporting by user and key activity. User accountability reduces lost keys. Fewer lost keys leads to lower expenses and improved security.
- **Analytics:** Identify potential problems in removal and return patterns before they escalate. Complete reporting suite provides multiple reporting options to provide real-time data. Reports can be automatically generated and sent to multiple users by email. Custom reports can be configured and exported to Excel for added convenience.
- **Security:** Loose keys are vulnerable to being misplaced or stolen. Only authorized users are able to access the electronic key management system. Biometric Fingerprint, PIN, and/or Prox Card authentication (optional) allow access to the IKC for added security and control. The IKC supports dual authentication if desired. For added security, a digital photo capture of each login can be added.
- **Convenience:** Allow employees to retrieve keys quickly without waiting for a manager. Quick, easy-to-use web-based or locally hosted software shows what keys are in, what keys are out, and to whom they are issued. The IKC allows the return of any key to any location in the cabinet, and then learns the key's new location.
- **Productivity:** Eliminate time spent searching for, or replacing lost keys – always know who took which key, and when.
- **Efficiency:** Pair with a full XT solution to identify patterns and workflows to gain even greater efficiency and security. XT version cabinets charge and program keys while they are secured and stored, ensuring keys are always ready to go.

Features:

- Heavy-duty enclosure keeps keys safe and secure
- Distributes keys only to authorized users
- Admin notifications (email and SMS) for unreturned keys
- Available in 3 cabinet sizes. Cabinet storage capacities are 32, 64, 96, 128, 160, 192, 224, 256, and 288 (Max capacity for XT version is 64 per cabinet).
- Three versions available: XT, iFob, and Hybrid
- Locks XT keys in place and keeps them charged and ready for use. (XT version)
- Identifies XT key serial number (XT version)
- XT version integrates to XT Web Manager Enterprise
- Built-in 10" touchscreen and fingerprint reader
- Multi-factor verification/authentication includes biometric finger scan, PIN, and Prox Card.
- Audible and visual alarms to indicate trouble conditions
- Built-in camera for photo verification of removal or attempted removal.
- Comprehensive reporting & analytics
- Emergency Fob Release System
- Multi-System Networking
- Medeco high security mechanical lock for manual override
- Options (see page 69 for full list of options):
 - Mounting: Custom Stand - holds 1 or 2 Standard or Mini cabinets to securely hold the cabinets in place without having to mount them on a wall.
 - User authentication: A Multi-class reader is available for purchase or the customer can supply their own reader for installation. (A reader and test card must be provided to Medeco for testing before the cabinet is manufactured to ensure proper compatibility.)

Intelligent Key Cabinet (IKC)

Standard Cabinet

LCD touchscreen used for PIN code authentication, warning messages as well as PC troubleshooting

High security mortise cylinder for manual override

Web-Cam for optional photo verification of access or attempted access

XT Programming Port
Included on XT and Hybrid versions only

Biometric Fingerprint Reader
used for authentication

Add-On Cabinet

High security mortise cylinder for manual override

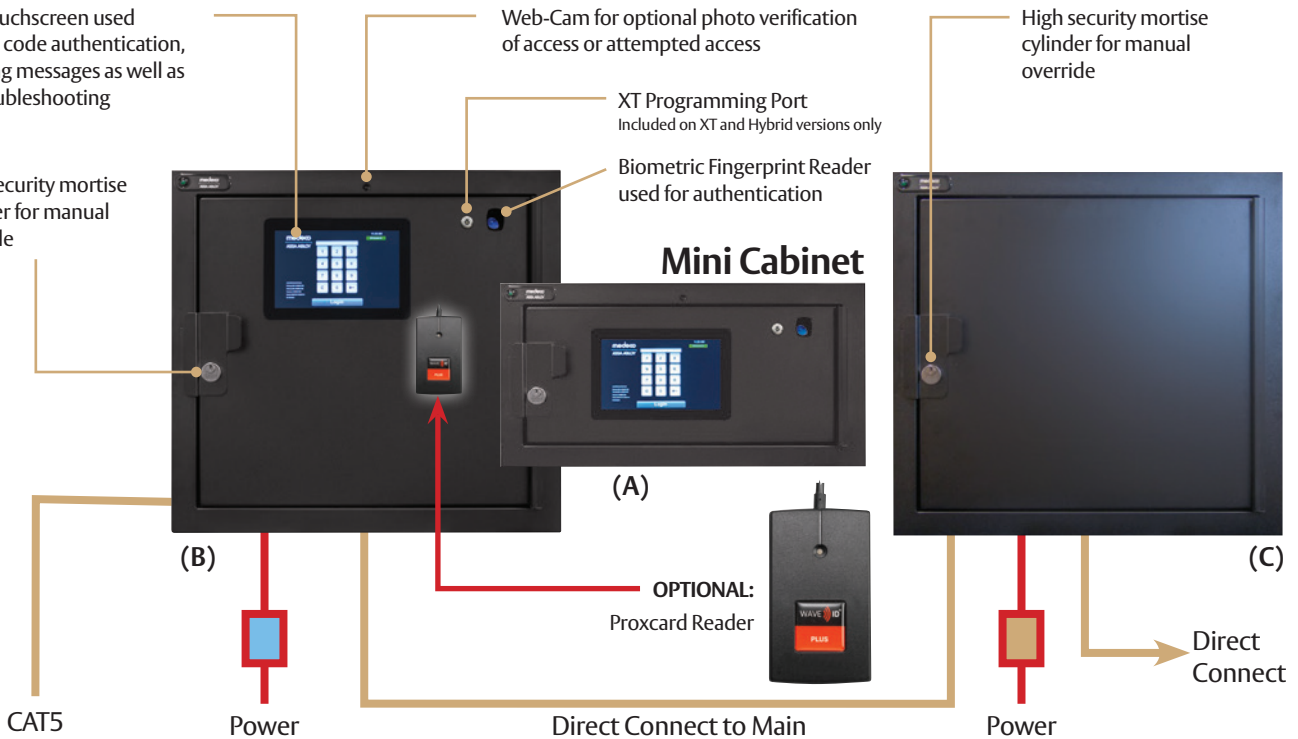

Scalability:

The IKC system can grow as business needs grow by adding on additional secondary cabinets from 32-288 port sizes for iFob units and in a combination of technologies (iFob or XT).

- Each system requires one 'Main' touchscreen cabinet
- Add additional cabinets as needs require
- System can be any combination of 32 or 64 port cabinets
- 32 port cabinets support either XT or iFob ports
- 64 port cabinets support either all XT, all iFob, or a combination of 32 XT plus 32 iFob.
- Main and Secondary boxes can be configured with same technology or different
- Up to 7 Add-on units maximum (512 keys) for every Main unit

Large Cabinet:

- 27" W x 46" H x 11" D
- Weight: 290 pounds
- May require wall reinforcement for mounting
- 160 to 288 key positions
- Available as iFob Main or Add-On Cabinet

Mini Cabinet (Image A):

- Main Cabinet (Image A) 27" W x 14.72" H x 12" D
- Can be stand alone or connected to Add-on cabinet
- Weight: 71 pounds
- Technology – Select All XT or All iFob
- Main and Add-on cabinets can be configured with same technology or different
- 32 key positions

Standard Cabinet (Image B):

- Main Cabinet (Image B), 32 or 64 ports, 27" W x 25.25" H x 12" D
- Weight: 113 pounds
- Can be stand alone or connected to secondary cabinet
- Technology – Select All XT, All iFob, or 32 XT plus 32 iFob
- Main and Add-on cabinets can be configured with same technology or different
- 32-64 key positions – XT/hybrid
- 32-128 key positions – iFob

Add-on Cabinet (Image C):

- Add-on Cabinet (Image C), 27" W x 25.25" H x 12" D
- Available with 32 or 64 ports
- 32 port option expandable to 64 with additional 32 port panel (sold separately)
- Must be connected to a Main cabinet

Intelligent Key Cabinet (IKC)

How to Order:

<p>1</p> <p>EA-100199 Base Part #</p> <p>Refer to pages 67 to 68 for descriptions and technical specifications to find the corresponding base part number.</p>	<p>2</p> <p>M Main Cabinet</p> <p>M = Main Cabinet A = Add On</p>	<p>3</p> <p>D Input Device</p> <p>D = Multi-Class Card Reader 0 = No Input Device*</p> <p>*Note: Input options available on Main cabinet units only.</p>	<p>4</p> <p>1 With Stand</p> <p>0 = No Stand 1 = With Stand</p>
--	---	--	---

EXAMPLE: 32 PORT XT MAIN CABINET, INPUT DEVICE, WITH STAND

EA-100199 - M D 1

Base Number for Intelligent Key Cabinet (IKC)

Base Numbers:

- EA-100199-XXX – 32 port XT Standard
- EA-100236-XXX – 32 port iFob Mini
- EA-100237-XXX – 32 port XT Mini
- EA-100247-XXX – 64 port XT Standard
- EA-100248-XXX – 32 port iFob Standard
- EA-100249-XXX – 64 port iFob Standard
- EA-100250-XXX – 32 XT/32 iFob Combo Standard
- EA-100259-XXX – 96 port iFob Standard
- EA-100260-XXX – 128 port iFob Standard
- EA-100261-XXX – 160 port iFob Large
- EA-100262-XXX – 192 port iFob Large
- EA-100263-XXX – 224 port iFob Large
- EA-100264-XXX – 256 port iFob Large
- EA-100265-XXX – 288 port iFob Large

Stand Options

0 = No Stand
1 = With Stand

External Input Options

D = Multi-class Card Reader
0 = No Input Device*

Cabinet Type (Main or Add-on)

M = Main Cabinet
A = Add On (Note: Add-on cabinets not available in mini size)

Intelligent Key Cabinet



Mini Cabinet



Standard Cabinet



Add-On Cabinet



Large Cabinet

IKC Software Options

Part Number	Description	Price
SW-500141	Medeco-hosted software for IKC, up to 5 cabinets, billed annually	\$1,073.00
SW-500141-1	Self-hosted software for IKC on-site server installations, iFob version only, one-time purchase	\$1,073.00
SW-500141-1R	Annual maintenance fee for IKC self-hosted software, billed annually	\$202.00

Intelligent Key Cabinet

Part Number	Ports	Type (Standard, Mini, Large)	Description	Price
EA-100237-M00	32	XT - Mini	Mini-Cabinet, 32 port XT main, no input, without stand	\$28,571.00
EA-100237-MD0	32	XT - Mini	Mini-Cabinet, 32 port XT main, Multi-class reader input, without stand	\$29,743.00
EA-100237-M01	32	XT - Mini	Mini-Cabinet, 32 port XT main, no input, with stand	\$30,035.00
EA-100237-MD1	32	XT - Mini	Mini-Cabinet, 32 port XT main, Multi-class reader input, with stand	\$31,207.00
EA-100236-M00	32	iFob - Mini	Mini-Cabinet, 32 port iFob main, no input, without stand	\$20,937.00
EA-100236-MD0	32	iFob - Mini	Mini-Cabinet, 32 port iFob main, Multi-class reader input, without stand	\$22,109.00
EA-100236-M01	32	iFob - Mini	Mini-Cabinet, 32 port iFob main, no input, with stand	\$22,401.00
EA-100236-MD1	32	iFob - Mini	Mini-Cabinet, 32 port iFob main, Multi-class reader input, with stand	\$23,573.00
EA-100199-M00	32*	XT - Standard	32 port XT main cabinet, no input, no stand	\$28,571.00
EA-100199-MD0	32*	XT - Standard	32 port XT main cabinet, Multi-class card reader input, no stand	\$29,743.00
EA-100199-M01	32*	XT - Standard	32 port XT main cabinet, no input, with stand	\$30,035.00
EA-100199-MD1	32*	XT - Standard	32 port XT main cabinet, Multi-class card reader input, with stand	\$31,207.00
EA-100199-A00	32*	XT - Standard (add-on)	32 port XT add-on cabinet without stand	\$17,322.00
EA-100199-A01	32*	XT - Standard (add-on)	32 port XT add-on cabinet with stand	\$18,787.00
EA-100247-M00	64	XT - Standard	64 port XT main cabinet, no input, without stand	\$34,486.00
EA-100247-MD0	64	XT - Standard	64 port XT main cabinet, Multi-class card reader input, without stand	\$35,658.00
EA-100247-M01	64	XT - Standard	64 port XT main cabinet, no input, with stand	\$35,950.00
EA-100247-MD1	64	XT - Standard	64 port XT main cabinet, Multi-class card reader input, with stand	\$37,122.00
EA-100247-A00	64	XT - Standard (add-on)	64 port XT add-on cabinet without stand	\$26,373.00
EA-100247-A01	64	XT - Standard (add-on)	64 port XT add-on cabinet with stand	\$27,837.00
EA-100248-M00	32*	iFob - Standard	32 port iFob main cabinet, no input, without stand	\$20,937.00
EA-100248-MD0	32*	iFob - Standard	32 port iFob main cabinet, Multi-class card reader input, without stand	\$22,109.00
EA-100248-M01	32*	iFob - Standard	32 port iFob main cabinet, no input, with stand	\$22,401.00
EA-100248-MD1	32*	iFob - Standard	32 port iFob main cabinet, Multi-class card reader input, with stand	\$23,573.00
EA-100248-A00	32*	iFob - Standard (add-on)	32 port iFob add-on cabinet, without stand	\$14,878.00
EA-100248-A01	32*	iFob - Standard (add-on)	32 port iFob add-on cabinet, with stand	\$16,343.00
EA-100249-M00	64	iFob - Standard	64 port iFob main cabinet, no input, without stand	\$29,158.00
EA-100249-MD0	64	iFob - Standard	64 port iFob main cabinet, Multi-class card reader input, without stand	\$30,330.00
EA-100249-M01	64	iFob - Standard	64 port iFob main cabinet, no input, with stand	\$30,622.00
EA-100249-MD1	64	iFob - Standard	64 port iFob main cabinet, Multi-class card reader input, with stand	\$31,794.00
EA-100249-A00	64	iFob - Standard (add-on)	64 port iFob add-on cabinet, without stand	\$18,659.00
EA-100249-A01	64	iFob - Standard (add-on)	64 port iFob add-on cabinet, with stand	\$20,124.00
EA-100250-M00	32/32 COMBO	XT/iFob - Standard	64 port combo main cabinet, no input, without stand	\$33,097.00
EA-100250-MD0	32/32 COMBO	XT/iFob - Standard	64 port combo main cabinet, Multi-class card reader input, without stand	\$34,269.00
EA-100250-M01	32/32 COMBO	XT/iFob - Standard	64 port combo main cabinet, no input, with stand	\$34,561.00
EA-100250-MD1	32/32 COMBO	XT/iFob - Standard	64 port combo main cabinet, Multi-class card reader input, with stand	\$34,561.00
EA-100250-A00	32/32 COMBO	XT/iFob - Standard (add-on)	64 port combo add-on cabinet, without stand	\$24,984.00
EA-100250-A01	32/32 COMBO	XT/iFob - Standard (add-on)	64 port combo add-on cabinet, with stand	\$26,448.00

* Expandable to 64 total ports with addition of 32 port panel (Sold separately). See page 69 for more details.

Continued on next page.

Intelligent Key Cabinet

Part Number	Ports	Type (Standard, Mini, Large)	Description	Price
EA-100259-M00	96	iFob Standard	96 port iFob standard cabinet, no input, without stand	\$32,000.00
EA-100259-MD0	96	iFob Standard	96 port iFob standard cabinet, Multi-class card reader input, without stand	\$32,750.00
EA-100259-M01	96	iFob Standard	96 port iFob standard cabinet, no input, with stand	\$33,000.00
EA-100259-MD1	96	iFob Standard	96 port iFob standard cabinet, Multi-class card reader input, with stand	\$33,750.00
EA-100259-A00	96	iFob - Standard (add-on)	96 port iFob add-on cabinet, without stand	\$24,856.22
EA-100259-A01	96	iFob - Standard (add-on)	96 port iFob add-on cabinet, with stand	\$25,856.22
EA-100260-M00	128	iFob Standard	128 port iFob standard cabinet, no input, without stand	\$37,760.00
EA-100260-MD0	128	iFob Standard	128 port iFob standard cabinet, Multi-class card reader input, without stand	\$38,510.00
EA-100260-M01	128	iFob Standard	128 port iFob standard cabinet, no input, with stand	\$38,760.00
EA-100260-MD1	128	iFob Standard	128 port iFob standard cabinet, Multi-class card reader input, with stand	\$39,510.00
EA-100260-A00	128	iFob - Standard (add-on)	128 port iFob add-on cabinet, without stand	\$29,880.66
EA-100260-A01	128	iFob - Standard (add-on)	128 port iFob add-on cabinet, with stand	\$30,880.66
EA-100261-M00	160	iFob Large	160 port iFob standard cabinet, no input, without stand	\$43,547.00
EA-100261-MD0	160	iFob Large	160 port iFob standard cabinet, Multi-class card reader input, without stand	\$44,297.00
EA-100261-M01	160	iFob Large	160 port iFob standard cabinet, no input, with stand	\$44,547.00
EA-100261-MD1	160	iFob Large	160 port iFob standard cabinet, Multi-class card reader input, with stand	\$45,297.00
EA-100261-A00	160	iFob - Large (add-on)	160 port iFob add-on cabinet, without stand	\$34,880.34
EA-100261-A01	160	iFob - Large (add-on)	160 port iFob add-on cabinet, with stand	\$35,880.34
EA-100262-M00	192	iFob Large	192 port iFob standard cabinet, no input, without stand	\$49,306.00
EA-100262-MD0	192	iFob Large	192 port iFob standard cabinet, Multi-class card reader input, without stand	\$50,056.00
EA-100262-M01	192	iFob Large	192 port iFob standard cabinet, no input, with stand	\$50,306.00
EA-100262-MD1	192	iFob Large	192 port iFob standard cabinet, Multi-class card reader input, with stand	\$51,056.00
EA-100262-A00	192	iFob - Large (add-on)	192 port iFob add-on cabinet, without stand	\$40,195.56
EA-100262-A01	192	iFob - Large (add-on)	192 port iFob add-on cabinet, with stand	\$41,195.56
EA-100263-M00	224	iFob Large	224 port iFob standard cabinet, no input, without stand	\$55,067.00
EA-100263-MD0	224	iFob Large	224 port iFob standard cabinet, Multi-class card reader input, without stand	\$55,817.00
EA-100263-M01	224	iFob Large	224 port iFob standard cabinet, no input, with stand	\$56,067.00
EA-100263-MD1	224	iFob Large	224 port iFob standard cabinet, Multi-class card reader input, with stand	\$56,817.00
EA-100263-A00	224	iFob - Large (add-on)	224 port iFob add-on cabinet, without stand	\$45,196.70
EA-100263-A01	224	iFob - Large (add-on)	224 port iFob add-on cabinet, with stand	\$46,196.70
EA-100264-M00	256	iFob Large	256 port iFob standard cabinet, no input, without stand	\$60,827.00
EA-100264-MD0	256	iFob Large	256 port iFob standard cabinet, Multi-class card reader input, without stand	\$61,577.00
EA-100264-M01	256	iFob Large	256 port iFob standard cabinet, no input, with stand	\$61,827.00
EA-100264-MD1	256	iFob Large	256 port iFob standard cabinet, Multi-class card reader input, with stand	\$62,577.00
EA-100264-A00	256	iFob - Large (add-on)	256 port iFob add-on cabinet, without stand	\$50,197.50
EA-100264-A01	256	iFob - Large (add-on)	256 port iFob add-on cabinet, with stand	\$51,197.50
EA-100265-M00	288	iFob Large	288 port iFob standard cabinet, no input, without stand	\$66,587.00
EA-100265-MD0	288	iFob Large	288 port iFob standard cabinet, Multi-class card reader input, without stand	\$67,337.00
EA-100265-M01	288	iFob Large	288 port iFob standard cabinet, no input, with stand	\$67,587.00
EA-100265-MD1	288	iFob Large	288 port iFob standard cabinet, Multi-class card reader input, with stand	\$68,337.00
EA-100265-A00	288	iFob - Large (add-on)	288 port iFob add-on cabinet, without stand	\$55,210.12
EA-100265-A01	288	iFob - Large (add-on)	288 port iFob add-on cabinet, with stand	\$56,210.12

Intelligent Key Cabinet Accessories



Cabinet Stand



Cabinet Tray



Medeco iFob



Multi-Class Reader

Description	Part Number	Price
Medeco iFob	EA-300242	\$90.90
6" Cable Seals (price is per cable seal)	EA-300245	\$8.34
Multi-Class reader, includes install and configuration	EA-250066	\$1,387.00
Spare XT Panel	EA-300244	\$9,378.00
Spare iFob Panel	EA-300243	\$7,479.00
Tray Assembly	EA-300257	\$548.00

IKC Installation Items

Description	Part Number	Price
Key Cabinet Stand	EA-300239	\$1,735.00
Large Wallboard	EA-300254	\$457.00
Standard Wall board	EA-300256	\$351.00
Mini Wallboard	EA-300255	\$280.00

IKC Extended Warranty & Service Plan



Coverage Includes:	Part Number	Price
<ul style="list-style-type: none"> •Extended Warranty & Service Plan are valid for one year •from date of purchase •All cabinet hardware •All software updates and upgrades •Online training •Expedited shipping (replacement parts) •Phone and online support •Pro Service Consultation 	SW-500701-1	\$2,730.00

*Normal use only. Does not cover physical damage or misuse.

Submitting Orders to Medeco:

For greater efficiency and to create the best ordering experience, orders may be submitted through three order channels: eBusiness, Email or Fax.

**eBusiness Order Channel**

Benefit: Immediately transmit clean orders to reduce entry time to speed up delivery.

EDI

EDI stands for Electronic Data Interchange. It's the easiest method to use for the transmission of orders. Orders are generated directly from your ERP system and sent directly into Medeco's order entry system. EDI allows for instant and accurate transmission.

Medeco WebShop

Online Order Entry is a convenient web-based form which allows customers to easily use drop-down menus and filtering options to assist with product search and selection. A perfect part number is selected every time!

Visit <http://extranet.assaabloydss.com> to access.

Email Order Channel

Benefit: Immediately submit your orders directly into our Digital Filing System to speed up processing time.

In USA and International (except Canada):

orders.medeco@assaabloy.com ; In Canada: orders.medeco.ca@assaabloy.com

Emailing orders in USA and International (except Canada):

orders.medeco@assaabloy.com ; in Canada: orders.medeco.ca@assaabloy.com

This allows customers to submit purchase orders directly into Medeco's Digital Filing System. Once the order is submitted by email, an automatic email notification is sent stating the order has been received by Medeco, thus ensuring the order was not lost in transmission.

Fax Order Channel

Benefit: Immediately submit orders directly into our Digital Filing System to speed up processing time. Typed submissions receive EDI benefits of faster processing and accuracy.

USA Fax: 800.421.6615

Canada Fax: 888.263.3326

International Fax (except Canada): 540-380-1634

Faxing orders in USA: 800.421.6615 ; Canada: 888-263-3326 allows customers to submit purchase orders directly into Medeco's Digital Filing System. If a faxed order is typed versus handwritten, Medeco will be able to use an internal tool to send typed, faxed orders through the EDI portal to create faster order processing and reduce entry errors.

Special Pricing (SP) and Quotations

The SP or quote number must be referenced on the order, when submitted for processing. Any invoiced order that has the incorrect discount applied to it and did not have the SP or quote number written on the order will have a service fee of \$100.00 net DEDUCTED from any sales credit issued for the difference in the discount.

Provide All of the Needed Information to Avoid Delays!
Use the Medeco Checklist to Submit Clean Orders for Faster Processing

Medeco Order Checklist for All Orders

- | | |
|--|--|
| <input type="checkbox"/> Account Number | <input type="checkbox"/> Base Part Number |
| <input type="checkbox"/> Purchase Order Number | <input type="checkbox"/> Finish |
| <input type="checkbox"/> Billing Address | <input type="checkbox"/> Keyway |
| <input type="checkbox"/> Shipping Address | <input type="checkbox"/> Cam/Tailpiece |
| <input type="checkbox"/> Shipping Instructions | <input type="checkbox"/> Keying Instructions |
| <input type="checkbox"/> Special Pricing/Quote ID* | <input type="checkbox"/> Quantity |
| <input type="checkbox"/> Special Instructions | |

*The quote number must be referenced on the order.

Any invoiced order that has the incorrect discount applied to it and did not have the quote number written on the order will have a service fee of \$100.00 net DEDUCTED from any sales credit issued for the difference in the discount.

Medeco XT Checklist

- | | |
|---|---|
| <input type="checkbox"/> New System: | <input type="checkbox"/> Existing System |
| <input type="checkbox"/> End User Name | <input type="checkbox"/> System Number |
| <input type="checkbox"/> End User Email Address | <input type="checkbox"/> End User Name |
| | <input type="checkbox"/> End User Email Address |

U.S. Customers – Door Security

Phone: 877-633-3261

Mailing address:

Medeco Security Locks, Inc.

P.O. Box 3075

Salem, VA 24153

Attn: Door Security Customer Service

Fax: 800-421-6615

To submit orders:

orders.medeco@assaabloy.com

To email Customer Service:

customerservice.medeco@assaabloy.com

To email Technical Support:

techsupport.medeco@assaabloy.com

Hours of operation:

Monday – Thursday, 8:00 a.m. – 6:00 p.m. ET

Friday, 8:00 a.m. – 5:00 p.m. ET

Canada Customers

Phone: 905-532-4970

Toll-free (in Canada only) 1-888-633-3264

Mailing address:

Medeco Canada

160 Four Valley Drive

Vaughan, ON L4K 4T9 CANADA

Fax: 905-532-4971 or

1-888-263-3326 (in Canada only)

E-mail: orders.medeco.ca@assaabloy.com

Hours of operation:

Monday – Friday, 8:00 a.m. – 4:30 p.m. ET

**Customers Outside the U.S.
(Not including Canada)**

Phone: +1 540-380-1741

or +1 877-633-3261

Fax: +1 540-380-1634

Mailing address:

Medeco Security Locks, Inc.

P.O. Box 3075

Salem, VA 24153

Attn: International Customer Service

E-mail: export@medeco.com

Submit Orders:

orders.medeco@assaabloy.com

Hours of operation:

Monday – Friday, 8:00 a.m. – 5:00 p.m. ET

Medeco Shipping & Returns Policies**Pricing:**

All published prices are subject to change without notice and are not guaranteed. All shipments will be made at prices prevailing at time of shipment. We reserve the right to correct typographical, clerical, editorial, pricing, quantity, or any other errors in this or any publications produced by Medeco Security Locks, Inc. without prior written notice or disclaimer.

**Changes/Cancellations
of Orders Policy:****– Order Changes:**

Changes made to orders after order acknowledgement or scheduling will result in a 10% change fee.

– Rescheduling orders and delayed shipments (blanket purchase orders):

Orders will be scheduled by agreement. However, orders may be rescheduled or delayed by Customer within 7-days (1 week) of initial acknowledgement without a change fee. Orders rescheduled or delayed after the 7-day period will be subject to a 10% change fee. Notification of rescheduling or delay must be in writing via email and can be sent to **orders.medeco@assaabloy.com**. Please reference the order number.

– Order cancellations:

Cancellation of orders after order acknowledgement/scheduling shall result in a 10% cancellation fee. If an order or a portion of an order is cancelled and products have already been manufactured and prepped for shipping, a 50% restocking fee will apply.

Shipping Charges:

For most U.S. customers, published freight rates will apply. Contact Medeco Customer Service for more information about Medeco's shipping and handling charges.

Freight:

All U.S. orders are shipped FOB origin: When delivered to the Transportation Company, Purchaser assumes risk of loss or damage in transit.

Customers Outside the U.S.:

Due to specific taxes, import/export fees, and exchange rates, pricing and shipping will vary from U.S. list prices for customers in Canada and elsewhere outside the United States.

Note: Some products may not be available in Canada as well as some of the programs offered in this price book may differ between the USA and Canada. Please contact your sales representative for more information.

Product Returns:

Medeco accepts product returns if the product is defective from a manufacturing flaw. If you need to make a return, fill out an RGA Form and fax it to:

In USA: 800-421-6615

In Canada: 888-263-3326

or email to:

In USA:

orders.medeco@assaabloy.com

In Canada:

Outside the USA (except Canada):

orders.medeco.ca@assaabloy.com

The RGA Number must be visible on the outside of any package returned to Medeco. The RGA form can be found on Medeco.com, the Extranet, or by contacting Customer Service at 877-633-3261 or CustomerService.Medeco@assaabloy.com.

Damaged Goods:

All orders are carefully filled, checked, and packaged. However, on rare occasions, a package may be damaged in transit. If this occurs, please make note of it on the delivery receipt before signing. To return merchandise that was damaged during the shipping or delivery process, call Medeco Customer Service.

Partial Shipments:

If all items on your order are not available at the time your order is processed, you must specify whether you want Medeco to hold the shipment until it is complete or send partial shipments as items are available. Orders received without specific shipping instructions will be filled at the discretion of Medeco.

Medeco® Standard and Extended Warranty Mechanical & Intelligent Key Products

Medeco Security Locks Inc. (“Medeco”) warrants to the original purchaser of a Medeco branded lock, lock cylinder, or Intelligent Key hardware product (referred to collectively as “Product”) to be free of defects in material and/or workmanship for a period of two (2) years from the date of original purchase for use. This Warranty may also apply to other specific products. For additional Warranty information or Warranty claim service, contact Medeco Customer Service at (877) 633-3261 or in Canada (888) 633-3264.

An Extended Warranty for Intelligent Key products is available for purchase. Please contact your local Medeco Representative for additional details.

In the event of a defect in material or workmanship during the Warranty period, Medeco will repair or replace (at its option) the Product under the conditions of this Warranty, this action being the sole remedy available to the purchaser under this express limited Warranty.

Limitations, Exclusions and other Rights:

- a. Medeco disclaims liability for implied warranties, including but not limited to those of merchantability or fitness for any particular purpose.
- b. Medeco disclaims liability for indirect, incidental or consequential damage at any time.
- c. Intelligent Key batteries are not covered under this warranty or any extended warranty.
- d. This Warranty gives specific legal rights, and a buyer may also have other rights that may vary from state to state. Some states do not allow limitations on indirect, incidental, and consequential damages or implied warranties so that the above limitations may not fully apply.
- e. Medeco mechanical keyblanks are made from a special nickel silver alloy. Medeco warrants its mechanical keys against defects in workmanship or breakage for the life of the Product. Bitted Medeco keys must be precisely cut to exact angles and depths, and require special duplication. This Warranty shall be void and Medeco disclaims liability of any kind in the event any key other than a genuine Medeco key has been used with the Product or that the key has been cut on any machine other than a Medeco or Medeco-approved key cutting machine.
- f. Medeco CLIQ Intelligent keys are covered for one (1) year against breakage (mechanical blade only).
- g. Medeco Intelligent Keys Cabinets (IKC) are covered under this two (2) year warranty. Within that time frame, Medeco will repair or replace any component that is found to have a defect.
- h. Medeco shall not be held responsible for product complaints or product damage arising from, in its sole judgment, and absence of user training, improper installation, failure to provide normal maintenance, extreme environmental conditions, use rates in excess of the industry standards defined for the type of product, use of incompatible parts or products not made or authorized by Medeco, or application of force not resulting from normal use.
- i. Unless otherwise specified by separate warranty, finishes are warranted for a period of two years following purchase for use. This finish Warranty shall be considered void after installation if, in the sole judgment of Medeco, the damage to the finish is the direct result of extreme climatic conditions, chemical or abrasive actions.

Medeco Standard Terms and Conditions of Sale

Effective January 1, 2024

Special terms may be applied for special circumstances and by mutual agreement.

These *Medeco Standard Terms and Conditions of Sale* (these “Terms and Conditions”) set forth the entire agreement between “Medeco,” the company named on the face hereof (or the document attached or linked hereto) and the “Buyer,” the person or entity who accepts Medeco’s quotation for the sale of Products or whose order for Products is accepted by Medeco. Unless otherwise agreed in writing by Medeco, these Conditions shall apply to and govern all contracts for the sale and supply of goods (“Products”), between Buyer and Medeco and all orders are accepted in accordance with these Conditions.

1. Prices:

Prices are subject to change without notice. No prices are guaranteed unless accompanied with an official price quotation from Medeco. All quotations are valid for 90 days unless otherwise noted but represent no obligation until Medeco accepts Buyer’s order.

Pricing for orders with requested ship dates greater than 90 days in the future, including blanket orders, may be adjusted by Medeco to Medeco’s prevailing prices at the time of shipment.

Buyer’s possession of Medeco’s price list does not constitute an agreement to sell.

Medeco may, under exceptional circumstances (e.g., supply chain / cost variances) and in its sole and absolute discretion, adjust pricing to match Medeco’s prevailing prices at the time of shipment.

2. Terms:

All sales are net 30 days unless otherwise agreed in writing. Late accounts shall bear interest at a rate of 1-1/2% per month.

3. Delivery:

Unless otherwise prearranged, Buyers shall be invoiced F.O.B. Shipping Point. Buyer’s freight terms shall be by mutual agreement as negotiated yearly. Freight will be charged according to Medeco’s prevailing freight policy. If Buyer selects a carrier with a higher rate, Buyer will be charged the rate difference. Cartage charges for delivery from freight terminal to Buyer’s warehouse are for Buyer’s account. When delivered to the transportation company, all shipments become the property of the Buyer, who assumes the risk of loss or damage in transit.

4. Acceptance:

Medeco reserves the right to decline an order, in whole or in part, when the type or quantity of Products or credit worthiness of Buyer is not satisfactory to Medeco in its sole and absolute discretion.

Purchase orders, quote requests, order acknowledgements, or other similar transaction materials issued by the Buyer that have contrary standard terms and conditions are not binding on Medeco, unless such terms and conditions are approved in a separate written agreement by Medeco’s authorized representatives. In the event of an acceptance of the Buyer’s purchase order by Medeco, or Buyer’s acceptance of Medeco’s quote or proposal, the Buyer agrees that such acceptance is solely limited to and conditioned upon the Buyer’s acceptance of these Terms and Conditions, which may not be changed or waived except in a separate writing signed by the parties. In any event, acceptance by Buyer of the Products shall be deemed unqualified acceptance of these Terms and Conditions and no course of action shall be deemed to modify these Terms and Conditions.

5. Invoicing:

Medeco has a minimum order value of \$50 except for service orders for cut keys or replacement cards, for which a minimum charge of \$25.00 net will be applied.

Minimum order charges are not imposed on the following types of orders:

- a. Partial shipments.
- b. Returned Products (must be accompanied by Medeco’s return authorization number).
- c. Search fee for key codes.

6. Returned Goods:

Any defects or errors in Products, reported within the stated warranty or notice period, for which Medeco is wholly responsible, will be promptly rectified. Returns based upon customer error may be returned at Medeco’s option with a minimum 50% restocking fee and only within 90 days of date of invoice.

Approval for return of merchandise must be requested from Medeco and, when

granted, a return authorization number shall be issued to Buyer. No return will be accepted unless the shipping container carries the return authorization label.

7. Claims:

In the event of [Buyer or Medeco] error, claims for shortages, pricing errors, and/or incorrectly filled orders must be submitted in writing to Medeco Customer Service within 30 days from receipt of material. Any claims for shortages or damage by the carrier must be made by the buyer directly to the carrier. Limited carrier insurance is typically offered for all orders. If the customer requires or desires additional insurance, please contact a Medeco Customer Service representative upon submittal of the order. Medeco will obtain requested insurance and the additional costs will be included on the customer’s invoice.

8. Invoice Deductions:

A Medeco Credit representative must be notified of any disputed invoices within 60 days from the date of invoice. Deductions should only be taken for the disputed amount and the balance of the invoice is due and payable with standard payment terms.

9. Change in Orders:

Changes on orders cannot be made after Medeco’s acknowledgement is received by Buyer, except on Medeco’s written approval and with a quoted price covering cost of making the change, on which a bona fide order must be issued by Buyer authorizing the change and the cost involved.

10. Incomplete Orders:

Orders lacking complete information for order entry will be held for receipt of complete information. Once notified of the information needed, Buyer will have 10 business days to reply with a plan to supply the missing information, or the order may be suspended.

Continued on the next page.

Medeco Standard Terms and Conditions of Sale *(Continued)*

11. Cancellations:

Cancellations will not be accepted unless no loss will be incurred by Medeco. Requests for cancellation must be in writing.

12. Packing and Cartage:

Unless otherwise stated, prices shall include all charges for Medeco's usual packing and crating and for cartage to F.O.B. point. Medeco shall not be obligated to provide special containers unless specified and agreed to in advance in writing by Medeco.

13. Allocation:

If sufficient Products are not available for any reason, Medeco may allocate Products among its customers. Allocation of Products pursuant to this Section shall completely satisfy and discharge Medeco's supply obligations and Medeco shall, therefore, not be deemed to be in breach of such obligations.

14. Taxes And Government Regulations:

Any license fee, property, sales, use or excise tax which may be levied, assessed, or imposed by government authority on any of Medeco's Products shall be added to the price therefore and be paid by the Buyer. Any increase in Medeco's costs in purchasing materials or in manufacturing, processing, selling, or delivering its Products resulting from any governmental tax or regulation or industry shall be added to the selling price and be paid by the Buyer.

15. Dies, Patterns and Special Tools:

Materials, tools, and equipment required to fill any sales contract or order issued by Buyer shall be furnished by Medeco, unless otherwise specified. If any materials, tools and/or equipment are furnished by or on behalf of Buyer for use by Medeco, they shall be of good quality and workmanship and sufficient for the intended purpose. Any such materials, tools or equipment furnished by or on behalf of Buyer to Medeco on other than a charge basis shall be held by Medeco as Buyer's property and Medeco shall account therefore, provided that Buyer shall allow for a reasonable wear or scrap loss on materials.

16. Warranty:

Medeco warrants that all Products will conform with applicable drawings and

specifications agreed upon in writing by Medeco, it being understood that reasonable variances not impairing the usefulness thereof shall be allowed, that said Products will be free from material defects in material or workmanship which impair the usefulness thereof within the stated warranty period. If any Product shall fail to conform therewith or be materially defective, Buyer's sole and exclusive remedy against Medeco will be for the repair or replacement of the defective Products, such repair or replacement to be at Medeco's sole discretion. EXCEPT AS PROVIDED IN THIS SECTION 16, MEDECO HEREBY EXPRESSLY DISCLAIMS ALL WARRANTIES, EXPRESS OR IMPLIED, AT LAW OR IN EQUITY, WITH RESPECT TO THE PRODUCTS OR THEIR CHARACTERISTICS, QUALITY, PERFORMANCE OR VALUE, INCLUDING, WITHOUT LIMITATION, THE IMPLIED WARRANTIES OF MERCHANTABILITY, FITNESS FOR A PARTICULAR PURPOSE, OR NON-INFRINGEMENT OF ANY INTELLECTUAL PROPERTY RIGHTS OF THIRD PARTIES.

17. Limitation of Liability:

IN NO EVENT SHALL MEDECO BE LIABLE FOR SPECIAL, INDIRECT, INCIDENTAL, OR CONSEQUENTIAL DAMAGES, WHETHER IN CONTRACT, WARRANTY, NEGLIGENCE, TORT, STRICT LIABILITY, OR OTHERWISE. Medeco's liability on all claims, whether in contract, warranty, negligence, tort, strict liability or otherwise for any loss or damage arising out of, or connected with an order or the performance or breach thereof, or from the design, manufacture, sale, or delivery of products shall in no case exceed the lesser of [\$X] and the purchase price of the products Under the applicable order. THE PARTIES AGREE THAT IN NO EVENT SHALL MEDECO BE LIABLE TO BUYER, A USER, OR ANY THIRD PERSON FOR LOSS OR DAMAGES TO PROPERTY RESULTING FROM FAILURE OF MEDECO'S PRODUCT(S) TO OPERATE OR TO FUNCTION PROPERLY, NOR ANY INDIRECT, SPECIAL OR CONSEQUENTIAL DAMAGES RESULTING THEREFROM. BUYER SHALL OBTAIN ITS OWN INSURANCE COVERING PERSONAL INJURY AND PROPERTY LOSS OR DAMAGE TO ITS PREMISES, AND HEREBY AGREES TO INDEMNIFY MEDECO AGAINST ALL CLAIMS OF THIS NATURE.

18. Delays:

Medeco shall not be liable for any loss or damage caused by delays or defaults in

performance hereunder due to any cause that is beyond Medeco's control, including but not limited to strikes, lockout or trade disputes (whether involving its own employees or those of any other person), breakdown of machinery, riots, fires, accidents, governmental interference or embargoes, shortages of materials, fuel, labor, supplies or transportation, or due to any cause of a like or different nature beyond its control. The existence of any such cause of delay shall extend the time of performance or delivery of any order or any uncompleted portion thereof by the time or times required removing any such excusable cause or causes of delay.

Additionally, should any such event occur, Medeco may cancel or suspend any order of Products made by Buyer without incurring liability to Buyer for any loss or damage.

19. Modifications:

Unless otherwise agreed to in writing by Medeco, the Terms and Conditions in effect at the time of order acceptance shall constitute the entire contract between the parties hereto and no agreement or other understanding in any way modifying, affecting, or canceling same will be binding unless made in writing, signed by an officer of Medeco and a duly authorized representative of Buyer. Stenographic and clerical errors or omissions are subject to corrections. Buyer shall reference the current version of Medeco's Terms and Conditions as referenced on its website at the time of transaction, as Medeco may make modifications from time to time without specific notice to Buyers. These Terms and Conditions shall apply to all future spot sales from Medeco to Buyer unless a written contract therefore has been entered into by the parties.

20. Compliance with Law:

Each party agrees to comply with all other state, Federal, and local laws applicable to its performance hereunder.

21. Financial Responsibility:

All shipments shall at all times be subject to the approval of Medeco's Credit Dept. In the event of any proceedings by or against Buyer in bankruptcy or insolvency, voluntary or involuntary, or under Chapters X or XI of the Bankruptcy Act of

Continued on the next page.

Medeco®

Professional Services

To achieve optimum performance of your new key system, Medeco recommends professional design and implementation services. Services include system planning, system deployment, team training and ongoing support.

Medeco Professional Services: Making the most out of your investment



Over our 55 year history, Medeco has established a reputation for developing high-quality products that provide unparalleled security. Yet, high-quality products alone do not guarantee a successful deployment. To achieve optimum performance of your new intelligent Key System, Medeco recommends professional design and implementation services.

Medeco Professional Services includes a variety of offerings that will help you gain additional value from your technology investment. Professional Services include:

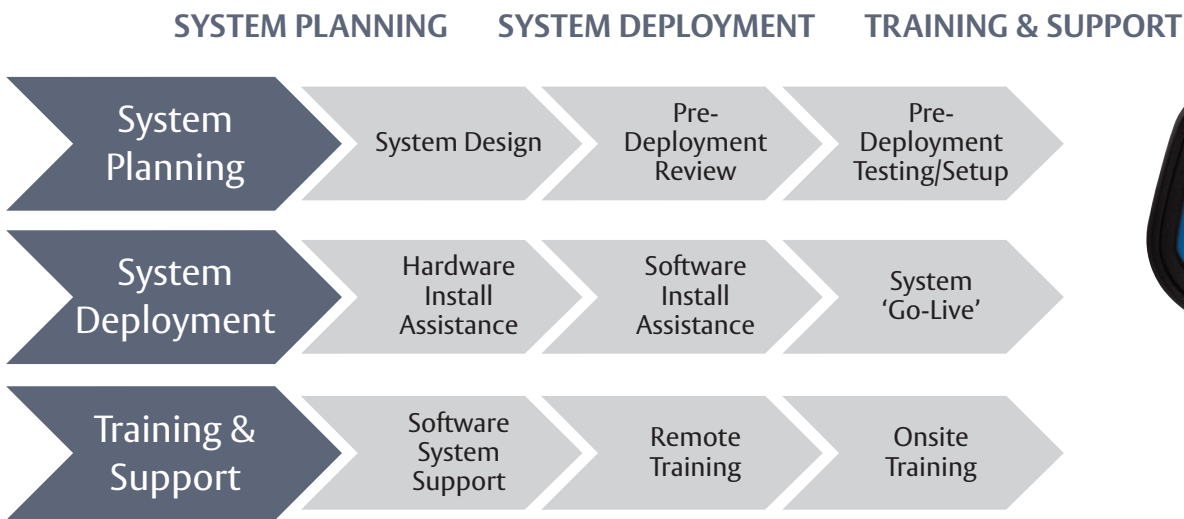

Professional Services

System Planning Services



Medeco Professional Services provides consulting expertise that utilizes industry best practices to strategically plan, scope, and facilitate the design of Medeco solutions tailored to meet your organization's compliance, security, and risk management requirements. Our consulting service packages are meticulously crafted for execution under the guidance of a dedicated project manager.

All prices shown are CANADIAN LIST and subject to dealer software buying program discount.

Remote Planning Support

SW-501Remote

\$842.00/hr 1 hour minimum

- System Design Assistance

- Ensure that your system is designed with your current and future interests in mind.

Onsite Planning Support

SW-501Site

\$6,383.00/day plus T&E

- Pre-Deployment Meetings

- Live in person coordination of events and timeline planning.

System Deployment Services



The Medeco Professional Services team has committed technical consultants and software engineers who collaborate closely with your in-house team to facilitate the deployment and integration of Medeco solutions and third-party systems. This proficient group of systems engineers, integrators, and project management experts will manage and supervise the entire implementation process of your new Intelligent Key System, ensuring that all technical complexities and potential risks are identified in advance. This approach guarantees that your system is purposefully designed to scale according to your current and future needs.

Remote Deployment Services

SW-502Remote

\$842.00/hr 1 hour minimum

- Remote Software Installation

- Live online assistance with software installation to ensure complete functionality.

- Remote Software Upgrades

- Using our remote access software we will ensure that your software upgrades go without issue, including data conversions.

Onsite Deployment Services

SW-502Site

\$6,383.00/day plus T&E

- Equipment Configuration

- The assistance you need to get all of your equipment programmed and installed in a timely manner.

- Software Installation / Upgrades

- Live assistance from Technical Services to help with the software installation, patching, upgrades, migrations, etc.

Training & Support Services

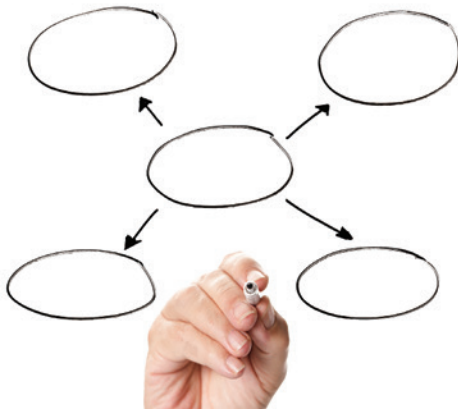

Before implementing your new system, we strongly recommend enrolling your business security team in Medeco technical training. We offer a range of tailored hands-on courses to instruct your team on the proper operation, customization, and support of your new Intelligent Key System.

Our experts will collaborate closely with your team, providing them with the essential knowledge to ensure a smooth start, allowing your new system to operate at peak performance from Day One. In the event of any issues, our team is ready to deliver prompt, professional, and cost-effective assistance via phone, email, or online channels.

For long-term engagements, the Medeco Professional Services team can provide on-site support, ensuring your system's sustained optimal performance on a day-to-day basis. Through continuous expert consultancy, Medeco consultants can streamline troubleshooting processes and assist in defining risk mitigation strategies during upgrades of Medeco solutions. This approach not only enhances system efficiency but also helps reduce training costs for your staff.

Enterprise System Support

SW-504Platinum

Call for Quote

• Enterprise System Support – Platinum

- Software System Remote Support for Emergency/Severity.
- Extended phone support: available 24 hours a day, 7 days a week (in English).

Remote Training

SW-503Remote

\$842.00/hr 1 hour minimum

- Web Based Training
- Additional Training Based on New Staff/Turnover

- Online training setup to meet your planning schedule.
- Online training to help you keep up with new staff requirements.

Onsite Training

SW-503Site

\$6,383.00/day plus T&E

- Hands-on Training

- In depth face to face training for our hardware and software applications.

All prices are U.S. LIST, and subject to dealer software discounting. T&E charges will be quoted upon request.

The Medeco Professional Services team will collaborate closely with your in-house team to support the planning and design, deployment, integration, and ongoing support and training of your new system. Our joint efforts will guarantee that your Medeco Intelligent Key System is operational from Day One and performing at its peak efficiency.

Finishes Available – Commercial & Industrial Locks



05
(US03)
Bright Brass



06
(US04)
Satin Brass



09
(US5)
Antique Brass



10
Satin Brass
Blackened

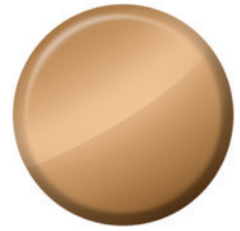

11
(US9)
Bright Bronze



12
(US10)
Satin Bronze



13
(US10B)
Dark Bronze/
Oil Rubbed



18
(US14)
Bright Nickel



19
(US15)
Satin Nickel

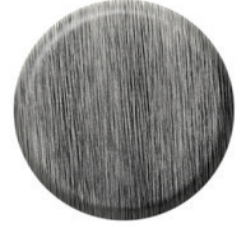

20
(US15A)
Antique Nickel



22
Flat Black



24
(US20A)
Dark Bronze/
Clear Coat



25
(US26)
Bright Chrome



26
(US26D)
Satin Chrome



BB
Matte Black

Note: Product appearance may differ from this chart as a result of the differences in plated versus printed materials.

The ASSA ABLOY Group is the global leader in access solutions. Every day, we help billions of people experience a more open world.

ASSA ABLOY Opening Solutions leads the development within door openings and products for access solutions in homes, businesses and institutions. Our offering includes doors, frames, door and window hardware, locks, perimeter fencing, access control and service.



medeco[®]

ASSA ABLOY

MEDECO USA

3625 Alleghany Drive | Salem, Virginia 24153-0330
Customer Service 1.877.633.3261

MEDECO CANADA

160 Four Valley Drive | Vaughan, ON L4K 4T9 CANADA
Customer Service 1.888.633.3264



facebook.com/medecolocks



youtube.com/medecolocks



newsletter sign up: medeco.com



linkedin.com/company/medecolocks/