

Medeco B

Medeco B Small Format Interchangeable Cores (SFIC) provide quick and easy cylinder changes in the event keys are lost or stolen. Medeco B is an economic and efficient solution to rekeying needs. Medeco B easily retrofits into existing systems, significantly reducing installation time.

Medeco B offers flexibility and is available in standard 6 and 7 pin format in established competitive keyways. The reinforced sleeve design provides added strength and durability.



Competitive Keyways

Medeco B is an affordable alternative for end users currently using industry standard unpatented keyways. Available keyways: 1C, 1D, AB, BB, CB, DB, EB, FB, GB, HB, JB, KB, LB, MB, QB, RB, TA, TB, TC, TD, TE, WA, WB, WC, WG, WH & WY.



Quickly Change Cores

Medeco B SFIC cylinder provides quick and easy cylinder changes in the event keys are lost or stolen.



Fits Existing & New Master Key Systems

Medeco B is priced to save clients' money vs. other unpatented competitors and can be substituted directly into existing SFIC master key systems.

Applications:

The Medeco B retrofit cylinders are ideal for any application requiring unpatented key control that can be substituted directly into existing small format interchangeable core systems.

Warranty:

Medeco B cylinders are warranted for two years against manufacturer's defects. See the Medeco® limited warranty for full details.

Finishes:

- Available in all standard finishes to match existing hardware.

Technical Information:

- Solid brass construction
- Reinforced sleeve design
- Uses A2 SFIC Specifications
- Available with Medeco-branded stamping or no stamping
- 6 & 7 pin unpatented SFIC
- Sleeve, shell, plug & face plate made of brass
- Individually capped pin chambers
- Available in the following industry standard SFIC keyways: 1C, 1D, AB, BB, CB, DB, EB, FB, GB, HB, JB, KB, LB, MB, QB, RB, TA, TB, TC, TD, TE, WA, WB, WC, WG, WH & WY
- Dealers do not need a contract to purchase Medeco B SFIC Cores. Cores are available through Medeco and authorized distributors.

Small Format Interchangeable Core (SFIC)

Medeco Small Format Interchangeable Core (SFIC) products are industry standard and compatible with existing door hardware.

They offer rapid combination changes that can be managed by non-technical personnel using a special control key to remove the cylinder (core) from the lock housing. A core with a new combination can then be inserted, which in effect rekeys the lock. All of this can be done without having to take the lock apart.

Medeco SFICs are the easiest way to upgrade security for cylinders that are already in place. Medeco's industry-standard SFIC products include:

- **Medeco X4:** Provides patented protection against unauthorized key duplication through 2030.
- **Medeco B:** Cylinders are compatible with popular keyways such as A-Q, W and T.
- **Medeco XT:** Offers audit information, scheduling, and analytics in an SFIC format. (Refer to Medeco XT section of the catalog for more details.)

By using existing door hardware, Medeco SFICs help reduce cost while upgrading security.



Patented Key Control

Protects against unauthorized duplication of your keys.



Uses Existing Hardware

Industry standard Small Format Interchangeable Cores (SFIC) size, reduces cost by eliminating the need to replace your existing hardware.



Quickly Change Cores

Provides quick and easy cylinder changes in the event keys are lost or stolen.

Technical Information:

- SFICs are available in six or seven pin cylinders, and can replace Best style cores
- Solid brass construction for excellent durability
- Spool shaped top and bottom pins add a measure of pick resistance (X4 and Medeco B)
- Individual pin chamber caps provide ease of servicing

Applications:

Convenience stores and fast-food restaurants, schools, office buildings, hospitals, and wherever else SFIC's need to be upgraded.

Warranty:

Warranted for two (2) years against manufacturer's defects. See the Medeco® limited warranty for full details.

Finishes:

X4 and Medeco B SFIC's are available in all standard finishes to match with existing hardware.

(See finishes on inside back cover.)

XT SFIC's are available in:

- 06 – Satin Brass
- 12 – Satin Bronze
- 13 – Dark Bronze/Oil rubbed
- 26 – Satin Chrome
- BB – Matte Black

(Note: There is a fee for all XT finishes other than 26- Satin Chrome.)

Available Technologies:

- X4
- XT (please see XT section of catalog for more details)
- Medeco B

How To Order Small Format Interchangeable Core

Medeco X4		LEVEL 1 – Patented Key Control
Cores Only	Part Number	Notes
6 Pin Small Format Interchangeable Core with Clip Retainer, Removable Front Plate	33600006 (P)	Pinned pricing includes master key system design and pinning, as well as two cut keys. Note: Conventional cylinders are available (KIK, Rim, Mortise, etc.) and can be easily integrated into an SFIC Master Key System
	33600006 (S)	
7 Pin Small Format Interchangeable Core with Clip Retainer, Removable Front Plate	33700006 (P)	
	33700006 (S)	

How to Order Medeco X4:

(P) = Pinned (S) = Sub-Assembled

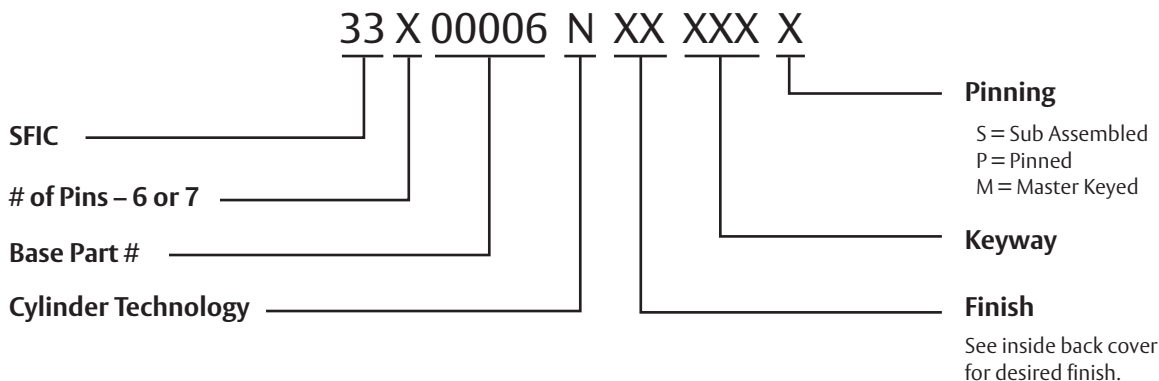







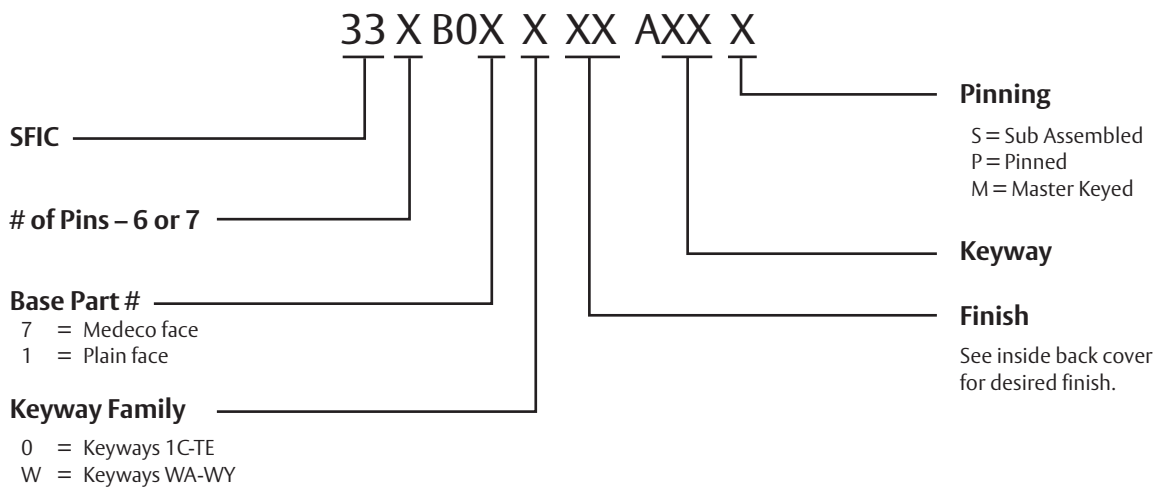

Medeco B		LEVEL 0 – Convenience
Cores Only	Part Number	Notes
6 Pin Small Format Interchangeable Core, Medeco B stamping	33-6B07X (P)	Pinned pricing includes master key system design and pinning, as well as two cut keys
	33-6B07X (S)	
6 Pin Small Format Interchangeable Core, no stamping	33-6B01X (P)	
	33-6B01X (S)	
7 Pin Small Format Interchangeable Core, Medeco B stamping	33-7B07X (P)	
	33-7B07X (S)	
7 Pin Small Format Interchangeable Core, no stamping	33-7B01X (P)	
	33-7B01X (S)	

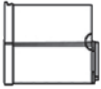
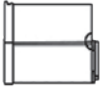
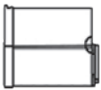
How to Order Medeco B:

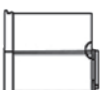
(P) = Pinned (S) = Sub-Assembled

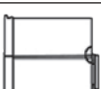
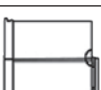
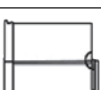

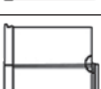
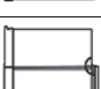
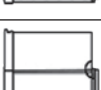





Small Format Interchangeable Core

Description	Part Number	Medeco B	X4	KeyMark
 Medeco X4 and KM 6 Pin SFIC	33600006 (P)			
	33600006 (S)			
 Medeco B 6 Pin SFIC, Medeco face plate, Alphabet and T series keyways	336B070 (P)			
	336B070 (S)			
 Medeco B 6 Pin SFIC, Medeco face plate, W series keyways	336B07W (P)			
	336B07W (S)			
 Medeco B 6 Pin SFIC, plain face plate, Alphabet and T Series Keyways	336B010 (P)			
	336B010 (S)			
 Medeco B 6 Pin SFIC, plain face plate, W Series Keyways	336B01W (P)			
	336B01W (S)			
 Medeco X4 and KM 7 Pin SFIC	33700006 (P)			
	33700006 (S)			
 Medeco B 7 Pin SFIC, Medeco face plate, Alphabet and T series keyways	337B070 (P)			
	337B070 (S)			
 Medeco B 7 Pin SFIC, Medeco face plate, W series keyways	337B07W (P)			
	337B07W (S)			
 Medeco B 7 Pin SFIC, plain face place, Alphabet and T Series Keyways	337B010 (P)			
	337B010 (S)			
 Medeco B 7 Pin SFIC, plain face plate, W Series Keyways	337B01W(P)			
	337B01W (S)			
 Medeco X4 and KM 6 Pin SFIC, Extended Plug Head	33600007 (P)			
	33600007 (S)			
 Small Format Interchangeable Core, Extended Plug Head	33700007 (P)			
	33700007 (S)			
 Specialty Sliding Door 7 Pin SFIC, Medeco X4 and KM	3370000S (P)			
	3370000S (S)			
 Medeco B 7 Pin SFIC for Showcase Lock, Medeco face plate	337B070S (P)			
	337B070S (S)			
 Medeco B 7 Pin SFIC for Showcase Lock, Medeco face plate, W series keyways	337B07WS (P)			
	337B07WS (S)			

(P) = Pinned (combined), (S) = Sub-assembled (uncombined)
 Surcharges for Master Keying, Custom Coining and Custom Stamping apply, see page 195.
 Refer to the XT and CLIQ Intelligent Key sections for format availability and pricing.







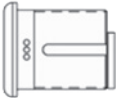

NOTE: Price includes \$45 adder for Medeco B pinned/master-pinned only.

SFIC Rim Cylinders

Description	Part Number	X4	KeyMark
 6 Pin SFIC with 1-1/4" Rim Assembly	33602032 (P)		
	33602032 (S)		
 6 Pin SFIC with 1-1/2" Rim Assembly	33602042 (P)		
	33602042 (S)		
 7 Pin SFIC with 1-1/2" Rim Assembly	33702042 (P)		
	33702042 (S)		
 7 Pin SFIC with Corbin Russwin® Master Ring Assembly	337020B2 (P)		
	337020B2 (S)		
 6 Pin SFIC with 1-1/2" Ext.Face Rim Assembly	33602033 K (P)		
	33602033 K (S)		
 6 Pin SFIC with 1-1/2" Ext.Face Rim Assembly	33602043 K (P)		
	33602043 K (S)		
 7 Pin SFIC with 1-1/2" Ext.Face Rim Assembly	33702043 K (P)		
	33702043 K (S)		

(P) = Pinned (combined)
 (S) = Sub-assembled (uncombined)
 Surcharges for Master Keying, Custom Coining and Custom Stamping apply, see page 195.
 Refer to the XT and CLIQ Intelligent Key sections for format availability and pricing.

SFIC Mortise Cylinders

Description	Part Number	X4	KeyMark
 6 Pin SFIC 1-1/4" Mortise Assembly	33602012 (P)		
	33602012 (S)		
 7 Pin SFIC 1-3/8" Mortise Assembly	33702022 (P)		
	33702022 (S)		
 7 Pin SFIC 1-3/8" Corbin® Jumbo Assembly	337020C2 (P)		
	337020C2 (S)		
 7 Pin SFIC 1-1/2" Mortise Cylinder Assembly	337020E2 (P)		
	337020E2 (S)		
 6 Pin SFIC 1-1/4" Ext. Face Mortise Assembly Medeco KM only	33602013 K(P)		
	33602013 K(S)		
 7 Pin SFIC 1-3/8" Ext. Face Mortise Assembly Medeco KM only	33702023 K(P)		
	33702023 K(S)		
 6 Pin SFIC 7/8" body length (1-3/8" overall) Tapered Head Mortise Assembly	33602052 (P)		
	33602052 (S)		
 6 Pin SFIC 1" body length (1-1/2" overall) Tapered Head Mortise Assembly (can accept 7 pin core)	33602062 (P)		
	33602062 (S)		
 6 Pin SFIC 7/8" body length (1-3/8" overall) Ext. Face Tapered Head Mortise Assembly	33602053 K(P)		
	33602053 K(S)		
 6 Pin SFIC 1" body length (1-1/2" overall) Ext. Face Tapered Head Mortise Assembly (can accept 7 pin core)	33602063 K(P)		
	33602063 K(S)		

(P) = Pinned (combined)

(S) = Sub-assembled (uncombined)

Surcharges for Master Keying, Custom Coining and Custom Stamping apply, see page 195.
Refer to the XT and CLIQ Intelligent Key sections for format availability and pricing.

SFIC Housings

Description	Part Number	Price
 6 Pin 1-1/4" Mortise Housing Only	33-076011	
 6 or 7 Pin 1-3/8" Mortise Housing Only	33-076021	
 7 Pin 1-1/2" SFIC Mortise Housing Only, (If using 6 Pin core spacer CP-160420 required)	33-076025	
 7 Pin 1-3/8" Housing Only for Corbin® Russwin® Master Ring Cylinders*	33-076028	
 6 Pin 7/8" Tapered Head Mortise Housing Only	33-076051	
 6 or 7 Pin 1" Tapered Head Mortise Housing Only	33-076061	
 6 Pin 1-1/2" Rim Cylinder Housing Only	33-07603H	
 7 Pin 1 -1/2" Rim Cylinder Housing Only	33-07604H	
 7 Pin Corbin® Jumbo Rim Housing Only	33-076048	

Showcase Lock Housing

Description	Part Number	Price
Showcase lock for SFIC cylinder. Works with Medeco X4, Medeco XT, or Medeco B SFIC. SFIC sold separately.	33-07340	

(P) = Pinned (combined)

(S) = Sub-assembled (uncombined)

Surcharges for Master Keying, Custom Coining and Custom Stamping apply, see page 195.
Refer to the XT and CLIQ Intelligent Key sections for format availability and pricing.