

# Smart SFIC Solutions Catalog



Experience a safer  
and more open world

**medeco**<sup>®</sup>  
ASSA ABLOY

# Table of Contents

Introduction to SFIC / Medeco SFIC Continuum .....	3
Medeco XT SFIC Locking Platforms .....	4
Medeco XT System Overview .....	5
Medeco X4 SFIC Locking Platforms .....	6
Medeco B SFIC Locking Platforms .....	7
Medeco B SFIC Keyway Cross Reference Guide .....	8
Professional Services .....	9-10
SFIC Cylinders .....	11-12
SFIC Housings .....	13
SFIC Deadbolts .....	14
SFIC Padlocks .....	15
Euro Profile Interchangeable Core (EPIC) .....	16
Cabinet Locks .....	17
SFIC Keys .....	18
Finishes .....	19



For additional information and to find a local service provider, visit:  
[www.medeco.com/sfic](http://www.medeco.com/sfic)

# SFIC Introduction

Once almost exclusively used by large institutions, retail chains, and commercial operations, Small Format Interchangeable Core (SFIC) cylinders continue to be increasingly common in many markets, due to the ease and speed of removing cylinders with the appropriate control key.

This allows locks to be quickly rekeyed without special tools or training, saving time and money while ensuring the security and integrity of the master key system. What sets SFIC cylinders apart from other interchangeable core is its universal format. All SFIC cylinders, regardless of the manufacturer, are designed to the same specifications for size and function. This allows the use of SFIC cores with virtually any SFIC hardware.

Few solutions offer the cost savings and flexibility of SFIC, and no other manufacturer provides as many options as Medeco.

## Medeco SFIC Continuum

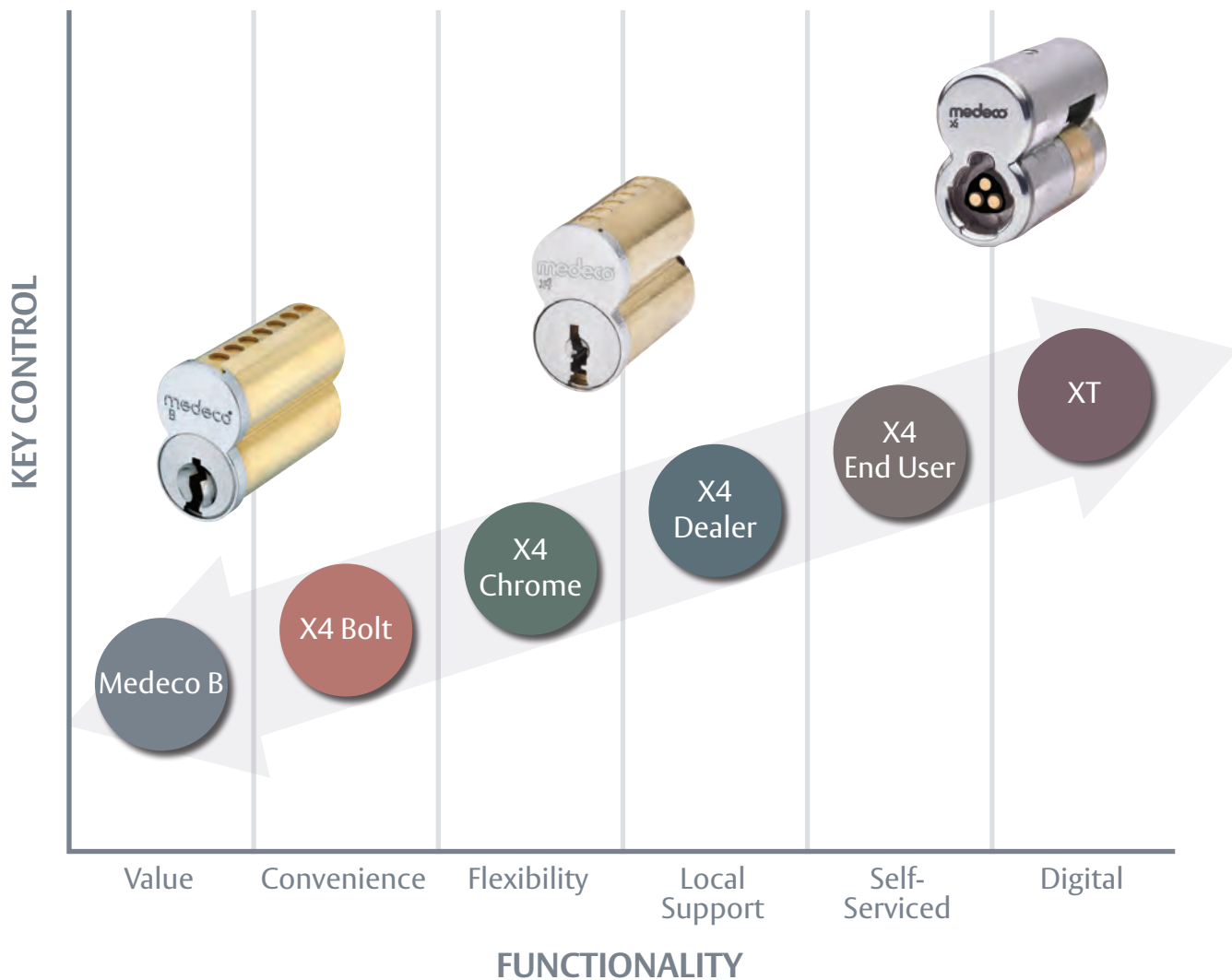

# Medeco XT



Medeco XT is a complete electronic locking system providing controlled access, accountability, physical security and effective system management. More than just a way to protect property, equipment and assets, Medeco XT is also a business tool that can lead to a substantial return on investment.

## Unique Capabilities



### Electronic Scheduling

Keys are electronically programmed to open only specific locks during a designated schedule. Schedules may also contain an expiration point to completely disable the key until it is audited and reprogrammed.



### Audit Accountability

Audit information recorded in both the lock and key shows a time-and-date-stamped record of every event, including authorized accesses and unauthorized attempts.



### Data Dashboard

Data Analytics shows system data in a graphical way. It consists of several mini-dashboards that provide insight into your system configuration and audit events.



### Uses Existing Hardware

Medeco XT keys provide all power to the cylinder, eliminating the need for any hard wiring or power supply. Simply remove the existing mechanical cylinder and install the Medeco XT cylinder.



### Physical Security

Medeco XT products add a wide variety of intelligent features without compromising on physical security. Attack-resistant design and tamper-proof features provide strong protection against forced entry.



### Efficient System Management

Medeco XT software contains tools that will help you manage your security more efficiently. Flexible programming, scheduled access and full audit reports are offered with the convenience of stand-alone or web-based software.



### Bluetooth

Bluetooth enabled option with iOS and Android app support.

# Medeco XT System Overview

Medeco XT software contains tools that will help you manage your security more efficiently. Flexible programming, scheduled access and full audit reports are offered with the convenience of web-based software. Medeco XT Web Hosting provides a global solution to programming and scheduling XT Keys and Cylinders.

Administrators have the ability to change schedules and retrieve audit information from their Medeco XT keys without having to physically possess the key. With the downloadable programming client, a key holder can dock and synchronize with the XT Web Server from anywhere in the world with a PC and an internet connection. Our web-hosted programming offers secure web access and year-round 24/7 access, making it a cost-effective electronic solution to meet any customer's needs.

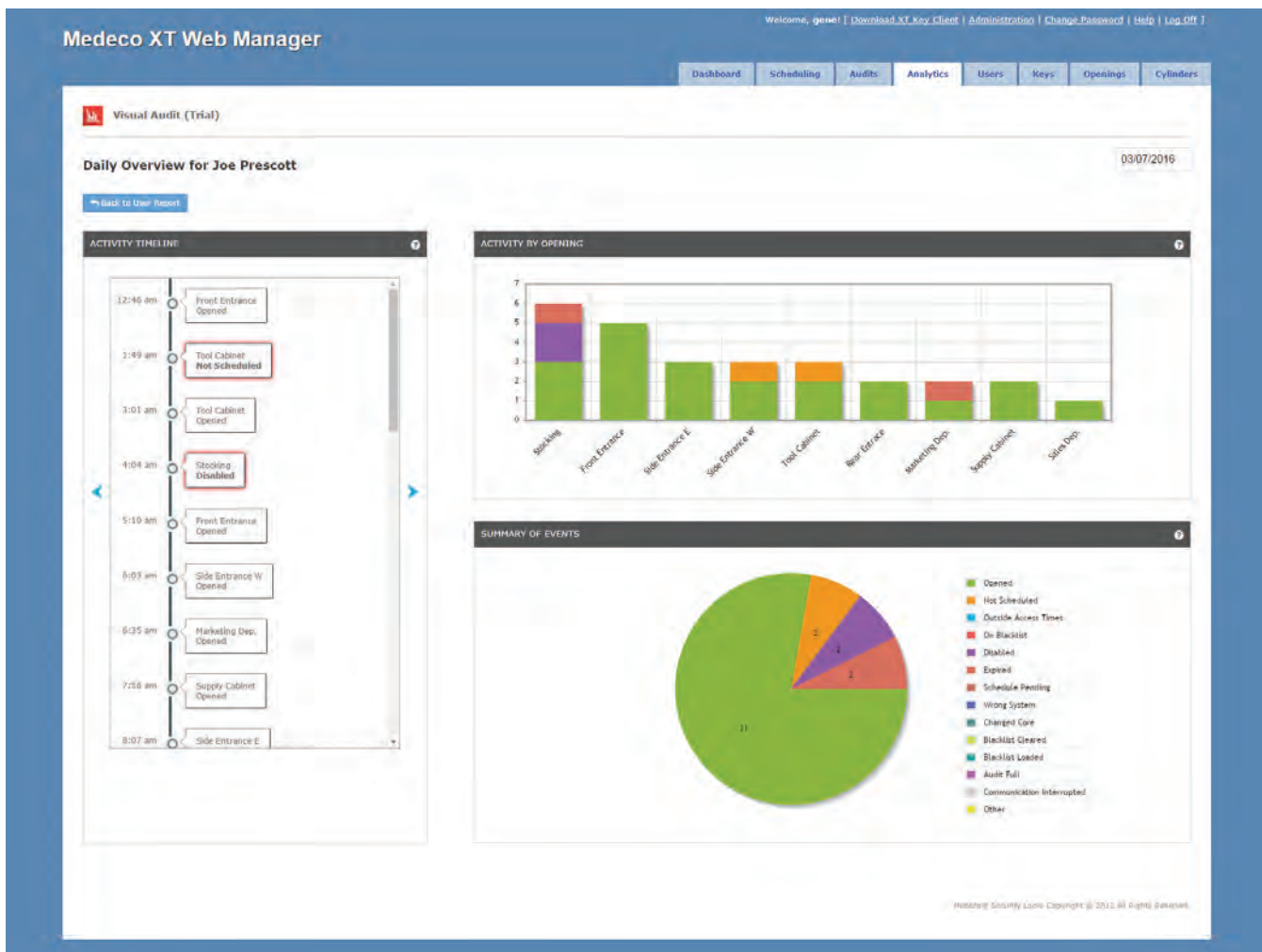

# Medeco X4



Medeco X4 is the perfect security upgrade for Small Format Interchangeable Core facilities. All facilities need patented key control to effectively secure exterior and interior openings. This strength of integrity allows security managers to have peace of mind when it comes to managing their system.

Medeco X4 is the most economic and efficient solution. Patent protected until 2027 and with one of the largest master keying capabilities on the market, Medeco X4 allows facility managers to tie everything together under one key for ease, convenience and efficiency. Additionally, Medeco X4 easily retrofits into existing door hardware, so installation time is minimal.

## Unique Capabilities



### Protected by Federal Utility Patent to 2030

Patent protection prevents unauthorized duplication of keys and allows Medeco to eliminate manufacture and supply of imitators.



### Competitively Priced

Unlike many competitors, the price of a Medeco X4 pinned core includes the cost of 2 cut keys and there is no additional charge for master keying.



### Uses Existing Hardware

Retrofit cylinders available in many different formats, including SFIC, eliminating the need to replace expensive door hardware.



### Large System Capability

Key systems can be extended to four times that of other SFIC products.



### Complete Facility Solution

Cores can be integrated into a single key system where traditional and small format cylinder types can be operated by the same keys.

# Medeco B



Medeco B offers unlimited flexibility and keying options. Available in standard 6 and 7 pin formats in industry standard keyways, Medeco B can be installed in both new and existing key systems.

## Key Control

Unrestricted/Off-Patent      Customers do not need a contract to purchase Medeco B SFIC Cores. Cores are available through Medeco and authorized distributors.

## Unique Capabilities



### Value Priced

Medeco B is priced to save clients money vs. other unpatented competitors and can be substituted directly into existing master key systems.



### Solid Brass Construction

Quality metals provide for unbeatable durability.



### Reinforced

Manufactured with a reinforced sleeve design.

# Medeco B Small Format Interchangeable Core

SFIC Keyway Cross Reference Guide							
KEYWAY	MEDECO <sup>B</sup>	STANLEY	FALCON	KSP	GMS	MSB	OAK
1C	✓	✓	✗	✓	✓	✗	✗
1D	✓	✓	✗	✓	✓	✗	✗
AB	✓	✓	✓	✓	✓	✓	✓
BB	✓	✓	✓	✓	✓	✗	✗
CB	✓	✓	✓	✓	✓	✓	✗
DB	✓	✓	✓	✓	✓	✗	✗
EB	✓	✓	✓	✓	✓	✓	✓
FB	✓	✓	✓	✓	✓	✗	✗
GB	✓	✓	✓	✓	✓	✓	✓
HB	✓	✓	✓	✓	✓	✗	✗
JB	✓	✓	✓	✓	✓	✓	✓
KB	✓	✓	✓	✓	✓	✗	✗
LB	✓	✓	✓	✓	✓	✓	✓
MB	✓	✓	✓	✓	✓	✗	✗
QB	✓	✓	✓	✓	✓	✓	✓
RB	✓	✓	✓	✓	✓	✗	✗
TA	✓	✓	✓	✗	✗	✗	✗
TB	✓	✓	✓	✓	✓	✗	✗
TC	✓	✓	✗	✗	✓	✓	✗
TD	✓	✓	✓	✓	✓	✗	✗
TE	✓	✓	✓	✗	✓	✓	✗
WA	✓	✓	✓	✗	✓	✓	✓
WB	✓	✓	✗	✗	✓	✓	✓
WC	✓	✓	✗	✗	✓	✓	✓
WG	✓	✓	✗	✗	✓	✓	✓
WH	✓	✓	✗	✗	✓	✓	✓
WY	✓	✓	✗	✗	✗	✗	✓



# Medeco® Professional Services

High-quality products alone do not guarantee a successful product experience; value-added services are often needed to ensure that complex systems are designed to work effectively both now and in the future. In order to protect your investment and provide you with the best possible support, Medeco recommends the use of professional design and implementation services to ensure you derive the greatest value on your product investment.

Medeco can provide the technical expertise and skilled resources to help you scope, plan and support your next project. By identifying technical complexities and risks up front, we can ensure the system has been designed to grow with your needs, and identify any issues that might interfere with a trouble-free installation.

We will also provide technical training for your team so that you will properly operate, customize and support Medeco Intelligent Key solutions and mechanical security. And, when there is an issue, we can provide fast, professional and cost effective assistance via phone, email or online.

## Professional Services – Medeco XT Key Systems

### System Planning

Remote Planning Support	SW-501Remote
• <b>System Design Assistance</b>	– Ensure that your system is designed with your current and future interests in mind.
• <b>Hardware Requirements</b>	– Determine the required hardware to meet your implementation goals.
Onsite Planning Support	SW-501Site
• <b>Pre-Deployment Meetings</b>	– Live in person coordination of events and timeline planning.
• <b>Bench-Top Deployment and Validation</b>	– Full functionality testing of hardware in a test environment to ensure complete satisfaction before deployment.

### System Deployment

Remote Deployment Services	SW-502Remote
• <b>Remote Software Installation</b>	– Live online assistance with software installation to ensure complete functionality.
• <b>Remote Software Upgrades</b>	– Using our remote access software we will ensure that your software upgrades go without issue, including data conversions.
Onsite Deployment Services	SW-502Site
• <b>Equipment Configuration</b>	– The assistance you need to get all of your equipment programmed and installed in a timely manner.
• <b>Software Installation / Upgrades</b>	– No need to worry about software installation, we will be there to perform this task for you.

For pricing, contact Medeco Customer Care at 1-877-633-3261 or [customerservice.medeco@assaabloy.com](mailto:customerservice.medeco@assaabloy.com)

## Professional Services – Medeco XT Key Systems

### **Enterprise System Support** (Includes standard support hours of 8am - 5pm, M - F)

#### Enterprise System Support – Silver SW-504Silver

- **Enterprise System Support – Silver** – Software System Support; Extended phone support; 6am – 8am and 5pm – 7pm Eastern, Monday – Friday; 2 hour response time to email requests; Real time phone support; Up to 35 tickets annual

#### Enterprise System Support – Gold SW-504Gold

- **Enterprise System Support – Gold** – Software System Support; Extended phone support; 6am – 8am and 5pm – 10pm Eastern, 7 Days per week; 1 hour response time to email requests; Real time phone support; Up to 50 tickets annual

### **Training and Sustaining**

#### Remote Training SW-503Remote

- **Web Based Training** – Online training setup to meet your planning schedule.
- **Additional Training Based on New Staff/Turnover** – Online training to help you keep up with new staff requirements.

#### Onsite Training SW-503Site

- **Hands-on Training** – In depth face to face training for our hardware and software applications.
- **Detailed Product Installation Classes** – On site classes to train your employees on site specific hardware installation.

All prices are U.S. NET, and not subject to dealer discounting. T&E charges will be quoted upon request.

## Professional Services – Mechanical Key Systems

#### Training Certification Classes SW-505Site

##### **Personalized on-site factory technical certification class(es).**

Medeco will conduct field training, demonstrate sample equipment, and certify students on service, maintenance, and support. These are the same certification classes given at factory and trade shows. Various classes available including Medeco<sup>3</sup>, Medeco x4, Medeco XT, CLIQ and Medeco Master Keying — see training catalog for further details.

#### Master Key Consultation SW-506Site

##### **Master key system design consultation with a Medeco key system design expert.**

In person key system design consultation with a system design expert. We will assist you in the development of a master key system to meet your design specifications. The system will be uniquely tailored to your facility, resulting in custom Key System Schematics, biting lists and pinning charts.

#### Key Management Consultation SW-507Site

##### **Assistance in the design, implementation, customization, and best practices for sound key control.**

Assistance in the design, implementation, customization, and best practices for sound key control products and key management policies and procedures that will minimize liabilities and extend key system lifespan. A key system investment will be maximized by deploying these sound key management practices.

#### Installation Inspection SW-508Site

##### **Project product installation and operation inspection and certification.**

# SFIC Cylinders



Medeco XT		LEVEL 3 – Intelligent Keys
Cores Only	Part Number	Notes
Medeco XT Intelligent Key Digital Small Format Interchangeable Core	EA-100108	All master keying is digital and managed by the software



Medeco X4		LEVEL 1 – Patented Key Control
Cores Only	Part Number	Notes
6 Pin Small Format Interchangeable Core with Clip Retainer, Removable Front Plate	33600006 (P)	Pinned pricing includes master key system design and pinning, as well as two cut keys.  Note: Conventional cylinders are available (KIK, Rim, Mortise, etc.) and can be easily integrated into an SFIC Master Key System
	33600006 (S)	
7 Pin Small Format Interchangeable Core with Clip Retainer, Removable Front Plate	33700006 (P)	
	33700006 (S)	

(P) = Pinned (S) = Sub-Assembled

### How to Order:

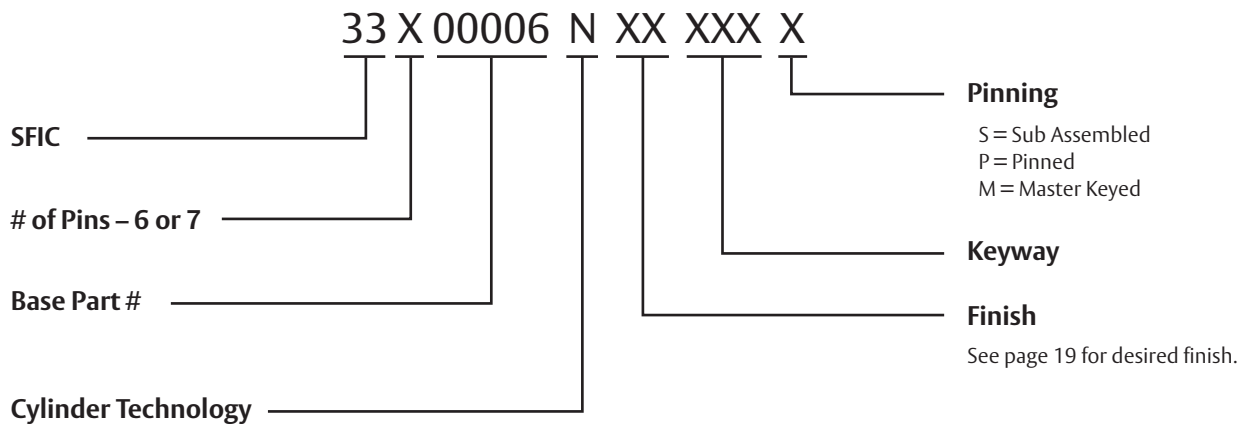

# SFIC Cylinders



Medeco B		LEVEL 0 – Convenience
Cores Only	Part Number	Notes
6 Pin Small Format Interchangeable Core, Medeco face plate	33-6B07X (P)	Pinned pricing includes master key system design and pinning, as well as two cut keys
	33-6B07X (S)	
6 Pin Small Format Interchangeable Core with plain face	33-6B01X (P)	
	33-6B01X (S)	
7 Pin Small Format Interchangeable Core, Medeco face plate	33-7B07X (P)	
	33-7B07X (S)	
7 Pin Small Format Interchangeable Core with plain face	33-7B01X (P)	
	33-7B01X (S)	

(P) = Pinned (S) = Sub-Assembled



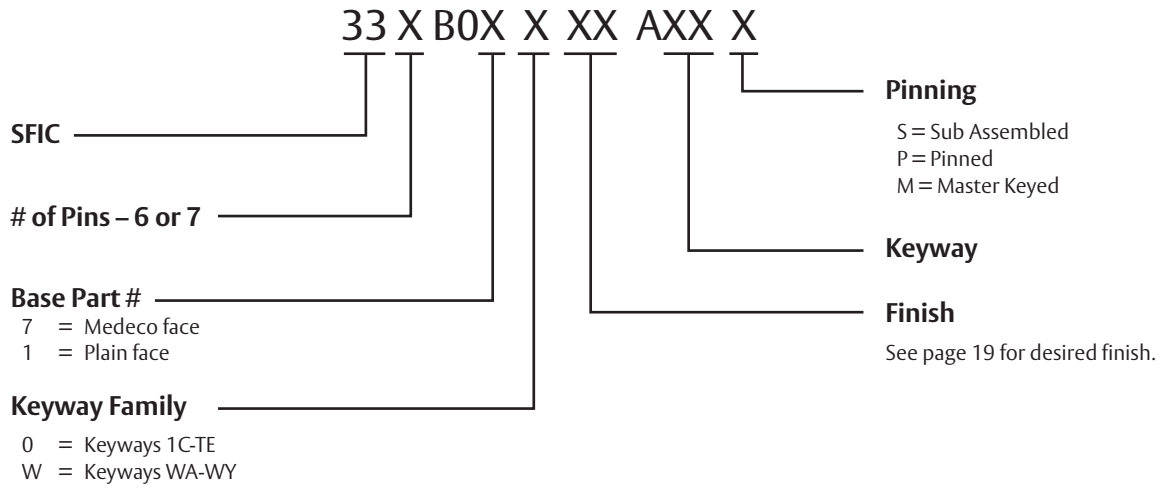



## How to Order:





# SFIC Housings



## Medeco SFIC Mortise Housings

Description	Part Number
 6 Pin 1 1/4" Mortise Housing Only*	33076011
 6 or 7 Pin 1 3/8" Mortise Housing Only*	33076021
 7 Pin 1 1/2" SFIC Mortise Housing Only* If using 6 Pin core spacer CP-160420 required	33076025
 7 Pin 1 3/8" Housing Only for Corbin® Russwin® Master Ring Cylinders*	33076028
 6 Pin 7/8" Tapered Head Mortise Housing Only*	33076051
 6 or 7 Pin 1" Tapered Head Mortise Housing Only*	33076061

## Medeco SFIC Rim Housings

Description	Part Number
 6 Pin 1 1/2" Rim Cylinder Housing Only	3307603H
 7 Pin 1 1/2" Rim Cylinder Housing Only	3307604H
 7 Pin Corbin® Jumbo Rim Housing Only	33076048

\* All Medeco SFIC Mortise Housings have a screw-on interchangeable cam.", simplifying inventory by allowing you to quickly adapt any housing to fit any hardware.

See Medeco's full line catalog for a complete listing of cams offered.

# Maxum SFIC Deadbolts



## Maxum SFIC Deadbolts

Certification	ANSI A156.36, Grade 1 UL437 Listed cylinder for high security
Door Thickness	Fits 1-3/8" to 2-1/2" Thick
Strike	2-3/4" x 1-1/8", round corners
Warranty	2 Years

Product	Function	Faceplate	Backset	Cylinder	Part Number
<b>Grade 1 Deadbolt</b>	Single	1-1/8"	2-3/8"	Less Core	11C701
	Single	1-1/8"	2-3/4"	Less Core	11C702
	Single	1"	2-3/8"	Less Core	11C703
	Single	1"	2-3/4"	Less Core	11C704
	Single	Drive-In	2-3/8"	Less Core	11C705
	Single	Drive-In	2-3/4"	Less Core	11C706
	Single	1-1/8"	2-3/8"	Less Core	11C711
	Single	1-1/8"	2-3/4"	Less Core	11C712
	Single	1"	2-3/8"	Less Core	11C713
	Single	1"	2-3/4"	Less Core	11C714
	Single	Drive-In	2-3/8"	Less Core	11C715
	Single	Drive-In	2-3/4"	Less Core	11C716
	Double	1-1/8"	2-3/8"	Less Core	11C721
	Double	1-1/8"	2-3/4"	Less Core	11C722
	Double	1"	2-3/8"	Less Core	11C723
	Double	1"	2-3/4"	Less Core	11C724
	Double	Drive-In	2-3/8"	Less Core	11C725
	Double	Drive-In	2-3/4"	Less Core	11C726

# System Series SFIC Padlocks



## Indoor/Outdoor Padlock, 5/16" Shackle - less SFIC

Description	Part Number
Key Retaining, 1 1/8" Shackle Clearance, Less Cylinder	54315K0
Non-Key Retaining, 1 1/8" Shackle Clearance, Less Cylinder	54315L0
Key Retaining, 2 3/8" Shackle Clearance, Less Cylinder	5431FK0
Non-Key Retaining, 2 3/8" Shackle Clearance, Less Cylinder	5431FL0

## Indoor/Outdoor Padlock, 7/16" Shackle - less SFIC

Description	Part Number
Key Retaining, 1 3/8" Shackle Clearance, Less Cylinder	54415K0
Non-Key Retaining, 1 3/8" Shackle Clearance, Less Cylinder	54415L0
Key Retaining, 1 7/8" Shackle Clearance, Less Cylinder	5441FK0
Non-Key Retaining, 1 7/8" Shackle Clearance, Less Cylinder	5441FL0

## Shrouded Padlock, 5/16" Shackle - less SFIC

Description	Part Number
Key Retaining, 3/4" Shackle Clearance, Less Cylinder	54325K0
Non-Key Retaining, 3/4" Shackle Clearance, Less Cylinder	54325L0

## Shrouded Padlock, 7/16" Shackle - less SFIC

Description	Part Number
Key Retaining, 3/4" Shackle Clearance, Less Cylinder	54425K0
Non-Key Retaining, 3/4" Shackle Clearance, Less Cylinder	54425L0

# EPIC–Euro Profile Interchangeable Core



## EPIC–Euro Profile Interchangeable Core

### 6 Pin Part Numbers

Description	Part Number
EPIC Euro Double 37.9 mm/37.9mm	2326D21
EPIC Euro Half 37.9mm	2326H01
EPIC Euro with Thumbturn 40mm int/39.2 mm ext	2326S12X*
Small Format Interchangeable Core (SFIC)	3360000R (P)
Small Format Interchangeable Core (SFIC)	3360000R (S)

### 7 Pin Part Numbers

Description	Part Number
EPIC Euro Double 41.73mm/41.73mm	2324D21
EPIC Euro Double 41.73mm/55mm	2324D25
EPIC Euro Half 41.73mm	2324H01
EPIC Euro Half 55mm	2324H05
EPIC with Thumbturn 40mm int/43mm ext	2324S12X
EPIC with Thumbturn 40mm int/55mm ext	2324S15X
EPIC with Thumbturn 55mm int/43mm ext	2324S52X

\*X denotes thumb turn.



# SFIC Cabinet Locks



## SFIC Cabinet Locks

Description	Part Number
Cabinet lock with deadbolt for SFIC cylinder. Works with Medeco X4, Medeco XT SFIC, or Best style SFIC. SFIC ordered separately.	3307311
Cabinet lock with spring latch for SFIC cylinder. Works with Medeco X4, Medeco XT SFIC, or Best style SFIC. SFIC ordered separately.	3307321
File Cabinet Lock for SFIC cylinder. Works with Medeco X4, Medeco XT SFIC or Best style SFIC Cylinders . SFIC ordered separately.	3307350
Door/Drawer Lock for SFIC cylinder. Works with Medeco X4, Medeco XT SFIC, or best style SFIC. SFIC ordered separately.	3307331
SFIC Mailbox Lock	3307360
SFIC Ratchet Lock	3307340

# SFIC Keys



## Keyblanks for Door Hardware – Medeco B

For Keyways: 1C, 1D, AB, BB, CB, DB, EB, FB, GB, HB, JB, KB, LB, MB, QB, RB, TA, TB, TC, TD, TE	Part Number
Key Blank	KYBA50000A XX 00
Cut Key	KYCA50000A XX 00
Control Key	KYC A50000A XX 03

**XX = Keyway**

For Keyways: WA, WB, WC, WG, WH, WY	Part Number
Key Blank	KYBA60000A XX 00
Cut Key	KYCA60000A XX 00
Control Key	KYCA60000A XX 01

**XX = Keyway**

## Keyblanks for Door Hardware – Medeco X4

Description	Part Number
6 or 7 Pin Keyblank for Medeco X4 (Small Bow, Custom Coined)	KYB 32X900 XX 99
6 or 7 Pin Keyblank for Medeco X4 (Large Bow, Custom Coined)	KYB 38X900 XX 99

**X = 6 or 7 Pin XX = Keyway**

## Medeco XT Keys

Description	Part Number
Medeco XT Industrial Key (G2)	EA-100107
Medeco XT Slim Line Key Basic (G2)	EA-100156
Medeco XT Slim Line Key Plus (G3S)	EA-100178
Medeco XT Slim Line Key Bluetooth (G3B)	EA-100177

**All Medeco XT Keys can be programmed to function as Operator, Audit, Control and Program Keys.**

## Medeco XT Key Bundle

Description	Part Number
Medeco XT Industrial Key (G2) & Charger Bundle. Includes Medeco XT Industrial Key, Portable Charger & USB Cable.	94-0239
Medeco XT Slim Line Key Basic (G2) & Charger Bundle. Includes XT Slim Line Key, Charger & USB Cable.	94-0271
Medeco XT Slim Line Key Plus (G3S) & Charger Bundle. Includes XT Slim Line Key, Charger & USB Cable.	94-0307
Medeco XT Slim Line Key Bluetooth (G3B) & Charger Bundle. Includes XT Slim Line Key, Charger & USB Cable.	94-0306

# Finishes Available

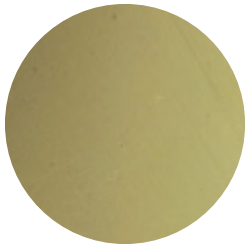

05  
(US03)  
Bright Brass

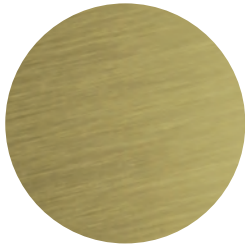

06  
(US04)  
Satin Brass



09  
(US5)  
Antique Brass



10  
Satin Brass  
Blackened

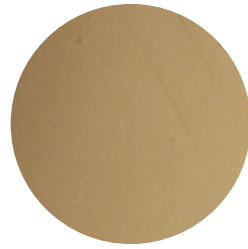

11  
(US9)  
Bright Bronze



12  
(US10)  
Satin Bronze



13  
(US10B)  
Dark Bronze/  
Oil Rubbed

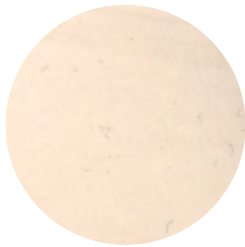

18  
(US14)  
Bright Nickel



19  
(US15)  
Satin Nickel

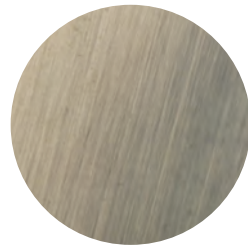

20  
(US15A)  
Antique Nickel



22  
(US19)  
Flat Black

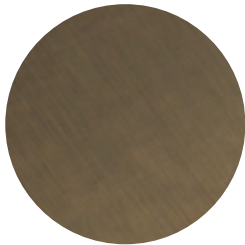

24  
(US20A)  
Dark Bronze/  
Clear Coat

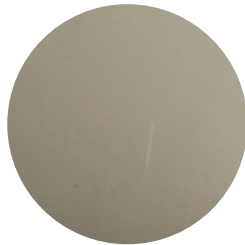

25  
(US26)  
Bright Chrome



26  
(US26D)  
Satin Chrome

*Note: Product appearance may differ from this chart as a result of the differences in plated versus printed materials.*



MEDECO U.S.: 3625 Alleghany Drive | P.O. Box 3075 | Salem, Virginia 24153-0330  
Customer Service: 1-877-633-3261

MEDECO CANADA: 160 Four Valley Drive | Vaughan, ON L4K 4T9 CANADA  
Customer Service: 1-888-633-3264

The ASSA ABLOY Group is the global leader in access solutions. Every day we help people feel safe, secure and experience a more open world.



[facebook.com/medecolocks](https://facebook.com/medecolocks)



[twitter.com/medecolocks](https://twitter.com/medecolocks)



[youtube.com/medecolocks](https://youtube.com/medecolocks)



[instagram.com/medecolocks](https://instagram.com/medecolocks)



newsletter sign-up: [medeco.com](https://medeco.com)