

MOEN®



MOEN®





Transforming and creating a meaningful difference in your personal experience with water.

At Moen®, we've spent decades revolutionizing the way people experience water at home.

From the historic invention of the first single-handle mixing valve to the only faucet you never have to touch, every innovation is born at the intersection of form and function.

But Moen is more than a faucet company; we're a water experience company that happens to make faucets. With 1.5 trillion gallons of water flowing through our products every year in the U.S. alone, our responsibility isn't only to you and water itself.

That's why we continue differentiating ourselves through innovation, expertise, and our brand purpose. Because it's not enough to be a brand you buy into; we need to be one you believe in.

Contents

2024 NEW COLLECTIONS AND PRODUCTS

MISSION MOEN

SMART WATER NETWORK

- 46 Collection Feature:
Smart Water Network
- 50 Smart Customizable Water
- 54 Smart Water Security
- 56 Smart Irrigation

KITCHEN AND BAR

- 62 Smart Faucets
- 73 Premium Faucets
- 80 Faucets
- 95 Premium Pot Fillers
- 96 Premium Bar/Prep
- 98 Bar/Prep
- 101 Laundry Faucets
- 102 Water Filtration Systems & Faucets
- 109 Premium Soap Dispensers

KITCHEN SINKS

- 116 Luxe Chef™
- 117 Workstation System Sinks
- 119 Workstation Sinks
- 120 Host™
- 121 Fireclay Sinks
- 121 Granite Sinks
- 124 Prep™
- 125 Stainless Steel Sinks
- 130 Sink Accessories

DISPOSALS

- 138 Luxe Chef | 1 Horsepower
- 139 Host | ¾ Horsepower
- 140 Prep | ½ Horsepower
- 141 Lite™ | ½ Horsepower
- 142 Disposal Accessories

EBIDETS AND ETOILETS

- 147 Electronic Bidet Seats
- 148 Non-Electronic Bidet Seats
- 149 Electronic Cleansing Toilets

BATH AND SHOWER

- 156 Smart Faucets
- 159 Weymouth®
- 173 Arris®
- 183 Flara™
- 194 Colinet™
- 205 90°°
- 217 Doux™
- 228 Greenfield™
- 239 Wynford®
- 250 Align®
- 263 Rizon®
- 273 Belfield
- 286 Cia™
- 296 Voss™
- 310 Dartmoor®
- 316 Glyde™
- 323 Brantford®
- 332 Eva®
- 341 Vichy®
- 345 Gibson™
- 354 Genta™ LX
- 362 Chateau®



CUSTOM SHOWERING

- 375 Smart Shower
- 378 ExactTemp®
¾" Thermostatic Showering
- 384 M-CORE® 3-Series Integrated
Transfer Valve Trim
- 391 M-CORE Transfer Valve Trim
- 420 Annex™ Shower Rail
- 432 Posi-Temp® Integrated
Transfer Valve Trim
- 437 Showerheads
- 447 Handheld Showers
- 451 Magnetix™ Handheld Showers
- 454 Accessories and Body Sprays
- 459 Tub Spouts and Drains

VALVES

- 468 Bath and Showering Valves

COORDINATING ACCESSORIES

- 488 Mason®
- 489 Retreat®
- 490 Arlys™
- 491 Triva™
- 492 Sage®
- 493 Iso™
- 495 Kyvos®
- 496 Lounge™
- 497 Madison™
- 498 Preston™
- 499 Aspen™
- 500 Kingsley®
- 502 Gilcrest®
- 502 Glenshire®
- 504 Donner™
- 504 Straight Shower Rods
- 505 Build-Your-Own
Straight Shower Rod
- 506 Contemporary
- 507 Stainless Steel
- 508 Economy Metal
- 509 Hotel/Motel
- 510 Recessed Fixtures

COORDINATING ACCESSORIES

- 511 30" Towel Bars
- 512 Shower Rods and Rings
- 513 Double Curved Shower Rods
- 514 Curved Shower Rods
- 515 Straight Shower Rods
- 517 Shower Curtain Rings
- 518 Lighting
- 523 Knobs and Pulls
- 526 Bath Safety
- 529 Collection Grab Bars
- 535 Designer Grab Bars
- 537 Standard Grab Bars
- 540 Grab Bars with Accessories
- 540 SecureMount™ System
- 540 Hand Grips
- 541 Chairs, Seats and Benches
- 542 Tub, Shower and Toilet Safety
- 542 Handheld Shower

MOEN GENUINE

REPLACEMENT PARTS

- 544 Moen Genuine Replacement Parts

BULK PACK PRODUCTS

- 597 Bulk Pack Products

COMMERCIAL FAUCETS, VALVES AND SHOWER

- 617 Commercial Faucets, Valves and
Shower



2024 New Collections and Products

- A | Tenon™ Kitchen Collection
- B | Reverse Osmosis and Carbon Compatible SIP® Drinking Water Faucets
- C | Smyth™ Collection and Lifeshine® Bronzed Gold Finish in Select Kitchen Products
- D | Verso™ Shower Platform Expansion
- E | Brushed Gold and Matte Black Finish Expansion in Select Grab Bars
- F | Luxe Chef™ Workstation System Sinks and Luxe Chef, Host™ and Prep™ Disposals
- G | Select Prep Stainless Steel Sinks
- H | Widespread Faucet Expansion in Select Bath Collections
- I | Smart Faucet with Motion Control Platform Expansion in Select Kitchen Collections



D



E



G



F



H



I

MISSION  MOEN™

Preserving the World's Most Precious Resource

OUR PROMISE TO THE WATER OF TOMORROW

Mission Moen is our pledge to conserve and protect the world's most precious resource while helping people enjoy it even more.

It's our promise to the water of tomorrow and the guiding principle behind our innovation and design. And importantly, it's an invitation for consumers to join us. To reconsider the immeasurable value of water and make simple choices that treat it with the care and reverence it deserves.

By 2030, our innovations will help consumers save 1 trillion gallons of water, and our intentional design and engineering will help repurpose 2,000 tons of ocean plastic.

Because water designs our life, and together, we can keep it that way.

Want to learn more? Visit [moen.com/mission-moen](https://www.moen.com/mission-moen).

Wholesale

Listed in numerical order

MODEL NUMBER	LIST PRICE	PAGE NO.	UNIVERSAL PRODUCT CODE	CASE QTY	MODEL NUMBER	LIST PRICE	PAGE NO.	UNIVERSAL PRODUCT CODE	CASE QTY
2-100-5A	7.10	505	034584100108	50	601	44.00	556	026508072158	12
2-100-6A	8.85	505	034584100115	50	615	1752.20	287	026508335895	1
2-10155SS	14.40	505	034584100092	25	615BG	2365.55	287	026508335901	1
2-10156SS	21.50	505	034584100085	20	615BN	2365.55	287	026508335925	1
2-102-5PS	28.35	516	034584003522	25	615BL	2601.95	287	026508335918	1
2-102-5BS	29.75	516	034584003539	25	620	1752.20	228	026508364260	1
2-102-5BL	35.45	516	034584038548	25	620BG	2365.55	228	026508364277	1
2-100-5SS	38.40	505	034584100283	25	620BN	2365.55	228	026508364291	1
2-100-6SS	42.45	505	034584100290	20	620BL	2601.95	228	026508364284	1
3CH	4.95	506	034584015945	200	655	1912.45	240	026508298404	1
52-F	4.95	505	034584100603	200	655BN	2581.80	240	026508298411	1
52-5	12.15	504	034584484741	50	655ORB	2840.05	240	026508298435	1
52-6	13.70	504	034584484758	50	695	1912.45	297	026508280973	-
52-5-SS	19.25	504	034584484857	10	695BG	2581.80	297	026508290415	1
52-5-OWB	28.00	504	034584008244	10	695BN	2581.80	297	026508280980	1
52-5-BN	41.90	504	034584011909	10	695NL	2581.80	297	026508290422	1
54-F	1.50	505	034584100689	200	695BL	2641.90	297	026508371299	1
54-5	8.65	504	034584484765	50	695ORB	2840.05	297	026508280997	1
54-6	10.30	504	034584484789	50	900-001	767.70	54	860000103503	1
55-F	11.45	505	034584100429	50	900-006	846.10	54	860000103572	1
55-5	49.80	504	034584484871	50	900-002	1230.75	54	860000103534	1
58-F	9.65	505	034584100443	50	902	1.95	508	034584711007	50
58-5	48.05	504	034584484895	50	908	3.60	508	034584712004	100
61-F	1.80	505	034584100610	200	910	3.35	508	034584719003	100
61-5-SS	16.00	504	034584484918	50	910A18	4.65	508	034584713001	24
63-F	4.80	505	034584100627	200	910A24	5.20	508	034584714008	24
63-5	11.95	504	034584484802	50	920-002	8.10	54	026508351246	20
63-5-SS	19.05	504	034584484949	50	920-002	8.10	54	026508351246	20
63-5-HD	43.20	504	034584484932	50	920-003	18.75	54	860000103510	10
65-F-PS	20.20	516	034584003546	25	920-006	36.20	55	850015061011	36
65-F-BS	23.25	516	034584003553	25	920-004	78.05	55	860000103596	25
65-F-BL	25.25	516	034584038555	25	920-005	203.00	55	850015061004	4
117	7.25	548	026508001172	72	930-011	7.65	563	026508344064	50
162	117.40	557	026508043349	6	930-001	62.40	54	860000103541	24
220H5	250.50	451	026508377062	2	930-002	62.40	54	860000103558	24
220H5EP	250.50	451	026508377109	2	930-003	72.05	54	026508325438	24
220R5	275.40	440	026508377185	2	930-004	72.05	54	026508325445	24
220R5EP	275.40	440	026508377222	2	930-005	104.85	54	026508325452	12
220R7	275.40	440	026508377307	2	930-006	104.85	54	026508325469	12
220R7EP	275.40	440	026508377345	2	935-003	1.95	563	026508343876	500
220C3	280.90	451	026508348123	2	935-008	1.95	563	026508343883	250
220C3EP	280.90	451	026508348161	2	935-002	8.10	563	026508349397	48
220C5	280.90	451	026508376942	2	935-009	8.55	563	026508349441	48
220C5EP	280.90	451	026508376980	2	935-016	9.25	563	026508370513	192
220R3	282.80	440	026508366271	2	935-017	11.15	563	026508370520	96
220R3EP	282.80	440	026508366318	2	935-005	15.00	563	026508349427	48
220H5BL	318.30	451	026508377086	2	935-007	15.45	563	026508349410	48
220H5BN	324.65	451	026508377093	2	935-014	21.25	563	026508349496	24
220H5EPBL	324.65	451	026508377123	2	935-001	22.80	563	026508349380	48
220H5EPBN	324.65	451	026508377130	2	935-006	23.30	563	026508349434	48
220R5BL	358.00	440	026508377208	2	935-015	27.00	563	026508349502	45
220R5BN	358.00	440	026508377215	2	935-004	55.80	563	026508349403	24
220R5EPBL	358.00	440	026508377246	2	935-011	75.30	563	026508349465	96
220R5EPBN	358.00	440	026508377253	2	950	3.65	508	034584718006	200
220R7BL	358.00	440	026508377321	2	1011	17.35	142	026508269176	6
220R7BN	358.00	440	026508377338	2	1017	17.90	143	026508269190	50
220R7EPBL	358.00	440	026508377369	2	1023	8.95	143	029122010230	24
220R7EPBN	358.00	440	026508377376	2	1024	10.95	143	029122010247	24
220H5BG	361.90	451	026508377079	2	1026	10.05	143	029122010261	6
220C3BL	365.15	451	026508348147	2	1037	9.95	143	029122010850	6
220C3BN	365.15	451	026508348154	2	1200	52.90	547	026508012000	18
220C3EPBL	365.15	451	026508348185	2	1200B	52.90	550	026508005019	144
220C3EPBN	365.15	451	026508348192	2	1212	85.00	548	026508342817	12
220C5BL	365.15	451	026508376966	2	1213	110.00	548	026508328057	12
220C5BN	365.15	451	026508376973	2	1213	110.00	548	026508328057	12
220C5EPBL	365.15	451	026508377000	2	1214	389.00	548	026508360538	12
220C5EPBN	365.15	451	026508377017	2	1215	110.00	547	026508356906	12
220R3BG	367.65	440	026508366288	2	1222	88.30	548	026508014004	18
220R3BN	367.65	440	026508366301	2	1222B	88.30	550	026508043868	72
220R3EPBG	367.65	440	026508366325	2	1222HD	110.35	550	026508207604	18
220R3EPBN	367.65	440	026508366349	2	1222HD	110.35	550	026508207604	18
220H5EPBG	369.15	451	026508377116	2	1224	17.35	547	026508012246	18
220R5BG	393.80	440	026508377192	2	1224B	17.35	550	026508004609	144
220R5EPBG	393.80	440	026508377239	2	1225	33.35	547	026508012253	36
220R7BG	393.80	440	026508377314	2	1225B	33.35	550	026508004616	144
220R7EPBG	393.80	440	026508377352	2	1234	16.80	548	026508251669	18
220C3BG	401.70	451	026508348130	2	1248	17.35	547	026508004623	18
220C3EPBG	401.70	451	026508348178	2	1248B	17.35	550	026508043226	144
220C5BG	401.70	451	026508376959	2	1255	34.15	548	026508199022	18
220C5EPBG	401.70	451	026508376997	2	1258	17.40	548	026508251676	18
220R3BL	422.80	440	026508366295	2	1576SS	12.65	510	034584704504	40
220R3EPBL	422.80	440	026508366332	2	1824	21.30	143	026508269206	10
395	1752.20	251	026508298367	1	1920	74.60	562	026508019207	6
395BG	2365.55	251	026508298374	1	1920BN	108.30	562	026508199329	6
395BN	2365.55	251	026508298398	1	1920BL	120.35	562	026508378700	6
395BL	2601.95	251	026508298381	1	1920ORB	132.95	562	026508199336	6
575	35.80	510	034584700230	20	2326PF	205.20	475	026508312339	6
588	4.25	510	034584701305	80	2328PF	205.20	475	026508312346	6

MODEL NUMBER	LIST PRICE	PAGE NO.	UNIVERSAL PRODUCT CODE	CASE QTY	MODEL NUMBER	LIST PRICE	PAGE NO.	UNIVERSAL PRODUCT CODE	CASE QTY
2353	229.85	366	026508025697	12	3853BN	158.30	461	026508164518	12
2360PF	212.60	476	026508312353	3	3853ORB	174.10	461	026508164525	12
2363	262.70	366	026508025703	12	3857	105.10	460	026508070406	6
2510	159.20	473	026508074541	6	3857BN	152.55	460	026508162453	6
2520	159.20	473	026508073001	6	3857ORB	167.80	460	026508162460	6
2521	287.50	477	026508299999	6	3858	94.30	462	026508162477	6
2551	287.50	477	026508300008	6	3858BN	136.95	462	026508162484	6
2565CH	19.85	510	034584700131	36	3858BL	150.65	462	026508357590	6
2570	193.35	473	026508073018	6	3858ORB	150.65	462	026508162491	6
2571	323.75	477	026508300015	6	3863EP	327.00	449	026508219539	6
2575	19.60	510	034584700162	36	3863EPBN	683.00	449	026508219546	6
2580	159.20	474	026508233566	6	3865EP	249.55	450	026508221495	6
2581	323.75	477	026508300022	6	3865EPBN	362.30	450	026508221501	6
2590	193.35	473	026508073025	6	3865EPORB	398.75	450	026508227619	6
2919EP	225.60	370	026508270783	6	3868EP	300.20	449	026508221532	6
2982EP	225.60	370	026508270790	6	3868EPBG	434.45	449	026508285176	6
2995EP	263.85	370	026508270806	6	3868EPBN	434.45	449	026508221549	6
3346	91.70	459	026508335819	6	3868EPORB	477.45	449	026508227633	6
3346BG	145.30	459	026508335826	6	3887EP	366.35	449	026508221575	6
3346BN	145.30	459	026508335840	6	3887EPBG	727.95	449	026508285183	6
3346BL	169.15	459	026508335833	6	3887EPBN	727.95	449	026508223239	6
3347	76.75	462	026508335857	6	3887EPBL	771.40	449	026508283509	6
3347BG	118.45	462	026508335864	6	3890	99.10	460	026508174746	12
3347BN	118.45	462	026508335888	6	3890BN	143.85	460	026508174753	12
3347BL	130.30	462	026508335871	6	3890BL	151.35	460	026508294857	12
3360	211.70	671	026508222768	6	3892	80.95	463	026508174760	12
3558EP	282.25	450	026508282274	6	3892BG	124.95	463	026508285602	6
3558EPBN	381.00	450	026508282281	6	3892BN	124.95	463	026508174777	12
3558EPBL	419.10	450	026508285442	6	3892BL	133.30	463	026508279427	6
3558EPORB	419.10	450	026508282298	6	3911	74.40	461	026508004258	12
3636EP	346.90	450	026508241677	6	3919	16.95	549	026508039199	18
3636EPBG	660.10	450	026508352267	6	3924	16.95	549	026508039243	18
3636EPBN	660.10	450	026508241684	6	3926	72.35	461	026508004272	12
3636EPBL	726.15	450	026508351017	6	3931	72.35	461	026508004289	12
3636EPORB	726.15	450	026508242773	6	3942	63.70	110	026508187586	6
3638	135.30	441	026508241691	12	3942SRS	79.60	110	026508234341	6
3638EP	135.30	441	026508242131	12	3942BL	82.80	110	026508187890	6
3638EPBG	210.70	441	026508365601	12	3944	62.50	110	026508187616	6
3638EPBL	223.50	441	026508351390	12	3944SRS	81.25	110	026508234358	6
3638BG	229.65	441	026508350959	12	3944BL	84.35	110	026508289907	6
3638BN	229.65	441	026508241707	12	3944ORB	87.45	110	026508187937	6
3638EPBN	229.65	441	026508242148	12	3959	66.70	463	26508004296	12
3638BL	231.85	441	026508305980	12	3960	74.40	461	026508004302	12
3638ORB	252.70	441	026508242155	12	3988EP	333.05	449	026508282304	6
3662EP	228.85	451	026508279861	6	3988EPBN	661.75	449	026508282328	6
3662EPBG	310.25	451	026508351000	6	3988EPSRN	661.75	449	026508282359	6
3662EPBN	310.25	451	026508279878	6	4325	98.95	459	026508364796	6
3662EPBL	378.35	451	026508324783	6	4325BG	150.30	459	026508364802	6
3662EPORB	390.35	451	026508279885	6	4325BN	156.75	459	026508364826	6
3667EP	358.60	448	026508242162	6	4325BL	176.30	459	026508364833	6
3667EPBG	708.95	448	026508350973	6	4326	79.90	462	026508364840	6
3667EPBN	708.95	448	026508242179	6	4326BG	123.45	462	026508364819	6
3667EPNL	708.95	448	026508301197	6	4326BN	123.45	462	026508364857	6
3667EPBL	779.85	448	026508350997	6	4326BL	135.85	462	026508364789	6
3667EPORB	779.85	448	026508242186	6	4500	363.60	239	026508253649	3
3668EP	300.20	449	026508242193	6	4500BN	481.25	239	026508253656	3
3668EPBN	434.45	449	026508242209	6	4500ORB	516.90	239	026508255667	3
3668EPORB	477.45	449	026508242216	6	4505	361.40	239	026508255674	3
3669EP	358.60	448	026508242223	6	4505BN	478.35	239	026508255681	3
3669EPBN	708.95	448	026508242230	6	4505ORB	513.75	239	026508255704	3
3669EPBL	779.85	448	026508290187	6	4507	538.25	239	026508255711	3
3669EPORB	779.85	448	026508242247	6	4507BN	699.75	239	026508255728	3
3670EP	401.70	448	026508300039	6	4507ORB	753.55	239	026508255742	3
3670EPBN	582.45	448	026508300053	6	4736	323.00	101	026508357569	3
3670EPBL	640.60	448	026508300046	6	4792	192.30	470	026508229583	6
3671EP	401.70	448	026508300060	6	4793	217.80	470	026508229590	6
3671EPBN	582.45	448	026508300084	6	4794	207.65	470	026508244050	6
3671EPBL	640.60	448	026508300077	6	4796	181.20	470	026508229606	6
3737	104.35	460	026508265642	6	4797	184.70	470	026508229613	6
3737BN	151.45	460	026508265659	6	4798	184.70	470	026508229620	6
3737BL	166.60	460	026508337912	6	4903	130.90	100	026508085325	12
3737ORB	166.60	460	026508265666	6	4905	270.45	100	026508138748	3
3800	86.60	461	026508030639	12	4905SRS	338.05	100	026508242902	3
3801	86.60	461	026508029473	12	4925	199.70	362	026508002360	12
3806	108.00	460	026508041680	12	4945	349.70	362	026508002537	6
3814	107.05	460	026508251041	6	4975	133.45	101	026508003206	12
3814BN	155.35	460	026508251058	6	5263EP15	58.05	668	026508237236	12
3814ORB	170.95	460	026508251065	6	5263EP17	58.05	668	026508237250	12
3828	64.15	463	026508133736	12	5263EP15CBN	105.95	668	026508237243	12
3829	64.15	463	026508133743	12	5263EP17CBN	105.95	668	026508237267	12
3829BN	147.15	463	026508133804	12	5520NC	14.70	509	03458471066	24
3829BL	153.55	463	026508300091	12	5571	28.65	509	034584115713	20
3829ORB	161.85	463	026508134375	12	5577	51.25	509	034584700605	20
3839	74.60	461	026508239490	12	5622	540.35	98	026508352281	3
3839BN	108.25	461	026508260203	1	5622SRS	675.45	98	026508352311	3
3839BL	119.00	461	026508294840	12	5622BL	702.50	98	026508352304	3
3853	76.30	461	026508070345	12	5622BG	783.55	98	026508352298	3
3853BRB	117.45	461	026508271858	12	5770SRS	579.40	99	26508387030	3

Wholesale

Listed in numerical order

MODEL NUMBER	LIST PRICE	PAGE NO.	UNIVERSAL PRODUCT CODE	CASE QTY	MODEL NUMBER	LIST PRICE	PAGE NO.	UNIVERSAL PRODUCT CODE	CASE QTY
5770BL	602.55	99	26508387009	3	6260ORB	579.55	100	026508337554	3
5770NL	625.75	99	26508387023	3	6300	45.40	443	026508154724	12
5770BZG	672.10	99	26508387016	3	6300EP	45.40	443	026508208557	12
5802CH	6.05	499	034584220011	24	6300EP15	45.40	443	026508241745	12
5808CH	13.60	499	034584220028	3	6300BN	69.25	443	026508207574	12
5818CH	15.95	499	034584220035	3	6300EPBN	69.25	443	026508208571	12
5824CH	18.30	499	034584220042	3	6302	117.05	441	026508142417	12
5882	381.35	100	026508351925	3	6302EP	117.05	441	026508208595	12
5882SRS	480.50	100	026508351949	3	6302EP15	117.05	441	026508241752	12
5882BL	495.75	100	026508351932	3	6302BN	182.70	441	026508142431	12
5886CH	10.70	499	034584220073	3	6302EPBN	182.70	441	026508208625	12
5923	647.50	83	026508267028	3	6302EPORB	201.00	441	026508208632	12
5923SRS	809.35	83	026508267035	3	6302ORB	201.00	441	026508142448	12
5923EWC	809.45	69	026508279007	3	6302WR	201.00	441	026508142486	12
5923BL	841.75	83	026508282557	3	6303	64.70	443	026508153314	12
5923BG	938.85	83	026508329573	3	6303EP	64.70	443	026508208687	12
5923BLS	938.85	83	026508294505	3	6303BN	99.15	443	026508153321	12
5923EWSRS	1011.80	69	026508279014	3	6303EPBN	99.15	443	026508208694	12
5923EWBL	1052.25	69	026508291054	3	6303EPORB	109.05	443	026508208700	12
5923EWSBG	1173.65	69	026508329580	3	6303ORB	109.05	443	026508153338	12
5923EWBLS	1173.65	69	026508294512	3	6313	64.70	443	026508214862	12
5925	513.50	92	026508315316	3	6313BN	99.15	443	026508214879	12
5925SRS	641.90	92	026508315347	3	6313ORB	109.05	443	026508214886	12
5925EWC	666.55	71	026508373293	3	6322	115.60	442	026508239506	12
5925BL	667.55	92	026508315323	3	6322EP	115.60	442	026508239513	12
5925BLS	744.60	92	026508315330	3	6322BN	190.70	442	026508260210	12
5925EWSRS	833.20	71	026508373309	3	6322EPBN	190.70	442	026508260227	12
5925EWBL	866.55	71	026508373279	3	6322BL	190.95	442	026508290095	12
5925EWBLS	966.55	71	026508373286	3	6322EPBL	190.95	442	026508290101	12
5926	540.50	90	026508357606	3	6325	115.60	442	026508230107	12
5926SRS	675.65	90	026508358078	3	6325EP	115.60	442	026508230121	12
5926BL	702.70	90	026508358061	3	6325BG	180.55	442	026508285251	12
5927	542.35	89	026508358085	3	6325BN	180.55	442	026508230114	12
5927SRS	677.90	89	026508358115	3	6325EPBG	180.55	442	026508285268	12
5927BL	705.05	89	026508358092	1	6325EPBN	180.55	442	026508230138	12
5927ORB	759.25	89	026508358108	3	6325ENPL	180.55	442	026508301210	12
5965	514.65	98	026508240007	3	6325NL	180.55	442	026508301227	12
5965SRS	643.35	98	026508240014	3	6325EPORB	198.75	442	026508230145	12
5965BL	669.05	98	026508282564	3	6325ORB	198.75	442	026508230152	12
5965BG	746.25	98	026508283851	3	6345	111.95	440	026508238554	3
5965BLS	746.25	98	026508294529	3	6345EP	111.95	440	026508281857	3
5985ORB	634.85	99	026508211809	3	6345BG	126.10	440	026508337837	3
5995	423.60	99	026508207291	3	6345BN	126.10	440	026508271469	3
5995SRS	529.50	99	026508231968	3	6345EPBG	126.10	440	026508337844	3
5995BL	550.70	99	026508228395	3	6345EPBN	126.10	440	026508281864	3
5995ORB	593.05	99	026508209790	3	6345BL	140.25	440	026508306000	3
6126	503.15	99	026508335635	3	6345EPBL	140.25	440	026508306017	3
6126SRS	628.90	99	026508335659	3	6345EPORB	140.25	440	026508281871	3
6126BL	654.10	99	026508335642	3	6345ORB	140.25	440	026508271476	3
6126NL	679.25	99	026508336700	3	6370EP	69.85	442	026508281840	12
6145	231.45	345	026508272060	3	6370	73.35	442	026508266632	12
6145BN	312.45	345	026508290064	3	6370EPBN	106.95	442	026508281796	3
6145BL	347.15	345	026508290107	3	6370BN	112.25	442	026508266687	12
6150	194.80	345	026508272077	3	6370EPBL	117.70	442	026508325520	12
6150BN	263.00	345	026508290088	3	6370BL	123.60	442	026508325513	12
6150BL	282.50	345	026508290071	3	6371EP	69.85	442	026508281802	12
6170	306.60	316	026508351147	3	6371	73.35	442	026508266625	12
6170BN	398.60	316	026508351178	3	6371EPBN	106.95	442	026508281819	12
6170BL	413.95	316	026508351161	3	6371BN	112.25	442	026508266649	12
6172	220.75	316	026508261163	3	6371EPBL	117.70	442	026508342305	12
6172BN	298.00	316	026508261170	3	6371EPORB	117.70	442	026508281826	12
6172BL	309.05	316	026508325506	3	6371BL	123.60	442	026508342299	12
6190	363.60	250	026508244913	3	6371ORB	123.60	442	026508266670	12
6190BN	481.25	250	026508249567	3	6399	124.80	442	026508174722	12
6190BL	516.90	250	026508274989	3	6399EP	124.80	442	026508208762	12
6190BG	527.20	250	026508284674	3	6399EP15	124.80	442	026508274682	12
6191	353.85	250	026508249598	3	6399EP15BN	181.20	442	026508376324	12
6191BN	468.30	250	026508249604	3	6399BG	194.75	442	026508285954	12
6191BL	485.65	250	026508274996	3	6399BN	194.75	442	026508174739	12
6191BG	513.05	250	026508285930	3	6399EP15BG	194.75	442	026508376317	12
6192	538.25	250	026508249611	3	6399EPBG	194.75	442	026508285961	12
6192BN	699.75	250	026508249628	3	6399EPBN	194.75	442	026508208779	12
6192BL	726.65	250	026508370872	3	6399BL	214.35	442	026508275009	12
6192BG	780.45	250	026508285947	3	6399EP15BL	214.35	442	026508275016	12
6198	363.60	250	-	3	6399EPBL	214.35	442	026508275023	12
6198BN	481.25	250	-	3	6400	306.60	332	026508195369	3
6198BL	516.90	250	-	3	6400BN	398.60	332	026508195376	3
6221	348.95	286	026508335932	3	6400ORB	429.25	332	026508195383	3
6221BN	461.85	286	026508335963	3	6401	371.65	273	026508275337	3
6221BL	496.05	286	026508335956	3	6401BN	483.15	273	026508275344	3
6221BG	505.95	286	026508335949	3	6401BL	501.70	273	026508371350	3
6221EW	627.70	157	026508337790	3	6401NL	520.30	273	026508301234	3
6221EWBN	847.40	157	026508337820	3	6401ORB	520.30	273	026508275351	3
6221EWBG	910.15	157	026508337806	3	6402	358.30	273	026508275153	3
6221EWBL	910.15	157	026508337813	3	6402BN	465.75	273	026508275160	3
6260	413.95	100	026508337530	3	6402BL	483.65	273	026508371343	3
6260SRS	517.45	100	026508337561	3	6402NL	501.60	273	026508301241	3
6260BL	538.15	100	026508337547	3	6402ORB	501.60	273	026508275177	3

Wholesale

Listed in numerical order

MODEL NUMBER	LIST PRICE	PAGE NO.	UNIVERSAL PRODUCT CODE	CASE QTY	MODEL NUMBER	LIST PRICE	PAGE NO.	UNIVERSAL PRODUCT CODE	CASE QTY
6410	220.75	332	026508153109	6	7425SRS	221.40	94	026508274873	6
6410BN	298.00	332	026508153116	6	7430	222.85	94	026508052853	6
6410ORB	320.10	332	026508153123	6	7430SRS	278.60	94	026508274880	6
6504	363.60	228	026508364215	3	7434	222.85	94	026508053034	6
6504BN	454.50	228	026508364246	3	7437	227.65	94	026508053126	6
6504BL	490.85	228	026508364239	3	7545C	448.70	92	026508138816	3
6504BG	527.20	228	026508364222	3	7545SRS	560.85	92	026508242964	3
6512EP15	134.65	441	026508378045	12	7545ORB	628.20	92	026508164907	3
6512EP	137.35	441	026508290408	12	7565	573.40	84	026508240045	3
6512EP15BN	216.35	441	026508378069	12	7565SRS	716.70	84	026508240052	3
6512EPBN	220.70	441	026508290385	12	7565EWC	741.05	69	026508342794	3
6512EP15BL	238.10	441	026508378052	12	7565BL	745.40	84	026508274736	3
6512EPBL	242.85	441	026508290392	12	7565BG	831.40	84	026508283868	3
6600	306.60	323	026508195390	3	7565BLS	831.40	84	026508294536	3
6600BN	398.60	323	026508195406	3	7565EVC	906.05	66	026508303665	3
6600ORB	429.25	323	026508195413	3	7565EWSRS	926.35	69	026508342800	3
6610	220.75	323	026508162057	6	7565EWBL	963.35	69	026508303696	3
6610BN	298.00	323	026508160992	6	7565EVSRS	996.65	66	026508303672	3
6610ORB	320.10	323	026508161005	6	7565EVBL	1042.00	66	026508303641	3
6702	221.75	354	026508271186	3	7565EWBG	1074.50	69	026508303689	3
6702BN	288.30	354	026508290125	3	7565EWBLS	1074.50	69	026508303702	3
6702BL	310.50	354	026508290118	3	7565EVBG	1087.25	66	026508303634	3
6710	280.00	341	026508273074	3	7565EVBL	1087.25	66	026508303658	3
6802	220.75	310	026508264386	3	7585C	262.80	93	026508270318	3
6802BN	298.00	310	026508264393	3	7585SRS	328.50	93	026508270325	3
6802BL	309.05	310	026508336977	3	7594C	471.85	88	026508205037	3
6802ORB	320.10	310	026508264409	3	7594SRS	589.80	88	026508231982	3
6803	306.60	310	026508351185	3	7594BL	613.40	88	026508228388	3
6803BN	398.60	310	026508351208	3	7594EWC	631.30	71	026508279021	3
6803BL	413.95	310	026508351192	3	7594ORB	660.60	88	026508209806	3
6803ORB	429.25	310	026508351154	3	7594EWSRS	789.10	71	026508279045	3
6900	363.60	263	026508235096	3	7594EVC	804.35	67	026508303726	3
6900BL	516.90	263	026508301258	3	7594EWBL	820.65	71	026508289914	3
6901	346.80	296	026508230169	3	7594EWORD	883.80	71	026508279038	3
6901BN	459.05	296	026508230176	3	7594EVSRS	884.80	67	026508303740	3
6901BL	476.05	296	026508372197	3	7594EVBL	925.05	67	026508303719	3
6901NL	485.50	296	026508301265	3	7594EVORB	965.25	67	026508303733	3
6901ORB	493.05	296	026508230183	3	7622	602.10	81	026508352328	3
6901BG	502.85	296	026508284629	3	7622SRS	752.60	81	026508352434	3
6903	348.95	296	026508230190	3	7622EWC	766.30	69	026508352410	3
6903BN	461.85	296	026508230206	3	7622BL	782.70	81	026508352342	3
6903BL	478.95	296	026508372180	3	7622BG	873.00	81	026508352335	3
6903NL	488.50	296	026508297582	3	7622EVC	922.80	65	026508382912	3
6903ORB	496.05	296	026508230213	3	7622EVC	930.55	66	026508352373	3
6903BG	505.95	296	026508284636	3	7622EWSRS	957.90	69	026508352427	3
7165	531.90	84	026508240021	3	7622EWBL	996.20	69	026508352403	3
7165SRS	664.90	84	026508240038	3	7622EV2SRS	1015.10	65	026508382929	3
7165BL	691.45	84	026508317785	3	7622EVSRS	1023.60	66	026508352380	1
7185C	494.45	87	026508211786	3	7622EV2BL	1061.20	65	026508382905	3
7185SRS	618.05	87	026508242940	3	7622EVBL	1070.15	66	026508352366	3
7185EWC	653.85	70	026508292686	3	7622EV2BG	1107.35	65	026508382899	3
7185ORB	692.20	87	026508211816	3	7622EWBG	1111.15	69	026508352397	3
7185EWSRS	817.35	70	026508292709	3	7622EVBG	1116.65	66	026508352359	3
7185EVC	827.30	67	026508303603	3	7664	377.50	100	026508316450	3
7185EVSRS	910.05	67	026508303627	3	7664SRS	471.90	100	026508316498	3
7185EWORD	915.40	70	026508292693	3	7664BL	490.75	100	026508316467	3
7185EVORB	992.80	67	026508303610	3	7664ORB	528.50	100	026508316481	3
7245C	399.45	90	026508259900	3	7664BG	547.40	100	026508349922	3
7245SRS	499.30	90	026508259924	3	7664BLS	547.40	100	026508316474	3
7245BL	519.25	90	026508337585	3	7770SRS	643.75	87	026508387085	3
7245ORB	559.20	90	026508259917	3	7770BL	669.50	87	026508382936	3
7250C	324.75	90	026508259931	3	7770NL	695.25	87	026508382998	3
7250SRS	405.95	90	026508259955	3	7770BZG	746.75	87	026508382943	3
7250BL	422.20	90	026508337592	3	7770EWSRS	831.25	70	026508387078	3
7250ORB	454.70	90	026508259948	3	7770EWBL	864.50	70	026508387047	3
7255C	377.50	90	026508259962	3	7770EWNL	897.75	70	026508387061	3
7255SRS	471.90	90	026508259986	3	7770EV2SRS	905.50	66	026508382981	3
7255BL	490.75	90	026508337608	3	7770EV2BL	946.65	66	026508382950	3
7255ORB	528.50	90	026508259979	3	7770EWBZG	964.25	70	026508387054	3
7260	460.00	89	026508337615	3	7770EV2BZG	987.80	66	026508382967	3
7260SRS	575.00	89	026508337721	3	7770EV2NL	987.80	66	026508382974	3
7260BL	598.05	89	026508337622	3	7822	850.00	81	26508279311	3
7260EWC	619.45	71	026508337684	3	7822SRS	1062.50	81	26508279328	3
7260ORB	644.05	89	026508337714	3	7822BL	1105.00	81	26508289938	3
7260EWSRS	774.30	71	026508337707	3	7822BG	1232.50	81	26508357798	3
7260EVC	792.30	67	026508337646	3	7825	230.70	93	026508138786	3
7260EWBL	805.30	71	026508337677	3	7825SRS	288.40	93	026508242988	3
7260EWORD	867.20	71	026508337691	3	7840	275.10	93	026508138847	3
7260EVSRS	871.55	67	026508337660	3	7840SRS	343.90	93	026508243008	3
7260EVBL	911.10	67	026508337639	3	7864	419.50	92	026508278444	3
7260EVORB	950.75	67	026508337653	3	7864SRS	524.35	92	026508278468	3
7295SRS	560.85	88	026508267165	3	7864BL	545.30	92	026508278451	3
7365	468.00	84	026508251171	3	7864EWC	578.90	72	026508279052	3
7365SRS	585.05	84	026508251188	3	7864ORB	587.25	92	026508316504	3
7365BL	608.40	84	026508317778	3	7864BG	608.25	92	026508349939	3
7412	24.70	539	034584175373	6	7864BLS	608.25	92	026508294543	3
7423	180.50	94	026508053157	6	7864EWSRS	723.65	72	026508279069	3
7425	177.10	94	026508052938	6	7864EVC	751.10	68	026508303771	3

Wholesale

Listed in numerical order

MODEL NUMBER	LIST PRICE	PAGE NO.	UNIVERSAL PRODUCT CODE	CASE QTY	MODEL NUMBER	LIST PRICE	PAGE NO.	UNIVERSAL PRODUCT CODE	CASE QTY
7864EWBL	752.55	72	026508289921	3	8316	655.60	650	026508205990	3
7864EVSRS	826.15	68	026508303788	3	8316AC	655.60	651	026508213223	3
7864EWBG	839.40	72	026508351093	3	8342	714.95	659	026508078266	1
7864EWBLS	839.40	72	026508294550	3	8342EP15	714.95	659	026508213377	1
7864EVBL	863.75	68	026508303757	3	8343	734.30	657	026508083130	1
7864EVBG	901.25	68	026508350515	3	8346	507.60	660	026508063347	4
7864EVBLS	901.25	68	026508303764	3	8346EP15	507.60	660	026508213384	4
7871	461.45	92	026508316566	3	8349	82.30	668	026508015094	6
7871SRS	576.80	92	026508316603	3	8349EP15	82.30	668	026508213391	6
7871BL	599.90	92	026508316573	3	8349EP17	82.30	668	026508228647	6
7882	458.45	91	026508279311	3	8349EP15CBN	119.85	668	026508237045	6
7882SRS	573.10	91	026508279328	3	8349EP17CBN	119.85	668	026508237052	6
7882BL	596.00	91	026508289938	3	8360	251.00	666	026508086810	6
7882EWC	617.85	71	026508350539	3	8370HD	143.85	670	026508228470	6
7882EWSRS	772.35	71	026508350546	3	8370	204.05	664	026508013960	12
7882EWBL	803.25	71	026508350522	3	8371HD	173.10	670	026508228487	6
7906	168.15	94	026508003398	6	8372HD	173.10	670	026508228494	6
7907	211.55	94	026508030318	6	8373HD	173.10	670	026508228500	6
8103	188.45	629	026508162309	6	8374HD	186.60	670	026508228517	6
8113	279.20	629	026508162279	6	8375HD	173.10	670	026508239803	6
8116	345.15	629	026508162316	6	8375	229.90	663	026508040423	12
8119	327.30	628	026508162330	6	8375EP15	229.90	663	026508213407	12
8124	277.40	629	026508026168	6	8389EP15	262.55	662	026508213414	6
8126	328.15	628	026508162347	6	8400	193.85	636	026508015063	12
8137	264.25	628	026508185476	6	8413F03	185.15	622	026508234440	3
8138	314.55	628	026508199046	6	8413F05	185.15	622	026508234457	3
8210F05	216.20	623	026508235430	6	8413F12	185.15	622	026508266564	3
8210F12	216.20	623	026508266847	6	8414	220.95	622	026508137123	3
8210SMF05	216.20	623	026508258866	6	8414F12	220.95	622	026508269954	3
8210SMF12	216.20	623	026508266854	6	8414F12BN	287.20	622	026508271773	3
8215F03	239.75	623	026508235447	6	8416	198.85	622	026508017272	3
8215F05	239.75	623	026508235454	6	8416F05	198.85	622	026508234471	3
8215F12	239.75	623	026508266946	6	8417F05	255.75	621	026508234495	6
8215SMF12	239.75	623	026508266830	6	8417F12	255.75	621	026508266571	6
8220F05	338.60	622	026508235508	3	8419F05	290.50	621	026508227848	6
8225	351.60	625	026508162439	3	8419F12	290.50	621	026508266588	6
8225SMF15	351.60	625	026508238684	3	8420	224.95	636	026508015070	12
8226	271.65	625	026508155431	6	8422	203.35	636	026508232125	12
8227	330.20	625	026508162255	3	8422F05	203.35	636	026508232149	12
8228F05	360.00	622	026508235522	3	8425	219.05	636	026508015087	12
8228F12	360.00	622	026508266823	3	8430	151.55	636	026508066454	12
8229	293.15	625	026508162262	6	8430F05	151.55	636	026508232156	12
8230	225.00	629	026508172179	3	8430CBN	197.05	636	026508235348	12
8242	378.75	626	026508185483	3	8432	186.55	636	026508066461	12
8244	400.05	626	026508185490	3	8432F05	186.55	636	026508264706	12
8248	344.35	625	026508181089	3	8434	179.85	637	026508066478	12
8248SMF12	344.35	625	026508267073	3	8437	196.25	637	026508232163	12
8270	257.15	624	026508154618	6	8437CBN	255.15	637	026508235355	12
8276	230.80	624	026508167717	6	8439	161.35	637	026508232170	12
8277	233.90	628	026508199060	6	8439F05	161.35	637	026508232675	12
8278	270.95	624	026508167809	6	8551	644.95	645	026508249901	6
8278SM	270.95	624	026508238714	6	8551AC	663.95	645	026508249918	6
8278SMF12	270.95	624	026508267080	6	8552	719.95	645	026508249925	6
8279SM	288.30	624	026508238738	6	8552AC	719.95	645	026508249932	6
8279SMF12	288.30	624	026508267097	6	8553	644.95	645	026508249949	6
8279	293.20	624	026508167816	6	8553AC	663.95	646	026508249956	6
8280	260.40	626	026508154632	6	8553BN	806.20	645	026508343722	6
8285	281.75	626	026508161203	6	8553ACBN	829.95	646	026508344606	6
8287	324.55	626	026508162231	6	8553BL	870.70	645	026508343715	6
8289	345.80	626	026508162248	6	8553ACBL	896.35	646	026508344590	6
8290EP15	125.10	669	026508213360	12	8554	719.95	646	026508249963	6
8290	130.15	669	026508154069	12	8554AC	719.95	646	026508249970	6
8292	135.85	669	026508172186	12	8554ACBN	899.95	646	026508344620	6
8310MR128	164.35	654	026508236550	6	8554BN	899.95	646	026508343746	6
8310M128	204.25	654	026508236529	3	8554ACBL	971.95	646	026508344613	6
8310M16	204.25	654	026508236536	3	8554BL	971.95	646	026508343739	6
8310M35	204.25	654	026508236543	3	8558	539.15	642	026508271995	3
8310R16	548.60	651	026508160329	3	8558BN	673.95	642	026508343760	3
8310SR128	548.60	651	026508265178	3	8558BL	727.85	642	026508343753	3
8310SR35	548.60	651	026508265192	3	8559	615.25	642	026508271483	6
8310RDF16	575.90	651	026508205983	3	8559BN	769.05	642	026508343777	6
8310	655.60	650	026508006412	3	8559BL	830.60	642	026508341599	6
8310AC16	655.60	650	026508167649	3	8560	539.15	642	026508272008	3
8310S35	655.60	650	026508265123	3	8560BN	673.95	642	026508343791	3
8310ACDF16	688.25	650	026508205969	3	8560BL	727.85	642	026508343784	1
8310DF16	688.25	650	026508205976	3	8562	1117.10	643	026508271490	3
8311	655.60	650	026508199077	3	8565	639.80	643	026508271506	3
8311AC12	655.60	650	026508199091	3	8701	159.85	627	026508129739	6
8312M0125	204.25	654	026508236574	3	8707	190.45	627	026508206515	6
8312M05	204.25	654	026508236581	3	8713	479.65	627	026508020951	6
8312M10	204.25	654	026508236598	3	8716	33.65	537	034584017871	6
8312R10	548.60	651	026508160305	3	8717	282.25	627	026508237649	6
8312SR05	548.60	651	026508265260	3	8718	34.90	537	034584178251	6
8312SR125	548.60	651	026508265284	3	8724	36.05	537	034584175465	6
8312	655.60	650	026508152225	3	8730	40.70	537	034584175472	6
8312AC10	655.60	651	026508167656	3	8732	42.80	537	034584175489	6
8315	655.60	650	026508199084	3	8736	47.65	537	034584175496	6
8315AC05	655.60	651	026508199107	3	8742	51.55	537	034584175502	6

Wholesale

Listed in numerical order

SUGGESTED LIST PRICES

MODEL NUMBER	LIST PRICE	PAGE NO.	UNIVERSAL PRODUCT CODE	CASE QTY	MODEL NUMBER	LIST PRICE	PAGE NO.	UNIVERSAL PRODUCT CODE	CASE QTY
8748	56.65	537	034584175519	6	15440	452.80	647	026508245699	2
8780	129.50	639	026508021859	6	15856	65.50	669	026508015186	12
8792	295.60	639	026508125717	6	15856CBN	95.40	669	026508239858	12
8798	207.60	639	026508003930	6	20001	38.55	443	026508255377	3
8799	270.60	639	026508013779	6	20200	58.30	549	026508202005	18
8800	179.90	638	026508007778	6	22036	22.10	133	026508017593	24
8800F05	179.90	638	026508235317	6	22037	19.35	133	026508008652	40
8810	206.25	638	026508007785	6	22174	10.00	133	026508038314	30
8820	212.50	638	026508007792	6	22175	5.05	133	026508036006	1000
8884	194.70	633	026508093238	6	22650	14.55	133	26508104385	1
8886	358.90	633	026508093245	6	22681	5.50	133	026508032336	1
8889	459.40	633	026508093252	6	22682	6.55	133	026508032374	1
8894	221.10	633	026508220672	6	22684	4.55	133	026508032299	1
8912	32.25	538	034584175533	6	22897	1.15	133	026508038307	1
8915	132.25	638	026508094143	12	23026	44.10	443	026508224281	4
8917	155.90	638	026508030325	12	23418A	1.85	506	034584100122	50
8922	278.75	638	026508039175	6	23418SS	3.40	507	034584100016	50
8924	298.30	638	026508039205	6	23424A	2.30	506	034584100146	50
8938	179.35	640	026508003954	6	23424SS	4.55	507	034584100023	50
8942	58.10	538	034584175595	6	23430SS	5.90	507	034584100030	50
8948	176.95	640	026508061695	6	26100EP	69.80	451	026508266540	2
8957	138.15	640	026508030264	12	26100EPSRN	85.35	451	026508266557	2
8994	113.50	538	034584015044	3	26100EPBL	91.95	451	026508329276	2
8996	121.00	538	034584015051	3	52016F05	21.35	648	026508236284	100
9000	165.40	469	026508081112	6	52016F10	21.35	648	026508228708	24
9001	113.00	556	026508094709	6	52016	23.10	554	026508165065	24
9025	1912.45	273	026508298442	1	52100	97.45	633	026508207635	24
9025BN	2581.80	273	026508298459	1	52120	180.85	623	026508207048	12
9025NL	2581.80	273	026508298466	1	52120	180.85	623	026508207048	12
9025BL	2677.45	273	026508372135	1	52124GBM25	259.00	666	026508234112	3
9025ORB	2840.05	273	026508298473	1	52224GBP25	229.70	667	026508227008	3
9126	559.05	86	026508335666	3	52224GBM15	264.90	667	026508226964	3
9126SRS	698.80	86	026508335741	3	52224GBM17	264.90	667	026508226971	3
9126EWC	723.30	70	026508335727	2	52224GBM25	264.90	667	026508226995	3
9126BL	726.75	86	026508335673	3	52224GBM15CBN	542.95	667	026508236970	3
9126NL	754.70	86	026508336748	3	52236GBM15	288.45	667	026508227015	3
9126EV2C	880.15	65	026508387108	3	52236GBM17	288.45	667	026508227022	3
9126EVC	887.50	67	026508335697	2	52236GBM25	288.45	667	026508227046	3
9126EWSRS	904.10	70	026508335734	2	52236GBM15CBN	590.10	667	026508237007	3
9126EWBL	940.30	70	026508335710	2	52652	33.00	631	026508036198	24
9126EV2SRS	968.15	65	026508387122	3	52653	34.45	631	026508029336	24
9126EVSRS	976.30	67	026508335703	2	52655	20.75	631	026508029510	24
9126EWNL	976.45	70	026508336731	2	52703	72.65	669	026508026083	12
9126EV2BL	1012.15	65	026508387092	3	52710	300.65	667	026508063361	6
9126EVBL	1020.65	67	026508335680	2	52710EP15	300.65	667	026508213346	6
9126EV2NL	1056.15	65	026508387115	3	52710CBN	598.40	667	026508237106	6
9126EVNL	1065.00	67	026508336724	2	52710EP15CBN	598.40	667	026508237144	6
9263EP15	79.35	668	026508255438	12	52711	54.50	669	026508228630	12
9265	321.95	477	026508255155	6	52714	54.50	669	026508249871	12
9349EP15	116.80	668	026508255452	6	52716EP15	76.45	668	026508213353	20
9417F05	283.00	621	026508257296	3	52740EP17	300.05	667	026508228524	6
9417F12	283.00	621	026508266977	3	52748EP15	219.35	667	026508234754	6
9419F05	314.45	621	026508255483	3	62300	148.05	473	026508025857	12
9419F12	314.45	621	026508266984	3	62320	148.05	473	026508009208	12
9480	175.15	635	026508255490	3	62330	196.25	475	026508102312	12
9482	194.60	635	026508255506	3	62340	164.25	474	026508102305	12
9501	51.35	108	26508153963	18	62345	148.05	475	026508252512	12
9601	68.40	108	026508153918	18	62360	180.00	474	026508102275	12
9700	233.95	469	026508230008	3	62360PF	200.50	476	026508337349	12
9792	433.35	470	026508229637	6	62365	148.05	474	026508227251	12
9793	443.50	470	026508229644	6	62365PF	168.65	476	026508337356	12
10066	29.70	559	026508037836	125	62370	180.00	473	026508009215	12
10066BN	41.90	559	026508117088	20	62380	148.05	474	026508102268	12
10066NL	42.60	559	026508146309	20	62380PF	168.65	476	026508337370	12
10066WR	46.30	559	026508117095	20	62385	180.00	474	026508227268	12
10154	27.00	444	026508050903	50	62385PF	200.50	476	026508337387	12
10154BRB	37.05	444	026508210628	20	62390	180.00	474	026508067055	12
10154BL	45.75	444	026508317440	30	62700	134.85	477	026508009277	12
10154BG	48.45	444	026508285213	30	62700	134.85	477	026508009277	12
10154BN	48.45	444	026508105344	50	62720	134.85	477	026508009284	12
10154NL	48.45	444	026508104248	1	62720	134.85	477	026508009284	12
10154ORB	53.30	444	026508100325	50	64601	154.85	602	026508040751	12
10399	43.30	558	026508033197	36	64621	190.30	602	026508002896	12
10510	29.70	559	026508037829	30	64900	121.00	605	026508040775	12
10709	15.15	563	026508027226	84	64919	167.85	605	026508017265	12
10709BC	21.15	563	026508172247	20	64920	167.85	605	026508002889	12
10709BG	47.30	563	026508291832	20	64922	121.00	605	026508147955	12
10709BN	47.30	563	026508172254	20	64925	167.85	605	026508134542	12
10709NL	51.95	563	026508204900	20	66172	199.00	604	026508261194	6
10709BL	52.05	563	026508326732	20	66410	199.00	604	026508152485	6
10709ORB	52.05	563	026508172261	20	66610	199.00	604	026508162064	6
10709WR	52.05	563	026508172308	50	66802	199.00	604	026508264379	6
10790	136.80	563	026508004166	12	67315C	319.25	93	026508069257	6
13382	12.95	553	026508028834	300	67315C	319.25	93	026508069257	6
14272	7.70	552	026508031087	150	67315SRS	399.05	93	026508242933	6
14292	256.00	562	026508004180	-	67315SRS	399.05	93	026508242933	6
14526	15.25	563	026508028308	50	67425	173.60	601	026508052983	6
14891	21.15	550	026508148914	60	67430	218.25	601	026508052884	6

Wholesale

Listed in numerical order

MODEL NUMBER	LIST PRICE	PAGE NO.	UNIVERSAL PRODUCT CODE	CASE QTY	MODEL NUMBER	LIST PRICE	PAGE NO.	UNIVERSAL PRODUCT CODE	CASE QTY
67434	218.25	601	026508053041	6	104549	49.40	655	026508245385	20
67545C	418.45	600	026508209165	3	104550	54.95	655	026508245392	20
67840	263.15	600	026508138861	6	104551	59.00	655	026508245408	20
69000	146.80	605	026508045114	6	104552	65.85	655	026508245415	20
74998	100.25	101	026508028070	12	104553	70.00	655	026508245422	20
75651	573.40	84	026508378106	3	104554	75.45	655	026508245439	20
75651SRS	716.70	84	026508378120	3	104555	132.20	655	026508246535	20
75651BL	745.40	84	026508378113	3	104556	132.20	655	026508244074	20
90530	68.45	466	026508905302	10	104557	23.10	655	026508244081	20
91751	13.25	553	026508023655	1000	104560	51.35	655	026508247891	12
94514	13.75	553	026508021316	150	104561	72.45	655	026508246559	20
96107	19.55	563	026508961070	18	104563	97.45	655	026508245446	20
96365	10.10	548	026508963654	36	104564	97.45	655	026508246573	20
96497	26.25	563	026508004708	12	104565	97.45	655	026508245453	20
96778	10.85	548	026508967782	36	104566	97.45	655	026508245460	20
96782	33.70	549	026508967829	18	104567	97.45	655	026508245477	20
96790	34.95	553	026508009048	150	104568	97.45	655	026508245484	20
96791	33.70	553	026508009055	150	104569	29.30	655	026508245491	20
96797	34.95	553	026508009062	150	104570	21.65	655	026508245507	12
96858	62.60	558	026508014486	25	104571	28.90	655	026508246580	20
96868	76.80	558	026508014509	-	104572	7.50	655	026508245514	20
96914	6.90	551	026508030998	500	104573	27.95	655	026508246801	30
96945	43.80	558	026508017609	100	104574	61.10	655	026508246818	15
96945BG	62.70	558	026508293164	9	104575	54.80	655	026508248010	6
96945BN	62.70	558	026508120361	9	104577	13.15	655	026508246825	30
96945WR	68.90	558	026508118337	9	104578	55.20	655	026508244098	12
96955	53.25	558	026508017616	100	104579	59.90	655	026508244104	12
96987	11.55	559	026508028001	250	104580	55.30	655	026508244111	12
96987BN	15.95	559	026508118344	20	104581	38.65	655	026508244128	20
96987BG	16.25	559	026508293171	12	104582	35.15	655	026508246832	20
96987NL	16.35	559	026508147139	20	104583	30.30	655	026508246856	20
96987WR	17.85	559	026508118351	20	104584	89.95	655	026508247877	12
96988	20.80	551	026508017586	100	104585	141.75	655	026508247884	-
97557	68.85	549	026508975572	36	104587	172.75	652	026508248614	6
98026	39.10	549	026508042472	12	104588	32.50	655	026508246863	20
98032	13.25	549	026508042533	18	104589	52.25	655	026508246870	20
98039	33.70	549	026508042601	18	104590	31.05	655	026508247426	33
98040	17.90	548	026508043400	18	104591	31.05	655	026508247433	33
98085	7.25	563	026508041901	225	104592	31.05	655	026508247440	33
99550	34.95	633	026508207659	12	104593	31.05	655	026508247457	33
99551	34.95	633	026508220689	12	104594	31.05	655	026508247464	33
99556	38.25	645	026508252130	20	104595	31.05	655	026508247471	33
99557	38.25	645	026508252147	20	104597	20.75	655	026508246849	40
99557BN	47.85	645	026508343975	20	104598	30.60	655	026508251843	20
99557BL	52.60	645	026508343968	20	104599	54.95	655	026508251850	20
99558	49.15	645	026508252154	20	104600	58.95	655	026508252536	12
99558BN	61.45	645	026508343869	20	104609	12.00	655	026508251867	20
99558BL	67.55	645	026508343708	20	104617	35.00	652	026508273999	12
99559	38.25	621	026508258859	20	104618	82.80	652	026508274002	12
99596	44.20	563	026508020920	-	104619	82.80	652	026508274019	12
99915	0.25	551	026508045541	2500	104620	82.80	652	026508274026	12
100224	23.70	562	026508092262	45	104621	82.80	652	026508274033	12
100679	70.05	562	026508057704	12	104622	82.80	652	026508274040	12
100686	54.65	669	026508057711	60	104623	82.80	652	026508274057	12
100686CBN	78.55	669	026508246436	60	104624	82.80	652	026508274064	12
100710	24.95	549	026508059524	18	104625	39.00	652	026508274071	12
100817	38.00	557	026508124185	100	104626	40.05	652	026508274088	12
100818	40.70	557	026508124192	20	104627	37.30	652	026508274095	12
101100	37.10	559	026508096550	100	104628	110.20	652	026508274101	12
101205	12.95	549	026508060575	18	104630	113.20	647	026508273609	12
101663BG	41.25	466	026508285411	12	104631	37.40	652	026508274118	12
101663BN	41.25	466	026508120897	12	104633	133.35	652	026508274125	12
101663WR	45.45	466	026508120927	12	104634	26.35	652	026508274132	20
101663ORB	46.95	466	026508100349	12	105895	31.40	111	026508288542	6
101664BG	51.25	466	026508285428	12	105895NL	41.90	111	026508294338	6
101664BN	51.25	466	026508120903	12	105895BG	42.45	111	026508283608	6
101664WR	56.50	466	026508120934	12	105895BL	43.00	111	026508098011	6
101664ORB	58.25	466	026508100363	12	105895SRS	43.35	111	026508214138	6
102763BG	51.25	466	026508285435	12	105895BLS	44.20	111	026508294499	6
102763BN	51.25	466	026508120910	12	105895ORB	45.30	111	026508144336	6
102763WR	56.50	466	026508120941	12	106378	22.95	558	026508085868	250
102763ORB	58.25	466	026508100387	12	106479	5.55	559	026508085899	300
104414	59.00	669	026508081525	-	114348	117.65	458	026508118085	12
104421	56.45	548	026508074589	36	114348NL	136.85	458	026508146354	12
104451	185.95	646	026508199282	12	114348BG	170.60	458	026508350980	12
104463	185.95	470	026508324257	12	114348BN	170.60	458	026508118115	12
104464	185.95	470	026508324240	12	114348ORB	187.55	458	026508101766	12
104465	185.95	470	026508204368	12	114348WR	187.55	458	026508118122	12
104466	185.95	470	026508267103	12	116651	18.60	444	026508128572	6
104540	43.95	655	026508245293	20	116651BG	31.50	444	026508285572	6
104541	38.45	655	026508245309	20	116651BN	31.50	444	026508128589	6
104542	53.50	655	026508245316	20	116651NL	31.50	444	026508147146	6
104543	59.00	655	026508245323	20	116651ORB	40.95	444	026508147191	6
104544	65.85	655	026508245330	20	116651WR	40.95	444	026508128596	6
104545	72.70	655	026508245347	20	116711	8.35	554	026508135686	500
104546	38.45	655	026508245354	20	118305	15.00	552	026508130148	100
104547	42.60	655	026508245361	20	123815	36.65	444	026508140437	12
104548	45.30	655	026508245378	20	123815BG	61.10	444	026508285138	12

Wholesale

Listed in numerical order

MODEL NUMBER	LIST PRICE	PAGE NO.	UNIVERSAL PRODUCT CODE	CASE QTY	MODEL NUMBER	LIST PRICE	PAGE NO.	UNIVERSAL PRODUCT CODE	CASE QTY
123815BN	61.10	444	026508152881	12	148479	33.15	559	026508202975	25
123815NL	61.10	444	026508301159	12	148479BN	62.00	559	026508202982	25
123815BL	67.20	444	026508279410	12	148479WR	62.40	559	026508202999	25
123815ORB	67.20	444	026508164983	12	150257	46.95	551	026508205693	50
123816	62.00	563	026508140444	12	150313	10.80	552	026508205563	12
123816	62.00	563	026508140444	12	150627	34.95	553	026508213834	50
123816BN	86.85	563	026508166994	12	151380	95.35	444	026508207413	6
123816BN	86.85	563	026508166994	12	151380BG	162.10	444	026508323687	6
123816BL	95.90	563	026508356722	12	151380BN	162.10	444	026508207420	6
123816BL	95.90	563	026508356722	12	151380BL	178.20	444	026508323694	6
123816ORB	95.90	563	026508167007	12	151380ORB	178.20	444	026508207437	6
128284	37.00	457	026508156568	12	154296	371.80	455	026508218266	6
129102	43.35	558	026508173114	12	154296BG	387.00	455	026508291870	6
129102BG	63.90	558	026508293195	12	154296BN	408.80	455	026508218273	6
129102BN	63.90	558	026508173121	12	154296BL	449.70	455	026508328088	6
129102NL	63.90	558	026508173176	12	154296NL	449.70	455	026508231029	6
129102ORB	70.35	558	026508173152	12	154296ORB	449.70	455	026508218280	6
129102WR	70.35	558	026508173145	12	154305	182.55	452	026508218488	6
130153	43.10	558	026508158500	12	154305BG	250.50	452	026508291887	6
130153BG	63.80	558	026508297650	12	154305BN	264.70	452	026508218495	6
130153BN	66.15	558	026508158517	12	154305BL	281.05	452	026508312643	6
130153NL	72.20	558	026508157244	12	154305NL	281.05	452	026508231098	6
130153ORB	72.75	558	026508158524	12	154305ORB	281.05	452	026508218501	6
130153WR	72.75	558	026508158531	12	155656	42.75	558	026508219867	12
131553	88.20	563	026508157862	12	155694	32.70	458	026508221372	12
131553BN	120.30	563	026508200742	12	155694BG	47.30	458	026508337769	12
131553NL	120.30	563	026508230916	12	155694BN	47.30	458	026508221389	12
131553ORB	130.75	563	026508200759	12	155694BL	52.00	458	026508337776	12
131553BG	132.15	563	026508286616	12	155694ORB	52.00	458	026508227565	12
131553BL	135.35	563	026508305096	12	155746	264.00	455	026508221396	6
135167	59.85	559	026508171677	9	155746BG	364.40	455	026508292853	6
135167BN	109.20	559	026508171318	9	155746BN	382.65	455	026508221402	6
135167WR	120.30	559	026508171325	9	155746ORB	420.95	455	026508227572	6
137114	49.10	557	026508173275	20	155747	84.65	453	026508221419	6
137347	46.15	558	026508173565	9	155747BG	111.30	453	026508293584	6
137347NL	54.85	558	026508173596	9	155747BN	122.80	453	026508221426	6
137347P	73.60	558	026508173602	9	155747ORB	135.15	453	026508227589	6
137347BG	75.15	558	026508293287	9	155747NL	156.80	453	026508312674	6
137347BN	75.15	558	026508173589	9	155748BG	49.60	456	026508294314	8
137347WR	82.60	558	026508173619	9	155748BN	49.60	456	026508295007	8
137401	16.00	555	026508180310	12	155748	50.60	456	026508221433	8
137488	11.05	446	026508178454	200	155748BN	73.35	456	026508221440	8
137488BG	28.75	446	026508285220	1	155748BL	108.10	456	026508280775	8
137488BN	28.75	446	026508178461	200	155748BR	108.10	456	026508280782	8
137488NL	28.75	446	026508309698	48	155891	84.65	453	026508223178	24
137488BL	30.35	446	026508277409	24	155891BG	117.65	453	026508293591	6
140676	6.65	551	026508184356	96	155891BN	117.65	453	026508223185	24
140680	18.40	466	026508184431	12	155891BL	135.15	453	026508278185	24
140690	20.75	466	026508184448	12	157276EP15	84.65	453	026508241714	6
140715	12.95	470	026508187517	200	159060	22.65	111	026508231425	6
140780	78.35	160	026508165720	12	159060	22.65	111	026508231425	6
140780	78.35	160	026508165720	12	160042	130.20	452	026508228166	6
140780BG	109.20	183	026508286623	12	160042BN	188.95	452	026508228173	6
140780BG	109.20	183	026508286623	12	160042ORB	207.85	452	026508228180	6
140780BN	109.20	183	026508165737	12	161919	26.90	157	026508233283	20
140780BN	109.20	183	026508165737	12	161919BG	38.10	157	026508292891	20
140780NL	109.20	183	026508230923	12	161919BN	38.10	157	026508233290	20
140780NL	109.20	183	026508230923	12	161919NL	38.10	157	026508309704	20
140780BL	123.30	160	026508299371	12	161951	124.95	445	026508233559	12
140780BL	123.30	160	026508299371	12	161951BG	169.00	445	026508285237	12
140780ORB	131.30	160	026508165744	12	161951BN	169.00	445	026508233610	12
140780ORB	131.30	160	026508165744	12	161951BL	169.00	445	026508299449	12
141002	57.75	65	026508187296	6	161951BL	185.90	445	026508299432	12
141002NL	62.85	65	026508265765	6	161951ORB	185.90	445	026508233627	12
141002BG	66.25	65	026508283677	6	161955	103.45	460	026508233726	6
141002BL	66.25	65	026508229019	6	161955BG	160.30	460	026508285589	6
141002SRS	66.25	65	026508209370	6	161955BN	160.30	460	026508233733	6
141002BLS	72.90	66	026508314159	6	161955NL	160.30	460	026508299456	6
141002ORB	73.05	99	026508211410	6	161955BL	165.60	460	026508371312	6
142538	7.30	466	026508188668	180	161955ORB	176.35	460	026508233740	6
143326	14.85	555	026508199695	100	163847	12.55	555	026508238264	100
143530	10.80	556	026508193167	144	164745	14.95	446	026508239247	20
145058	21.45	560	026508190432	50	164745BG	21.85	446	026508285244	20
145665	5.85	557	026508193044	120	164745BN	21.85	446	026508239254	20
147204	31.05	205	026508204450	12	164745NL	21.85	446	026508299463	20
147204BN	75.20	205	026508205136	12	164745ORB	28.35	446	026508239261	20
147204BL	82.70	205	026508375136	12	164927	98.65	452	026508241585	6
147206	110.20	559	026508200544	12	164927BG	120.35	452	026508351574	6
147212	41.40	559	026508200605	12	164927NL	135.15	452	026508299470	6
147556	163.35	205	026508204696	6	164927BN	142.90	452	026508241592	6
147556BN	239.55	205	026508205211	6	164927BL	144.60	452	026508351581	6
147556BL	263.50	205	026508375068	6	164927ORB	161.20	452	026508241608	6
147572	15.90	446	026508204849	12	164928	101.10	452	026508241615	6
147572BG	23.20	446	026508350966	12	164928BN	146.50	452	026508241622	6
147572BN	23.20	446	026508205327	12	164928BL	161.20	452	026508290194	6
147572BL	27.65	446	026508317457	12	164928ORB	161.20	452	026508241639	6
147913	179.10	452	026508200513	6	164929	84.65	453	026508241646	6
147913BN	265.20	452	026508200520	6	164929NL	122.50	453	026508271872	6

Wholesale

Listed in numerical order

MODEL NUMBER	LIST PRICE	PAGE NO.	UNIVERSAL PRODUCT CODE	CASE QTY	MODEL NUMBER	LIST PRICE	PAGE NO.	UNIVERSAL PRODUCT CODE	CASE QTY
164929BN	122.80	453	026508241653	6	182422	170.30	648	026508272398	12
164929ORB	135.15	453	026508241660	6	182534	57.45	648	026508273708	6
165006	28.45	263	026508239926	20	182535	154.80	648	026508273715	6
165006BL	58.75	263	026508306482	20	182536	10.95	648	026508273722	20
165018	8.40	555	026508240120	12	182537	170.30	648	026508273739	12
165914	196.85	459	026508242339	6	182538	24.10	648	026508273746	20
165914BN	333.75	459	026508242346	6	182540	58.30	648	026508273760	12
165914BL	367.15	459	026508308103	6	182542	18.70	648	026508273777	20
168665	32.95	556	026508239193	50	182543	18.60	648	026508273784	20
168666	20.90	556	026508244487	50	182544	18.60	648	026508273791	20
169031	159.60	66	026508266199	12	182546	37.45	642	026508273807	12
169031	159.60	66	026508266199	12	182546BN	46.80	642	026508343951	12
169031	159.60	66	026508266199	12	182546BL	51.50	642	026508343692	12
172656	98.00	460	026508251003	6	182547	27.05	648	026508273814	20
172656BG	148.85	460	026508285145	6	184082	11.85	554	026508272497	50
172656BN	155.35	460	026508251010	6	185820	121.85	459	026508276969	6
172656BL	176.30	460	026508274675	6	185820BN	145.40	459	026508276976	6
172657	98.00	460	026508251027	6	185820NL	145.40	459	026508299487	6
172657BG	132.15	460	026508291931	6	185820BL	152.30	459	026508372159	6
172657BN	155.35	460	026508251034	6	185820ORB	154.80	459	026508276983	6
172657BL	192.25	460	026508293379	6	186117	25.75	451	026508284742	6
172666	19.50	250	026508250938	20	186117SRN	31.30	451	026508284759	6
172666BG	24.15	250	026508292006	20	186117BN	39.45	451	026508329238	6
172666BN	24.15	250	026508250945	20	186117BL	41.55	451	026508329221	6
172666BL	34.00	250	026508280942	20	186117ORB	43.45	451	026508329252	6
174055	35.05	648	026508235799	12	186589	9.95	142	026508275221	6
174056	111.40	648	026508235904	12	187054	164.60	451	026508281147	6
174057	30.95	648	026508235911	12	187054BG	196.90	451	026508363218	6
174060	19.60	648	026508235942	12	187054BN	205.15	451	026508281154	6
174061	27.50	648	026508235959	12	187054BL	227.35	451	026508324745	6
174061BN	34.40	648	026508346433	12	187054ORB	227.35	451	026508281161	6
174061BL	37.85	648	026508346426	12	189315	71.95	453	026508282120	6
174062	10.15	648	026508252765	12	189315BN	97.15	453	026508282137	6
174065	55.60	648	026508252772	12	189315BL	106.95	453	026508285459	6
174066	6.45	648	026508252789	12	189315ORB	106.95	453	026508282144	6
174335	220.05	648	026508254394	12	189318	80.10	453	026508282151	6
174336	21.85	648	026508254400	20	189318BN	116.20	453	026508282168	6
174337	21.85	648	026508254417	20	189318SRN	116.20	453	026508282199	6
174337BN	27.30	648	026508343852	20	189318BRB	127.95	453	026508282175	6
174337BL	30.00	648	026508343845	20	189318ORB	127.95	453	026508282182	6
175083	8.40	554	026508252895	200	189575	115.85	452	026508282205	6
175084	8.40	554	026508252901	350	189575BG	170.00	452	026508304815	6
175385	102.75	460	026508257753	6	189575BN	170.00	452	026508282212	6
175385BN	159.55	460	026508257760	6	189575NL	170.00	452	026508304822	6
175385NL	159.55	460	026508257777	6	189575BL	187.05	452	026508337783	6
175385ORB	175.40	460	026508257784	6	191956	96.05	462	026508281178	6
175709	129.75	557	026508254912	12	191956BG	139.20	462	026508285152	6
175916	17.55	647	026508261903	12	191956BN	139.20	462	026508281185	6
175917	17.55	647	026508261910	1	191956NL	139.20	462	026508299494	6
175918	17.55	647	026508261927	12	191956BL	142.35	462	026508371329	6
175921	17.55	647	026508266755	12	191956ORB	153.00	462	026508281192	6
175925	17.55	647	026508266762	12	193371	79.90	463	026508299913	6
175926	17.55	647	026508266779	12	193371BN	123.45	463	026508299920	6
176257	122.50	452	026508254974	6	193371BL	127.90	463	026508372166	6
176257BN	179.60	452	026508254981	6	193371ORB	135.85	463	026508299944	6
177171	119.60	445	026508257876	12	195386	95.35	463	026508281208	6
177171BN	161.70	445	026508257883	12	195386BN	138.35	463	026508281215	6
177171NL	161.70	445	026508257890	12	195386NL	138.35	463	026508281222	6
177171ORB	177.95	445	026508257906	12	195386ORB	152.25	463	026508281239	6
177566	49.05	69	026508259719	6	195827	79.90	463	026508299951	6
177566	49.05	69	026508259719	6	195827BG	123.45	463	026508299968	6
178755	83.30	562	026508259030	8	195827BN	123.45	463	026508299982	6
178755BN	120.75	562	026508259047	8	195827BL	135.85	463	026508299975	6
178755BL	125.15	562	026508378076	8	195957	75.70	453	026508305102	6
178755ORB	128.20	562	026508259054	8	195957BN	109.80	453	026508305119	6
179573	78.30	377	026508274224	6	195957NL	109.80	453	026508305126	6
179573	78.30	377	026508274224	6	195957ORB	120.90	453	026508305133	6
179791	124.20	460	026508264171	6	195958	80.10	453	026508305140	6
179791BN	158.00	460	026508264188	6	195958BN	116.20	453	026508305157	6
179791BL	173.80	460	026508326855	6	195958NL	116.20	453	026508305164	6
179834	18.20	445	026508263969	20	195958ORB	127.55	453	026508305171	6
179834BL	24.00	445	026508335499	20	198017	101.05	455	026508315163	6
180158	11.30	554	026508266458	20	198017BN	146.45	455	026508315187	6
181040	17.55	647	026508266786	12	198017BL	155.55	455	026508315170	6
181085	11.55	554	026508266366	100	198020	111.25	452	026508315255	6
181148	82.20	642	026508274491	12	198020BN	161.25	452	026508315279	6
181148BN	102.75	642	026508343920	12	198020BL	177.45	452	026508315262	6
181148BL	111.00	642	026508343913	12	198021	111.25	452	026508315286	6
181149	71.10	642	026508274507	12	198021BN	161.25	452	026508315309	6
181149BN	88.90	642	026508343944	12	198021BL	177.45	452	026508315293	6
181149BL	96.00	642	026508343937	12	199785	59.75	63	026508328699	6
182413	63.85	648	026508272305	64	199785	59.75	63	026508328699	6
182414	18.05	648	026508272312	12	199785	59.75	63	026508328699	6
182415	131.70	648	026508272329	24	200755	46.15	557	026508329450	15
182416	108.95	648	026508272336	12	200755BG	75.15	557	026508331255	15
182418	37.50	648	026508272350	12	200755BN	75.15	557	026508331279	15
182420	47.75	648	026508272374	12	200755NL	75.15	557	026508331286	15
182421	69.20	648	026508272381	12	200755BL	82.50	557	026508331262	15

Wholesale

Listed in numerical order

MODEL NUMBER	LIST PRICE	PAGE NO.	UNIVERSAL PRODUCT CODE	CASE QTY	MODEL NUMBER	LIST PRICE	PAGE NO.	UNIVERSAL PRODUCT CODE	CASE QTY
200755ORB	82.50	557	026508375525	15	A501	125.15	454	026508149119	12
200758	33.30	551	026508329481	20	A501BN	156.50	454	026508149300	12
200759	39.75	551	026508329498	20	A501NL	156.50	454	026508149171	12
200760	64.15	557	026508329504	12	A501ORB	172.15	454	026508149256	12
200763	5.85	559	026508329528	12	A501WR	172.15	454	026508149188	12
200779	46.15	557	026508331446	15	A701	62.85	458	026508232941	12
200779BG	75.15	557	026508331453	15	A701BG	90.90	458	026508335970	12
200779BN	75.15	557	026508331477	15	A701BN	90.90	458	026508232958	12
200779NL	75.15	557	026508331484	15	A701BL	100.00	458	026508335987	12
200779BL	82.60	557	026508331460	15	A701ORB	100.00	458	026508232965	12
200779ORB	82.60	557	026508331491	15	A705	57.75	445	026508240816	12
200780	46.15	557	026508331507	15	A705CBN	86.55	445	026508240823	12
200780BN	75.15	557	026508331514	15	A714	57.25	458	026508042847	24
200780BL	82.60	557	026508388952	-	A714ORB	91.30	458	026508181317	12
200781	46.15	557	026508331521	15	A714WR	91.30	458	026508167014	12
200781BG	75.15	557	026508331538	15	A720	96.20	458	026508042892	12
200781BN	75.15	557	026508331545	15	A720BN	130.70	458	026508141984	12
200781NL	75.15	557	026508331552	15	A720BL	143.75	458	026508351291	12
200781ORB	82.60	557	026508331569	15	A720ORB	143.75	458	026508141991	12
200781BL	82.60	557	026508381687	15	A721	86.25	457	026508227725	12
205497	11.25	142	026508357774	12	A721	86.25	457	026508227725	12
210007	60.85	456	026508353714	12	A721BG	121.65	457	026508282496	12
210007BN	84.70	456	026508353721	12	A721BG	121.65	457	026508282496	12
210007SRN	84.70	456	026508353738	12	A721BN	121.65	457	026508227732	12
210007BG	124.90	456	026508353769	12	A721BN	121.65	457	026508227732	12
210007BL	124.90	456	026508353745	12	A721NL	121.65	457	026508301272	12
210007ORB	124.90	456	026508353752	12	A721NL	121.65	457	026508301272	12
210492BN	50.50	558	026508358726	15	A721SRN	121.65	457	026508282465	12
210492NL	50.50	558	026508358733	15	A721SRN	121.65	457	026508282465	12
210492	56.50	558	026508358696	15	A721BRB	123.15	457	026508282489	12
210492BG	63.05	558	026508358702	15	A721BL	133.75	457	026508335994	12
210492BL	72.75	558	026508358719	15	A721BL	133.75	457	026508335994	12
210492ORB	95.35	558	026508358832	15	A721ORB	133.75	457	026508282472	12
210572BL	50.30	558	026508358856	15	A721ORB	133.75	457	026508282472	12
210572	56.50	558	026508358849	15	A723	33.65	669	026508228654	20
210572BN	60.80	558	026508358863	15	A725	67.40	457	026508044551	12
210572NL	60.80	558	026508358870	15	A725	67.40	457	026508044551	12
210572ORB	64.35	558	026508358887	15	A725CBN	89.45	669	026508191224	12
210573	62.20	559	026508358894	15	A725BN	95.45	457	026508121955	12
210573BN	87.10	559	026508358900	15	A725BN	95.45	457	026508121955	12
210573BL	95.35	559	026508388945	-	A725NL	95.45	457	026508079232	12
210574	61.90	559	026508358917	15	A725NL	95.45	457	026508079232	12
210574BG	86.70	559	026508358924	15	A725BG	100.85	457	026508285275	12
210574BN	86.70	559	026508358931	15	A725BG	100.85	457	026508285275	12
210574NL	86.70	559	026508358948	15	A725ORB	104.95	457	026508132166	12
210574ORB	95.35	559	026508358955	15	A725ORB	104.95	457	026508132166	12
210574BL	95.35	559	026508385203	15	A725WR	104.95	457	026508121962	12
213293BG	23.70	557	-	12	A725WR	104.95	457	026508121962	12
215810	158.70	118	26508380390	6	A726	136.95	456	026508073032	12
215812	92.00	118	26508380413	6	A726WR	156.00	456	026508118412	12
215817	158.70	118	26508380451	8	A726BG	244.60	456	026508285367	12
215819	212.00	118	26508380475	8	A726NL	244.60	456	026508079638	24
216721	8.40	554	026508186374	700	A726SRN	244.60	456	026508282458	12
221672	27.50	159	026508224519	12	A726ST	244.60	456	026508079645	12
221672BG	36.50	159	026508293140	12	A726BR	253.45	456	026508181225	12
221672BN	36.50	159	026508224526	12	A735	212.85	455	026508172728	6
221672NL	36.50	159	026508231135	12	A735BG	276.25	455	026508294307	6
221672BL	40.40	159	026508301166	12	A735NL	302.80	455	026508313374	6
221672ORB	40.40	159	026508224533	12	A735BN	308.65	455	026508172735	6
221673	18.60	170	026508224540	12	A735ORB	327.55	455	026508172742	6
221673BG	24.85	170	026508293157	12	A735WR	327.55	455	026508172766	6
221673BN	24.85	170	026508224557	12	A742	230.15	455	026508204078	6
221673NL	24.85	170	026508231142	12	A742BG	295.90	455	026508282441	6
221673BL	27.40	170	026508301173	12	A742NL	315.80	455	026508301289	6
221673ORB	27.40	170	026508224564	12	A742BN	333.90	455	026508205433	6
221772	17.65	161	026508256947	12	A742BL	367.30	455	026508351284	6
221772BN	23.40	161	026508256954	12	A742BRB	367.30	455	026508282434	6
221772BG	24.75	161	026508336878	12	A742ORB	367.30	455	026508282427	6
221772NL	24.75	161	026508336885	12	A750	42.50	457	026508172674	24
221772BL	24.90	161	026508301180	12	A750	42.50	457	026508172674	24
221772ORB	25.75	161	026508288290	12	A755	172.40	457	026508232972	12
226651	57.60	444	026508165751	6	A755BG	250.05	457	026508351376	12
226651BG	111.65	444	026508285596	6	A755BN	250.05	457	026508232989	12
226651BN	111.65	444	026508165782	6	A755BL	275.10	457	026508351369	12
226651NL	111.65	444	026508165799	6	A755ORB	275.10	457	026508232996	12
226651ORB	122.75	444	026508165805	6	A780	161.50	456	026508227138	20
226651WR	122.75	444	026508165829	6	A1717	178.90	232	026508166116	6
262578	22.00	108	026508375044	200	A1717BN	256.35	232	026508166123	6
316711	8.40	554	026508178775	350	A1717ORB	278.55	232	026508199015	6
316721	12.55	555	026508260883	100	ARC-4200	66.75	142	029122010520	60
336651	86.15	444	026508282229	6	ARC-4200-CHSR	87.60	142	026508380819	6
336651BG	167.50	444	026508285169	6	AS-4201-CH	22.45	142	029122010681	100
336651BN	167.50	444	026508282243	6	AS-4201-BL	28.05	142	026508294369	100
336651NL	167.50	444	026508282250	6	AS-4201-BLS	33.90	142	026508294574	100
336651BL	184.05	444	026508282236	6	AS-4201-BRB	33.90	142	026508251706	100
336651ORB	184.05	444	026508282267	6	AS-4201-NL	39.85	142	026508294376	100
416711	8.40	554	026508178782	200	AS-4201-BG	44.85	142	026508292075	100
516711	8.40	554	026508180464	500	AS-4201-SRS	44.85	142	026508380826	24

Wholesale

Listed in numerical order

MODEL NUMBER	LIST PRICE	PAGE NO.	UNIVERSAL PRODUCT CODE	CASE QTY	MODEL NUMBER	LIST PRICE	PAGE NO.	UNIVERSAL PRODUCT CODE	CASE QTY
AT2099	22.00	445	026508065112	12	CL703BN	155.15	458	026508250556	12
AT2099BN	55.90	445	026508105924	12	CL703BL	170.75	458	026508351345	12
AT2099ORB	61.40	445	026508132173	12	CL703BL	170.75	458	026508351345	12
AT2199	10.45	446	026508065136	200	CL703ORB	170.75	458	026508250563	12
AT2199BN	27.55	446	026508130162	200	CL703ORB	170.75	458	026508250563	12
AT2199NL	27.55	446	026508104057	48	CL707	145.35	458	026508250570	12
AT2199BG	29.10	446	026508324271	48	CL707	145.35	458	026508250570	12
AT2199ORB	30.25	446	026508132180	200	CL707BN	210.70	458	026508250587	12
AT2199WR	30.25	446	026508118436	24	CL707BN	210.70	458	026508250587	12
BGS18186B	361.80	601	026508376379	1	CL707BL	231.80	458	026508351307	12
BGS181210B	462.95	601	026508357620	1	CL707BL	231.80	458	026508351307	12
BH3803CH	29.75	272	034584024848	12	CL707ORB	231.80	458	026508250594	12
BH3803BN	32.75	361	034584029058	24	CL707ORB	231.80	458	026508250594	12
BH3803BL	36.05	272	034584029041	24	CL6302	117.05	441	026508254202	12
BH3808CH	51.10	272	034584024855	3	CL6302	117.05	441	026508254240	12
BH3808BN	56.25	361	034584029072	6	CL6302EP	117.05	441	026508266892	12
BH3808BL	61.85	272	034584029065	6	CL6302EP	117.05	441	026508266892	12
BH3818CH	51.50	272	034584024862	6	CL6302BN	182.70	441	026508254257	12
BH3818BN	56.65	361	034584029096	6	CL6302BN	182.70	441	026508254257	12
BH3818BL	62.30	272	034584029089	6	CL6302EPBN	182.70	441	026508266908	12
BH3824CH	55.90	272	034584024879	6	CL6302EPBN	182.70	441	026508266908	12
BH3824BN	61.45	361	034584029119	6	CL6303	64.70	443	026508254264	12
BH3824BL	67.60	272	034584029102	6	CL6303	64.70	443	026508254264	12
BH3886CH	41.00	272	034584024886	6	CL6303EP	64.70	443	026508266878	12
BH3886BN	45.15	361	034584029133	6	CL6303EP	64.70	443	026508266878	12
BH3886BL	49.55	272	034584029126	6	CL6303BN	99.15	443	026508254271	12
BP1803CH	18.00	491	034584030870	24	CL6303BN	99.15	443	026508254271	12
BP1803BN	22.50	491	034584030863	24	CL6303EPBN	99.15	443	026508266885	12
BP1803BL	23.40	491	034584030856	24	CL6303EPBN	99.15	443	026508266885	12
BP1808CH	28.65	491	034584030900	6	CL10154	37.55	445	026508254103	12
BP1808BN	35.80	491	034584030894	6	CL10154	37.55	445	026508254103	12
BP1808BL	37.25	491	034584030887	6	CL10154BN	75.85	445	026508254110	12
BP1818CH	39.20	491	034584030931	6	CL10154BN	75.85	445	026508254110	12
BP1818BN	49.00	491	034584030924	6	CL26500	68.95	442	026508254226	12
BP1818BL	51.00	491	034584030917	6	CL26500	68.95	442	026508254226	12
BP1822CH	64.00	491	034584030962	6	CL26500EP	68.95	442	026508266915	12
BP1822BN	80.00	491	034584030955	6	CL26500EP	68.95	442	026508266915	12
BP1822BL	83.30	491	034584030948	6	CL26500BN	112.50	442	026508254233	2
BP1824CH	41.00	491	034584030993	6	CL26500BN	112.50	442	026508254233	2
BP1824BN	51.25	491	034584030986	6	CL26500EPBN	112.50	442	026508266922	12
BP1824BL	53.45	491	034584030979	6	CL26500EPBN	112.50	442	026508266922	12
BP1886CH	24.50	491	034584031020	6	CL123815	46.95	445	026508254127	12
BP1886BN	29.65	491	034584031013	6	CL123815	46.95	445	026508254127	12
BP1886BL	31.85	491	034584031006	6	CL123815BN	88.65	445	026508254134	12
BP1888CH	42.45	491	034584031051	6	CL123815BN	88.65	445	026508254134	12
BP1888BN	53.05	491	034584031044	6	CL155694	30.95	458	026508254141	12
BP1888BL	55.20	491	034584031037	6	CL155694	30.95	458	026508254141	12
BP1892CH	252.05	491	034584031082	1	CL155694BN	44.75	458	026508254158	12
BP1892BN	308.35	491	034584031075	1	CL155694BN	44.75	458	026508254158	12
BP1892BL	327.40	491	034584031068	1	CL155747	80.10	453	026508254776	6
BP3703CH	30.45	495	034584025418	24	CL155747	80.10	453	026508254776	6
BP3703BN	34.30	495	034584025401	24	CL155747BN	116.20	453	026508254783	6
BP3708CH	44.20	495	034584025432	6	CL155747BN	116.20	453	026508254783	6
BP3708BN	49.75	495	034584025425	6	CL155748	47.85	456	026508254165	12
BP3718CH	58.00	495	034584025456	6	CL155748	47.85	456	026508254165	12
BP3718BN	65.20	495	034584025449	6	CL155748BN	69.40	456	026508254172	12
BP3724CH	60.65	495	034584025470	6	CL155748BN	69.40	456	026508254172	12
BP3724BN	70.95	495	034584025463	6	CL164928	95.70	452	026508254202	6
BP3786CH	46.95	495	034584025494	6	CL164928	95.70	452	026508254202	6
BP3786BN	52.80	495	034584025487	6	CL164928BN	138.75	452	026508254219	6
BP6903CH	12.55	497	034584020215	24	CL164928BN	138.75	452	026508254219	6
BP6903BN	18.85	497	034584039446	24	CLA701	62.85	458	026508254288	12
BP6903OWB	19.00	497	034584012517	24	CLA701	62.85	458	026508254288	12
BP6908CH	27.70	497	034584484093	6	CLA701BN	90.90	458	026508254295	12
BP6908OWB	37.35	497	034584012524	6	CLA701BN	90.90	458	026508254295	12
BP6908BN	37.40	497	034584039453	6	CSR2145CH	55.50	515	034584023407	10
BP6918CH	28.95	497	034584484079	6	CSR2145BN	64.75	515	034584023391	10
BP6918BN	35.20	497	034584039460	6	CSR2145BL	69.35	515	034584038562	10
BP6918OWB	36.20	497	034584012531	6	CSR2155CH	60.55	515	034584023421	10
BP6924CH	31.95	497	034584484086	6	CSR2155BN	64.60	515	034584023414	10
BP6924BN	42.20	497	034584039477	6	CSR2155OWB	76.35	515	034584023438	10
BP6924OWB	42.20	497	034584012548	6	CSR2160CH	68.00	514	034584008831	10
BP6980CH	23.25	497	034584014658	6	CSR2160BN	69.25	514	034584008848	10
BP6980OWB	28.15	497	034584014665	6	CSR2160OWB	85.55	514	034584008855	10
BP6986CH	20.85	497	034584484109	6	CSR2160BG	99.85	514	034584028587	10
BP6986BN	26.05	497	034584039484	6	CSR2160BL	102.05	514	034584029805	10
BP6986OWB	26.10	497	034584012555	6	CSR2160NL	136.05	514	034584029812	10
BR587	5.00	510	034584701183	72	CSR2164CH	69.50	514	034584024374	10
CA8301	623.50	642	026508211076	3	CSR2164BN	76.50	514	034584024381	10
CA8301BN	779.40	642	026508343814	3	CSR2164OWB	87.45	514	034584024398	10
CA8301BL	841.75	642	026508343807	3	CSR2164BL	104.35	514	034584029829	10
CA8302	615.25	642	026508211083	6	CSR2164BG	107.00	514	034584028570	10
CA8302BN	769.05	642	026508343838	6	CSR2165CH	53.75	515	034584008794	10
CA8302BL	830.60	642	026508343821	6	CSR2165BN	57.60	515	034584008800	10
CA8303	693.80	643	026508211090	3	CSR2165BL	67.20	515	034584038579	10
CL703	107.05	458	026508250549	12	CSR2165OWB	69.15	515	034584011336	10
CL703	107.05	458	026508250549	12	CSR2166CH	61.50	515	034584008817	10
CL703BN	155.15	458	026508250556	12	CSR2166BN	66.15	515	034584008824	10

MODEL NUMBER	LIST PRICE	PAGE NO.	UNIVERSAL PRODUCT CODE	CASE QTY	MODEL NUMBER	LIST PRICE	PAGE NO.	UNIVERSAL PRODUCT CODE	CASE QTY
CSR2167CH	52.85	515	034584031112	10	DN6850BN	66.00	492	034584483416	2
CSR2167BN	61.65	515	034584031105	10	DN6886CH	21.45	492	034584483386	3
CSR2167BL	76.15	515	034584031099	10	DN6886BN	31.00	492	034584483393	3
CSR2169CH	64.70	514	034584038609	10	DN6886ORB	31.35	492	034584016027	3
CSR2169BN	71.30	514	034584038593	10	DN6890BN	65.60	492	034584485564	3
CSR2169BL	93.20	514	034584038586	10	DN6892BN	127.35	492	034584002235	3
CSR2172CH	62.95	516	034584023018	10	DN7005	47.00	542	034584179623	2
CSR2172BN	69.25	516	034584023001	10	DN7010	38.05	542	034584179630	2
DN0703CH	25.90	352	034584008268	6	DN7015	45.95	542	034584179647	2
DN0703BN	29.10	352	034584012890	24	DN7020	43.55	542	034584179654	2
DN0703BL	32.10	352	034584034373	12	DN7025	62.40	541	034584179661	2
DN0705CH	11.15	352	034584018489	48	DN7030	79.55	541	034584179678	2
DN0705BN	13.05	352	034584018472	48	DN7050	19.85	542	034584179715	24
DN0705BL	13.55	352	034584029843	48	DN7060	104.05	541	034584484277	2
DN0705BG	15.65	352	034584028563	48	DN7075	104.35	542	034584484307	2
DN0707CH	22.30	352	034584018496	48	DN7100	140.05	541	034584011923	2
DN0707BN	24.00	352	034584018144	48	DN7105	180.10	541	034584011947	2
DN0707BL	26.95	352	034584029850	48	DN7110	487.20	541	034584019141	2
DN0707BG	28.75	352	034584028556	48	DN7110WB	565.25	541	034584023827	2
DN0708CH	51.00	352	034584008275	3	DN7175	73.60	542	034584011916	2
DN0708BN	57.45	352	034584012906	3	DN7703CH	15.85	496	034584004154	24
DN0708BL	63.20	352	034584034380	3	DN7703BN	18.40	496	034584004215	24
DN0709CH	46.85	352	034584017314	3	DN7708CH	29.45	496	034584004161	3
DN0709BN	52.45	352	034584017307	3	DN7708BN	33.75	496	034584004222	3
DN0709BL	57.70	352	034584034397	3	DN7718CH	31.00	496	034584004178	3
DN0718CH	46.90	352	034584008282	3	DN7718BN	35.65	496	034584004239	3
DN0718BN	54.30	352	034584012913	3	DN7722CH	48.90	496	034584004864	3
DN0718BL	59.70	352	034584034168	3	DN7722BN	56.20	496	034584004871	3
DN0722CH	76.50	352	034584008299	3	DN7724CH	33.65	496	034584004185	3
DN0722BN	85.85	352	034584012920	3	DN7724BN	38.75	496	034584004246	3
DN0722BL	94.45	352	034584034175	3	DN7786CH	22.05	496	034584004192	3
DN0724CH	51.00	352	034584008305	3	DN7786BN	25.30	496	034584004253	3
DN0724BN	59.15	352	034584012937	3	DN7790CH	53.05	496	034584004208	3
DN0724BL	65.10	352	034584034182	3	DN7790BN	61.05	496	034584004260	3
DN0761CH	149.80	353	034584018632	2	DN8001W	58.40	542	034584025319	3
DN0761BL	181.45	353	034584029867	2	DN8001CH	64.70	542	034584011701	3
DN0761BN	188.60	353	034584018625	2	DN8303CH	18.05	489	034584004413	24
DN0761BG	226.30	353	034584028549	2	DN8303BN	20.25	489	034584004482	24
DN0762CH	213.70	353	034584018656	2	DN8308CH	34.65	489	034584004420	3
DN0762BL	258.80	353	034584029874	2	DN8308BN	38.60	489	034584004499	3
DN0762BN	264.10	353	034584018649	2	DN8318CH	35.40	489	034584004437	3
DN0762BG	316.80	353	034584028532	2	DN8318BN	39.60	489	034584004505	3
DN0763CH	262.25	353	034584018670	2	DN8322CH	58.50	489	034584004444	3
DN0763BL	317.60	353	034584029881	2	DN8322BN	65.35	489	034584004512	3
DN0763BN	327.90	353	034584018663	2	DN8324CH	38.40	489	034584004451	3
DN0763BG	393.40	353	034584028525	2	DN8324BN	42.95	489	034584004529	3
DN0764CH	335.95	353	034584018694	2	DN8386CH	25.00	489	034584004468	3
DN0764BL	406.85	353	034584029898	2	DN8386BN	27.95	489	034584004536	3
DN0764BN	419.80	353	034584018687	2	DN8390CH	65.35	489	034584004475	3
DN0764BG	503.75	353	034584028518	2	DN8390BN	72.85	489	034584004543	3
DN0769	27.65	353	034584019097	3	DN8403CH	9.05	498	034584141118	12
DN0786CH	33.10	352	034584008312	3	DN8403BN	13.50	498	034584002242	12
DN0786BN	40.20	352	034584012982	3	DN8403BL	16.70	498	026508363409	12
DN0786BL	44.25	352	034584034199	3	DN8408CH	19.30	498	034584141125	3
DN0790CH	92.45	352	034584008329	3	DN8408BN	26.60	498	034584002259	3
DN0790BN	104.10	352	034584012999	3	DN8408BL	29.00	498	026508363416	3
DN0790BL	114.50	352	034584034205	3	DN8418CH	25.15	498	034584141132	3
DN0792CH	123.75	352	034584008336	3	DN8418BN	31.15	498	034584002266	3
DN0792BN	139.25	352	034584013101	3	DN8418BL	33.95	498	026508363423	3
DN0792BL	153.15	352	034584034212	3	DN8422CH	41.50	498	034584141187	3
DN0794CH	216.45	352	034584015167	2	DN8424CH	26.95	498	034584141149	3
DN0794BN	234.05	352	034584015174	2	DN8424BN	33.20	498	034584002273	3
DN0794BL	257.45	352	034584034229	2	DN8424BL	36.20	498	026508363430	3
DN0892ORB	122.05	502	034584004994	1	DN8486CH	17.30	498	034584141156	3
DN2141CH	85.50	513	034584017536	2	DN8486BN	22.35	498	034584002280	3
DN2141BN	86.20	513	034584017543	2	DN8486BL	24.35	498	026508363454	3
DN2141OWB	108.45	513	034584017550	2	DN8490CH	45.40	498	034584481849	3
DN2141BL	111.20	513	034584029904	6	DN8712	30.20	537	034584178275	6
DN2692CH	104.10	502	034584005014	1	DN8948	65.80	538	034584175601	6
DN2692BN	109.05	502	034584005038	1	DN9830CH	6.10	511	034584005885	50
DN5075	24.00	510	034584014856	3	DN9830BL	9.20	511	034584029928	50
DN5075W	24.00	510	034584014863	3	DN9830SN	10.10	511	034584005915	50
DN6801CH	21.85	492	034584001139	24	DN9830BN	10.75	511	034584005892	50
DN6801BN	33.20	492	034584001146	12	EB500-E	144.00	148	026508358269	5
DN6801ORB	36.60	492	034584009333	12	EB500-R	144.00	148	026508358276	5
DN6803CH	13.60	492	034584483300	24	EB800-E	305.30	148	026508358283	1
DN6803BN	22.25	492	034584483317	6	EB1000	438.70	147	026508337127	1
DN6803ORB	22.50	492	034584015983	12	EB1500-E	613.85	147	026508358238	1
DN6808CH	25.95	492	034584483324	3	EB1500-EBS	706.20	147	026508358245	1
DN6808BN	34.60	492	034584483331	3	EB2100-E	844.60	147	026508358252	1
DN6808ORB	38.25	492	034584015990	3	ET900	1921.55	149	026508358306	1
DN6818CH	30.35	492	034584483348	3	ET1300	3536.95	149	026508358290	1
DN6818BN	40.90	492	034584483355	3	ET2200	5229.25	149	026508337158	1
DN6818ORB	42.50	492	034584016003	3	EX50c	212.55	140	026508290439	2
DN6822BN	67.50	492	034584002297	3	EX75c	319.35	139	026508290446	2
DN6824CH	32.95	492	034584483362	3	EX100c	415.20	138	026508377665	2
DN6824BN	44.40	492	034584483379	3	EX100c	507.30	138	026508295670	2
DN6824ORB	46.20	492	034584016010	3	F5923	710.60	83	026508344415	3

Wholesale

Listed in numerical order

MODEL NUMBER	LIST PRICE	PAGE NO.	UNIVERSAL PRODUCT CODE	CASE QTY	MODEL NUMBER	LIST PRICE	PAGE NO.	UNIVERSAL PRODUCT CODE	CASE QTY
F5923SRS	863.35	83	026508344446	3	GGA55B	153.95	131	026508307373	10
F5923BL	888.05	83	026508344439	3	GGA57B	146.45	131	026508307397	9
F5923BG	1051.45	83	026508344422	3	GGA60B	85.55	133	026508307427	36
F7600	199.95	104	026508359815	6	GGA60W	85.55	133	026508307458	36
F7600SRS	249.95	104	26508359822	6	GGB3018B	382.65	122	026508307502	1
F7600BL	259.95	104	26508376584	6	GGB3019B	521.70	122	026508307519	1
F7600BZG	269.95	104	26508376584	6	GGB3024B	878.15	121	026508307526	1
F7620	199.95	104	026508359839	6	GGB3026B	703.50	121	026508307533	1
F7620SRS	249.95	104	026508359853	6	GGB3028B	641.10	121	026508307557	1
F7620BL	259.95	104	026508359846	6	GGB4010B	662.40	121	026508309353	1
F7660	199.95	104	26508376355	6	GGB4012B	645.25	121	026508309360	1
F7660SRS	249.95	104	026508359877	6	GGW3018B	382.65	122	026508307717	1
F7660BL	259.95	104	026508359860	6	GGW3019B	521.70	122	026508307724	1
F9126	657.30	86	26508375570	3	GGW3024B	878.15	121	026508307731	1
F9126SRS	821.65	86	026508344491	3	GGW3026B	703.50	121	026508307748	1
F9126BL	854.50	86	026508344484	3	GGW3028B	641.10	121	026508307762	1
F9800	211.95	106	026508346419	2	GGW4010B	662.40	121	026508309445	1
F9805	120.00	107	26508359884	6	GGW4012B	645.25	121	026508309452	1
F9810	53.30	107	026508359884	12	GS18155	921.00	127	026508376386	1
F9820	93.30	107	026508359891	12	GS18156B	709.05	127	026508376393	1
F9900	539.95	106	026508373132	1	GS18157	492.15	128	026508376409	1
F9910	68.95	106	26508373095	12	GS18158B	349.70	128	026508376416	1
F9920	68.95	107	26508373118	12	GS18186B	399.60	128	026508376447	1
F9930	159.95	107	26508373125	12	GS18259B	785.00	126	026508376454	1
F9940	79.95	107	26508379387	12	GS18260B	525.00	126	026508376461	1
F26610SRS	144.95	108	26508383018	6	GS18463	377.60	128	026508376478	1
F26620	115.95	108	026508387573	6	GS20166	260.25	129	026508376485	1
F26620SRS	144.95	108	026508387580	6	GS20167B	260.25	129	026508376492	1
F26620BL	150.75	108	026508387566	6	GS20264	339.80	129	026508376508	1
F26660SRS	144.95	108	026508387559	6	GS20265B	305.70	129	026508376515	1
F26660BL	150.75	108	026508387597	6	GS161400R	1013.85	117	26508380598	1
FC301810	895.30	121	026508334744	1	GS161500R	921.55	117	26508380604	1
FC331910	970.90	121	026508334751	1	GS161600R	860.00	117	26508380611	1
FP62300	148.05	473	026508154502	12	GS181020BUX	1075.00	119	026508365939	1
FP62320	148.05	473	026508154496	12	GS181050BUX	1425.00	119	026508365878	1
FP62325PF	161.30	475	026508312377	12	GS181062B	750.00	125	026508365915	1
FP62326PF	193.25	475	026508312384	12	GS181092B	975.00	125	026508365922	1
FP62327PF	161.30	475	026508312391	12	GS181210B	514.35	126	026508357637	1
FP62328PF	193.25	475	026508312407	12	GS181723B	656.60	127	026508376423	1
FP62340	164.25	475	026508199213	12	GS181733B	599.90	127	026508376430	1
FP62360PF	200.50	476	026508312414	12	GS182040BUX	1350.00	119	026508368268	1
FP62365	148.05	474	026508233580	12	GS182072B	750.00	126	026508365892	1
FP62365PF	168.65	476	026508312421	12	GS182082B	850.00	126	026508365885	1
FP62370	180.00	473	026508154519	12	GS202683	385.00	129	026508376522	1
FP62380	148.05	474	026508154526	12	GS202684	385.00	129	026508376539	1
FP62380PF	168.65	476	026508312438	12	GT33c	137.25	141	026508290453	2
FP62385	180.00	474	026508264713	12	GT50C	165.15	140	026508290460	2
FP62385PF	200.50	476	026508312445	12	GXB75c	356.85	139	026508274453	2
FS7235	780.70	77	026508344569	3	GXP33c	126.40	141	026508261811	2
FS7235SRS	945.90	77	026508344583	3	GXP50c	148.70	140	026508261804	2
FS7235BL	1014.95	77	026508344576	3	L2352	201.25	368	026508047538	6
FS72003	765.55	78	026508375181	3	L2353	229.85	366	026508047569	6
FS72003SRS	956.95	78	026508344552	3	L2361	219.10	369	026508047613	6
FS72003BL	995.25	78	026508344545	3	L2362	233.90	368	026508047545	6
FS73004	765.55	76	026508375211	3	L2363	262.70	366	026508047583	6
FS73004SRS	980.50	76	026508344538	3	L2368EP	290.90	368	026508241813	3
FS73004NL	1058.90	76	026508344514	3	L2369EP	313.85	366	026508241820	3
FS73004ORB	1098.15	76	026508344521	3	L4601	175.70	362	026508047293	12
FS73004BG	1137.35	76	026508344507	3	L4605	175.70	362	026508060759	12
G16100	841.30	125	026508240267	1	L4621	217.05	362	026508047286	12
G16200	819.70	125	026508240274	1	L4625	217.05	362	026508047323	12
G16221	862.90	125	026508240281	1	L64600	154.85	602	026508063705	12
G16430	517.30	125	026508240298	1	L64601	154.85	602	026508063712	12
G18121	884.50	127	026508248447	1	L64620	201.95	603	026508047309	12
G18180	571.50	126	026508248119	1	L64621	190.30	603	026508047316	12
G18185	442.80	128	026508248140	1	L64624	207.75	603	026508047347	12
G18220	1036.20	127	026508248454	1	L64625	192.20	603	026508047354	12
G18287	571.50	126	026508248157	1	L64635	207.75	603	026508061534	12
G18288	646.90	127	026508248164	1	LR2250DCH	27.25	540	034584009005	3
GA716	115.05	132	026508248027	10	LR2350DCH	73.40	540	034584020857	3
GA719	166.25	132	026508248034	6	LR2350DBN	76.30	540	034584017598	3
GA726	80.90	132	026508248041	15	LR2352DBN	70.60	540	034584017604	3
GA728	109.15	132	026508248058	12	LR2352DCH	73.40	540	034584020871	3
GA760	194.50	132	026508248218	3	LR2354DCH	73.40	540	034584020918	3
GA763	143.75	132	026508248225	6	LR2354DBN	76.30	540	034584020550	3
GA768	169.70	132	026508248232	10	LR2356DCH	73.40	540	034584020895	3
GA771	186.90	132	026508248249	6	LR7518	30.20	539	034584485397	1
GA772	143.20	131	026508248256	12	LR7524	34.40	539	034584485403	1
GA776	199.95	118	26508380505	10	LR7536	43.50	539	034584485410	1
GA779	526.65	118	26508380536	10	LR7542	48.40	539	034584485427	1
GA780B	190.05	132	026508248263	6	LR8716D3CH	40.70	535	034584005236	3
GA781B	169.70	131	026508248270	8	LR8716D3BN	45.65	535	034584005212	3
GA781	199.95	118	26508380550	10	LR8716D3GCH	64.25	536	034584005311	3
GA782B	143.75	131	026508248287	15	LR8716D3GBN	65.70	536	034584005298	3
GA785B	156.90	131	026508248294	6	LR8716D3GOWB	77.70	536	034584007780	3
GGA50B	140.60	131	026508307328	9	LR8724D2CH	47.85	535	034584005205	3
GGA51B	178.75	131	026508307335	10	LR8724D3CH	47.90	535	034584005243	3
GGA52B	194.35	131	026508307342	9	LR8724PS	51.85	537	034584000798	3

Wholesale

Listed in numerical order

SUGGESTED LIST PRICES

MODEL NUMBER	LIST PRICE	PAGE NO.	UNIVERSAL PRODUCT CODE	CASE QTY
LR8724D3BN	53.20	535	034584005229	3
LR8724D2BN	53.25	535	034584005182	3
LR8724D3GCH	70.40	536	034584005328	3
LR8724D1GCH	71.05	535	034584005281	3
LR8724D1GBN	74.50	535	034584005267	3
LR8724D3GBN	76.70	536	034584005304	3
LR8724D1GOWB	88.60	535	034584007773	3
LR8724D3GOWB	90.90	536	034584007797	3
MANCIS	59.70	465	026508355633	12
MANCIS	59.70	465	026508355633	12
MANCXS	59.70	465	026508356913	12
MANCXS	59.70	465	026508356913	12
MANXS	59.70	465	026508356920	12
MANXS	59.70	465	026508356920	12
MBHG3818CH	141.40	272	034584030078	3
MBHG3818BN	147.15	361	034584030061	3
P1700	16.00	507	034584751904	100
P1703	7.40	507	034584751805	100
P1718	18.70	507	034584029171	50
P1724	19.60	507	034584029188	50
P1780	16.75	507	034584751409	50
P1786	12.80	507	034584751706	100
P5030	2.65	506	034584090300	100
P5030BN	5.20	506	034584027481	100
P5050	5.25	506	034584090454	100
P5050BN	11.95	506	034584027498	100
P5080	4.45	506	034584090317	100
P5080BN	9.80	506	034584027504	100
P5100	4.40	506	034584090478	100
P5118	5.95	506	034584090324	50
P5118BN	12.95	506	034584027511	36
P5124	6.75	506	034584090331	50
P5124BN	14.35	506	034584027528	36
P5130BN	15.45	506	034584027535	36
P5340	3.30	506	034584090348	100
P5360	3.95	506	034584090355	100
P5500	4.65	506	034584090362	100
P5860	5.50	506	034584090379	100
P5860BN	10.35	506	034584027542	100
R2250	19.20	540	034584094452	6
R2260	23.10	540	034584094469	6
R2270	27.40	540	034584094476	6
R2356DBN	78.60	540	034584025258	3
R5519	55.50	509	034584700544	10
R7418	22.70	539	034584174185	6
R7424	25.80	539	034584174246	6
R7436	35.95	539	034584174369	6
R7442	38.90	539	034584174420	6
R8712P	28.50	537	034584094889	6
R8712BL	37.75	537	034584038616	6
R8712W	39.90	537	034584017826	6
R8712D3GCH	58.40	536	034584020017	6
R8712D3GBN	63.95	536	034584020000	6
R8712D3GOWB	76.70	536	034584020024	6
R8716P	31.80	537	034584017833	6
R8716BL	42.10	537	034584038623	6
R8716W	45.95	537	034584017840	6
R8716D1GCH	65.70	535	034584025289	3
R8716D1GBN	71.05	535	034584025272	3
R8718P	33.60	537	034584094896	6
R8718PS	43.30	537	034584172273	6
R8718BL	43.60	537	034584038630	6
R8718W	48.20	537	034584171870	6
R8718D3GCH	64.00	536	034584020048	6
R8718D3GBN	72.65	536	034584020031	6
R8718PB	85.05	537	034584177186	6
R8718D3GOWB	85.65	536	034584020055	6
R8724P	38.30	537	034584094902	6
R8724BL	45.10	537	034584038647	6
R8724PS	47.45	537	034584172259	6
R8724W	52.35	537	034584172242	6
R8724PB	101.70	537	034584178244	6
R8730P	45.35	537	034584094919	6
R8730BL	50.90	537	034584038654	6
R8730W	57.60	537	034584014917	6
R8732P	43.30	537	034584014955	6
R8732BL	53.50	537	034584038661	6
R8732W	59.30	537	034584015181	6
R8736P	51.35	537	034584094926	6
R8736PS	55.95	537	034584172280	6
R8736BL	59.55	537	034584038678	6
R8736W	64.20	537	034584094872	6
R8736D3GCH	106.65	536	034584009043	6
R8736D3GBN	107.65	536	034584009050	6
R8736D3GOWB	127.35	536	034584016256	6
R8742P	55.20	537	034584094933	6
R8742BL	64.45	537	034584038685	6
R8742PS	68.45	537	034584172297	6

MODEL NUMBER	LIST PRICE	PAGE NO.	UNIVERSAL PRODUCT CODE	CASE QTY
R8742W	70.70	537	034584014962	6
R8742D3GCH	129.25	536	034584009067	6
R8742D3GBN	130.50	536	034584009074	6
R8742D3GOWB	152.95	536	034584016263	6
R8748P	65.25	537	034584482594	6
R8748BL	70.85	537	034584038692	6
R8748W	72.15	537	034584014979	6
R8748D3GCH	147.30	536	034584020079	6
R8748D3GBN	149.50	536	034584020062	6
R8748D3GOWB	174.25	536	034584020086	6
R8912P	33.15	538	034584094940	6
R8912BL	40.30	538	034584038708	6
R8912W	49.75	538	034584485571	6
R8916P	33.60	538	034584017857	6
R8916	34.85	538	034584017888	6
R8916BL	43.55	538	034584038715	6
R8918	38.30	538	034584176011	6
R8918P	40.00	538	034584094438	6
R8918BL	47.90	538	034584038722	6
R8918W	61.05	538	034584171924	6
R8924	43.30	538	034584176028	6
R8924P	45.35	538	034584094445	6
R8924BL	54.10	538	034584038739	6
R8924W	66.15	538	034584176059	6
R8930	46.65	538	034584014986	6
R8930P	49.10	538	034584094957	6
R8930BL	58.35	538	034584038746	6
R8930W	66.15	538	034584014993	6
R8932	46.60	538	034584015006	6
R8932P	49.15	538	034584015020	6
R8932BL	62.95	538	034584038753	6
R8932W	71.45	538	034584015013	6
R8936	53.10	538	034584176035	6
R8936P	56.40	538	034584481047	6
R8936BL	66.35	538	034584038760	6
R8936W	75.55	538	034584176073	6
R8942P	60.75	538	034584481054	6
R8942BL	72.60	538	034584038777	6
R8942W	88.05	538	034584176097	6
R8948P	62.60	538	034584482587	6
R8948BL	82.25	538	034584038784	6
R8948W	90.75	538	034584092533	6
R8960FDW	177.40	539	034584016607	2
R8960FD	180.90	539	034584016584	2
R8962FDW	196.55	539	034584016614	2
R8962FD	207.00	539	034584016591	2
RA8716D1GBN	81.20	535	034584025296	3
RR5506HD	28.00	509	034584038883	60
RR5506HDBN	30.75	509	034584038890	60
RR5506HDLB	32.95	509	034584038906	60
RR5506HDOWB	33.30	509	034584038913	60
RR5520SS	23.35	509	034584700551	24
S0000	57.00	630	026508181461	12
S0001	68.55	630	026508025314	12
S0002	70.00	630	026508025321	12
S0003	68.55	630	026508025338	12
S0004	82.35	630	026508025345	12
S0007	70.00	630	026508025376	12
S0009	75.45	630	026508025390	12
S0010	82.35	630	026508025406	12
S0011	68.55	630	026508025413	12
S0012	149.65	630	026508025420	12
S0020	70.00	631	026508148112	12
S0030T	59.30	631	026508269848	12
S0030	76.90	631	026508148129	12
S0030NA	79.20	631	026508273821	6
S0050T	67.45	631	026508269855	12
S0050	85.10	631	026508160718	12
S0060	105.75	631	026508199275	12
S0070	92.00	631	026508181478	12
S110	170.75	444	026508242353	6
S110BG	206.80	444	026508351321	6
S110BN	206.80	444	026508242360	6
S110BL	227.30	444	026508279434	6
S110ORB	227.30	444	026508351352	6
S112	583.85	438	026508132753	3
S112EP	583.85	438	026508221761	3
S112BG	790.55	438	026508323700	3
S112BN	790.55	438	026508132760	3
S112EPBG	790.55	438	026508323717	3
S112EPBN	790.55	438	026508222065	3
S112NL	790.55	438	026508144671	3
S112EPNL	869.55	438	026508222072	3
S112EPORB	869.55	438	026508222089	3
S112EPWR	869.55	438	026508222096	3
S112ORB	869.55	438	026508144664	3
S112WR	869.55	438	026508132777	3
S113	170.75	444	026508133965	6

Wholesale

Listed in numerical order

MODEL NUMBER	LIST PRICE	PAGE NO.	UNIVERSAL PRODUCT CODE	CASE QTY
S113BG	206.80	444	026508285978	6
S113BN	206.80	444	026508133972	6
S113NL	206.80	444	026508144695	3
S113ORB	227.30	444	026508144688	6
S113WR	227.30	444	026508133989	3
S116	185.45	444	026508349793	6
S116BG	222.35	444	026508349809	6
S116BN	222.35	444	026508349823	6
S116BL	244.60	444	026508349816	6
S116ORB	244.60	444	026508349830	6
S122	62.75	444	026508223499	6
S122BG	129.60	444	026508337851	6
S122BN	129.60	444	026508223512	6
S122NL	129.60	444	026508299517	6
S122BL	142.70	444	026508299500	6
S122ORB	142.70	444	026508223529	6
S133	62.75	445	026508223536	6
S133BG	129.60	445	026508351314	6
S133BN	129.60	445	026508223543	6
S133BL	142.70	445	026508351338	6
S134	62.75	445	026508328620	6
S134BG	129.60	445	026508328637	6
S134BN	129.60	445	026508328651	6
S134BL	142.70	445	026508328644	6
S176EP15	254.10	439	026508380239	3
S176	259.20	439	026508139189	3
S176EP	259.20	439	026508214558	3
S176EP15BG	349.35	439	026508380246	3
S176EP15BN	349.35	439	026508380260	3
S176BG	356.35	439	026508285190	3
S176BN	356.35	439	026508152911	3
S176EPBG	356.35	439	026508286012	3
S176EPBN	356.35	439	026508214565	3
S176EP15BL	366.80	439	026508380253	3
S176BL	374.15	439	026508279335	3
S176EPBL	374.15	439	026508279342	3
S177	62.60	445	026508223550	6
S177BN	129.60	445	026508223574	6
S178	256.10	439	026508374757	3
S178EP	256.10	439	026508374719	3
S178BG	356.35	439	026508374764	3
S178BN	356.35	439	026508374788	3
S178EPBG	356.35	439	026508374726	3
S178EPBN	356.35	439	026508374740	3
S178BL	374.15	439	026508374771	3
S178EPBL	374.15	439	026508374733	3
S664	802.45	95	026508200063	3
S664SRS	1003.10	95	026508234242	3
S664BL	1043.20	95	026508289525	3
S664NL	1083.35	95	026508294352	3
S664ORB	1123.45	95	026508169032	3
S664BG	1163.60	95	026508283967	3
S664BZG	1608.95	95	026508387146	3
S665	802.45	95	026508205617	3
S665SRS	1003.10	95	026508234259	3
S665BL	1043.20	95	026508289532	3
S665BG	1163.60	95	026508283974	3
S665BLS	1163.60	95	026508294635	3
S905	2291.55	206	026508298480	1
S905BN	3093.50	206	026508298497	1
S905BL	3093.55	206	026508370926	1
S931	2235.60	184	026508302484	1
S931BG	3018.00	184	026508302491	1
S931BN	3018.00	184	026508302507	1
S931NL	3018.00	184	026508302514	1
S989	285.30	459	026508302521	6
S989BG	428.00	459	026508302538	6
S989BN	428.00	459	026508302545	6
S989NL	428.00	459	026508302552	6
S990	280.65	462	026508302569	6
S990BG	421.00	462	026508302576	6
S990BN	421.00	462	026508302583	6
S990NL	421.00	462	026508302590	6
S1001	555.30	438	026508282366	3
S1001EP	555.30	438	026508290507	3
S1002	592.30	437	026508290514	3
S1002EP	592.30	437	026508290521	3
S1003	555.30	438	026508290538	3
S1003EP	555.30	438	026508290545	3
S1004	592.30	437	026508290552	3
S1004EP	592.30	437	026508290559	3
S1300	126.50	454	026508219621	6
S1311	622.85	437	026508152171	3
S1311EP	622.85	437	026508213988	3
S1311BG	850.10	437	026508285282	3
S1311BN	850.10	437	026508152188	3
S1311EPBG	850.10	437	026508285299	3
S1311EPBN	850.10	437	026508214015	3

MODEL NUMBER	LIST PRICE	PAGE NO.	UNIVERSAL PRODUCT CODE	CASE QTY
S1311EPNL	850.10	437	026508231180	3
S1311NL	850.10	437	026508231197	3
S1311BL	935.05	437	026508301326	3
S1311EPBL	935.05	437	026508301333	3
S1311EPORB	935.05	437	026508214022	3
S1311ORB	935.05	437	026508152195	3
S2000ESUSA	261.90	55	026508343661	2
S3102	859.30	53	026508269916	3
S3104	1836.30	471	026508269923	3
S3105	2291.55	218	026508294277	1
S3105BN	3093.50	218	026508294291	1
S3105BL	3402.90	218	026508294284	1
S3371	728.95	471	026508216408	6
S3600	185.35	471	026508216439	12
S3835	172.55	459	026508291221	6
S3835BN	250.15	459	026508291245	6
S3835BL	275.25	459	026508291238	6
S3836	155.40	462	026508291252	6
S3836BN	225.30	462	026508291276	6
S3836BL	247.75	462	026508291269	6
S3870EPBN	1002.20	447	026508228982	6
S3879EP	441.10	447	026508221884	6
S3879EPBN	885.05	447	026508221891	6
S3880EP	441.10	447	026508282380	6
S3880EPBG	885.05	447	026508318997	6
S3880EPBN	885.05	447	026508282373	6
S3880EPNL	885.05	447	026508316696	6
S3894	147.50	459	026508240144	6
S3896	141.15	459	026508220764	6
S3896BN	204.70	459	026508222126	6
S3896BL	206.60	459	026508370889	6
S3898	138.85	462	026508220450	6
S3898BN	201.45	462	026508220467	6
S3898BL	203.30	462	026508370896	6
S3945C	208.10	109	026508248911	6
S3945SRS	260.10	109	026508248935	6
S3945BL	270.50	109	026508289945	6
S3945NL	280.90	109	026508295236	6
S3945ORB	291.30	109	026508248928	6
S3945BZG	295.80	109	026508283882	6
S3945BG	301.70	109	026508283882	6
S3946C	208.10	110	026508248942	6
S3946SRS	260.10	110	026508248966	6
S3946BL	270.50	110	026508247167	6
S3946NL	280.90	110	026508316900	6
S3946ORB	291.30	110	026508248959	6
S3946BG	301.70	110	026508283899	6
S3946BLS	301.70	110	026508294581	6
S3947C	208.10	109	026508248973	6
S3947SRS	260.10	109	026508247327	6
S3947BL	270.50	109	026508289457	6
S3947BG	301.70	109	026508283905	6
S3947BLS	301.70	109	026508294598	6
S3948C	208.10	110	026508247150	6
S3948SRS	260.10	110	026508250280	6
S3948BL	270.50	110	026508289464	6
S3948ORB	291.30	110	026508250273	6
S3955C	208.10	109	026508300619	6
S3955SRS	260.10	109	026508300626	6
S3955BL	270.50	109	026508300602	6
S5000	266.75	459	026508310526	6
S5000BG	400.05	459	026508310533	6
S5000BN	400.05	459	026508310557	6
S5000BL	440.00	459	026508310540	6
S5001	249.55	462	026508310564	6
S5001BG	374.30	462	026508310571	6
S5001BN	374.30	462	026508310595	6
S5001BL	411.70	462	026508310588	6
S5235	896.65	77	026508316702	3
S5235EWC	1049.45	68	026508373323	3
S5235SRS	1120.75	77	026508316733	3
S5235BL	1165.60	77	026508316719	3
S5235NL	1210.45	77	026508316726	3
S5235EWSRS	1311.75	68	026508373347	3
S5235EWBL	1364.30	68	026508373316	3
S5235EWNL	1416.75	68	026508373330	3
S5500	378.05	96	026508249475	6
S5510	432.85	105	026508249482	3
S5510SRS	541.05	105	026508249505	3
S5510BL	562.75	105	026508289471	3
S5510NL	584.35	105	026508294345	3
S5510ORB	606.00	105	026508249499	3
S5510BG	627.65	105	026508283912	3
S5520	432.85	105	026508249512	3
S5520SRS	541.05	105	026508249536	3
S5520BL	562.75	105	026508289488	3
S5520ORB	606.00	105	026508249529	3
S5520BG	627.65	105	026508283929	3

Wholesale

Listed in numerical order

MODEL NUMBER	LIST PRICE	PAGE NO.	UNIVERSAL PRODUCT CODE	CASE QTY	MODEL NUMBER	LIST PRICE	PAGE NO.	UNIVERSAL PRODUCT CODE	CASE QTY
S5520BLS	627.65	105	026508294604	3	S6365EPORB	374.15	439	026508230268	3
S5530	432.85	105	026508249543	3	S6365ORB	374.15	439	026508230275	3
S5530SRS	541.05	105	026508249550	3	S6710	604.20	205	026508298206	3
S5530BL	562.75	105	026508289495	3	S6710BN	906.30	205	026508298213	3
S5530BG	627.65	105	026508283936	3	S6710BL	936.50	205	026508370902	3
S5530BLS	627.65	105	026508294611	3	S6712	845.70	205	026508298220	3
S5535	403.90	105	026508316788	3	S6712BN	1099.40	205	026508298237	3
S5535SRS	504.90	105	026508316818	3	S6712BL	1141.65	205	026508370919	3
S5535BL	525.10	105	026508316795	3	S6910	460.40	217	026508291085	3
S5535NL	545.30	105	026508316801	3	S6910BN	598.55	217	026508291108	3
S5540	432.85	105	026508300633	3	S6910BL	644.60	217	026508291092	3
S5540SRS	541.05	105	026508300657	3	S6910EW	825.90	157	026508355015	3
S5540BL	562.75	105	026508300640	3	S6910EWBN	1060.80	157	026508355039	3
S5550	432.85	104	026508300695	3	S6910EWBL	1156.25	157	026508355022	3
S5550SRS	541.05	104	026508300718	3	S6981	643.05	183	026508302408	3
S5550BL	562.75	104	026508300701	3	S6981BN	835.95	183	026508302422	3
S5550BLS	627.65	104	026508316672	3	S6981NL	900.25	183	026508302439	3
S5560	412.30	105	026508335758	3	S6981BG	932.40	183	026508302415	3
S5560SRS	515.30	105	026508335772	3	S6981EW	1009.30	157	026508354971	3
S5560BL	535.95	105	026508335765	3	S6981EWBN	1261.60	157	026508354995	3
S5560NL	556.55	105	026508336755	3	S6981EWNL	1312.05	157	026508354988	3
S6235	620.70	97	026508316825	3	S6981EWBG	1362.55	157	026508355008	3
S6235SRS	775.95	97	026508316856	3	S6982	771.65	183	026508302446	3
S6235BL	806.95	97	026508316832	3	S6982BN	1003.15	183	026508302460	3
S6235NL	838.00	97	026508316849	3	S6982NL	1080.35	183	026508302477	3
S6310	259.20	439	026508220771	3	S6982BG	1118.90	183	026508302453	3
S6310EP	259.20	439	026508221921	3	S7235	689.70	78	026508316863	3
S6310EPNL	339.30	439	026508234389	3	S7235SRS	862.10	78	026508316894	3
S6310NL	339.30	439	026508234549	3	S7235BL	896.60	78	026508316870	3
S6310BN	356.35	439	026508220986	3	S7235NL	931.05	78	026508316887	3
S6310EPBN	356.35	439	026508221938	3	S7235EV2C	1196.50	64	026508356777	3
S6310EPORB	374.15	439	026508221945	3	S7235EV2SRS	1316.10	64	026508356791	3
S6310EPWR	374.15	439	026508281000	3	S7235EV2BL	1375.95	64	026508356760	3
S6310ORB	374.15	439	026508220993	3	S7235EV2NL	1435.80	64	026508356784	3
S6310WR	374.15	439	026508221013	3	S11705EP	359.45	450	026508221969	6
S6312	168.60	441	026508220788	12	S11705EPBN	520.95	450	026508221952	6
S6312EP	168.60	441	026508222003	12	S12104	223.70	459	026508215531	6
S6312BN	200.40	441	026508221037	12	S12104BG	354.30	459	026508285985	6
S6312EPBN	200.40	441	026508222027	12	S12104BN	354.30	459	026508215548	6
S6312EPNL	200.40	441	026508260845	6	S12104NL	357.85	459	026508231166	6
S6312NL	200.40	441	026508260869	12	S12104BL	389.75	459	026508301302	6
S6312EPORB	220.35	441	026508260852	12	S12104ORB	389.75	459	026508215555	6
S6312ORB	220.35	441	026508260876	12	S12105	201.40	462	026508281246	6
S6320	394.80	438	026508220795	3	S12105BG	292.05	462	026508285992	6
S6320EP	394.80	438	026508221853	3	S12105BN	292.05	462	026508281253	6
S6320BG	620.45	438	026508286494	3	S12105NL	292.05	462	026508281260	6
S6320BN	620.45	438	026508221068	3	S12105BL	321.25	462	026508301319	6
S6320EPBG	620.45	438	026508285206	3	S12105ORB	321.25	462	026508281277	6
S6320EPBN	620.45	438	026508221860	3	S12107EP	726.05	447	026508218945	6
S6320BL	682.40	438	026508351598	3	S12107EPBG	1026.75	447	026508286005	6
S6320EPBL	682.40	438	026508351604	3	S12107EPBN	1026.75	447	026508218952	6
S6320EPORB	682.40	438	026508221877	3	S12107EPNL	1026.75	447	026508231173	6
S6320ORB	682.40	438	026508221075	3	S12107EPORB	1129.30	447	026508218969	6
S6335	203.25	441	026508220849	6	S12107EPBL	1140.05	447	026508313381	6
S6335EP	203.25	441	026508221778	6	S16900	189.10	462	026508282946	6
S6335EP15	203.25	441	026508264218	6	S16900BN	320.70	462	026508282953	6
S6335BN	276.70	441	026508220863	6	S16900BL	352.85	462	026508301340	6
S6335EPBN	276.70	441	026508222041	6	S22105	2368.70	161	026508251072	1
S6340	259.20	439	026508220801	3	S22105BN	3434.65	161	026508251089	3
S6340EP	259.20	439	026508221907	3	S22105BL	3553.00	161	026508302293	1
S6340EP15	259.20	439	026508241790	3	S22105NL	3671.50	161	026508337448	1
S6340BN	356.35	439	026508220634	3	S22105BG	3789.90	161	026508373200	12
S6340EP15BN	356.35	439	026508241806	3	S22105ORB	3789.90	161	026508285015	1
S6340EPBN	356.35	439	026508221914	3	S22110	2368.70	161	026508255001	1
S6345	405.95	438	026508260944	3	S22110BN	3434.65	161	026508255018	1
S6345EP	405.95	438	026508260968	3	S22110BL	3553.00	161	026508302309	1
S6345BG	638.00	438	026508286036	3	S22110NL	3671.50	161	026508337455	1
S6345BN	638.00	438	026508260951	3	S22110BG	3789.90	161	026508373217	12
S6345EPBG	638.00	438	026508286043	3	S22110ORB	3789.90	161	026508285022	1
S6345EPBN	638.00	438	026508260975	3	S42107	780.10	159	026508215562	3
S6345BL	701.70	438	026508351611	3	S42107BN	1092.15	159	026508215579	3
S6345EPBL	701.70	438	026508351628	3	S42107BL	1131.15	159	026508301357	3
S6360	377.30	438	026508220481	3	S42107NL	1170.15	159	026508231203	3
S6360EP	377.30	438	026508220504	3	S42107BG	1209.20	159	026508286029	3
S6360BN	565.95	438	026508220498	3	S42107ORB	1209.20	159	026508215586	3
S6360EPBN	565.95	438	026508220511	3	S43001	712.15	173	026508242391	3
S6360EPORB	623.50	438	026508224946	3	S43001BL	1032.60	173	026508301364	3
S6360ORB	623.50	438	026508224953	3	S44101	596.90	194	026508310441	3
S6365	259.20	439	026508230220	3	S44101BN	775.95	194	026508310472	3
S6365EP	259.20	439	026508230244	3	S44101BL	835.65	194	026508310465	3
S6365BG	356.35	439	026508285305	3	S44101BG	865.50	194	026508310458	3
S6365BN	356.35	439	026508230237	3	S44507	2235.60	195	026508310489	1
S6365EPBG	356.35	439	026508285312	3	S44507BG	3018.00	195	026508310496	1
S6365EPBN	356.35	439	026508230251	3	S44507BN	3018.00	195	026508310519	1
S6365EPNL	356.35	439	026508301371	3	S44507BL	3319.90	195	026508310502	1
S6365NL	356.35	439	026508301388	3	S52003	620.20	97	026508294734	3
S6365BL	374.15	439	026508289501	3	S52003SRS	775.25	97	026508294758	3
S6365EPBL	374.15	439	026508289518	3	S52003BL	806.25	97	026508294741	3

Wholesale

Listed in numerical order

MODEL NUMBER	LIST PRICE	PAGE NO.	UNIVERSAL PRODUCT CODE	CASE QTY	MODEL NUMBER	LIST PRICE	PAGE NO.	UNIVERSAL PRODUCT CODE	CASE QTY
S53004	639.00	97	026508288689	3	SR2201OWB	22.45	517	034584018847	12
S53004SRS	798.75	97	026508288719	3	SR2201BL	31.10	517	034584029195	24
S53004BL	830.75	97	026508337165	3	SR2201NL	31.10	517	034584029201	24
S53004NL	862.65	97	026508288696	3	SV003	141.35	630	026508025444	12
S53004ORB	894.60	97	026508288702	3	SV006	131.80	630	026508025475	12
S53004BG	926.60	97	026508299241	3	SV010	138.65	630	026508025512	12
S55005	748.05	96	026508288764	3	T181	45.45	369	026508029565	12
S55005SRS	935.05	96	026508288788	3	T181	45.45	369	026508029565	12
S55005BL	972.40	96	026508288771	3	T182	50.05	611	026508029589	12
S55005BLS	1086.25	96	026508300572	3	T182EP	50.05	612	026508208786	12
S62101	659.40	97	026508236420	3	T183	81.25	609	026508029602	12
S62101SRS	824.20	97	026508236451	3	T183EP	81.25	609	026508208809	12
S62101BL	857.20	97	026508337172	3	T187	45.45	613	026508019832	12
S62101NL	890.15	97	026508236437	3	T373	355.95	317	026508261316	3
S62101ORB	923.10	97	026508236444	3	T373BN	532.55	317	026508261323	3
S62101BG	956.10	97	026508283943	3	T373BL	585.90	317	026508325612	3
S64001	720.00	96	026508376119	3	T393	534.35	252	026508249642	3
S64001SRS	900.00	96	026508374559	3	T393BG	746.60	252	026508285909	3
S64001BL	936.00	96	026508376126	3	T393BN	746.60	252	026508249659	3
S64001BG	1044.00	96	026508374481	3	T393BL	791.20	252	026508281925	3
S72003	696.85	79	026508294765	3	T394	832.15	252	026508249666	3
S72003SRS	871.05	79	026508294789	3	T394BG	1369.95	252	026508285893	3
S72003BL	905.90	79	026508294772	3	T394BN	1369.95	252	026508249673	3
S72003EV2C	1040.20	65	026508356746	3	T470	48.25	616	026508019825	12
S72003EV2SRS	1144.20	65	026508356753	3	T471	93.20	615	026508015742	12
S72003EV2BL	1196.20	65	026508356081	3	T471EP	93.20	615	026508270813	12
S72103	865.85	78	026508300664	3	T473	57.55	615	026508015728	12
S72103SRS	1082.25	78	026508300688	3	T473EP	57.55	615	026508270967	12
S72103BL	1125.55	78	026508300671	3	T653	534.35	241	026508253830	3
S73004	718.00	76	026508288726	3	T653BN	746.60	241	026508253847	3
S73004SRS	897.50	76	026508288757	3	T653ORB	821.20	241	026508256107	3
S73004BL	933.40	76	026508337196	3	T654	832.15	241	026508256114	3
S73004NL	969.30	76	026508288733	3	T654BN	1369.95	241	026508254448	3
S73004ORB	1005.20	76	026508288740	3	T654ORB	1507.00	241	026508254578	3
S73004BG	1041.10	76	026508299234	3	T683	355.95	311	026508264621	3
S73004EV2C	1061.55	64	026508356821	3	T683BN	532.55	311	026508264638	3
S73004EV2SRS	1167.70	64	026508356852	3	T683BL	585.90	311	026508337066	3
S73004EV2BL	1220.75	64	026508356814	3	T683ORB	585.90	311	026508264645	3
S73004EV2BG	1273.85	64	026508356807	3	T693	512.75	298	026508230701	3
S73004EV2NL	1273.85	64	026508356838	3	T693BG	716.50	298	026508286272	3
S73004EV2ORB	1273.85	64	026508356845	3	T693BN	716.50	298	026508230718	3
S73104	879.90	76	026508305386	3	T693NL	716.50	298	026508301777	3
S73104EWC	1032.65	68	026508373378	3	T693BL	743.55	298	026508373040	3
S73104SRS	1099.85	76	026508305423	3	T693ORB	788.10	298	026508230725	3
S73104BL	1143.85	76	026508337202	3	T694	798.70	298	026508230732	3
S73104NL	1187.85	76	026508305409	3	T694BG	1314.80	298	026508286487	3
S73104ORB	1231.80	76	026508305416	3	T694BN	1314.80	298	026508230749	3
S73104BG	1275.80	76	026508305393	3	T694NL	1314.80	298	026508301784	3
S73104EWSRS	1290.85	68	026508373408	3	T694BL	1357.75	298	026508372227	3
S73104EWBL	1342.50	68	026508373361	3	T694ORB	1446.20	298	026508230756	3
S73104EWNL	1394.10	68	026508373385	3	T908	356.00	355	026508295717	3
S73104EWOORB	1445.75	68	026508373392	3	T908BN	532.55	355	026508295731	3
S73104EWBG	1497.40	68	026508373354	3	T908BL	585.85	355	026508295724	3
S73204	1034.75	75	026508337219	3	T924	558.90	324	026508162019	3
S73204SRS	1293.40	75	026508337264	3	T924BN	708.05	324	026508161036	3
S73204BL	1345.15	75	026508337233	3	T924ORB	778.90	324	026508161043	3
S73204NL	1396.85	75	026508337240	3	T933	355.95	324	026508162118	3
S73204ORB	1448.60	75	026508337257	3	T933BN	532.55	324	026508162132	3
S73204BG	1500.35	75	026508337226	3	T933ORB	585.90	324	026508162125	3
S74001	800.00	75	026508374498	3	T935	534.35	264	026508027806	3
S74001SRS	1000.00	75	026508374535	3	T935BL	821.25	264	026508301814	3
S74001BL	1040.00	75	026508374504	3	T936	832.15	264	026508235171	3
S74001EV2C	1111.00	64	026508375372	3	T943	355.95	333	026508153192	3
S74001BG	1160.00	75	026508374542	3	T943BN	532.55	333	026508153208	3
S74001EV2SRS	1233.20	64	026508375396	3	T943ORB	585.90	333	026508153215	3
S74001EV2BL	1277.70	64	026508375402	3	T944	558.90	333	026508153161	3
S74001EV2BG	1333.20	64	026508376133	3	T944BN	708.05	333	026508153178	3
S75005	840.50	74	026508288795	3	T944ORB	778.90	333	026508153185	3
S75005SRS	1050.65	74	026508288818	3	T961	348.40	346	026508272190	3
S75005BL	1092.65	74	026508288801	3	T961BN	506.50	346	026508289877	3
S75005EV2C	1182.35	63	026508356883	3	T961BL	557.10	346	026508289860	3
S75005BLS	1218.75	74	026508300589	3	T990	339.25	363	026508125724	6
S75005EV2SRS	1300.55	63	026508357583	3	T994	209.25	363	026508017173	6
S75005EV2BL	1359.70	63	026508356869	3	T2131	72.55	337	026508153222	3
S75005EV2BLS	1418.75	63	026508356876	3	T2131BN	165.80	337	026508153239	3
S93005	2291.55	174	026508251096	1	T2131ORB	182.25	337	026508153246	3
S93005BL	3032.90	174	026508302316	1	T2132	95.20	337	026508153253	3
SF2143CH	32.55	515	034584038944	10	T2132BN	204.85	337	026508153260	3
SF2143BN	34.90	515	034584038937	10	T2132EPBN	204.85	337	026508209066	3
SF2143BL	38.35	515	034584038920	10	T2132EPORB	225.25	337	026508209073	3
SMA1000CH	40.15	540	034584007728	24	T2132ORB	225.25	337	026508153277	3
SMA1000OWB	43.35	540	034584007735	24	T2133	138.50	336	026508153284	3
SMA1001CH	38.45	540	034584007759	24	T2133BN	270.20	336	026508153291	3
SR2100CH	15.40	517	034584013354	25	T2133EPBN	270.20	336	026508207833	3
SR2100BN	17.65	517	034584013361	25	T2133EPORB	297.25	336	026508207840	3
SR2100OWB	17.90	517	034584013378	25	T2133ORB	297.25	336	026508153307	3
SR2201CH	19.20	517	034584018830	12	T2137EP	170.00	336	026508272411	3
SR2201BN	22.15	517	034584018823	12	T2137EPBN	312.60	336	026508272428	3

Wholesale

Listed in numerical order

SUGGESTED LIST PRICES

MODEL NUMBER	LIST PRICE	PAGE NO.	UNIVERSAL PRODUCT CODE	CASE QTY	MODEL NUMBER	LIST PRICE	PAGE NO.	UNIVERSAL PRODUCT CODE	CASE QTY
T2137EPORB	345.85	336	026508272435	3	T2233EP	190.60	336	026508271407	4
T2138EP	148.15	337	026508326947	3	T2233EPBN	319.35	336	026508271568	4
T2138EPBN	255.45	337	026508326954	3	T2233EPORB	345.85	336	026508271575	4
T2139EP	190.60	336	026508326985	3	T2252EP	148.15	329	026508271391	4
T2139EPBN	319.35	336	026508326992	3	T2252EPBN	255.45	329	026508271582	4
T2151	72.55	329	026508162149	3	T2252EPORB	275.40	329	026508271599	4
T2151BN	165.80	329	026508162163	3	T2253EP	190.60	328	026508271384	4
T2151ORB	182.25	329	026508162156	3	T2253EPBN	319.35	328	026508271605	4
T2152	95.20	329	026508162170	3	T2253EPORB	345.85	328	026508271612	4
T2152BN	204.85	329	026508162194	3	T2261	163.35	293	026508336007	3
T2152EPBN	204.85	329	026508207871	3	T2261BG	296.65	293	026508336014	3
T2152EPORB	225.25	329	026508207888	3	T2261BN	296.65	293	026508336038	3
T2152ORB	225.25	329	026508162187	3	T2261BL	326.45	293	026508336021	3
T2153	138.50	328	026508162200	3	T2262EP	217.70	293	026508336045	4
T2153BN	270.20	328	026508162224	3	T2262EPBG	396.00	293	026508336052	4
T2153EPBN	270.20	328	026508207918	3	T2262EPBN	396.00	293	026508336076	4
T2153EPORB	297.25	328	026508207925	3	T2262EPBL	435.65	293	026508336069	4
T2153ORB	297.25	328	026508162217	3	T2263EP	277.05	293	026508336083	4
T2157EP	170.00	328	026508272442	3	T2263EPBG	503.35	293	026508336090	4
T2157EPBN	312.60	328	026508272459	3	T2263EPBN	503.35	293	026508336113	4
T2157EPORB	345.85	328	026508272466	3	T2263EPBL	553.65	293	026508336106	4
T2181	72.55	314	026508264423	3	T2282EP	148.15	314	026508271438	4
T2181BN	165.80	314	026508264430	3	T2282EPBN	255.45	314	026508271629	4
T2181BL	182.25	314	026508336984	3	T2282EPBL	275.40	314	026508337035	4
T2181ORB	182.25	314	026508264447	3	T2282EPORB	275.40	314	026508271636	4
T2182EP	78.95	314	026508264478	3	T2283EP	190.60	314	026508271421	4
T2182	95.20	314	026508264454	3	T2283EPBN	319.35	314	026508271643	4
T2182BN	204.85	314	026508264461	3	T2283EPBL	345.85	314	026508337042	4
T2182EPBN	204.85	314	026508264485	3	T2283EPORB	345.85	314	026508271650	4
T2182BL	225.25	314	026508336991	3	T2310	296.15	282	026508300145	4
T2182EPBL	225.25	314	026508337004	3	T2310BN	537.75	282	026508300152	4
T2182EPORB	225.25	314	026508264492	3	T2310NL	537.75	282	026508300169	4
T2182ORB	225.25	314	026508264508	3	T2310BL	547.90	282	026508371381	4
T2183EP	118.95	314	026508264539	3	T2310ORB	591.55	282	026508300176	4
T2183	138.50	314	026508264515	3	T2311	164.05	281	026508275429	3
T2183BN	270.20	314	026508264522	3	T2311BN	297.85	281	026508275436	3
T2183EPBN	270.20	314	026508264546	3	T2311NL	297.85	281	026508301418	3
T2183BL	297.25	314	026508337011	3	T2311BL	303.55	281	026508371398	3
T2183EPBL	297.25	314	026508337028	3	T2311ORB	327.60	281	026508275443	3
T2183EPORB	297.25	314	026508264553	3	T2312	218.60	281	026508275450	4
T2183ORB	297.25	314	026508264560	3	T2312EP	218.60	281	026508275474	4
T2190	307.35	260	026508300107	4	T2312BN	397.60	281	026508275467	4
T2190BG	558.00	260	026508300114	4	T2312EPBN	397.60	281	026508275481	4
T2190BN	558.00	260	026508300138	4	T2312EPNL	397.60	281	026508301425	4
T2190BL	613.95	260	026508300121	4	T2312NL	397.60	281	026508301449	4
T2191	170.25	259	026508249680	3	T2312BL	404.40	281	026508371404	4
T2191BG	309.05	259	026508286050	3	T2312EPBL	404.40	281	026508371411	4
T2191BN	309.05	259	026508249178	3	T2312EPORB	437.15	281	026508275498	4
T2191BL	340.05	259	026508275030	3	T2312ORB	437.15	281	026508275535	4
T2192NH	180.50	259	026508249314	3	T2313	277.95	281	026508275542	4
T2192	226.85	259	026508249710	3	T2313EP	277.95	281	026508275566	4
T2192EP	226.85	259	026508249185	3	T2313BN	505.30	281	026508275559	4
T2192NHBG	327.80	259	026508286081	3	T2313EPBN	505.30	281	026508275573	4
T2192NHBN	327.80	259	026508249321	3	T2313EPNL	505.30	281	026508301456	4
T2192NHBL	360.55	259	026508275047	3	T2313NL	505.30	281	026508301470	4
T2192BG	412.60	259	026508286067	3	T2313BL	514.25	281	026508371428	4
T2192BN	412.60	259	026508249727	3	T2313EPBL	514.25	281	026508371435	4
T2192EPBG	412.60	259	026508286074	3	T2313EPORB	556.15	281	026508275580	4
T2192EPBN	412.60	259	026508249192	3	T2313ORB	556.15	281	026508275627	4
T2192BL	453.95	259	026508281888	3	T2470	101.15	360	026508300183	4
T2192EPBL	453.95	259	026508281895	3	T2470BN	146.65	360	026508300206	4
T2193NH	194.40	259	026508249338	3	T2470BL	157.95	360	026508300190	4
T2193EP	288.70	257	026508249208	3	T2471	68.15	359	026508271223	3
T2193	288.70	259	026508249758	3	T2471BN	139.60	359	026508289594	3
T2193NHBG	380.05	259	026508286111	3	T2471BL	153.60	359	026508289587	3
T2193NHBN	380.05	259	026508249345	3	T2472NH	70.40	359	026508271247	3
T2193NHBL	418.15	259	026508275054	3	T2472EP	74.10	359	026508271230	3
T2193EPBG	524.55	257	026508286104	3	T2472NHBN	144.35	359	026508289631	3
T2193EPBN	524.55	257	026508249772	3	T2472EPBN	151.85	359	026508289617	3
T2193BG	524.55	259	026508286098	3	T2472NHBL	158.75	359	026508289624	3
T2193BN	524.55	259	026508249765	3	T2472EPBL	167.10	359	026508289600	3
T2193EPBL	576.90	257	026508281918	3	T2473NH	95.65	359	026508271261	3
T2193BL	576.90	259	026508281901	3	T2473EP	111.50	359	026508271254	3
T2221	170.25	236	026508364413	3	T2473NHBN	190.10	359	026508289679	3
T2221BG	309.05	236	026508364529	3	T2473NHBL	209.15	359	026508289662	3
T2221BN	309.05	236	026508364444	3	T2473EPBN	214.40	359	026508289655	3
T2221BL	340.05	236	026508364406	3	T2473EPBL	235.75	359	026508289648	3
T2222EP	226.85	236	026508364390	3	T2662EP	77.25	343	026508273098	3
T2222EPBG	412.60	236	026508364482	3	T2663EP	116.40	343	026508273111	3
T2222EPBN	412.60	236	026508364499	3	T2690	295.00	306	026508300220	4
T2222EPBL	453.95	236	026508364567	3	T2690BG	535.60	306	026508300237	4
T2223EP	288.70	236	026508364468	3	T2690BN	535.60	306	026508300244	4
T2223EPBG	524.55	236	026508364574	3	T2690NL	535.60	306	026508300251	4
T2223EPBN	524.55	236	026508364345	3	T2690BL	545.65	306	026508373019	4
T2223EPBL	576.90	236	026508364451	3	T2690ORB	589.15	306	026508300268	4
T2232EP	148.15	337	026508271414	4	T2691	163.35	306	026508230282	3
T2232EPBN	255.45	337	026508271544	4	T2691BG	296.65	306	026508286128	3
T2232EPORB	275.40	337	026508271551	4	T2691BN	296.65	306	026508230299	3

Wholesale

Listed in numerical order

MODEL NUMBER	LIST PRICE	PAGE NO.	UNIVERSAL PRODUCT CODE	CASE QTY	MODEL NUMBER	LIST PRICE	PAGE NO.	UNIVERSAL PRODUCT CODE	CASE QTY
T2691NL	296.65	306	026508301487	3	T3002EPBL	258.50	350	026508306024	4
T2691BL	303.65	306	026508372999	3	T3003EP	171.35	350	026508272183	4
T2691ORB	326.45	306	026508230305	3	T3003EPBN	323.00	350	026508289839	4
T2692NH	173.20	305	026508230367	3	T3003EPBL	355.30	350	026508306031	4
T2692	217.70	305	026508230312	3	T3111	188.10	560	026508108017	3
T2692EP	217.70	305	026508230336	3	T3111BN	438.90	560	026508115336	3
T2692NHBN	314.55	305	026508230374	3	T3111ORB	482.85	560	026508132395	3
T2692BG	396.00	305	026508286135	3	T3290	234.20	560	026508294864	3
T2692BN	396.00	305	026508230329	3	T3290BN	314.55	560	026508294888	3
T2692EPBG	396.00	305	026508286142	3	T3290BL	346.05	560	026508294871	3
T2692EPBN	396.00	305	026508230343	3	T3291	201.50	560	026508249819	3
T2692EPNL	396.00	305	026508301494	3	T3291BG	429.20	560	026508286197	3
T2692NL	396.00	305	026508301517	3	T3291BN	429.20	560	026508249826	3
T2692BL	402.75	305	026508372968	3	T3691	193.40	560	026508230497	3
T2692EPBL	402.75	305	026508373033	3	T3691BG	411.90	560	026508285329	3
T2692EPORB	435.55	305	026508230350	3	T3691BN	411.90	560	026508230503	3
T2692ORB	435.55	305	026508230398	3	T3691NL	411.90	560	026508301654	3
T2693NH	186.55	305	026508230459	3	T3691BL	421.65	560	026508372982	3
T2693	277.05	305	026508230404	3	T3691ORB	453.30	560	026508230510	3
T2693EP	277.05	305	026508230428	3	T4111	243.90	560	026508115176	3
T2693NHBN	364.75	305	026508230466	3	T4111BN	327.55	560	026508115558	3
T2693BG	503.35	305	026508286166	3	T4111ORB	360.25	560	026508132425	3
T2693BN	503.35	305	026508230411	3	T4191	156.10	561	026508249253	12
T2693EPBG	503.35	305	026508286173	3	T4191BG	209.75	561	026508285886	12
T2693EPBN	503.35	305	026508230435	3	T4191BN	209.75	561	026508249260	12
T2693EPNL	503.35	305	026508301524	3	T4191BL	230.70	561	026508275061	12
T2693NL	503.35	305	026508301548	3	T4192	154.80	561	026508260326	12
T2693BL	512.50	305	026508373071	3	T4192	154.80	561	026508260326	12
T2693EPBL	512.50	305	026508373026	3	T4192BG	209.75	561	026508285879	12
T2693EPORB	553.95	305	026508230442	3	T4192BN	209.75	561	026508281666	12
T2693ORB	553.95	305	026508230480	3	T4192BL	230.70	561	026508281659	12
T2741	72.55	321	026508261217	3	T4291	309.60	253	026508290668	3
T2741BN	165.80	321	026508261224	3	T4291BG	467.55	253	026508290705	3
T2741BL	182.25	321	026508325544	3	T4291BN	467.55	253	026508290729	3
T2742EP	78.95	321	026508261255	3	T4291BL	503.10	253	026508290712	3
T2742	95.20	321	026508261231	3	T4292	157.60	253	026508290736	6
T2742BN	204.85	321	026508261248	3	T4292BG	237.55	253	026508290743	6
T2742EPBN	204.85	321	026508261262	3	T4292BN	237.55	253	026508290767	6
T2742BL	225.25	321	026508325551	3	T4292BL	256.15	253	026508290750	6
T2742EPBL	225.25	321	026508325568	3	T4311	162.90	561	026508250402	6
T2743EP	118.95	321	026508261293	3	T4311BN	219.00	561	026508250419	6
T2743	138.50	321	026508261279	3	T4311ORB	240.75	561	026508250426	6
T2743BN	270.20	321	026508261286	3	T4401	309.60	230	026508364383	3
T2743EPBN	270.20	321	026508261309	3	T4401BG	467.55	230	026508364376	3
T2743BL	297.25	321	026508325575	3	T4401BN	467.55	230	026508364369	3
T2743EPBL	297.25	321	026508325582	3	T4401BL	503.10	230	026508364536	3
T2810	307.35	271	026508300305	4	T4402	157.60	230	026508364437	6
T2810BL	613.95	271	026508300312	4	T4402BG	237.55	230	026508364475	3
T2811	170.25	270	026508235102	3	T4402BN	237.55	230	026508364505	6
T2811BL	340.00	270	026508301555	3	T4402BL	256.15	230	026508364543	6
T2812NH	180.50	270	026508256671	3	T4411	310.40	275	026508290774	3
T2812	226.85	270	026508235119	3	T4411BN	467.55	275	026508290781	3
T2812EP	226.85	270	026508235126	3	T4411NL	467.55	275	026508290798	3
T2812NHBL	360.55	270	026508301586	3	T4411BL	481.10	275	026508371558	3
T2812BL	453.90	270	026508301562	3	T4411ORB	504.40	275	026508290804	3
T2812EPBL	453.90	270	026508301579	3	T4412	157.60	275	026508290811	6
T2813NH	194.40	270	026508256688	3	T4412BN	237.55	275	026508290828	6
T2813	288.70	270	026508235133	3	T4412NL	237.55	275	026508290835	6
T2813EP	288.70	270	026508235140	3	T4412BL	244.25	275	026508371541	6
T2813NHBL	418.10	270	026508301616	3	T4412ORB	256.15	275	026508290842	6
T2813BL	576.90	270	026508301593	3	T4500	307.35	248	026508300367	4
T2813EPBL	576.90	270	026508301609	3	T4500BN	558.00	248	026508300374	4
T2842EP	148.15	321	026508271452	4	T4500ORB	613.95	248	026508300398	4
T2842EPBN	255.45	321	026508271667	4	T4501	170.25	247	026508253441	3
T2842EPBL	275.40	321	026508325599	4	T4501BN	309.05	247	026508253458	3
T2843EP	190.60	321	026508271445	4	T4501ORB	340.05	247	026508255766	3
T2843EPBN	319.35	321	026508271674	4	T4502	226.85	247	026508253465	3
T2843EPBL	345.85	321	026508325605	4	T4502EP	226.85	247	026508253489	3
T2900	105.55	351	026508300336	4	T4502BN	412.60	247	026508253472	3
T2900BN	153.10	351	026508300350	4	T4502EPBN	412.60	247	026508253496	3
T2900BL	168.45	351	026508300343	4	T4502EPORB	453.80	247	026508255780	3
T2901	71.15	351	026508272121	3	T4502ORB	453.80	247	026508255810	3
T2901BN	146.05	351	026508289693	3	T4503	288.70	247	026508253519	3
T2901BL	160.70	351	026508289686	3	T4503EP	288.70	247	026508253533	3
T2902NH	73.50	350	026508272145	3	T4503BN	524.55	247	026508253526	3
T2902EP	77.25	350	026508272138	3	T4503EPBN	524.55	247	026508253540	3
T2902NHBN	151.05	350	026508289730	3	T4503EPORB	577.20	247	026508255834	3
T2902EPBN	158.85	350	026508289716	3	T4503ORB	577.20	247	026508255872	3
T2902NHBL	166.15	350	026508289723	3	T4520	381.05	239	026508253403	3
T2902EPBL	174.80	350	026508289709	3	T4520BN	560.45	239	026508253700	3
T2903NH	99.65	350	026508272169	3	T4520ORB	597.80	239	026508255919	3
T2903EP	116.40	350	026508272152	3	T4524	388.60	239	026508253717	3
T2903NHBN	198.80	350	026508289778	3	T4524BN	571.50	239	026508253762	3
T2903NHBL	218.70	350	026508289761	3	T4524ORB	609.60	239	026508255933	3
T2903EPBN	219.30	350	026508289754	3	T4611	149.85	561	026508230589	12
T2903EPBL	241.30	350	026508289747	3	T4611BG	201.30	561	026508285862	12
T3002EP	132.35	350	026508272176	4	T4611BN	201.30	561	026508230596	12
T3002EPBN	235.00	350	026508289822	4	T4611NL	201.30	561	026508301715	12

Wholesale

Listed in numerical order

SUGGESTED LIST PRICES

MODEL NUMBER	LIST PRICE	PAGE NO.	UNIVERSAL PRODUCT CODE	CASE QTY	MODEL NUMBER	LIST PRICE	PAGE NO.	UNIVERSAL PRODUCT CODE	CASE QTY
T4611BL	205.95	561	026508371237	12	T6906ORB	627.70	297	026508230695	3
T4611ORB	221.40	561	026508230602	12	T6906BG	647.90	297	026508286265	3
T4612	149.85	561	026508281338	12	T6906BL	675.00	297	026508372210	3
T4612BG	201.30	561	026508286241	12	T6920	377.60	263	026508235157	3
T4612BN	201.30	561	026508281345	12	T6920BL	610.80	263	026508301760	3
T4612NL	201.30	561	026508301722	12	T8342NH	362.90	659	026508237175	1
T4612BL	205.95	561	026508373064	12	T8342	371.85	659	026508228562	1
T4612ORB	221.40	561	026508281352	12	T8342EP15	371.85	659	026508228579	1
T4621	297.05	288	026508336120	3	T8342NHCBN	497.65	659	026508237182	1
T4621BG	448.75	288	026508336137	3	T8342CBN	546.55	659	026508237151	1
T4621BN	448.75	288	026508336151	3	T8342EP15CBN	546.55	659	026508237168	1
T4621BL	482.85	288	026508336144	3	T8343	392.85	657	026508228586	1
T4622	151.25	288	026508336168	6	T8343EP15	392.85	657	026508228593	1
T4622BG	227.95	288	026508336175	6	T8343CBN	577.60	657	026508237199	1
T4622BN	227.95	288	026508336199	6	T8343EP15CBN	577.60	657	026508237625	1
T4622BL	245.80	288	026508336182	6	T8346	343.15	661	026508228609	4
T4691	297.95	299	026508290859	3	T8346EP15	343.15	661	026508228616	4
T4691BG	448.75	299	026508290866	3	T8346CBN	486.55	661	026508235638	4
T4691BN	448.75	299	026508290873	3	T8346EP15CBN	486.55	661	026508235645	4
T4691NL	448.75	299	026508290880	3	T8360	49.60	666	026508222775	3
T4691BL	461.75	299	026508371244	3	T8360CBN	90.60	666	026508235652	3
T4691ORB	484.05	299	026508290897	3	T8370	38.80	664	026508211885	3
T4692	151.25	299	026508290903	6	T8370CBN	70.80	664	026508235669	3
T4692BG	227.95	299	026508290910	6	T8375NH	47.50	663	026508235690	3
T4692BN	227.95	299	026508290927	6	T8375	67.00	663	026508211892	3
T4692NL	227.95	299	026508290934	6	T8375EP15	67.00	663	026508222782	3
T4692BL	234.45	299	026508371251	6	T8375NHCBN	79.35	663	026508235706	3
T4692ORB	245.80	299	026508290941	6	T8389	102.60	662	026508212134	3
T4943	268.60	324	026508162088	3	T8389EP15	102.60	662	026508222799	3
T4943BN	350.70	324	026508162101	3	T8389EP15CBN	160.25	662	026508235720	3
T4943ORB	385.60	324	026508162095	3	T9023	481.30	274	026508275788	3
T5220	471.55	338	026508171769	3	T9023BN	676.35	274	026508275795	3
T5220BN	569.35	338	026508171776	3	T9023NL	676.35	274	026508301791	3
T6142	213.50	345	026508272114	3	T9023BL	697.90	274	026508371374	3
T6142BN	320.25	345	026508289853	3	T9023ORB	734.45	274	026508275801	3
T6142BL	352.20	345	026508289846	3	T9024	654.15	274	026508275818	3
T6173	218.15	316	026508261330	3	T9024BN	921.10	274	026508275825	3
T6173BN	305.40	316	026508261347	3	T9024NL	921.10	274	026508301807	3
T6173BL	327.20	316	026508325629	3	T9024BL	948.45	274	026508372234	3
T6193	377.60	251	026508249857	3	T9024ORB	987.85	274	026508275832	3
T6193BN	573.75	251	026508249291	3	T9342EP15	508.35	658	026508257340	1
T6193BL	592.30	251	026508275078	3	T9342GBM15	559.15	658	026508257388	1
T6193BG	610.80	251	026508286258	3	T9346GBM15	492.60	660	026508255568	1
T6222	362.35	286	026508336205	3	T9360	137.20	666	026508255582	3
T6222BN	525.40	286	026508336236	3	T9370	107.20	664	026508255599	3
T6222BG	579.75	286	026508336212	3	T9375EP15	134.15	663	026508255612	3
T6222BL	579.75	286	026508336229	3	T9389EP15	170.65	662	026508255636	3
T6223	512.75	288	026508336243	3	T62132EP	78.95	337	026508208359	12
T6223BG	716.50	288	026508336250	3	T62132EP	78.95	337	026508208359	12
T6223BN	716.50	288	026508336274	3	T62132	78.95	611	026508152508	12
T6223BL	788.15	288	026508336267	3	T62133EP	118.95	336	026508208373	12
T6405	389.70	273	026508275757	3	T62133EP	118.95	336	026508208373	12
T6405BN	534.90	273	026508275764	3	T62133	118.95	609	026508152515	12
T6405BL	554.00	273	026508371367	3	T62151	58.75	613	026508162026	12
T6405NL	554.00	273	026508301739	3	T62152EP	78.95	329	026508208397	12
T6405ORB	573.10	273	026508275771	3	T62152EP	78.95	329	026508208397	12
T6420	218.15	332	026508153130	3	T62152	78.95	610	026508162033	12
T6420BN	305.40	332	026508153147	3	T62153EP	118.95	328	026508208410	12
T6420ORB	338.15	332	026508153154	3	T62153EP	118.95	328	026508208410	12
T6503	534.35	229	0265083364550	3	T62153	118.95	608	026508162040	12
T6503BG	746.60	229	0265083364512	3	T62182	78.95	610	026508264577	12
T6503BN	746.60	229	0265083364420	3	T62183	118.95	608	026508264584	12
T6503BL	791.20	229	0265083364352	3	T62742	78.95	610	026508261354	12
T6601	310.40	242	026508290958	3	T62743	118.95	608	026508261361	6
T6601BN	467.55	242	026508290965	3	T90331	46.55	466	026508184455	12
T6601ORB	504.40	242	026508290682	3	T90331BG	146.85	466	026508286289	12
T6602	157.60	242	026508290699	6	T90331BN	146.85	466	026508184509	12
T6602BN	237.55	242	026508290972	6	T90331NL	146.85	466	026508184516	12
T6602ORB	256.15	242	026508290996	6	T90331ORB	161.50	466	026508184523	12
T6620	218.15	323	026508162071	3	T90331WR	161.50	466	026508184578	12
T6620BN	305.40	323	026508161012	3	TF3347	328.95	464	026508357095	6
T6620ORB	338.15	323	026508161029	3	TF3347BG	421.05	464	026508357101	6
T6708	179.65	354	026508295687	3	TF3347BN	421.05	464	026508357125	6
T6708BN	242.55	354	026508295700	3	TF3347BL	463.20	464	026508357118	6
T6708BL	260.50	354	026508295694	3	TF3858	229.50	464	026508357132	6
T6805	218.15	310	026508264591	3	TF3858BN	309.80	464	026508357156	6
T6805BN	305.40	310	026508264607	3	TF3858BL	340.85	464	026508357149	6
T6805BL	327.20	310	026508337059	3	TF3858ORB	340.85	464	026508357163	6
T6805ORB	338.15	310	026508264614	3	TF3901	239.15	465	026508357170	6
T6905	362.35	296	026508230640	3	TF3901BN	322.85	465	026508357194	6
T6905BN	532.85	296	026508230657	3	TF3901BL	355.15	465	026508357187	6
T6905NL	550.60	296	026508301746	3	TF4326	367.35	464	026508372388	6
T6905ORB	568.35	296	026508230664	3	TF4326BG	470.15	464	026508372395	6
T6905BG	586.15	296	026508284650	3	TF4326BN	470.15	464	026508372418	6
T6905BL	610.80	296	026508372203	3	TF4326BL	517.25	464	026508372401	6
T6906	413.05	297	026508230671	3	TF191956	341.70	464	026508356937	6
T6906BN	587.20	297	026508230688	3	TF191956BG	437.40	464	026508356944	6
T6906NL	607.45	297	026508301753	3	TF191956BN	437.40	464	026508356951	6

Wholesale

Listed in numerical order

MODEL NUMBER	LIST PRICE	PAGE NO.	UNIVERSAL PRODUCT CODE	CASE QTY	MODEL NUMBER	LIST PRICE	PAGE NO.	UNIVERSAL PRODUCT CODE	CASE QTY
TF191956NL	437.40	464	026508356968	6	TS1422	308.10	454	026508258798	6
TF191956BL	459.15	464	026508371336	6	TS1422BG	417.50	454	026508286296	6
TF191956ORB	481.15	464	026508356975	6	TS1422BN	417.50	454	026508258804	6
TF193371	306.00	464	026508356982	6	TS1422NL	417.50	454	026508258811	6
TF193371BN	391.70	464	026508356999	6	TS1422BL	459.35	454	026508301838	6
TF193371NL	391.70	464	026508357002	6	TS1422ORB	459.35	454	026508258828	6
TF193371BL	411.20	464	026508372173	6	TS2200	533.50	226	026508300404	4
TF193371ORB	430.85	464	026508357019	6	TS2200BN	773.55	226	026508300459	4
TF195386	229.50	465	026508357026	6	TS2200BL	851.00	226	026508300442	4
TF195386BN	309.80	465	026508357040	6	TS2201	255.15	225	026508291283	3
TF195386BL	340.85	465	026508357033	6	TS2201BN	370.05	225	026508291306	3
TF195827	367.35	464	026508357057	6	TS2201BL	407.05	225	026508291290	3
TF195827BG	470.15	464	026508357064	6	TS2202	340.20	225	026508291313	4
TF195827BN	470.15	464	026508357088	6	TS2202EP	340.20	225	026508291344	4
TF195827BL	517.25	464	026508357071	6	TS2202BN	493.25	225	026508291337	4
TFS990	372.30	464	026508357293	6	TS2202EPBN	493.25	225	026508291368	4
TFS990BG	502.60	464	026508357309	6	TS2202BL	542.70	225	026508291320	4
TFS990BN	502.60	464	026508357316	6	TS2202EPBL	542.70	225	026508291351	4
TFS990NL	502.60	464	026508357323	6	TS2203EP	432.60	224	026508291436	4
TFS3836	355.80	464	026508357200	6	TS2203	432.60	225	026508291405	4
TFS3836BN	498.05	464	026508357224	6	TS2203EPBN	627.30	224	026508291450	4
TFS3836BL	547.90	464	026508357217	6	TS2203BN	627.30	225	026508291429	4
TFS3898	355.80	464	026508357231	6	TS2203EPBL	689.90	224	026508291443	4
TFS3898BN	480.30	464	026508357248	6	TS2203BL	689.90	225	026508291412	4
TFS3898BL	498.05	464	026508370933	6	TS2710	495.85	214	026508300466	4
TFS5001	383.55	464	026508358375	6	TS2710BN	918.05	214	026508300473	4
TFS5001BG	517.80	464	026508357255	6	TS2710BL	942.10	214	026508370940	4
TFS5001BN	517.80	464	026508357279	6	TS2711	241.05	213	026508215111	3
TFS5001BL	569.60	464	026508357262	6	TS2711BN	446.35	213	026508216989	3
TL181	45.45	369	026508047620	12	TS2711BL	450.45	213	026508370957	3
TL181	45.45	369	026508047620	12	TS2712EP	321.55	212	026508222218	3
TL182NH	47.45	612	026508208496	12	TS2712	321.55	213	026508215128	3
TL182NH	47.45	612	026508208496	12	TS2712EPBN	595.55	212	026508223413	3
TL182EP	50.05	364	026508208472	12	TS2712BN	595.55	213	026508216996	3
TL182	50.05	368	026508047552	12	TS2712EPBL	610.95	212	026508370971	3
TL182	50.05	368	026508047552	12	TS2712BL	610.95	213	026508370964	3
TL183NH	71.35	609	026508208533	12	TS2713EP	408.70	212	026508222249	3
TL183	81.25	367	026508047590	12	TS2713	408.70	213	026508215135	3
TL183	81.25	367	026508047590	12	TS2713EPBN	757.20	212	026508223437	3
TL183EP	81.25	367	026508208519	12	TS2713BN	757.20	213	026508217009	3
TL183EP	81.25	367	026508208519	12	TS2713EPBL	776.55	212	026508373194	3
TL470	48.25	616	026508047842	12	TS2713BL	776.55	213	026508373187	3
TL471	93.20	615	026508047828	12	TS2911	292.60	191	026508302606	3
TL471EP	93.20	615	026508271056	12	TS2911BG	438.80	191	026508302613	3
TL473	57.55	615	026508047774	12	TS2911BN	438.80	191	026508302620	3
TL473EP	57.55	615	026508271087	12	TS2911NL	438.80	191	026508302637	3
TL2368EP	105.45	368	026508242414	6	TS2912EP	442.85	190	026508302675	4
TL2369EP	128.25	367	026508242421	6	TS2912	442.85	191	026508302644	4
TR1000BN	39.65	516	034584017710	3	TS2912EPBG	664.15	190	026508302682	4
TR1000CH	39.65	516	034584017727	3	TS2912EPBN	664.15	190	026508302699	4
TR1000WB	39.65	516	034584017734	3	TS2912EPNL	664.15	190	026508302705	4
TR1000BL	43.60	516	034584033772	3	TS2912BG	664.15	191	026508302651	4
TR1000BG	71.40	516	034584038791	3	TS2912BN	664.15	191	026508302668	4
TR1032BN	55.75	516	034584029164	3	TS2912NL	664.15	191	026508302750	4
TS913	756.75	207	026508298282	3	TS2913EP	563.15	190	026508302798	4
TS913BN	1059.40	207	026508298299	3	TS2913	563.15	191	026508302767	4
TS913BL	1097.25	207	026508371022	3	TS2913EPBG	844.60	190	026508302804	4
TS914	1178.60	207	026508298305	3	TS2913EPBN	844.60	190	026508302811	4
TS914BN	1977.55	207	026508298312	3	TS2913EPNL	844.60	190	026508302828	4
TS914BL	2003.65	207	026508371039	3	TS2913BG	844.60	191	026508302774	4
TS926	1055.70	185	026508303245	3	TS2913BN	844.60	191	026508302781	4
TS926BG	1530.70	185	026508303252	3	TS2913NL	844.60	191	026508302873	4
TS926BN	1530.70	185	026508303269	3	TS3100	406.20	208	026508223581	3
TS926NL	1530.70	185	026508303276	3	TS3100BN	614.45	208	026508223598	3
TS928	1392.15	185	026508303320	3	TS3100BL	629.60	208	026508370988	3
TS928BG	2018.55	185	026508303337	3	TS3101	429.90	220	026508291498	3
TS928BN	2018.55	185	026508303344	3	TS3101BN	623.25	220	026508291511	3
TS928NL	2018.55	185	026508303351	3	TS3101BL	685.60	220	026508291504	3
TS983	515.50	219	026508291146	3	TS3102	198.40	220	026508291528	6
TS983BN	721.65	219	026508291160	3	TS3102BN	287.75	220	026508291542	6
TS983BL	793.80	219	026508291153	3	TS3102BL	316.45	220	026508291535	6
TS984	803.00	219	026508291177	3	TS3210	410.15	170	026508215715	3
TS984BN	1124.25	219	026508291191	3	TS3210BG	580.15	170	026508286371	3
TS984BL	1236.65	219	026508291184	3	TS3210BN	580.15	170	026508215845	3
TS1320	199.05	454	026508219638	6	TS3210NL	580.15	170	026508231319	3
TS1320BN	280.65	454	026508219645	6	TS3210BL	626.10	170	026508301999	3
TS1320NL	280.65	454	026508250754	6	TS3210ORB	626.10	170	026508215852	3
TS1320ORB	316.80	454	026508219652	6	TS3300	187.55	208	026508223635	6
TS1322	199.05	454	026508219669	6	TS3300BN	250.05	208	026508223642	6
TS1322BG	280.65	454	026508285374	6	TS3300BL	253.10	208	026508370995	6
TS1322BN	280.65	454	026508219676	6	TS3302BL	565.05	53	026508299203	3
TS1322NL	280.65	454	026508250761	6	TS3302TB	565.05	53	026508269930	3
TS1322BL	316.80	454	026508301821	6	TS3304BL	859.30	53	026508299210	3
TS1322ORB	316.80	454	026508219683	6	TS3304TB	859.30	53	026508269947	3
TS1420	308.10	454	026508252543	6	TS3400	663.45	381	026508215173	3
TS1420BN	417.50	454	026508258743	6	TS3400BN	1127.40	381	026508217221	3
TS1420NL	417.50	454	026508258750	6	TS3400ORB	1183.60	381	026508217238	3
TS1420ORB	459.35	454	026508258767	6	TS3411	319.10	383	026508215203	3

Wholesale

Listed in numerical order

SUGGESTED LIST PRICES

MODEL NUMBER	LIST PRICE	PAGE NO.	UNIVERSAL PRODUCT CODE	CASE QTY	MODEL NUMBER	LIST PRICE	PAGE NO.	UNIVERSAL PRODUCT CODE	CASE QTY
TS3411BN	501.30	383	026508217313	3	TS32102BL	1231.60	169	026508299180	3
TS3411ORB	526.50	383	026508217320	3	TS32102EPBL	1231.60	169	026508299173	3
TS3600	164.80	383	026508215258	6	TS32102EPORB	1231.60	169	026508218891	3
TS3600BN	293.15	383	026508217511	6	TS32102ORB	1231.60	169	026508215777	3
TS3600ORB	308.00	383	026508217528	6	TS32104	953.80	169	026508215784	3
TS3661NH	714.40	447	026508266991	3	TS32104EP	953.80	169	026508218914	3
TS3661NHBG	1128.60	447	026508324585	3	TS32104BG	1338.15	169	026508286357	3
TS3661NHBN	1128.60	447	026508279458	3	TS32104BN	1338.15	169	026508215791	3
TS3661NHBL	1190.85	447	026508279441	3	TS32104EPBG	1338.15	169	026508286364	3
TS3661NHORB	1190.85	447	026508279465	3	TS32104EPBN	1338.15	169	026508218921	3
TS4201	410.05	186	026508303009	3	TS32104EPNL	1338.15	169	026508231289	3
TS4201BG	615.05	186	026508303016	3	TS32104NL	1338.15	169	026508231302	3
TS4201BN	615.05	186	026508303023	3	TS32104BL	1443.75	169	026508299159	3
TS4201NL	615.05	186	026508303030	3	TS32104EPBL	1443.75	169	026508299142	3
TS4202	189.20	186	026508303047	6	TS32104EPORB	1443.75	169	026508218938	3
TS4202BG	283.95	186	026508303054	6	TS32104ORB	1443.75	169	026508215838	3
TS4202BN	283.95	186	026508303061	6	TS32110	496.00	163	026508215869	3
TS4202NL	283.95	186	026508303078	6	TS32110BG	730.00	163	026508286388	3
TS4211	369.60	560	026508215302	3	TS32110BN	730.00	163	026508215876	3
TS4211BN	506.05	560	026508217610	3	TS32110NL	730.00	163	026508231326	3
TS4211ORB	533.10	560	026508217627	3	TS32110BL	787.50	163	026508302002	3
TS6721	540.90	205	026508298244	3	TS32110ORB	787.50	163	026508215883	3
TS6721BN	811.35	205	026508298251	3	TS33002	407.80	175	026508242599	3
TS6721BL	838.40	205	026508371008	3	TS33002BL	673.00	175	026508302033	3
TS6731	627.35	206	026508298268	3	TS33003	232.95	175	026508242612	6
TS6731BN	846.90	206	026508298275	3	TS33003BL	373.95	175	026508302040	6
TS6731BL	878.30	206	026508371015	3	TS42108	828.20	159	026508215982	3
TS6925	409.60	217	026508291115	3	TS42108BN	1118.05	159	026508215999	3
TS6925BN	532.50	217	026508291139	3	TS42108BL	1159.45	159	026508302095	3
TS6925BL	573.45	217	026508291122	3	TS42108NL	1200.85	159	026508231364	3
TS6984	613.65	184	026508303160	3	TS42108BG	1242.25	159	026508286425	3
TS6984BN	797.75	184	026508303184	3	TS42108ORB	1242.25	159	026508216002	3
TS6984NL	859.15	184	026508303191	3	TS42112	847.50	160	026508216019	3
TS6984BG	889.80	184	026508303177	3	TS42112BN	1101.70	160	026508216026	3
TS6985	640.40	184	026508303207	3	TS42112BL	1144.10	160	026508302101	3
TS6985BN	832.50	184	026508303221	3	TS42112NL	1186.45	160	026508231371	3
TS6985NL	896.55	184	026508303238	3	TS42112BG	1228.85	160	026508286432	3
TS6985BG	928.55	184	026508303214	3	TS42112ORB	1228.85	160	026508216033	3
TS21104	1774.00	162	026508215623	3	TS42114	828.20	159	026508216040	3
TS21104BG	3087.95	162	026508286319	3	TS42114BN	1118.05	159	026508216057	3
TS21104BN	3087.95	162	026508215630	3	TS42114BL	1159.45	159	026508302118	3
TS21104NL	3087.95	162	026508231227	3	TS42114NL	1200.85	159	026508231388	3
TS21104BL	3331.65	162	026508301852	3	TS42114ORB	1242.25	159	026508216064	3
TS21104ORB	3331.65	162	026508215647	3	TS42114BG	1283.70	159	026508284667	3
TS22000	817.40	181	026508300411	4	TS43002	771.00	173	026508242636	3
TS22000BL	1336.80	181	026508305720	4	TS43002BL	1156.50	173	026508302125	3
TS22001	381.15	180	026508242438	3	TS43003	789.10	173	026508242650	3
TS22001BL	623.60	180	026508301869	3	TS43003BL	1183.65	173	026508281932	3
TS22002EP	742.85	179	026508242476	3	TS44102	534.30	194	026508310601	3
TS22002	742.85	180	026508242452	3	TS44102BN	694.60	194	026508310632	3
TS22002EPBL	1193.40	179	026508301883	3	TS44102BL	748.05	194	026508310625	3
TS22002BL	1193.40	180	026508301876	3	TS44102BG	774.75	194	026508310618	3
TS22003EP	889.35	179	026508242537	3	TS44103	559.80	194	026508310649	3
TS22003	889.35	180	026508242513	3	TS44103BN	727.75	194	026508310670	3
TS22003EPBL	1419.15	179	026508301906	3	TS44103BL	783.75	194	026508310663	3
TS22003BL	1419.15	180	026508301890	3	TS44103BG	811.75	194	026508310656	3
TS22101	1163.60	162	026508215654	3	TS44104	561.10	194	026508310687	3
TS22101BG	1646.90	162	026508291078	3	TS44104BN	729.40	194	026508310717	3
TS22101BN	1646.90	162	026508215661	3	TS44104BL	785.50	194	026508310700	3
TS22101NL	1646.90	162	026508231234	3	TS44104BG	813.55	194	026508310694	3
TS22101BL	1776.85	162	026508301913	3	TS44105	586.60	194	026508310724	3
TS22101ORB	1776.85	162	026508215678	3	TS44105BN	762.55	194	026508310755	3
TS22103	1163.60	162	026508215685	3	TS44105BL	821.20	194	026508310748	3
TS22103BG	1646.90	162	026508286326	3	TS44105BG	850.55	194	026508310731	3
TS22103BN	1646.90	162	026508215692	3	TS44201	279.85	202	026508310809	3
TS22103NL	1646.90	162	026508231241	3	TS44201BG	419.85	202	026508310816	3
TS22103BL	1776.85	162	026508301920	3	TS44201BN	419.85	202	026508310830	3
TS22103ORB	1776.85	162	026508215708	3	TS44201BL	461.80	202	026508310823	3
TS25105	988.30	161	026508251119	3	TS44401	392.20	197	026508311004	3
TS25105BN	1432.85	161	026508251126	3	TS44401BG	588.25	197	026508311011	3
TS25105BL	1482.40	161	026508381069	3	TS44401BN	588.25	197	026508311035	3
TS25105NL	1531.85	161	026508337462	3	TS44401BL	647.15	197	026508311028	3
TS25105ORB	1576.15	161	026508282014	3	TS44402	181.05	197	026508311042	6
TS25105BG	1581.25	161	026508373255	3	TS44402BG	271.65	197	026508311059	6
TS32100	879.40	171	026508300480	4	TS44402BN	271.65	197	026508311073	6
TS32100BG	1243.55	171	026508300497	4	TS44402BL	298.75	197	026508311066	6
TS32100BN	1243.55	171	026508300510	4	TS44503	1009.85	196	026508311080	3
TS32100NL	1243.55	171	026508300527	4	TS44503BG	1464.25	196	026508311097	3
TS32100BL	1342.00	171	026508300503	4	TS44503BN	1464.25	196	026508311110	3
TS32100ORB	1342.00	171	026508300534	4	TS44503BL	1610.65	196	026508311103	3
TS32102	782.20	169	026508215722	3	TS44504	1222.45	196	026508311127	3
TS32102EP	782.20	169	026508218877	3	TS44504BG	1772.65	196	026508311134	3
TS32102BG	1141.70	169	026508286333	3	TS44504BN	1772.65	196	026508311158	3
TS32102BN	1141.70	169	026508215739	3	TS44504BL	1949.95	196	026508311141	3
TS32102EPBG	1141.70	169	026508286340	3	TS44505	1035.85	196	026508311165	3
TS32102EPBN	1141.70	169	026508218884	3	TS44505BG	1490.25	196	026508311172	3
TS32102EPNL	1141.70	169	026508231258	3	TS44505BN	1490.25	196	026508311196	3
TS32102NL	1141.70	169	026508231272	3	TS44505BL	1636.70	196	026508311189	3

Wholesale

Listed in numerical order

MODEL NUMBER	LIST PRICE	PAGE NO.	UNIVERSAL PRODUCT CODE	CASE QTY
TS44506	1248.50	196	026508311202	3
TS44506BG	1798.65	196	026508311219	3
TS44506BN	1798.65	196	026508311233	3
TS44506BL	1975.95	196	026508311226	3
TS50100	408.90	469	026508251133	2
TS50110	332.45	469	026508258231	2
TS50200	613.50	469	026508251140	2
TS50210	498.70	469	026508258248	2
TS52104	257.50	163	026508216071	6
TS52104BG	355.75	163	026508286449	6
TS52104BN	355.75	163	026508216088	6
TS52104NL	355.75	163	026508231395	6
TS52104BL	383.55	163	026508302132	6
TS52104ORB	383.55	163	026508216095	6
TS93003	1024.30	174	026508242735	3
TS93003BL	1629.50	174	026508302149	3
TS93004	1564.00	174	026508242759	3
TS93004BL	3068.20	174	026508302156	3
TV6142	360.30	345	026508378274	3
TV6142BN	467.05	345	026508378298	3
TV6142BL	499.00	345	026508378281	3
TV6173	364.95	316	026508378304	3
TV6173BN	452.20	316	026508378328	3
TV6173BL	474.00	316	026508378311	3
TV6420	364.95	332	026508378359	3
TV6420BN	452.20	332	026508378366	3
TV6420ORB	484.95	332	026508378373	3
TV6507	548.95	228	026508373699	3
TV6507BN	686.20	228	026508373705	3
TV6507BL	741.10	228	026508373729	3
TV6507BG	796.00	228	026508373712	3
TV6620	364.95	323	026508378380	3
TV6620BN	452.20	323	026508378397	3
TV6620ORB	484.95	323	026508378403	3
TV6708	326.45	354	-	3
TV6708BN	389.35	354	026508383100	3
TV6708BL	407.30	354	026508383094	3
TV6805	364.95	310	026508378410	3
TV6805BN	452.20	310	026508378434	3
TV6805BL	474.00	310	026508378427	3
TV6805ORB	484.95	310	026508378441	3
U130CI	72.60	471	026508319390	6
U130CX	72.60	471	026508319413	6
U130X	72.60	471	026508319437	6
U130CIS	104.50	471	026508319406	6
U130CXS	104.50	471	026508319420	6
U130XS	104.50	471	026508319444	6
U140CI	72.60	471	026508319451	6
U140CX	72.60	471	026508319475	6
U140X	72.60	471	026508319536	6
U140V	88.95	471	026508319512	6
U140CIS	104.50	471	026508319468	6
U140CXS	104.50	471	026508319499	6
U140XS	104.50	471	026508319550	6
U140VS	120.85	471	026508319529	6
U231CI	152.70	472	026508319574	6
U231CX	152.70	472	026508319581	6
U231X	152.70	472	026508319598	6
U232CIS	270.70	472	026508319604	6
U232CXS	270.70	472	026508319611	6
U232XS	270.70	472	026508319628	6
U361CI	152.70	472	026508319635	6
U361CX	152.70	472	026508319642	6
U361X	152.70	472	026508319659	6
U362CIS	270.70	472	026508319666	6
U362CXS	270.70	472	026508319673	6
U362XS	270.70	472	026508319680	6
U8350	262.95	665	026508319697	3
UT2011	192.35	333	026508319703	12
UT2011BN	233.65	333	026508319710	12
UT2011ORB	249.70	333	026508319727	12
UT2021	192.35	325	026508319734	12
UT2021BN	233.65	325	026508319741	12
UT2021ORB	249.70	325	026508319758	12
UT2031	192.35	312	026508319765	12
UT2031BN	233.65	312	026508319772	12
UT2031BL	249.70	312	026508337073	12
UT2031ORB	249.70	312	026508319789	12
UT2081	232.25	267	026508319826	12
UT2081BL	306.85	267	026508319833	12
UT2131	181.30	335	026508338094	3
UT2131BN	288.35	335	026508338100	3
UT2131ORB	304.85	335	026508338117	3
UT2132NH	186.25	335	026508338155	3
UT2132EP	190.30	335	026508338124	1
UT2132NHBN	298.25	335	026508338162	3
UT2132NHORB	315.80	335	026508338179	3
UT2132EPBN	327.40	335	026508338131	12

MODEL NUMBER	LIST PRICE	PAGE NO.	UNIVERSAL PRODUCT CODE	CASE QTY
UT2132EPORB	347.80	335	026508338148	12
UT2133NH	213.15	334	026508338216	3
UT2133EP	230.25	334	026508338186	4
UT2133NHBN	329.45	334	026508338223	3
UT2133NHORB	344.05	334	026508338230	3
UT2133EPBN	392.70	334	026508338193	4
UT2133EPORB	419.80	334	026508338209	4
UT2151	181.30	327	026508338247	3
UT2151BN	288.35	327	026508338254	3
UT2151ORB	304.85	327	026508338261	3
UT2152NH	186.25	327	026508338308	3
UT2152EP	190.30	327	026508338278	12
UT2152NHBN	298.25	327	026508338315	3
UT2152NHORB	315.80	327	026508338322	3
UT2152EPBN	327.40	327	026508338285	12
UT2152EPORB	347.80	327	026508338292	12
UT2153NH	224.40	326	026508338360	3
UT2153EP	230.25	326	026508338339	3
UT2153NHBN	318.35	326	026508338377	3
UT2153NHORB	344.05	326	026508338384	3
UT2153EPBN	392.70	326	026508338346	3
UT2153EPORB	419.80	326	026508338353	3
UT181	181.30	313	026508338391	3
UT2181BN	288.35	313	026508338407	3
UT2181BL	304.85	313	026508343258	3
UT2181ORB	304.85	313	026508338414	3
UT2182EP	190.30	313	026508338421	12
UT2182EPBN	327.40	313	026508338438	12
UT2182EPBL	347.80	313	026508343265	12
UT2182EPORB	347.80	313	026508338445	12
UT2183EP	230.25	312	026508338452	12
UT2183EPBN	392.70	312	026508338469	12
UT2183EPBL	419.80	312	026508343272	12
UT2183EPORB	419.80	312	026508338476	12
UT2191	298.90	258	026508338483	3
UT2191BG	437.75	258	026508338490	3
UT2191BN	437.75	258	026508338513	3
UT2191BL	468.75	258	026508338506	3
UT2192NH	309.05	257	026508338568	3
UT2192EP	355.45	257	026508338520	12
UT2192NHBG	456.40	257	026508338575	3
UT2192NHBN	456.40	257	026508338599	3
UT2192NHBL	489.25	257	026508338582	3
UT2192EPBG	541.25	257	026508338537	12
UT2192EPBN	541.25	257	026508338551	12
UT2192EPBL	582.55	257	026508338544	12
UT2193NH	323.10	257	026508338643	3
UT2193EP	417.30	257	026508338605	3
UT2193NHBG	508.75	257	026508338650	3
UT2193NHBN	508.75	257	026508338674	3
UT2193NHBL	546.80	257	026508338667	3
UT2193EPBG	653.20	257	026508338612	3
UT2193EPBN	653.20	257	026508338636	3
UT2193EPBL	705.60	257	026508338629	3
UT2232EP	270.75	335	026508338681	4
UT2232EPBN	378.00	335	026508338698	4
UT2232EPORB	397.90	335	026508338704	4
UT2233EP	313.20	334	026508338711	4
UT2233EPBN	441.95	334	026508338728	4
UT2233EPORB	468.45	334	026508338735	4
UT2252EP	270.75	327	026508338742	4
UT2252EPBN	378.00	327	026508338759	4
UT2252EPORB	397.90	327	026508338766	4
UT2253EP	313.20	326	026508338773	4
UT2253EPBN	441.95	326	026508338780	4
UT2253EPORB	468.45	326	026508338797	4
UT2261	286.80	292	026508336281	3
UT2261BG	420.15	292	026508336298	3
UT2261BN	420.15	292	026508336311	3
UT2261BL	449.85	292	026508336304	3
UT2262EP	341.20	292	026508336328	4
UT2262EPBG	519.50	292	026508336335	4
UT2262EPBN	519.50	292	026508336359	4
UT2262EPBL	559.10	292	026508336342	4
UT2263EP	400.50	292	026508336366	4
UT2263EPBG	626.80	292	026508336373	4
UT2263EPBN	626.80	292	026508336397	4
UT2263EPBL	677.15	292	026508336380	4
UT2282EP	270.75	313	026508338803	4
UT2282EPBN	378.00	313	026508338810	4
UT2282EPBL	397.90	313	026508343289	4
UT2282EPORB	397.90	313	026508338827	4
UT2283EP	313.20	312	026508338834	4
UT2283EPBN	441.95	312	026508338841	4
UT2283EPBL	468.45	312	026508343296	4
UT2283EPORB	468.45	312	026508338858	4
UT2311	292.70	280	026508338865	3
UT2311BN	426.45	280	026508338872	1

Wholesale

Listed in numerical order

SUGGESTED LIST PRICES

MODEL NUMBER	LIST PRICE	PAGE NO.	UNIVERSAL PRODUCT CODE	CASE QTY	MODEL NUMBER	LIST PRICE	PAGE NO.	UNIVERSAL PRODUCT CODE	CASE QTY
UT2311NL	426.45	280	026508338889	3	UT2842EP	270.75	319	026508339695	4
UT2311BL	439.05	280	026508371442	3	UT2842EPBN	378.00	319	026508339718	4
UT2311ORB	456.30	280	026508338896	3	UT2842EPBL	397.90	319	026508339701	4
UT2312EP	347.25	280	026508338902	4	UT2843EP	313.20	319	026508339725	4
UT2312EPBN	526.25	280	026508338919	3	UT2843EPBN	441.95	319	026508339749	4
UT2312EPNL	526.25	280	026508338926	4	UT2843EPBL	468.45	319	026508339732	4
UT2312EPBL	538.25	280	026508371459	4	UT2901	193.65	349	026508339756	3
UT2312EPORB	565.85	280	026508338933	4	UT2901BN	268.60	349	026508339770	3
UT2313EP	406.55	280	026508338940	4	UT2901BL	283.25	349	026508339763	3
UT2313EPBN	634.00	280	026508338957	4	UT2902NH	196.05	349	026508339817	3
UT2313EPNL	634.00	280	026508338964	4	UT2902EP	199.85	349	026508339787	12
UT2313EPORB	684.80	280	026508338971	4	UT2902NHBN	273.60	349	026508339831	3
UT2313EPBL	687.30	280	026508371466	4	UT2902EPBN	281.35	349	026508339800	12
UT2321	298.90	235	026508365021	3	UT2902NHBL	288.75	349	026508339824	3
UT2321BG	437.75	235	026508365199	3	UT2902EPBL	297.30	349	026508339794	12
UT2321BN	437.75	235	026508365045	3	UT2903NH	222.20	348	026508339879	3
UT2321BL	468.75	235	026508365007	3	UT2903EP	238.95	348	026508339848	12
UT2322EP	355.45	235	026508365014	3	UT2903NHBN	321.35	348	026508339893	3
UT2322EPBG	541.25	235	026508365120	3	UT2903NHBL	341.25	348	026508339886	3
UT2322EPBN	541.25	235	026508364949	3	UT2903EPBN	341.80	348	026508339862	12
UT2322EPBL	582.55	235	026508365168	3	UT2903EPBL	363.75	348	026508339855	12
UT2323EP	417.30	235	026508365250	3	UT2921	192.35	347	026508319901	12
UT2323EPBG	653.20	235	026508365076	3	UT2921BN	234.00	347	026508319925	12
UT2323EPBN	653.20	235	026508364987	3	UT2921BL	250.20	347	026508319918	12
UT2323EPBL	705.60	235	026508365281	3	UT3002EP	254.80	349	026508339909	4
UT2401	187.35	356	026508319857	12	UT3002EPBN	357.60	349	026508339923	4
UT2401BN	233.65	356	026508319871	12	UT3002EPBL	381.00	349	026508339916	4
UT2401BL	249.70	356	026508319864	12	UT3003EP	293.95	348	026508339930	4
UT2471	190.65	358	026508339107	3	UT3003EPBN	445.50	348	026508339954	4
UT2471BN	262.15	358	026508339121	3	UT3003EPBL	477.80	348	026508339947	4
UT2471BL	276.15	358	026508339114	3	UT3290	335.50	256	026508319932	4
UT2472NH	193.00	357	026508339169	3	UT3290BG	415.90	256	026508319949	4
UT2472EP	196.65	357	026508339138	12	UT3290BN	415.90	256	026508319963	4
UT2472NHBN	266.95	357	026508339183	3	UT3290BL	457.50	256	026508319956	4
UT2472EPBN	274.40	357	026508339152	12	UT3291	355.00	255	026508319970	3
UT2472NHBL	281.30	357	026508339176	3	UT3291BG	582.75	255	026508319987	3
UT2472EPBL	289.60	357	026508339145	12	UT3291BN	582.75	255	026508320006	3
UT2473NH	218.10	357	026508339220	3	UT3291BL	640.95	255	026508319994	3
UT2473EP	234.10	357	026508339190	12	UT3292	422.45	255	026508320013	4
UT2473NHBN	312.70	357	026508339244	3	UT3292EP	422.45	255	026508320051	4
UT2473NHBL	331.65	357	026508339237	3	UT3292BG	709.90	255	026508320020	4
UT2473EPBN	336.95	357	026508339213	12	UT3292BN	709.90	255	026508320044	4
UT2473EPBL	358.40	357	026508339206	12	UT3292EPBG	709.90	255	026508320068	4
UT2661	193.65	342	026508339251	3	UT3292EPBN	709.90	255	026508320082	4
UT2662NH	196.05	342	026508339275	3	UT3292BL	780.90	255	026508320037	4
UT2662EP	199.85	342	026508339268	1	UT3292EPBL	780.90	255	026508320075	4
UT2663NH	222.20	342	026508339299	3	UT3293	518.50	255	026508320099	4
UT2663EP	238.95	342	026508339282	12	UT3293EP	518.50	255	026508320136	4
UT2691	286.80	304	026508339305	3	UT3293BG	864.05	255	026508320105	4
UT2691BL	418.50	304	026508373002	3	UT3293BN	864.05	255	026508320129	4
UT2691BG	420.15	304	026508339312	3	UT3293EPBG	864.05	255	026508320143	4
UT2691BN	420.15	304	026508339329	3	UT3293EPBN	864.05	255	026508320167	4
UT2691NL	420.15	304	026508339336	3	UT3293BL	950.45	255	026508320112	4
UT2691ORB	449.85	304	026508339343	3	UT3293EPBL	950.45	255	026508320150	4
UT2692EP	341.20	304	026508339350	12	UT3311	327.15	278	026508320174	3
UT2692EPBG	519.50	304	026508339367	12	UT3311BN	558.75	278	026508320181	3
UT2692EPBN	519.50	304	026508339374	12	UT3311NL	558.75	278	026508320198	3
UT2692EPNL	519.50	304	026508339381	12	UT3311BL	572.50	278	026508371497	3
UT2692EPBL	528.80	304	026508373057	12	UT3311ORB	599.20	278	026508320204	3
UT2692EPORB	559.00	304	026508339398	12	UT3312	397.65	277	026508320211	4
UT2693EP	400.50	304	026508339404	3	UT3312EP	397.65	277	026508320235	4
UT2693EPBG	626.80	304	026508339411	3	UT3312BN	657.00	277	026508320228	4
UT2693EPBN	626.80	304	026508339428	3	UT3312EPBN	657.00	277	026508320242	4
UT2693EPNL	626.80	304	026508339435	3	UT3312EPNL	657.00	277	026508320259	4
UT2693EPBL	640.80	304	026508372951	3	UT3312NL	657.00	277	026508320273	4
UT2693EPORB	677.45	304	026508339442	3	UT3312BL	676.00	277	026508371503	4
UT2721	192.35	318	026508319888	12	UT3312EPBL	676.00	277	026508371510	4
UT2721BN	233.65	318	026508319895	12	UT3312EPORB	745.55	277	026508320266	4
UT2721BL	249.70	318	026508337080	12	UT3312ORB	745.55	277	026508320280	4
UT2741	181.30	320	026508339459	3	UT3313	490.95	277	026508320297	4
UT2741BN	288.35	320	026508339473	1	UT3313EP	490.95	277	026508320310	4
UT2741BL	304.85	320	026508339466	3	UT3313BN	828.75	277	026508320303	4
UT2742EP	190.30	319	026508339480	12	UT3313EPBN	828.75	277	026508320327	4
UT2742EPBN	327.40	319	026508339503	12	UT3313EPNL	828.75	277	026508320334	4
UT2742EPBL	347.80	319	026508339497	12	UT3313NL	828.75	277	026508320358	4
UT2743EP	230.25	319	026508339510	3	UT3313BL	840.75	277	026508371534	4
UT2743EPBN	392.70	319	026508339534	3	UT3313EPBL	840.75	277	026508371527	4
UT2743EPBL	419.75	319	026508339527	3	UT3313EPORB	938.45	277	026508320341	4
UT2811	298.90	269	026508339541	3	UT3313ORB	938.45	277	026508320365	4
UT2811BL	468.70	269	026508339558	3	UT3322	335.50	279	026508320372	4
UT2812NH	309.05	268	026508339602	3	UT3322BN	415.90	279	026508320389	4
UT2812EP	355.45	268	026508339572	12	UT3322NL	415.90	279	026508320396	4
UT2812NHBL	489.25	268	026508339619	3	UT3322BL	436.10	279	026508371473	4
UT2812EPBL	582.50	268	026508339589	12	UT3322ORB	447.40	279	026508320402	4
UT2813NH	323.10	268	026508339664	3	UT3331	321.95	291	026508336403	4
UT2813EP	417.30	268	026508339633	12	UT3331BG	399.15	291	026508336410	4
UT2813NHBL	546.70	268	026508339671	3	UT3331BN	399.15	291	026508336434	4
UT2813EPBL	705.60	268	026508339640	12	UT3331BL	439.05	291	026508336427	4

Wholesale

Listed in numerical order

MODEL NUMBER	LIST PRICE	PAGE NO.	UNIVERSAL PRODUCT CODE	CASE QTY
UT3361	340.70	290	026508336441	3
UT3361BG	559.20	290	026508336458	3
UT3361BN	559.20	290	026508336472	3
UT3361BL	615.10	290	026508336465	3
UT3362	405.45	290	026508336489	3
UT3362EP	405.45	290	026508336526	3
UT3362BG	681.30	290	026508336496	3
UT3362BN	681.30	290	026508336519	3
UT3362EPBG	681.30	290	026508336533	3
UT3362EPBN	681.30	290	026508336557	3
UT3362BL	749.45	290	026508336502	3
UT3362EPBL	749.45	290	026508336540	3
UT3363	497.60	290	026508336564	3
UT3363EP	497.60	290	026508336601	3
UT3363BG	829.20	290	026508336571	3
UT3363BN	829.20	290	026508336595	3
UT3363EPBG	829.20	290	026508336618	3
UT3363EPBN	829.20	290	026508336632	3
UT3363BL	912.20	290	026508336588	4
UT3363EPBL	912.20	290	026508336625	3
UT3611	321.90	303	026508320419	4
UT3611BL	359.25	303	026508320433	4
UT3611BG	399.15	303	026508320426	4
UT3611BN	399.15	303	026508320440	4
UT3611NL	399.15	303	026508324738	4
UT3611ORB	429.35	303	026508320457	4
UT3691	340.70	302	026508320464	3
UT3691BG	559.20	302	026508320471	3
UT3691BN	559.20	302	026508320488	3
UT3691NL	559.20	302	026508320495	3
UT3691BL	562.10	302	026508371183	3
UT3691ORB	600.65	302	026508320501	3
UT3692	405.45	301	026508320518	4
UT3692EP	405.45	301	026508320549	4
UT3692BG	681.30	301	026508320525	4
UT3692BN	681.30	301	026508320532	4
UT3692EPBG	681.30	301	026508320556	4
UT3692EPBN	681.30	301	026508320563	4
UT3692EPNL	681.30	301	026508320570	4
UT3692NL	681.30	301	026508320594	4
UT3692BL	689.20	301	026508371190	4
UT3692EPBL	689.20	301	026508371206	4
UT3692EPORB	734.75	301	026508320587	4
UT3692ORB	734.75	301	026508320600	4
UT3693	497.60	301	026508320617	4
UT3693EP	497.60	301	026508320648	4
UT3693BG	829.20	301	026508320624	4
UT3693BN	829.20	301	026508320631	4
UT3693EPBG	829.20	301	026508320655	4
UT3693EPBN	829.20	301	026508320662	4
UT3693EPNL	829.20	301	026508320679	4
UT3693NL	829.20	301	026508320693	4
UT3693BL	845.90	301	026508371213	4
UT3693EPBL	845.90	301	026508371220	4
UT3693EPORB	897.35	301	026508320686	4
UT3693ORB	897.35	301	026508320709	4
UT3811	355.00	266	026508325209	3
UT3811BL	625.75	266	026508325216	3
UT3812EP	422.45	266	026508325230	4
UT3812EPBL	765.55	266	026508325247	4
UT3813EP	518.50	266	026508325261	4
UT3813EPBL	935.05	266	026508325278	4
UT4191	232.25	256	026508320716	12
UT4191BG	285.90	256	026508320723	12
UT4191BN	285.90	256	026508320747	12
UT4191BL	306.80	256	026508320730	12
UT4291	492.70	254	26508347089	3
UT4291BG	720.45	254	26508347096	3
UT4291BN	720.45	254	26508347119	3
UT4291BL	778.65	254	26508347102	3
UT4292EP	560.15	254	26508347126	4
UT4292EPBG	847.60	254	26508347133	4
UT4292EPBN	847.60	254	26508347157	4
UT4292EPBL	918.60	254	26508347140	4
UT4293EP	656.20	254	26508346464	4
UT4293EPBG	1001.75	254	26508347164	4
UT4293EPBN	1001.75	254	26508347188	4
UT4293EPBL	1088.15	254	26508347171	4
UT4301	226.45	279	026508320754	12
UT4301BN	278.20	279	026508320761	12
UT4301NL	278.20	279	026508320778	12
UT4301BL	283.05	279	026508371480	12
UT4301ORB	298.30	279	026508320785	12
UT4311	464.85	276	26508347195	3
UT4311BN	696.45	276	26508347201	3
UT4311NL	696.45	276	26508347218	3
UT4311BL	709.15	276	26508371565	3
UT4311ORB	736.90	276	26508347225	3

MODEL NUMBER	LIST PRICE	PAGE NO.	UNIVERSAL PRODUCT CODE	CASE QTY
UT4312EP	535.35	276	26508347232	4
UT4312EPBN	794.70	276	26508347249	4
UT4312EPNL	794.70	276	26508347256	4
UT4312EPBL	813.70	276	26508371572	4
UT4312EPORB	883.25	276	26508347263	4
UT4313EP	628.65	276	26508347270	4
UT4313EPBN	966.45	276	26508347287	4
UT4313EPNL	966.45	276	26508347294	4
UT4313EPBL	996.80	276	26508372128	4
UT4313EPORB	1076.15	276	26508347300	4
UT4321	492.70	231	26508364956	3
UT4321BG	720.45	231	26508365274	3
UT4321BN	720.45	231	26508365366	3
UT4321BL	778.65	231	26508365359	3
UT4322EP	560.15	231	26508365373	4
UT4322EPBG	847.60	231	26508365311	4
UT4322EPBN	847.60	231	26508364994	4
UT4322EPBL	918.60	231	26508365380	4
UT4323EP	656.20	231	26508365397	4
UT4323EPBG	1001.75	231	26508365144	4
UT4323EPBN	1001.75	231	26508365052	4
UT4323EPBL	1088.15	231	26508365403	4
UT4361	478.40	289	26508359471	3
UT4361BG	696.90	289	26508359488	3
UT4361BN	696.90	289	26508359501	3
UT4361BL	752.80	289	26508359495	3
UT4362EP	543.15	289	26508359518	3
UT4362EPBG	819.00	289	26508359525	3
UT4362EPBN	819.00	289	26508359549	3
UT4362EPBL	887.15	289	26508359532	3
UT4363EP	635.30	289	26508359556	3
UT4363EPBG	966.90	289	26508359563	3
UT4363EPBN	966.90	289	26508359587	3
UT4363EPBL	1049.90	289	26508359570	3
UT4511	232.25	245	026508320792	12
UT4511BN	285.90	245	026508320808	12
UT4511ORB	306.80	245	026508320822	12
UT4611	222.85	303	026508320839	12
UT4611BL	273.85	303	026508372975	12
UT4611BG	274.35	303	026508320846	12
UT4611BN	274.35	303	026508320853	12
UT4611NL	274.35	303	026508320860	12
UT4611ORB	294.40	303	026508320877	12
UT4620	222.85	291	026508336649	12
UT4620BG	274.35	291	026508336656	12
UT4620BN	274.35	291	026508336670	12
UT4620BL	294.40	291	026508336663	12
UT4691	478.40	300	26508348383	3
UT4691BL	696.40	300	26508371268	3
UT4691BG	696.90	300	26508348390	3
UT4691BN	696.90	300	26508348406	3
UT4691NL	696.90	300	26508348413	3
UT4691ORB	738.35	300	26508348420	3
UT4692EP	543.15	300	26508348437	4
UT4692EPBG	819.00	300	26508348444	4
UT4692EPBN	819.00	300	26508348451	4
UT4692EPNL	819.00	300	26508348468	4
UT4692EPBL	826.90	300	26508371275	4
UT4692EPORB	872.45	300	26508348475	4
UT4693EP	635.30	300	26508348482	4
UT4693EPBG	966.90	300	26508348499	4
UT4693EPBN	966.90	300	26508348505	4
UT4693EPNL	966.90	300	26508348512	4
UT4693EPBL	983.60	300	026508371282	4
UT4693EPORB	1035.05	300	26508348529	4
UT4811	492.70	265	26508348536	3
UT4811BL	763.45	265	26508348543	3
UT4812EP	560.15	265	26508348567	4
UT4812EPBL	903.25	265	26508348574	4
UT4813EP	656.20	265	26508348598	4
UT4813EPBL	1072.75	265	26508348604	4
UT5500	327.30	245	026508320884	4
UT5500BN	415.90	245	026508320891	4
UT5500ORB	447.40	245	026508320914	4
UT6501	232.25	234	026508364888	12
UT6501BG	285.90	234	026508364895	12
UT6501BN	285.90	234	026508364918	12
UT6501BL	306.80	234	026508364901	12
UT8350	195.40	665	026508321126	3
UT8350CBN	250.75	665	026508321133	3
UT24501	298.90	246	026508338988	3
UT24501BN	437.75	246	026508338995	3
UT24501ORB	468.75	246	026508339015	3
UT24502EP	355.45	246	026508339022	3
UT24502EPBN	541.25	246	026508339039	3
UT24502EPORB	582.45	246	026508339052	3
UT24503EP	417.30	246	026508339060	3
UT24503EPBN	653.20	246	026508339077	3

Wholesale

Listed in numerical order

MODEL NUMBER	LIST PRICE	PAGE NO.	UNIVERSAL PRODUCT CODE	CASE QTY
UT24503EPORB	705.90	246	026508339091	3
UT33321	355.00	233	026508365243	3
UT33321BG	582.75	233	026508365113	3
UT33321BN	582.75	233	026508365298	3
UT33321BL	640.95	233	026508365212	3
UT33322	422.45	232	026508365328	4
UT33322EP	422.45	232	026508365236	4
UT33322BG	709.90	232	026508365304	4
UT33322BN	709.90	232	026508365090	4
UT33322EPBG	709.90	232	026508365083	4
UT33322EPBN	709.90	232	026508365267	4
UT33322BL	780.90	232	026508365069	4
UT33322EPBL	780.90	232	026508364963	4
UT33323	518.50	232	026508365137	4
UT33323EP	518.50	232	026508365229	4
UT33323BG	864.05	232	026508365335	4
UT33323BN	864.05	232	026508365205	4
UT33323EPBG	864.05	232	026508365175	3
UT33323EPBN	864.05	232	026508364970	4
UT33323BL	950.45	232	026508364932	4
UT33323EPBL	950.45	232	026508365182	4
UT33341	335.50	233	026508365038	4
UT33341BG	415.90	233	026508365342	4
UT33341BN	415.90	233	026508365151	4
UT33341BL	457.50	233	026508365106	4
UT35501	355.00	244	026508323014	3
UT35501BN	582.75	244	026508323021	3
UT35501ORB	625.75	244	026508323045	3
UT35502	422.45	244	026508323052	4
UT35502EP	422.45	244	026508323076	4
UT35502BN	709.90	244	026508323069	4
UT35502EPBN	709.90	244	026508323083	4
UT35502EPORB	765.55	244	026508323106	4
UT35502ORB	765.55	244	026508323120	4
UT35503	518.50	244	026508323137	4
UT35503EP	518.50	244	026508323151	4
UT35503BN	864.05	244	026508323144	4
UT35503EPBN	864.05	244	026508323168	4
UT35503EPORB	935.05	244	026508323182	4
UT35503ORB	935.05	244	026508323205	4
UT45501	467.95	243	26508348260	3
UT45501BN	679.80	243	26508348277	3
UT45501ORB	763.45	243	26508348291	3
UT45502EP	530.65	243	26508348307	4
UT45502EPBN	798.10	243	26508348314	4
UT45502EPORB	903.25	243	26508348338	4
UT45503EP	620.05	243	26508348345	4
UT45503EPBN	941.45	243	26508348352	4
UT45503EPORB	1072.75	243	26508348376	4
UTL170	207.20	606	026508321140	3
UTL171	213.40	606	026508321157	12
UTL171EP	213.40	606	026508321164	12
UTL172	256.50	606	026508321171	12
UTL172EP	256.50	606	026508321188	12
UTL181	156.35	365	026508339961	3
UTL182NH	158.25	364	026508340004	12
UTL182EP	160.90	364	026508339985	12
UTL183NH	182.15	364	026508340035	12
UTL183EP	192.05	364	026508340011	12
UTS2201	409.15	224	026508340134	3
UTS2201BN	524.15	224	026508340158	3
UTS2201BL	561.05	224	026508340141	3
UTS2202EP	494.30	224	026508340165	4
UTS2202EPBN	647.30	224	026508340189	4
UTS2202EPBL	696.70	224	026508340172	4
UTS2203EP	586.65	224	026508340196	4
UTS2203EPBN	781.30	224	026508340219	4
UTS2203EPBL	843.90	224	026508340202	4
UTS2411	518.80	189	026508321232	4
UTS2411BG	752.25	189	026508321249	4
UTS2411BN	752.25	189	026508321256	4
UTS2411NL	752.25	189	026508321263	4
UTS2611	453.15	223	026508321270	4
UTS2611BN	657.05	223	026508321294	4
UTS2611BL	722.70	223	026508321287	4
UTS2711	387.75	212	026508340523	3
UTS2711BN	593.05	212	026508340530	3
UTS2711BL	598.50	212	026508371046	3
UTS2712EP	468.25	212	026508340547	4
UTS2712EPBN	742.25	212	026508340554	4
UTS2712EPBL	772.60	212	026508371053	4
UTS2713EP	555.45	212	026508340561	4
UTS2713EPBN	903.85	212	026508340578	4
UTS2713EPBL	916.50	212	026508371060	4
UTS2911	446.60	190	026508340615	3
UTS2911BG	592.95	190	026508340622	3
UTS2911BN	592.95	190	026508340639	3
UTS2911NL	592.95	190	026508340646	3

MODEL NUMBER	LIST PRICE	PAGE NO.	UNIVERSAL PRODUCT CODE	CASE QTY
UTS2912EP	596.85	190	026508340653	4
UTS2912EPBG	818.30	190	026508340660	4
UTS2912EPBN	818.30	190	026508340677	4
UTS2912EPNL	818.30	190	026508340684	4
UTS2913EP	717.15	190	026508340691	4
UTS2913EPBG	998.70	190	026508340707	4
UTS2913EPBN	998.70	190	026508340714	4
UTS2913EPNL	998.70	190	026508340721	4
UTS3201	460.55	222	026508321461	3
UTS3201BN	580.70	222	026508321485	3
UTS3201BL	619.45	222	026508321478	3
UTS3202	555.25	222	026508321492	4
UTS3202EP	555.25	222	026508321522	4
UTS3202BN	740.75	222	026508321515	4
UTS3202EPBN	740.75	222	026508321546	4
UTS3202BL	835.90	222	026508321508	4
UTS3202EPBL	835.90	222	026508321539	4
UTS3203	658.75	222	026508321553	4
UTS3203EP	658.75	222	026508321584	4
UTS3203BN	906.65	222	026508321577	4
UTS3203EPBN	906.65	222	026508321607	4
UTS3203BL	1022.15	222	026508321560	4
UTS3203EPBL	1022.15	222	026508321591	4
UTS3311	513.15	178	026508321973	4
UTS3311BL	1116.85	178	026508321980	4
UTS3711	443.90	210	026508322000	3
UTS3711BN	830.60	210	026508322017	3
UTS3711BL	843.40	210	026508371077	3
UTS3713	654.25	210	026508322024	4
UTS3713EP	654.25	210	026508322048	4
UTS3713BN	1253.90	210	026508322031	4
UTS3713EPBN	1253.90	210	026508322055	4
UTS3713BL	1275.75	210	026508371084	4
UTS3713EPBL	1275.75	210	026508371091	4
UTS3715	530.50	210	026508322062	4
UTS3715EP	530.50	210	026508322086	4
UTS3715BN	1022.05	210	026508322079	4
UTS3715EPBN	1022.05	210	026508322093	4
UTS3715BL	1034.50	210	026508371107	4
UTS3715EPBL	1034.50	210	026508371114	4
UTS3911	556.10	188	026508322109	3
UTS3911BG	737.50	188	026508322116	3
UTS3911BN	737.50	188	026508322123	3
UTS3911NL	737.50	188	026508322130	3
UTS3912	661.45	188	026508322147	4
UTS3912EP	661.45	188	026508322178	4
UTS3912BG	915.15	188	026508322154	4
UTS3912BN	915.15	188	026508322161	4
UTS3912EPBG	915.15	188	026508322185	4
UTS3912EPBN	915.15	188	026508322192	4
UTS3912EPNL	915.15	188	026508322208	4
UTS3912NL	915.15	188	026508322215	4
UTS3913	788.40	188	026508322222	4
UTS3913EP	788.40	188	026508322253	4
UTS3913BG	1118.50	188	026508322239	4
UTS3913BN	1118.50	188	026508322246	4
UTS3913EPBG	1118.50	188	026508322260	4
UTS3913EPBN	1118.50	188	026508322277	4
UTS3913EPNL	1118.50	188	026508322284	4
UTS3913NL	1118.50	188	026508322291	4
UTS4172	303.45	211	026508322307	12
UTS4172BN	377.80	211	026508322314	12
UTS4172BL	394.50	211	026508371121	12
UTS4201	598.25	221	26508348710	3
UTS4201BN	718.40	221	26508348734	3
UTS4201BL	757.15	221	26508348727	3
UTS4202EP	692.95	221	26508348741	4
UTS4202EPBN	878.50	221	26508348765	4
UTS4202EPBL	973.60	221	26508348758	4
UTS4203EP	796.45	221	26508348772	4
UTS4203EPBN	1044.35	221	26508348796	4
UTS4203EPBL	1159.85	221	26508348789	4
UTS4311	753.45	166	026508322321	4
UTS4311BG	1092.50	166	026508322338	4
UTS4311BN	1092.50	166	026508322352	4
UTS4311NL	1092.50	166	026508322369	4
UTS4311BL	1201.75	166	026508322345	4
UTS4311ORB	1201.75	166	026508322376	4
UTS4711	581.60	209	26508347317	3
UTS4711BN	968.30	209	26508349106	4
UTS4711BL	981.10	209	26508371138	3
UTS4713EP	791.95	209	26508349113	4
UTS4713EPBN	1391.60	209	26508349120	4
UTS4713EPBL	1413.45	209	026508371145	4
UTS4715EP	668.20	209	26508349137	4
UTS4715EPBN	1159.75	209	26508349144	4
UTS4715EPBL	1172.20	209	26508371152	4
UTS4910	693.80	187	26508349182	3

Wholesale

Listed in numerical order

MODEL NUMBER	LIST PRICE	PAGE NO.	UNIVERSAL PRODUCT CODE	CASE QTY
UTS4910BG	875.20	187	26508349199	3
UTS4910BN	875.20	187	26508349205	3
UTS4910NL	875.20	187	26508349212	3
UTS4911	337.30	189	026508322581	12
UTS4911BG	458.10	189	026508322598	12
UTS4911BN	458.10	189	026508322604	12
UTS4911NL	458.10	189	026508322611	12
UTS4912EP	799.15	187	26508349229	4
UTS4912EPBG	1052.85	187	26508349236	4
UTS4912EPBN	1052.85	187	26508349243	4
UTS4912EPNL	1052.85	187	26508349250	4
UTS4913EP	926.10	187	26508349267	4
UTS4913EPBG	1256.20	187	26508349274	4
UTS4913EPBN	1256.20	187	26508349281	4
UTS4913EPNL	1256.20	187	26508349298	4
UTS9011	428.80	211	026508322628	4
UTS9011BN	620.85	211	026508322635	4
UTS9011BL	643.20	211	026508371169	4
UTS9204	320.40	223	026508322642	12
UTS9204BN	421.40	223	026508322666	12
UTS9204BL	454.00	223	026508322659	12
UTS9211	495.40	200	026508322673	4
UTS9211BG	718.40	200	026508322680	4
UTS9211BN	718.40	200	026508322703	4
UTS9211BL	790.20	200	026508322697	4
UTS9381	322.20	200	026508322710	12
UTS9381BG	437.45	200	026508322727	12
UTS9381BN	437.45	200	026508322741	12
UTS9381BL	481.20	200	026508322734	12
UTS22001	496.20	179	026508340042	3
UTS22001BL	738.55	179	026508340059	3
UTS22002EP	857.85	179	026508340073	3
UTS22002EPBL	1308.40	179	026508340080	3
UTS22003EP	1004.35	179	026508340103	3
UTS22003EPBL	1534.15	179	026508340110	3
UTS23005	442.90	178	026508321201	12
UTS23005BL	568.85	178	026508321218	12
UTS23210	525.10	168	026508340226	3
UTS23210BG	695.15	168	026508340356	3
UTS23210BN	695.15	168	026508340370	3
UTS23210NL	695.15	168	026508340387	3
UTS23210BL	741.05	168	026508340363	3
UTS23210ORB	741.05	168	026508340394	3
UTS32001	578.95	177	026508321317	3
UTS32001BL	825.35	177	026508321324	3
UTS32002	906.45	177	026508321348	3
UTS32002EP	906.45	177	026508321379	3
UTS32002BL	1403.55	177	026508321355	3
UTS32002EPBL	1403.55	177	026508321386	3
UTS32003	1026.45	177	026508321409	3
UTS32003EP	1026.45	177	026508321430	3
UTS32003BL	1609.00	177	026508321416	4
UTS32003EPBL	1609.00	177	026508321447	3
UTS32205	469.15	167	026508321614	12
UTS32205BG	536.10	167	026508321621	12
UTS32205BN	536.10	167	026508321645	12
UTS32205NL	536.10	167	026508321652	12
UTS32205BL	570.70	167	026508321638	12
UTS32205ORB	570.70	167	026508321669	12
UTS33101	628.05	166	026508321676	3
UTS33101BG	806.20	166	026508321683	3
UTS33101BN	806.20	166	026508321706	3
UTS33101NL	806.20	166	026508321713	3
UTS33101BL	855.25	166	026508321690	3
UTS33101ORB	855.25	166	026508321720	3
UTS33102	940.65	165	026508321737	3
UTS33102EP	940.65	165	026508321775	3
UTS33102BG	1306.45	165	026508321744	3
UTS33102BN	1306.45	165	026508321768	3
UTS33102EPBG	1306.45	165	026508321782	3
UTS33102EPBN	1306.45	165	026508321805	3
UTS33102EPNL	1306.45	165	026508321812	3
UTS33102NL	1306.45	165	026508321836	3
UTS33102BL	1436.90	165	026508321751	3
UTS33102EPBL	1436.90	165	026508321799	3
UTS33102EPORB	1436.90	165	026508321829	3
UTS33102ORB	1436.90	165	026508321843	3
UTS33103	1078.20	165	026508321850	3
UTS33103EP	1078.20	165	026508321898	3
UTS33103BG	1478.80	165	026508321867	3
UTS33103BN	1478.80	165	026508321881	3
UTS33103EPBG	1478.80	165	026508321904	3
UTS33103EPBN	1478.80	165	026508321928	3
UTS33103EPNL	1478.80	165	026508321935	3
UTS33103NL	1478.80	165	026508321959	3
UTS33103BL	1628.80	165	026508321874	3
UTS33103EPBL	1628.80	165	026508321911	3
UTS33103EPORB	1628.80	165	026508321942	3

MODEL NUMBER	LIST PRICE	PAGE NO.	UNIVERSAL PRODUCT CODE	CASE QTY
UTS33103ORB	1628.80	165	026508321966	3
UTS42001	716.65	176	26508348628	3
UTS42001BL	963.05	176	26508348635	3
UTS42002EP	1044.15	176	26508348659	3
UTS42002EPBL	1541.25	176	26508348666	3
UTS42003EP	1164.15	176	26508348680	3
UTS42003EPBL	1746.70	176	26508348697	3
UTS43101	765.75	164	26508348802	3
UTS43101BG	943.90	164	26508348819	3
UTS43101BN	943.90	164	26508348833	3
UTS43101NL	943.90	164	26508348840	3
UTS43101BL	992.95	164	26508348826	3
UTS43101ORB	992.95	164	26508348857	3
UTS43102EP	1078.35	164	26508348864	3
UTS43102EPBG	1444.15	164	26508348871	3
UTS43102EPBN	1444.15	164	26508348895	3
UTS43102EPNL	1444.15	164	26508348901	3
UTS43102EPBL	1574.65	164	26508348888	3
UTS43102EPORB	1574.65	164	26508348918	3
UTS43103EP	1215.90	164	26508348925	3
UTS43103EPBG	1616.50	164	26508348932	3
UTS43103EPBN	1616.50	164	26508348956	3
UTS43103EPNL	1616.50	164	26508348963	3
UTS43103EPBL	1766.50	164	26508348949	3
UTS43103EPORB	1766.50	164	26508348970	3
UTS232102EP	897.25	168	026508340233	3
UTS232102EPBG	1256.80	168	026508340240	3
UTS232102EPBN	1256.80	168	026508340264	3
UTS232102EPNL	1256.80	168	026508340271	3
UTS232102EPBL	1346.60	168	026508340257	3
UTS232102EPORB	1346.60	168	026508340288	3
UTS232104EP	1068.75	168	026508340295	3
UTS232104EPBG	1453.15	168	026508340301	3
UTS232104EPBN	1453.15	168	026508340325	3
UTS232104EPNL	1453.15	168	026508340332	3
UTS232104EPBL	1558.80	168	026508340318	3
UTS232104EPORB	1558.80	168	026508340349	3
UTS244201	433.85	201	026508340400	3
UTS244201BG	573.85	201	026508340417	3
UTS244201BN	573.85	201	026508340431	3
UTS244201BL	615.85	201	026508340424	3
UTS244202EP	577.65	201	026508340448	3
UTS244202EPBG	789.40	201	026508340455	3
UTS244202EPBN	789.40	201	026508340479	3
UTS244202EPBL	852.85	201	026508340462	3
UTS244203EP	692.65	201	026508340486	3
UTS244203EPBG	961.95	201	026508340493	3
UTS244203EPBN	961.95	201	026508340516	3
UTS244203EPBL	1042.75	201	026508340509	3
UTS344301	531.05	199	026508323212	3
UTS344301BG	704.30	199	026508323229	3
UTS344301BN	704.30	199	026508323243	3
UTS344301BL	774.70	199	026508323236	3
UTS344302	631.75	199	026508323250	3
UTS344302EP	631.75	199	026508323298	3
UTS344302BG	873.90	199	026508323267	3
UTS344302BN	873.90	199	026508323281	3
UTS344302EPBG	873.90	199	026508323304	3
UTS344302EPBN	873.90	199	026508323328	3
UTS344302BL	961.35	199	026508323274	3
UTS344302EPBL	961.35	199	026508323311	3
UTS344303	752.90	199	026508323335	3
UTS344303EP	752.90	199	026508323373	3
UTS344303BG	1068.20	199	026508323342	3
UTS344303BN	1068.20	199	026508323366	3
UTS344303EPBG	1068.20	199	026508323380	3
UTS344303EPBN	1068.20	199	026508323403	3
UTS344303BL	1175.00	199	026508323359	3
UTS344303EPBL	1175.00	199	026508323397	3
UTS444301	624.90	198	26508348987	3
UTS444301BG	783.85	198	26508348994	3
UTS444301BN	783.85	198	26508349014	3
UTS444301BL	848.45	198	26508349007	3
UTS444302EP	717.25	198	26508349021	3
UTS444302EPBG	939.40	198	26508349038	3
UTS444302EPBN	939.40	198	26508349052	3
UTS444302EPBL	1019.70	198	26508349045	3
UTS444303EP	828.45	198	26508349069	3
UTS444303EPBG	1117.70	198	26508349076	3
UTS444303EPBN	1117.70	198	26508349090	3
UTS444303EPBL	1215.70	198	26508349083	3
WIACC001G1USA	81.50	57	026508365984	1
WICNT008G1USA	292.60	57	026508366059	1
WICNT016T1USA	382.00	57	026508366011	1
WICNT016G1USA	382.00	57	026508366011	1
WISNS002G1USA	113.70	57	026508365991	3
WMV130CIS	154.05	469	026508353134	6
WMV130CXS	154.05	469	026508353141	6

Wholesale

Listed in numerical order

SUGGESTED LIST PRICES

MODEL NUMBER	LIST PRICE	PAGE NO.	UNIVERSAL PRODUCT CODE	CASE QTY	MODEL NUMBER	LIST PRICE	PAGE NO.	UNIVERSAL PRODUCT CODE	CASE QTY
WMV130XS	154.05	469	026508353158	6	YB0208BN	123.25	227	034584028433	6
WT371	443.70	317	026508353059	3	YB0208BL	135.55	227	034584028426	6
WT371BN	585.70	317	026508353172	3	YB0218CH	131.40	227	034584028471	6
WT371BL	644.25	317	026508353165	3	YB0218BN	141.95	227	034584028464	6
WT391	734.65	251	026508353189	3	YB0218BL	156.05	227	034584028457	6
WT391BG	984.45	251	026508353196	3	YB0224CH	136.10	227	034584028501	6
WT391BN	984.45	251	026508353219	3	YB0224BN	147.15	227	034584028495	6
WT391BL	1082.85	251	026508353202	3	YB0224BL	161.95	227	034584028488	6
WT621	734.65	229	026508372425	3	YB0275CH	81.70	227	034584028303	6
WT621BG	984.45	229	026508372432	3	YB0275BN	89.90	227	034584028297	6
WT621BN	984.45	229	026508372456	3	YB0275BL	99.40	227	034584028280	6
WT621BL	1082.85	229	026508372449	3	YB0286CH	91.75	227	034584028891	6
WT681	443.70	311	026508353264	3	YB0286BN	99.00	227	034584028884	6
WT681BN	585.70	311	026508353288	3	YB0286BL	108.90	227	034584028877	6
WT681BL	644.25	311	026508353271	3	YB0301CH	92.40	192	034584031570	24
WT681ORB	644.25	311	026508353295	3	YB0301BN	120.10	192	034584031587	24
WT691	663.00	298	026508353066	3	YB0301NL	132.15	192	034584031594	24
WT691BG	914.95	298	026508353301	3	YB0301BG	144.20	192	034584031648	24
WT691BN	914.95	298	026508353318	3	YB0303CH	70.85	192	034584031631	24
WT691NL	914.95	298	026508353325	3	YB0303BN	92.15	192	034584031624	24
WT691BL	962.15	298	026508371305	3	YB0303NL	101.30	192	034584031600	24
WT691ORB	1006.45	298	026508353332	3	YB0303BG	110.55	192	034584031617	24
WT901	483.60	355	026508353349	3	YB0305CH	18.60	192	034584031679	48
WT901BN	619.00	355	026508353363	3	YB0305NL	20.50	192	034584031686	48
WT901BL	680.90	355	026508353356	3	YB0305BN	24.25	192	034584031662	48
WT961	483.60	346	026508353417	3	YB0305BG	29.05	192	034584031655	48
WT961BN	628.70	346	026508353431	3	YB0307CH	37.35	192	034584031716	48
WT961BL	691.55	346	026508353424	3	YB0307BN	48.60	192	034584031709	48
WT6221	712.75	287	026508353226	3	YB0307NL	53.45	192	034584031723	48
WT6221BG	962.15	287	026508353233	3	YB0307BG	58.35	192	034584031693	48
WT6221BN	962.15	287	026508353257	3	YB0308CH	130.35	192	034584031167	6
WT6221BL	1058.40	287	026508353240	3	YB0308BN	169.35	192	034584031150	6
WT9021	642.60	274	026508353370	3	YB0308NL	186.35	192	034584031174	6
WT9021BN	893.20	274	026508353387	3	YB0308BG	203.35	192	034584031730	6
WT9021NL	893.20	274	026508353394	3	YB0318CH	150.00	192	034584031204	6
WT9021BL	932.60	274	026508372142	3	YB0318BN	194.85	192	034584031198	6
WT9021ORB	982.55	274	026508353400	3	YB0318NL	214.35	192	034584031211	6
WTS911	806.05	207	026508353073	3	YB0318BG	233.95	192	034584031181	6
WTS911BN	1136.55	207	026508353486	3	YB0322CH	145.40	192	034584031242	6
WTS911BL	1168.75	207	026508371176	3	YB0322BN	188.95	192	034584031235	6
WTS921	816.00	185	026508353493	3	YB0322NL	208.00	192	034584031259	6
WTS921BG	1142.40	185	026508353509	3	YB0322BG	226.90	192	034584031228	6
WTS921NL	1142.40	185	026508353523	3	YB0324CH	155.15	192	034584031280	6
WTS921BN	1245.20	185	026508353516	3	YB0324BN	201.75	192	034584031273	6
WTS981	806.05	218	026508353530	3	YB0324NL	221.85	192	034584031297	6
WTS981BN	1007.55	218	026508353554	3	YB0324BG	242.10	192	034584031266	6
WTS981BL	1108.35	218	026508353547	3	YB0361CH	237.45	193	034584031327	2
WTS44501	828.30	195	026508353448	3	YB0361BN	308.65	193	034584031310	2
WTS44501BG	1134.75	195	026508353455	3	YB0361NL	339.50	193	034584031334	2
WTS44501BN	1134.75	195	026508353479	3	YB0361BG	370.35	193	034584031303	2
WTS44501BL	1248.20	195	026508353462	3	YB0362CH	332.15	193	034584031365	2
Y5703CH	18.00	490	034584033239	12	YB0362BN	431.80	193	034584031358	2
Y5703BN	22.50	490	034584032973	12	YB0362NL	475.05	193	034584031372	2
Y5703BL	23.40	490	034584032317	12	YB0362BG	518.25	193	034584031341	2
Y5708CH	24.00	490	034584033246	3	YB0363CH	412.60	193	034584030306	2
Y5708BN	30.00	490	034584032980	3	YB0363BN	536.30	193	034584030290	2
Y5708BL	31.25	490	034584032324	3	YB0363NL	589.90	193	034584030313	2
Y5709CH	28.65	490	034584034250	3	YB0363BG	643.55	193	034584030283	2
Y5709BN	35.80	490	034584034243	3	YB0364CH	515.70	193	034584030344	2
Y5709BL	37.25	490	034584034236	3	YB0364BN	670.45	193	034584030337	2
Y5718CH	39.20	490	034584033253	3	YB0364NL	737.40	193	034584030351	2
Y5718BN	49.00	490	034584032997	3	YB0364BG	804.35	193	034584030320	2
Y5718BL	51.00	490	034584032331	3	YB0369	40.90	193	034584030368	3
Y5722CH	64.00	490	034584034281	3	YB0386CH	104.75	192	034584030399	6
Y5722BN	80.00	490	034584034274	3	YB0386BN	136.15	192	034584030382	6
Y5722BL	83.30	490	034584034267	3	YB0386NL	149.85	192	034584030405	6
Y5724CH	41.00	490	034584033260	3	YB0386BG	163.45	192	034584030375	6
Y5724BN	51.25	490	034584033000	3	YB0390CH	144.00	192	034584030436	6
Y5724BL	53.45	490	034584032348	3	YB0390BN	187.15	192	034584030429	6
Y5785CH	24.00	490	034584034311	3	YB0390NL	205.85	192	034584030443	6
Y5785BN	29.10	490	034584034304	3	YB0390BG	224.55	192	034584030412	6
Y5785BL	31.25	490	034584034298	3	YB0392CH	354.55	192	034584030474	1
Y5786CH	24.50	490	034584033277	3	YB0392BN	425.40	192	034584030467	1
Y5786BN	29.65	490	034584033017	3	YB0392NL	468.00	192	034584030481	1
Y5786BL	31.85	490	034584032355	3	YB0392BG	510.45	192	034584030450	1
Y5788CH	42.45	490	034584034342	3	YB0402CH	66.85	261	034584022547	24
Y5788BN	53.05	490	034584034335	3	YB0402BN	76.15	261	034584022530	24
Y5788BL	55.20	490	034584034328	3	YB0402BL	83.55	261	034584026750	24
Y5794CH	193.10	490	034584034366	2	YB0403CH	37.00	261	034584022561	24
Y5794BN	204.90	490	034584034359	2	YB0403BN	40.70	261	034584022554	24
Y5794BL	232.20	490	034584032881	2	YB0403BL	44.70	261	034584026767	24
YB0201CH	81.10	227	034584028389	24	YB0403BG	48.85	261	034584028594	24
YB0201BN	87.45	227	034584028372	24	YB0408CH	67.45	261	034584022585	6
YB0201BL	96.25	227	034584028365	24	YB0408BN	74.60	261	034584022578	6
YB0203CH	62.10	227	034584028419	24	YB0408BL	82.05	261	034584026774	6
YB0203BN	66.60	227	034584028402	24	YB0408BG	108.20	261	034584028600	6
YB0203BL	73.10	227	034584028396	24	YB0409CH	57.45	261	034584022608	6
YB0208CH	114.35	227	034584028440	6	YB0409BN	63.20	261	034584022592	6

Wholesale

Listed in numerical order

MODEL NUMBER	LIST PRICE	PAGE NO.	UNIVERSAL PRODUCT CODE	CASE QTY	MODEL NUMBER	LIST PRICE	PAGE NO.	UNIVERSAL PRODUCT CODE	CASE QTY
YB0409BL	69.45	261	034584026781	6	YB1718CH	78.35	237	034584037695	6
YB0418CH	78.35	261	034584022622	6	YB1718BN	86.15	237	034584037688	6
YB0418BN	86.15	261	034584022615	6	YB1718BL	94.70	237	034584037671	6
YB0418BL	94.70	261	034584026798	6	YB1718BG	120.60	237	034584037664	6
YB0418BG	120.60	261	034584028617	6	YB1724CH	80.80	237	034584037732	6
YB0424CH	80.80	261	034584022646	6	YB1724BN	89.20	237	034584037725	6
YB0424BN	89.20	261	034584022639	6	YB1724BL	98.05	237	034584037718	6
YB0424BL	98.05	261	034584026804	6	YB1724BG	124.75	237	034584037701	6
YB0424BG	124.75	261	034584028624	6	YB1761CH	180.65	238	034584037770	1
YB0486CH	55.00	261	034584022660	6	YB1761BN	225.90	238	034584037763	1
YB0486BN	60.15	261	034584022653	6	YB1761BL	246.25	238	034584037756	1
YB0486BL	66.15	261	034584026811	6	YB1761BG	271.10	238	034584037749	1
YB0486BG	87.15	261	034584028648	6	YB1762CH	252.75	238	034584037817	1
YB0501CH	92.45	203	034584032423	24	YB1762BN	315.95	238	034584037800	1
YB0501BN	120.20	203	034584032416	24	YB1762BL	344.35	238	034584037794	1
YB0501BL	132.25	203	034584032409	24	YB1762BG	379.15	238	034584037787	1
YB0501BG	138.75	203	034584032393	24	YB1763CH	313.95	238	034584037855	1
YB0503CH	70.90	203	034584032461	24	YB1763BN	392.40	238	034584037848	1
YB0503BN	92.15	203	034584032454	24	YB1763BL	427.70	238	034584037831	1
YB0503BL	101.40	203	034584032447	24	YB1763BG	470.95	238	034584037824	1
YB0503BG	106.30	203	034584032430	24	YB1764CH	402.00	238	034584037893	1
YB0505CH	18.60	203	034584032508	48	YB1764BN	502.50	238	034584037886	1
YB0505BN	24.25	203	034584032492	48	YB1764BL	547.75	238	034584037879	1
YB0505BL	26.70	203	034584032485	48	YB1764BG	602.95	238	034584037862	1
YB0505BG	28.00	203	034584032478	48	YB1769	33.10	238	034584037909	3
YB0507CH	37.40	203	034584032546	48	YB1786CH	55.00	237	034584037947	6
YB0507BN	48.65	203	034584032539	48	YB1786BN	60.15	237	034584037930	6
YB0507BL	53.45	203	034584032522	48	YB1786BL	66.15	237	034584037923	6
YB0507BG	56.15	203	034584032515	48	YB1786BG	87.15	237	034584037916	6
YB0508CH	130.35	203	034584032584	6	YB1788CH	97.80	237	034584037985	3
YB0508BN	169.45	203	034584032577	6	YB1788BN	108.20	237	034584037978	3
YB0508BL	186.50	203	034584032560	6	YB1788BL	119.00	237	034584037961	3
YB0508BG	195.60	203	034584032553	6	YB1788BG	156.95	237	034584037954	3
YB0518CH	150.00	203	034584032621	6	YB1794CH	318.35	237	034584038029	2
YB0518BN	194.95	203	034584032614	6	YB1794BN	349.15	237	034584038012	2
YB0518BL	214.50	203	034584032607	6	YB1794BL	380.60	237	034584038005	2
YB0518BG	224.95	203	034584032591	6	YB1794BG	453.90	237	034584037992	2
YB0524CH	155.30	203	034584032669	6	YB2101CH	25.50	315	034584024992	24
YB0524BN	201.85	203	034584032652	6	YB2101BN	40.90	315	034584024985	24
YB0524BL	222.00	203	034584032645	6	YB2101BL	45.05	315	034584033512	24
YB0524BG	232.90	203	034584032638	6	YB2101ORB	45.05	315	034584025005	24
YB0561CH	237.55	204	034584032706	2	YB2103CH	18.90	315	034584025029	24
YB0561BN	308.75	204	034584032690	2	YB2103BN	23.60	315	034584025012	24
YB0561BL	339.65	204	034584032683	2	YB2103BL	24.55	315	034584033529	24
YB0561BG	356.35	204	034584032676	2	YB2103ORB	26.45	315	034584025036	24
YB0562CH	332.40	204	034584032744	2	YB2108CH	33.25	315	034584025050	6
YB0562BN	432.10	204	034584032737	2	YB2108BN	41.55	315	034584025043	6
YB0562BL	475.30	204	034584032720	2	YB2108BL	43.20	315	034584033536	6
YB0562BG	498.70	204	034584032713	2	YB2108ORB	46.55	315	034584025067	6
YB0563CH	412.80	204	034584032782	2	YB2118CH	41.50	315	034584025098	6
YB0563BN	536.55	204	034584032775	2	YB2118BN	51.85	315	034584025074	6
YB0563BL	590.20	204	034584032768	2	YB2118BL	53.95	315	034584033543	6
YB0563BG	619.15	204	034584032751	2	YB2118ORB	58.10	315	034584025081	6
YB0564CH	515.90	204	034584032829	2	YB2124CH	43.55	315	034584025111	6
YB0564BN	670.70	204	034584032812	2	YB2124BN	54.45	315	034584025104	6
YB0564BL	737.75	204	034584032805	2	YB2124BL	56.65	315	034584033550	6
YB0564BG	773.95	204	034584032799	2	YB2124ORB	61.00	315	034584025128	6
YB0569	42.80	204	034584032836	3	YB2186CH	25.95	315	034584025142	6
YB0586CH	104.75	203	034584032874	6	YB2186BN	32.40	315	034584025135	6
YB0586BN	136.25	203	034584032867	6	YB2186BL	33.70	315	034584033567	6
YB0586BL	149.90	203	034584032850	6	YB2186ORB	36.30	315	034584025159	6
YB0586BG	157.20	203	034584032843	6	YB2201CH	25.50	330	034584008015	6
YB0801CH	114.50	182	034584021717	24	YB2201BN	40.90	330	034584008008	6
YB0801BL	138.60	182	034584029676	24	YB2201ORB	45.05	330	034584008022	6
YB0803CH	109.95	182	034584021731	24	YB2203CH	18.90	330	034584008046	24
YB0803BL	133.25	182	034584029669	24	YB2203BN	23.60	330	034584008039	24
YB0808CH	156.45	182	034584021755	6	YB2203ORB	26.45	330	034584008053	24
YB0808BL	189.50	182	034584029652	6	YB2208CH	33.25	330	034584008077	6
YB0818CH	181.15	182	034584021779	6	YB2208BN	41.55	330	034584008060	6
YB0818BL	219.40	182	034584029645	6	YB2208ORB	46.55	330	034584008084	6
YB0824CH	195.50	182	034584021793	6	YB2218CH	41.50	330	034584008107	6
YB0824BL	236.80	182	034584029638	6	YB2218BN	51.85	330	034584008091	6
YB0886CH	126.55	182	034584021816	6	YB2218ORB	58.10	330	034584008114	6
YB0886BL	153.15	182	034584029621	6	YB2224CH	43.55	330	034584008138	6
YB0892CH	315.45	182	034584021830	3	YB2224BN	54.45	330	034584008121	6
YB0892BL	382.00	182	034584029614	3	YB2224ORB	61.00	330	034584008145	6
YB1701CH	48.05	237	034584037572	24	YB2261CH	150.15	331	034584022233	2
YB1701BN	53.05	237	034584037565	24	YB2261BN	187.80	331	034584022226	2
YB1701BL	57.85	237	034584037558	24	YB2261ORB	187.80	331	034584022240	2
YB1701BG	68.95	237	034584037541	24	YB2262CH	210.20	331	034584022264	2
YB1703CH	37.00	237	034584037619	24	YB2262BN	262.85	331	034584022257	2
YB1703BN	40.70	237	034584037602	24	YB2262ORB	262.85	331	034584022271	2
YB1703BL	44.70	237	034584037596	24	YB2263CH	261.00	331	034584022295	2
YB1703BG	48.85	237	034584037589	24	YB2263BN	326.35	331	034584022288	2
YB1708CH	67.45	237	034584037657	6	YB2263ORB	326.35	331	034584022301	2
YB1708BN	74.60	237	034584037640	6	YB2264CH	334.35	331	034584022325	2
YB1708BL	82.05	237	034584037633	6	YB2264BN	417.85	331	034584022318	2
YB1708BG	108.20	237	034584037626	6	YB2264ORB	417.85	331	034584022332	2

Wholesale

Listed in numerical order

SUGGESTED LIST PRICES

MODEL NUMBER	LIST PRICE	PAGE NO.	UNIVERSAL PRODUCT CODE	CASE QTY	MODEL NUMBER	LIST PRICE	PAGE NO.	UNIVERSAL PRODUCT CODE	CASE QTY
YB2269	28.15	331	034584022349	3	YB5161BG	271.10	309	034584028792	2
YB2286CH	25.95	330	034584008169	6	YB5162CH	252.75	309	034584023872	2
YB2286BN	32.40	330	034584008152	6	YB5162BL	315.95	309	034584038210	2
YB2286ORB	36.30	330	034584008176	6	YB5162BN	315.95	309	034584023865	2
YB2303CH	18.90	322	034584024602	24	YB5162ORB	315.95	309	034584023889	2
YB2303BN	23.60	322	034584024596	24	YB5162NL	329.00	309	034584029768	2
YB2303BL	24.55	322	034584033185	24	YB5162BG	379.15	309	034584028778	2
YB2308CH	33.25	322	034584024626	6	YB5163CH	313.95	309	034584023902	2
YB2308BN	41.55	322	034584024619	6	YB5163BL	392.40	309	034584038227	2
YB2308BL	43.20	322	034584033192	6	YB5163BN	392.40	309	034584023896	2
YB2318CH	41.50	322	034584024640	6	YB5163ORB	392.40	309	034584023919	2
YB2318BN	51.85	322	034584024633	6	YB5163NL	424.20	309	034584029775	2
YB2318BL	53.95	322	034584033208	6	YB5163BG	470.95	309	034584028761	2
YB2324CH	43.55	322	034584024664	6	YB5164CH	402.00	309	034584023933	2
YB2324BN	54.45	322	034584024657	6	YB5164BL	502.50	309	034584038234	2
YB2324BL	56.65	322	034584033215	6	YB5164BN	502.50	309	034584023926	2
YB2386CH	25.95	322	034584024688	6	YB5164ORB	502.50	309	034584023940	2
YB2386BN	32.40	322	034584024671	6	YB5164NL	543.30	309	034584029782	2
YB2386BL	33.70	322	034584033222	6	YB5164BG	602.95	309	034584028754	2
YB2801CH	25.50	339	034584005601	6	YB5169	33.10	309	034584023957	3
YB2801BN	40.90	339	034584005663	6	YB5186CH	52.75	307	034584020802	6
YB2801ORB	45.05	339	034584005724	6	YB5186BN	57.75	307	034584020796	6
YB2803CH	18.90	339	034584005557	24	YB5186ORB	58.80	307	034584020819	6
YB2803BN	23.60	339	034584005618	24	YB5186BL	62.90	307	034584038258	6
YB2803ORB	26.45	339	034584005670	24	YB5186NL	63.95	307	034584029744	6
YB2808CH	33.25	339	034584005564	6	YB5186BG	83.60	307	034584028747	6
YB2808BN	41.55	339	034584005625	6	YB5201CH	48.05	249	034584023087	6
YB2808ORB	46.55	339	034584005687	6	YB5201BN	53.05	249	034584023094	6
YB2818CH	41.50	339	034584005571	6	YB5201ORB	58.25	249	034584023575	6
YB2818BN	51.85	339	034584005632	6	YB5203CH	37.00	249	034584023100	24
YB2818ORB	58.10	339	034584005694	6	YB5203BN	40.70	249	034584023117	24
YB2824CH	43.55	339	034584005588	6	YB5203ORB	44.70	249	034584023599	24
YB2824BN	54.45	339	034584005649	6	YB5208CH	67.45	249	034584023124	6
YB2824ORB	61.00	339	034584005700	6	YB5208BN	74.60	249	034584023131	6
YB2861CH	150.15	340	034584022363	2	YB5208ORB	82.10	249	034584023612	6
YB2861BN	187.80	340	034584022356	2	YB5218CH	78.35	249	034584023148	6
YB2861ORB	187.80	340	034584022370	2	YB5218BN	86.15	249	034584023155	6
YB2862CH	210.20	340	034584022394	2	YB5218ORB	94.70	249	034584023636	6
YB2862BN	262.85	340	034584022387	2	YB5222CH	107.25	249	034584023162	6
YB2862ORB	262.85	340	034584022400	2	YB5222BN	113.05	249	034584023179	6
YB2863CH	261.00	340	034584022424	2	YB5222ORB	118.70	249	034584023650	6
YB2863BN	326.35	340	034584022417	2	YB5224CH	80.80	249	034584023186	6
YB2863ORB	326.35	340	034584022431	2	YB5224BN	89.20	249	034584023193	6
YB2864CH	334.35	340	034584022455	2	YB5224ORB	98.15	249	034584023674	6
YB2864BN	417.85	340	034584022448	2	YB5275CH	167.20	249	034584023544	6
YB2864ORB	417.85	340	034584022462	2	YB5275BN	191.25	249	034584023537	6
YB2869	28.15	340	034584022479	3	YB5275OWB	207.25	249	034584023551	6
YB2886CH	25.95	339	034584005595	6	YB5286CH	55.00	249	034584023209	6
YB2886BN	32.40	339	034584005656	6	YB5286BN	60.15	249	034584023216	6
YB2886ORB	36.30	339	034584005717	6	YB5286ORB	66.15	249	034584023698	6
YB2894CH	202.40	339	034584015143	2	YB5403CH	38.55	500	034584482761	24
YB2894BN	222.00	339	034584015136	2	YB5403BN	42.50	500	034584483003	24
YB2894ORB	244.15	339	034584015150	2	YB5403WR	46.60	500	034584483089	24
YB5101CH	46.10	307	034584020628	24	YB5408CH	70.45	500	034584482778	6
YB5101BN	50.90	307	034584020611	24	YB5408BN	77.95	500	034584483010	6
YB5101NL	55.80	307	034584029607	24	YB5408ORB	85.70	500	034584000347	6
YB5101BL	55.90	307	034584038159	24	YB5408WR	85.70	500	034584483096	6
YB5101ORB	55.90	307	034584020635	24	YB5418CH	75.65	500	034584482785	6
YB5101BG	61.05	307	034584028631	24	YB5418BN	83.25	500	034584483027	6
YB5103CH	35.50	307	034584020659	24	YB5418ORB	91.50	500	034584000606	6
YB5103BN	39.05	307	034584020642	24	YB5418WR	91.50	500	034584483102	6
YB5103ORB	39.70	307	034584020666	24	YB5422CH	101.35	500	034584015693	6
YB5103BL	42.85	307	034584038166	24	YB5422BN	109.30	500	034584015686	6
YB5103NL	42.90	307	034584029591	24	YB5422ORB	120.25	500	034584015709	6
YB5103BG	46.85	307	034584028846	24	YB5422WR	120.25	500	034584015716	6
YB5108CH	64.75	307	034584020680	6	YB5424CH	78.15	500	034584482792	6
YB5108BN	71.65	307	034584020673	6	YB5424BN	86.20	500	034584483034	6
YB5108ORB	73.05	307	034584020697	6	YB5424ORB	94.85	500	034584000613	6
YB5108BL	78.90	307	034584038173	6	YB5424WR	94.85	500	034584483119	6
YB5108NL	84.25	307	034584029584	6	YB5486CH	53.10	500	034584482822	6
YB5108BG	103.90	307	034584028839	6	YB5486BN	58.15	500	034584483065	6
YB5118CH	75.10	307	034584020710	6	YB5486ORB	63.95	500	034584000644	6
YB5118BN	82.65	307	034584020703	6	YB5486WR	63.95	500	034584483140	6
YB5118ORB	84.15	307	034584020727	6	YB5490CH	100.55	500	034584482839	3
YB5118BL	90.90	307	034584038180	6	YB5490BN	108.10	500	034584483072	3
YB5118NL	91.05	307	034584029577	6	YB5490ORB	119.10	500	034584000651	3
YB5118BG	115.70	307	034584028822	6	YB5490WR	128.60	500	034584483157	3
YB5124CH	77.55	307	034584020741	6	YB5494CH	273.80	500	034584015082	2
YB5124BN	85.60	307	034584020734	6	YB5494BN	301.80	500	034584015075	2
YB5124BL	94.25	307	034584038197	6	YB5494ORB	331.95	500	034584015099	2
YB5124ORB	94.25	307	034584020758	6	YB6401CH	46.25	283	034584027047	24
YB5124NL	96.15	307	034584029683	6	YB6401BN	51.05	283	034584027030	24
YB5124BG	119.75	307	034584028815	6	YB6401NL	56.00	283	034584029737	24
YB5161CH	180.65	309	034584023841	2	YB6401BL	56.15	283	034584038265	24
YB5161BL	225.90	309	034584038203	2	YB6401ORB	56.15	283	034584027054	24
YB5161BN	225.90	309	034584023834	2	YB6403CH	35.60	283	034584027078	24
YB5161ORB	225.90	309	034584023858	2	YB6403BN	39.15	283	034584027061	24
YB5161NL	226.00	309	034584029751	2	YB6403BL	43.20	283	034584038272	24

Wholesale

Listed in numerical order

MODEL NUMBER	LIST PRICE	PAGE NO.	UNIVERSAL PRODUCT CODE	CASE QTY	MODEL NUMBER	LIST PRICE	PAGE NO.	UNIVERSAL PRODUCT CODE	CASE QTY
YB6403NL	43.20	283	034584029720	24	YB8405NL	28.30	172	034584021861	48
YB6403ORB	43.20	283	034584027085	24	YB8405ORB	28.30	172	034584021878	48
YB6408CH	64.95	283	034584027108	6	YB8405BG	30.90	172	034584028860	48
YB6408BN	71.85	283	034584027092	6	YB8407CH	42.60	172	034584021892	48
YB6408BL	79.15	283	034584038289	6	YB8407BN	45.50	172	034584021885	48
YB6408ORB	79.15	283	034584027115	6	YB8407BL	49.85	172	034584029249	48
YB6408NL	84.65	283	034584029713	6	YB8407NL	50.05	172	034584021908	48
YB6418CH	75.55	283	034584027139	6	YB8407ORB	50.05	172	034584021915	48
YB6418BN	82.95	283	034584027122	6	YB8407BG	54.60	172	034584028853	48
YB6418BL	91.30	283	034584038296	6	YB8408CH	177.90	172	034584017970	6
YB6418ORB	91.30	283	034584027146	6	YB8408BN	194.90	172	034584017963	6
YB6418NL	91.40	283	034584029706	6	YB8408BL	214.10	172	034584029256	6
YB6422CH	101.10	283	034584027160	6	YB8408NL	214.50	172	034584020444	6
YB6422BN	108.85	283	034584027153	6	YB8408ORB	214.50	172	034584017987	6
YB6422BL	119.85	283	034584038302	6	YB8408BG	234.00	172	034584028716	6
YB6422ORB	119.85	283	034584027177	6	YB8418CH	200.80	172	034584018007	6
YB6422NL	122.45	283	034584029218	6	YB8418BN	228.05	172	034584017994	6
YB6424CH	77.90	283	034584027191	6	YB8418BL	250.65	172	034584029263	6
YB6424BN	86.00	283	034584027184	6	YB8418NL	251.05	172	034584020451	6
YB6424NL	94.30	283	034584029690	6	YB8418ORB	251.05	172	034584018014	6
YB6424BL	94.55	283	034584038319	6	YB8418BG	273.60	172	034584028808	6
YB6424ORB	94.55	283	034584027207	6	YB8424CH	216.65	172	034584018038	6
YB6461CH	181.45	285	034584027344	1	YB8424BN	246.00	172	034584018021	6
YB6461BL	219.65	285	034584029317	1	YB8424BL	270.05	172	034584029270	6
YB6461NL	219.65	285	034584029324	1	YB8424NL	270.45	172	034584020468	6
YB6461BN	226.75	285	034584027214	1	YB8424ORB	270.45	172	034584018045	6
YB6461ORB	226.75	285	034584027351	1	YB8424BG	295.00	172	034584028785	6
YB6462CH	253.85	285	034584027375	1	YB8486CH	140.00	172	034584018069	6
YB6462BL	307.40	285	034584029331	1	YB8486BN	159.80	172	034584018052	6
YB6462NL	307.40	285	034584029393	1	YB8486BL	175.60	172	034584029287	6
YB6462BN	317.20	285	034584027368	1	YB8486NL	175.80	172	034584020475	6
YB6462ORB	317.20	285	034584027382	1	YB8486ORB	175.80	172	034584018076	6
YB6463CH	315.10	285	034584027443	1	YB8486BG	191.80	172	034584028709	6
YB6463BN	393.90	285	034584027399	1	YB8801CH	84.75	215	034584014696	24
YB6463NL	393.90	285	034584029379	1	YB8801BN	91.50	215	034584016492	24
YB6463ORB	393.90	285	034584027405	1	YB8801BL	99.70	215	034584038333	24
YB6463BL	410.15	285	034584029386	1	YB8803CH	64.90	215	034584014702	24
YB6464CH	403.55	285	034584027450	1	YB8803BN	70.30	215	034584016508	24
YB6464BN	504.50	285	034584027412	1	YB8803BL	76.60	215	034584038340	24
YB6464ORB	504.50	285	034584027429	1	YB8805CH	17.15	215	034584018564	48
YB6464BL	523.85	285	034584029362	1	YB8805BN	19.80	215	034584018250	48
YB6464NL	523.85	285	034584029355	1	YB8805BL	21.55	215	034584038357	48
YB6469	33.30	285	034584027436	3	YB8807CH	34.30	215	034584018571	48
YB6486CH	53.05	283	034584027238	6	YB8807BN	37.10	215	034584018267	48
YB6486BN	57.95	283	034584027221	6	YB8807BL	40.40	215	034584038364	48
YB6486BL	63.80	283	034584038326	6	YB8808CH	119.50	215	034584014719	6
YB6486ORB	63.80	283	034584027245	6	YB8808BN	128.95	215	034584016515	6
YB6486NL	68.80	283	034584029348	6	YB8808BL	140.55	215	034584038371	6
YB8000CH	6.10	371	034584001641	50	YB8818CH	137.50	215	034584014726	6
YB8000BC	7.80	371	034584002181	50	YB8818BN	148.45	215	034584016522	6
YB8000SN	10.10	371	034584003478	50	YB8818BL	161.80	215	034584038388	6
YB8000OWB	13.10	371	034584009234	50	YB8824CH	142.45	215	034584014733	6
YB8003CH	5.35	371	034584001634	50	YB8824BN	153.90	215	034584016539	6
YB8003BC	6.85	371	034584002174	50	YB8824BL	167.75	215	034584038395	6
YB8003SN	7.00	371	034584003461	50	YB8861CH	217.70	216	034584023971	2
YB8003OWB	8.00	371	034584009241	50	YB8861BN	272.05	216	034584023964	2
YB8081	15.20	371	034584016836	25	YB8861BL	296.50	216	034584038401	2
YB8086CH	10.10	371	034584001689	50	YB8862CH	304.55	216	034584023995	2
YB8086BC	13.30	371	034584002228	50	YB8862BN	380.80	216	034584023988	2
YB8086SN	14.45	371	034584003515	50	YB8862BL	415.10	216	034584038418	2
YB8086OWB	15.45	371	034584009289	50	YB8863CH	378.25	216	034584024015	2
YB8094CH	5.10	371	034584001672	50	YB8863BN	473.15	216	034584024008	2
YB8094BC	6.60	371	034584002211	50	YB8863BL	515.70	216	034584038425	2
YB8094SN	8.35	371	034584003454	50	YB8864CH	484.55	216	034584024039	2
YB8094OWB	10.35	371	034584009272	50	YB8864BN	605.65	216	034584024022	2
YB8098CH	4.40	371	034584001665	50	YB8864BL	660.10	216	034584038432	2
YB8098BC	5.55	371	034584002204	50	YB8869	40.00	216	034584024046	3
YB8098SN	6.75	371	034584003492	50	YB8886CH	96.00	215	034584014740	6
YB8098OWB	7.80	371	034584009265	50	YB8886BN	103.60	215	034584016546	6
YB8099CH	2.15	371	034584001658	50	YB8886BL	112.90	215	034584038449	6
YB8099OWB	2.75	371	034584009258	50	YG0312CH	214.20	193	034584030511	6
YB8099SN	3.25	371	034584003485	50	YG0312BN	278.40	193	034584030504	6
YB8099BC	3.60	371	034584002198	50	YG0312NL	306.25	193	034584030528	6
YB8401CH	135.65	172	034584017918	24	YG0312BG	334.15	193	034584030498	6
YB8401BN	154.50	172	034584017901	24	YG0318CH	223.85	193	034584030559	6
YB8401BL	169.70	172	034584029300	24	YG0318BN	290.95	193	034584030542	6
YB8401NL	169.95	172	034584020420	24	YG0318NL	320.10	193	034584030566	6
YB8401ORB	169.95	172	034584017925	24	YG0318BG	349.10	193	034584030535	6
YB8401BG	185.45	172	034584028730	24	YG0324CH	233.90	193	034584030597	6
YB8403CH	123.20	172	034584017949	24	YG0324BN	303.90	193	034584030580	6
YB8403BN	141.00	172	034584017932	24	YG0324NL	334.40	193	034584030603	6
YB8403BL	155.00	172	034584029225	24	YG0324BG	364.75	193	034584030573	6
YB8403NL	155.20	172	034584020437	24	YG0336CH	266.20	193	034584030634	6
YB8403ORB	155.20	172	034584017956	24	YG0336BN	346.10	193	034584030627	6
YB8403BG	169.15	172	034584028723	24	YG0336NL	380.65	193	034584030641	6
YB8405CH	22.80	172	034584021854	48	YG0336BG	415.30	193	034584030610	6
YB8405BN	25.75	172	034584021847	48	YG0342CH	391.75	193	034584031402	6
YB8405BL	28.30	172	034584029232	48	YG0342BN	509.25	193	034584031396	6

Wholesale

Listed in numerical order

SUGGESTED LIST PRICES

MODEL NUMBER	LIST PRICE	PAGE NO.	UNIVERSAL PRODUCT CODE	CASE QTY	MODEL NUMBER	LIST PRICE	PAGE NO.	UNIVERSAL PRODUCT CODE	CASE QTY
YG0342NL	560.20	193	034584031419	6	YG5418ORB	191.20	501	034584007483	3
YG0342BG	611.15	193	034584031389	6	YG5424CH	149.55	501	034584482662	3
YG0412CH	123.55	262	034584024091	6	YG5424BN	187.45	501	034584483706	3
YG0412BN	154.45	262	034584024107	6	YG5424ORB	206.30	501	034584007490	3
YG0412BL	155.65	262	034584038814	6	YG5430CH	160.00	501	034584482679	3
YG0412BG	159.35	262	034584038807	6	YG5430BN	195.25	501	034584483713	3
YG0418CH	132.25	262	034584024114	6	YG5436CH	170.25	501	034584482686	3
YG0418BN	165.30	262	034584024121	6	YG5436BN	210.90	501	034584483720	3
YG0418BL	166.65	262	034584038821	6	YG5442CH	249.85	501	034584482693	3
YG0418BG	191.80	262	034584028693	6	YG5442BN	312.40	501	034584483737	3
YG0424CH	138.10	262	034584024138	6	YG6412CH	123.55	284	034584027269	6
YG0424BN	172.65	262	034584024145	6	YG6412BN	150.75	284	034584027252	6
YG0424BL	174.00	262	034584038838	6	YG6412BL	153.20	284	034584029942	6
YG0424BG	200.25	262	034584028686	6	YG6412NL	155.65	284	034584029447	6
YG0436CH	157.45	262	034584024152	6	YG6412ORB	166.80	284	034584027276	6
YG0436BN	196.80	262	034584024169	6	YG6418CH	129.10	284	034584027290	6
YG0436BL	198.35	262	034584038852	6	YG6418BN	157.50	284	034584027283	6
YG0436BG	203.10	262	034584038845	6	YG6418BL	160.10	284	034584029430	6
YG0442CH	189.00	262	034584024176	6	YG6418NL	162.65	284	034584029423	6
YG0442BN	236.25	262	034584024183	6	YG6418ORB	174.30	284	034584027306	6
YG0442BL	245.70	262	034584038876	6	YG6424CH	134.90	284	034584027320	6
YG0442BG	274.05	262	034584038869	6	YG6424BL	167.30	284	034584029416	6
YG0712CH	84.45	353	034584021939	6	YG6424BN	168.65	284	034584027313	6
YG0712BN	99.00	353	034584021922	6	YG6424NL	169.95	284	034584029409	6
YG0712BL	106.10	353	034584029294	6	YG6424ORB	188.85	284	034584027337	6
YG0718CH	89.05	353	034584021953	6	YG8812CH	196.40	215	034584022127	6
YG0718BN	104.00	353	034584021946	6	YG8812BN	212.25	215	034584022110	6
YG0718BL	112.00	353	034584029560	6	YG8812BL	231.40	215	034584038487	6
YG0724CH	93.65	353	034584021977	6	YG8818CH	205.20	215	034584022141	6
YG0724BN	109.50	353	034584021960	6	YG8818BN	222.45	215	034584022134	6
YG0724BL	117.80	353	034584029553	6	YG8818BL	242.50	215	034584038494	6
YG0736CH	106.65	353	034584021991	6	YG8824CH	214.40	215	034584022165	6
YG0736BN	124.50	353	034584021984	6	YG8824BN	240.10	215	034584022158	6
YG0736BL	134.10	353	034584029546	6	YG8824BL	261.70	215	034584038500	6
YG0742CH	130.00	353	034584022769	6	YG8836CH	244.05	215	034584022189	6
YG0742BN	162.50	353	034584022752	6	YG8836BN	270.35	215	034584022172	6
YG0742BL	169.00	353	034584029539	6	YG8836BL	294.70	215	034584038517	6
YG0812CH	206.25	182	034584022042	6	YG8842CH	359.25	215	034584022806	6
YG0812BL	249.10	182	034584029522	6	YG8842BN	397.15	215	034584022790	6
YG0818CH	215.50	182	034584022066	6	YG8842BL	432.90	215	034584038524	6
YG0818BL	260.30	182	034584029515	6					
YG0824CH	225.15	182	034584022080	6					
YG0824BL	272.00	182	034584029508	6					
YG0836CH	256.25	182	034584022103	6					
YG0836BL	309.70	182	034584029492	6					
YG0842CH	358.70	182	034584022783	6					
YG0842BL	433.35	182	034584029485	6					
YG2212CH	110.50	330	034584024190	6					
YG2212BN	136.45	330	034584024206	6					
YG2212ORB	149.20	330	034584024213	6					
YG2218CH	115.40	330	034584024220	6					
YG2218BN	142.50	330	034584024237	6					
YG2218ORB	155.60	330	034584024244	6					
YG2224CH	120.80	330	034584024251	6					
YG2224BN	148.60	330	034584024268	6					
YG2224ORB	163.10	330	034584024275	6					
YG2812CH	110.50	339	034584024282	6					
YG2812BN	136.45	339	034584024299	6					
YG2812ORB	149.20	339	034584024305	6					
YG2818CH	115.40	339	034584024312	6					
YG2818BN	142.20	339	034584024329	6					
YG2818ORB	155.60	339	034584024336	6					
YG2824CH	120.80	339	034584024343	6					
YG2824BN	148.60	339	034584024350	6					
YG2824ORB	163.10	339	034584024367	6					
YG5112CH	123.55	308	034584025166	6					
YG5112BN	152.00	308	034584025241	6					
YG5112BL	160.60	308	034584038456	6					
YG5112NL	166.80	308	034584029478	6					
YG5112ORB	169.25	308	034584025173	6					
YG5112BG	179.15	308	034584028679	6					
YG5118CH	129.10	308	034584025197	6					
YG5118BN	158.80	308	034584025180	6					
YG5118BL	167.85	308	034584038463	6					
YG5118NL	174.30	308	034584029461	6					
YG5118ORB	176.85	308	034584025203	6					
YG5118BG	187.20	308	034584028662	6					
YG5124CH	134.90	308	034584025227	6					
YG5124BN	168.65	308	034584025210	6					
YG5124BL	175.40	308	034584038470	6					
YG5124NL	182.15	308	034584029454	6					
YG5124ORB	186.15	308	034584025234	6					
YG5124BG	195.60	308	034584028655	6					
YG5412CH	137.05	501	034584482648	3					
YG5412BN	165.70	501	034584483683	3					
YG5412ORB	182.20	501	034584007476	3					
YG5418CH	143.20	501	034584482655	3					
YG5418BN	173.60	501	034584483690	3					

Bulk

Listed in numerical order

SUGGESTED LIST PRICES

MODEL NUMBER	LIST PRICE	PAGE NO.	UNIVERSAL PRODUCT CODE	CASE QTY
64601	154.85	602	026508040751	12
64621	190.30	602	026508002896	12
64900	121.00	605	026508040775	12
64919	167.85	605	026508017265	12
64920	167.85	605	026508002889	12
64922	121.00	605	026508147955	12
64925	167.85	605	026508134542	12
66172	199.00	604	026508261194	6
66410	199.00	604	026508152485	6
66610	199.00	604	026508162064	6
66802	199.00	604	026508264379	6
67315C	319.25	93	026508069257	6
67315SRS	399.05	93	026508242933	6
67425	173.60	601	026508052983	6
67430	218.25	601	026508052884	6
67434	218.25	601	026508053041	6
67545C	418.45	600	026508209165	3
67840	263.15	600	026508138861	6
69000	146.80	605	026508045114	6
BGS181210B	462.95	601	026508357620	1
BGS18186B	361.80	601	026508376379	1
L64600	154.85	602	026508063705	12
L64601	154.85	602	026508063712	12
L64620	201.95	603	026508047309	12
L64621	190.30	603	026508047316	12
L64624	207.75	603	026508047347	12
L64625	192.20	603	026508047354	12
L64635	207.75	603	026508061534	12
T181	45.45	369	026508029565	12
T182	50.05	611	026508029589	12
T182EP	50.05	612	026508208786	12
T183	81.25	609	026508029602	12
T183EP	81.25	609	026508208809	12
T187	45.45	613	026508019832	12
T470	48.25	616	026508019825	12
T471	93.20	615	026508015742	12
T471EP	93.20	615	026508270813	12
T473	57.55	615	026508015728	12
T473EP	57.55	615	026508270967	12
T62132	78.95	611	026508152508	12
T62132EP	78.95	337	026508208359	12
T62133	118.95	609	026508152515	12
T62133EP	118.95	336	026508208373	12
T62151	58.75	613	026508162026	12
T62152	78.95	610	026508162033	12
T62152EP	78.95	329	026508208397	12
T62153	118.95	608	026508162040	12
T62153EP	118.95	328	026508208410	12
T62182	78.95	610	026508264577	12
T62183	118.95	608	026508264584	12
T62742	78.95	610	026508261354	12
T62743	118.95	608	026508261361	6
TL181	45.45	369	026508047620	12
TL182	50.05	368	026508047552	12
TL182EP	50.05	364	026508208472	12
TL182NH	47.45	612	026508208496	12
TL183	81.25	367	026508047590	12
TL183EP	81.25	367	026508208519	12
TL183NH	71.35	609	026508208533	12
TL470	48.25	616	026508047842	12
TL471	93.20	615	026508047828	12
TL471EP	93.20	615	026508271056	12
TL473	57.55	615	026508047774	12
TL473EP	57.55	615	026508271087	12
UTL170	207.20	606	026508321140	3
UTL171	213.40	606	026508321157	12
UTL171EP	213.40	606	026508321164	12

MODEL NUMBER	LIST PRICE	PAGE NO.	UNIVERSAL PRODUCT CODE	CASE QTY
UTL172	256.50	606	026508321171	12
UTL172EP	256.50	606	026508321188	12

B2B Connect: Best-In-Class Online 24/7 Service

Moen® continues to empower you through B2B Connect with new technologies, responsive design, and ease of use processes to help you run your business efficiently. B2B Connect is Moen's new digital-first, self-serve business site to make it easier to do business with North America's number one faucet brand.

FEATURES:

- Place product orders
- Check pricing/inventory
- Check order status even on multi-shipment orders
- Obtain order confirmation
- Order tracking details
- View and print packing slip
- Product browsing and selection
- Customer admin role to manage account users
- Modern user interface compatible with all major web browsers
- View and save shopping carts

Request an account today at B2BConnect.moen.com to receive Moen's best-in-class Online sales support .

Customer Support

MOEN B2B CONNECT

Phone: 1-888-450-5829 Website: B2Bconnect.moen.com Email: connect@moen.com

MOEN WHOLESALE FAUCETS

Phone: 1-800-531-1600 Fax: 1-800-848-6636 Email: moencustomerservicewholesaleUS@moen.com

MOEN RETAIL FAUCETS

Phone: 1-800-531-1606 Fax: 1-800-848-6636 Email: moencustomerserviceUS@moen.com

MOEN ACCESSORIES

Phone: 1-800-531-1606 Fax: 1-888-379-2720 Email: moencustomerserviceUS@moen.com

Visit moen.com/professional for products, tools and resources for the professional. Additional information and customer support can be found by visiting moen.com or contacting your Moen Sales Representative.





MOEN

MOEN

Good Morning

100°
102°

9:23 AM

MOEN

MOEN

Smart Water Network

Water is the most important resource in our homes, flowing through a vast network of pipes behind the walls of your home. Elevate and protect your experiences with the water running throughout your life with the Moen® Smart Water Network.

The Moen Smart Water Network is a collection of smart products, brought together in a single, integrated app, to give you unprecedented control over how you experience water in your everyday life. It's not technology for technology's sake. It's innovation that makes your life simpler, easier and brings you peace of mind.

Customized Control and Convenience

The Moen® Smart Water Network simplifies your life and gives you peace of mind by creating a deeper connection with the water in your home. Control and customize all interactions with water to elevate your experiences to a level that has never before been possible.



SMART FAUCET

For the busiest room in your home, Moen Smart Faucets use touchless technology and voice control to make life easier in the kitchen.



SMART SHOWER

Never again will you have to walk into a shower that's too hot or cold. Create a customized showering experience to meet your exact needs.



FLO SMART WATER MONITOR AND SHUTOFF

The Smart Water Monitor and Shutoff is installed on a home's main water supply line and connects to the Moen Smart Water App so you can receive notifications and control your home's water from anywhere at any time.



SMART LEAK DETECTOR

The Smart Leak Detector is a standalone sensor that can be placed anywhere in a home to alert you when and where it detects moisture to help prevent water damage and loss.



SMART SUMP PUMP MONITOR

The Smart Sump Pump Monitor gives you peace of mind by monitoring your sump pump's performance through connected, smart technology that provides 24/7 alerts of potential failure or flooding issues before it's too late.



SMART SPRINKLER CONTROLLER

The Moen Smart Sprinkler Controller offers simple, intelligent and affordable control over home irrigation systems. Enjoy automated and customized outdoor watering routines using the Moen Smart Water App.



SMART WIRELESS SOIL SENSOR

Once inserted flush into the ground, Smart Wireless Soil Sensors measure the soil moisture and temperature. Measurements are communicated to the Moen Smart Sprinkler Controller to automatically adjust a zone's watering schedules as needed.





Tap Into Your Whole Home's Water

The Moen® Smart Water App allows you to connect to the water flowing through your home like never before, activating the full potential and automation of your Moen smart water products. The app provides the ultimate peace of mind by giving users complete control over their water from anywhere at any time. You can even track water usage to enhance conservation efforts and monitor for potential issues before they become a problem.





MOEN SMART WATER APP

The free iOS/Android™ Moen Smart Water App is easy to set up and allows you to control all of the features and benefits of the products in your Moen Smart Water Network from customized settings and personalized presets to monitoring water usage and automatic shutoff.



TRACK WATER USAGE

See your home's total water usage by device in the Moen Smart Water App, so you can know when and where water is being used.

WATER SECURITY

Monitor your water, detect leaks in your pipes 24/7 and automatically shut off your entire water supply before a catastrophic leak damages your home.

CUSTOMIZATION AND PERSONALIZATION

Further enhance your relationship with water throughout your home by creating preferred settings and presets for a completely personalized experience.

WHOLE HOME MONITORING

Monitor, track and control the entire water supply system throughout your home.

NOTIFICATIONS AND ALERTS

Receive real-time alerts through the app, a text or even phone call, so you can take immediate action to address potential issues.

ACHIEVE WATER SAVINGS

The Smart Water Network automates home water conservation. Embrace sustainability using the Flo Smart Water Monitor and Shutoff for automated water security and achieving conservation goals. Set outdoor watering routines with the Smart Sprinkler Controller and optimize water use with the Smart Faucet for effortless savings and elevated experiences.

SMART CUSTOMIZABLE WATER

SMART PRODUCTS





SMART FAUCET WITH MOTION CONTROL

The Moen Smart Faucet with Motion Control makes life easier and completely touch free in the kitchen. The advanced sensor technology allows touchless operation of both the temperature and water flow by using simple hand motions, while the voice-activated and app-based features give you additional control and personalization.

Collections

Nio™ | Tenon™ | Weymouth® | Sinema™ |
Paterson™ | Smyth™ | Cia™ | KURV™

Reference Kitchen and Bar section for product details beginning on page 62.



SMART FAUCET

The Moen Smart Faucet makes life easier in the kitchen. Achieve precise volume and temperature control with your voice or a tap of the app; turn water on/off with the wave of your hand; or simply use the handle. Plus, with a wide range of styles and finishes, it's a beautifully practical addition to any home.

Collections

Cia™ | Align® | KURV™ | Brantford® | Arbor® | Belfield™ | Sleek®

Reference Kitchen and Bar section for product details beginning on page 62.



SMART CUSTOMIZABLE WATER

SMART PRODUCTS





SMART SHOWER CONTROLLER AND DIGITAL VALVE

The Smart Shower is a Wi-Fi enabled, digital shower that offers mobile connectivity and unmatched personalization, providing you with countless ways to create your ideal showering experience. You can control the shower in three ways: voice control through smart speakers, the U by Moen® Smart Shower App, and a shower controller. Within the app, you can create up to twelve presets including name, greeting, outlets used, temperature, timer and notifications. Additionally, the “warmup and pause” feature activates the shower to warm up to your exact temperature and then pause the water flow until you’re ready to get in, helping to reduce unnecessary water waste. With the Moen Smart Shower, your perfect shower is just a tap or voice command away.

Two-Outlet Controller

TS3302TB | TS3302BL

Four-Outlet Controller

TS3304TB | TS3304BL

Two-Outlet Valve

S3102

Four-Outlet Valve

S3104

Battery back-up sold separately | 179573

The Smart Shower controller must be paired with the Smart Shower digital valve.
Controller available in Terra Beige (TB) and Matte Black (BL). See page 377 for additional product details.



SMART WATER SECURITY



SMART PRODUCTS



Flo Smart Water Monitor and Shutoff

Reduce your risk of water leaks and damage with the Flo Smart Water Monitor and Shutoff. Flo monitors flow rate and pressure of your home's water and tracks total home water usage, allowing the intelligent system to detect leaks as small as a drop a minute anywhere in your home. Plus, it can automatically shut off the water before a catastrophic leak occurs.



		MODEL	LIST	FINISH/CONNECT	CASE QTY
FLO SMART WATER MONITOR AND SHUTOFF - PREMIUM					
 <ul style="list-style-type: none"> • Wi-Fi connected • features leak detection • features automatic shutoff • features water usage monitoring • smartphone app available for Apple iOS and Android OS • installs on main water line • AC power required 		900-001*	767.70	0.75" Shutoff	1
		900-006*	846.10	1.00" Shutoff	1
		900-002**	1230.75	1.25" Shutoff	1
FLO SMART WATER ACCESSORIES - PREMIUM					
 		920-003	18.75	25' DC Ext. Cable	10
		920-002	8.10	AC Adapter	1
FLO SMART WATER ACCESSORIES - PREMIUM					
		930-001	62.40	0.75" NPT Spacer Kit	24
		930-002	62.40	0.75" CC Spacer Kit	24
		930-003	72.05	1.00" NPT Spacer Kit	24
		930-004	72.05	1.00" CC Spacer Kit	24
		930-005	104.85	1.25" NPT Spacer Kit	24
		930-006	104.85	1.25" CC Spacer Kit	24

* Can be installed on lines up to 1/4" | **Can be installed on lines up to 1/2"



Smart Leak Detector

The Smart Leak Detector is a standalone sensor that can be placed anywhere in a home to alert you when and where it detects moisture to help prevent water damage and loss. If the Smart Leak Detector senses the presence of water, extreme temperatures or high humidity, it will alert you in one or more ways, according to set preferences: Moen Smart Water App, text, phone call or email.

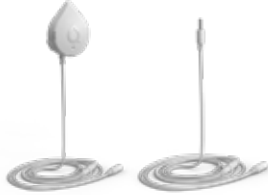

	MODEL	LIST	FINISH/CONNECT	CASE QTY
SMART LEAK DETECTOR - PREMIUM				
 <ul style="list-style-type: none"> • Wi-Fi connected • features moisture, temperature and humidity sensing • features audible, visual and app alerts • smartphone app available for Apple iOS and Android OS • installs anywhere water might be an issue • battery powered 	920-004***	78.05	Smart Leak Detector 1 pk	4
	920-005***	203.00	Smart Leak Detector 3 pk	4
	SMART LEAK DETECTOR ACCESSORY			
	920-006	35.50	6' Leak Sensing Cable	36

SMART PRODUCTS



Smart Sump Pump Monitor

Retrofittable to any sump pump (up to and including 1HP), the Moen Smart Sump Pump Monitor gives you peace of mind by monitoring your sump pump's performance through connected, smart technology that provides 24/7 alerts of potential failure or flooding issues, before it's too late.



	MODEL	LIST	FINISH/CONNECT	CASE QTY
SMART SUMP PUMP MONITOR - PREMIUM				
 <ul style="list-style-type: none"> • Wi-Fi connected • features ability to monitor and alert of potential issues with a sump pump system • features moisture, temperature and humidity sensing • smartphone app available for Apple iOS and Android OS • retrofits to any brand sump pump up to 1 HP • plugs into standard outlet and primary sump pump plugs into monitor • comes with 10' smart water level sensor, 6' leak sensing disc, 9 volt battery back-up and zip ties for installation 	S2000ESUSA	261.90	N/A	2

Requires:

- standard electrical outlet with 8 ft. of sump pump basin lid. For longer distances, a 5 ft. smart water level sensor extension cable is available
- Wi-Fi 2.4 Ghz
- iOS or Android Smart phone
- Moen Smart Water App

*Can be installed on lines up to 1¼" | **Can be installed on lines up to 1½" | ***Comes with 48" detector extension cable for hard-to-reach areas

SMART IRRIGATION

SMART PRODUCTS





Smart Sprinkler Controller

The Moen® Smart Sprinkler Controller offers simple, intelligent and affordable control over home irrigation systems—all accessible from the Moen Smart Water App. Eliminate the guesswork in managing sprinkler routines with the controller's unique features that automate watering and ensure lawns and landscapes get water where it's needed, only when it's needed—helping to reduce water waste.



	MODEL	LIST	FINISH/CONNECT	CASE QTY
SMART SPRINKLER CONTROLLER - PREMIUM				
<ul style="list-style-type: none"> • Wi-Fi connected • retrofits on existing installed irrigation system • app control enables independent zone control, ability to set schedules, weather skip and seasonal adjustments • available in 8 or 16 zone controllers 	WICNT008G1USA	292.60	8-Zone Controller	1
	WICNT016G1USA	382.00	16-Zone Controller	1



Smart Wireless Soil Sensor

Moen Smart Wireless Soil Sensors pair with the Moen Smart Sprinkler Controller to intelligently optimize and automate in-ground home irrigation systems. By monitoring the moisture and temperature levels of the soil, the sensors ensure just the right amount of water is used—where and when it's needed most—to ensure a healthy and lush landscape. Just set and forget.

	MODEL	LIST	FINISH/CONNECT	CASE QTY
SMART WIRELESS SOIL SENSOR - PREMIUM				
<ul style="list-style-type: none"> • wireless connection directly to Moen Smart Sprinkler Controller to automatically adjust watering schedule based on exact soil moisture • measure soil moisture and temperature levels at 1, 3 and 5-inch depths • recommend one sensor per zone 	WISNS002G1USA	113.70	Wireless Soil Sensor - 1 Pk	3



Smart Sprinkler Controller Outdoor Enclosure

The Moen Smart Sprinkler Controller Outdoor Enclosure securely houses the Moen Smart Sprinkler Controller to protect the device in outdoor installation settings. The water-tight enclosure is made of high-grade plastic and is certified for outdoor electrical systems to ensure it can withstand outdoor weather conditions and keep your controller protected and running uninterrupted.

	MODEL	LIST	FINISH/CONNECT	CASE QTY
SMART SPRINKLER CONTROLLER OUTDOOR ENCLOSURE - PREMIUM				
<ul style="list-style-type: none"> • enables Moen Smart Sprinkler Controller to be installed outdoors • fits 8 or 16 zone Smart Sprinkler Controllers 	WIACC001G1USA	81.50	Outdoor Enclosure	12





Kitchen and Bar

Your kitchen is an extension of you. Whether you are an avid at-home chef or a take-out connoisseur, Moen® offers faucets with the best of style, smarts and technology to enhance every experience at the sink. With diverse finish and installation options, you can perfectly curate your kitchen to your unique lifestyle and routine.

Tenon® Smart Faucet with Motion Control | S74001EV2

MAKE A STATEMENT AT THE SINK





Kitchen and Bar

COLLECTIONS

- 62 Smart Faucets
- 74 Premium Faucets
- 80 Faucets
- 95 Premium Pot Fillers
- 96 Premium Bar/Prep
- 98 Bar/Prep
- 101 Laundry Faucets
- 102 Water Filtration Systems & Faucets
- 109 Premium Soap Dispensers

FINISHES

- Chrome
 - Spot Resist Stainless
 - Matte Black
 - Polished Nickel
 - Oil Rubbed Bronze
 - Black Stainless
 - Brushed Gold
 - Bronzed Gold
- LifeShine® Non-Tarnish Finish**
All Bronzed Gold, Brushed Gold and Polished Nickel faucet components feature the LifeShine Non-Tarnish Finish.

Want to add Water Filtration or a Soap Dispenser in the Kitchen?
See pages 102-111.

Bar/Prep faucet available.
See pages 96-100.

Deck Extension kits available on
page 557.

ICON KEY



MotionSense Wave™ Hands-Free Faucet
MotionSense Wave single-sensor faucets allow you to easily turn water on and off with the wave of a hand.



Offers 3 times more reach when compared to most residential pre-rinse sprayer faucets.



Spot Resist™ Stainless

Spot Resist Stainless finish resists fingerprints and water spots for a cleaner looking kitchen.

DURALOCK®

Push-button connector that makes installing faucets quick, secure and hassle-free – no tools required. A telltale 'click' audibly signals a secure connection.

DURALAST®

Duralast Cartridge

Provides the smooth feel and reliable operation of a new faucet from the first time you use it to the last.

reflex

Secure retraction, range of motion, and flexibility. Works in unison as a complete system of innovations.

POWERBOOST PRO

Faucets with Power Boost Pro offer a variable flow rate from 1.1-2.2 GPM to meet any need for improved cleaning spray, reduced splash and the ability to save water with a low-flow stream that won't sacrifice experience.

POWERBOOST™

Boosted stream fills pots and pitchers faster, while the boosted spray cleans 50 percent faster than other Moen faucets without Power Clean™ or Power Boost™ technology.

POWER CLEAN™

Cleans 50 percent faster than most Moen pulldowns and pullout faucets without Power Clean™ or Power Boost™ technology while containing splash and minimizing mess.

MAGNETIX™

Magnetic docking system. Faucet wand returns effortlessly for secure docking.



Also available in bulk pack.
See page 597.



KITCHEN TOUCHLESS FAUCETS



Smart Faucet with Motion Control

- Nio™
- Tenon™ **NEW!**
- Weymouth®
- Sinema™
- Paterson™
- Cia™ **NEW!**
- Kurv™ **NEW!**
- Smyth™ **NEW!**

Smart Faucet

- Cia™
- Align®
- KURV™
- Arbor®
- Belfield™
- Steek®

MotionSense Wave™

- Weymouth®
- Sinema™
- Cia™
- Align®
- KURV™
- Smyth™ **NEW!**
- Brantford®
- Arbor®
- Belfield™
- Genta™ LX
- Steek®

Touchless Kitchen Faucets

For the busiest room in your home, select Moen faucets use touchless technology and voice control to make life easier in the kitchen. If your hands are occupied or messy, or you're concerned about the spread of germs, you'll love our touchless features.

The Smart Faucet with Motion Control is the only faucet you never have to touch, offering advanced sensor technology that allows you to control the temperature of water with a simple hand motion, as well as voice control.

The Smart Faucet makes every day easier by allowing you to precisely control with your voice or a wave of your hand the amount of water you use.

MotionSense Wave™ allows you to turn water on and off with just the wave of a hand with no need to touch the faucet handle to start the flow. The faucet also offers manual operation as an optional choice.











	MODEL	LIST	FINISH/CONNECT	CASE QTY
NIO™ SMART FAUCET WITH MOTION CONTROL ONE-HANDLE KITCHEN PULLDOWN - PREMIUM				
 	<ul style="list-style-type: none"> • application: one hole • spout height: 18.38" • connection: 3/8" compression • number of functions: four-function • spray type: aerated stream; powerful cleaning rinse; boosted rinse; boosted stream • handle mounting: right only • hose length: 68" • secondary two-tone handle option included: chrome faucet has matte black handle; matte black faucet has brushed gold handle; spot resist faucet has matte black handle; black stainless faucet has spot resist stainless handle • AC adapter included • DC powered: 6 D-cell batteries included • voice activated kitchen: compatible with Amazon Just Ask Alexa and Works with Google Assistant 			
	1.5 GPM (5.7 L/min) max.			
	S75005EV2C	1182.35	Chrome	3
	S75005EV2SRS●	1300.55	Spot Resist Stainless	3
	S75005EV2BL	1359.70	Matte Black	3
S75005EV2BLS●	1418.75	Black Stainless	3	
OPTIONAL WALL MOUNT & HOSE EXTENSION KIT SOLD SEPARATELY				
199785	59.75	N/A or Unfinished	6	
 POWERBOOST reflex  DURALOCK  DURALAST				



TOUCHLESS Kitchen Faucets

TOUCHLESS KITCHEN

	MODEL	LIST	FINISH/CONNECT	CASE QTY
TENON™ SMART FAUCET WITH MOTION CONTROL ONE-HANDLE KITCHEN PULLDOWN - PREMIUM				
  	<ul style="list-style-type: none"> • application: one hole • spout height: 17.69" • connection: 3/8" compression • number of functions: four-function • spray type: aerated stream; powerful cleaning rinse; boosted rinse; boosted stream • handle mounting: right only • hose length: 68" • unique wood handle assembled on faucet • secondary matching finish handle option included • AC adapter included • DC powered: 6 D-cell batteries included • voice activated kitchen: compatible with Amazon Just Ask Alexa and Works with Google Assistant 			
	1.5 GPM (5.7 L/min) max.			
	S74001EV2C	1111.00	Chrome	3
	S74001EV2SRS●	1233.20	Spot Resist Stainless	3
	S74001EV2BL	1277.70	Matte Black	3
S74001EV2BG	1333.20	Brushed Gold	3	
OPTIONAL WALL MOUNT & HOSE EXTENSION KIT SOLD SEPARATELY				
199785	59.75	N/A or Unfinished	6	
 POWERBOOST reflex  DURALOCK® DURALAST®				



	MODEL	LIST	FINISH/CONNECT	CASE QTY
WEYMOUTH® SMART FAUCET WITH MOTION CONTROL ONE-HANDLE KITCHEN PULLDOWN - PREMIUM				
 	<ul style="list-style-type: none"> • spray wand: metal • application: one hole • spout height: 17.00" • connection: 3/8" compression • number of functions: four-function • spray type: aerated stream; powerful cleaning rinse; boosted rinse; boosted stream • handle mounting: right only • hose length: 68" • includes: choice of matching finish or porcelain handle caps • AC adapter included • DC powered: 6 D-cell batteries included • voice activated kitchen: compatible with Amazon Just Ask Alexa and Works with Google Assistant 			
	1.5 GPM (5.7 L/min) max.			
	S73004EV2C	1061.55	Chrome	3
	S73004EV2SRS●	1167.70	Spot Resist Stainless	3
	S73004EV2BL	1220.75	Matte Black	3
S73004EV2NL	1273.85	Polished Nickel	3	
S73004EV2ORB	1273.85	Oil Rubbed Bronze	3	
S73004EV2BG	1273.85	Brushed Gold	3	
OPTIONAL WALL MOUNT & HOSE EXTENSION KIT SOLD SEPARATELY				
199785	59.75	N/A or Unfinished	6	
 POWERBOOST reflex  DURALOCK® DURALAST®				



	MODEL	LIST	FINISH/CONNECT	CASE QTY
SINEMA™ SMART FAUCET WITH MOTION CONTROL ONE-HANDLE KITCHEN PULLDOWN - PREMIUM				
 	<ul style="list-style-type: none"> • spray wand: metal • application: one hole • spout height: 17.75" • connection: 3/8" compression • number of functions: four-function • spray type: aerated stream; powerful cleaning rinse; boosted rinse; boosted stream • handle mounting: right only • hose length: 68" • two-tone art deco-inspired etched handle installed on faucet; secondary matching finish handle option included • AC adapter included • DC powered: 6 D-cell batteries included • voice activated kitchen: compatible with Amazon Just Ask Alexa and Works with Google Assistant 			
	1.5 GPM (5.7 L/min) max.			
	S7235EV2C	1196.50	Chrome	3
	S7235EV2SRS●	1316.10	Spot Resist Stainless	3
	S7235EV2BL	1375.95	Matte Black	3
S7235EV2NL	1435.80	Polished Nickel	3	
OPTIONAL WALL MOUNT & HOSE EXTENSION KIT SOLD SEPARATELY				
199785	59.75	N/A or Unfinished	6	
 POWERBOOST reflex  DURALOCK® DURALAST®				



TOUCHLESS Kitchen Faucets

MODEL		LIST	FINISH/CONNECT	CASE QTY
PATERSON™ SMART FAUCET WITH MOTION CONTROL ONE-HANDLE KITCHEN PULLDOWN – PREMIUM				
	<ul style="list-style-type: none"> • application: one hole • spout height: 17.00" • connection: 3/8" compression • number of functions: four-function • spray type: aerated stream; powerful cleaning rinse; boosted rinse; boosted stream • handle mounting: right only • secondary wheel handle option: included • hose length: 68" • AC adapter included • DC powered: 6 D-cell batteries included • voice activated kitchen: compatible with Amazon Just Ask Alexa and Works with Google Assistant 		1.5 GPM (5.7 L/min) max.	
	S72003EV2C	1040.20	Chrome	3
	S72003EV2SRS●	1144.20	Spot Resist Stainless	3
	S72003EV2BL	1196.20	Matte Black	3
OPTIONAL WALL MOUNT & HOSE EXTENSION KIT SOLD SEPARATELY				
199785	59.75	N/A or Unfinished	6	
				

MODEL		LIST	FINISH/CONNECT	CASE QTY
CIA™ SMART FAUCET WITH MOTION CONTROL ONE-HANDLE KITCHEN PULLDOWN				
 <p>DECKPLATE SOLD SEPARATELY</p> <p>NEW! Q2</p>	<ul style="list-style-type: none"> • application: one hole • spout height: 16.86" • connection: 3/8" compression • number of functions: four-function • spray type: aerated stream; powerful cleaning rinse; boosted rinse; boosted stream • handle mounting: right only • secondary accent escutcheon option included: chrome faucet has optional matte black; spot resist stainless has chrome; matte black has brushed gold and chrome; brushed gold has matte black • hose length: 68" • AC adapter included • DC powered: 6 D-cell batteries included • voice activated kitchen: compatible with Amazon Just Ask Alexa and Works with Google Assistant 		1.5 GPM (5.7 L/min) max.	
	7622EV2C	922.80	Chrome	3
	7622EV2SRS●	1015.10	Spot Resist Stainless	3
	7622EV2BL	1061.20	Matte Black	3
7622EV2BG	1107.35	Brushed Gold	3	
OPTIONAL DECKPLATE SOLD SEPARATELY				
141002	57.75	Chrome	6	
141002SRS●	66.25	Spot Resist Stainless	6	
141002BL	66.25	Matte Black	6	
141002BG	66.25	Brushed Gold	6	
OPTIONAL WALL MOUNT & HOSE EXTENSION KIT SOLD SEPARATELY				
199785	59.75	N/A or Unfinished	6	
				

MODEL		LIST	FINISH/CONNECT	CASE QTY
KURV™ SMART FAUCET WITH MOTION CONTROL ONE-HANDLE KITCHEN PULLDOWN				
 <p>DECKPLATE SOLD SEPARATELY</p> <p>NEW! Q2</p>	<ul style="list-style-type: none"> • spray wand: metal • application: one hole • spout height: 16.38" • connection: 3/8" compression • number of functions: four-function • spray type: aerated stream; powerful cleaning rinse; boosted rinse; boosted stream • handle mounting: right only • hose length: 68" • AC adapter included • DC powered: 6 D-cell batteries included • voice activated kitchen: compatible with Amazon Just Ask Alexa and Works with Google Assistant 		1.5 GPM (5.7 L/min) max.	
	9126EV2C	880.15	Chrome	3
	9126EV2SRS●	968.15	Spot Resist Stainless	3
	9126EV2BL	1012.15	Matte Black	3
9126EV2NL	1056.15	Polished Nickel	3	
OPTIONAL DECKPLATE SOLD SEPARATELY				
141002	57.75	Chrome	6	
141002SRS●	66.25	Spot Resist Stainless	6	
141002BL	66.25	Matte Black	6	
141002NL	62.85	Polished Nickel	6	
OPTIONAL WALL MOUNT & HOSE EXTENSION KIT SOLD SEPARATELY				
199785	59.75	N/A or Unfinished	6	
				













TOUCHLESS KITCHEN

TOUCHLESS Kitchen Faucets

TOUCHLESS KITCHEN



		MODEL	LIST	FINISH/CONNECT	CASE QTY
SMYTH™		SMART FAUCET WITH MOTION CONTROL ONE-HANDLE KITCHEN PULLDOWN			
 DECKPLATE SOLD SEPARATELY 	<ul style="list-style-type: none"> • application: one hole • spout height: 16.50" • connection: 3/8" compression • number of functions: four-function • spray type: aerated stream; powerful cleaning rinse; boosted rinse; boosted stream • handle mounting: right only • hose length: 68" • AC adapter included • DC powered: 6 D-cell batteries included • voice activated kitchen: compatible with Amazon Just Ask Alexa and Works with Google Assistant 	1.5 GPM (5.7 L/min) max.			
			7770EV2SRS●	905.50	Spot Resist Stainless
7770EV2BL	946.65		Matte Black	3	
		7770EV2NL	987.80	Polished Nickel	3
		7770EV2BZG	987.80	Bronzed Gold	3
		OPTIONAL WALL MOUNT & HOSE EXTENSION KIT SOLD SEPARATELY			
		199785	59.75	N/A or Unfinished	6
		 POWERBOOST reflex  DURALOCK® DURALAST®			



		MODEL	LIST	FINISH/CONNECT	CASE QTY
CIA™		SMART FAUCET ONE-HANDLE KITCHEN PULLDOWN			
 DECKPLATE SOLD SEPARATELY 	<ul style="list-style-type: none"> • application: one or three hole • spout height: 16.86" • connection: 3/8" compression • number of functions: four-function • spray type: aerated stream; powerful cleaning rinse; boosted rinse; boosted stream • handle mounting: right only • hose length: 68" • secondary accent escutcheon option included: chrome faucet has optional matte black; spot resist stainless has chrome; matte black has brushed gold and chrome; brushed gold has matte black • DC powered: 6 D-cell batteries included • voice activated kitchen: compatible with Amazon Just Ask Alexa and Works with Google Assistant 	1.5 GPM (5.7 L/min) max.			
			7622EVC	930.55	Chrome
7622EVSRS●	1023.60		Spot Resist Stainless	3	
		7622EVBL	1070.15	Matte Black	3
		7622EVBG	1116.65	Brushed Gold	3
		OPTIONAL DECKPLATE SOLD SEPARATELY			
		141002	57.75	Chrome	6
		141002SRS●	66.25	Spot Resist Stainless	6
		141002BL	66.25	Matte Black	6
		141002BG	66.25	Brushed Gold	6
		OPTIONAL AC ADAPTERS SOLD SEPARATELY			
		169031	159.60	N/A or Unfinished	12
		OPTIONAL WALL MOUNT & HOSE EXTENSION KIT SOLD SEPARATELY			
		199785	59.75	N/A or Unfinished	6
		 POWERBOOST reflex  DURALOCK® DURALAST®			



		MODEL	LIST	FINISH/CONNECT	CASE QTY
ALIGN®		SMART FAUCET ONE-HANDLE KITCHEN PULLDOWN			
 DECKPLATE SOLD SEPARATELY 	<ul style="list-style-type: none"> • application: one or three hole • spout height: 15.70" • connection: 3/8" compression • number of functions: four-function • spray type: aerated stream; powerful cleaning rinse; boosted rinse; boosted stream • handle mounting: right only • hose length: 68" • DC powered: 6 D-cell batteries included • voice activated kitchen: compatible with Amazon Just Ask Alexa and Works with Google Assistant 	1.5 GPM (5.7 L/min) max.			
			7565EVC	906.05	Chrome
7565EVSRS●	996.65		Spot Resist Stainless	3	
		7565EVBL	1042.00	Matte Black	3
		7565EVBLS●	1087.25	Black Stainless	3
		7565EVBG	1087.25	Brushed Gold	3
		OPTIONAL DECKPLATE SOLD SEPARATELY			
		141002	57.75	Chrome	6
		141002SRS●	66.25	Spot Resist Stainless	6
		141002BL	66.25	Matte Black	6
		141002BLS●	72.90	Black Stainless	6
		141002BG	66.25	Brushed Gold	6
		OPTIONAL AC ADAPTERS SOLD SEPARATELY			
		169031	159.60	N/A or Unfinished	12
		OPTIONAL WALL MOUNT & HOSE EXTENSION KIT SOLD SEPARATELY			
		199785	59.75	N/A or Unfinished	6
		 POWERBOOST reflex  DURALOCK® DURALAST®			





TOUCHLESS Kitchen Faucets

	MODEL	LIST	FINISH/CONNECT	CASE QTY	
KURV™ SMART FAUCET ONE-HANDLE KITCHEN PULLDOWN					
 <p>DECKPLATE SOLD SEPARATELY</p> <ul style="list-style-type: none"> • spray wand: metal • application: one or three hole • spout height: 16.38" • connection: 3/8" compression • number of functions: four-function • spray type: aerated stream; powerful cleaning rinse; boosted rinse; boosted stream • handle mounting: right only • hose length: 68" • DC powered: 6 D-cell batteries included • voice activated kitchen: compatible with Amazon Just Ask Alexa and Works with Google Assistant 	1.5 GPM (5.7 L/min) max.				
	9126EVC	887.50	Chrome	3	
	9126EVSRS●	976.30	Spot Resist Stainless	3	
	9126EVB�	1020.65	Matte Black	3	
	9126EVNL	1065.00	Polished Nickel	3	
	OPTIONAL DECKPLATE SOLD SEPARATELY				
	141002	57.75	Chrome	6	
	141002SRS●	66.25	Spot Resist Stainless	6	
	141002BL	66.25	Matte Black	6	
	141002NL	62.85	Polished Nickel	6	
OPTIONAL AC ADAPTERS SOLD SEPARATELY					
169031	159.60	N/A or Unfinished	12		
OPTIONAL WALL MOUNT & HOSE EXTENSION KIT SOLD SEPARATELY					
199785	59.75	N/A or Unfinished	6		
					

BRANTFORD® SMART FAUCET ONE-HANDLE KITCHEN PULLDOWN					
 <p>DECKPLATE INCLUDED</p> <ul style="list-style-type: none"> • application: one or three hole • spout height: 15.50" • connection: 3/4" compression • number of functions: four-function • spray type: aerated stream; powerful cleaning rinse; boosted rinse; boosted stream • handle mounting: right only • hose length: 68" • deckplate: included • DC powered: 6 D-cell batteries included • voice activated kitchen: compatible with Amazon Just Ask Alexa and Works with Google Assistant 	1.5 GPM (5.7 L/min) max.				
	7185EVC	827.30	Chrome	3	
	7185EVSRS●	910.05	Spot Resist Stainless	3	
	7185EVORB	992.80	Oil Rubbed Bronze	3	
	OPTIONAL AC ADAPTERS SOLD SEPARATELY				
	169031	159.60	N/A or Unfinished	12	
	OPTIONAL WALL MOUNT & HOSE EXTENSION KIT SOLD SEPARATELY				
	199785	59.75	N/A or Unfinished	6	
					

ARBOR® SMART FAUCET ONE-HANDLE KITCHEN PULLDOWN					
 <p>DECKPLATE INCLUDED</p> <ul style="list-style-type: none"> • application: one or three hole • spout height: 15.50" • connection: 3/8" compression • number of functions: four-function • spray type: aerated stream; powerful cleaning rinse; boosted rinse; boosted stream • handle mounting: right only • hose length: 68" • deckplate: included • DC powered: 6 D-cell batteries included • voice activated kitchen: compatible with Amazon Just Ask Alexa and Works with Google Assistant 	1.5 GPM (5.7 L/min) max.				
	7594EVC	804.35	Chrome	3	
	7594EVSRS●	884.80	Spot Resist Stainless	3	
	7594EVB�	925.05	Matte Black	3	
	7594EVORB	965.25	Oil Rubbed Bronze	3	
	OPTIONAL AC ADAPTERS SOLD SEPARATELY				
	169031	159.60	N/A or Unfinished	12	
	OPTIONAL WALL MOUNT & HOSE EXTENSION KIT SOLD SEPARATELY				
	199785	59.75	N/A or Unfinished	6	
					





BELFIELD™ SMART FAUCET ONE-HANDLE KITCHEN PULLDOWN					
 <p>DECKPLATE INCLUDED</p> <ul style="list-style-type: none"> • application: one or three hole • spout height: 15.62" • connection: 3/8" compression • number of functions: four-function • spray type: aerated stream; powerful cleaning rinse; boosted rinse; boosted stream • handle mounting: right only • hose length: 68" • deckplate: included • DC powered: 6 D-cell batteries included • voice activated kitchen: compatible with Amazon Just Ask Alexa and Works with Google Assistant 	1.5 GPM (5.7 L/min) max.				
	7260EVC	792.30	Chrome	3	
	7260EVSRS●	871.55	Spot Resist Stainless	3	
	7260EVB�	911.10	Matte Black	3	
	7260EVORB	950.75	Oil Rubbed Bronze	3	
	OPTIONAL AC ADAPTERS SOLD SEPARATELY				
	169031	159.60	N/A or Unfinished	12	
	OPTIONAL WALL MOUNT & HOSE EXTENSION KIT SOLD SEPARATELY				
	199785	59.75	N/A or Unfinished	6	
					











TOUCHLESS KITCHEN

TOUCHLESS Kitchen Faucets

TOUCHLESS KITCHEN



	MODEL	LIST	FINISH/CONNECT	CASE QTY
SLEEK® SMART FAUCET ONE-HANDLE KITCHEN PULLDOWN				
 DECKPLATE INCLUDED 	<ul style="list-style-type: none"> • application: one or three hole • spout height: 15.56" • connection: 3/8" compression • number of functions: four-function • spray type: aerated stream; powerful cleaning rinse; boosted rinse; boosted stream • handle mounting: right only • hose length: 68" • deckplate: included • DC powered: 6 D-cell batteries included • voice activated kitchen: compatible with Amazon Just Ask Alexa and Works with Google Assistant 			
	1.5 GPM (5.7 L/min) max.			
	7864EVC	751.10	Chrome	3
	7864EVSRS●	826.15	Spot Resist Stainless	3
	7864EVBL	863.75	Matte Black	3
	7864EVBLS●	901.25	Black Stainless	3
	7864EVBG	901.25	Brushed Gold	3
	OPTIONAL AC ADAPTERS SOLD SEPARATELY			
	169031	159.60	N/A or Unfinished	12
	OPTIONAL WALL MOUNT & HOSE EXTENSION KIT SOLD SEPARATELY			
199785	59.75	N/A or Unfinished	6	
 POWERBOOST  DURALOCK® DURALAST®				



	MODEL	LIST	FINISH/CONNECT	CASE QTY
WEYMOUTH® TOUCHLESS WITH MOTIONSENSE™ WAVE ONE-HANDLE SPRING KITCHEN PULLDOWN - PREMIUM				
 	<ul style="list-style-type: none"> • spray wand: metal • application: one hole • spout height: 21.75" • connection: 3/8" compression • number of functions: two-function • spray type: aerated stream; powerful cleaning rinse • handle mounting: right only • hose length: 68" • DC powered: 6 AA cell batteries included • includes: choice of matching finish or porcelain handle caps 			
	1.5 GPM (5.7 L/min) max.			
	S73104EWC	1032.65	Chrome	3
	S73104EWSRS●	1290.85	Spot Resist Stainless	3
	S73104EWBL	1342.50	Matte Black	3
	S73104EWNL	1394.10	Polished Nickel	3
	S73104EWORB	1445.75	Oil Rubbed Bronze	3
	S73104EWBG	1497.40	Brushed Gold	3
	OPTIONAL AC ADAPTERS SOLD SEPARATELY			
	169031	159.60	N/A or Unfinished	12
OPTIONAL WALL MOUNT & HOSE EXTENSION KIT SOLD SEPARATELY				
177566	49.05	N/A or Unfinished	6	
 MOTIONSENSE™ POWER CLEAN DURALOCK® DURALAST® 				



	MODEL	LIST	FINISH/CONNECT	CASE QTY
SINEMA™ TOUCHLESS WITH MOTIONSENSE™ WAVE ONE-HANDLE SPRING KITCHEN PULLDOWN - PREMIUM				
 	<ul style="list-style-type: none"> • spray wand: metal • application: one hole • spout height: 23.5" • connection: 3/8" compression • number of functions: two-function • spray type: aerated stream; powerful cleaning rinse • handle mounting: right only • hose length: 68" • two-tone art deco-inspired etched handle installed on faucet; secondary matching finish handle option included • DC powered: 6 AA cell batteries included 			
	1.5 GPM (5.7 L/min) max.			
	S5235EWC	1049.45	Chrome	3
	S5235EWSRS●	1311.75	Spot Resist Stainless	3
	S5235EWBL	1364.30	Matte Black	3
	S5235EWNL	1416.75	Polished Nickel	3
	OPTIONAL AC ADAPTERS SOLD SEPARATELY			
	169031	159.60	N/A or Unfinished	12
	OPTIONAL WALL MOUNT & HOSE EXTENSION KIT SOLD SEPARATELY			
	177566	49.05	N/A or Unfinished	6
 MOTIONSENSE™ POWER CLEAN DURALOCK® DURALAST® 				



TOUCHLESS Kitchen Faucets





	MODEL	LIST	FINISH/CONNECT	CASE QTY	
CIA™ TOUCHLESS WITH MOTIONSENSE™ WAVE ONE-HANDLE KITCHEN PULLDOWN					
 <p>DECKPLATE SOLD SEPARATELY</p> <ul style="list-style-type: none"> • application: one or three hole • spout height: 16.86" • connection: 3/8" compression • number of functions: two-function • spray type: aerated stream; powerful cleaning rinse • handle mounting: right only • hose length: 68" • secondary accent escutcheon option included: chrome faucet has optional matte black; spot resist stainless has chrome; matte black has brushed gold and chrome; brushed gold has matte black • DC powered: 6 AA cell batteries included 	1.5 GPM (5.7 L/min) max.				
	7622EWC	766.30	Chrome	3	
	7622EWSRS●	957.90	Spot Resist Stainless	3	
	7622EWBL	996.20	Matte Black	3	
	7622EWBG	1111.15	Brushed Gold	3	
	OPTIONAL DECKPLATE SOLD SEPARATELY				
	141002	57.75	Chrome	6	
	141002SRS●	66.25	Spot Resist Stainless	6	
	141002BL	66.25	Matte Black	6	
	141002BG	66.25	Brushed Gold	6	
OPTIONAL AC ADAPTERS SOLD SEPARATELY					
169031	159.60	N/A or Unfinished	12		
OPTIONAL WALL MOUNT & HOSE EXTENSION KIT SOLD SEPARATELY					
177566	49.05	N/A or Unfinished	6		
 POWER CLEAN reflex DURALOCK® DURALAST®					





	MODEL	LIST	FINISH/CONNECT	CASE QTY	
ALIGN® TOUCHLESS WITH MOTIONSENSE™ WAVE ONE-HANDLE SPRING KITCHEN PULLDOWN					
 <p>DECKPLATE SOLD SEPARATELY</p> <ul style="list-style-type: none"> • application: one or three hole • spout height: 21.75" • connection: 3/8" compression • number of functions: two-function • spray type: aerated stream; powerful cleaning rinse • handle mounting: right only • hose length: 68" • DC powered: 6 AA cell batteries included 	1.5 GPM (5.7 L/min) max.				
	5923EWC	809.45	Chrome	3	
	5923EWSRS●	1011.80	Spot Resist Stainless	3	
	5923EWBL	1052.25	Matte Black	3	
	5923EWBLS●	1173.65	Black Stainless	3	
	5923EWBG	1173.65	Brushed Gold	3	
	OPTIONAL DECKPLATE SOLD SEPARATELY				
	141002	57.75	Chrome	6	
	141002SRS●	66.25	Spot Resist Stainless	6	
	141002BL	66.25	Matte Black	6	
141002BLS●	72.90	Black Stainless	6		
141002BG	66.25	Brushed Gold	6		
OPTIONAL AC ADAPTERS SOLD SEPARATELY					
169031	159.60	N/A or Unfinished	12		
OPTIONAL WALL MOUNT & HOSE EXTENSION KIT SOLD SEPARATELY					
177566	49.05	N/A or Unfinished	6		
 POWER CLEAN DURALOCK® DURALAST® 3x					





	MODEL	LIST	FINISH/CONNECT	CASE QTY	
ALIGN® TOUCHLESS WITH MOTIONSENSE™ WAVE ONE-HANDLE KITCHEN PULLDOWN					
 <p>DECKPLATE SOLD SEPARATELY</p> <ul style="list-style-type: none"> • application: one or three hole • spout height: 15.70" • connection: 3/8" compression • number of functions: two-function • spray type: aerated stream; powerful cleaning rinse • handle mounting: right only • hose length: 68" • DC powered: 6 AA cell batteries included 	1.5 GPM (5.7 L/min) max.				
	7565EWC	741.05	Chrome	3	
	7565EWSRS●	926.35	Spot Resist Stainless	3	
	7565EWBL	963.35	Matte Black	3	
	7565EWBLS●	1074.50	Black Stainless	3	
	7565EWBG	1074.50	Brushed Gold	3	
	OPTIONAL DECKPLATE SOLD SEPARATELY				
	141002	57.75	Chrome	6	
	141002SRS●	66.25	Spot Resist Stainless	6	
	141002BL	66.25	Matte Black	6	
141002BLS●	72.90	Black Stainless	6		
141002BG	66.25	Brushed Gold	6		
OPTIONAL AC ADAPTERS SOLD SEPARATELY					
169031	159.60	N/A or Unfinished	12		
OPTIONAL WALL MOUNT & HOSE EXTENSION KIT SOLD SEPARATELY					
177566	49.05	N/A or Unfinished	6		
 POWER CLEAN reflex DURALOCK® DURALAST®					

TOUCHLESS KITCHEN



TOUCHLESS Kitchen Faucets



	MODEL	LIST	FINISH/CONNECT	CASE QTY
KURV™ TOUCHLESS WITH MOTIONSENSE™ WAVE ONE-HANDLE KITCHEN PULLDOWN				
 DECKPLATE SOLD SEPARATELY 	<ul style="list-style-type: none"> • spray wand: metal • application: one or three hole • spout height: 16.38" • connection: 3/8" compression • number of functions: two-function • spray type: aerated stream; powerful cleaning rinse • handle mounting: right only • hose length: 68" • DC powered: 6 AA cell batteries included 			
	1.5 GPM (5.7 L/min) max.			
	9126EWC	723.30	Chrome	3
	9126EWSRS●	904.10	Spot Resist Stainless	3
	9126EWBL	940.30	Matte Black	3
	9126EWNL	976.45	Polished Nickel	3
	OPTIONAL DECKPLATE SOLD SEPARATELY			
	141002	57.75	Chrome	6
	141002SRS●	66.25	Spot Resist Stainless	6
	141002BL	66.25	Matte Black	6
141002NL	62.85	Polished Nickel	6	
OPTIONAL AC ADAPTERS SOLD SEPARATELY				
169031	159.60	N/A or Unfinished	12	
OPTIONAL WALL MOUNT & HOSE EXTENSION KIT SOLD SEPARATELY				
177566	49.05	N/A or Unfinished	6	
 POWER CLEAN reflex  DURALAST®				



	MODEL	LIST	FINISH/CONNECT	CASE QTY
SMYTH™ TOUCHLESS WITH MOTIONSENSE™ WAVE ONE-HANDLE KITCHEN PULLDOWN				
 DECKPLATE SOLD SEPARATELY 	<ul style="list-style-type: none"> • application: one or three hole • spout height: 16.50" • connection: 3/8" compression • number of functions: two-function • spray type: aerated stream; powerful cleaning rinse • handle mounting: right only • hose length: 68" • DC powered: 6 AA cell batteries included 			
	1.5 GPM (5.7 L/min) max.			
	7770EWSRS●	831.25	Spot Resist Stainless	3
	7770EWBL	864.50	Matte Black	3
	7770EWNL	897.75	Polished Nickel	3
	7770EWBZG	964.25	Bronzed Gold	3
	OPTIONAL DECKPLATE SOLD SEPARATELY			
	141002SRS●	66.25	Spot Resist Stainless	6
	141002BL	66.25	Matte Black	6
	141002NL	62.85	Polished Nickel	6
OPTIONAL AC ADAPTERS SOLD SEPARATELY				
169031	159.60	N/A or Unfinished	12	
OPTIONAL WALL MOUNT & HOSE EXTENSION KIT SOLD SEPARATELY				
177566	49.05	N/A or Unfinished	6	
 POWER CLEAN reflex  DURALAST®				



	MODEL	LIST	FINISH/CONNECT	CASE QTY
BRANTFORD® TOUCHLESS WITH MOTIONSENSE™ WAVE ONE-HANDLE KITCHEN PULLDOWN				
 DECKPLATE INCLUDED 	<ul style="list-style-type: none"> • application: one or three hole • spout height: 15.50" • connection: 3/8" compression • number of functions: two-function • spray type: powerful cleaning rinse; aerated stream • handle mounting: right only • hose length: 68" • deckplate: included • DC powered: 6 AA cell batteries: included 			
	1.5 GPM (5.7 L/min) max.			
	7185EWC	653.85	Chrome	3
	7185EWSRS●	817.35	Spot Resist Stainless	3
	7185EWORB	915.40	Oil Rubbed Bronze	3
	OPTIONAL AC ADAPTERS SOLD SEPARATELY			
	169031	159.60	N/A or Unfinished	12
	OPTIONAL WALL MOUNT & HOSE EXTENSION KIT SOLD SEPARATELY			
	177566	49.05	N/A or Unfinished	6
	 POWER CLEAN reflex  DURALAST®			

TOUCHLESS Kitchen Faucets

		MODEL	LIST	FINISH/CONNECT	CASE QTY
ARBOR® TOUCHLESS WITH MOTIONSENSE™ WAVE ONE-HANDLE KITCHEN PULLDOWN					
 DECKPLATE INCLUDED 	<ul style="list-style-type: none"> • application: one or three hole • spout height: 15.50" • connection: 3/8" compression • number of functions: two-function • spray type: powerful cleaning rinse; aerated stream • handle mounting: right only • hose length: 68" • deckplate: included • DC powered: 6 AA cell batteries: included 	1.5 GPM (5.7 L/min) max.			
		7594EWC	631.30	Chrome	3
		7594EWSRS●	789.10	Spot Resist Stainless	3
		7594EWBL	820.65	Matte Black	3
		7594EWORB	883.80	Oil Rubbed Bronze	3
OPTIONAL AC ADAPTERS SOLD SEPARATELY					
		169031	159.60	N/A or Unfinished	12
OPTIONAL WALL MOUNT & HOSE EXTENSION KIT SOLD SEPARATELY					
		177566	49.05	N/A or Unfinished	6
 POWER CLEAN reflex DURALOCK® DURALAST®					





		MODEL	LIST	FINISH/CONNECT	CASE QTY
BELFIELD™ TOUCHLESS WITH MOTIONSENSE™ WAVE ONE-HANDLE KITCHEN PULLDOWN					
 DECKPLATE INCLUDED 	<ul style="list-style-type: none"> • application: one or three hole • spout height: 15.62" • connection: 3/8" compression • number of functions: two-function • spray type: aerated stream; powerful cleaning rinse • handle mounting: right only • hose length: 68" • deckplate: included • DC powered: 6 AA cell batteries: included 	1.5 GPM (5.7 L/min) max.			
		7260EWC	619.45	Chrome	3
		7260EWSRS●	774.30	Spot Resist Stainless	3
		7260EWBL	805.30	Matte Black	3
		7260EWORB	867.20	Oil Rubbed Bronze	3
OPTIONAL AC ADAPTERS SOLD SEPARATELY					
		169031	159.60	N/A or Unfinished	12
OPTIONAL WALL MOUNT & HOSE EXTENSION KIT SOLD SEPARATELY					
		177566	49.05	N/A or Unfinished	6
 POWER CLEAN reflex DURALOCK® DURALAST®					

		MODEL	LIST	FINISH/CONNECT	CASE QTY
GENTA™ LX TOUCHLESS WITH MOTIONSENSE™ WAVE ONE-HANDLE KITCHEN PULLDOWN					
 DECKPLATE INCLUDED 	<ul style="list-style-type: none"> • application: one or three hole • spout height: 16.00" • connection: 3/8" compression • number of functions: two-function • spray type: aerated stream; powerful cleaning rinse • handle mounting: right only • hose length: 68" • deckplate: included • DC powered: 6 AA cell batteries: included 	1.5 GPM (5.7 L/min) max.			
		7882EWC	617.85	Chrome	3
		7882EWSRS●	772.35	Spot Resist Stainless	3
		7882EWBL	803.25	Matte Black	3
OPTIONAL AC ADAPTERS SOLD SEPARATELY					
		169031	159.60	N/A or Unfinished	12
OPTIONAL WALL MOUNT & HOSE EXTENSION KIT SOLD SEPARATELY					
		177566	49.05	N/A or Unfinished	6
 POWER CLEAN reflex DURALOCK® DURALAST®					

		MODEL	LIST	FINISH/CONNECT	CASE QTY
SLEEK® TOUCHLESS WITH MOTIONSENSE™ WAVE ONE-HANDLE SPRING KITCHEN PULLDOWN					
 DECKPLATE INCLUDED 	<ul style="list-style-type: none"> • application: one or three hole • spout height: 23.25" • connection: 3/8" compression • number of functions: two-function • spray type: aerated stream; powerful cleaning rinse • handle mounting: right only • hose length: 68" • deckplate: included • DC powered: 6 AA cell batteries included 	1.5 GPM (5.7 L/min) max.			
		5925EWC	666.55	Chrome	3
		5925EWSRS●	833.20	Spot Resist Stainless	3
		5925EWBL	866.55	Matte Black	3
		5925EWBLS●	966.55	Black Stainless	3
OPTIONAL AC ADAPTERS SOLD SEPARATELY					
		169031	159.60	N/A or Unfinished	12
OPTIONAL WALL MOUNT & HOSE EXTENSION KIT SOLD SEPARATELY					
		177566	49.05	N/A or Unfinished	6
 POWER CLEAN DURALOCK® DURALAST® 3x					

TOUCHLESS Kitchen Faucets

TOUCHLESS KITCHEN

		MODEL	LIST	FINISH/CONNECT	CASE QTY
SLEEK®	TOUCHLESS WITH <i>MOTIONSENSE™</i> WAVE ONE-HANDLE KITCHEN PULLDOWN				
	DECKPLATE INCLUDED				
	<ul style="list-style-type: none"> • application: one or three hole • spout height: 15.56" • connection: 3/8" compression • number of functions: two-function • spray type: aerated stream; powerful cleaning rinse • handle mounting: right only • hose length: 68" • deckplate: included • DC powered: 6 AA cell batteries: included 	1.5 GPM (5.7 L/min) max.			
		7864EWC	578.90	Chrome	3
		7864EWSRS●	723.65	Spot Resist Stainless	3
		7864EWBL	752.55	Matte Black	3
		7864EWBLS●	839.40	Black Stainless	3
		7864EWBG	839.40	Brushed Gold	3
		OPTIONAL AC ADAPTERS SOLD SEPARATELY			
		169031	159.60	N/A or Unfinished	12
		OPTIONAL WALL MOUNT & HOSE EXTENSION KIT SOLD SEPARATELY			
		177566	49.05	N/A or Unfinished	6
		 POWER CLEAN reflex  DURALOCK® DURALAST®			

KITCHEN, BAR & FILTRATION FAUCETS



Premium Kitchen Faucets

KITCHEN

Nio™

Tenon™ **NEW!**

Weymouth®

Sinema™



Paterson™

Premium Kitchen Faucets

Bring elegance to your home with premium kitchen faucet selections from Moen. From the sophistication of period traditional to the streamlined refinement of minimalist contemporary, you'll find a host of amazing ways to be expressive in the kitchen.











	MODEL	LIST	FINISH/CONNECT	CASE QTY
NIO™ SMART FAUCET WITH MOTION CONTROL ONE-HANDLE KITCHEN PULLDOWN – PREMIUM				
 <ul style="list-style-type: none"> • application: one hole • spout height: 18.38" • connection: 3/8" compression • number of functions: four-function • spray type: aerated stream; powerful cleaning rinse; boosted rinse; boosted stream • handle mounting: right only • hose length: 68" • secondary two-tone handle option included: chrome faucet has matte black handle; matte black faucet has brushed gold handle; spot resist faucet has matte black handle; black stainless faucet has spot resist stainless handle • AC adapter included • DC powered: 6 D-cell batteries included • voice activated kitchen: compatible with Amazon Just Ask Alexa and Works with Google Assistant 	1.5 GPM (5.7 L/min) max.			
	S75005EV2C	1182.35	Chrome	3
	S75005EV2SRS●	1300.55	Spot Resist Stainless	3
	S75005EV2BL	1359.70	Matte Black	3
	S75005EV2BLS●	1418.75	Black Stainless	3
OPTIONAL WALL MOUNT & HOSE EXTENSION KIT SOLD SEPARATELY				
	199785	59.75	N/A or Unfinished	6
				

NIO™ ONE-HANDLE KITCHEN PULLDOWN – PREMIUM				
 <ul style="list-style-type: none"> • application: one hole • spout height: 18.38" • connection: 3/8" compression • number of functions: four-function • spray type: aerated stream; powerful cleaning rinse; boosted rinse; boosted stream • handle mounting: right only • hose length: 68" • secondary two-tone handle option included: chrome faucet has matte black handle; matte black faucet has brushed gold handle; spot resist faucet has matte black handle; black stainless faucet has spot resist stainless handle 	1.5 GPM (5.7 L/min) max.			
	S75005	840.50	Chrome	3
	S75005SRS●	1050.65	Spot Resist Stainless	3
	S75005BL	1092.65	Matte Black	3
	S75005BLS●	1218.75	Black Stainless	3
				



Premium Kitchen Faucets







	MODEL	LIST	FINISH/CONNECT	CASE QTY	
TENON™ SMART FAUCET WITH MOTION CONTROL ONE-HANDLE KITCHEN PULLDOWN - PREMIUM					
 <p>NEW!</p>	<ul style="list-style-type: none"> • application: one hole • spout height: 17.69" • connection: 3/8" compression • number of functions: four-function • spray type: aerated stream; powerful cleaning rinse; boosted rinse; boosted stream • handle mounting: right only • hose length: 68" • unique wood handle assembled on faucet • secondary matching finish handle option included • AC adapter included • DC powered: 6 D-cell batteries included • voice activated kitchen: compatible with Amazon Just Ask Alexa and Works with Google Assistant 				
	1.5 GPM (5.7 L/min) max.				
	S74001EV2C	1111.00	Chrome	3	
	S74001EV2SRS●	1233.20	Spot Resist Stainless	3	
	S74001EV2BL	1277.70	Matte Black	3	
	S74001EV2BG	1333.20	Brushed Gold	3	
OPTIONAL WALL MOUNT & HOSE EXTENSION KIT SOLD SEPARATELY					
199785	59.75	N/A or Unfinished	6		
					
TENON™ ONE-HANDLE KITCHEN PULLDOWN - PREMIUM					
 <p>NEW!</p>	<ul style="list-style-type: none"> • application: one hole • spout height: 17.69" • connection: 3/8" compression • number of functions: four-function • spray type: aerated stream; powerful cleaning rinse; boosted rinse; boosted stream • handle mounting: right only • hose length: 68" • unique wood handle assembled on faucet • secondary matching finish handle: included 				
	1.5 GPM (5.7 L/min) max.				
	S74001	800.00	Chrome	3	
	S74001SRS●	1000.00	Spot Resist Stainless	3	
	S74001BL	1040.00	Matte Black	3	
	S74001BG	1160.00	Brushed Gold	3	
					
WEYMOUTH® SMART FAUCET WITH MOTION CONTROL ONE-HANDLE KITCHEN PULLDOWN - PREMIUM					
	<ul style="list-style-type: none"> • spray wand: metal • application: one hole • spout height: 17.00" • connection: 3/8" compression • number of functions: four-function • spray type: aerated stream; powerful cleaning rinse; boosted rinse; boosted stream • handle mounting: right only • hose length: 68" • includes: choice of matching finish or porcelain handle caps • AC adapter included • DC powered: 6 D-cell batteries included • voice activated kitchen: compatible with Amazon Just Ask Alexa and Works with Google Assistant 				
	1.5 GPM (5.7 L/min) max.				
	S73004EV2C	1061.55	Chrome	3	
	S73004EV2SRS●	1167.70	Spot Resist Stainless	3	
	S73004EV2BL	1220.75	Matte Black	3	
	S73004EV2NL	1273.85	Polished Nickel	3	
	S73004EV2ORB	1273.85	Oil Rubbed Bronze	3	
	S73004EV2BG	1273.85	Brushed Gold	3	
	OPTIONAL WALL MOUNT & HOSE EXTENSION KIT SOLD SEPARATELY				
	199785	59.75	N/A or Unfinished	6	
					
WEYMOUTH® TWO-HANDLE KITCHEN BRIDGE PULLDOWN - PREMIUM					
	<ul style="list-style-type: none"> • spray wand: metal • application: three hole • spout height: 16.75" • connection: 3/8" compression • number of functions: four-function • spray type: aerated stream; powerful cleaning rinse; boosted rinse; boosted stream • hose length: 68" • handle: two-handle • spout: pulldown • secondary cross handle option: included • includes: choice of matching finish or porcelain handle caps 				
	1.5 GPM (5.7 L/min) max.				
	S73204	1034.75	Chrome	3	
	S73204SRS●	1293.40	Spot Resist Stainless	3	
	S73204BL	1345.15	Matte Black	3	
	S73204NL	1396.85	Polished Nickel	3	
	S73204ORB	1448.60	Oil Rubbed Bronze	3	
	S73204BG	1500.35	Brushed Gold	3	
					



KITCHEN

Premium Kitchen Faucets

KITCHEN

		MODEL	LIST	FINISH/CONNECT	CASE QTY	
WEYMOUTH® TOUCHLESS WITH MOTIONSENSE™ WAVE ONE-HANDLE SPRING KITCHEN PULLDOWN - PREMIUM						
 <ul style="list-style-type: none"> • spray wand: metal • application: one hole • spout height: 21.75" • connection: 3/8" compression • number of functions: four-function • spray type: aerated stream; powerful cleaning rinse; boosted rinse; boosted stream • handle mounting: right only • hose length: 68" • DC powered: 6 AA cell batteries included • includes: choice of matching finish or porcelain handle caps 	1.5 GPM (5.7 L/min) max.					
		S73104EWC	1032.65	Chrome	3	
		S73104EWSRS●	1290.85	Spot Resist Stainless	3	
		S73104EWBL	1342.50	Matte Black	3	
		S73104EWNL	1394.10	Polished Nickel	3	
		S73104EWORB	1445.75	Oil Rubbed Bronze	3	
		S73104EWBG	1497.40	Brushed Gold	3	
	OPTIONAL AC ADAPTERS SOLD SEPARATELY					
		169031	159.60	N/A or Unfinished	12	
	OPTIONAL WALL MOUNT & HOSE EXTENSION KIT SOLD SEPARATELY					
	177566	49.05	N/A or Unfinished	6		
 POWER CLEAN DURALOCK® DURALAST® 						
WEYMOUTH® ONE-HANDLE KITCHEN SPRING PULLDOWN - PREMIUM						
 <ul style="list-style-type: none"> • spray wand: metal • application: one hole • spout height: 21.75" • connection: 3/8" compression • number of functions: four-function • spray type: aerated stream; powerful cleaning rinse; boosted rinse; boosted stream • handle mounting: right only • hose length: 68" • included: choice of matching finish or porcelain handle cap 	1.5 GPM (5.7 L/min) max.					
		S73104	879.90	Chrome	3	
		S73104SRS●	1099.85	Spot Resist Stainless	3	
		S73104BL	1143.85	Matte Black	3	
		S73104NL	1187.85	Polished Nickel	3	
		S73104ORB	1231.80	Oil Rubbed Bronze	3	
		S73104BG	1275.80	Brushed Gold	3	
 POWERBOOST DURALOCK® DURALAST® 						
WEYMOUTH® 3-IN-1 WATER FILTRATION PULLDOWN KITCHEN FAUCET - PREMIUM						
 <ul style="list-style-type: none"> • water filtration at the spray wand • spray wand: metal • application: one hole • spout height: 16.73" • connection: 3/8" compression • number of functions: three-function • spray type: filtered laminar stream; unfiltered aerated stream; unfiltered PowerClean spray • handle mounting: right only • hose length: 68" • included: choice of matching finish or porcelain handle cap 	1.5 GPM (5.7 L/min) max.					
		FS73004	784.40	Chrome	3	
		FS73004SRS●	980.50	Spot Resist Stainless	3	
		FS73004NL	1058.90	Polished Nickel	3	
		FS73004ORB	1098.15	Oil Rubbed Bronze	3	
		FS73004BG	1137.35	Brushed Gold	3	
 reflex DURALOCK® DURALAST®						
WEYMOUTH® ONE-HANDLE KITCHEN PULLDOWN - PREMIUM						
 <ul style="list-style-type: none"> • spray wand: metal • application: one hole • spout height: 17" • connection: 3/8" compression • number of functions: four-function • spray type: aerated stream; powerful cleaning rinse; boosted rinse; boosted stream • handle mounting: right only • hose length: 68" • included: choice of matching finish or porcelain handle cap 	1.5 GPM (5.7 L/min) max.					
		S73004	718.00	Chrome	3	
		S73004SRS●	897.50	Spot Resist Stainless	3	
		S73004BL	933.40	Matte Black	3	
		S73004NL	969.30	Polished Nickel	3	
		S73004ORB	1005.20	Oil Rubbed Bronze	3	
		S73004BG	1041.10	Brushed Gold	3	
 POWERBOOST reflex DURALOCK® DURALAST®						

Premium Kitchen Faucets

		MODEL	LIST	FINISH/CONNECT	CASE QTY
	<ul style="list-style-type: none"> • spray wand: metal • application: one hole • spout height: 17.75" • connection: 3/8" compression • number of functions: four-function • spray type: aerated stream; powerful cleaning rinse; boosted rinse; boosted stream • handle mounting: right only • hose length: 68" • two-tone art deco-inspired etched handle installed on faucet; secondary matching finish handle option included • AC adapter included • DC powered: 6 D-cell batteries included • voice activated kitchen: compatible with Amazon Just Ask Alexa and Works with Google Assistant 	1.5 GPM (5.7 L/min) max.			
		S7235EV2C	1196.50	Chrome	3
		S7235EV2SRS●	1316.10	Spot Resist Stainless	3
		S7235EV2BL	1375.95	Matte Black	3
		S7235EV2NL	1435.80	Polished Nickel	3
OPTIONAL WALL MOUNT & HOSE EXTENSION KIT SOLD SEPARATELY					
	199785	59.75	N/A or Unfinished	6	
					
	<ul style="list-style-type: none"> • spray wand: metal • application: one hole • spout height: 23.5" • connection: 3/8" compression • number of functions: two-function • spray type: aerated stream; powerful cleaning rinse • handle mounting: right only • hose length: 68" • two-tone art deco-inspired etched handle installed on faucet; secondary matching finish handle option included • DC powered: 6 AA cell batteries included 	1.5 GPM (5.7 L/min) max.			
		S5235EWC	1049.45	Chrome	3
		S5235EWSRS●	1311.75	Spot Resist Stainless	3
		S5235EWBL	1364.30	Matte Black	3
		S5235EWNL	1416.75	Polished Nickel	3
OPTIONAL AC ADAPTERS SOLD SEPARATELY					
	169031	159.60	N/A or Unfinished	12	
OPTIONAL WALL MOUNT & HOSE EXTENSION KIT SOLD SEPARATELY					
	177566	49.05	N/A or Unfinished	6	
					
	<ul style="list-style-type: none"> • spray wand: metal • application: one hole • spout height: 23.5" • connection: 3/8" compression • number of functions: four-function • spray type: aerated stream; powerful cleaning rinse; boosted rinse; boosted stream • handle mounting: right only • hose length: 69" • two-tone art deco-inspired etched handle installed on faucet; secondary matching finish handle option included 	1.5 GPM (5.7 L/min) max.			
		S5235	896.65	Chrome	3
		S5235SRS●	1120.75	Spot Resist Stainless	3
		S5235BL	1165.60	Matte Black	3
		S5235NL	1210.45	Polished Nickel	3
					
	<ul style="list-style-type: none"> • water filtration at the spray wand • spray wand: metal • application: one hole • spout height: 17.75" • connection: 3/8" compression • number of functions: three-function • spray type: filtered laminar stream; unfiltered aerated stream; unfiltered PowerClean spray • handle mounting: right only • hose length: 68" • two-tone art deco-inspired etched handle installed on faucet; secondary matching finish handle option included 	1.5 GPM (5.7 L/min) max.			
		FS7235	780.70	Chrome	3
		FS7235SRS●	975.90	Spot Resist Stainless	3
		FS7235BL	1014.95	Matte Black	3
					

KITCHEN







Premium Kitchen Faucets

KITCHEN

		MODEL	LIST	FINISH/CONNECT	CASE QTY
 	<p>SINEMA™ ONE-HANDLE KITCHEN PULLDOWN - PREMIUM</p> <ul style="list-style-type: none"> • spray wand: metal • application: one hole • spout height: 17.75" • connection: 3/8" compression • number of functions: four-function • spray type: aerated stream; powerful cleaning rinse; boosted rinse; boosted stream • handle mounting: right only • hose length: 68" • two-tone art deco-inspired etched handle installed on faucet; secondary matching finish handle option included <p> POWERBOOST  DURALOCK® DURALAST®</p>	1.5 GPM (5.7 L/min) max.			
		S7235	689.70	Chrome	3
		S7235SRS●	862.10	Spot Resist Stainless	3
		S7235BL	896.60	Matte Black	3
		S7235NL	931.05	Polished Nickel	3
 	<p>PATERSON™ SMART FAUCET WITH MOTION CONTROL ONE-HANDLE KITCHEN PULLDOWN - PREMIUM</p> <ul style="list-style-type: none"> • spray wand: metal • application: one hole • spout height: 17.00" • connection: 3/8" compression • number of functions: four-function • spray type: aerated stream; powerful cleaning rinse; boosted rinse; boosted stream • handle mounting: right only • secondary wheel handle option: included • hose length: 68" • AC adapter included • DC powered: 6 D-cell batteries included • voice activated kitchen: compatible with Amazon Just Ask Alexa and Works with Google Assistant <p> POWERBOOST  DURALOCK® DURALAST®</p>	1.5 GPM (5.7 L/min) max.			
		S72003EV2C	1040.20	Chrome	3
		S72003EV2SRS●	1144.20	Spot Resist Stainless	3
		S72003EV2BL	1196.20	Matte Black	3
		199785	59.75	N/A or Unfinished	6
<small>OPTIONAL WALL MOUNT & HOSE EXTENSION KIT SOLD SEPARATELY</small>					
 	<p>PATERSON™ 3-IN-1 WATER FILTRATION PULLDOWN KITCHEN FAUCET - PREMIUM</p> <ul style="list-style-type: none"> • water filtration at the spray wand • spray wand: metal • application: one hole • spout height: 17.00" • connection: 3/8" compression • number of functions: three-function • spray type: filtered laminar stream; unfiltered aerated stream; unfiltered PowerClean spray • handle mounting: right only • hose length: 68" • secondary wheel handle option: included <p> reflex  DURALOCK® DURALAST®</p>	1.5 GPM (5.7 L/min) max.			
		FS72003	765.55	Chrome	3
		FS72003SRS●	956.95	Spot Resist Stainless	3
		FS72003BL	995.25	Matte Black	3
 	<p>PATERSON™ ONE-HANDLE KITCHEN SPRING PULLDOWN - PREMIUM</p> <ul style="list-style-type: none"> • spray wand: metal • application: one hole • spout height: 22.37" • connection: 3/8" compression • number of functions: four-function • spray type: aerated stream; powerful cleaning rinse; boosted rinse; boosted stream • handle mounting: right only • hose length: 68" • secondary wheel handle option: included <p> POWERBOOST DURALOCK® DURALAST® </p>	1.5 GPM (5.7 L/min) max.			
		S72103	865.85	Chrome	3
		S72103SRS●	1082.25	Spot Resist Stainless	3
		S72103BL	1125.55	Matte Black	3



Premium Kitchen Faucets

PATERSON™		MODEL	LIST	FINISH/CONNECT	CASE QTY
ONE-HANDLE KITCHEN PULLDOWN - PREMIUM					
 	<ul style="list-style-type: none"> • spray wand: metal • application: one hole • spout height: 17.00" • connection: 3/8" compression • number of functions: four-function • spray type: aerated stream; powerful cleaning rinse; boosted rinse; boosted stream • handle mounting: right only • hose length: 68" • secondary wheel handle option: included 	1.5 GPM (5.7 L/min) max.			
		S72003	696.85	Chrome	3
		S72003SRS ●	871.05	Spot Resist Stainless	3
		S72003BL	905.90	Matte Black	3
 POWERBOOST reflex  DURALOCK® DURALAST®					

KITCHEN

- Cia™
- Align®
- KURV™
- Smyth™ **NEW!**
- Brantford®
- Arbor®
- Belfield™
- Genta™ LX
- Sleek®
- Camerist®
- Integra®
- Method™
- Chateau®

Kitchen Faucets













Moen® kitchen faucets combine meaningful innovations with an exceptional variety of attractive styles and in a wide array of finishes. With almost limitless design possibilities, kitchen faucets from Moen offer design, functionality and value.



	MODEL	LIST	FINISH/CONNECT	CASE QTY
CIA™ SMART FAUCET WITH MOTION CONTROL ONE-HANDLE KITCHEN PULLDOWN				
 DECKPLATE SOLD SEPARATELY NEW! Q2	<ul style="list-style-type: none"> • application: one hole • spout height: 16.86" • connection: 3/8" compression • number of functions: four-function • spray type: aerated stream; powerful cleaning rinse; boosted rinse; boosted stream • handle mounting: right only • secondary accent escutcheon option included: chrome faucet has optional matte black; spot resist stainless has chrome; matte black has brushed gold and chrome; brushed gold has matte black • hose length: 68" • AC adapter included • DC powered: 6 D-cell batteries included • voice activated kitchen: compatible with Amazon Just Ask Alexa and Works with Google Assistant 			
	1.5 GPM (5.7 L/min) max.			
	7622EV2C	922.80	Chrome	3
	7622EV2SRS●	1015.10	Spot Resist Stainless	3
	7622EV2BL	1061.20	Matte Black	3
	7622EV2BG	1107.35	Brushed Gold	3
OPTIONAL DECKPLATE SOLD SEPARATELY				
	141002	57.75	Chrome	6
	141002SRS●	66.25	Spot Resist Stainless	6
	141002BL	66.25	Matte Black	6
	141002BG	66.25	Brushed Gold	6
OPTIONAL WALL MOUNT & HOSE EXTENSION KIT SOLD SEPARATELY				
	199785	59.75	N/A or Unfinished	6
POWERBOOST reflex DURALOCK® DURALAST®				

CIA™ SMART FAUCET ONE-HANDLE KITCHEN PULLDOWN				
 DECKPLATE SOLD SEPARATELY	<ul style="list-style-type: none"> • application: one or three hole • spout height: 16.86" • connection: 3/8" compression • number of functions: four-function • spray type: aerated stream; powerful cleaning rinse; boosted rinse; boosted stream • handle mounting: right only • hose length: 68" • secondary accent escutcheon option included: chrome faucet has optional matte black; spot resist stainless has chrome; matte black has brushed gold and chrome; brushed gold has matte black • DC powered: 6 D-cell batteries included • voice activated kitchen: compatible with Amazon Just Ask Alexa and Works with Google Assistant 			
	1.5 GPM (5.7 L/min) max.			
	7622EVC	930.55	Chrome	3
	7622EVSRS●	1023.60	Spot Resist Stainless	3
	7622EVBL	1070.15	Matte Black	3
	7622EVBG	1116.65	Brushed Gold	3
OPTIONAL DECKPLATE SOLD SEPARATELY				
	141002	57.75	Chrome	6
	141002SRS●	66.25	Spot Resist Stainless	6
	141002BL	66.25	Matte Black	6
	141002BG	66.25	Brushed Gold	6
OPTIONAL AC ADAPTERS SOLD SEPARATELY				
	169031	159.60	N/A or Unfinished	12
OPTIONAL WALL MOUNT & HOSE EXTENSION KIT SOLD SEPARATELY				
	199785	59.75	N/A or Unfinished	6
POWERBOOST reflex DURALOCK® DURALAST®				





Kitchen Faucets







	MODEL	LIST	FINISH/CONNECT	CASE QTY																
CIA™ TOUCHLESS WITH <i>MOTIONSENSE™</i> WAVE ONE-HANDLE KITCHEN PULLDOWN																				
 DECKPLATE SOLD SEPARATELY 	<ul style="list-style-type: none"> • application: one or three hole • spout height: 16.86" • connection: 3/8" compression • number of functions: two-function • spray type: aerated stream; powerful cleaning rinse • handle mounting: right only • hose length: 68" • secondary accent escutcheon option included: chrome faucet has optional matte black; spot resist stainless has chrome; matte black has brushed gold and chrome; brushed gold has matte black • DC powered: 6 AA cell batteries included 	1.5 GPM (5.7 L/min) max. <table border="1"> <tr> <td>7622EWC</td> <td>766.30</td> <td>Chrome</td> <td>3</td> </tr> <tr> <td>7622EWSRS●</td> <td>957.90</td> <td>Spot Resist Stainless</td> <td>3</td> </tr> <tr> <td>7622EWBL</td> <td>996.20</td> <td>Matte Black</td> <td>3</td> </tr> <tr> <td>7622EWBG</td> <td>1111.15</td> <td>Brushed Gold</td> <td>3</td> </tr> </table>			7622EWC	766.30	Chrome	3	7622EWSRS●	957.90	Spot Resist Stainless	3	7622EWBL	996.20	Matte Black	3	7622EWBG	1111.15	Brushed Gold	3
	7622EWC	766.30	Chrome	3																
7622EWSRS●	957.90	Spot Resist Stainless	3																	
7622EWBL	996.20	Matte Black	3																	
7622EWBG	1111.15	Brushed Gold	3																	
OPTIONAL DECKPLATE SOLD SEPARATELY																				
<table border="1"> <tr> <td>141002</td> <td>57.75</td> <td>Chrome</td> <td>6</td> </tr> <tr> <td>141002SRS●</td> <td>66.25</td> <td>Spot Resist Stainless</td> <td>6</td> </tr> <tr> <td>141002BL</td> <td>66.25</td> <td>Matte Black</td> <td>6</td> </tr> <tr> <td>141002BG</td> <td>66.25</td> <td>Brushed Gold</td> <td>6</td> </tr> </table>					141002	57.75	Chrome	6	141002SRS●	66.25	Spot Resist Stainless	6	141002BL	66.25	Matte Black	6	141002BG	66.25	Brushed Gold	6
141002	57.75	Chrome	6																	
141002SRS●	66.25	Spot Resist Stainless	6																	
141002BL	66.25	Matte Black	6																	
141002BG	66.25	Brushed Gold	6																	
OPTIONAL AC ADAPTERS SOLD SEPARATELY																				
<table border="1"> <tr> <td>169031</td> <td>159.60</td> <td>N/A or Unfinished</td> <td>12</td> </tr> </table>					169031	159.60	N/A or Unfinished	12												
169031	159.60	N/A or Unfinished	12																	
OPTIONAL WALL MOUNT & HOSE EXTENSION KIT SOLD SEPARATELY																				
<table border="1"> <tr> <td>177566</td> <td>49.05</td> <td>N/A or Unfinished</td> <td>6</td> </tr> </table>					177566	49.05	N/A or Unfinished	6												
177566	49.05	N/A or Unfinished	6																	
 POWER CLEAN reflex  DURALOCK® DURALAST®																				
CIA™ ONE-HANDLE KITCHEN SPRING PULLDOWN																				
DECKPLATE SOLD SEPARATELY 	<ul style="list-style-type: none"> • application: one or three hole • spout height: 24.50" • connection: 3/8" compression • number of functions: four-function • spray type: aerated stream; powerful cleaning rinse; boosted rinse; boosted stream • bi-directional PowerBoost Pro togglelock • magnetix wand docking • handle mounting: right only • hose length: 87" • secondary accent escutcheon option included: chrome faucet has optional matte black; spot resist stainless has chrome; matte black has brushed gold and chrome; brushed gold has matte black 	1.5 GPM aerated/1.5 Laminar <table border="1"> <tr> <td>7822</td> <td>850.00</td> <td>Chrome</td> <td>3</td> </tr> <tr> <td>7822SRS●</td> <td>1062.50</td> <td>Spot Resist Stainless</td> <td>3</td> </tr> <tr> <td>7822BL</td> <td>1105.00</td> <td>Matte Black</td> <td>3</td> </tr> <tr> <td>7822BG</td> <td>1232.50</td> <td>Brushed Gold</td> <td>3</td> </tr> </table>			7822	850.00	Chrome	3	7822SRS●	1062.50	Spot Resist Stainless	3	7822BL	1105.00	Matte Black	3	7822BG	1232.50	Brushed Gold	3
	7822	850.00	Chrome	3																
7822SRS●	1062.50	Spot Resist Stainless	3																	
7822BL	1105.00	Matte Black	3																	
7822BG	1232.50	Brushed Gold	3																	
OPTIONAL DECKPLATE SOLD SEPARATELY																				
<table border="1"> <tr> <td>141002</td> <td>57.75</td> <td>Chrome</td> <td>6</td> </tr> <tr> <td>141002BG</td> <td>66.25</td> <td>Brushed Gold</td> <td>6</td> </tr> <tr> <td>141002SRS●</td> <td>66.25</td> <td>Spot Resist Stainless</td> <td>6</td> </tr> <tr> <td>141002BL</td> <td>66.25</td> <td>Matte Black</td> <td>6</td> </tr> </table>					141002	57.75	Chrome	6	141002BG	66.25	Brushed Gold	6	141002SRS●	66.25	Spot Resist Stainless	6	141002BL	66.25	Matte Black	6
141002	57.75	Chrome	6																	
141002BG	66.25	Brushed Gold	6																	
141002SRS●	66.25	Spot Resist Stainless	6																	
141002BL	66.25	Matte Black	6																	
 DURALOCK® DURALAST®  POWERBOOST PRO  MAGNETIX																				
CIA™ ONE-HANDLE KITCHEN PULLDOWN																				
 DECKPLATE SOLD SEPARATELY 	<ul style="list-style-type: none"> • application: one or three hole • spout height: 16.86" • connection: 3/8" compression • number of functions: four-function • spray type: aerated stream; powerful cleaning rinse; boosted rinse; boosted stream • handle mounting: right only • hose length: 68" • secondary accent escutcheon option included: chrome faucet has optional matte black; spot resist stainless has chrome; matte black has brushed gold and chrome; brushed gold has matte black 	1.5 GPM (5.7 L/min) max. <table border="1"> <tr> <td>7622</td> <td>602.10</td> <td>Chrome</td> <td>3</td> </tr> <tr> <td>7622SRS●</td> <td>752.60</td> <td>Spot Resist Stainless</td> <td>3</td> </tr> <tr> <td>7622BL</td> <td>782.70</td> <td>Matte Black</td> <td>3</td> </tr> <tr> <td>7622BG</td> <td>873.00</td> <td>Brushed Gold</td> <td>3</td> </tr> </table>			7622	602.10	Chrome	3	7622SRS●	752.60	Spot Resist Stainless	3	7622BL	782.70	Matte Black	3	7622BG	873.00	Brushed Gold	3
	7622	602.10	Chrome	3																
7622SRS●	752.60	Spot Resist Stainless	3																	
7622BL	782.70	Matte Black	3																	
7622BG	873.00	Brushed Gold	3																	
OPTIONAL DECKPLATE SOLD SEPARATELY																				
<table border="1"> <tr> <td>141002</td> <td>57.75</td> <td>Chrome</td> <td>6</td> </tr> <tr> <td>141002SRS●</td> <td>66.25</td> <td>Spot Resist Stainless</td> <td>6</td> </tr> <tr> <td>141002BL</td> <td>66.25</td> <td>Matte Black</td> <td>6</td> </tr> <tr> <td>141002BG</td> <td>66.25</td> <td>Brushed Gold</td> <td>6</td> </tr> </table>					141002	57.75	Chrome	6	141002SRS●	66.25	Spot Resist Stainless	6	141002BL	66.25	Matte Black	6	141002BG	66.25	Brushed Gold	6
141002	57.75	Chrome	6																	
141002SRS●	66.25	Spot Resist Stainless	6																	
141002BL	66.25	Matte Black	6																	
141002BG	66.25	Brushed Gold	6																	
 POWERBOOST  reflex  DURALOCK® DURALAST®																				

KITCHEN

Kitchen Faucets



KITCHEN





	MODEL	LIST	FINISH/CONNECT	CASE QTY	
ALIGN® SMART FAUCET ONE-HANDLE KITCHEN PULLDOWN					
 <p>DECKPLATE SOLD SEPARATELY</p> <ul style="list-style-type: none"> • application: one or three hole • spout height: 15.70" • connection: 3/8" compression • number of functions: four-function • spray type: aerated stream; powerful cleaning rinse; boosted rinse; boosted stream • handle mounting: right only • hose length: 68" • DC powered: 6 D-cell batteries included • voice activated kitchen: compatible with Amazon Just Ask Alexa and Works with Google Assistant 	1.5 GPM (5.7 L/min) max.				
	7565EVC	906.05	Chrome	3	
	7565EVSRS●	996.65	Spot Resist Stainless	3	
	7565EVBL	1042.00	Matte Black	3	
	7565EVBLS●	1087.25	Black Stainless	3	
	7565EVBG	1087.25	Brushed Gold	3	
	OPTIONAL DECKPLATE SOLD SEPARATELY				
	141002	57.75	Chrome	6	
	141002SRS●	66.25	Spot Resist Stainless	6	
	141002BL	66.25	Matte Black	6	
	141002BLS●	72.90	Black Stainless	6	
	141002BG	66.25	Brushed Gold	6	
	OPTIONAL AC ADAPTERS SOLD SEPARATELY				
	169031	159.60	N/A or Unfinished	12	
	OPTIONAL WALL MOUNT & HOSE EXTENSION KIT SOLD SEPARATELY				
199785	59.75	N/A or Unfinished	6		
 POWERBOOST  reflex  DURALOCK®  DURALAST®					





	MODEL	LIST	FINISH/CONNECT	CASE QTY	
ALIGN® TOUCHLESS WITH MOTIONSENSE™ WAVE ONE-HANDLE SPRING KITCHEN PULLDOWN					
 <p>DECKPLATE SOLD SEPARATELY</p> <ul style="list-style-type: none"> • application: one or three hole • spout height: 21.75" • connection: 3/8" compression • number of functions: two-function • spray type: aerated stream; powerful cleaning rinse • handle mounting: right only • hose length: 68" • DC powered: 6 AA cell batteries included 	1.5 GPM (5.7 L/min) max.				
	5923EWC	809.45	Chrome	3	
	5923EWSRS●	1011.80	Spot Resist Stainless	3	
	5923EWBL	1052.25	Matte Black	3	
	5923EWBLS●	1173.65	Black Stainless	3	
	5923EWBG	1173.65	Brushed Gold	3	
	OPTIONAL DECKPLATE SOLD SEPARATELY				
	141002	57.75	Chrome	6	
	141002SRS●	66.25	Spot Resist Stainless	6	
	141002BL	66.25	Matte Black	6	
	141002BLS●	72.90	Black Stainless	6	
	141002BG	66.25	Brushed Gold	6	
	OPTIONAL AC ADAPTERS SOLD SEPARATELY				
	169031	159.60	N/A or Unfinished	12	
	OPTIONAL WALL MOUNT & HOSE EXTENSION KIT SOLD SEPARATELY				
177566	49.05	N/A or Unfinished	6		
 motionSense  POWERCLEAN  DURALOCK®  DURALAST® 					



Kitchen Faucets

	MODEL	LIST	FINISH/CONNECT	CASE QTY	
ALIGN® TOUCHLESS WITH MOTIONSENSE™ WAVE ONE-HANDLE KITCHEN PULLDOWN					
 DECKPLATE SOLD SEPARATELY 	<ul style="list-style-type: none"> • application: one or three hole • spout height: 15.70" • connection: 3/8" compression • number of functions: two-function • spray type: aerated stream; powerful cleaning rinse • handle mounting: right only • hose length: 68" • DC powered: 6 AA cell batteries included 	1.5 GPM (5.7 L/min) max.			
	7565EWC	741.05	Chrome	3	
	7565EWSRS●	926.35	Spot Resist Stainless	3	
	7565EWBL	963.35	Matte Black	3	
	7565EWBLS●	1074.50	Black Stainless	3	
	7565EWBG	1074.50	Brushed Gold	3	
	OPTIONAL DECKPLATE SOLD SEPARATELY				
	141002	57.75	Chrome	6	
	141002SRS●	66.25	Spot Resist Stainless	6	
	141002BL	66.25	Matte Black	6	
141002BLS●	72.90	Black Stainless	6		
141002BG	66.25	Brushed Gold	6		
OPTIONAL AC ADAPTERS SOLD SEPARATELY					
169031	159.60	N/A or Unfinished	12		
OPTIONAL WALL MOUNT & HOSE EXTENSION KIT SOLD SEPARATELY					
177566	49.05	N/A or Unfinished	6		
 POWER CLEAN reflex DURALOCK® DURALAST®					







	MODEL	LIST	FINISH/CONNECT	CASE QTY	
ALIGN® ONE-HANDLE KITCHEN SPRING PULLDOWN					
 DECKPLATE SOLD SEPARATELY 	<ul style="list-style-type: none"> • application: one or three hole • spout height: 21.75" • connection: 3/8" compression • number of functions: four-function • spray type: aerated stream; powerful cleaning rinse; boosted rinse; boosted stream • handle mounting: right only • hose length: 68" 	1.5 GPM (5.7 L/min) max.			
	5923	647.50	Chrome	3	
	5923SRS●	809.35	Spot Resist Stainless	3	
	5923BL	841.75	Matte Black	3	
	5923BLS●	938.85	Black Stainless	3	
	5923BG	938.85	Brushed Gold	3	
	OPTIONAL DECKPLATE SOLD SEPARATELY				
	141002	57.75	Chrome	6	
	141002SRS●	66.25	Spot Resist Stainless	6	
	141002BL	66.25	Matte Black	6	
141002BLS●	72.90	Black Stainless	6		
141002BG	66.25	Brushed Gold	6		
 POWERBOOST DURALOCK® DURALAST® 					







	MODEL	LIST	FINISH/CONNECT	CASE QTY	
ALIGN® 3-IN-1 WATER FILTRATION PULLDOWN KITCHEN FAUCET					
 DECKPLATE SOLD SEPARATELY 	<ul style="list-style-type: none"> • water filtration at the spray wand • spray wand: metal • application: one hole • spout height: 15.63" • connection: 3/8" compression • number of functions: three-function • spray type: filtered laminar stream; unfiltered aerated stream; unfiltered PowerClean spray • handle mounting: right only • hose length: 68" 	1.5 GPM (5.7 L/min) max.			
	F5923	723.75	Chrome	3	
	F5923SRS●	906.00	Spot Resist Stainless	3	
	F5923BL	942.25	Matte Black	3	
	F5923BG	1051.45	Brushed Gold	3	
	OPTIONAL DECKPLATE SOLD SEPARATELY				
	141002	57.75	Chrome	6	
	141002SRS●	66.25	Spot Resist Stainless	6	
	141002BL	66.25	Matte Black	6	
	141002BG	66.25	Brushed Gold	6	
 DURALOCK® DURALAST® 					

KITCHEN





Kitchen Faucets





KITCHEN







			MODEL	LIST	FINISH/CONNECT	CASE QTY
ALIGN® ONE-HANDLE KITCHEN PULLDOWN						
 DECKPLATE SOLD SEPARATELY 	<ul style="list-style-type: none"> • application: one or three hole • spout height: 15.70" • connection: 3/8" compression • number of functions: four-function • spray type: aerated stream; powerful cleaning rinse; boosted rinse; boosted stream • handle mounting: right only • hose length: 68" 	1.5 GPM (5.7 L/min) max.				
		7565	573.40	Chrome	3	
		7565SRS●	716.70	Spot Resist Stainless	3	
		7565BL	745.40	Matte Black	3	
		7565BLS●	831.40	Black Stainless	3	
		7565BG	831.40	Brushed Gold	3	
OPTIONAL DECKPLATE SOLD SEPARATELY						
		141002	57.75	Chrome	6	
		141002SRS●	66.25	Spot Resist Stainless	6	
		141002BL	66.25	Matte Black	6	
		141002BLS●	72.90	Black Stainless	6	
		141002BG	66.25	Brushed Gold	6	
 POWERBOOST reflex DURALOCK® DURALAST®						
1.0 GPM (3.8L/min) max.						
 DECKPLATE SOLD SEPARATELY 	<ul style="list-style-type: none"> • application: one or three hole • spout height: 15.70" • connection: 3/8" compression • number of functions: four-function • spray type: aerated stream; powerful cleaning rinse; boosted rinse; boosted stream • handle mounting: right only • hose length: 68" 	1.0 GPM (3.8L/min) max.				
		75651	573.40	Chrome	3	
		75651SRS●	716.70	Spot Resist Stainless	3	
		75651BL	745.40	Matte Black	3	
OPTIONAL DECKPLATE SOLD SEPARATELY						
		141002	57.75	Chrome	6	
		141002SRS●	66.25	Spot Resist Stainless	6	
		141002BL	66.25	Matte Black	6	
 POWERBOOST reflex DURALOCK® DURALAST®						

ALIGN® ONE-HANDLE KITCHEN						
 DECKPLATE SOLD SEPARATELY 	<ul style="list-style-type: none"> • application: two or four hole • spout height: 15.31" • connection: 3/8" compression • spray type: aerated stream • handle mounting: right only • side spray: included 	1.5 GPM (5.7 L/min) max.				
		7165	531.90	Chrome	3	
		7165SRS●	664.90	Spot Resist Stainless	3	
		7165BL	691.45	Matte Black	3	
OPTIONAL DECKPLATE SOLD SEPARATELY						
		141002	57.75	Chrome	6	
		141002SRS●	66.25	Spot Resist Stainless	6	
		141002BL	66.25	Matte Black	6	
 DURALOCK® DURALAST®						
1.5 GPM (5.7 L/min) max.						
 DECKPLATE SOLD SEPARATELY 	<ul style="list-style-type: none"> • application: one or three hole • spout height: 15.31" • connection: 3/8" compression • spray type: aerated stream • handle mounting: right only 	1.5 GPM (5.7 L/min) max.				
		7365	468.00	Chrome	3	
		7365SRS●	585.05	Spot Resist Stainless	3	
		7365BL	608.40	Matte Black	3	
OPTIONAL DECKPLATE SOLD SEPARATELY						
		141002	57.75	Chrome	6	
		141002SRS●	66.25	Spot Resist Stainless	6	
		141002BL	66.25	Matte Black	6	
 DURALAST®						

Kitchen Faucets

		MODEL	LIST	FINISH/CONNECT	CASE QTY
KURV™	SMART FAUCET WITH MOTION CONTROL ONE-HANDLE KITCHEN PULLDOWN				
 DECKPLATE SOLD SEPARATELY 	<ul style="list-style-type: none"> spray wand: metal application: one hole spout height: 16.38" connection: 3/8" compression number of functions: four-function spray type: aerated stream; powerful cleaning rinse; boosted rinse; boosted stream handle mounting: right only hose length: 68" AC adapter included DC powered: 6 D-cell batteries included voice activated kitchen: compatible with Amazon Just Ask Alexa and Works with Google Assistant 	1.5 GPM (5.7 L/min) max.			
			9126EV2C	880.15	Chrome
		9126EV2SRS●	968.15	Spot Resist Stainless	3
		9126EV2BL	1012.15	Matte Black	3
		9126EV2NL	1056.15	Polished Nickel	3
		OPTIONAL DECKPLATE SOLD SEPARATELY			
		141002	57.75	Chrome	6
		141002SRS●	66.25	Spot Resist Stainless	6
		141002BL	66.25	Matte Black	6
		141002NL	62.85	Polished Nickel	6
		OPTIONAL WALL MOUNT & HOSE EXTENSION KIT SOLD SEPARATELY			
		199785	59.75	N/A or Unfinished	6
 POWERBOOST reflex  DURALOCK® DURALAST™					



		MODEL	LIST	FINISH/CONNECT	CASE QTY
KURV™	SMART FAUCET ONE-HANDLE KITCHEN PULLDOWN				
 DECKPLATE SOLD SEPARATELY 	<ul style="list-style-type: none"> spray wand: metal application: one or three hole spout height: 16.38" connection: 3/8" compression number of functions: four-function spray type: aerated stream; powerful cleaning rinse; boosted rinse; boosted stream handle mounting: right only hose length: 68" DC powered: 6 D-cell batteries included voice activated kitchen: compatible with Amazon Just Ask Alexa and Works with Google Assistant 	1.5 GPM (5.7 L/min) max.			
			9126EVC	888.85	Chrome
		9126EVSRS●	977.70	Spot Resist Stainless	3
		9126EVB	1022.15	Matte Black	3
		9126EVNL	1066.55	Polished Nickel	3
		OPTIONAL DECKPLATE SOLD SEPARATELY			
		141002	57.75	Chrome	6
		141002SRS●	66.25	Spot Resist Stainless	6
		141002BL	66.25	Matte Black	6
		141002NL	62.85	Polished Nickel	6
		OPTIONAL AC ADAPTERS SOLD SEPARATELY			
		169031	159.60	N/A or Unfinished	12
		OPTIONAL WALL MOUNT & HOSE EXTENSION KIT SOLD SEPARATELY			
		199785	59.75	N/A or Unfinished	6
 POWERBOOST reflex  DURALOCK® DURALAST™					



		MODEL	LIST	FINISH/CONNECT	CASE QTY
KURV™	TOUCHLESS WITH MOTIONSENSE™ WAVE ONE-HANDLE KITCHEN PULLDOWN				
 DECKPLATE SOLD SEPARATELY 	<ul style="list-style-type: none"> spray wand: metal application: one or three hole spout height: 16.38" connection: 3/8" compression number of functions: two-function spray type: aerated stream; powerful cleaning rinse handle mounting: right only hose length: 68" DC powered: 6 AA cell batteries included 	1.5 GPM (5.7 L/min) max.			
			9126EWC	723.30	Chrome
		9126EWSRS●	904.10	Spot Resist Stainless	3
		9126EWBL	940.30	Matte Black	3
		9126EWNL	976.45	Polished Nickel	3
		OPTIONAL DECKPLATE SOLD SEPARATELY			
		141002	57.75	Chrome	6
		141002SRS●	66.25	Spot Resist Stainless	6
		141002BL	66.25	Matte Black	6
		141002NL	62.85	Polished Nickel	6
		OPTIONAL AC ADAPTERS SOLD SEPARATELY			
		169031	159.60	N/A or Unfinished	12
		OPTIONAL WALL MOUNT & HOSE EXTENSION KIT SOLD SEPARATELY			
		177566	49.05	N/A or Unfinished	6
 MOTIONSENSE™ WAVE  POWER CLEAN reflex  DURALOCK® DURALAST™					









Kitchen Faucets

KITCHEN

		MODEL	LIST	FINISH/CONNECT	CASE QTY
KURV™ 3-IN-1 WATER FILTRATION PULLDOWN KITCHEN FAUCET					
 DECKPLATE SOLD SEPARATELY 	<ul style="list-style-type: none"> • water filtration at the spray wand • spray wand: metal • application: one hole • spout height: 16.38" • connection: 3/8" compression • number of functions: three-function • spray type: filtered laminar stream; unfiltered aerated stream; unfiltered PowerClean spray • handle mounting: right only • hose length: 68" 	1.5 GPM (5.7 L/min) max.			
		F9126	657.30	Chrome	3
		F9126SRS●	821.65	Spot Resist Stainless	3
		F9126BL	854.50	Matte Black	3
OPTIONAL DECKPLATE SOLD SEPARATELY					
		141002	57.75	Chrome	6
		141002SRS●	66.25	Spot Resist Stainless	6
		141002BL	66.25	Matte Black	6
 reflex DURALOCK® DURALAST®					



		MODEL	LIST	FINISH/CONNECT	CASE QTY
KURV™ ONE-HANDLE KITCHEN PULLDOWN					
 DECKPLATE SOLD SEPARATELY 	<ul style="list-style-type: none"> • spray wand metal • application: one or three hole • spout height: 16.38" • connection: 3/8" compression • number of functions: four-function • spray type: aerated stream; powerful cleaning rinse; boosted rinse; boosted stream • handle mounting: right only • hose length: 68" 	1.5 GPM (5.7 L/min) max.			
		9126	559.05	Chrome	3
		9126SRS●	698.80	Spot Resist Stainless	3
		9126BL	726.75	Matte Black	3
		9126NL	754.70	Polished Nickel	3
OPTIONAL DECKPLATE SOLD SEPARATELY					
		141002	57.75	Chrome	6
		141002SRS●	66.25	Spot Resist Stainless	6
		141002BL	66.25	Matte Black	6
		141002NL	62.85	Polished Nickel	6
 POWERBOOST reflex DURALOCK® DURALAST®					



		MODEL	LIST	FINISH/CONNECT	CASE QTY
SMYTH™ SMART FAUCET WITH MOTION CONTROL ONE-HANDLE KITCHEN PULLDOWN					
 DECKPLATE SOLD SEPARATELY 	<ul style="list-style-type: none"> • application: one hole • spout height: 16.50" • connection: 3/8" compression • number of functions: four-function • spray type: aerated stream; powerful cleaning rinse; boosted rinse; boosted stream • handle mounting: right only • hose length: 68" • AC adapter included • DC powered: 6 D-cell batteries included • voice activated kitchen: compatible with Amazon Just Ask Alexa and Works with Google Assistant 	1.5 GPM (5.7 L/min) max.			
		7770EV2SRS●	905.50	Spot Resist Stainless	3
		7770EV2BL	946.65	Matte Black	3
		7770EV2NL	987.80	Polished Nickel	3
		7770EV2BZG	987.80	Bronzed Gold	3
OPTIONAL WALL MOUNT & HOSE EXTENSION KIT SOLD SEPARATELY					
		199785	59.75	N/A or Unfinished	6
 POWERBOOST reflex DURALOCK® DURALAST®					



		MODEL	LIST	FINISH/CONNECT	CASE QTY
SMYTH™ TOUCHLESS WITH MOTIONSENSE™ WAVE ONE-HANDLE KITCHEN PULLDOWN					
 DECKPLATE SOLD SEPARATELY 	<ul style="list-style-type: none"> • application: one or three hole • spout height: 16.50" • connection: 3/8" compression • number of functions: two-function • spray type: aerated stream; powerful cleaning rinse • handle mounting: right only • hose length: 68" • DC powered: 6 AA cell batteries included 	1.5 GPM (5.7 L/min) max.			
		7770EWSRS●	831.25	Spot Resist Stainless	3
		7770EWBL	864.50	Matte Black	3
		7770EWNL	897.75	Polished Nickel	3
		7770EWBZG	964.25	Bronzed Gold	3
OPTIONAL DECKPLATE SOLD SEPARATELY					
		141002SRS●	66.25	Spot Resist Stainless	6
		141002BL	66.25	Matte Black	6
		141002NL	62.85	Polished Nickel	6
OPTIONAL AC ADAPTERS SOLD SEPARATELY					
		169031	159.60	N/A or Unfinished	12
OPTIONAL WALL MOUNT & HOSE EXTENSION KIT SOLD SEPARATELY					
		177566	49.05	N/A or Unfinished	6
 POWER CLEAN reflex DURALOCK® DURALAST®					





Kitchen Faucets

		MODEL	LIST	FINISH/CONNECT	CASE QTY
SMYTH™ ONE-HANDLE KITCHEN PULLDOWN		1.5 GPM (5.7 L/min) max.			
 <p>DECKPLATE SOLD SEPARATELY</p> <p>NEW! Q2</p> 	<ul style="list-style-type: none"> • application: one or three hole • spout height: 16.50" • connection: 3/8" compression • number of functions: four-function • spray type: aerated stream; powerful cleaning rinse; boosted rinse; boosted stream • handle mounting: right only • hose length: 68" 	7770SRS	643.75	Spot Resist Stainless	3
		7770BL	669.50	Matte Black	3
		7770NL	695.25	Polished Nickel	3
		7770BZG	746.75	Bronzed Gold	3
	OPTIONAL DECKPLATE SOLD SEPARATELY				
		141002SRS	66.25	Spot Resist Stainless	6
		141002BL	66.25	Matte Black	6
		141002NL	62.85	Polished Nickel	6
					

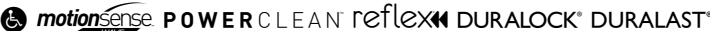
		MODEL	LIST	FINISH/CONNECT	CASE QTY	
BRANTFORD® SMART FAUCET ONE-HANDLE KITCHEN PULLDOWN		1.5 GPM (5.7 L/min) max.				
 <p>DECKPLATE INCLUDED</p> 	<ul style="list-style-type: none"> • application: one or three hole • spout height: 15.50" • connection: 3/4" compression • number of functions: four-function • spray type: aerated stream; powerful cleaning rinse; boosted rinse; boosted stream • handle mounting: right only • hose length: 68" • deckplate: included • DC powered: 6 D-cell batteries included • voice activated kitchen: compatible with Amazon Just Ask Alexa and Works with Google Assistant 	7185EVC	827.30	Chrome	3	
		7185EVSRS	910.05	Spot Resist Stainless	3	
		7185EVORB	992.80	Oil Rubbed Bronze	3	
	OPTIONAL AC ADAPTERS SOLD SEPARATELY					
			169031	159.60	N/A or Unfinished	12
OPTIONAL WALL MOUNT & HOSE EXTENSION KIT SOLD SEPARATELY						
		199785	59.75	N/A or Unfinished	6	
						



		MODEL	LIST	FINISH/CONNECT	CASE QTY	
BRANTFORD® TOUCHLESS WITH MOTIONSENSE™ WAVE ONE-HANDLE KITCHEN PULLDOWN		1.5 GPM (5.7 L/min) max.				
 <p>DECKPLATE INCLUDED</p> 	<ul style="list-style-type: none"> • application: one or three hole • spout height: 15.50" • connection: 3/8" compression • number of functions: two-function • spray type: powerful cleaning rinse; aerated stream • handle mounting: right only • hose length: 68" • deckplate: included • DC powered: 6 AA cell batteries: included 	7185EWC	653.85	Chrome	3	
		7185EWSRS	817.35	Spot Resist Stainless	3	
		7185EWORB	915.40	Oil Rubbed Bronze	3	
	OPTIONAL AC ADAPTERS SOLD SEPARATELY					
			169031	159.60	N/A or Unfinished	12
OPTIONAL WALL MOUNT & HOSE EXTENSION KIT SOLD SEPARATELY						
		177566	49.05	N/A or Unfinished	6	
						



		MODEL	LIST	FINISH/CONNECT	CASE QTY
BRANTFORD® ONE-HANDLE KITCHEN PULLDOWN		1.5 GPM (5.7 L/min) max.			
 <p>DECKPLATE INCLUDED</p> 	<ul style="list-style-type: none"> • application: one or three hole • spout height: 15.50" • connection: 3/8" compression • number of functions: four-function • spray type: aerated stream; powerful cleaning rinse; boosted rinse; boosted stream • handle mounting: right only • hose length: 68" • deckplate: included 	7185C	494.45	Chrome	3
		7185SRS	618.05	Spot Resist Stainless	3
		7185ORB	692.20	Oil Rubbed Bronze	3
					









Kitchen Faucets

KITCHEN

		MODEL	LIST	FINISH/CONNECT	CASE QTY
BRANTFORD® ONE-HANDLE KITCHEN PULLOUT		1.5 GPM (5.7 L/min) max.			
 DECKPLATE INCLUDED 	<ul style="list-style-type: none"> • application: one or three hole • spout height: 12.94" • connection: 3/8" compression • number of functions: two-function • spray type: aerated stream; powerful cleaning rinse • hose length: 68" • deckplate: included 	7295SRS●	560.85	Spot Resist Stainless	3
	 POWER CLEAN reflex DURALOCK® DURALAST®				



		MODEL	LIST	FINISH/CONNECT	CASE QTY
ARBOR® SMART FAUCET ONE-HANDLE KITCHEN PULLDOWN		1.5 GPM (5.7 L/min) max.			
 DECKPLATE INCLUDED 	<ul style="list-style-type: none"> • application: one or three hole • spout height: 15.50" • connection: 3/8" compression • number of functions: four-function • spray type: aerated stream; powerful cleaning rinse; boosted rinse; boosted stream • handle mounting: right only • hose length: 68" • deckplate: included • DC powered: 6 D-cell batteries included • voice activated kitchen: compatible with Amazon Just Ask Alexa and Works with Google Assistant 	7594EVC	804.35	Chrome	3
		7594EVSRS●	884.80	Spot Resist Stainless	3
		7594EVBL	925.05	Matte Black	3
		7594EVORB	965.25	Oil Rubbed Bronze	3
	OPTIONAL AC ADAPTERS SOLD SEPARATELY				
		169031	159.60	N/A or Unfinished	12
OPTIONAL WALL MOUNT & HOSE EXTENSION KIT SOLD SEPARATELY					
		199785	59.75	N/A or Unfinished	6
 POWERBOOST reflex DURALOCK® DURALAST®					



		MODEL	LIST	FINISH/CONNECT	CASE QTY
ARBOR® TOUCHLESS WITH MOTIONSENSE™ WAVE ONE-HANDLE KITCHEN PULLDOWN		1.5 GPM (5.7 L/min) max.			
 DECKPLATE INCLUDED 	<ul style="list-style-type: none"> • application: one or three hole • spout height: 15.50" • connection: 3/8" compression • number of functions: two-function • spray type: powerful cleaning rinse; aerated stream • handle mounting: right only • hose length: 68" • deckplate: included • DC powered: 6 AA cell batteries: included 	7594EWC	631.30	Chrome	3
		7594EWSRS●	789.10	Spot Resist Stainless	3
		7594EWBL	820.65	Matte Black	3
		7594EWORB	883.80	Oil Rubbed Bronze	3
	OPTIONAL AC ADAPTERS SOLD SEPARATELY				
		169031	159.60	N/A or Unfinished	12
OPTIONAL WALL MOUNT & HOSE EXTENSION KIT SOLD SEPARATELY					
		177566	49.05	N/A or Unfinished	6
 motionsense WAVE POWER CLEAN reflex DURALOCK® DURALAST®					





		MODEL	LIST	FINISH/CONNECT	CASE QTY
ARBOR® ONE-HANDLE KITCHEN PULLDOWN		1.5 GPM (5.7 L/min) max.			
 DECKPLATE INCLUDED 	<ul style="list-style-type: none"> • application: one or three hole • spout height: 15.50" • connection: 3/8" compression • number of functions: four-function • spray type: aerated stream; powerful cleaning rinse; boosted rinse; boosted stream • handle mounting: right only • hose length: 68" • deckplate: included 	7594C	471.85	Chrome	3
		7594SRS●	589.80	Spot Resist Stainless	3
		7594BL	613.40	Matte Black	3
		7594ORB	660.60	Oil Rubbed Bronze	3
 POWERBOOST reflex DURALOCK® DURALAST®					





Kitchen Faucets

		MODEL	LIST	FINISH/CONNECT	CASE QTY
BELFIELD™ SMART FAUCET ONE-HANDLE KITCHEN PULLDOWN					
 <p>DECKPLATE INCLUDED</p>	<ul style="list-style-type: none"> • application: one or three hole • spout height: 15.62" • connection: 3/8" compression • number of functions: four-function • spray type: aerated stream; powerful cleaning rinse; boosted rinse; boosted stream • handle mounting: right only • hose length: 68" • deckplate: included • DC powered: 6 D-cell batteries included • voice activated kitchen: compatible with Amazon Just Ask Alexa and Works with Google Assistant 	1.5 GPM (5.7 L/min) max.			
			7260EVC	792.30	Chrome
7260EVSRS●	871.55		Spot Resist Stainless	3	
7260EVBL	911.10		Matte Black	3	
7260EVORB	950.75		Oil Rubbed Bronze	3	
OPTIONAL AC ADAPTERS SOLD SEPARATELY					
169031	159.60	N/A or Unfinished	12		
OPTIONAL WALL MOUNT & HOSE EXTENSION KIT SOLD SEPARATELY					
199785	59.75	N/A or Unfinished	6		
 POWERBOOST reflex DURALOCK® DURALAST®					

		MODEL	LIST	FINISH/CONNECT	CASE QTY
BELFIELD™ TOUCHLESS WITH MOTIONSENSE™ WAVE ONE-HANDLE KITCHEN PULLDOWN					
 <p>DECKPLATE INCLUDED</p>	<ul style="list-style-type: none"> • application: one or three hole • spout height: 15.62" • connection: 3/8" compression • number of functions: two-function • spray type: aerated stream; powerful cleaning rinse • handle mounting: right only • hose length: 68" • deckplate: included • DC powered: 6 AA cell batteries: included 	1.5 GPM (5.7 L/min) max.			
			7260EWC	619.45	Chrome
7260EWSRS●	774.30		Spot Resist Stainless	3	
7260EWBL	805.30		Matte Black	3	
7260EWORB	867.20		Oil Rubbed Bronze	3	
OPTIONAL AC ADAPTERS SOLD SEPARATELY					
169031	159.60	N/A or Unfinished	12		
OPTIONAL WALL MOUNT & HOSE EXTENSION KIT SOLD SEPARATELY					
177566	49.05	N/A or Unfinished	6		
 motionSense POWER CLEAN reflex DURALOCK® DURALAST®					



		MODEL	LIST	FINISH/CONNECT	CASE QTY
BELFIELD™ ONE-HANDLE KITCHEN SPRING PULLDOWN					
 <p>DECKPLATE INCLUDED</p>	<ul style="list-style-type: none"> • application: one or three hole • spout height: 17.26" • connection: 3/8" compression • number of functions: four-function • spray type: aerated stream; powerful cleaning rinse; boosted rinse; boosted stream • handle mounting: right only • hose length: 68" • deck plate: included 	1.5 GPM (5.7 L/min) max.			
			5927	542.35	Chrome
5927SRS●	677.90		Spot Resist Stainless	3	
5927BL	705.05		Matte Black	3	
5927ORB	759.25		Oil Rubbed Bronze	3	
 POWERBOOST DURALOCK® DURALAST® 					







		MODEL	LIST	FINISH/CONNECT	CASE QTY
BELFIELD™ ONE-HANDLE KITCHEN PULLDOWN					
 <p>DECKPLATE INCLUDED</p>	<ul style="list-style-type: none"> • application: one or three hole • spout height: 15.62" • connection: 3/8" compression • number of functions: four-function • spray type: aerated stream; powerful cleaning rinse; boosted rinse; boosted stream • handle mounting: right only • hose length: 68" • deckplate: included 	1.5 GPM (5.7 L/min) max.			
			7260	460.00	Chrome
7260SRS●	575.00		Spot Resist Stainless	3	
7260BL	598.05		Matte Black	3	
7260ORB	644.05		Oil Rubbed Bronze	3	
 POWERBOOST reflex DURALOCK® DURALAST®					









KITCHEN

Kitchen Faucets



BELFIELD™ ONE-HANDLE KITCHEN		MODEL	LIST	FINISH/CONNECT	CASE QTY
 DECKPLATE INCLUDED 	<ul style="list-style-type: none"> • application: two or four hole • spout height: 12.22" • connection: 3/8" compression • spray type: aerated stream • deckplate: included • side spray: included 	1.5 GPM (5.7 L/min) max.			
		7245C	399.45	Chrome	3
		7245SRS●	499.30	Spot Resist Stainless	3
		7245BL	519.25	Matte Black	3
		7245ORB	559.20	Oil Rubbed Bronze	3
 DURALOCK® DURALAST®					



BELFIELD™ TWO-HANDLE KITCHEN		MODEL	LIST	FINISH/CONNECT	CASE QTY
 	<ul style="list-style-type: none"> • application: four hole • spout height: 9.34" • connection: 1/2" IPS • spray type: aerated stream • deckplate: included • side spray: included 	1.5 GPM (5.7 L/min) max.			
		7255C	377.50	Chrome	3
		7255SRS●	471.90	Spot Resist Stainless	3
		7255BL	490.75	Matte Black	3
		7255ORB	528.50	Oil Rubbed Bronze	3
 DURALOCK® DURALAST®					
 	<ul style="list-style-type: none"> • application: three hole • spout height: 9.34" • connection: 1/2" IPS • spray type: aerated stream • deckplate: included 	1.5 GPM (5.7 L/min) max.			
		7250C	324.75	Chrome	3
		7250SRS●	405.95	Spot Resist Stainless	3
		7250BL	422.20	Matte Black	3
		7250ORB	454.70	Oil Rubbed Bronze	3
 DURALAST®					



GENTA™ LX TOUCHLESS WITH MOTIONSENSE™ WAVE ONE-HANDLE KITCHEN PULLDOWN		MODEL	LIST	FINISH/CONNECT	CASE QTY	
 DECKPLATE INCLUDED 	<ul style="list-style-type: none"> • application: one or three hole • spout height: 16.00" • connection: 3/8" compression • number of functions: two-function • spray type: aerated stream; powerful cleaning rinse • handle mounting: right only • hose length: 68" • deckplate: included • DC powered: 6 AA cell batteries: included 	1.5 GPM (5.7 L/min) max.				
		7882EWC	617.85	Chrome	3	
		7882EWSRS●	772.35	Spot Resist Stainless	3	
		7882EWBL	803.25	Matte Black	3	
		OPTIONAL AC ADAPTERS SOLD SEPARATELY				
		169031	159.60	N/A or Unfinished	12	
		OPTIONAL WALL MOUNT & HOSE EXTENSION KIT SOLD SEPARATELY				
177566	49.05	N/A or Unfinished	6			
 motionSense POWER CLEAN reflex DURALOCK® DURALAST®						



GENTA™ LX ONE-HANDLE KITCHEN SPRING PULLDOWN		MODEL	LIST	FINISH/CONNECT	CASE QTY
 DECKPLATE INCLUDED 	<ul style="list-style-type: none"> • application: one or three hole • spout height: 16.125" • connection: 3/8" compression • number of functions: four-function • spray type: aerated stream; powerful cleaning rinse; boosted rinse; boosted stream • handle mounting: right only • hose length: 68" • deck plate included 	1.5 GPM (5.7 L/min) max.			
		5926	540.50	Chrome	3
		5926SRS●	675.65	Spot Resist Stainless	3
		5926BL	702.70	Matte Black	3
		 POWERBOOST DURALOCK® DURALAST® (3x)			

Kitchen Faucets

GENTA™ LX		ONE-HANDLE KITCHEN PULLDOWN		MODEL	LIST	FINISH/CONNECT	CASE QTY
 DECKPLATE INCLUDED 	<ul style="list-style-type: none"> • application: one or three hole • spout height: 16.00" • connection: 3/8" compression • number of functions: four-function • pray type: aerated stream; powerful cleaning rinse; boosted rinse; boosted stream • handle mounting: right only • hose length: 68" • deckplate: included 	1.5 GPM (5.7 L/min) max.					
		7882	458.45	Chrome	3		
		7882SRS●	573.10	Spot Resist Stainless	3		
		7882BL	596.00	Matte Black	3		
							

SLEEK®		SMART FAUCET ONE-HANDLE KITCHEN PULLDOWN		MODEL	LIST	FINISH/CONNECT	CASE QTY
 DECKPLATE INCLUDED 	<ul style="list-style-type: none"> • application: one or three hole • spout height: 15.56" • connection: 3/8" compression • number of functions: four-function • spray type: aerated stream; powerful cleaning rinse; boosted rinse; boosted stream • handle mounting: right only • hose length: 68" • deckplate: included • DC powered: 6 D-cell batteries included • voice activated kitchen: compatible with Amazon Just Ask Alexa and Works with Google Assistant 	1.5 GPM (5.7 L/min) max.					
		7864EVC	751.10	Chrome	3		
		7864EVSRS●	826.15	Spot Resist Stainless	3		
		7864EVB�	863.75	Matte Black	3		
		7864EVBLS●	901.25	Black Stainless	3		
		7864EVBG	901.25	Brushed Gold	3		
		OPTIONAL AC ADAPTERS SOLD SEPARATELY					
169031	159.60	N/A or Unfinished	12				
OPTIONAL WALL MOUNT & HOSE EXTENSION KIT SOLD SEPARATELY							
199785	59.75	N/A or Unfinished	6				
							

SLEEK®		TOUCHLESS WITH MOTIONSENSE™ WAVE ONE-HANDLE SPRING KITCHEN PULLDOWN		MODEL	LIST	FINISH/CONNECT	CASE QTY
 DECKPLATE INCLUDED 	<ul style="list-style-type: none"> • application: one or three hole • spout height: 23.25" • connection: 3/8" compression • number of functions: two-function • spray type: aerated stream; powerful cleaning rinse • handle mounting: right only • hose length: 68" • deckplate: included • DC powered: 6 AA cell batteries included 	1.5 GPM (5.7 L/min) max.					
		5925EWC	666.55	Chrome	3		
		5925EWSRS●	833.20	Spot Resist Stainless	3		
		5925EWBL	866.55	Matte Black	3		
		5925EWBLS●	966.55	Black Stainless	3		
		OPTIONAL AC ADAPTERS SOLD SEPARATELY					
169031	159.60	N/A or Unfinished	12				
OPTIONAL WALL MOUNT & HOSE EXTENSION KIT SOLD SEPARATELY							
177566	49.05	N/A or Unfinished	6				
							











SLEEK®		TOUCHLESS WITH MOTIONSENSE™ WAVE ONE-HANDLE KITCHEN PULLDOWN		MODEL	LIST	FINISH/CONNECT	CASE QTY
 DECKPLATE INCLUDED 	<ul style="list-style-type: none"> • application: one or three hole • spout height: 15.56" • connection: 3/8" compression • number of functions: two-function • spray type: aerated stream; powerful cleaning rinse • handle mounting: right only • hose length: 68" • deckplate: included • DC powered: 6 AA cell batteries: included 	1.5 GPM (5.7 L/min) max.					
		7864EWC	578.90	Chrome	3		
		7864EWSRS●	723.65	Spot Resist Stainless	3		
		7864EWBL	752.55	Matte Black	3		
		7864EWBLS●	839.40	Black Stainless	3		
		7864EWBG	839.40	Brushed Gold	3		
		OPTIONAL AC ADAPTERS SOLD SEPARATELY					
169031	159.60	N/A or Unfinished	12				
OPTIONAL WALL MOUNT & HOSE EXTENSION KIT SOLD SEPARATELY							
177566	49.05	N/A or Unfinished	6				
							













KITCHEN

Kitchen Faucets

KITCHEN

		MODEL	LIST	FINISH/CONNECT	CASE QTY
SLEEK® ONE-HANDLE KITCHEN SPRING PULLDOWN					
 DECKPLATE INCLUDED 	<ul style="list-style-type: none"> • application: one or three hole • spout height: 23.25" • connection: 3/8" compression • number of functions: four-function • spray type: aerated stream; powerful cleaning rinse; boosted rinse; boosted stream • handle mounting: right only • hose length: 68" • deckplate: included 	1.5 GPM (5.7 L/min) max.			
			5925	513.50	Chrome
		5925SRS ●	641.90	Spot Resist Stainless	3
		5925BL	667.55	Matte Black	3
		5925BLS ●	744.60	Black Stainless	3
		 POWERBOOST DURALOCK® DURALAST® 			
SLEEK® ONE-HANDLE KITCHEN PULLDOWN					
	<ul style="list-style-type: none"> • application: two hole • spout height: 15.56" • connection: 3/8" compression • number of functions: four-function • spray type: aerated stream; powerful cleaning rinse; boosted rinse; boosted stream • handle mounting: right only • hose length: 68" 	1.5 GPM (5.7 L/min) max.			
			7871	461.45	Chrome
		7871SRS ●	576.80	Spot Resist Stainless	3
		7871BL	599.90	Matte Black	3
		 POWERBOOST reflex DURALOCK® DURALAST®			
SLEEK® ONE-HANDLE KITCHEN PULLDOWN					
 DECKPLATE INCLUDED 	<ul style="list-style-type: none"> • application: one or three hole • spout height: 15.56" • connection: 3/8" compression • number of functions: four-function • spray type: aerated stream; powerful cleaning rinse; boosted rinse; boosted stream • handle mounting: right only • hose length: 68" • deckplate: included 	1.5 GPM (5.7 L/min) max.			
			7864	419.50	Chrome
		7864SRS ●	524.35	Spot Resist Stainless	3
		7864BL	545.30	Matte Black	3
		7864ORB	587.25	Oil Rubbed Bronze	3
		7864BLS ●	608.25	Black Stainless	3
		7864BG	608.25	Brushed Gold	3
		 POWERBOOST reflex DURALOCK® DURALAST®			
CAMERIST® ONE-HANDLE KITCHEN PULLOUT					
 DECKPLATE INCLUDED 	<ul style="list-style-type: none"> • application: one or three hole • spout height: 12.00" • connection: 3/8" compression • number of functions: two-function • spray type: aerated stream; powerful cleaning rinse • hose length: 68" • deckplate: included 	1.5 GPM (5.7 L/min) max.			
			7545C ◆	448.70	Chrome
		7545SRS ●	560.85	Spot Resist Stainless	3
		7545ORB	628.20	Oil Rubbed Bronze	3
		 POWERCLEAN reflex DURALOCK® DURALAST®			











Kitchen Faucets





		MODEL	LIST	FINISH/CONNECT	CASE QTY
CAMERIST® ONE-HANDLE KITCHEN					
 DECKPLATE INCLUDED	<ul style="list-style-type: none"> • application: two or four hole • spout height: 8.13" • connection: 3/8" compression • spray type: aerated stream • deckplate: included • side spray: included 	1.5 GPM (5.7 L/min) max.			
		7840◆	275.10	Chrome	3
	<ul style="list-style-type: none"> • application: one or three hole • spout height: 8.13" • connection: 3/8" compression • spray type: aerated stream • deckplate: included 	1.5 GPM (5.7 L/min) max.			
		7825	230.70	Chrome	3
	<ul style="list-style-type: none"> • application: one or three hole • spout height: 8.13" • connection: 3/8" compression • spray type: aerated stream • deckplate: included 	1.5 GPM (5.7 L/min) max.			
		7825SRS●	288.40	Spot Resist Stainless	3
 DURALOCK® DURALAST®					
INTEGRA® ONE-HANDLE KITCHEN PULLOUT					
 DECKPLATE INCLUDED	<ul style="list-style-type: none"> • application: one or three hole • spout height: 10.63" • connection: 3/8" compression • number of functions: two-function • spray type: aerated stream; powerful cleaning rinse • hose length: 59" • deckplate: included 	1.5 GPM (5.7 L/min) max.			
		67315C◆	319.25	Chrome	6
	<ul style="list-style-type: none"> • application: one or three hole • spout height: 10.63" • connection: 3/8" compression • number of functions: two-function • spray type: aerated stream; powerful cleaning rinse • hose length: 59" • deckplate: included 	1.5 GPM (5.7 L/min) max.			
		67315SRS●◆	399.05	Spot Resist Stainless	6
 POWER CLEAN® DURALOCK® DURALAST®					
METHOD™ ONE-HANDLE KITCHEN PULLOUT					
 DECKPLATE INCLUDED	<ul style="list-style-type: none"> • application: one or three hole • spout height: 9.04" • connection: 3/8" compression • number of functions: two-function • spray type: aerated stream; powerful cleaning rinse • hose length: 68" • deckplate: included 	1.5 GPM (5.7 L/min) max.			
		7585C	262.80	Chrome	3
	<ul style="list-style-type: none"> • application: one or three hole • spout height: 9.04" • connection: 3/8" compression • number of functions: two-function • spray type: aerated stream; powerful cleaning rinse • hose length: 68" • deckplate: included 	1.5 GPM (5.7 L/min) max.			
		7585SRS●	328.50	Spot Resist Stainless	3
 POWER CLEAN® DURALOCK® DURALAST®					

KITCHEN

Kitchen Faucets

KITCHEN

CHATEAU®		MODEL	LIST	FINISH/CONNECT	CASE QTY
ONE-HANDLE KITCHEN					
 <ul style="list-style-type: none"> • application: four hole • spout height: 8.50" • connection: 3/8" compression • spray type: aerated stream • side spray: included 		1.5 GPM (5.7 L/min) max.			
		7430◆	222.85	Chrome	6
		7430SRS●	278.60	Spot Resist Stainless	6
	 DURALOCK® DURALAST®				
 <ul style="list-style-type: none"> • application: two hole • spout height: 8.94" • connection: 3/8" compression • spray type: aerated stream • side spray: included 		1.5 GPM (5.7 L/min) max.			
		7437	227.65	Chrome	6
		 DURALOCK® DURALAST®			
 <ul style="list-style-type: none"> • application: three hole • spout height: 8.50" • connection: 3/8" compression • spray type: aerated stream • side spray: included 		1.5 GPM (5.7 L/min) max.			
		7434◆	222.85	Chrome	6
		 DURALOCK® DURALAST®			
 <ul style="list-style-type: none"> • application: three hole • spout height: 8.50" • connection: 3/8" compression • spray type: aerated stream 		1.5 GPM (5.7 L/min) max.			
		7425◆	177.10	Chrome	6
		7425SRS●	221.40	Spot Resist Stainless	6
	 DURALAST®				
 <ul style="list-style-type: none"> • application: one hole • spout height: 8.94" • connection: 3/8" compression • spray type: aerated stream 		1.5 GPM (5.7 L/min) max.			
		7423	180.50	Chrome	6
		 DURALAST®			

CHATEAU®					
TWO-HANDLE KITCHEN					
 <ul style="list-style-type: none"> • application: four hole • spout height: 6.50" • connection: 1/2" IPS • spray type: aerated stream • side spray: included 		1.5 GPM (5.7 L/min) max.			
		7907	211.55	Chrome	6
		 DURALOCK® DURALAST®			
 <ul style="list-style-type: none"> • application: three hole • spout height: 6.50" • connection: 1/2" IPS • spray type: aerated stream 		1.5 GPM (5.7 L/min) max.			
		7906	168.15	Chrome	6
		 DURALAST®			

Modern

Traditional

Premium Pot Fillers

The pot filler is the ultimate epicurean luxury, with all the details needed to ensure convenient flow control over a cooktop. They are available in traditional and modern styles to coordinate with any décor preference.



KITCHEN

		MODEL	LIST	FINISH/CONNECT	CASE QTY
MODERN POT FILLER	TWO-HANDLE KITCHEN POT FILLER - PREMIUM				
	<ul style="list-style-type: none"> • application: one hole • spout reach: 24.00" • connection: 1/2" IPS • spray type: aerated stream 	5.5 GPM (21 L/min) max.			
		S665	802.45	Chrome	3
		S665SRS ●	1003.10	Spot Resist Stainless	3
		S665BL	1043.20	Matte Black	3
		S665BLS ●	1163.60	Black Stainless	3
		S665BG	1163.60	Brushed Gold	3

TRADITIONAL POT FILLER	TWO-HANDLE KITCHEN POT FILLER - PREMIUM				
	<ul style="list-style-type: none"> • application: one hole • spout reach: 24.00" • connection: 1/2" IPS • spray type: aerated stream 	5.5 GPM (21 L/min) max.			
		S664	802.45	Chrome	3
		S664SRS ●	1003.10	Spot Resist Stainless	3
		S664BL	1043.20	Matte Black	3
		S664NL	1083.35	Polished Nickel	3
		S664ORB	1123.45	Oil Rubbed Bronze	3
		S664BG	1163.60	Brushed Gold	3
		Q2 NEW! S664BZG	1608.95	Bronzed Gold	3

Premium Bar/Prep Faucets

KITCHEN

Nio™

Tenon™ **NEW!**

Weymouth®



Sinema™



Paterson™

Premium Bar/Prep Kitchen Faucets















Perfect for secondary sinks, bar/prep kitchen faucets combine design and functionality. Available in array of design options, Moen® bar/prep kitchen faucets match perfectly with almost any decorating style.



	MODEL	LIST	FINISH/CONNECT	CASE QTY
NIO™ ONE-HANDLE KITCHEN BAR - PREMIUM				
 	1.5 GPM (5.7 L/min) max.			
	S55005	748.05	Chrome	3
	S55005SRS●	935.05	Spot Resist Stainless	3
	S55005BL	972.40	Matte Black	3
	S55005BLS●	1086.25	Black Stainless	3
<ul style="list-style-type: none"> • application: one hole • spout height: 13.96" • connection: 3/8" compression • spray type: aerated stream • handle mounting: right only • secondary two-tone handle option included: chrome faucet has matte black handle; matte black faucet has brushed gold handle; spot resist faucet has matte black handle; black stainless faucet has spot resist stainless handle 				
				

	MODEL	LIST	FINISH/CONNECT	CASE QTY
TENON™ ONE-HANDLE KITCHEN BAR PULLDOWN - PREMIUM				
 	1.5 GPM (5.7 L/min) max.			
	S64001	720.00	Chrome	3
	S64001SRS●	900.00	Spot Resist Stainless	3
	S64001BL	936.00	Matte Black	3
	S64001BG	1044.00	Brushed Gold	3
<ul style="list-style-type: none"> • application: one hole • spout height: 14.44" • connection: 3/8" compression • number of functions: four-function • spray type: aerated stream; powerful cleaning rinse; boosted rinse; boosted stream • handle mounting: right only • hose length: 68" • unique wood handle assembled on faucet • secondary matching finish handle: included 				
				

Premium Bar/Prep Faucets

		MODEL	LIST	FINISH/CONNECT	CASE QTY	
WEYMOUTH® ONE-HANDLE KITCHEN BAR PULLDOWN - PREMIUM						
 	<ul style="list-style-type: none"> • spray wand: metal • application: one hole • spout height: 14.66" • connection: 3/8" compression • number of functions: two-function • spray type: aerated stream; powerful cleaning rinse • handle mounting: right only • hose length: 68" • included: choice of matching finish or porcelain handle cap 	1.5 GPM (5.7 L/min) max.				
		S53004	639.00	Chrome	3	
		S53004SRS●	798.75	Spot Resist Stainless	3	
		S53004BL	830.75	Matte Black	3	
		S53004NL	862.65	Polished Nickel	3	
		S53004ORB	894.60	Oil Rubbed Bronze	3	
		S53004BG	926.60	Brushed Gold	3	
 POWER CLEAN reflex  DURALOCK® DURALAST®						
WEYMOUTH® ONE-HANDLE KITCHEN BAR - PREMIUM						
	<ul style="list-style-type: none"> • application: one hole • spout height: 7.81" • connection: 3/8" compression • spray type: aerated stream • handle mounting: right only 	1.5 GPM (5.7 L/min) max.				
		S62101	659.40	Chrome	3	
		S62101SRS●	824.20	Spot Resist Stainless	3	
		S62101BL	857.20	Matte Black	3	
		S62101NL	890.15	Polished Nickel	3	
		S62101ORB	923.10	Oil Rubbed Bronze	3	
		S62101BG	956.10	Brushed Gold	3	
 DURALAST®						
SINEMA™ ONE-HANDLE KITCHEN BAR PULLDOWN - PREMIUM						
 	<ul style="list-style-type: none"> • spray wand: metal • application: one hole • spout height: 15.00" • connection: 3/8" compression • number of functions: two-function • spray type: aerated stream; powerful cleaning rinse • handle mounting: right only • hose length: 68" • two-tone art deco-inspired etched handle installed on faucet; secondary matching finish handle option included 	1.5 GPM (5.7 L/min) max.				
		S6235	620.70	Chrome	3	
		S6235SRS●	775.95	Spot Resist Stainless	3	
		S6235BL	806.95	Matte Black	3	
		S6235NL	838.00	Polished Nickel	3	
	 POWER CLEAN reflex  DURALOCK® DURALAST®					
	PATERSON™ ONE-HANDLE KITCHEN BAR PULLDOWN - PREMIUM					
 	<ul style="list-style-type: none"> • spray wand: metal • application: one hole • spout height: 14.31" • connection: 3/8" compression • number of functions: two-function • spray type: aerated stream; powerful cleaning rinse • handle mounting: right only • hose length: 68" • secondary wheel handle option: included 	1.5 GPM (5.7 L/min) max.				
		S52003	620.20	Chrome	3	
		S52003SRS●	775.25	Spot Resist Stainless	3	
		S52003BL	806.25	Matte Black	3	
	 POWER CLEAN reflex  DURALOCK® DURALAST®					

KITCHEN

Bar/Prep Faucets



KITCHEN



- Cia™
- Align®
- KURV™
- Smyth™ **NEW!**
- Brantford®
- Arbor®
- Belfield™
- Genta™ LX
- Sleek®
- Camerist®
- Chateau®

Bar/Prep Kitchen Faucets













Combining performance and reliability, Moen® bar/prep faucets are tailored to perfection. Available in your choice of unique design options, these functional collections are sure to complete any kitchen.



		MODEL	LIST	FINISH/CONNECT	CASE QTY	
CIA™ ONE-HANDLE KITCHEN BAR		1.5 GPM (5.7 L/min) max.				
 DECKPLATE SOLD SEPARATELY	<ul style="list-style-type: none"> • application: one hole • spout height: 14.00" • connection: 3/8" compression • spray type: aerated stream • handle mounting: right only 	5622	540.35	Chrome	3	
		5622SRS●	675.45	Spot Resist Stainless	3	
		5622BL	702.50	Matte Black	3	
		5622BG	783.55	Brushed Gold	3	
		OPTIONAL DECKPLATE SOLD SEPARATELY				
		141002	57.75	Chrome	6	
		141002SRS●	66.25	Spot Resist Stainless	6	
		141002BL	66.25	Matte Black	6	
		141002BG	66.25	Brushed Gold	6	

		MODEL	LIST	FINISH/CONNECT	CASE QTY
ALIGN® ONE-HANDLE KITCHEN BAR PULLDOWN		1.5 GPM (5.7 L/min) max.			
 DECKPLATE SOLD SEPARATELY	<ul style="list-style-type: none"> • application: one or three hole • spout height: 13.75" • connection: 3/8" compression • number of functions: two-function • spray type: aerated stream; powerful cleaning rinse • handle mounting: right only • hose length: 68" 	5965	514.65	Chrome	3
		5965SRS●	643.35	Spot Resist Stainless	3
		5965BL	669.05	Matte Black	3
		5965BLS●	746.25	Black Stainless	3
		5965BG	746.25	Brushed Gold	3
		OPTIONAL DECKPLATE SOLD SEPARATELY			
		141002	57.75	Chrome	6
		141002SRS●	66.25	Spot Resist Stainless	6
		141002BL	66.25	Matte Black	6
		141002BLS●	72.90	Black Stainless	6
		141002BG	66.25	Brushed Gold	6



Bar/Prep Faucets



		MODEL	LIST	FINISH/CONNECT	CASE QTY
KURV™ ONE-HANDLE KITCHEN BAR PULLDOWN					
 DECKPLATE SOLD SEPARATELY 	<ul style="list-style-type: none"> • spray wand: metal • application: one to three hole • spout height: 13.31" • connection: 3/8" compression • number of functions: two-function • spray type: aerated stream; powerful cleaning rinse • handle mounting: right only • hose length: 68" 	1.5 GPM (5.7 L/min) max.			
		6126	503.15	Chrome	3
		6126SRS●	628.90	Spot Resist Stainless	3
		6126BL	654.10	Matte Black	3
		6126NL	679.25	Polished Nickel	3
		OPTIONAL DECKPLATE SOLD SEPARATELY			
		141002	57.75	Chrome	6
		141002SRS●	66.25	Spot Resist Stainless	6
		141002BL	66.25	Matte Black	6
		141002NL	62.85	Polished Nickel	6
 POWER CLEAN reflex DURALOCK® DURALAST®					
SMYTH™ ONE-HANDLE KITCHEN BAR PULLDOWN					
 DECKPLATE SOLD SEPARATELY 	<ul style="list-style-type: none"> • application: one to three hole • spout height: 14.14" • connection: 3/8" compression • number of functions: two-function • spray type: aerated stream; powerful cleaning rinse • handle mounting: right only • hose length: 68" 	1.5 GPM (5.7 L/min) max.			
		5770SRS●	579.40	Spot Resist Stainless	3
		5770BL	602.55	Matte Black	3
		5770NL	625.75	Polished Nickel	3
		5770BZG	672.10	Bronzed Gold	3
 POWER CLEAN reflex DURALOCK® DURALAST®					
BRANTFORD® ONE-HANDLE KITCHEN BAR PULLDOWN					
 DECKPLATE SOLD SEPARATELY 	<ul style="list-style-type: none"> • application: one or three hole • spout height: 14.38" • connection: 3/8" compression • number of functions: two-function • spray type: aerated stream; powerful cleaning rinse • handle mounting: right only • hose length: 68" 	1.5 GPM (5.7 L/min) max.			
		5985ORB	634.85	Oil Rubbed Bronze	3
		OPTIONAL DECKPLATE SOLD SEPARATELY			
		141002ORB	73.05	Oil Rubbed Bronze	6
 POWER CLEAN reflex DURALOCK® DURALAST®					
ARBOR® ONE-HANDLE KITCHEN BAR PULLDOWN					
 DECKPLATE SOLD SEPARATELY 	<ul style="list-style-type: none"> • application: one or three hole • spout height: 14.38" • connection: 3/8" compression • number of functions: two-function • spray type: aerated stream; powerful cleaning rinse • handle mounting: right only • hose length: 68" 	1.5 GPM (5.7 L/min) max.			
		5995	423.60	Chrome	3
		5995SRS●	529.50	Spot Resist Stainless	3
		5995BL	550.70	Matte Black	3
		5995ORB	593.05	Oil Rubbed Bronze	3
		OPTIONAL DECKPLATE SOLD SEPARATELY			
		141002	57.75	Chrome	6
		141002SRS●	66.25	Spot Resist Stainless	6
		141002BL	66.25	Matte Black	6
		141002ORB	73.05	Oil Rubbed Bronze	6
 POWER CLEAN reflex DURALOCK® DURALAST®					



KITCHEN



Bar/Prep Faucets

KITCHEN

BELFIELD™		ONE-HANDLE KITCHEN BAR PULLDOWN		MODEL	LIST	FINISH/CONNECT	CASE QTY	
 DECKPLATE SOLD SEPARATELY 	<ul style="list-style-type: none"> • application: one to three hole • spout height: 14.39" • connection: 3/8" compression • number of functions: two-function • spray type: aerated stream; powerful cleaning rinse • handle mounting: right only • hose length: 68" 	1.5 GPM (5.7 L/min) max.						
				6260	413.95	Chrome	3	
				6260SRS●	517.45	Spot Resist Stainless	3	
				6260BL	538.15	Matte Black	3	
				6260ORB	579.55	Oil Rubbed Bronze	3	
				OPTIONAL DECKPLATE SOLD SEPARATELY				
				141002	57.75	Chrome	6	
				141002SRS●	66.25	Spot Resist Stainless	6	
				141002BL	66.25	Matte Black	6	
				141002ORB	73.05	Oil Rubbed Bronze	6	
				 POWER CLEAN reflex DURALOCK® DURALAST®				

GENTA™ LX		ONE-HANDLE KITCHEN BAR		MODEL	LIST	FINISH/CONNECT	CASE QTY
 DECKPLATE INCLUDED 	<ul style="list-style-type: none"> • application: one hole • spout height: 14.30" • limited spout rotation: 125° • connection: 3/8" compression • spray type: aerated stream • handle mounting: right only • deck plate included 	1.5 GPM (5.7 L/min) max.					
				5882	381.35	Chrome	3
				5882SRS●	480.50	Spot Resist Stainless	3
				5882BL	495.75	Matte Black	3
				 DURALOCK® DURALAST®			

SLEEK®		ONE-HANDLE KITCHEN BAR PULLDOWN		MODEL	LIST	FINISH/CONNECT	CASE QTY
 DECKPLATE SOLD SEPARATELY 	<ul style="list-style-type: none"> • application: one or three hole • spout height: 14.46" • connection: 3/8" compression • number of functions: two-function • spray type: aerated stream; powerful cleaning rinse • handle mounting: right only • hose length: 68" 	1.5 GPM (5.7 L/min) max.					
				7664	377.50	Chrome	3
				7664SRS●	471.90	Spot Resist Stainless	3
				7664BL	490.75	Matte Black	3
				7664ORB	528.50	Oil Rubbed Bronze	3
				7664BLS●	547.40	Black Stainless	3
				7664BG	547.40	Brushed Gold	3
				OPTIONAL DECKPLATE SOLD SEPARATELY			
				141002	57.75	Chrome	6
				141002SRS●	66.25	Spot Resist Stainless	6
				141002BL	66.25	Matte Black	6
				141002ORB	73.05	Oil Rubbed Bronze	6
				141002BLS●	72.90	Black Stainless	6
				141002BG	66.25	Brushed Gold	6
				 POWER CLEAN reflex DURALOCK® DURALAST®			

CAMERIST®		ONE-HANDLE KITCHEN BAR		MODEL	LIST	FINISH/CONNECT	CASE QTY
	<ul style="list-style-type: none"> • application: two hole • spout height: 11.00" • connection: 3/8" compression • spray type: aerated stream 	1.5 GPM (5.7 L/min) max.					
				4905	270.45	Chrome	3
				4905SRS●	338.05	Spot Resist Stainless	3
				 DURALOCK® DURALAST®			

CHATEAU®		TWO-HANDLE KITCHEN BAR		MODEL	LIST	FINISH/CONNECT	CASE QTY
	<ul style="list-style-type: none"> • application: two hole • spout height: 10.50" • connection: 1/2" IPS • spray type: aerated stream 	1.5 GPM (5.7 L/min) max.					
				4903	130.90	Chrome	12

Arbor®

Chateau®

Laundry Faucets

Take your laundry and utility area to the next level with improved style, simplicity and enhanced mobility. Moen® laundry room faucets feature the best in form and function, with options that elevate everyday tasks such as increased flow rates, extended sink reach, and multiple sprays to make cleaning easier and more efficient.



KITCHEN

		MODEL	LIST	FINISH/CONNECT	CASE QTY
ARBOR®	ONE-HANDLE LAUNDRY PULLDOWN				
	<ul style="list-style-type: none"> • application: one hole • spout height: 16.87 • connection: 3/8" compression • threaded spout can accommodate a garden hose • number of functions: one-function • spray type: aerated stream • hose length: 62" • deckplate not available 	4.0 GPM (15.14 L/min) max. 4736	323.00	Chrome	3
	 reflex DURALAST®				
CHATEAU®	TWO-HANDLE KITCHEN LAUNDRY				
	<ul style="list-style-type: none"> • application: two hole • spout height: 6.63" • connection: 1/2" IPS • spray type: aerated stream • water usage: unrestricted 	Unrestricted 4975	133.45	Chrome	12
	DURALAST®				
	<ul style="list-style-type: none"> • application: two hole • spout height: 6.63" • connection: 1/2" IPS • spray type: aerated stream • water usage: unrestricted 	Unrestricted 74998	100.25	Chrome	12
	 DURALAST®				

3-in-1 Water Filtration Pulldown Kitchen Faucets

KITCHEN

Weymouth®

Sinema™

Paterson™



Align®



KURV™

NEW! 3-in-1 Water Filtration Pulldown Kitchen Faucet



The Moen® 3-in-1 Water Filtration Pulldown Kitchen Faucet dispenses both filtered cold water, and hot and cold tap water through two separate water channels, eliminating any chance of mixed water flow. For drinking and cooking, flip the button on the spray head for filtered water; for tap water, use the lever handle. Environmentally friendly, pair with any Moen filtration system to put filtered water at your fingertips.









		MODEL	LIST	FINISH/CONNECT	CASE QTY
WEYMOUTH® 3-IN-1 WATER FILTRATION PULLDOWN KITCHEN FAUCET - PREMIUM					
 	<ul style="list-style-type: none"> • water filtration at the spray wand • spray wand: metal • application: one hole • spout height: 16.73" • connection: 3/8" compression • number of functions: three-function • spray type: filtered laminar stream; unfiltered aerated stream; unfiltered PowerClean spray • handle mounting: right only • hose length: 68" • included: choice of matching finish or porcelain handle cap 	1.5 GPM (5.7 L/min) max.			
		FS73004	784.40	Chrome	3
		FS73004SRS●	980.50	Spot Resist Stainless	3
		FS73004NL	1058.90	Polished Nickel	3
		FS73004ORB	1098.15	Oil Rubbed Bronze	3
		FS73004BG	1137.35	Brushed Gold	3
 reflex DURALOCK® DURALAST®					

SINEMA™ 3-IN-1 WATER FILTRATION PULLDOWN KITCHEN FAUCET - PREMIUM					
 	<ul style="list-style-type: none"> • water filtration at the spray wand • spray wand: metal • application: one hole • spout height: 17.75" • connection: 3/8" compression • number of functions: three-function • spray type: filtered laminar stream; unfiltered aerated stream; unfiltered PowerClean spray • handle mounting: right only • hose length: 68" • two-tone art deco-inspired etched handle installed on faucet; secondary matching finish handle option included 	1.5 GPM (5.7 L/min) max.			
		FS7235	780.70	Chrome	3
		FS7235SRS●	975.90	Spot Resist Stainless	3
		FS7235BL	1014.95	Matte Black	3
 reflex DURALOCK® DURALAST®					

3-in-1 Water Filtration Pulldown Kitchen Faucets

		MODEL	LIST	FINISH/CONNECT	CASE QTY
PATERSON™		3-IN-1 WATER FILTRATION PULLDOWN KITCHEN FAUCET – PREMIUM			
 	<ul style="list-style-type: none"> • water filtration at the spray wand • spray wand: metal • application: one hole • spout height: 17.00" • connection: 3/8" compression • number of functions: three-function • spray type: filtered laminar stream; unfiltered aerated stream; unfiltered PowerClean spray • handle mounting: right only • hose length: 68" • secondary wheel handle option: included 	1.5 GPM (5.7 L/min) max.			
		FS72003	765.55	Chrome	3
		FS72003SRS●	956.95	Spot Resist Stainless	3
		FS72003BL	995.25	Matte Black	3
		 DURALOCK® DURALAST®			

		MODEL	LIST	FINISH/CONNECT	CASE QTY
ALIGN®		3-IN-1 WATER FILTRATION PULLDOWN KITCHEN FAUCET			
 <p>DECKPLATE SOLD SEPARATELY</p> 	<ul style="list-style-type: none"> • water filtration at the spray wand • spray wand: metal • application: one hole • spout height: 15.63" • connection: 3/8" compression • number of functions: three-function • spray type: filtered laminar stream; unfiltered aerated stream; unfiltered PowerClean spray • handle mounting: right only • hose length: 68" 	1.5 GPM (5.7 L/min) max.			
		F5923	723.75	Chrome	3
		F5923SRS●	906.00	Spot Resist Stainless	3
		F5923BL	942.25	Matte Black	3
	F5923BG	1051.45	Brushed Gold	3	
		OPTIONAL DECKPLATE SOLD SEPARATELY			
	141002	57.75	Chrome	6	
	141002SRS●	66.25	Spot Resist Stainless	6	
	141002BL	66.25	Matte Black	6	
	141002BG	66.25	Brushed Gold	6	
		 DURALOCK® DURALAST® 			

		MODEL	LIST	FINISH/CONNECT	CASE QTY
KURV™		3-IN-1 WATER FILTRATION PULLDOWN KITCHEN FAUCET			
 <p>DECKPLATE SOLD SEPARATELY</p> 	<ul style="list-style-type: none"> • water filtration at the spray wand • spray wand: metal • application: one hole • spout height: 16.38" • connection: 3/8" compression • number of functions: three-function • spray type: filtered laminar stream; unfiltered aerated stream; unfiltered PowerClean spray • handle mounting: right only • hose length: 68" 	1.5 GPM (5.7 L/min) max.			
		F9126	657.30	Chrome	3
		F9126SRS●	821.65	Spot Resist Stainless	3
		F9126BL	854.50	Matte Black	3
		OPTIONAL DECKPLATE SOLD SEPARATELY			
	141002	57.75	Chrome	6	
	141002SRS●	66.25	Spot Resist Stainless	6	
	141002BL	66.25	Matte Black	6	
		 DURALOCK® DURALAST®			

Water Filtration Systems & Faucets

KITCHEN

SIP DRINKING WATER FAUCETS | REVERSE OSMOSIS & CARBON FILTRATION COMPATIBLE FAUCETS

- Modern
- Traditional
- Transitional









SIP DRINKING WATER FAUCETS | CARBON FILTRATION COMPATIBLE FAUCETS

- Nio™
- Modern
- Paterson™
- Traditional
- KURV™
- Sinema™
- Transitional

SIP™ Drinking Water

The Moen® SIP™ drinking water faucets make filtering cold tap water at your kitchen sink easier than ever before. They're available in multiple styles and finish options, providing you with a dedicated faucet for clean filtered water that matches the design of your kitchen.



		MODEL	LIST	FINISH/CONNECT	CASE QTY
MODERN	REVERSE OSMOSIS & CARBON FILTRATION COMPATIBLE DRINKING WATER FAUCETS				
	<ul style="list-style-type: none"> • compatible with Moen filtration systems • integrated air gap for use with Reverse Osmosis Systems • easy, DIY installation • F9800 + F9900 filtration systems sold separately 	1.5 GPM (5.7 L/min) max.			
		F7660	199.95	Chrome	6
		F7660SRS●	249.95	Spot Resist Stainless	6
		F7660BL	259.95	Matte Black	6
					
TRADITIONAL	REVERSE OSMOSIS & CARBON FILTRATION COMPATIBLE DRINKING WATER FAUCETS				
	<ul style="list-style-type: none"> • compatible with Moen filtration systems • integrated air gap for use with Reverse Osmosis Systems • easy, DIY installation • F9800 + F9900 filtration systems sold separately 	1.5 GPM (5.7 L/min) max.			
		F7600	199.95	Chrome	6
		F7600SRS●	249.95	Spot Resist Stainless	6
		F7600BL	259.95	Matte Black	6
		Q2  F7600BZG	269.95	Bronzed Gold	6
					
TRANSITIONAL	REVERSE OSMOSIS & CARBON FILTRATION COMPATIBLE DRINKING WATER FAUCETS - PREMIUM				
	<ul style="list-style-type: none"> • compatible with Moen filtration systems • integrated air gap for use with Reverse Osmosis Systems • easy, DIY installation • F9800 + F9900 filtration systems sold separately 	1.5 GPM (5.7 L/min) max.			
		F7620	199.95	Chrome	6
		F7620SRS●	249.95	Spot Resist Stainless	6
		F7620BL	259.95	Matte Black	6
					
NIO™	CARBON FILTRATION COMPATIBLE FAUCETS - PREMIUM				
	<ul style="list-style-type: none"> • spout height: 10.88 • LED escutcheon for filter life indication • compatible with F9800 + 262578: sold separately • compatible with carbon filtration systems 	1.5 GPM (5.7 L/min) max.			
		S5550	432.85	Chrome	3
		S5550SRS●	541.05	Spot Resist Stainless	3
		S5550BL	562.75	Matte Black	3
		S5550BLS●	627.65	Black Stainless	3
					

Water Filtration Systems & Faucets

		MODEL	LIST	FINISH/CONNECT	CASE QTY
MODERN	CARBON FILTRATION COMPATIBLE FAUCETS - PREMIUM				
	<ul style="list-style-type: none"> • spout height: 10.88 • LED escutcheon for filter life indication • compatible with F9800 + 262578: sold separately • compatible with carbon filtration systems 	1.5 GPM (5.7 L/min) max.			
		S5530	432.85	Chrome	3
		S5530SRS●	541.05	Spot Resist Stainless	3
		S5530BL	562.75	Matte Black	3
		S5530BLS●	627.65	Black Stainless	3
		S5530BG	627.65	Brushed Gold	3
	 DURALAST®				
PATERSON™	CARBON FILTRATION COMPATIBLE FAUCETS - PREMIUM				
	<ul style="list-style-type: none"> • spout height: 10.88 • LED escutcheon for filter life indication • compatible with F9800 + 262578: sold separately • compatible with carbon filtration systems 	1.5 GPM (5.7 L/min) max.			
		S5540●	432.85	Chrome	3
		S5540SRS●	541.05	Spot Resist Stainless	3
		S5540BL	562.75	Matte Black	3
	 DURALAST®				
TRADITIONAL	CARBON FILTRATION COMPATIBLE FAUCETS - PREMIUM				
	<ul style="list-style-type: none"> • spout height: 10.88 • LED escutcheon for filter life indication • compatible with F9800 + 262578: sold separately • compatible with carbon filtration systems 	1.5 GPM (5.7 L/min) max.			
		S5510	432.85	Chrome	3
		S5510SRS●	541.05	Spot Resist Stainless	3
		S5510BL	562.75	Matte Black	3
		S5510NL	584.35	Polished Nickel	3
		S5510ORB	606.00	Oil Rubbed Bronze	3
		S5510BG	627.65	Brushed Gold	3
	 DURALAST®				
KURV™	CARBON FILTRATION COMPATIBLE FAUCETS - PREMIUM				
	<ul style="list-style-type: none"> • spout height: 10.88 • LED escutcheon for filter life indication • compatible with F9800 + 262578: sold separately • compatible with carbon filtration systems 	1.5 GPM (5.7 L/min) max.			
		S5560	412.30	Chrome	3
		S5560SRS●	515.30	Spot Resist Stainless	3
		S5560BL	535.95	Matte Black	3
		S5560NL	556.55	Polished Nickel	3
	 DURALAST®				
SINEMA™	CARBON FILTRATION COMPATIBLE FAUCETS - PREMIUM				
	<ul style="list-style-type: none"> • spout height: 10.88 • LED escutcheon for filter life indication • compatible with F9800 + 262578: sold separately • compatible with carbon filtration systems 	1.5 GPM (5.7 L/min) max.			
		S5535	403.90	Chrome	3
		S5535SRS●	504.90	Spot Resist Stainless	3
		S5535BL	525.10	Matte Black	3
		S5535NL	545.30	Polished Nickel	3
	 DURALAST®				
TRANSITIONAL	CARBON FILTRATION COMPATIBLE FAUCETS - PREMIUM				
	<ul style="list-style-type: none"> • spout height: 10.88 • LED escutcheon for filter life indication • compatible with F9800 + 262578: sold separately • compatible with carbon filtration systems 	1.5 GPM (5.7 L/min) max.			
		S5520	432.85	Chrome	3
		S5520SRS●	541.05	Spot Resist Stainless	3
		S5520BL	562.75	Matte Black	3
		S5520ORB	606.00	Oil Rubbed Bronze	3
		S5520BLS●	627.65	Black Stainless	3
		S5520BG	627.65	Brushed Gold	3
	 DURALAST®				

Water Filtration Systems & Faucets

KITCHEN

Under Sink Water Filtration Systems

- 4-Stage Reverse Osmosis System
- Single Stage Advanced Carbon System
- ChoiceFlo® Carbon System



Under Sink Replacement Filters

- Reverse Osmosis Replacement Filters
- Water Filtration Replacement Filters







Under Sink Water Filtration Systems & Replacement Filters

Moen is continuing to enhance the experiences you have in the home with new, comprehensive water filtration solutions that allow you to enjoy every sip right from your kitchen sink. Moen® water filtration products can remove potentially harmful contaminants from your tap water and are better for the environment by helping to reduce plastic waste.



		MODEL	LIST	FINISH/CONNECT	CASE QTY
MOEN®	4-STAGE UNDER SINK REVERSE OSMOSIS ADVANCED WATER FILTRATION SYSTEM				
	<ul style="list-style-type: none"> • provides best quality water by reducing contaminants • 1:1 ratio with high recovery reverse osmosis membrane • includes 3.2 gallon storage tank • compatible with F7620, F7660, and F7600 SIP drinking faucets 	F9900	539.95	N/A or Unfinished	1
MOEN®	SINGLE STAGE UNDER SINK ADVANCED WATER FILTRATION SYSTEM				
	<ul style="list-style-type: none"> • filter F9820: included • application: undercounter system • wet change filter replacement notification: yes • battery: included • use with: F7660, F7600 or F7620 series SIP™ drinking water faucets • adapter kit 262578 available to use with: S5510, S5520, S5530, S5540, S5535 and S5560 series SIP dring water faucets 	F9800	230.00	N/A or Unfinished	2
MOEN®	REVERSE OSMOSIS SEDIMENT STAGE 1 WATER FILTER REPLACEMENT				
	<ul style="list-style-type: none"> • stage 1 of the 4 Stage Reverse Osmosis Water Filtration System • removes larger sediments, minerals, and contaminants • 6 month filter life 	F9910	68.95	N/A or Unfinished	12







Water Filtration Systems & Faucets

		MODEL	LIST	FINISH/CONNECT	CASE QTY
MOEN®	REVERSE OSMOSIS CARBON BLOCK PRE-MEMBRANE STAGE 2 WATER FILTER REPLACEMENT				
	<ul style="list-style-type: none"> • stage 2 of the 4 Stage Reverse Osmosis Water Filtration System • removes larger sediments, minerals, and contaminants • 6 month filter life 	F9920	68.95	N/A or Unfinished	12
MOEN®	REVERSE OSMOSIS MEMBRANE STAGE 3 WATER FILTER REPLACEMENT				
	<ul style="list-style-type: none"> • stage 3 of the 4 stage Reverse Osmosis Water Filtration System • removes larger sediments, minerals, and contaminants • 12 month filter life 	F9930	159.95	N/A or Unfinished	12
MOEN®	REVERSE OSMOSIS CARBON BLOCK POST MEMBRANE STAGE 4 WATER FILTER REPLACEMENT				
	<ul style="list-style-type: none"> • stage 4 of the 4 Stage Reverse Osmosis Water Filtration System • removes larger sediments, minerals, and contaminants • 6 month filter life 	F9940	79.95	N/A or Unfinished	12
MOEN®	SINGLE-STAGE ADVANCED WATER FILTER REPLACEMENT				
	<ul style="list-style-type: none"> • 12 month filter life • 845 gallon capacity • improves water color, taste, and smell • works with F9800 Advanced Carbon Water Filtration System 	F9820	115.00	N/A or Unfinished	12
MOEN®	SINGLE-STAGE STANDARD WATER FILTER REPLACEMENT				
	<ul style="list-style-type: none"> • 6 month filter life • 500 gallon capacity • improves water color, taste, and smell • works with F9800 Advanced Carbon Water Filtration System 	F9810	80.00	N/A or Unfinished	12
MOEN®	FILTRATION SUMP REPLACEMENT				
	<ul style="list-style-type: none"> • replacement sump for F9800 • sump to be replaced between 3-5 years 	F9805	120.00	N/A or Unfinished	6

KITCHEN

Water Filtration Parts and Add-Ons

KITCHEN

		MODEL	LIST	FINISH/CONNECT	CASE QTY
MOEN® CHOICEFLO® CARBON WATER FILTRATION REPLACEMENT FILTERS					
	<ul style="list-style-type: none"> includes: replacement battery use with: SIP faucets, Choiceflo and Aquasuite series 	9601	68.40	N/A or Unfinished	18
	<ul style="list-style-type: none"> includes: replacement battery use with: Choiceflo and Aquasuite series 	9501	51.35	N/A or Unfinished	18
TRADITIONAL 3-IN-1 WATER FILTRATION PULLDOWN RETRO FIT WAND KIT					
	<ul style="list-style-type: none"> 3-function wand offers: unfiltered aerated stream, unfiltered PowerClean spray or filtered laminar stream style coordinates with any traditional Moen pull-down faucets Includes: pull-down wand and hose simple DIY installation hose length: 68" 	F26610SRS●	144.95	Spot Resist Stainless	6
MODERN 3-IN-1 WATER FILTRATION PULLDOWN RETRO FIT WAND KIT					
	<ul style="list-style-type: none"> 3-function wand offers: unfiltered aerated stream, unfiltered PowerClean spray or filtered laminar stream style coordinates with any traditional Moen pull-down faucets Includes: pull-down wand and hose simple DIY installation hose length: 68" 	F26660SRS●	144.95	Spot Resist Stainless	6
		F26660BL	150.75	Matte Black	6
TRANSITIONAL 3-IN-1 WATER FILTRATION PULLDOWN RETRO FIT WAND KIT					
	<ul style="list-style-type: none"> 3-function wand offers: unfiltered aerated stream, unfiltered PowerClean spray or filtered laminar stream style coordinates with any traditional Moen pull-down faucets Includes: pull-down wand and hose simple DIY installation hose length: 68" 	F26620	115.95	Chrome	6
		F26620SRS●	144.95	Spot Resist Stainless	6
		F26620BL	150.75	Matte Black	6
MOEN® SIP ADAPTER KIT					
	<ul style="list-style-type: none"> adapter kit for use with F9800 compatible with S5510, S5520, S5530, S5535, S5540, S5560 	262578	22.00	N/A or Unfinished	

Premium Soap Dispensers



- Modern**
- Paterson™**
- Traditional**
- Transitional**

Premium Soap Dispensers

Accessorize your kitchen with stylish soap dispensers from Moen®. They are available in coordinating styles for every decorating taste: traditional, transitional or modern. All come with tops that lift off for easy refill.











KITCHEN

		MODEL	LIST	FINISH/CONNECT	CASE QTY
MODERN	SOAP DISPENSER - PREMIUM				
	<ul style="list-style-type: none"> • spout height: 5.00" • spout reach: 3.50" • max deck thickness: 3-1/2" • bottle size: 18 ounce refillable bottle • hole diameter: 1-1/8" hole 	S3947C	208.10	Chrome	6
		S3947SRS●	260.10	Spot Resist Stainless	6
		S3947BL	270.50	Matte Black	6
		S3947BLS●	301.70	Black Stainless	6
		S3947BG	301.70	Brushed Gold	6
		♿			
PATERSON™	SOAP DISPENSER - PREMIUM				
	<ul style="list-style-type: none"> • spout height: 5.00" • spout reach: 3.50" • max deck thickness: 3-1/2" • bottle size: 18 ounce refillable bottle • hole diameter: 1-1/8" hole 	S3955C	208.10	Chrome	6
		S3955SRS●	260.10	Spot Resist Stainless	6
		S3955BL	270.50	Matte Black	6
		♿			
TRADITIONAL	SOAP DISPENSER - PREMIUM				
	<ul style="list-style-type: none"> • spout height: 5.00" • spout reach: 3.50" • max deck thickness: 3-1/2" • bottle size: 18 ounce refillable bottle • hole diameter: 1-1/8" hole 	S3945C	208.10	Chrome	6
		S3945SRS●	260.10	Spot Resist Stainless	6
		S3945BL	270.50	Matte Black	6
		S3945NL	280.90	Polished Nickel	6
		S3945ORB	291.30	Oil Rubbed Bronze	6
		S3945BG	301.70	Brushed Gold	6
		Q2 NEW! S3945BZG	295.80	Bronzed Gold	6
		♿			

Premium Soap Dispensers

KITCHEN

		MODEL	LIST	FINISH/CONNECT	CASE QTY
TRANSITIONAL SOAP DISPENSER - PREMIUM					
 <ul style="list-style-type: none"> • spout height: 5.00" • spout reach: 3.50" • max deck thickness: 3-1/2" • bottle size: 18 ounce refillable bottle • hole diameter: 1-1/8" hole 		S3946C	208.10	Chrome	6
		S3946SRS●	260.10	Spot Resist Stainless	6
		S3946BL	270.50	Matte Black	6
		S3946NL	280.90	Polished Nickel	6
		S3946ORB	291.30	Oil Rubbed Bronze	6
		S3946BLS●	301.70	Black Stainless	6
	S3946BG	301.70	Brushed Gold	6	
					
 <ul style="list-style-type: none"> • spout height: 5.00" • spout reach: 3.50" • max deck thickness: 3-1/2" • bottle size: 18 ounce refillable bottle • hole diameter: 1-1/8" hole 		S3948C	208.10	Chrome	6
		S3948SRS●	260.10	Spot Resist Stainless	6
		S3948BL	270.50	Matte Black	6
		S3948ORB	291.30	Oil Rubbed Bronze	6
					
MOEN® SOAP DISPENSER					
 <ul style="list-style-type: none"> • spout height: 3.13" • spout reach: 2.75" • max deck thickness: 2-1/4" • bottle size: 18 ounce refillable bottle • hole diameter: 1-1/8" hole 		3942	63.70	Chrome	6
		3942SRS●	79.60	Spot Resist Stainless	6
		3942BL	82.80	Matte Black	6
					
 <ul style="list-style-type: none"> • spout height: 2.56" • spout reach: 3.63" • max deck thickness: 2-1/4" • bottle size: 18 ounce refillable bottle • hole diameter: 1-1/8" hole 		3944	62.50	Chrome	6
		3944SRS●	81.25	Spot Resist Stainless	6
		3944BL	84.35	Matte Black	6
	3944ORB	87.45	Oil Rubbed Bronze	6	
					

Kitchen Accessories

		MODEL	LIST	FINISH/CONNECT	CASE QTY
	MOEN® AIR GAP <ul style="list-style-type: none"> • application: one hole • hole diameter: 1-3/8" 	105895	31.40	Chrome	6
		105895SRS●	43.35	Spot Resist Stainless	6
		105895BL	43.00	Matte Black	6
		105895NL	41.90	Polished Nickel	6
		105895ORB	45.30	Oil Rubbed Bronze	6
		105895BLS●	44.20	Black Stainless	6
		105895BG	42.45	Brushed Gold	6

		MODEL	LIST	FINISH/CONNECT	CASE QTY
	MOEN® PULLOUT/PULLDOWN HOSE MANAGEMENT SYSTEM <ul style="list-style-type: none"> • system: helps prevent hose/weight getting caught under sink • size: can be cut to accommodate different cabinet sizes • compatible with: Moen kitchen pulldowns and pullout single mount skus (excluding Aberdeen™) 	159060	22.65	N/A or Unfinished	6

		MODEL	LIST	FINISH/CONNECT	CASE QTY
	MOEN® WALL MOUNT & HOSE EXTENSION KIT <ul style="list-style-type: none"> • use with Smart Faucets with Motion Control and faucets with MotionSense Wave • contains: pulldownconnection hose bracket, hose guide nut, mounting bracket and screws 	199785	59.75	N/A or Unfinished	6

		MODEL	LIST	FINISH/CONNECT	CASE QTY
	MOEN® AC ADAPTER KIT <ul style="list-style-type: none"> • use with Smart Faucets and faucets with MotionSense Wave • contains: AC adapter, power splitter, hook & loop fasteners and mounting screw 	169031	159.30	N/A or Unfinished	12

		MODEL	LIST	FINISH/CONNECT	CASE QTY
	MOEN® WALL MOUNT & HOSE EXTENSION KIT <ul style="list-style-type: none"> • use with faucets with MotionSense Wave • contains: pulldownconnection hose bracket, hose guide nut, mounting bracket and screws 	177566	49.05	N/A or Unfinished	6





Kitchen Sinks

No matter your style or how you use your kitchen, Moen® has the ideal sink for you. Creating the perfect kitchen starts with understanding how you enjoy it best. Enhance efficiency or showcase stunning design with a sink that forms the ideal foundation for your space. It's never been easier to find a sink that's the perfect fit.

Whether your lifestyle is busy or relaxed, casual or refined, Moen's new sink portfolio caters to your kitchen routines to create a space that embodies your personal passions and design taste.

Luxe Chef® Workstation Sink | GS181020BUX

Kitchen Sinks

COLLECTIONS

- 116 Luxe Chef™
- 120 Host™
- 124 Prep™
- 130 Accessories

MATERIALS

- Black
- White
- Stainless

SoundSHIELD™

All Moen stainless steel sinks feature SoundSHIELD, a sound-deadening system that offers exceptional noise reduction and quiet dependability.

ICON KEY

Dimensions noted are nominal. Use template provided with sink for cut-out dimensions.

Full scale DXF files can be downloaded for computer-controlled cutting equipment by visiting MoenPro.com.

Sinks sold in single quantity pack except where noted.

*ADA/FHA Compliant

Sink compliant to ADA (ICC A117.1) and FHA accessibility specifications when installed to these required standards. See specific product specification sheet for details.

**FHA Compliant

Sink compliant to FHA accessibility specifications when installed to these required standards. See specific product specification sheet for details.

Drains and accessories sold separately.
See pages 130-133



Also available in bulk pack.
See page 597.



Sink Selection Guide



The Following Guidelines Will Assist You When Selecting Sinks

Category	Material/Sink	Gauge	Apron Front		Installation/Mount			Features		
			Undermount	Dualmount	Undermount	Dualmount	Drop-In	Bowl Depth	SoundSHIELD	Warranty
Luxe Chef	Stainless Workstation System	16			•			10"	•	Lifetime
Luxe Chef	Stainless Workstation	18	•		•			Up to 10"	•	Lifetime
Host	Fireclay	N/A	•					10"		Lifetime
Host	Granite	N/A			•	•		Up to 9½"		Lifetime
Prep	Stainless	16			•			10"	•	Lifetime
Prep	Stainless	18	•	•	•	•	•	Up to 10"	•	Lifetime
Prep	Stainless	20			•		•	Up to 7"		Lifetime

SKU Number Guide — Example SKU Number: GS181020BUX

Sink	Material	Granite Finish	Accessory	Gauge	# of Bowls	Random #	# of Holes	Drain Size and Placement Combination
G	FC Fireclay	B Black	A Accessory	16 Gauge	1 Single	XX	0 None	- 3.5" Drain Size
S	Stainless	W White		18 Gauge	2 Double		1 Hole	2 2" Drain Size
G	Granite			20 Gauge	4 Bar/Prep		2 Holes	- Center Drain Position
							3 Holes	B Rear Drain Position
							4 Holes	L Left Rear Drain Position
								R Right Rear Drain Position
								UX Enhanced Workflow

Luxe Chef™

Unlock Your Inner Chef with Culinary Inspired Products for Your Kitchen

Passionate about culinary experiences, you invest in high performance products that elevate your meal preparation and blend convenience, excitement, and efficiency into your cooking routines. You find joy in experimenting with new recipes and need a kitchen sink that provides innovative features that streamline your prep and free up space to unleash your creative potential in the kitchen. The kitchen is the heart of your home.



Workstation System Sinks





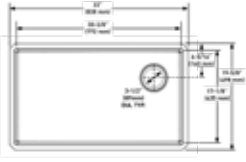
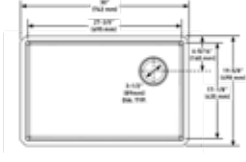
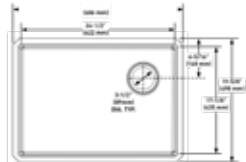

The workstation system sink has premium accessories and innovative features to utilize when creating flavorful dishes. The kitchen sink's new space-saving design includes an exclusive under-sink pullout storage bin to keep accessories organized—enhancing your kitchen's functionality and aesthetic appeal while reinventing your culinary experience.

Workstation Sinks



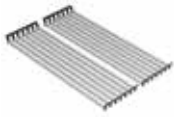

The workstation sinks include high-quality accessories, comprising of a cutting board, colander, flexible drying rack and much more, so you can enjoy a multi-functional workspace to transition between jobs seamlessly.

		MODEL	MATERIAL	LIST	
16 GAUGE MINIMUM CABINET SIZE 36" WORKSTATION SYSTEM					
NEW Q2	<ul style="list-style-type: none"> undermount single bowl overall dimensions: 33" x 19⁵/₈" x 10" features SoundSHIELD™ for noise reduction and quiet dependability corner radius 15 mm drain location: rear right included accessories: pullout storage bin, sink grid, drain assembly and basket strainer 		GS161400R	stainless steel	1013.85
16 GAUGE MINIMUM CABINET SIZE 33" WORKSTATION SYSTEM					
NEW Q2	<ul style="list-style-type: none"> undermount single bowl overall dimensions: 30" x 19⁵/₈" x 10" features SoundSHIELD™ for noise reduction and quiet dependability corner radius 15 mm drain location: rear right included accessories: pullout storage bin, sink grid, drain assembly and basket strainer 		GS161500R	stainless steel	921.55
16 GAUGE MINIMUM CABINET SIZE 30" WORKSTATION SYSTEM					
NEW Q2	<ul style="list-style-type: none"> undermount single bowl overall dimensions: 27" x 19⁵/₈" x 10" features SoundSHIELD™ for noise reduction and quiet dependability corner radius 15mm drain location: rear right included accessories: pullout storage bin, sink grid, drain assembly and basket strainer 		GS161600R	stainless steel	860.00

LUXE CHEF

		MODEL	LIST	MATERIAL	CASE QTY
WORKSTATION SYSTEM ACCESSORIES WHITE OAK CUTTING BOARD					
NEW! Q2	 <ul style="list-style-type: none"> • 13-1/5" x 17" • almost impervious to water • Regular application of food-safe mineral oil recommended • for use with workstation system sinks GS161400R, GS161500R or GS161600R • 1 year warranty 	GA776	199.95	white oak	10
WORKSTATION SYSTEM ACCESSORIES ACACIA CUTTING BOARD					
NEW! Q2	 <ul style="list-style-type: none"> • 13-1/5" x 17" • resistant to moisture • Regular application of food-safe mineral oil recommended • for use with workstation system sinks GS161400R, GS161500R or GS161600R • 1 year warranty 	GA781	199.95	acacia	10
WORKSTATION SYSTEM ACCESSORIES ACCESSORY BUNDLE					
NEW! Q2	 <ul style="list-style-type: none"> • includes: 2 prep bins with lids, utensil bin, colander, and 2 drying racks • durable and easy to clean • for use with workstation sinks GS161400R, GS161500R or GS161600R • 1 year warranty 	GA779	526.65	stainless steel	10
WORKSTATION SYSTEM ACCESSORIES DRYING RACK					
NEW! Q2	 <ul style="list-style-type: none"> • air-dry dishes and utensils • offers versatility including two racks • durable and easy to clean • for use with workstation system sinks GS161400R, GS161500R or GS161600R • 1 year warranty 	215812	92.00	stainless steel	6
WORKSTATION SYSTEM ACCESSORIES UTENSIL BIN					
NEW! Q2	 <ul style="list-style-type: none"> • open design allows water to drain off quickly into sink • 2 divided compartments • durable and easy to clean • for use with workstation system sinks GS161400R, GS161500R or GS161600R • 1 year warranty 	215817	158.70	stainless steel	8
WORKSTATION SYSTEM ACCESSORIES COLANDER					
NEW! Q2	 <ul style="list-style-type: none"> • wash fruit, vegetables, and many other functions including draining pasta and more • durable and easy to clean • for use with workstation system sinks GS161400R, GS161500R or GS161600R • 1 year warranty 	215810	158.70	stainless steel	6
WORKSTATION SYSTEM ACCESSORIES PREP BINS					
NEW! Q2	 <ul style="list-style-type: none"> • 2 prep bins with lids • quick access to garnishes and toppings in your prep area • durable and easy to clean • for use with workstation system sinks GS161400R, GS161500R or GS161600R • 1 year warranty 	215819	212.00	stainless steel	8

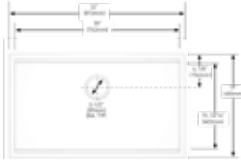
LUXE CHEF

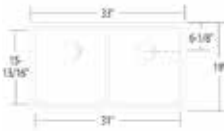
18 GAUGE MINIMUM CABINET SIZE 36" WORKSTATION WITH ACCESSORIES		MODEL	MATERIAL	LIST	
	<ul style="list-style-type: none"> • apron front • undermount single bowl • overall dimensions: 33" x 22" x 9" • features SoundSHIELD™ for noise reduction and quiet dependability • corner radius 00 mm • drain location: rear center • included accessories: hardwood cutting board, sink grid, basket strainer/drain assembly, flexible drying rack, and colander 		GS181050BUX	stainless steel	1425.00
	<ul style="list-style-type: none"> • undermount single bowl • overall dimensions: 32" x 19" x 10" • features SoundSHIELD™ for noise reduction and quiet dependability • corner radius 00 mm • drain location: rear center • included accessories: hardwood cutting board, sink grid, basket strainer/drain assembly, flexible drying rack, and colander 		GS181020BUX	stainless steel	1075.00
	<ul style="list-style-type: none"> • undermount single bowl • overall dimensions: 33" x 19" x 10" • features SoundSHIELD™ for noise reduction and quiet dependability • corner radius 00 mm • drain location: rear center • included accessories: hardwood cutting board, sink grid, basket strainer/drain assembly, flexible drying rack, and colander 		GS182040BUX	stainless steel	1350.00

Host™

Natural Beauty Added to Your Kitchen

As an enthusiastic entertainer, your kitchen is a hub for hosting festive gatherings and dinner parties. Whether crafting cocktails or curating elaborate meals, a new aesthetically pleasing and functional kitchen is vital for creating memorable moments for you and your guests. Style is key in your decision-making process, and you're open to making a statement with modern designs like apron front fireclay sinks—the kitchen design reflects your personality.











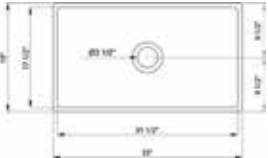

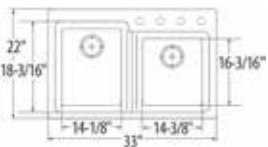

Fireclay Sinks

These sinks are made with 100% eco-friendly, lead-free fireclay making them chip-stain and heat-resistant. The included bottom sink rack and added stainless grid coordinate with today's popular kitchen appliances while protecting your sink from tough tasks. The thick, durable material reduces sound.

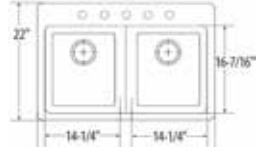

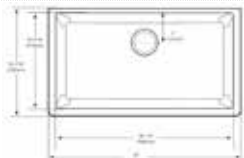
Granite Sinks

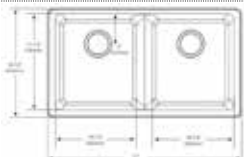
These sinks have a timeless elegance and are made with eco-friendly, natural materials. The deep bowl can hold many dishes—even large pots, pans, and baking sheets. These are available in various platforms and finishes to match the style that's right for your kitchen.

		MODEL	MATERIAL	LIST	
FIRECLAY MINIMUM CABINET SIZE 36"					
	<ul style="list-style-type: none"> • apron front • undermount single bowl • overall dimensions: 33" x 19" x 10" • drain location: center • included accessories: sink grid, drain assembly, and basket strainer 		FC331910	white	970.90
FIRECLAY MINIMUM CABINET SIZE 33"					
	<ul style="list-style-type: none"> • apron front • undermount single bowl • overall dimensions: 30" x 18" x 10" • drain location: center • included accessories: sink grid, drain assembly, and basket strainer 		FC301810	white	895.30
GRANITE MINIMUM CABINET SIZE 36"					
	<ul style="list-style-type: none"> • dual mount single bowl • overall dimensions: 33" x 20⁷/₈" x 9¹/₂" • drain location: rear center 		GGB3026B	black	703.50
			GGW3026B	white	703.50
			FEATURED ACCESSORY <i>sold separately</i>		
			GGA52B	sink grid	194.35
	<ul style="list-style-type: none"> • dual mount double bowl • overall dimensions: 33" x 22" x 9¹/₂" • drain location: rear center 		GGB3024B	black	878.15
			GGW3024B	white	878.15
	<ul style="list-style-type: none"> • dual mount double bowl • overall dimensions: 33" x 22" x 9¹/₂" • drain location: rear center 		GGB3028B	black	641.10
			GGW3028B	white	641.10
			FEATURED ACCESSORY <i>sold separately</i>		
			GGA55B	sink grid	153.95
	<ul style="list-style-type: none"> • undermount single bowl • overall dimensions: 33" x 18³/₈" x 9¹/₁₆" • drain location: rear center 		GGB4010B	black	662.40
			GGW4010B	white	662.40
			FEATURED ACCESSORY <i>sold separately</i>		
			GGA52B	sink grid	194.35
	<ul style="list-style-type: none"> • undermount double bowl • overall dimensions: 33" x 18¹/₂" x 9¹/₂" • drain location: rear center 		GGB4012B	black	645.25
			GGW4012B	white	645.25

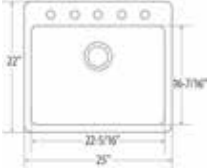

HOST

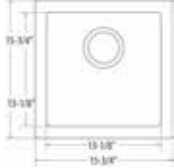
		MODEL	MATERIAL	LIST
GRANITE MINIMUM CABINET SIZE 30"				
 <ul style="list-style-type: none"> • dual mount single bowl • overall dimensions: 25" x 22" x 9 1/2" • drain location: rear center 		GGB3019B	black	521.70
		GGW3019B	white	521.70
		<i>FEATURED ACCESSORY sold separately</i>		
		GGA51B	sink grid	178.75
GRANITE MINIMUM CABINET SIZE 21"				
 <ul style="list-style-type: none"> • dual mount single bowl • overall dimensions: 15 3/4" x 15 3/4" x 7-11/16" • drain location: rear center 		GGB3018B	black	382.65
		GGW3018B	white	382.65
		<i>FEATURED ACCESSORY sold separately</i>		
		GGA51B	sink grid	178.75

SINKS



PREP

Prep™









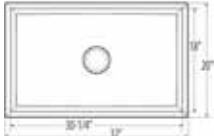

The Perfect Sink for a Busy Lifestyle

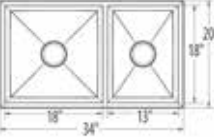
As someone who prepares light meals and leads an active lifestyle, you seek the essentials that establish a solid foundation. Your kitchen design is rooted in durability, cleanliness and organization, reflecting your commitment to practicality and streamlined functionality. Embracing these core principles, you create a space that effortlessly supports how you live in your kitchen and complements your on-the-go lifestyle.

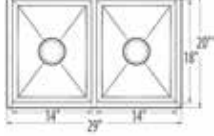

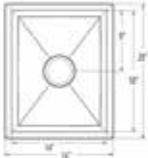

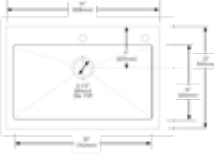

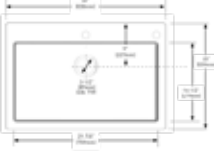



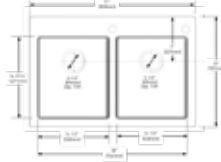

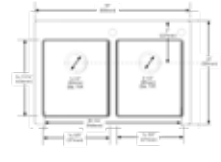

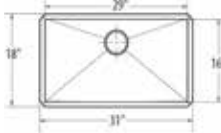
Stainless Steel Sinks

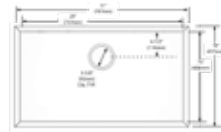

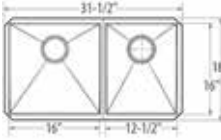

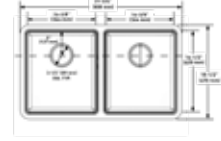

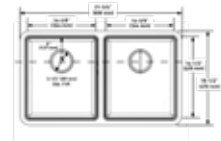

Stainless steel sinks are easy to clean and maintain. SoundSHIELD™ technology is an undercoating that comes standard stainless steel sinks to reduce vibration and noise that is caused by running water and the clanging dishes, providing a much quieter experience when working at the sink. Select 18-gauge and 20-gauge stainless steel sinks are now ADA-compliant. Single bowl designs make washing large pots and pans simple.

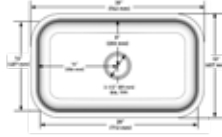
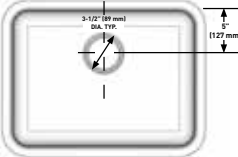
		MODEL	MATERIAL	LIST	
16 GAUGE MINIMUM CABINET SIZE 36"					
	<ul style="list-style-type: none"> • undermount single bowl • overall dimensions: 32" x 20" x 10" • features SoundSHIELD™ for noise reduction and quiet dependability • corner radius: 0 mm • drain location: center 		G16100	stainless steel	841.30
			FEATURED ACCESSORY <i>sold separately</i>		
			GA760	sink grid	194.50
16 GAUGE MINIMUM CABINET SIZE 34"					
	<ul style="list-style-type: none"> • undermount double bowl • overall dimensions: 34" x 20" x 10" • features SoundSHIELD™ for noise reduction and quiet dependability • corner radius: 0 mm • drain location: center 		G16221	stainless steel	862.90
			FEATURED ACCESSORY <i>sold separately</i>		
			GA768	sink grid	169.70
16 GAUGE MINIMUM CABINET SIZE 31"					
	<ul style="list-style-type: none"> • undermount double bowl • overall dimensions: 31" x 20" x 10" • features SoundSHIELD™ for noise reduction and quiet dependability • corner radius: 0 mm • drain location: center 		G16200	stainless steel	819.70
			FEATURED ACCESSORY <i>sold separately</i>		
			GA763	sink grid	143.75
16 GAUGE MINIMUM CABINET SIZE 24"					
	<ul style="list-style-type: none"> • undermount single bowl • overall dimensions: 16" x 20" x 10" • features SoundSHIELD™ for noise reduction and quiet dependability • corner radius: 0 mm • drain location: center 		G16430	stainless steel	517.30
			FEATURED ACCESSORY <i>sold separately</i>		
			GA763	sink grid	143.75
18 GAUGE MINIMUM CABINET SIZE 36"					
	<ul style="list-style-type: none"> • apron front • dual mount single bowl • overall dimensions: 33" x 22" x 9" • features SoundSHIELD™ for noise reduction and quiet dependability • corner radius: 15 mm • drain location: rear center • included accessories: sink grid, drain assembly, and basket strainer 		GS181092B	stainless steel	975.00
18 GAUGE MINIMUM CABINET SIZE 33"					
	<ul style="list-style-type: none"> • dual mount single bowl • overall dimensions: 33" x 22" x 9" • features SoundSHIELD™ for noise reduction and quiet dependability • corner radius: 15 mm • drain location: rear center • included accessories: sink grid, drain assembly, and basket strainer 		GS181062B	stainless steel	750.00

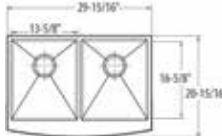
PREP

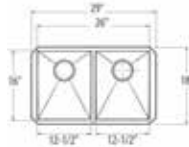

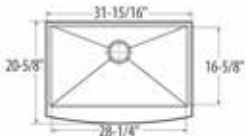

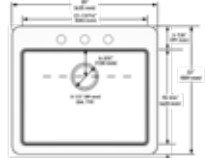
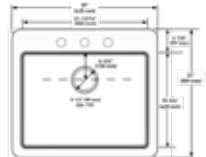
18 GAUGE MINIMUM CABINET SIZE 36"				MODEL	MATERIAL	LIST
	<ul style="list-style-type: none"> dual mount double bowl overall dimensions: 33" x 22" x 9" features low divide to make washing large items easier features SoundSHIELD™ for noise reduction and quiet dependability corner radius: 15 mm drain location: rear center included accessories: 2 sink grids, drain assemblies, and basket strainers 		GS182082B	stainless steel	850.00	
	<ul style="list-style-type: none"> dual mount double bowl overall dimensions: 33" x 22" x 9" features SoundSHIELD™ for noise reduction and quiet dependability corner radius: 15 mm drain location: rear center included accessories: 2 sink grids, drain assemblies, and basket strainers 		GS182072B	stainless steel	750.00	
	<ul style="list-style-type: none"> undermount single bowl overall dimensions: 31" x 18" x 8 1/2" features SoundSHIELD™ for noise reduction and quiet dependability corner radius: 0 mm drain location: rear center 		G18180	stainless steel	571.50	
			FEATURED ACCESSORY <i>sold separately</i>			
			GA780B	sink grid	190.05	
	<ul style="list-style-type: none"> overall dimensions: 31" x 18" x 6" features SoundSHIELD™ for noise reduction and quiet dependability corner radius: 0 mm drain location: rear center available in bulk: BGS181210B ADA/FHA compliant and FHA compliant 		GS181210B	stainless steel	514.35	
			FEATURED ACCESSORY <i>sold separately</i>			
			GA780B	sink grid	190.05	
	<ul style="list-style-type: none"> undermount double bowl overall dimensions: 31 1/2" x 18" x 8 1/2" features SoundSHIELD™ for noise reduction and quiet dependability corner radius: 0 mm drain location: rear center 		G18287	stainless steel	571.50	
			FEATURED ACCESSORY <i>sold separately</i>			
			GA782B	sink grid	143.75	
			GA785B	sink grid	156.90	
	<ul style="list-style-type: none"> undermount double bowl overall dimensions: 31 13/16" x 18 1/2" x 9" features SoundSHIELD™ for noise reduction and quiet dependability corner radius: 20 mm drain location: rear center 		GS18259B	stainless steel	785.00	
	<ul style="list-style-type: none"> undermount double bowl overall dimensions: 31 4/5" x 18 1/2" x 5 1/2" features SoundSHIELD™ for noise reduction and quiet dependability corner radius: 20 mm drain location: rear center ADA/FHA compliant and FHA compliant 		GS18260B	stainless steel	525.00	

SINKS







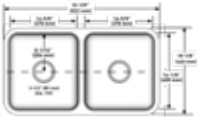

18 GAUGE MINIMUM CABINET SIZE 33"		MODEL	MATERIAL	LIST	
	<ul style="list-style-type: none"> undermount single bowl overall dimensions: 30" x 18" x 10" features SoundSHIELD™ for noise reduction and quiet dependability corner radius: 100 mm drain location: center 		GS18155	stainless steel	921.00
ADA/FHA COMPLIANT	<ul style="list-style-type: none"> undermount single bowl overall dimensions: 30" x 18" x 5 1/2" features SoundSHIELD™ for noise reduction and quiet dependability corner radius: 100 mm drain location: center rear ADA/FHA compliant and FHA compliant 		GS18156B	stainless steel	709.05
	<ul style="list-style-type: none"> apron front undermount double bowl overall dimensions: 30" x 20 5/8" x 9" features SoundSHIELD™ for noise reduction and quiet dependability corner radius: 0 mm drain location: center rear 		G18220	stainless steel	1036.20
			<i>FEATURED ACCESSORY sold separately</i>		
			GA772	sink grid	143.20
	<ul style="list-style-type: none"> undermount double bowl overall dimensions: 19" x 18" x 8 1/2" features SoundSHIELD™ for noise reduction and quiet dependability corner radius: 0 mm drain location: rear center 		G18288	stainless steel	646.90
			<i>FEATURED ACCESSORY sold separately</i>		
			GA782B	sink grid	143.75
18 GAUGE MINIMUM CABINET SIZE 30"					
	<ul style="list-style-type: none"> apron front single bowl overall dimensions: 30" x 21" x 9" features SoundSHIELD™ for noise reduction and quiet dependability corner radius: 0 mm drain location: center rear 		G18121	stainless steel	884.50
			<i>FEATURED ACCESSORY sold separately</i>		
			GA771	sink grid	186.90
	<ul style="list-style-type: none"> drop-in single bowl overall dimensions: 25" x 22" x 8" features SoundSHIELD™ for noise reduction and quiet dependability corner radius: 20 mm drain location: rear center 3-hole sink deck 		GS181723B	stainless steel	656.60
ADA/FHA COMPLIANT	<ul style="list-style-type: none"> drop-in single bowl overall dimensions: 25" x 22" x 5 1/2" features SoundSHIELD™ for noise reduction and quiet dependability corner radius: 20 mm drain location: rear center 3-hole sink deck ADA/FHA compliant and FHA compliant 		GS181733B	stainless steel	599.90

SINKS

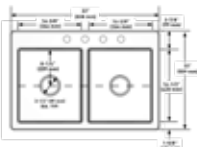
PREP

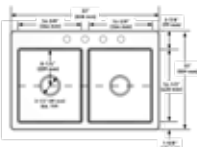
		MODEL	MATERIAL	LIST
18 GAUGE MINIMUM CABINET SIZE 27"				
	<ul style="list-style-type: none"> • undermount single bowl • overall dimensions: 22" x 18" x 8 1/2" • features SoundSHIELD™ for noise reduction and quiet dependability • corner radius: 0 mm • drain location: rear center 	G18185	stainless steel	442.80
		<i>FEATURED ACCESSORY sold separately</i>		
		GA781B	sink grid	169.70
<hr/>				
	<ul style="list-style-type: none"> • undermount single bowl • overall dimensions: 23" x 17 7/8" x 9" • features SoundSHIELD™ for noise reduction and quiet dependability • corner radius: 50 mm • drain location: center 	GS18157	stainless steel	492.15
<hr/>				
	<p>ADA/FHA COMPLIANT</p> <ul style="list-style-type: none"> • undermount single bowl • overall dimensions: 23" x 17 7/8" x 5 1/2" • features SoundSHIELD™ for noise reduction and quiet dependability • corner radius: 50 mm • drain location: rear center • ADA/FHA compliant and FHA compliant 	GS18158B	stainless steel	349.70
<hr/>				
	<p>ADA/FHA COMPLIANT</p> <ul style="list-style-type: none"> • undermount single bowl • overall dimensions: 22" x 18" x 5 1/2" • features SoundSHIELD™ for noise reduction and quiet dependability • corner radius: 0 mm • drain location: rear center • available in bulk: BGS18186B • ADA/FHA compliant and FHA compliant 	GS18186B	stainless steel	399.60
<hr/>				
18 GAUGE MINIMUM CABINET SIZE 21"				
	<ul style="list-style-type: none"> • undermount single bowl • overall dimensions: 16 1/2" x 18" x 9" • features SoundSHIELD™ for noise reduction and quiet dependability • corner radius: 100 mm • drain location: center 	GS18463	stainless steel	377.60

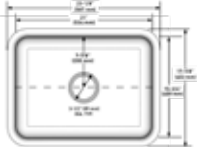
SINKS

20 GAUGE MINIMUM CABINET SIZE 36"		MODEL	MATERIAL	LIST	
	<ul style="list-style-type: none"> • undermount double bowl • overall dimensions: 32½" x 18⅞" x 7" • features SoundSHIELD™ for noise reduction and quiet dependability • corner radius: 50 mm • drain location: center 		GS20264	stainless steel	339.80
ADA/FHA COMPLIANT	<ul style="list-style-type: none"> • undermount double bowl • overall dimensions: 32-3/8" x 18⅞" x 5½" • features SoundSHIELD™ for noise reduction and quiet dependability • corner radius: 50 mm • drain location: rear center • ADA/FHA compliant and FHA compliant 		GS20265B	stainless steel	305.70
	<ul style="list-style-type: none"> • drop-in double bowl • overall dimensions: 33" x 22" x 7" • features SoundSHIELD™ for noise reduction and quiet dependability • corner radius: 20 mm • drain location: center • 3-hole sink deck 		GS202683	stainless steel	385.00
	<ul style="list-style-type: none"> • drop-in double bowl • overall dimensions: 33" x 22" x 7" • features SoundSHIELD™ for noise reduction and quiet dependability • corner radius: 20 mm • drain location: center • 4-hole sink deck 		GS202684	stainless steel	385.00
20 GAUGE MINIMUM CABINET SIZE 27"		MODEL	MATERIAL	LIST	
	<ul style="list-style-type: none"> • undermount single bowl • overall dimensions: 23⅞" x 17⅞" x 7" • features SoundSHIELD™ for noise reduction and quiet dependability • corner radius: 50 mm • drain location: center 		GS20166	stainless steel	260.25
ADA/FHA COMPLIANT	<ul style="list-style-type: none"> • undermount single bowl • overall dimensions: 23⅞" x 17⅞" x 5½" • features SoundSHIELD™ for noise reduction and quiet dependability • corner radius: 50 mm • drain location: rear center • ADA/FHA compliant and FHA compliant 		GS20167B	stainless steel	260.25

SINKS

Kitchen Sink Accessories

Simple. Clean. Hardworking.









Personalize the way you utilize your kitchen sink with Moen's premium accessories. Designed to optimize your space, these accessories elevate functionality with unparalleled efficiency. Experience seamless movement during cooking and cleaning, accompanied by sound minimization, surface protection and enhanced organization. Embracing kitchen sink accessories is the perfect way to complement your culinary space.







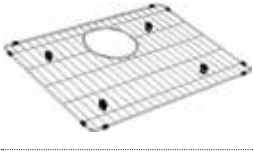
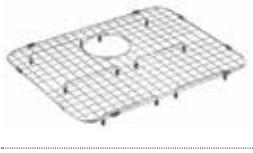



Sink Accessories

Crafted for durability, Moen's sink accessories enhance the overall experience. Sink grids with rear and center drain options organize dishes while protecting the sink from damage. Drop-in-based strainers and hole covers help contain debris; for added convenience, U-channel clamps, extension screws, and the undermount bracket pack are available to streamline installation.

ACCESSORIES

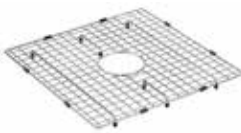
		MODEL	LIST	MATERIAL	CASE QTY
GRANITE SINKS					
	<ul style="list-style-type: none"> • stainless steel construction • rear drain • fits professional bowl size: 13¹/₈" x 13¹/₈" 	GGA50B	140.60	stainless steel	9
	<ul style="list-style-type: none"> • stainless steel construction • rear drain • fits professional bowl size: 13" x 16¹/₂" 	GGA57B	146.45	stainless steel	9
	<ul style="list-style-type: none"> • stainless steel construction • rear drain • fits professional bowl size: 15¹/₈" x 16.25" 	GGA55B	153.95	stainless steel	10
	<ul style="list-style-type: none"> • stainless steel construction • rear drain • fits bowl size: 13.6" x 16.6" 	GA772	143.20	stainless steel	12
	<ul style="list-style-type: none"> • stainless steel construction • rear drain • fits professional bowl size: 12¹/₂" x 16" 	GA782B	143.75	stainless steel	15
	<ul style="list-style-type: none"> • stainless steel construction • rear drain • fits professional bowl size: 16" x 16" 	GA785B	156.90	stainless steel	6
	<ul style="list-style-type: none"> • stainless steel construction • rear drain • fits professional bowl size: 22¹/₂" x 16¹/₂" 	GGA51B	178.75	stainless steel	10
	<ul style="list-style-type: none"> • stainless steel construction • rear drain • fits professional bowl size: 20" x 16" 	GA781B	169.70	stainless steel	8
	<ul style="list-style-type: none"> • stainless steel construction • rear drain • fits professional bowl size: 30¹/₄" x 16¹/₄" 	GGA52B	194.35	stainless steel	9

ACCESSORIES

		MODEL	LIST	MATERIAL	CASE QTY
	<ul style="list-style-type: none"> • stainless steel construction • rear drain • fits bowl size: 28" x 16" 	GA771	186.90	stainless steel	6
	<ul style="list-style-type: none"> • stainless steel construction • rear drain • fits professional bowl size: 29" x 16" 	GA780B	190.05	stainless steel	6
	<ul style="list-style-type: none"> • stainless steel construction • center drain • fits bowl size: 14" x 16" 	GA726	80.90	stainless steel	15
	<ul style="list-style-type: none"> • stainless steel construction • center drain • fits professional bowl size: 13" x 18" 	GA763	143.75	stainless steel	6
	<ul style="list-style-type: none"> • stainless steel construction • center drain • fits bowl size: 14" x 18" 	GA728	109.15	stainless steel	12
	<ul style="list-style-type: none"> • stainless steel construction • center drain • fits bowl size: 18" x 18" center drain 	GA768	169.70	stainless steel	10
	<ul style="list-style-type: none"> • stainless steel construction • center drain • fits bowl size: 21" x 16" 	GA716	115.05	stainless steel	10
	<ul style="list-style-type: none"> • stainless steel construction • center drain • fits bowl size: 29" x 16" 	GA719	166.25	stainless steel	6
	<ul style="list-style-type: none"> • stainless steel construction • center drain • fits professional bowl size: 30" x 18" 	GA760	194.50	stainless steel	3

ACCESSORIES

		MODEL	LIST	MATERIAL	CASE QTY
	<ul style="list-style-type: none"> • drop-in basket strainer with 3 1/2" drain assembly • includes: basket strainer and stopper • fits sinks with standard 3 5/8" outlet • for use with: granite sinks • coordinate drain to match color of Moen granite sinks 	GGA60B	85.55	Black	56
		GGA60W	85.55	White	56
	<ul style="list-style-type: none"> • drop-in basket strainer with 3 1/2" drain assembly • includes: lock nut • fits sinks with standard 3 5/8" outlet 	22036	22.10	stainless steel	24
	<ul style="list-style-type: none"> • drop-in basket strainer with 3 1/2" drain assembly • includes: lock nut • fits sinks with standard 3 5/8" outlet 	22037	19.35	stainless steel	40
	<ul style="list-style-type: none"> • drop-in basket strainer with 2" drain assembly • includes: lock nut • fits sinks with standard 2" outlet 	22174	10.00	N/A or Unfinished	30
	<ul style="list-style-type: none"> • u-channel clamp: 8 pieces 	22684	4.55	N/A or Unfinished	1
		22681	5.50	N/A or Unfinished	1
		22682	6.55	N/A or Unfinished	1
	<ul style="list-style-type: none"> • u-channel 3" extension screw: 1 piece 	22175	5.05	N/A or Unfinished	1000
	<ul style="list-style-type: none"> • undermount bracket pack: 10 pieces 	22650	14.55	N/A or Unfinished	1
	<ul style="list-style-type: none"> • hole cover: 1 1/2" 	22897	1.15	stainless steel	1



Garbage Disposals

Moen® offers a range of garbage disposals tailored to your lifestyle and cooking preferences. Whether you're a passionate cooking enthusiast, a frequent entertainer or prefer quick and easy meals, Moen has the ideal solution. With powerful grinding capabilities for handling various food waste, models that balance power and efficiency for busy kitchens and compact options for conveniently disposing of small scraps, Moen ensures efficient, effortless kitchen cleanup.

Luxe Chef™ EX Series 1 Horsepower Garbage Disposal | EX100c

Garbage Disposals

COLLECTIONS

138 Luxe Chef™ - 1 Horsepower

139 Host™ - ¾ Horsepower

140 Prep™ - ½ Horsepower

141 Lite™ - ⅓ Horsepower

Moen® has made it simple and intuitive for consumers to find the perfect disposal based on how they use their kitchen. From cooking enthusiasts and frequent entertainers to those who rarely cook from scratch, Moen offers garbage disposals with the right amount of grinding power to make kitchen cleanup a breeze.



Universal Xpress Mount™ fits Moen and most existing 3-bolt mounting assemblies



SoundSHIELD™ designed to provide sound deadening insulation



Permanent magnet motor designed to help reduce jamming



High-speed VORTEX™ motor provides fast, powerful grinding



Pre-installed power cord is a savings over other models where cord must be purchased separately



Continuous feed grinds as long as power is on



360 Clean Rinse design eliminates odors



Batch Feed Stopper activates disposal for safer operation. No wall switch required



Easy-Lift Installation System allows for simple, quick connection for enhanced comfort when under the sink

Garbage Disposals Suited Just for You

From the top chef to the take-out enthusiast, Moen offers disposals with the power and features to meet your needs.

Luxe Chef

Designed for those who love to get creative in their kitchen and need the strongest clean up possible.



Host

Designed for those who frequently cook for guests and need advanced cleanup power.



Prep

Designed for those who slice, dice and peel as part of basic meal prep, and need a little more help with cleanup.





Lite

Designed for those who rarely cook from scratch and just want cleanup to be simple.







LUXE CHEF™ Garbage Disposals

		MODEL	LIST	CASE QTY
EXL SERIES				
	<ul style="list-style-type: none"> • engine: 1 horsepower with 2800 RPM • feed: continuous feed • motion sensing technology: light activates when under cabinet door is open with positionable sensor • battery compartment: front facing • dishwasher: connects with 1-1/2" drain outlet • 13 lbs. 16" height • grind component material: stainless steel • turntable assembly: stainless steel • includes: easy open dishwasher inlet; drain stopper; hardwire capable cord; reset button; removable splash guard; pre-installed power cord; light; simple snap tool; drain elbow and mounting assembly • 10 year limited warranty with in-home service 	EXL100c	507.30	2
EX SERIES				
	<ul style="list-style-type: none"> • engine: 1 horsepower with 2500 RPM • feed: continuous feed • Easy-Lift installation system allows for simple, quick connection for enhanced comfort when under the sink • dishwasher: connect with 1-1/2" drain outlet • 9.25 lbs. 13.4" height • grind component material: galvanized steel • turntable assembly: stainless steel • includes: polished stainless steel sink flange; removable splash guard; pre-installed power cord; drain elbow and mounting assembly; drain stopper; hardwire capable cord • sloped dishwasher inlet with 1/4 turn cap for easy removal • 10 year limited warranty with in-home service 	EX100c	415.20	2

GARBAGE DISPOSALS

HOST™ Garbage Disposals

		MODEL	LIST	CASE QTY
EX SERIES				
 	<ul style="list-style-type: none"> • engine: 3/4 horsepower with 2700 RPM • feed: continuous feed • Easy-Lift installation system allows for simple, quick connection for enhanced comfort when under the sink • dishwasher: connect with 1-1/2" drain outlet • 9.25 lbs. 13.4" height • grind component material: galvanized steel • turntable assembly: stainless steel • includes: polished stainless steel sink flange; removable splash guard; pre-installed power cord; drain elbow and mounting assembly; drain stopper; hardwire capable cord • sloped dishwasher inlet with 1/4 turn cap for easy removal • 10 year limited warranty with in-home service 	EX75c	319.35	2
				
GX SERIES				
	<ul style="list-style-type: none"> • engine: 3/4 horsepower with 2700 RPM • feed: batch feed • dishwasher: connect with 1-1/2" drain outlet • 14.1 lbs. 15-5/8" height • grind component material: galvanized steel • turntable assembly: stainless steel • includes: polished stainless steel sink flange; removable splash guard; pre-installed power cord; drain elbow and mounting assembly; drain stopper; hardwire capable cord • 10 year limited warranty with in-home service 	GXB75c	356.85	2
				

GARBAGE DISPOSALS

PREP™ Garbage Disposals

		MODEL	LIST	CASE QTY
GX PRO SERIES				
	<ul style="list-style-type: none"> • engine: 1/2 horsepower with 2600 RPM • feed: continuous feed • Easy-Lift installation system allows for simple, quick connection for enhanced comfort when under the sink • dishwasher: connects with 1-1/2" drain outlet • 7.75 lbs. 13-3/8" height • grind component material: galvanized steel • turntable assembly: stainless steel • includes: drain elbow and mounting assembly; polished stainless steel sink flange; pre-installed power cord; removable splash guard; drain stopper; hardwire capable cord • sloped dishwasher inlet with 1/4 turn cap for easy removal • 5 year limited warranty with in-home service 	GXP50c	148.70	2
				
EX SERIES				
NEW!				
	<ul style="list-style-type: none"> • engine: 1/2 horsepower with 2600 RPM • feed: continuous feed • Easy-Lift installation system allows for simple, quick connection for enhanced comfort when under the sink • dishwasher: connect with 1-1/2" drain outlet • 9.25 lbs. 13.4" height • grind component material: galvanized steel • turntable assembly: stainless steel • includes: polished stainless steel sink flange; removable splash guard; pre-installed power cord; drain elbow and mounting assembly; drain stopper; hardwire capable cord • sloped dishwasher inlet with 1/4 turn cap for easy removal • 5 year limited warranty with in-home service 	EX50c	212.55	2
				
GT SERIES				
	<ul style="list-style-type: none"> • engine: 1/2 horsepower with 2600 RPM • feed: continuous feed • Easy-Lift installation system allows for simple, quick connection for enhanced comfort when under the sink • dishwasher: connects with 1-1/2" drain outlet • 7.75 lbs. 13-3/8" height • grind component material: galvanized steel • turntable assembly: stainless steel • includes: easy open dishwasher inlet; drain elbow and mounting assembly; drain stopper; hardwire capable cord; unjamming wrench; reset button; pre-installed power cord; removable splash guard; simple snap tool • sloped dishwasher inlet with 1/4 turn cap for easy removal • 5 year limited warranty with in-home service 	GT50c	165.15	2
				















Installation Innovation-Fast Track™ enhanced features for faster installation.

Features:

- Simple Snap Tool quickly secures mounting assembly
- Easy Open Dishwasher Inlet. No additional tools required
- Pre-installed power cord is a savings over models where cord must be purchased separately. Cord easily removes for optional hardwiring.

LITE™ Garbage Disposals

		MODEL	LIST	CASE QTY
GX PRO SERIES				
	<ul style="list-style-type: none"> • engine: 1/3 horsepower with 1900 RPM • feed: continuous feed • Easy-Lift installation system allows for simple, quick connection for enhanced comfort when under the sink • dishwasher: connects with 1-1/2" drain outlet • 7.75 lbs. 13-3/8" height • grind component material: galvanized steel • turntable assembly: stainless steel • includes: drain elbow and mounting assembly; stainless steel sink flange; pre-installed power cord; removable splash guard; drain stopper; hardwire capable cord • sloped dishwasher inlet with 1/4 turn cap for easy removal • 5 year limited warranty with in-home service 	GXP33c	126.40	2
		      		

GT SERIES				
	<ul style="list-style-type: none"> • engine: 1/3 horsepower with 1900 RPM • feed: continuous feed • Easy-Lift installation system allows for simple, quick connection for enhanced comfort when under the sink • dishwasher: connects with 1-1/2" drain outlet • 7.75 lbs. 13-3/8" height • grind component material: galvanized steel • turntable assembly: stainless steel • includes: easy open dishwasher inlet; drain elbow and mounting assembly; drain stopper; hardwire capable cord; unjamming wrench; reset button; pre-installed power cord; removable splash guard; simple snap tool; hardwire capable cord • sloped dishwasher inlet with 1/4 turn cap for easy removal • 5 year limited warranty with in-home service 	GT33c	137.25	2
		       		

GARBAGE DISPOSALS

ACCESSORIES Garbage Disposals

		MODEL	LIST	CASE QTY
CONTROLLER BASE UNIT WITH CHROME AND SPOT RESIST STAINLESS SWITCH				
	<p>NEW!</p> <ul style="list-style-type: none"> includes: interchangeable chrome and Spot Resist stainless button finishes air tubing size: 1/8" mounting hole size: 1-3/8" air tube length: 10' compatible with all Moen disposals 1 year limited warranty ideal application for island countertop where electrical switch is unavailable 	ARC-4200-CHSRS	87.60	6
DISPOSAL AIR SWITCH CONTROLLER				
	<ul style="list-style-type: none"> application: one hole air tubing size: 1/8" mounting hole size: 1-3/8" air tube length: 10' compatible with all Moen disposals 1 year limited warranty ideal application for island countertop where electrical switch is unavailable 	ARC-4200	66.75	60
AIR SWITCH				
	<ul style="list-style-type: none"> requires disposal air switch controller ARC-4200 sold separately assortment of finishes available to coordinate with faucets and sinks compatible with all disposals 1 year limited warranty 	AS-4201-CH	22.45	100
		AS-4201-BL	28.05	100
		AS-4201-NL	39.85	100
		NEW! AS-4201-SRS ●	44.85	100
		AS-4201-BRB	33.90	100
		AS-4201-BLS ●	33.90	100
AS-4201-BG	44.85	100		
POLISHED STAINLESS DRAIN STOPPER				
	<ul style="list-style-type: none"> compatible with all Moen disposals & other 3-bolt mounting systems 1 year limited warranty 	1011	17.35	24
PLASTIC DRAIN STOPPER				
	<ul style="list-style-type: none"> compatible with all Moen disposals & other 3-bolt mounting systems 1 year limited warranty 	186589	9.95	6
REMOVABLE SPLASH GUARD				
	<ul style="list-style-type: none"> helps clear food scraps that cause odor for a more complete rinse compatible with all Moen branded garbage disposals no tools needed for installation 5 year limited warranty 	205497	11.25	100

ACCESSORIES Garbage Disposals

		MODEL	LIST	CASE QTY
DISHWASHER CONNECTOR KIT				
	<ul style="list-style-type: none"> connects 1-1/4", 1" and 3/4" outside diameter dishwasher drain hoses to the 1-1/2" garbage disposal dishwasher inlet compatible with all Moen disposals & other 3-bolt mounting systems 1 year limited warranty 	1023	8.95	24
DRAIN ELBOW & GASKET				
	<ul style="list-style-type: none"> compatible with all Moen disposals & other 3-bolt mounting systems 1 year limited warranty 	1026	10.05	6
SINK FLANGE				
	<ul style="list-style-type: none"> for sinks 3/4" thick or less Finish: brushed stainless steel compatible with all Moen & other 3-bolt mount systems 1 year limited warranty 	1017	17.90	50
UNIVERSAL XPRESS MOUNT ASSEMBLY				
	<ul style="list-style-type: none"> compatible with all Moen disposals & other 3-bolt mounting systems polished stainless steel construction for additional durability 1 year limited warranty 	1824	21.30	10
DISPOSAL UNJAMMING WRENCH				
	<ul style="list-style-type: none"> allows users to clear jam from above the sink compatible with all Moen disposals 1 year limited warranty 	1037	9.95	10
DISPOSAL POWER CORD KIT				
	<ul style="list-style-type: none"> compatible with all disposals 1 year limited warranty 	1024	10.95	24



eBidets and eToilets

Achieve personalized comfort and enhanced cleanliness with Moen's Bidet Seats, Electronic Bidet Seats (eBidets) and Electronic Toilets (eToilets). Easily retrofit any of the bidet seats onto any toilet or replace your current toilet with a tankless eToilet to elevate the design of the bathroom and experience a customized routine tailored to meet your needs for the perfect clean, every time.

5-Series Electronic Cleansing Toilet | ET2200

eBidets and eToilets

COLLECTIONS

- 147 Electronic Bidet Seats
- 148 Non-Electronic Bidet Seats
- 149 Electronic Cleansing Toilets

FINISHES

- White
- Biscuit

ICON KEY



ADA

ADA Compliant - Moen® eBidets and eToilets equipped with remotes or easy-to-use onboard controls allow users to operate without tight grasping, pinching or twisting of the wrist. Additionally, Moen eToilets meet ADA height requirements.



WaterSense Labeled

Product has been tested and is certified to meet EPA flow control criteria.







eBidets

eToilets







Achieve personalized comfort and enhanced cleanliness with Moen's Bidet Seats, Electronic Bidet Seats (eBidets) and Electronic Toilets (eToilets). Easily retrofit any of the bidet seats onto any toilet or replace your current toilet with a tankless eToilet to elevate the design of the bathroom and experience a customized routine tailored to meet your needs for the perfect clean, every time.



	MODEL	LIST	FINISH/CONNECT	CASE QTY
ELECTRONIC BIDET SEAT - 5 SERIES				
 <ul style="list-style-type: none"> • plugs into 120V grounded outlet • retrofit existing traditional toilet • elongated design • front and rear cleansing • pulsating and oscillating cleanse • aerated spray • self-cleaning options with replaceable nozzles • UV technology • endless & instantaneous warm water • adjustable water temperature and pressure • hot or cold massage, nozzle position adjustment and dual nozzles for enhanced personal cleaning • soft-close lid and seat • hygienic seat • heated seat with temperature control and sensor • operates with a remote control • warm air dryer with temperature control • nightlight • deodorizer • ADA Compliant 	EB2100-E	844.60	White	1
	ELECTRONIC BIDET SEAT - 3 SERIES			
 <ul style="list-style-type: none"> • plugs into 120V grounded outlet • retrofit existing traditional toilet • elongated design • front and rear cleansing • pulsating and oscillating cleanse • self-cleaning options with replaceable nozzles • endless & instantaneous warm water • adjustable water temperature and pressure • hot or cold massage, nozzle position adjustment and dual nozzles for enhanced personal cleaning • soft-close lid and seat • hygienic seat • heated seat with temperature control and sensor • operates via a remote control • nightlight • ADA Compliant 	EB1500-E	613.85	White	1
		EB1500-EBS	706.20	Biscuit
ELECTRONIC BIDET SEAT - 3 SERIES				
 <ul style="list-style-type: none"> • plugs into 120V grounded outlet • retrofit existing traditional toilet • elongated design • front and rear cleansing • pulsating and oscillating cleanse • self-cleaning options with replaceable nozzles • endless & instantaneous warm water • adjustable water temperature and pressure • nozzle position adjustment and dual nozzles for enhanced personal cleaning • soft-close lid and seat • hygienic seat • heated seat with temperature control and sensor • nightlight • convenient control panel for operation 	EB1000	438.70	White	1

EBIDET AND ETOILET

eBidets and eToilets

		MODEL	LIST	FINISH/CONNECT	CASE QTY
ELECTRONIC BIDET SEAT - 2 SERIES					
 <ul style="list-style-type: none"> • plugs into 120V grounded outlet • retrofit existing traditional toilet • elongated design • dual nozzles for front and rear cleansing • self-cleaning options with replaceable nozzles • endless and instantaneous warm water • adjustable water temperature & pressure • soft-close lid and seat • hygienic seat • heated seat with temperature control and sensor • operates with an easy turn knob and buttons • quick release hinges • ADA Compliant 		EB800-E	305.30	White	1
NON-ELECTRONIC BIDET SEAT 2-SERIES					
 <ul style="list-style-type: none"> • retrofit existing traditional toilet • elongated design • dual nozzles for front and rear cleansing • water pressure control • soft-close lid and seat -Self-cleaning options with replaceable nozzles • operates via an easy turn knob • quick release hinges • ADA compliant hinges 		EB500-E	144.00	White	5
 <ul style="list-style-type: none"> • retrofit existing traditional toilet • round design • dual nozzles for front and rear cleansing • water pressure control • soft-close lid and seat • self-cleaning options with replaceable nozzles • operates via an easy turn knob • quick release hinges • ADA compliant 		EB500-R	144.00	White	5

eBidets and eToilets

		MODEL	LIST	FINISH/CONNECT	CASE QTY
ELECTRONIC CLEANSING TOILET - 5-SERIES					
	<ul style="list-style-type: none"> • bidet features with front and rear cleansing; pulsating and oscillating cleanse • self-cleaning, replaceable nozzles with UV technology • aerated spray • endless and instantaneous warm water • adjustable water temperature and pressure • soft-close lid and seat • hygienic heated seat with sensor and temperature control • automatic and remote flush • manual side knob and remote control • convenient remote-control activation including remote opening of seat and lid • convenient remote-control activation including remote opening of seat and lid • automatic open/close seat and lid • foot touch open/close seat and lid plus foot touch flush • auto-close and auto-flush feature • auto-sensing nightlight • warm air dryer with temperature control and flash drying • pre-wets bowl to stay clean longer • deodorizer • battery back-up for flush control • comfort height seat • ADA Compliant 	 ET2200	5229.25	White	1
ELECTRONIC CLEANSING TOILET - 3 SERIES					
	<ul style="list-style-type: none"> • bidet features with front and rear cleansing; pulsating and oscillating cleanse • self-cleaning, replaceable nozzles with UV technology • aerated spray • endless and instantaneous warm water • adjustable water temperature and pressure • soft-close lid and seat • hygienic heated seat with sensor and temperature control • automatic and remote flush • manual side knob and remote control • convenient remote-control activation including remote opening of seat and lid • auto-sensing nightlight • warm air dryer with temperature control and flash drying • pre-wets bowl to stay clean longer • deodorizer • comfort height seat • ADA Compliant 	 ET1300	3536.95	White	1
ELECTRONIC CLEANSING TOILET - 2 SERIES					
	<ul style="list-style-type: none"> • bidet features with front and rear cleansing; pulsating and oscillating cleanse • self-cleaning options with replaceable nozzles • aerated spray • endless and instantaneous warm water • adjustable water temperature and pressure • soft-close lid and seat • hygienic heated seat with sensor and temperature control • automatic and remote flush • manual side knob and remote control • auto-sensing nightlight • warm air dryer with temperature control • pre-wets bowl to stay clean longer • comfort height seat • ADA Compliant 	 ET900	1921.55	White	1





BEAUTIFULLY BLENDED

Bath and Shower

Revitalize your daily routines and enhance your bathroom's aesthetic with versatile design solutions from Moen®. Explore an array of faucets, showerheads, accessories and innovative technologies—including touchless faucet options—that allow you to tailor your space's appearance and functionality to your exact needs. Unleash your creativity and craft a blissful escape that looks beautiful and works beautifully.

Flara™ Collection in Polished Nickel



Bath and Shower

Bath collections and matching accessories

COLLECTIONS

- 156 Touchless Bath Faucets
- 159 Weymouth®
- 173 Arris®
- 183 Flara™
- 194 Colinet™
- 205 90°®
- 217 Doux™
- 228 Greenfield™
- 239 Wynford®
- 250 Align®
- 263 Rizon®
- 273 Belfield™
- 286 Cia™
- 296 Voss™
- 310 Dartmoor®
- 316 Glyde™
- 323 Brantford®
- 332 Eva®
- 341 Vichy®
- 345 Gibson™
- 354 Genta™ LX
- 362 Chateau®

FINISHES

- Chrome
- Brushed Nickel
- Brushed Gold
- Polished Nickel
- Oil Rubbed Bronze
- Matte Black
- Wrought Iron/Matte Black

- LifeShine® Non-Tarnish Finish**
- All Brushed Nickel, Brushed Gold and Polished Nickel faucet components feature the LifeShine Non-Tarnish Finish.

- Wrought Iron/Matte Black**
- Wrought Iron and Matte Black are the same finish and interchangeable.

ICON KEY



WaterSense Labeled

Product has been tested and is certified to meet EPA flow control criteria.



MotionSense Wave™ Hands-Free Faucet

MotionSense Wave™ touchless faucets allow you to easily turn water on and off with the wave of a hand.

IMMERSION®

Immersion® Rainshower

Immersion Rainshower's innovative technology provides optimal water pressure and excellent coverage for an unparalleled shower experience.



Moen® M•PACT® Common Valve System

With M•PACT, you can change your faucet style without replacing any plumbing. It's as easy as changing a light bulb.

DURALOCK®

Push-button connector that makes installing faucets quick, secure and hassle-free – no tools required. A telltale 'click' audibly signals a secure connection.

DURALAST®

Duralast Cartridge

Provides the smooth feel and reliable operation of a new faucet from the first time you use it to the last.



Also available in bulk pack.
See page 597.



Available in bulk pack only.





Versatile. Durable. Built to Perform.

Moen® Roman Tub Valve improvements are designed for faster, more secure mounting on a wider variety of tub decks. Plus, an expanded portfolio of connection options makes installation even easier for installers of all skill levels.

KEY INSTALLATION FEATURES

Supply Connection Options

Moen also recognizes the increased use of PEX, cold expansion PEX and CPVC supply lines. Plumbers can now order valves designed to work directly with all types of piping—including copper. No other manufacturer offers more options.

Standardized Drill Holes

Only one drill bit (1¼") is needed for all spout and handle holes to further speed and simplify installation.

Dura-Grip Mounting System

This robust engineered system, where the mounting hardware components work together to prevent the valves and spout from moving after installation, also provides features that work with all types of surfaces (on both fixed and adjustable valves).

Test Plug

All models include a test plug for high-pressure testing after rough-in.

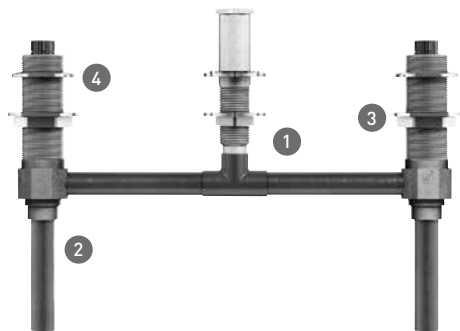

FIXED ROMAN TUB VALVE

- 1 Dura-Grip Mounting Hardware**
Improved design works with all deck materials including wood, fiberglass, tile and stone.
- 2 Robust, Pre-Soldered Design**
Set to standard 10" centers for simple installation.
- 3 Versatile Installation**
Fits finished tub decks from 1/8" to 13/16" thick.
- 4 M•PACT® Common Valve System Compatible**
Accepts all Moen Roman Tub Trim Kits.

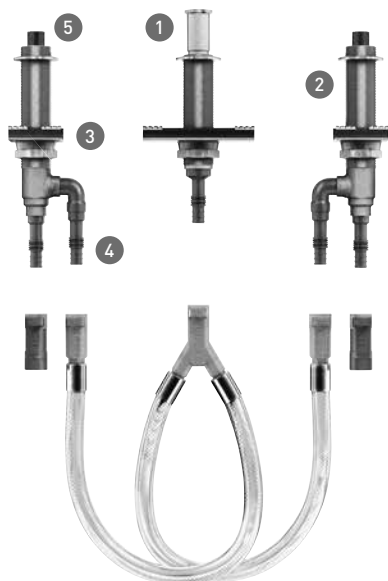

ADJUSTABLE ROMAN TUB VALVE

- 1 No-Cut Adjustable Spout Shank**
Loosen an expansion nut, extend and lock in place using the supplied metal tool.
- 2 33/8" Rough-In Deck Thickness**
Adapts to decks from 1/8" to 23/4" thick—with an additional 11/4" adjustability to accommodate finish materials.
- 3 Dura-Grip Mounting System**
Anti-rotation bracket and spout shank assembly provide secure installation to a variety of surfaces both above and below the deck.
- 4 Quick-Connect Flexible Hose**
Braided PVC tube for easy connections.
- 5 M•PACT Common Valve System Compatible**
Accepts all Moen Roman Tub Trim Kits.

Easily Change Your Style

The Moen M•PACT Common Valve System lets you upgrade the style of your faucet or shower as easily as changing a light bulb, saving you time, money and effort. Using just two simple tools, an Allen wrench and a screwdriver, you can enhance your bathroom style in minutes.

M•PACT COMPATIBLE FIXTURES

Little Effort, Big Difference

With an M•PACT compatible fixture, you can upgrade your bath or shower faucets at any time and never touch the plumbing. All changes can be made above the deck or in front of the wall.

- Untwist your current fixture from the top to remove
- Choose any M•PACT style fixture you like
- Lock right into place

Upgrade Anytime

The system is available in a variety of attractive styles and elegant finishes. Change fixtures at any point while decorating, during construction or years down the road.

What Sets Moen Apart?

Our M•PACT Common Valve System allows the homeowner to completely upgrade the style of their lavatory or shower faucet without replacing any of the faucet plumbing.

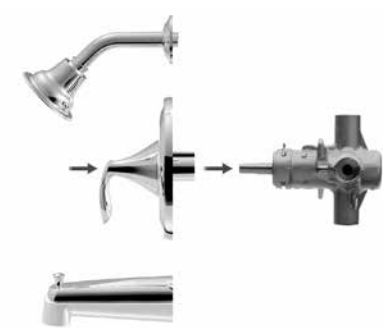

M•PACT COMMON VALVE SYSTEM

The M•PACT Common Valve System is available in the following Moen product applications

- Widespread lavatory faucets
- Roman tub faucets
- Wallmount lavatory faucets
- Tub/Shower trim

The M•PACT Common Valve System is compatible with Moen bath and shower faucets featuring this logo: 







PRODUCTS FEATURED:
Arris® Two-Handle Widespread



BATH TOUCHLESS FAUCETS



TOUCHLESS Bath Collection

	MODEL	LIST	FINISH/CONNECT	CASE QTY	
FLARA™ TOUCHLESS ONE-HANDLE BATHROOM FAUCET - MOTIONSENSE WAVE™ - PREMIUM					
 DECKPLATE SOLD SEPARATELY 	<ul style="list-style-type: none"> • application: one or three hole • supply lines: flexible • connection: 3/8" compression • deckplate: sold separately • drain assembly: metal • drain assembly type: spring loaded pop-up • DC powered: 6 AA batteries included 		1.2 GPM (4.5L/min) max.		
	S6981EW	1009.30	Chrome	3	
	S6981EWBN	1261.60	Brushed Nickel	3	
	S6981EWNL	1312.05	Polished Nickel	3	
	S6981EWBG	1362.55	Brushed Gold	3	
	OPTIONAL DECKPLATE SOLD SEPARATELY				
	161919	26.90	Chrome	20	
	161919BN	38.10	Brushed Nickel	20	
	161919NL	38.10	Polished Nickel	20	
	161919BG	38.10	Brushed Gold	20	
OPTIONAL AC ADAPTERS SOLD SEPARATELY					
169031	159.60	N/A or Unfinished	12		

DOUX™ TOUCHLESS ONE-HANDLE BATHROOM FAUCET - MOTIONSENSE WAVE™ - PREMIUM					
 DECKPLATE INCLUDED 	<ul style="list-style-type: none"> • application: one or three hole • supply lines: flexible • connection: 3/8" compression • deckplate: included • drain assembly: metal • drain assembly type: spring loaded pop-up • DC powered: 6 AA batteries included 		1.2 GPM (4.5L/min) max.		
	S6910EW	825.90	Chrome	3	
	S6910EWBN	1060.80	Brushed Nickel	3	
	S6910EWBL	1156.25	Matte Black	3	
	OPTIONAL AC ADAPTERS SOLD SEPARATELY				
	169031	159.60	N/A or Unfinished	12	



CIA™ TOUCHLESS ONE-HANDLE BATHROOM FAUCET - MOTIONSENSE WAVE™					
 DECKPLATE INCLUDED 	<ul style="list-style-type: none"> • application: one or three hole • supply lines: flexible • connection: 3/8" compression • deckplate: included • drain assembly: metal • drain assembly type: spring loaded pop-up • red/blue markings: included • matte black faucet includes optional brushed gold escutcheon • DC powered: 6 AA batteries included 		1.2 GPM (4.5L/min) max.		
	6221EW	627.70	Chrome	3	
	6221EWBN	847.40	Brushed Nickel	3	
	6221EWBG	910.15	Brushed Gold	3	
	6221EWBL	910.15	Matte Black	3	
	OPTIONAL AC ADAPTERS SOLD SEPARATELY				
	169031	159.60	N/A or Unfinished	12	







BATH AND SHOWERING



WEYMOUTH® Collection

MODEL LIST FINISH/CONNECT CASE QTY

ONE-HANDLE BATHROOM FAUCET - PREMIUM				
 <ul style="list-style-type: none"> • application: one hole • supply lines: flexible • connection: 3/8" compression • drain assembly: metal • drain assembly type: spring loaded pop-up <p> DURALAST®</p>	<p> 1.2 GPM (4.5L/min) max.</p>			
	S42107	780.10	Chrome	3
	S42107BN	1092.15	Brushed Nickel	3
	S42107BL	1131.15	Matte Black	3
	S42107NL	1170.15	Polished Nickel	3
	S42107BG	1209.20	Brushed Gold	3
	S42107ORB	1209.20	Oil Rubbed Bronze	3

TWO-HANDLE WIDESPREAD BATHROOM FAUCET TRIM - PREMIUM				
 <ul style="list-style-type: none"> • application: three hole • center dimensions: 8" - 16" center • drain assembly: metal with lift rod • valve: sold separately <p> </p>	<p> 1.2 GPM (4.5L/min) max.</p>			
	TS42108	828.20	Chrome	3
	TS42108BN	1118.05	Brushed Nickel	3
	TS42108BL	1159.45	Matte Black	3
	TS42108NL	1200.85	Polished Nickel	3
	TS42108BG	1242.25	Brushed Gold	3
	TS42108ORB	1242.25	Oil Rubbed Bronze	3
 <ul style="list-style-type: none"> • application: three hole • center dimensions: 8" - 16" center • drain assembly: metal with lift rod • valve: sold separately <p></p>	<p> 1.2 GPM (4.5L/min) max.</p>			
	TS42114	828.20	Chrome	3
	TS42114BN	1118.05	Brushed Nickel	3
	TS42114BL	1159.45	Matte Black	3
	TS42114NL	1200.85	Polished Nickel	3
	TS42114BG	1283.70	Brushed Gold	3
	TS42114ORB	1242.25	Oil Rubbed Bronze	3

WIDESPREAD FAUCET VALVE				
 <ul style="list-style-type: none"> • application: three hole • center dimensions: 8" - 16" center • drain assembly: metal with lift rod <p> DURALOCK® DURALAST®</p>	9000◆	165.40	1/2" IPS	6











HOW TO ORDER
VALVES: PAGE 469



OPTION: HANDLE CAP KIT				
 <ul style="list-style-type: none"> • description: finished handle cap kit • language: english version only 	221672	27.50	Chrome	12
	221672BN	36.50	Brushed Nickel	12
	221672BL	40.40	Matte Black	12
	221672NL	36.50	Polished Nickel	12
	221672BG	36.50	Brushed Gold	12
	221672ORB	40.40	Oil Rubbed Bronze	12











WEYMOUTH® Collection

		MODEL	LIST	FINISH/CONNECT	CASE QTY
TWO-HANDLE WALLMOUNT BATHROOM FAUCET TRIM - PREMIUM					
 <ul style="list-style-type: none"> • application: three hole • center dimensions: 8" center • drain assembly: 140780 sold separately • valve: sold separately 	<ul style="list-style-type: none"> • application: three hole • center dimensions: 8" center • drain assembly: 140780 sold separately • valve: sold separately 	1.2 GPM (4.5L/min) max.			
		TS42112	847.50	Chrome	3
		TS42112BN	1101.70	Brushed Nickel	3
		TS42112BL	1144.10	Matte Black	3
		TS42112NL	1186.45	Polished Nickel	3
		TS42112BG	1228.85	Brushed Gold	3
	TS42112ORB	1228.85	Oil Rubbed Bronze	3	
TWO-HANDLE WALLMOUNT FAUCET VALVE					
 <ul style="list-style-type: none"> • application: three hole • center dimensions: 8" center • drain assembly: 140780 sold separately • includes: mounting brackets  DURALAST®		9700	233.95	1/2" CC	3
HOW TO ORDER VALVES: PAGE 469  TRIM PART #   VALVE PART #   COMPLETE FAUCET					
OPTION: HANDLE CAP KIT					
 <ul style="list-style-type: none"> • description: finished handle cap kit • language: english version only 		221672	27.50	Chrome	12
		221672BN	36.50	Brushed Nickel	12
		221672BL	40.40	Matte Black	12
		221672NL	36.50	Polished Nickel	12
		221672BG	36.50	Brushed Gold	12
		221672ORB	40.40	Oil Rubbed Bronze	12
OPTION: DRAIN ASSEMBLY					
 <ul style="list-style-type: none"> • drain assembly: metal • drain assembly type: spring loaded pop-up • drain assembly size: 1-1/4" • drain assembly: 1-1/4" non-overflow 		140780	78.35	Chrome	12
		140780BN	109.20	Brushed Nickel	12
		140780BL	123.30	Matte Black	12
		140780NL	109.20	Polished Nickel	12
		140780BG	109.20	Brushed Gold	12
		140780ORB	131.30	Oil Rubbed Bronze	12

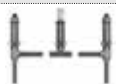
		MODEL	LIST	FINISH/CONNECT	CASE QTY
FREESTANDING OR WALLMOUNT TUB FILLER TRIM - PREMIUM					
 <ul style="list-style-type: none"> • application: two hole • center dimensions: 8" center • connection: 3/4" male • showerhead type: handshower • handshower functions: one-function • handshower flow rate: 1.75 gpm (6.65 L/min) max. • spout reach: 9.00" • mounting kit: sold separately 		S22105	2368.70	Chrome	1
		S22105BN	3434.65	Brushed Nickel	1
		S22105BL	3553.00	Matte Black	1
		S22105NL	3671.50	Polished Nickel	1
		S22105BG	3789.90	Brushed Gold	1
		S22105ORB	3789.90	Oil Rubbed Bronze	1
	 DURALAST®				
 <ul style="list-style-type: none"> • application: two hole • center dimensions: 8" center • connection: 3/4" male • showerhead type: handshower • handshower functions: one-function • handshower flow rate: 1.75 gpm (6.65 L/min) max. • spout reach: 9.00" • mounting kit: sold separately 		S22110	2368.70	Chrome	1
		S22110BN	3434.65	Brushed Nickel	1
		S22110BL	3553.00	Matte Black	1
		S22110NL	3671.50	Polished Nickel	1
		S22110BG	3789.90	Brushed Gold	1
		S22110ORB	3789.90	Oil Rubbed Bronze	1
	  DURALAST®				
 <ul style="list-style-type: none"> • description: floor mount tub filler risers • application: two hole • connection: 3/4" male • requires: floor mounting kit • fits: S22105 and S22100 		TS25105	988.30	Chrome	1
		TS25105BN	1432.85	Brushed Nickel	1
		TS25105BL	1482.40	Matte Black	1
		TS25105NL	1531.85	Polished Nickel	1
		TS25105BG	1581.25	Brushed Gold	1
		TS25105ORB	1576.15	Oil Rubbed Bronze	1
					
FREESTANDING TUB FILLER VALVE AND MOUNTING KIT - PREMIUM					
 <ul style="list-style-type: none"> • description: double riser floor joist mounting kit • application: two hole with 8" centers • center dimensions: 		TS50200	613.50	1/2" CC, NPT	2
					
 <ul style="list-style-type: none"> • description: double riser concrete mounting kit • application: two hole with 8" centers • quarter turn stops: included 		TS50210	498.70	1/2" CC, NPT	2
					
<p>HOW TO ORDER VALVES: PAGE 469</p> 					
OPTION: DIVERTER HANDLE CAP KIT					
 <ul style="list-style-type: none"> • description: finished diverter handle cap kit 		221772	17.65	Chrome	12
		221772BN	23.40	Brushed Nickel	12
		221772BL	24.90	Matte Black	12
		221772NL	24.75	Polished Nickel	12
		221772BG	24.75	Brushed Gold	12
		221772ORB	25.75	Oil Rubbed Bronze	12
OPTION: HANDLE CAP KIT					
 <ul style="list-style-type: none"> • description: finished handle cap kit • language: english version only 		221672	27.50	Chrome	12
		221672BN	36.50	Brushed Nickel	12
		221672BL	40.40	Matte Black	12
		221672NL	36.50	Polished Nickel	12
		221672BG	36.50	Brushed Gold	12
		221672ORB	40.40	Oil Rubbed Bronze	12

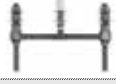
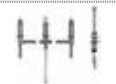



















WEYMOUTH® Collection

		MODEL	LIST	FINISH/CONNECT	CASE QTY
TWO-HANDLE ROMAN TUB TRIM - PREMIUM					
 <ul style="list-style-type: none"> • application: three hole • spout reach: 8.10" • valve: sold separately 		TS22101	1163.60	Chrome	3
		TS22101BN	1646.90	Brushed Nickel	3
		TS22101NL	1646.90	Polished Nickel	3
		TS22101BG	1646.90	Brushed Gold	3
		TS22101BL	1776.85	Matte Black	3
		TS22101ORB	1776.85	Oil Rubbed Bronze	3
 <ul style="list-style-type: none"> • application: three hole • spout reach: 8.10" • valve: sold separately 		TS22103	1163.60	Chrome	3
		TS22103BN	1646.90	Brushed Nickel	3
		TS22103NL	1646.90	Polished Nickel	3
		TS22103BG	1646.90	Brushed Gold	3
		TS22103BL	1776.85	Matte Black	3
		TS22103ORB	1776.85	Oil Rubbed Bronze	3
TWO-HANDLE ROMAN TUB TRIM WITH HANDSHOWER - PREMIUM					
 <ul style="list-style-type: none"> • application: four hole • showerhead type: handshower • handshower flow rate: 1.75 gpm (6.65 L/min) max. • spray functions: one-function • spout reach: 8.10" • valve: sold separately 		1.75 GPM (6.65 L/min) max.			
		TS21104	1774.00	Chrome	3
		TS21104BN	3087.95	Brushed Nickel	3
		TS21104NL	3087.95	Polished Nickel	3
		TS21104BG	3087.95	Brushed Gold	3
		TS21104BL	3331.65	Matte Black	3
	TS21104ORB	3331.65	Oil Rubbed Bronze	3	
TWO-HANDLE ROMAN TUB VALVE					
 <ul style="list-style-type: none"> • deck thickness: 1/8" to 3-3/8" rough-in deck • adjustable spout shank: adjustable center dimensions 		4792	192.30	1/2" CC	6
		DURALAST®			
 <ul style="list-style-type: none"> • deck thickness: 1/8" to 2-3/4" rough-in deck • adjustable spout shank: 10" - 24" center dimensions 		4793	217.80	1/2" CPVC, Crimp Ring PEX	6
		4794	207.65	1/2" Crimp Ring PEX, Cold Exp. PEX	6
	DURALOCK® DURALAST®				
 <ul style="list-style-type: none"> • deck thickness: 1/8" to 3-3/16" rough-in deck • Non-adjustable spout shank: 10" center dimensions 		4796	181.20	1/2" CC	6
		4797	184.70	1/2" CPVC, Crimp Ring PEX	6
		4798	184.70	1/2" Crimp Ring PEX, Cold Exp. PEX	6
	DURALAST®				
TWO-HANDLE ROMAN TUB VALVE WITH HANDSHOWER					
 <ul style="list-style-type: none"> • deck thickness: 1/8" to 2-5/8" rough-in deck • non-adj spout shank: adjustable center dim's 		9792	433.35	1/2" CC	6
		DURALAST®			
 <ul style="list-style-type: none"> • deck thickness: 1/8" to 2-5/8" rough-in deck • adj spout shank: 10" - 24" center dimensions 		9793	443.50	1/2" CPVC, Crimp Ring PEX	6
		DURALOCK® DURALAST®			
For more product details, reference page 470 in valve section.					
HOW TO ORDER					
VALVES: PAGE 470					
OPTION: HANDLE CAP KIT					
 <ul style="list-style-type: none"> • description: finished handle cap kit • language: english version only 		221672	27.50	Chrome	12
		221672BN	36.50	Brushed Nickel	12
		221672NL	36.50	Polished Nickel	12
		221672BG	36.50	Brushed Gold	12
		221672BL	40.40	Matte Black	12
		221672ORB	40.40	Oil Rubbed Bronze	12

WEYMOUTH®

























WEYMOUTH® Collection

		MODEL	LIST	FINISH/CONNECT	CASE QTY
EXACTTEMP® VALVE ONLY TRIM - PREMIUM					
 <ul style="list-style-type: none"> • description: temperature control valve trim • requires: separate volume control valve • valve: sold separately  		TS32110	496.00	Chrome	3
		TS32110BN	730.00	Brushed Nickel	3
		TS32110NL	730.00	Polished Nickel	3
		TS32110BG	730.00	Brushed Gold	3
		TS32110BL	787.50	Matte Black	3
		TS32110ORB	787.50	Oil Rubbed Bronze	3
EXACTTEMP® THERMOSTATIC MIXING SHOWER VALVE - PREMIUM					
 <ul style="list-style-type: none"> • description: thermostatic rough-in valve • ports: four with adjustable temp. limit stops • check stops: included 		S3371	728.95	¾" IPS	6
<p>HOW TO ORDER VALVES: PAGE 471</p>  TRIM PART # +  VALVE PART # =  COMPLETE FAUCET					
OPTION: HANDLE CAP KIT					
 <ul style="list-style-type: none"> • description: finished handle cap kit • language: english version only 		221672	27.50	Chrome	12
		221672BN	36.50	Brushed Nickel	12
		221672NL	36.50	Polished Nickel	12
		221672BG	36.50	Brushed Gold	12
		221672BL	40.40	Matte Black	12
		221672ORB	40.40	Oil Rubbed Bronze	12

EXACTTEMP® VOLUME CONTROL VALVE TRIM - PREMIUM					
 <ul style="list-style-type: none"> • valve: sold separately  		TS52104	257.50	Chrome	6
		TS52104BN	355.75	Brushed Nickel	6
		TS52104NL	355.75	Polished Nickel	6
		TS52104BG	355.75	Brushed Gold	6
		TS52104BL	383.55	Matte Black	6
		TS52104ORB	383.55	Oil Rubbed Bronze	6
EXACTTEMP® VOLUME CONTROL SHOWER VALVE - PREMIUM					
 <ul style="list-style-type: none"> • includes: volume control 		S3600	185.35	¾" IPS	12
<p>HOW TO ORDER VALVES: PAGE 471</p>  TRIM PART # +  VALVE PART # =  COMPLETE FAUCET					
OPTION: HANDLE CAP KIT					
 <ul style="list-style-type: none"> • description: finished handle cap kit • language: english version only 		221672	27.50	Chrome	12
		221672BN	36.50	Brushed Nickel	12
		221672NL	36.50	Polished Nickel	12
		221672BG	36.50	Brushed Gold	12
		221672BL	40.40	Matte Black	12
		221672ORB	40.40	Oil Rubbed Bronze	12

















WEYMOUTH® Collection

		MODEL	LIST	FINISH/CONNECT	CASE QTY	
M-CORE® 4-SERIES TUB/SHOWER TRIM – PREMIUM						
 <ul style="list-style-type: none"> • showerhead: two-function eco-performance rainshower • showerhead size: 9" diameter • tub spout length: 6 3/4" • tub spout connection type: slip fit • tub spout type: diverter • includes: thermostatic cartridge with volume and temperature control • valve: sold separately 	<ul style="list-style-type: none"> • showerhead: two-function eco-performance rainshower • showerhead size: 9" diameter • tub spout length: 6 3/4" • tub spout connection type: slip fit • tub spout type: diverter • includes: thermostatic cartridge with volume and temperature control • valve: sold separately 	1.75 GPM (6.65 L/min) max. UTS43103EP	1215.90	Chrome	3	
			UTS43103EPBN	1616.50	Brushed Nickel	3
			UTS43103EPNL	1616.50	Polished Nickel	3
			UTS43103EPBG	1616.50	Brushed Gold	3
			UTS43103EPBL	1766.50	Matte Black	3
			UTS43103EPORB	1766.50	Oil Rubbed Bronze	3
M-CORE® 4-SERIES SHOWER ONLY TRIM – PREMIUM						
 <ul style="list-style-type: none"> • showerhead: two-function eco-performance rainshower • showerhead size: 9" diameter • includes: thermostatic cartridge with volume and temperature control • valve: sold separately 	<ul style="list-style-type: none"> • showerhead: two-function eco-performance rainshower • showerhead size: 9" diameter • includes: thermostatic cartridge with volume and temperature control • valve: sold separately 	1.75 GPM (6.65 L/min) max. UTS43102EP	1078.35	Chrome	3	
			UTS43102EPBN	1444.15	Brushed Nickel	3
			UTS43102EPNL	1444.15	Polished Nickel	3
			UTS43102EPBG	1444.15	Brushed Gold	3
			UTS43102EPBL	1574.65	Matte Black	3
			UTS43102EPORB	1574.65	Oil Rubbed Bronze	3
M-CORE® 4-SERIES VALVE ONLY TRIM – PREMIUM						
 <ul style="list-style-type: none"> • includes: thermostatic cartridge with volume and temperature control • valve: sold separately 	<ul style="list-style-type: none"> • includes: thermostatic cartridge with volume and temperature control • valve: sold separately 	UTS43101	765.75	Chrome	3	
			UTS43101BN	943.90	Brushed Nickel	3
			UTS43101NL	943.90	Polished Nickel	3
			UTS43101BG	943.90	Brushed Gold	3
			UTS43101BL	992.95	Matte Black	3
			UTS43101ORB	992.95	Oil Rubbed Bronze	3
M-CORE® MIXING SHOWER VALVE						
 <ul style="list-style-type: none"> • tub/shower or shower only application • ports: four with adj. temp. limit stops • included: test plug and cross flow plug 	<ul style="list-style-type: none"> • tub/shower or shower only application • ports: four with adj. temp. limit stops • included: test plug and cross flow plug 	U140CI	72.60	1/2" CC/IPS	6	
			U140X	72.60	1/2" Crimp Ring PEX + CC/IPS Tub	6
			U140CX	72.60	1/2" Cold Exp. PEX + CC/IPS Tub	6
			U140V	88.95	1/2" CPVC + CC/IPS Tub	6
 <ul style="list-style-type: none"> • tub/shower or shower only application • ports: four with adj. temp. limit stops • quarter turn stops: included 	<ul style="list-style-type: none"> • tub/shower or shower only application • ports: four with adj. temp. limit stops • quarter turn stops: included 	U140CIS	104.50	1/2" CC/IPS	6	
			U140XS	104.50	1/2" Crimp Ring PEX + CC/IPS Tub	6
			U140CXS	104.50	1/2" Cold Exp. PEX + CC/IPS Tub	6
			U140VS	120.85	1/2" CPVC + CC/IPS Tub	6
 <ul style="list-style-type: none"> • shower only application • ports: three 	<ul style="list-style-type: none"> • shower only application • ports: three 	U130CI	72.60	1/2" CC/IPS	6	
			U130X	72.60	1/2" Crimp Ring PEX	6
			U130CX	72.60	1/2" Cold Exp. PEX	6
 <ul style="list-style-type: none"> • shower only application • ports: three • quarter turn stops: included 	<ul style="list-style-type: none"> • shower only application • ports: three • quarter turn stops: included 	U130CIS	104.50	1/2" CC/IPS	6	
			U130XS	104.50	1/2" Crimp Ring PEX	6
			U130CXS	104.50	1/2" Cold Exp. PEX	6
Four port valves can be used with either Tub/Shower or Shower Only applications. Three port valves can ONLY be used with Shower Only applications. For more product details, reference page 471 in valve section.						
HOW TO ORDER VALVES: PAGE 471		 TRIM PART #	+	 VALVE PART #	=	 COMPLETE FAUCET















WEYMOUTH®











MODEL LIST FINISH/CONNECT CASE QTY

M-CORE® 3-SERIES TUB/SHOWER TRIM – PREMIUM										
 <ul style="list-style-type: none"> • showerhead: two-function rainshower • showerhead size: 9" diameter • tub spout length: 6 3/4" • tub spout connection type: slip fit • tub spout type: diverter • includes: pressure balanced cartridge with volume and temperature control • valve: sold separately 	2.5 GPM (9.5 L/min) max.									
	UTS33103	1078.20	Chrome	3						
	UTS33103BN	1478.80	Brushed Nickel	3						
	UTS33103NL	1478.80	Polished Nickel	3						
	UTS33103BG	1478.80	Brushed Gold	3						
	UTS33103BL	1628.80	Matte Black	3						
	UTS33103ORB	1628.80	Oil Rubbed Bronze	3						
	1.75 GPM (6.65 L/min) max.									
	UTS33103EP	1078.20	Chrome	3						
	UTS33103EPBN	1478.80	Brushed Nickel	3						
	UTS33103EPNL	1478.80	Polished Nickel	3						
	UTS33103EPBG	1478.80	Brushed Gold	3						
	UTS33103EPBL	1628.80	Matte Black	3						
	UTS33103EPORB	1628.80	Oil Rubbed Bronze	3						
M-CORE® 3-SERIES SHOWER ONLY TRIM – PREMIUM										
 <ul style="list-style-type: none"> • showerhead: two-function rainshower • showerhead size: 9" diameter • includes: pressure balanced cartridge with volume and temperature control • valve: sold separately 	2.5 GPM (9.5 L/min) max.									
	UTS33102	940.65	Chrome	3						
	UTS33102BN	1306.45	Brushed Nickel	3						
	UTS33102NL	1306.45	Polished Nickel	3						
	UTS33102BG	1306.45	Brushed Gold	3						
	UTS33102BL	1436.90	Matte Black	3						
	UTS33102ORB	1436.90	Oil Rubbed Bronze	3						
	1.75 GPM (6.65 L/min) max.									
	UTS33102EP	940.65	Chrome	3						
	UTS33102EPBN	1306.45	Brushed Nickel	3						
	UTS33102EPNL	1306.45	Polished Nickel	3						
	UTS33102EPBG	1306.45	Brushed Gold	3						
	UTS33102EPBL	1436.90	Matte Black	3						
	UTS33102EPORB	1436.90	Oil Rubbed Bronze	3						
M-CORE® MIXING SHOWER VALVE										
 <ul style="list-style-type: none"> • tub/shower or shower only application • ports: four with adj. temp. limit stops • included: test plug and cross flow plug 	U140CI	72.60	1/2" CC/IPS	6						
	U140X	72.60	1/2" Crimp Ring PEX + CC/IPS Tub	6						
	U140CX	72.60	1/2" Cold Exp. PEX + CC/IPS Tub	6						
	U140V	88.95	1/2" CPVC + CC/IPS Tub	6						
 <ul style="list-style-type: none"> • tub/shower or shower only application • ports: four with adj. temp. limit stops • quarter turn stops: included 	U140CIS	104.50	1/2" CC/IPS	6						
	U140XS	104.50	1/2" Crimp Ring PEX + CC/IPS Tub	6						
	U140CXS	104.50	1/2" Cold Exp. PEX + CC/IPS Tub	6						
	U140VS	120.85	1/2" CPVC + CC/IPS Tub	6						
 <ul style="list-style-type: none"> • shower only application • ports: three 	U130CI	72.60	1/2" CC/IPS	6						
	U130X	72.60	1/2" Crimp Ring PEX	6						
	U130CX	72.60	1/2" Cold Exp. PEX	6						
 <ul style="list-style-type: none"> • shower only application • ports: three • quarter turn stops: included 	U130CIS	104.50	1/2" CC/IPS	6						
	U130XS	104.50	1/2" Crimp Ring PEX	6						
	U130CXS	104.50	1/2" Cold Exp. PEX	6						
<p>Four port valves can be used with either Tub/Shower or Shower Only applications. Three port valves can ONLY be used with Shower Only applications. For more product details, reference page 471 in valve section.</p>										
<p>HOW TO ORDER VALVES: PAGE 471</p>		 <p>TRIM PART #</p>			<p>+</p>	 <p>VALVE PART #</p>		<p>=</p>	 <p>COMPLETE FAUCET</p>	

WEYMOUTH®









WEYMOUTH® Collection

		MODEL	LIST	FINISH/CONNECT	CASE QTY	
M-CORE® 3-SERIES VALVE ONLY TRIM - PREMIUM						
 <ul style="list-style-type: none"> • includes: pressure balanced cartridge with volume and temperature control • valve: sold separately 	 	UTS33101	628.05	Chrome	3	
		UTS33101BN	806.20	Brushed Nickel	3	
		UTS33101NL	806.20	Polished Nickel	3	
		UTS33101BG	806.20	Brushed Gold	3	
		UTS33101BL	855.25	Matte Black	3	
		UTS33101ORB	855.25	Oil Rubbed Bronze	3	
M-CORE® MIXING SHOWER VALVE						
 <ul style="list-style-type: none"> • tub/shower or shower only application • ports: four with adj. temp. limit stops • included: test plug and cross flow plug 		U140CI	72.60	1/2" CC/IPS	6	
		U140X	72.60	1/2" Crimp Ring PEX + CC/IPS Tub	6	
		U140CX	72.60	1/2" Cold Exp. PEX + CC/IPS Tub	6	
		U140V	88.95	1/2" CPVC + CC/IPS Tub	6	
 <ul style="list-style-type: none"> • tub/shower or shower only application • ports: four with adj. temp. limit stops • quarter turn stops: included 		U140CIS	104.50	1/2" CC/IPS	6	
		U140XS	104.50	1/2" Crimp Ring PEX + CC/IPS Tub	6	
		U140CXS	104.50	1/2" Cold Exp. PEX + CC/IPS Tub	6	
		U140VS	120.85	1/2" CPVC + CC/IPS Tub	6	
 <ul style="list-style-type: none"> • shower only application • ports: three 		U130CI	72.60	1/2" CC/IPS	6	
		U130X	72.60	1/2" Crimp Ring PEX	6	
		U130CX	72.60	1/2" Cold Exp. PEX	6	
 <ul style="list-style-type: none"> • shower only application • ports: three • quarter turn stops: included 		U130CIS	104.50	1/2" CC/IPS	6	
		U130XS	104.50	1/2" Crimp Ring PEX	6	
		U130CXS	104.50	1/2" Cold Exp. PEX	6	
Four port valves can be used with either Tub/Shower or Shower Only applications. Three port valves can ONLY be used with Shower Only applications. For more product details, reference page 471 in valve section.						
HOW TO ORDER VALVES: PAGE 471		 TRIM PART #	+	 VALVE PART #	=	 COMPLETE FAUCET

M-CORE® 3-SERIES WITH INTEGRATED TRANSFER VALVE TRIM - PREMIUM						
 <ul style="list-style-type: none"> • includes: pressure balanced cartridge with volume and temperature control • valve: sold separately 	 	UTS4311	753.45	Chrome	4	
		UTS4311BN	1092.50	Brushed Nickel	4	
		UTS4311NL	1092.50	Polished Nickel	4	
		UTS4311BG	1092.50	Brushed Gold	4	
		UTS4311BL	1201.75	Matte Black	4	
		UTS4311ORB	1201.75	Oil Rubbed Bronze	4	
M-CORE® WITH INTEGRATED TRANSFER VALVE						
Three Function (2 independent/1 shared) OR Six Function (3 independent/3 shared) - plumbing configuration page 478						
 <ul style="list-style-type: none"> • ports: four with adj. temp. limit stops • check stops: included 		U362CIS	270.70	1/2" CC/IPS	6	
		U362CXS	270.70	1/2" Cold Exp. PEX	6	
		U362XS	270.70	1/2" Crimp Ring PEX	6	
Two Independent Functions OR Three Independent Functions - plumbing configurations page 478						
 <ul style="list-style-type: none"> • ports: four with adj. temp. limit stops • check stops: included 		U232CIS	270.70	1/2" CC/IPS	6	
		U232CXS	270.70	1/2" Cold Exp. PEX	6	
		U232XS	270.70	1/2" Crimp Ring PEX	6	
For more product details, reference page 472 in valve section. See page 478 for plumbing configurations.						
HOW TO ORDER VALVES: PAGE 472		 TRIM PART #	+	 VALVE PART #	=	 COMPLETE FAUCET

















WEYMOUTH®

WEYMOUTH® Collection

		MODEL	LIST	FINISH/CONNECT	CASE QTY	
M-CORE® TRANSFER VALVE TRIM - PREMIUM						
 <ul style="list-style-type: none"> • use with the M-CORE® transfer valve • valve: sold separately 		UTS32205	469.15	Chrome	12	
		UTS32205BN	536.10	Brushed Nickel	12	
		UTS32205NL	536.10	Polished Nickel	12	
		UTS32205BG	536.10	Brushed Gold	12	
		UTS32205BL	570.70	Matte Black	12	
		UTS32205ORB	570.70	Oil Rubbed Bronze	12	
M-CORE® TRANSFER VALVE						
Three Function (2 independent/1 shared) OR Six Function (3 independent/3 shared) - plumbing configuration page 478						
 <ul style="list-style-type: none"> • number of functions: three or six • ports: four 		U361CI	152.70	1/2" CC/IPS	6	
		U361CX	152.70	1/2" Cold Exp. PEX	6	
		U361X	152.70	1/2" Crimp Ring PEX	6	
Two Independent Functions OR Three Independent Functions - plumbing configurations page 478						
 <ul style="list-style-type: none"> • number of functions: two or three • ports: four 		U231CI	152.70	1/2" CC/IPS	6	
		U231CX	152.70	1/2" Cold Exp. PEX	6	
		U231X	152.70	1/2" Crimp Ring PEX	6	
For more product details, reference page 472 in valve section. See page 478 for plumbing configurations.						
HOW TO ORDER VALVES: PAGE 472		 TRIM PART #	+	 VALVE PART #	=	 COMPLETE FAUCET



















WEYMOUTH® Collection

		MODEL	LIST	FINISH/CONNECT	CASE QTY						
M-CORE® 2-SERIES TUB/SHOWER TRIM – PREMIUM											
 <ul style="list-style-type: none"> • showerhead: two-function eco-performance rainshower • showerhead size: 9" diameter • tub spout length: 6 3/4" • tub spout connection type: slip fit • tub spout type: diverter • includes: pressure balanced cartridge with temperature control • valve: sold separately 		1.75 GPM (6.65 L/min) max.									
		UTS232104EP	1068.75	Chrome	3						
		UTS232104EPBN	1453.15	Brushed Nickel	3						
		UTS232104EPNL	1453.15	Polished Nickel	3						
		UTS232104EPBG	1453.15	Brushed Gold	3						
		UTS232104EPBL	1558.80	Matte Black	3						
		UTS232104EPORB	1558.80	Oil Rubbed Bronze	3						
M-CORE® 2-SERIES SHOWER ONLY TRIM – PREMIUM											
 <ul style="list-style-type: none"> • showerhead: two-function eco-performance rainshower • showerhead size: 9" diameter • includes: pressure balanced cartridge with temperature control • valve: sold separately 		1.75 GPM (6.65 L/min) max.									
		UTS232102EP	897.25	Chrome	3						
		UTS232102EPBN	1256.80	Brushed Nickel	3						
		UTS232102EPNL	1256.80	Polished Nickel	3						
		UTS232102EPBG	1256.80	Brushed Gold	3						
		UTS232102EPBL	1346.60	Matte Black	3						
		UTS232102EPORB	1346.60	Oil Rubbed Bronze	3						
M-CORE® 2-SERIES VALVE ONLY TRIM – PREMIUM											
 <ul style="list-style-type: none"> • includes: pressure balanced cartridge with temperature control • valve: sold separately 		UTS23210	525.10	Chrome	3						
		UTS23210BN	695.15	Brushed Nickel	3						
		UTS23210NL	695.15	Polished Nickel	3						
		UTS23210BG	695.15	Brushed Gold	3						
		UTS23210BL	741.05	Matte Black	3						
		UTS23210ORB	741.05	Oil Rubbed Bronze	3						
	M-CORE® MIXING SHOWER VALVE										
 <ul style="list-style-type: none"> • tub/shower or shower only application • ports: four with adj. temp. limit stops • included: test plug and cross flow plug 		U140CI	72.60	1/2" CC/IPS	6						
		U140X	72.60	1/2" Crimp Ring PEX + CC/IPS Tub	6						
		U140CX	72.60	1/2" Cold Exp. PEX + CC/IPS Tub	6						
		U140V	88.95	1/2" CPVC + CC/IPS Tub	6						
	 <ul style="list-style-type: none"> • tub/shower or shower only application • ports: four with adj. temp. limit stops • quarter turn stops: included 		U140CIS	104.50	1/2" CC/IPS	6					
		U140XS	104.50	1/2" Crimp Ring PEX + CC/IPS Tub	6						
		U140CXS	104.50	1/2" Cold Exp. PEX + CC/IPS Tub	6						
		U140VS	120.85	1/2" CPVC + CC/IPS Tub	6						
 <ul style="list-style-type: none"> • shower only application • ports: three 			U130CI	72.60	1/2" CC/IPS	6					
		U130X	72.60	1/2" Crimp Ring PEX	6						
		U130CX	72.60	1/2" Cold Exp. PEX	6						
 <ul style="list-style-type: none"> • shower only application • ports: three • quarter turn stops: included 		U130CIS	104.50	1/2" CC/IPS	6						
		U130XS	104.50	1/2" Crimp Ring PEX	6						
		U130CXS	104.50	1/2" Cold Exp. PEX	6						
<p>Four port valves can be used with either Tub/Shower or Shower Only applications. Three port valves can ONLY be used with Shower Only applications. For more product details, reference page 471 in valve section.</p>											
<p>HOW TO ORDER VALVES: PAGE 471</p>		 <p>TRIM PART #</p>				<p>+</p>	 <p>VALVE PART #</p>		<p>=</p>	 <p>COMPLETE FAUCET</p>	











WEYMOUTH®

















MODEL LIST FINISH/CONNECT CASE QTY

POSI-TEMP® TUB/SHOWER TRIM - PREMIUM						
 <ul style="list-style-type: none"> • showerhead: two-function rainshower • showerhead size: 9" diameter • tub spout length: 6 3/4" • tub spout connection type: slip fit • tub spout type: diverter • valve: sold separately 	2.5 GPM (9.5 L/min) max.					
	TS32104	953.80	Chrome	3		
	TS32104BN	1338.15	Brushed Nickel	3		
	TS32104NL	1338.15	Polished Nickel	3		
	TS32104BG	1338.15	Brushed Gold	3		
	TS32104BL	1443.75	Matte Black	3		
	TS32104ORB	1443.75	Oil Rubbed Bronze	3		
	1.75 GPM (6.65 L/min) max.					
	TS32104EP	953.80	Chrome	3		
	TS32104EPBN	1338.15	Brushed Nickel	3		
	TS32104EPNL	1338.15	Polished Nickel	3		
	TS32104EPBG	1338.15	Brushed Gold	3		
	TS32104EPBL	1443.75	Matte Black	3		
	TS32104EPORB	1443.75	Oil Rubbed Bronze	3		
POSI-TEMP® SHOWER ONLY TRIM - PREMIUM						
 <ul style="list-style-type: none"> • showerhead: two-function rainshower • showerhead size: 9" diameter • valve: sold separately 	2.5 GPM (9.5 L/min) max.					
	TS32102	782.20	Chrome	3		
	TS32102BN	1141.70	Brushed Nickel	3		
	TS32102NL	1141.70	Polished Nickel	3		
	TS32102BG	1141.70	Brushed Gold	3		
	TS32102BL	1231.60	Matte Black	3		
	TS32102ORB	1231.60	Oil Rubbed Bronze	3		
	1.75 GPM (6.65 L/min) max.					
	TS32102EP	782.20	Chrome	3		
	TS32102EPBN	1141.70	Brushed Nickel	3		
	TS32102EPNL	1141.70	Polished Nickel	3		
	TS32102EPBG	1141.70	Brushed Gold	3		
	TS32102EPBL	1231.60	Matte Black	3		
	TS32102EPORB	1231.60	Oil Rubbed Bronze	3		
POSI-TEMP® SHOWER MIXING VALVES						
 <ul style="list-style-type: none"> • tub/shower or shower only application • ports: four with adjustable temp. limit stops • test plug: included 	2520 ◆	159.20	1/2" CC	6		
	2510 ◆	159.20	1/2" IPS	6		
 <ul style="list-style-type: none"> • tub/shower or shower only application • ports: four with adjustable temp. limit stops • quarter turn stops: included • test plug: included 	2570 ◆	193.35	1/2" CC	6		
	2590 ◆	193.35	1/2" IPS	6		
	2580 ◆	159.20	1/2" Crimp ring PEX	6		
 <ul style="list-style-type: none"> • tub/shower only application • ports: four with adjustable temp. limit stops • quarter turn stops: included • test plug: included 	2360PF	212.60	1/2" Crimp Ring PEX	3		
 <ul style="list-style-type: none"> • shower only application • ports: three with adjustable temp. limit stops • quarter turn stops: included • test plug: included 	2326PF	205.20	1/2" Crimp Ring PEX	6		
	2328PF	205.20	1/2" Cold Exp. PEX	6		
<p>Four port valves can be used with either Tub/Shower or Shower Only applications. Three port valves can ONLY be used with Shower Only applications. For more product details, reference page 473-476 in valve section.</p>						
<p>HOW TO ORDER VALVES: PAGES 473-476</p>		 <p>TRIM PART #</p>	+	 <p>VALVE PART #</p>	=	 <p>COMPLETE FAUCET</p>
OPTION: HANDLE CAP KIT						
 <ul style="list-style-type: none"> • description: finished handle cap kit • language: english version only 	221672	27.50	Chrome	12		
	221672BN	36.50	Brushed Nickel	12		
	221672NL	36.50	Polished Nickel	12		
	221672BG	36.50	Brushed Gold	12		
	221672BL	40.40	Matte Black	12		
	221672ORB	40.40	Oil Rubbed Bronze	12		



WEYMOUTH® Collection

		MODEL	LIST	FINISH/CONNECT	CASE QTY	
POSI-TEMP® VALVE ONLY TRIM - PREMIUM						
 <ul style="list-style-type: none"> • valve: sold separately 	 	TS3210	410.15	Chrome	3	
		TS3210BN	580.15	Brushed Nickel	3	
		TS3210NL	580.15	Polished Nickel	3	
		TS3210BG	580.15	Brushed Gold	3	
		TS3210BL	626.10	Matte Black	3	
		TS3210ORB	626.10	Oil Rubbed Bronze	3	
POSI-TEMP® SHOWER MIXING VALVES						
 <ul style="list-style-type: none"> • tub/shower or shower only application • ports: four with adjustable temp. limit stops • test plug: included 		2520 ◆	159.20	1/2" CC	6	
		2510 ◆	159.20	1/2" IPS	6	
 <ul style="list-style-type: none"> • tub/shower or shower only application • ports: four with adjustable temp. limit stops • quarter turn stops: included • test plug: included 		2570 ◆	193.35	1/2" CC	6	
		2590 ◆	193.35	1/2" IPS	6	
		2580 ◆	159.20	1/2" Crimp ring PEX	6	
 <ul style="list-style-type: none"> • tub/shower only application • ports: four with adjustable temp. limit stops • quarter turn stops: included • test plug: included 		2360PF	212.60	1/2" Crimp Ring PEX	3	
 <ul style="list-style-type: none"> • shower only application • ports: three with adjustable temp. limit stops • quarter turn stops: included • test plug: included 		2326PF	205.20	1/2" Crimp Ring PEX	6	
		2328PF	205.20	1/2" Cold Exp. PEX	6	
<p>Four port valves can be used with either Tub/Shower or Shower Only applications. Three port valves can ONLY be used with Shower Only applications. For more product details, reference page 473-476 in valve section.</p>						
<p>HOW TO ORDER VALVES: PAGES 473-476</p>		 <p>TRIM PART #</p>	+	 <p>VALVE PART #</p>	=	 <p>COMPLETE FAUCET</p>
OPTION: HANDLE CAP KIT						
 <ul style="list-style-type: none"> • description: finished handle cap kit • language: english version only 		221672	27.50	Chrome	12	
		221672BN	36.50	Brushed Nickel	12	
		221672NL	36.50	Polished Nickel	12	
		221672BG	36.50	Brushed Gold	12	
		221672BL	40.40	Matte Black	12	
		221672ORB	40.40	Oil Rubbed Bronze	12	
OPTION: ARROW CAP KIT						
 <ul style="list-style-type: none"> • description: finished arrow cap kit 		221673	18.60	Chrome	12	
		221673BN	24.85	Brushed Nickel	12	
		221673NL	24.85	Polished Nickel	12	
		221673BG	24.85	Brushed Gold	12	
		221673BL	27.40	Matte Black	12	
		221673ORB	27.40	Oil Rubbed Bronze	12	

		MODEL	LIST	FINISH/CONNECT	CASE QTY	
POSI-TEMP® WITH INTEGRATED TRANSFER VALVE TRIM - PREMIUM						
 <ul style="list-style-type: none"> valve: sold separately 	 	TS32100	879.40	Chrome	4	
		TS32100BN	1243.55	Brushed Nickel	4	
		TS32100NL	1243.55	Polished Nickel	4	
		TS32100BG	1243.55	Brushed Gold	4	
		TS32100BL	1342.00	Matte Black	4	
		TS32100ORB	1342.00	Oil Rubbed Bronze	4	
POSI-TEMP® WITH INTEGRATED TRANSFER VALVE						
 <ul style="list-style-type: none"> functions: three (two independent and one shared) ports: four with adjustable temp. limit stops test plug: included 		2551	287.50	1/2" IPS	6	
 <ul style="list-style-type: none"> functions: three (two independent and one shared) ports: four with adjustable temp. limit stops stops: included test plug: included 		2581	323.75	1/2" IPS	6	
 <ul style="list-style-type: none"> functions: two independent ports: four with adjustable temp. limit stops test plug: included 		2521	287.50	1/2" IPS	6	
 <ul style="list-style-type: none"> functions: two independent ports: four with adjustable temp. limit stops stops: included test plug: included 		2571	323.75	1/2" IPS	6	
For more product details, reference page 477 in valve section.						
HOW TO ORDER VALVES: PAGE 477		 TRIM PART #	+	 VALVE PART #	=	 COMPLETE FAUCET
OPTION: HANDLE CAP KIT						
 <ul style="list-style-type: none"> description: finished handle cap kit language: english version only 		221672	27.50	Chrome	12	
		221672BN	36.50	Brushed Nickel	12	
		221672NL	36.50	Polished Nickel	12	
		221672BG	36.50	Brushed Gold	12	
		221672BL	40.40	Matte Black	12	
		221672ORB	40.40	Oil Rubbed Bronze	12	
OPTION: ARROW CAP KIT						
 <ul style="list-style-type: none"> description: finished arrow cap kit 		221673	18.60	Chrome	12	
		221673BN	24.85	Brushed Nickel	12	
		221673NL	24.85	Polished Nickel	12	
		221673BG	24.85	Brushed Gold	12	
		221673BL	27.40	Matte Black	12	
		221673ORB	27.40	Oil Rubbed Bronze	12	



WEYMOUTH® Matching Bath Accessories**Moen® bath accessories CANNOT be combined with Moen faucet parts on a Purchase Order.**

A line of matching accessories - including tank levers and towel bars - allow for a completely cohesive look in the bath.

MODEL NUMBER	LIST EACH	DESCRIPTION	QTY
PREMIUM			
Chrome (CH)			
YB8401CH	135.65	Tank Lever	24
YB8403CH	123.20	Double Robe Hook	24
YB8405CH	22.80	Drawer Knob	48
YB8407CH	42.60	Drawer Pull	48
Ⓢ YB8408CH	177.90	Pivoting Paper Holder	6
YB8418CH	200.80	18" Towel Bar	6
YB8424CH	216.65	24" Towel Bar	6
YB8486CH	140.00	Towel Ring	6
Brushed Nickel (BN)			
YB8401BN	154.50	Tank Lever	24
YB8403BN	141.00	Double Robe Hook	24
YB8405BN	25.75	Drawer Knob	48
YB8407BN	45.50	Drawer Pull	48
Ⓢ YB8408BN	194.90	Pivoting Paper Holder	6
YB8418BN	228.05	18" Towel Bar	6
YB8424BN	246.00	24" Towel Bar	6
YB8486BN	159.80	Towel Ring	6
Matte Black (BL)			
YB8401BL	169.70	Tank Lever	24
YB8403BL	155.00	Double Robe Hook	24
YB8405BL	28.30	Drawer Knob	48
YB8407BL	49.85	Drawer Pull	48
Ⓢ YB8408BL	214.10	Pivoting Paper Holder	6
YB8418BL	250.65	18" Towel Bar	6
YB8424BL	270.05	24" Towel Bar	6
YB8486BL	175.60	Towel Ring	6
Polished Nickel (NL)			
YB8401NL	169.95	Tank Lever	24
YB8403NL	155.20	Double Robe Hook	24
YB8405NL	28.30	Drawer Knob	48
YB8407NL	50.05	Drawer Pull	48
Ⓢ YB8408NL	214.50	Pivoting Paper Holder	6
YB8418NL	251.05	18" Towel Bar	6
YB8424NL	270.45	24" Towel Bar	6
YB8486NL	175.80	Towel Ring	6
Brushed Gold (BG)			
YB8401BG	185.45	Tank Lever	24
YB8403BG	169.15	Double Robe Hook	24
YB8405BG	30.90	Drawer Knob	48
YB8407BG	54.60	Drawer Pull	48
Ⓢ YB8408BG	234.00	Pivoting Paper Holder	6
YB8418BG	273.60	18" Towel Bar	6
YB8424BG	295.00	24" Towel Bar	6
YB8486BG	191.80	Towel Ring	6
Oil Rubbed Bronze (ORB)			
YB8401ORB	169.95	Tank Lever	24
YB8403ORB	155.20	Double Robe Hook	24
YB8405ORB	28.30	Drawer Knob	48
YB8407ORB	50.05	Drawer Pull	48
Ⓢ YB8408ORB	214.50	Pivoting Paper Holder	6
YB8418ORB	251.05	18" Towel Bar	6
YB8424ORB	270.45	24" Towel Bar	6
YB8486ORB	175.80	Towel Ring	6

Ⓢ Denotes pivoting paper holder



Tank Lever
YB8401



Double Robe Hook
YB8403



Towel Ring
YB8486



Pivoting Paper Holder
YB8408 | Ⓢ



Drawer Knob
YB8405



18" Towel Bar
YB8418































Drawer Pull
YB8407





















24" Towel Bar
YB8424









List price is per each (unless otherwise noted).
Product can be ordered by case quantity or individually.

	MODEL	LIST	FINISH/CONNECT	CASE QTY
ONE-HANDLE BATHROOM FAUCET - PREMIUM				
 <ul style="list-style-type: none"> • application: one hole • supply lines: flexible • connection: 3/8" compression • drain assembly: metal • drain assembly type: spring loaded pop-up <p> DURALAST®</p>	<p> 1.2 GPM (4.5L/min) max.</p>			
	S43001	712.15	Chrome	3
	S43001BL	1032.60	Matte Black	3
TWO-HANDLE WIDESPREAD BATHROOM FAUCET TRIM - PREMIUM				
 <ul style="list-style-type: none"> • application: three hole • center dimensions: 8" - 16" center • drain assembly: metal with lift rod • valve: sold separately <p> </p>	<p> 1.2 GPM (4.5L/min) max.</p>			
	TS43002	771.00	Chrome	3
	TS43002BL	1156.50	Matte Black	3
WIDESPREAD FAUCET VALVE				
 <ul style="list-style-type: none"> • application: three hole • center dimensions: 8" - 16" center • drain assembly: metal with lift rod <p> DURALOCK® DURALAST®</p>	9000◆	165.40	1/2" IPS	6
<p>HOW TO ORDER VALVES: PAGE 469</p> <p>  TRIM PART # +  VALVE PART # =  COMPLETE FAUCET </p>				
TWO-HANDLE WALLMOUNT BATHROOM FAUCET TRIM - PREMIUM				
 <ul style="list-style-type: none"> • application: three hole • center dimensions: 8" center • drain assembly: 140780 sold separately • valve: sold separately <p> </p>	<p> 1.2 GPM (4.5L/min) max.</p>			
	TS43003	789.10	Chrome	3
	TS43003BL	1183.65	Matte Black	3
TWO-HANDLE WALLMOUNT FAUCET VALVE				
 <ul style="list-style-type: none"> • application: three hole • center dimensions: 8" center • drain assembly: 140780 sold separately • includes: mounting brackets <p> DURALAST®</p>	9700	233.95	1/2" CC	3
<p>HOW TO ORDER VALVES: PAGE 469</p> <p>  TRIM PART # +  VALVE PART # =  COMPLETE FAUCET </p>				
OPTION: DRAIN ASSEMBLY				
 <ul style="list-style-type: none"> • drain assembly: metal • drain assembly type: spring loaded pop-up • drain assembly size: 1-1/4" • drain assembly: 1-1/4" non-overflow 	140780	78.35	Chrome	12
	140780BL	123.30	Matte Black	12













		MODEL	LIST	FINISH/CONNECT	CASE QTY			
FREESTANDING TUB FILLER TRIM - PREMIUM								
	<ul style="list-style-type: none"> • application: one hole • showerhead type: handshower • handshower functions: one-function • handshower flow rate: 1.75 gpm (6.65 L/min) max. • spout reach: 11.00" • mounting kit: sold separately 	S93005	2291.55	Chrome	1			
		S93005BL	3032.90	Matte Black	1			
FREESTANDING TUB FILLER VALVE AND MOUNTING KIT - PREMIUM								
	<ul style="list-style-type: none"> • description: single riser floor joist mounting kit • application: one hole • quarter turn stops: included 	TS50100	408.90	1/2" CC, NPT	2			
	<ul style="list-style-type: none"> • description: single riser concrete mounting kit • application: one hole • connection size: 1/2" 	TS50110	332.45	1/2" CC, NPT	2			
HOW TO ORDER VALVES: PAGE 469		TRIM PART #	+		VALVE PART #	=		COMPLETE FAUCET

TWO-HANDLE ROMAN TUB TRIM - PREMIUM								
	<ul style="list-style-type: none"> • application: three hole • spout reach: 8.08" • valve: sold separately 	TS93003	1024.30	Chrome	3			
		TS93003BL	1629.50	Matte Black	3			
TWO-HANDLE ROMAN TUB TRIM WITH HANDSHOWER - PREMIUM								
	<ul style="list-style-type: none"> • application: four hole • showerhead type: handshower • handshower flow rate: 1.75 gpm (6.65 L/min) max. • spray functions: one-function • spout reach: 8.08" • valve: sold separately 	TS93004	1564.00	Chrome	3			
		TS93004BL	3068.20	Matte Black	3			
TWO-HANDLE ROMAN TUB VALVE								
	<ul style="list-style-type: none"> • deck thickness: 1/8" to 3-3/8" rough-in deck • adjustable spout shank: adjustable center dimensions 	4792	192.30	1/2" CC	6			
	<ul style="list-style-type: none"> • deck thickness: 1/8" to 2-3/4" rough-in deck • adjustable spout shank: 10" - 24" center dimensions 	DURALOCK® DURALAST®						
		4793	217.80	1/2" CPVC, Crimp Ring PEX	6			
	<ul style="list-style-type: none"> • deck thickness: 1/8" to 3-3/16" rough-in deck • Non-adjustable spout shank: 10" center dimensions 	DURALOCK® DURALAST®						
		4796	181.20	1/2" CC	6			
		4797	184.70	1/2" CPVC, Crimp Ring PEX	6			
		4798	184.70	1/2" Crimp Ring PEX, Cold Exp. PEX	6			
TWO-HANDLE ROMAN TUB VALVE WITH HANDSHOWER								
	<ul style="list-style-type: none"> • deck thickness: 1/8" to 2-5/8" rough-in deck • non-adj spout shank: adjustable center dim's 	9792	433.35	1/2" CC	6			
	<ul style="list-style-type: none"> • deck thickness: 1/8" to 2-5/8" rough-in deck • adj spout shank: 10" - 24" center dimensions 	DURALOCK® DURALAST®						
		9793	443.50	1/2" CPVC, Crimp Ring PEX	6			
For more product details, reference page 470 in valve section.								
HOW TO ORDER VALVES: PAGE 470		TRIM PART #	+		VALVE PART #	=		COMPLETE FAUCET











		MODEL	LIST	FINISH/CONNECT	CASE QTY	
EXACTTEMP® VALVE ONLY TRIM - PREMIUM						
 <ul style="list-style-type: none"> • description: temperature control valve trim • requires: separate volume control valve • valve: sold separately  		TS33002	407.80	Chrome	3	
		TS33002BL	673.00	Matte Black	3	
EXACTTEMP® THERMOSTATIC MIXING SHOWER VALVE - PREMIUM						
 <ul style="list-style-type: none"> • description: thermostatic rough-in valve • ports: four with adjustable temp. limit stops • check stops: included 		S3371	728.95	¾" IPS	6	
HOW TO ORDER VALVES: PAGE 471		 TRIM PART #	+	 VALVE PART #	=	 COMPLETE FAUCET









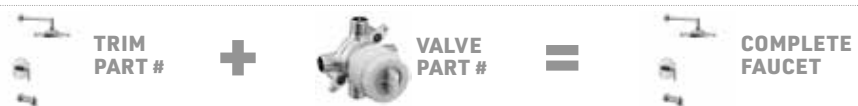

EXACTTEMP® VOLUME CONTROL VALVE TRIM - PREMIUM						
 <ul style="list-style-type: none"> • valve: sold separately  		TS33003	232.95	Chrome	6	
		TS33003BL	373.95	Matte Black	6	
EXACTTEMP® VOLUME CONTROL SHOWER VALVE - PREMIUM						
 <ul style="list-style-type: none"> • includes: volume control 		S3600	185.35	¾" IPS	12	
HOW TO ORDER VALVES: PAGE 471		 TRIM PART #	+	 VALVE PART #	=	 COMPLETE FAUCET



























		MODEL	LIST	FINISH/CONNECT	CASE QTY	
M-CORE® 4-SERIES TUB/SHOWER TRIM – PREMIUM						
 <ul style="list-style-type: none"> • showerhead type: eco-performance rainshower • showerhead size: 10" diameter • tub spout length: 6 3/4" • tub spout connection type: slip fit • tub spout type: diverter • includes: thermostatic cartridge with volume and temperature control • valve: sold separately 		1.75 GPM (6.65 L/min) max.				
		UTS42003EP	1164.15	Chrome	3	
		UTS42003EPBL	1746.70	Matte Black	3	
						
M-CORE® 4-SERIES SHOWER ONLY TRIM – PREMIUM						
 <ul style="list-style-type: none"> • showerhead type: eco-performance rainshower • showerhead size: 10" diameter • includes: thermostatic cartridge with volume and temperature control • valve: sold separately 		1.75 GPM (6.65 L/min) max.				
		UTS42002EP	1044.15	Chrome	3	
		UTS42002EPBL	1541.25	Matte Black	3	
						
M-CORE® 4-SERIES VALVE ONLY TRIM – PREMIUM						
 <ul style="list-style-type: none"> • includes: thermostatic cartridge with volume and temperature control • valve: sold separately 		UTS42001	716.65	Chrome	3	
		UTS42001BL	963.05	Matte Black	3	
						
M-CORE® MIXING SHOWER VALVE						
 <ul style="list-style-type: none"> • tub/shower or shower only application • ports: four with adj. temp. limit stops • included: test plug and cross flow plug 		U140CI	72.60	1/2" CC/IPS	6	
		U140X	72.60	1/2" Crimp Ring PEX + CC/IPS Tub	6	
		U140CX	72.60	1/2" Cold Exp. PEX + CC/IPS Tub	6	
		U140V	88.95	1/2" CPVC + CC/IPS Tub	6	
 <ul style="list-style-type: none"> • tub/shower or shower only application • ports: four with adj. temp. limit stops • quarter turn stops: included 		U140CIS	104.50	1/2" CC/IPS	6	
		U140XS	104.50	1/2" Crimp Ring PEX + CC/IPS Tub	6	
		U140CXS	104.50	1/2" Cold Exp. PEX + CC/IPS Tub	6	
		U140VS	120.85	1/2" CPVC + CC/IPS Tub	6	
 <ul style="list-style-type: none"> • shower only application • ports: three 		U130CI	72.60	1/2" CC/IPS	6	
		U130X	72.60	1/2" Crimp Ring PEX	6	
		U130CX	72.60	1/2" Cold Exp. PEX	6	
 <ul style="list-style-type: none"> • shower only application • ports: three • quarter turn stops: included 		U130CIS	104.50	1/2" CC/IPS	6	
		U130XS	104.50	1/2" Crimp Ring PEX	6	
		U130CXS	104.50	1/2" Cold Exp. PEX	6	
<p>Four port valves can be used with either Tub/Shower or Shower Only applications. Three port valves can ONLY be used with Shower Only applications. For more product details, reference page 471 in valve section.</p>						
HOW TO ORDER VALVES: PAGE 471		 TRIM PART #	+	 VALVE PART #	=	 COMPLETE FAUCET

MODEL LIST FINISH/CONNECT CASE QTY

















M-CORE® 3-SERIES TUB/SHOWER TRIM – PREMIUM				
 <ul style="list-style-type: none"> • showerhead: single-function rainshower • showerhead size: 10" diameter • tub spout length: 6 3/4" • tub spout connection type: slip fit • tub spout type: diverter • includes: pressure balanced cartridge with volume and temperature control • valve: sold separately 	<p>2.5 GPM (9.5 L/min) max.</p>			
	UTS32003	1026.45	Chrome	3
	UTS32003BL	1609.00	Matte Black	4
	<p>1.75 GPM (6.65 L/min) max.</p>			
	UTS32003EP	1026.45	Chrome	3
	UTS32003EPBL	1609.00	Matte Black	3
<p> IMMERSION®</p>				
M-CORE® 3-SERIES SHOWER ONLY TRIM – PREMIUM				
 <ul style="list-style-type: none"> • showerhead: single-function rainshower • showerhead size: 10" diameter • includes: pressure balanced cartridge with volume and temperature control • valve: sold separately 	<p>2.5 GPM (9.5 L/min) max.</p>			
	UTS32002	906.45	Chrome	3
	UTS32002BL	1403.55	Matte Black	3
	<p>1.75 GPM (6.65 L/min) max.</p>			
	UTS32002EP	906.45	Chrome	3
	UTS32002EPBL	1403.55	Matte Black	3
<p> IMMERSION®</p>				
M-CORE® 3-SERIES VALVE ONLY TRIM – PREMIUM				
 <ul style="list-style-type: none"> • includes: pressure balanced cartridge with volume and temperature control • valve: sold separately 	UTS32001	578.95	Chrome	3
	UTS32001BL	825.35	Matte Black	3
<p></p>				
M-CORE® MIXING SHOWER VALVE				
 <ul style="list-style-type: none"> • tub/shower or shower only application • ports: four with adj. temp. limit stops • included: test plug and cross flow plug 	U140CI	72.60	1/2" CC/IPS	6
	U140X	72.60	1/2" Crimp Ring PEX + CC/IPS Tub	6
	U140CX	72.60	1/2" Cold Exp. PEX + CC/IPS Tub	6
	U140V	88.95	1/2" CPVC + CC/IPS Tub	6
 <ul style="list-style-type: none"> • tub/shower or shower only application • ports: four with adj. temp. limit stops • quarter turn stops: included 	U140CIS	104.50	1/2" CC/IPS	6
	U140XS	104.50	1/2" Crimp Ring PEX + CC/IPS Tub	6
	U140CXS	104.50	1/2" Cold Exp. PEX + CC/IPS Tub	6
	U140VS	120.85	1/2" CPVC + CC/IPS Tub	6
 <ul style="list-style-type: none"> • shower only application • ports: three 	U130CI	72.60	1/2" CC/IPS	6
	U130X	72.60	1/2" Crimp Ring PEX	6
	U130CX	72.60	1/2" Cold Exp. PEX	6
 <ul style="list-style-type: none"> • shower only application • ports: three • quarter turn stops: included 	U130CIS	104.50	1/2" CC/IPS	6
	U130XS	104.50	1/2" Crimp Ring PEX	6
	U130CXS	104.50	1/2" Cold Exp. PEX	6
<p></p>				
<p>Four port valves can be used with either Tub/Shower or Shower Only applications. Three port valves can ONLY be used with Shower Only applications. For more product details, reference page 471 in valve section.</p>				
<p>HOW TO ORDER VALVES: PAGE 471</p>				















		MODEL	LIST	FINISH/CONNECT	CASE QTY			
M-CORE® 3-SERIES WITH INTEGRATED TRANSFER VALVE TRIM - PREMIUM								
	<ul style="list-style-type: none"> includes: pressure balanced cartridge with volume and temperature control valve: sold separately  	UTS3311	513.15	Chrome	4			
		UTS3311BL	1116.85	Matte Black	4			
M-CORE® WITH INTEGRATED TRANSFER VALVE								
Three Function (2 independent/1 shared) OR Six Function (3 independent/3 shared) - plumbing configuration page 478								
	<ul style="list-style-type: none"> ports: four with adj. temp. limit stops check stops: included 	U362CIS	270.70	1/2" CC/IPS	6			
		U362CXS	270.70	1/2" Cold Exp. PEX	6			
		U362XS	270.70	1/2" Crimp Ring PEX	6			
Two Independent Functions OR Three Independent Functions - plumbing configurations page 478								
	<ul style="list-style-type: none"> ports: four with adj. temp. limit stops check stops: included 	U232CIS	270.70	1/2" CC/IPS	6			
		U232CXS	270.70	1/2" Cold Exp. PEX	6			
		U232XS	270.70	1/2" Crimp Ring PEX	6			
For more product details, reference page 472 in valve section. See page 478 for plumbing configurations.								
HOW TO ORDER VALVES: PAGE 472		TRIM PART #	+		VALVE PART #	=		COMPLETE FAUCET

M-CORE® TRANSFER VALVE TRIM - PREMIUM								
	<ul style="list-style-type: none"> use with the M-CORE® transfer valve valve: sold separately  	UTS23005	442.90	Chrome	12			
		UTS23005BL	568.85	Matte Black	12			
M-CORE® TRANSFER VALVE								
Three Function (2 independent/1 shared) OR Six Function (3 independent/3 shared) - plumbing configuration page 478								
	<ul style="list-style-type: none"> number of functions: three or six ports: four 	U361CI	152.70	1/2" CC/IPS	6			
		U361CX	152.70	1/2" Cold Exp. PEX	6			
		U361X	152.70	1/2" Crimp Ring PEX	6			
Two Independent Functions OR Three Independent Functions - plumbing configurations page 478								
	<ul style="list-style-type: none"> number of functions: two or three ports: four 	U231CI	152.70	1/2" CC/IPS	6			
		U231CX	152.70	1/2" Cold Exp. PEX	6			
		U231X	152.70	1/2" Crimp Ring PEX	6			
For more product details, reference page 472 in valve section. See page 478 for plumbing configurations.								
HOW TO ORDER VALVES: PAGE 472		TRIM PART #	+		VALVE PART #	=		COMPLETE FAUCET

		MODEL	LIST	FINISH/CONNECT	CASE QTY	
M-CORE® 2-SERIES TUB/SHOWER TRIM – PREMIUM						
 <ul style="list-style-type: none"> • showerhead: single-function eco-performance rainshower • showerhead size: 10" diameter • tub spout length: 6 3/4" • tub spout connection type: slip fit • tub spout type: diverter • includes: pressure balanced cartridge with temperature control • valve: sold separately 	<ul style="list-style-type: none"> • 1.75 GPM (6.65 L/min) max. 					
	<ul style="list-style-type: none"> • UTS22003EP 1004.35 Chrome 3 • UTS22003EPBL 1534.15 Matte Black 3 					
M-CORE® 2-SERIES SHOWER ONLY TRIM – PREMIUM						
 <ul style="list-style-type: none"> • showerhead: single-function eco-performance rainshower • showerhead size: 10" diameter • includes: pressure balanced cartridge with temperature control • valve: sold separately 	<ul style="list-style-type: none"> • 1.75 GPM (6.65 L/min) max. 					
	<ul style="list-style-type: none"> • UTS22002EP 857.85 Chrome 3 • UTS22002EPBL 1308.40 Matte Black 3 					
M-CORE® 2-SERIES VALVE ONLY TRIM – PREMIUM						
 <ul style="list-style-type: none"> • includes: pressure balanced cartridge with temperature control • valve: sold separately 						
	<ul style="list-style-type: none"> • UTS22001 496.20 Chrome 3 • UTS22001BL 738.55 Matte Black 3 					
M-CORE® MIXING SHOWER VALVE						
 <ul style="list-style-type: none"> • tub/shower or shower only application • ports: four with adj. temp. limit stops • included: test plug and cross flow plug 						
	<ul style="list-style-type: none"> • U140CI 72.60 1/2" CC/IPS 6 • U140X 72.60 1/2" Crimp Ring PEX + CC/IPS Tub 6 • U140CX 72.60 1/2" Cold Exp. PEX + CC/IPS Tub 6 • U140V 88.95 1/2" CPVC + CC/IPS Tub 6 					
	 <ul style="list-style-type: none"> • tub/shower or shower only application • ports: four with adj. temp. limit stops • quarter turn stops: included 					
		<ul style="list-style-type: none"> • U140CIS 104.50 1/2" CC/IPS 6 • U140XS 104.50 1/2" Crimp Ring PEX + CC/IPS Tub 6 • U140CXS 104.50 1/2" Cold Exp. PEX + CC/IPS Tub 6 • U140VS 120.85 1/2" CPVC + CC/IPS Tub 6 				
 <ul style="list-style-type: none"> • shower only application • ports: three 						
	<ul style="list-style-type: none"> • U130CI 72.60 1/2" CC/IPS 6 • U130X 72.60 1/2" Crimp Ring PEX 6 • U130CX 72.60 1/2" Cold Exp. PEX 6 					
	 <ul style="list-style-type: none"> • shower only application • ports: three • quarter turn stops: included 					
<ul style="list-style-type: none"> • U130CIS 104.50 1/2" CC/IPS 6 • U130XS 104.50 1/2" Crimp Ring PEX 6 • U130CXS 104.50 1/2" Cold Exp. PEX 6 						
<p>Four port valves can be used with either Tub/Shower or Shower Only applications. Three port valves can ONLY be used with Shower Only applications. For more product details, reference page 471 in valve section.</p>						
<p>HOW TO ORDER VALVES: PAGE 471</p>						



		MODEL	LIST	FINISH/CONNECT	CASE QTY	
POSI-TEMP® TUB/SHOWER TRIM - PREMIUM						
 <ul style="list-style-type: none"> • showerhead: single-function rainshower • showerhead size: 10" diameter • tub spout length: 6 3/4" • tub spout connection type: slip fit • tub spout type: diverter • valve: sold separately 		2.5 GPM (9.5 L/min) max.				
		TS22003	889.35	Chrome	3	
		TS22003BL	1419.15	Matte Black	3	
		1.75 GPM (6.65 L/min) max.				
		TS22003EP	889.35	Chrome	3	
		TS22003EPBL	1419.15	Matte Black	3	
POSI-TEMP® SHOWER ONLY TRIM - PREMIUM						
 <ul style="list-style-type: none"> • showerhead: single-function rainshower • showerhead size: 10" diameter • valve: sold separately 		2.5 GPM (9.5 L/min) max.				
		TS22002	742.85	Chrome	3	
		TS22002BL	1193.40	Matte Black	3	
		1.75 GPM (6.65 L/min) max.				
		TS22002EP	742.85	Chrome	3	
		TS22002EPBL	1193.40	Matte Black	3	
POSI-TEMP® VALVE ONLY TRIM - PREMIUM						
 <ul style="list-style-type: none"> • valve: sold separately 		TS22001	381.15	Chrome	3	
		TS22001BL	623.60	Matte Black	3	
POSI-TEMP® SHOWER MIXING VALVES						
 <ul style="list-style-type: none"> • tub/shower or shower only application • ports: four with adjustable temp. limit stops • test plug: included 		2520 ◆	159.20	1/2" CC	6	
		2510 ◆	159.20	1/2" IPS	6	
 <ul style="list-style-type: none"> • tub/shower or shower only application • ports: four with adjustable temp. limit stops • quarter turn stops: included • test plug: included 		2570 ◆	193.35	1/2" CC	6	
		2590 ◆	193.35	1/2" IPS	6	
		2580 ◆	159.20	1/2" Crimp ring PEX	6	
 <ul style="list-style-type: none"> • tub/shower only application • ports: four with adjustable temp. limit stops • quarter turn stops: included • test plug: included 		2360PF	212.60	1/2" Crimp Ring PEX	3	
 <ul style="list-style-type: none"> • shower only application • ports: three with adjustable temp. limit stops • quarter turn stops: included • test plug: included 		2326PF	205.20	1/2" Crimp Ring PEX	6	
		2328PF	205.20	1/2" Cold Exp. PEX	6	
<p>Four port valves can be used with either Tub/Shower or Shower Only applications. Three port valves can ONLY be used with Shower Only applications. For more product details, reference page 473-476 in valve section.</p>						
HOW TO ORDER VALVES: PAGES 473-476		 TRIM PART #	+	 VALVE PART #	=	 COMPLETE FAUCET

		MODEL	LIST	FINISH/CONNECT	CASE QTY	
POSI-TEMP® WITH INTEGRATED TRANSFER VALVE TRIM - PREMIUM						
	<ul style="list-style-type: none"> valve: sold separately  	TS22000	817.40	Chrome	4	
		TS22000BL	1336.80	Matte Black	4	
POSI-TEMP® WITH INTEGRATED TRANSFER VALVE						
	<ul style="list-style-type: none"> functions: three (two independent and one shared) ports: four with adjustable temp. limit stops test plug: included 	2551	287.50	1/2" IPS	6	
	<ul style="list-style-type: none"> functions: three (two independent and one shared) ports: four with adjustable temp. limit stops stops: included test plug: included 	2581	323.75	1/2" IPS	6	
	<ul style="list-style-type: none"> functions: two independent ports: four with adjustable temp. limit stops test plug: included 	2521	287.50	1/2" IPS	6	
	<ul style="list-style-type: none"> functions: two independent ports: four with adjustable temp. limit stops stops: included test plug: included 	2571	323.75	1/2" IPS	6	
For more product details, reference page 477 in valve section.						
HOW TO ORDER VALVES: PAGE 477		 TRIM PART #	+	 VALVE PART #	=	 COMPLETE FAUCET



Moen® bath accessories CANNOT be combined with Moen faucet parts on a Purchase Order.

A line of matching accessories - including tank levers and towel bars - allow for a completely cohesive look in the bath.

MODEL NUMBER	LIST EACH	DESCRIPTION	QTY
PREMIUM			
Chrome (CH)			
YB0801CH	114.50	Tank Lever	24
YB0803CH	109.95	Double Robe Hook	24
Ⓟ YB0808CH	156.45	Pivoting Paper Holder	6
YB0818CH	181.15	18" Towel Bar	6
YB0824CH	195.50	24" Towel Bar	6
YB0886CH	126.55	Towel Ring	6
YB0892CH	315.45	5X Magnifying Mirror	3
Matte Black (BL)			
YB0801BL	138.60	Tank Lever	24
YB0803BL	133.25	Double Robe Hook	24
Ⓟ YB0808BL	189.50	Pivoting Paper Holder	6
YB0818BL	219.40	18" Towel Bar	6
YB0824BL	236.80	24" Towel Bar	6
YB0886BL	153.15	Towel Ring	6
YB0892BL	382.00	5X Magnifying Mirror	3

Ⓟ Denotes pivoting paper holder



Tank Lever
YB0801



Double Robe Hook
YB0803



Towel Ring
YB0886



Pivoting Paper Holder
YB0808 | Ⓟ



18" Towel Bar
YB0818

24" Towel Bar
YB0824



5x Magnifying Mirror
YB0892

GRAB BARS ♿

MODEL NUMBER	LIST EACH	DESCRIPTION	QTY
PREMIUM			
1 1/4" • Chrome (CH)			
YG0812CH	206.25	12" Designer Grab Bar	6
YG0818CH	215.50	18" Designer Grab Bar	6
YG0824CH	225.15	24" Designer Grab Bar	6
YG0836CH	256.25	36" Designer Grab Bar	6
YG0842CH	358.70	42" Designer Grab Bar	6
1 1/4" • Matte Black (BL)			
YG0812BL	249.10	12" Designer Grab Bar	6
YG0818BL	260.30	18" Designer Grab Bar	6
YG0824BL	272.00	24" Designer Grab Bar	6
YG0836BL	309.70	36" Designer Grab Bar	6
YG0842BL	433.35	42" Designer Grab Bar	6

SECUREMOUNT



- SecureMount™ Grab Bars are manufactured with an innovative flange design that makes it easy to connect to the stud at multiple points.
- Tested to withstand 500lbs.
- To install grab bars securely without studs, use SecureMount™ Anchors. Sold separately.









18" Designer Grab Bar
YG0818









♿ Complies with Americans with Disabilities Act (ADA) specifications. SecureMount™ Grab Bars are tested to withstand 500 lb. pull when securely installed per instructions.





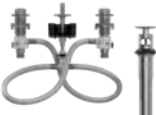



List price is per each (unless otherwise noted). Product can be ordered by case quantity or individually.

		MODEL	LIST	FINISH/CONNECT	CASE QTY
TOUCHLESS ONE-HANDLE BATHROOM FAUCET - MOTIONSENSE WAVE™ - PREMIUM					
 <p>DECKPLATE SOLD SEPARATELY</p> 	<ul style="list-style-type: none"> • application: one or three hole • supply lines: flexible • connection: 3/8" compression • deckplate: sold separately • drain assembly: metal • drain assembly type: spring loaded pop-up • DC powered: 6 AA batteries included  <p>DURALOCK® DURALAST®</p>	<p>1.2 GPM (4.5L/min) max.</p>			
		S6981EW	1009.30	Chrome	3
		S6981EWBN	1261.60	Brushed Nickel	3
		S6981EWNL	1312.05	Polished Nickel	3
		S6981EWBG	1362.55	Brushed Gold	3
OPTIONAL DECKPLATE SOLD SEPARATELY					
		161919	26.90	Chrome	20
		161919BN	38.10	Brushed Nickel	20
		161919NL	38.10	Polished Nickel	20
		161919BG	38.10	Brushed Gold	20
OPTIONAL AC ADAPTERS SOLD SEPARATELY					
		169031	159.60	N/A or Unfinished	12





ONE-HANDLE BATHROOM FAUCET - PREMIUM					
 <p>DECKPLATE SOLD SEPARATELY</p> 	<ul style="list-style-type: none"> • application: one or three hole • supply lines: flexible • connection: 3/8" compression • deckplate: sold separately • drain assembly: metal • drain assembly type: spring loaded pop-up  <p>DURALAST®</p>	<p>1.2 GPM (4.5L/min) max.</p>			
		S6981	643.05	Chrome	3
		S6981BN	835.95	Brushed Nickel	3
		S6981NL	900.25	Polished Nickel	3
		S6981BG	932.40	Brushed Gold	3
OPTIONAL DECKPLATE SOLD SEPARATELY					
		161919	26.90	Chrome	20
		161919BN	38.10	Brushed Nickel	20
		161919NL	38.10	Polished Nickel	20
		161919BG	38.10	Brushed Gold	20
 <p>DECKPLATE SOLD SEPARATELY</p> 	<ul style="list-style-type: none"> • application: one or three hole • supply lines: flexible • connection: 3/8" compression • deckplate: sold separately • drain assembly: 140780 sold separately  <p>DURALAST®</p>	<p>1.2 GPM (4.5L/min) max.</p>			
		S6982	771.65	Chrome	3
		S6982BN	1003.15	Brushed Nickel	3
		S6982NL	1080.35	Polished Nickel	3
		S6982BG	1118.90	Brushed Gold	3
OPTIONAL DECKPLATE SOLD SEPARATELY					
		161919	26.90	Chrome	20
		161919BN	38.10	Brushed Nickel	20
		161919NL	38.10	Polished Nickel	20
		161919BG	38.10	Brushed Gold	20
OPTION: DRAIN ASSEMBLY					
	<ul style="list-style-type: none"> • drain assembly: metal • drain assembly type: spring loaded pop-up • drain assembly size: 1-1/4" • drain assembly: 1-1/4" non-overflow 	140780	78.35	Chrome	12
		140780BN	109.20	Brushed Nickel	12
		140780NL	109.20	Polished Nickel	12
		140780BG	109.20	Brushed Gold	12











FLARA™ Collection

		MODEL	LIST	FINISH/CONNECT	CASE QTY	
TWO-HANDLE WIDESPREAD BATHROOM FAUCET TRIM - PREMIUM						
 <ul style="list-style-type: none"> • application: three hole • center dimensions: 8" - 16" center • drain assembly: metal with lift rod • valve: sold separately 			1.2 GPM (4.5L/min) max.			
		TS6984	613.65	Chrome	3	
		TS6984BN	797.75	Brushed Nickel	3	
		TS6984NL	859.15	Polished Nickel	3	
		TS6984BG	889.80	Brushed Gold	3	
 <ul style="list-style-type: none"> • application: three hole • center dimensions: 8" - 16" center • drain assembly: metal with lift rod • valve: sold separately 			1.2 GPM (4.5L/min) max.			
		TS6985	640.40	Chrome	3	
		TS6985BN	832.50	Brushed Nickel	3	
		TS6985NL	896.55	Polished Nickel	3	
		TS6985BG	928.55	Brushed Gold	3	
WIDESPREAD FAUCET VALVE						
 <ul style="list-style-type: none"> • application: three hole • center dimensions: 8" - 16" center • drain assembly: metal with lift rod 		9000◆	165.40	1/2" IPS	6	
HOW TO ORDER VALVES: PAGE 469		 TRIM PART #	+	 VALVE PART #	=	 COMPLETE FAUCET



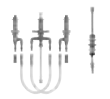





FREESTANDING TUB FILLER TRIM - PREMIUM						
 <ul style="list-style-type: none"> • application: one hole • showerhead type: handshower • handshower functions: one-function • handshower flow rate: 1.75 gpm (6.65L/min) max. • spout reach: 10.71" • mounting kit: sold separately 		S931	2235.60	Chrome	1	
		S931BN	3018.00	Brushed Nickel	1	
		S931NL	3018.00	Polished Nickel	1	
		S931BG	3018.00	Brushed Gold	1	
	FREESTANDING TUB FILLER VALVE AND MOUNTING KIT - PREMIUM					
 <ul style="list-style-type: none"> • description: single riser floor joist mounting kit • application: one hole • quarter turn stops: included 		TS50100	408.90	1/2" CC, NPT	2	
 <ul style="list-style-type: none"> • description: single riser concrete mounting kit • application: one hole • connection size: 1/2" 		TS50110	332.45	1/2" CC, NPT	2	
HOW TO ORDER VALVES: PAGE 469		 TRIM PART #	+	 VALVE PART #	=	 COMPLETE FAUCET









FLARA™ Collection



















		MODEL	LIST	FINISH/CONNECT	CASE QTY	
ONE-HANDLE WALLMOUNT TUB FILLER TRIM – PREMIUM						
 <ul style="list-style-type: none"> • application: two hole • connection: 1/2" slip fit • tub spout type: non diverter • spout reach: 10.00" • includes: high flow volume control cartridge • WMV130 series valve kit: sold separately 		WTS921	816.00	Chrome	3	
		WTS921BN	1245.20	Brushed Nickel	3	
		WTS921NL	1142.40	Polished Nickel	3	
		WTS921BG	1142.40	Brushed Gold	3	
ONE-HANDLE WALLMOUNT TUB FILLER VALVE KIT						
 <ul style="list-style-type: none"> • application: two hole with adj. center dimensions • ports: three • quarter turn stops: included • includes: test plug • includes: spout manifold 		WMV130CIS	154.05	1/2" CC/IPS	6	
		WMV130XS	154.05	1/2" Crimp Ring PEX	6	
		WMV130CXS	154.05	1/2" Cold Exp. PEX	6	
HOW TO ORDER						
VALVES: PAGE 469		 TRIM PART #	+	 VALVE PART #	=	 COMPLETE FAUCET

TWO-HANDLE ROMAN TUB TRIM – PREMIUM						
 <ul style="list-style-type: none"> • application: three hole • spout reach: 8.12" • valve: sold separately 		TS926	1055.70	Chrome	3	
		TS926BN	1530.70	Brushed Nickel	3	
		TS926NL	1530.70	Polished Nickel	3	
		TS926BG	1530.70	Brushed Gold	3	
TWO-HANDLE ROMAN TUB TRIM WITH HANDSHOWER – PREMIUM						
 <ul style="list-style-type: none"> • application: four hole • showerhead type: handshower • handshower flow rate: 1.75 gpm (6.65 L/min) max. • spray functions: one-function • spout reach: 8.12" • valve: sold separately 		TS928	1392.15	Chrome	3	
		TS928BN	2018.55	Brushed Nickel	3	
		TS928NL	2018.55	Polished Nickel	3	
		TS928BG	2018.55	Brushed Gold	3	
TWO-HANDLE ROMAN TUB VALVE						
 <ul style="list-style-type: none"> • deck thickness: 1/8" to 3-3/8" rough-in deck • adjustable spout shank: adjustable center dimensions 		4792	192.30	1/2" CC	6	
		DURALAST®				
 <ul style="list-style-type: none"> • deck thickness: 1/8" to 2-3/4" rough-in deck • adjustable spout shank: 10" - 24" center dimensions 		4793	217.80	1/2" CPVC, Crimp Ring PEX	6	
		4794	207.65	1/2" Crimp Ring PEX, Cold Exp. PEX	6	
	DURALOCK® DURALAST®					
 <ul style="list-style-type: none"> • deck thickness: 1/8" to 3-3/16" rough-in deck • Non-adjustable spout shank: 10" center dimensions 		4796	181.20	1/2" CC	6	
		4797	184.70	1/2" CPVC, Crimp Ring PEX	6	
		4798	184.70	1/2" Crimp Ring PEX, Cold Exp. PEX	6	
TWO-HANDLE ROMAN TUB VALVE WITH HANDSHOWER						
 <ul style="list-style-type: none"> • deck thickness: 1/8" to 2-5/8" rough-in deck • non-adj spout shank: adjustable center dim's 		9792	433.35	1/2" CC	6	
		DURALAST®				
 <ul style="list-style-type: none"> • deck thickness: 1/8" to 2-5/8" rough-in deck • adj spout shank: 10" - 24" center dimensions 		9793	443.50	1/2" CPVC, Crimp Ring PEX	6	
		DURALOCK® DURALAST®				
For more product details, reference page 470 in valve section.						
HOW TO ORDER						
VALVES: PAGE 470		 TRIM PART #	+	 VALVE PART #	=	 COMPLETE FAUCET

FLARA™ Collection

















		MODEL	LIST	FINISH/CONNECT	CASE QTY	
EXACTTEMP® VALVE ONLY TRIM - PREMIUM						
 <ul style="list-style-type: none"> • description: temperature control valve trim • requires: separate volume control valve • valve: sold separately  		TS4201	410.05	Chrome	3	
		TS4201BN	615.05	Brushed Nickel	3	
		TS4201NL	615.05	Polished Nickel	3	
		TS4201BG	615.05	Brushed Gold	3	
EXACTTEMP® THERMOSTATIC MIXING SHOWER VALVE - PREMIUM						
 <ul style="list-style-type: none"> • description: thermostatic rough-in valve • ports: four with adjustable temp. limit stops • check stops: included 		S3371	728.95	3/4" IPS	6	
HOW TO ORDER VALVES: PAGE 471		 TRIM PART #	+	 VALVE PART #	=	 COMPLETE FAUCET

EXACTTEMP® VOLUME CONTROL VALVE TRIM - PREMIUM						
 <ul style="list-style-type: none"> • valve: sold separately  		TS4202	189.20	Chrome	6	
		TS4202BN	283.95	Brushed Nickel	6	
		TS4202NL	283.95	Polished Nickel	6	
		TS4202BG	283.95	Brushed Gold	6	
EXACTTEMP® VOLUME CONTROL SHOWER VALVE - PREMIUM						
 <ul style="list-style-type: none"> • includes: volume control 		S3600	185.35	3/4" IPS	12	
HOW TO ORDER VALVES: PAGE 471		 TRIM PART #	+	 VALVE PART #	=	 COMPLETE FAUCET











		MODEL	LIST	FINISH/CONNECT	CASE QTY
M-CORE® 4-SERIES TUB/SHOWER TRIM – PREMIUM					
	<ul style="list-style-type: none"> • showerhead: single-function eco-performance rainshower • showerhead size: 6" diameter • tub spout length: 8 1/8" • tub spout connection type: slip fit • tub spout type: diverter • includes: thermostatic cartridge with volume and temperature control • valve: sold separately 	1.75 GPM (6.65 L/min) max.			
		UTS4913EP	926.10	Chrome	4
		UTS4913EPBN	1256.20	Brushed Nickel	4
		UTS4913EPNL	1256.20	Polished Nickel	4
		UTS4913EPBG	1256.20	Brushed Gold	4
M-CORE® 4-SERIES SHOWER ONLY TRIM – PREMIUM					
	<ul style="list-style-type: none"> • showerhead: single-function eco-performance rainshower • showerhead size: 6" diameter • includes: thermostatic cartridge with volume and temperature control • valve: sold separately 	1.75 GPM (6.65 L/min) max.			
		UTS4912EP	799.15	Chrome	4
		UTS4912EPBN	1052.85	Brushed Nickel	4
		UTS4912EPNL	1052.85	Polished Nickel	4
		UTS4912EPBG	1052.85	Brushed Gold	4
M-CORE® 4-SERIES VALVE ONLY TRIM – PREMIUM					
	<ul style="list-style-type: none"> • includes: thermostatic cartridge with volume and temperature control • valve: sold separately 	UTS4910	693.80	Chrome	3
		UTS4910BN	875.20	Brushed Nickel	3
		UTS4910NL	875.20	Polished Nickel	3
		UTS4910BG	875.20	Brushed Gold	3
		M-CORE® MIXING SHOWER VALVE			
	<ul style="list-style-type: none"> • tub/shower or shower only application • ports: four with adj. temp. limit stops • included: test plug and cross flow plug 	U140CI	72.60	1/2" CC/IPS	6
		U140X	72.60	1/2" Crimp Ring PEX + CC/IPS Tub	6
		U140CX	72.60	1/2" Cold Exp. PEX + CC/IPS Tub	6
		U140V	88.95	1/2" CPVC + CC/IPS Tub	6
			<ul style="list-style-type: none"> • tub/shower or shower only application • ports: four with adj. temp. limit stops • quarter turn stops: included 	U140CIS	104.50
U140XS	104.50			1/2" Crimp Ring PEX + CC/IPS Tub	6
U140CXS	104.50			1/2" Cold Exp. PEX + CC/IPS Tub	6
U140VS	120.85			1/2" CPVC + CC/IPS Tub	6
	<ul style="list-style-type: none"> • shower only application • ports: three 			U130CI	72.60
		U130X	72.60	1/2" Crimp Ring PEX	6
		U130CX	72.60	1/2" Cold Exp. PEX	6
	<ul style="list-style-type: none"> • shower only application • ports: three • quarter turn stops: included 	U130CIS	104.50	1/2" CC/IPS	6
		U130XS	104.50	1/2" Crimp Ring PEX	6
		U130CXS	104.50	1/2" Cold Exp. PEX	6
<p>Four port valves can be used with either Tub/Shower or Shower Only applications. Three port valves can ONLY be used with Shower Only applications. For more product details, reference page 471 in valve section.</p>					
HOW TO ORDER VALVES: PAGE 471		 TRIM PART #   VALVE PART #   COMPLETE FAUCET			













FLARA™ Collection

















		MODEL	LIST	FINISH/CONNECT	CASE QTY	
M-CORE® 3-SERIES TUB/SHOWER TRIM – PREMIUM						
 <ul style="list-style-type: none"> • showerhead: single-function rainshower • showerhead size: 6" diameter • tub spout length: 8 1/8" • tub spout connection type: slip fit • tub spout type: diverter • includes: pressure balanced cartridge with volume and temperature control • valve: sold separately 		2.5 GPM (9.5 L/min) max.				
		UTS3913	788.40	Chrome	4	
		UTS3913BN	1118.50	Brushed Nickel	4	
		UTS3913NL	1118.50	Polished Nickel	4	
		UTS3913BG	1118.50	Brushed Gold	4	
		1.75 GPM (6.65 L/min) max.				
		UTS3913EP	788.40	Chrome	4	
		UTS3913EPBN	1118.50	Brushed Nickel	4	
		UTS3913EPNL	1118.50	Polished Nickel	4	
		UTS3913EPBG	1118.50	Brushed Gold	4	
M-CORE® 3-SERIES SHOWER ONLY TRIM – PREMIUM						
 <ul style="list-style-type: none"> • showerhead: single-function rainshower • showerhead size: 6" diameter • includes: pressure balanced cartridge with volume and temperature control • valve: sold separately 		2.5 GPM (9.5 L/min) max.				
		UTS3912	661.45	Chrome	4	
		UTS3912BN	915.15	Brushed Nickel	4	
		UTS3912NL	915.15	Polished Nickel	4	
		UTS3912BG	915.15	Brushed Gold	4	
		1.75 GPM (6.65 L/min) max.				
		UTS3912EP	661.45	Chrome	4	
		UTS3912EPBN	915.15	Brushed Nickel	4	
		UTS3912EPNL	915.15	Polished Nickel	4	
		UTS3912EPBG	915.15	Brushed Gold	4	
M-CORE® 3-SERIES VALVE ONLY TRIM – PREMIUM						
 <ul style="list-style-type: none"> • includes: pressure balanced cartridge with volume and temperature control • valve: sold separately 		UTS3911	556.10	Chrome	3	
		UTS3911BN	737.50	Brushed Nickel	3	
		UTS3911NL	737.50	Polished Nickel	3	
		UTS3911BG	737.50	Brushed Gold	3	
	M-CORE® MIXING SHOWER VALVE					
 <ul style="list-style-type: none"> • tub/shower or shower only application • ports: four with adj. temp. limit stops • included: test plug and cross flow plug 		U140CI	72.60	1/2" CC/IPS	6	
		U140X	72.60	1/2" Crimp Ring PEX + CC/IPS Tub	6	
		U140CX	72.60	1/2" Cold Exp. PEX + CC/IPS Tub	6	
		U140V	88.95	1/2" CPVC + CC/IPS Tub	6	
	 <ul style="list-style-type: none"> • tub/shower or shower only application • ports: four with adj. temp. limit stops • quarter turn stops: included 		U140CIS	104.50	1/2" CC/IPS	6
		U140XS	104.50	1/2" Crimp Ring PEX + CC/IPS Tub	6	
		U140CXS	104.50	1/2" Cold Exp. PEX + CC/IPS Tub	6	
		U140VS	120.85	1/2" CPVC + CC/IPS Tub	6	
 <ul style="list-style-type: none"> • shower only application • ports: three 			U130CI	72.60	1/2" CC/IPS	6
		U130X	72.60	1/2" Crimp Ring PEX	6	
		U130CX	72.60	1/2" Cold Exp. PEX	6	
 <ul style="list-style-type: none"> • shower only application • ports: three • quarter turn stops: included 		U130CIS	104.50	1/2" CC/IPS	6	
		U130XS	104.50	1/2" Crimp Ring PEX	6	
		U130CXS	104.50	1/2" Cold Exp. PEX	6	
<p>Four port valves can be used with either Tub/Shower or Shower Only applications. Three port valves can ONLY be used with Shower Only applications. For more product details, reference page 471 in valve section.</p>						
<p>HOW TO ORDER VALVES: PAGE 471</p>		 <p>TRIM PART #</p>	+	 <p>VALVE PART #</p>	=	 <p>COMPLETE FAUCET</p>

FLARA™













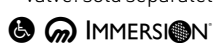

		MODEL	LIST	FINISH/CONNECT	CASE QTY		
M-CORE® 3-SERIES WITH INTEGRATED TRANSFER VALVE TRIM - PREMIUM							
 <ul style="list-style-type: none"> • includes: pressure balanced cartridge with volume and temperature control • valve: sold separately  		UTS2411	518.80	Chrome	4		
		UTS2411BN	752.25	Brushed Nickel	4		
		UTS2411NL	752.25	Polished Nickel	4		
		UTS2411BG	752.25	Brushed Gold	4		
M-CORE® WITH INTEGRATED TRANSFER VALVE							
Three Function (2 independent/1 shared) OR Six Function (3 independent/3 shared) - plumbing configuration page 478							
 <ul style="list-style-type: none"> • ports: four with adj. temp. limit stops • check stops: included 		U362CIS	270.70	1/2" CC/IPS	6		
		U362CXS	270.70	1/2" Cold Exp. PEX	6		
		U362XS	270.70	1/2" Crimp Ring PEX	6		
Two Independent Functions OR Three Independent Functions - plumbing configurations page 478							
 <ul style="list-style-type: none"> • ports: four with adj. temp. limit stops • check stops: included 		U232CIS	270.70	1/2" CC/IPS	6		
		U232CXS	270.70	1/2" Cold Exp. PEX	6		
		U232XS	270.70	1/2" Crimp Ring PEX	6		
For more product details, reference page 472 in valve section. See page 478 for plumbing configurations.							
HOW TO ORDER VALVES: PAGE 472		TRIM PART #	+		=		COMPLETE FAUCET

M-CORE® TRANSFER VALVE TRIM - PREMIUM							
 <ul style="list-style-type: none"> • use with the M-CORE® transfer valve • valve: sold separately  		UTS4911	337.30	Chrome	12		
		UTS4911BN	458.10	Brushed Nickel	12		
		UTS4911NL	458.10	Polished Nickel	12		
		UTS4911BG	458.10	Brushed Gold	12		
M-CORE® TRANSFER VALVE							
Three Function (2 independent/1 shared) OR Six Function (3 independent/3 shared) - plumbing configuration page 478							
 <ul style="list-style-type: none"> • number of functions: three or six • ports: four 		U361CI	152.70	1/2" CC/IPS	6		
		U361CX	152.70	1/2" Cold Exp. PEX	6		
		U361X	152.70	1/2" Crimp Ring PEX	6		
Two Independent Functions OR Three Independent Functions - plumbing configurations page 478							
 <ul style="list-style-type: none"> • number of functions: two or three • ports: four 		U231CI	152.70	1/2" CC/IPS	6		
		U231CX	152.70	1/2" Cold Exp. PEX	6		
		U231X	152.70	1/2" Crimp Ring PEX	6		
For more product details, reference page 472 in valve section. See page 478 for plumbing configurations.							
HOW TO ORDER VALVES: PAGE 472		TRIM PART #	+		=		COMPLETE FAUCET

FLARA™ Collection

		MODEL	LIST	FINISH/CONNECT	CASE QTY	
M-CORE® 2-SERIES TUB/SHOWER TRIM – PREMIUM						
 <ul style="list-style-type: none"> • showerhead: single-function eco-performance rainshower • showerhead size: 6" diameter • tub spout length: 8 1/8" • tub spout connection type: slip fit • tub spout type: diverter • includes: pressure balanced cartridge with temperature control • valve: sold separately 	<ul style="list-style-type: none"> • 1.75 GPM (6.65 L/min) max. 					
	UTS2913EP	717.15	Chrome	4		
	UTS2913EPBN	998.70	Brushed Nickel	4		
	UTS2913EPNL	998.70	Polished Nickel	4		
	UTS2913EPBG	998.70	Brushed Gold	4		
M-CORE® 2-SERIES SHOWER ONLY TRIM – PREMIUM						
 <ul style="list-style-type: none"> • showerhead: single-function eco-performance rainshower • showerhead size: 6" diameter • includes: pressure balanced cartridge with temperature control • valve: sold separately 	<ul style="list-style-type: none"> • 1.75 GPM (6.65 L/min) max. 					
	UTS2912EP	596.85	Chrome	4		
	UTS2912EPBN	818.30	Brushed Nickel	4		
	UTS2912EPNL	818.30	Polished Nickel	4		
	UTS2912EPBG	818.30	Brushed Gold	4		
M-CORE® 2-SERIES VALVE ONLY TRIM – PREMIUM						
 <ul style="list-style-type: none"> • includes: pressure balanced cartridge with temperature control • valve: sold separately 						
	UTS2911	446.60	Chrome	3		
	UTS2911BN	592.95	Brushed Nickel	3		
	UTS2911NL	592.95	Polished Nickel	3		
	UTS2911BG	592.95	Brushed Gold	3		
M-CORE® MIXING SHOWER VALVE						
 <ul style="list-style-type: none"> • tub/shower or shower only application • ports: four with adj. temp. limit stops • included: test plug and cross flow plug 						
	U140CI	72.60	1/2" CC/IPS	6		
	U140X	72.60	1/2" Crimp Ring PEX + CC/IPS Tub	6		
	U140CX	72.60	1/2" Cold Exp. PEX + CC/IPS Tub	6		
	U140V	88.95	1/2" CPVC + CC/IPS Tub	6		
 <ul style="list-style-type: none"> • tub/shower or shower only application • ports: four with adj. temp. limit stops • quarter turn stops: included 						
	U140CIS	104.50	1/2" CC/IPS	6		
	U140XS	104.50	1/2" Crimp Ring PEX + CC/IPS Tub	6		
	U140CXS	104.50	1/2" Cold Exp. PEX + CC/IPS Tub	6		
	U140VS	120.85	1/2" CPVC + CC/IPS Tub	6		
 <ul style="list-style-type: none"> • shower only application • ports: three 						
	U130CI	72.60	1/2" CC/IPS	6		
	U130X	72.60	1/2" Crimp Ring PEX	6		
 <ul style="list-style-type: none"> • shower only application • ports: three • quarter turn stops: included 						
	U130CIS	104.50	1/2" CC/IPS	6		
	U130XS	104.50	1/2" Crimp Ring PEX	6		
		U130CXS	104.50	1/2" Cold Exp. PEX	6	
<p>Four port valves can be used with either Tub/Shower or Shower Only applications. Three port valves can ONLY be used with Shower Only applications. For more product details, reference page 471 in valve section.</p>						
<p>HOW TO ORDER VALVES: PAGE 471</p>		 <p>TRIM PART #</p>	+	 <p>VALVE PART #</p>	=	 <p>COMPLETE FAUCET</p>

MODEL LIST FINISH/CONNECT CASE QTY

POSI-TEMP® TUB/SHOWER TRIM - PREMIUM					
 <ul style="list-style-type: none"> • showerhead: single-function rainshower • showerhead size: 6" diameter • tub spout length: 8 1/8" • tub spout connection type: slip fit • tub spout type: diverter • valve: sold separately 	2.5 GPM (9.5 L/min) max.				
	TS2913	563.15	Chrome	4	
	TS2913BN	844.60	Brushed Nickel	4	
	TS2913NL	844.60	Polished Nickel	4	
	TS2913BG	844.60	Brushed Gold	4	
	1.75 GPM (6.65 L/min) max.				
	TS2913EP	563.15	Chrome	4	
	TS2913EPBN	844.60	Brushed Nickel	4	
	TS2913EPNL	844.60	Polished Nickel	4	
	TS2913EPBG	844.60	Brushed Gold	4	
POSI-TEMP® SHOWER ONLY TRIM - PREMIUM					
 <ul style="list-style-type: none"> • showerhead: single-function rainshower • showerhead size: 6" diameter • valve: sold separately 	2.5 GPM (9.5 L/min) max.				
	TS2912	442.85	Chrome	4	
	TS2912BN	664.15	Brushed Nickel	4	
	TS2912NL	664.15	Polished Nickel	4	
	TS2912BG	664.15	Brushed Gold	4	
	1.75 GPM (6.65 L/min) max.				
	TS2912EP	442.85	Chrome	4	
	TS2912EPBN	664.15	Brushed Nickel	4	
	TS2912EPNL	664.15	Polished Nickel	4	
	TS2912EPBG	664.15	Brushed Gold	4	
POSI-TEMP® VALVE ONLY TRIM - PREMIUM					
 <ul style="list-style-type: none"> • valve: sold separately 	TS2911	292.60	Chrome	3	
	TS2911BN	438.80	Brushed Nickel	3	
	TS2911NL	438.80	Polished Nickel	3	
	TS2911BG	438.80	Brushed Gold	3	
	POSI-TEMP® SHOWER MIXING VALVES				
 <ul style="list-style-type: none"> • tub/shower or shower only application • ports: four with adjustable temp. limit stops • test plug: included 	2520 ◆	159.20	1/2" CC	6	
	2510 ◆	159.20	1/2" IPS	6	
 <ul style="list-style-type: none"> • tub/shower or shower only application • ports: four with adjustable temp. limit stops • quarter turn stops: included • test plug: included 	2570 ◆	193.35	1/2" CC	6	
	2590 ◆	193.35	1/2" IPS	6	
	2580 ◆	159.20	1/2" Crimp ring PEX	6	
	2360PF	212.60	1/2" Crimp Ring PEX	3	
 <ul style="list-style-type: none"> • tub/shower only application • ports: four with adjustable temp. limit stops • quarter turn stops: included • test plug: included 	2326PF	205.20	1/2" Crimp Ring PEX	6	
	2328PF	205.20	1/2" Cold Exp. PEX	6	
<p>Four port valves can be used with either Tub/Shower or Shower Only applications. Three port valves can ONLY be used with Shower Only applications. For more product details, reference page 473-476 in valve section.</p>					
<p>HOW TO ORDER VALVES: PAGES 473-476</p>	 <p>TRIM PART #</p>	+	 <p>VALVE PART #</p>	=	 <p>COMPLETE FAUCET</p>



FLARA™ Matching Bath Accessories

Moen® bath accessories CANNOT be combined with Moen faucet parts on a Purchase Order.

A line of matching accessories - including tank levers and towel bars - allow for a completely cohesive look in the bath.

MODEL NUMBER	LIST EACH	DESCRIPTION	QTY
PREMIUM			
Chrome (CH)			
YB0301CH	92.40	Tank Lever	24
YB0303CH	70.85	Double Robe Hook	24
YB0305CH	18.60	Drawer Knob	48
YB0307CH	37.35	Drawer Pull	48
Ⓟ YB0308CH	130.35	Pivoting Paper Holder	6
YB0318CH	150.00	18" Towel Bar	6
YB0322CH	145.40	24" Double Towel Bar	6
YB0324CH	155.15	24" Towel Bar	6
YB0386CH	104.75	Hand Towel Bar	6
YB0390CH	144.00	Vanity Shelf	6
Ⓟ YB0392CH	354.55	Mirror	1
Brushed Nickel (BN)			
YB0301BN	120.10	Tank Lever	24
YB0303BN	92.15	Double Robe Hook	24
YB0305BN	24.25	Drawer Knob	48
YB0307BN	48.60	Drawer Pull	48
Ⓟ YB0308BN	169.35	Pivoting Paper Holder	6
YB0318BN	194.85	18" Towel Bar	6
YB0322BN	188.95	24" Double Towel Bar	6
YB0324BN	201.75	24" Towel Bar	6
YB0386BN	136.15	Hand Towel Bar	6
YB0390BN	187.15	Vanity Shelf	6
Ⓟ YB0392BN	425.40	Mirror	1
Polished Nickel (NL)			
YB0301NL	132.15	Tank Lever	24
YB0303NL	101.30	Double Robe Hook	24
YB0305NL	20.50	Drawer Knob	48
YB0307NL	53.45	Drawer Pull	48
Ⓟ YB0308NL	186.35	Pivoting Paper Holder	6
YB0318NL	214.35	18" Towel Bar	6
YB0322NL	208.00	24" Double Towel Bar	6
YB0324NL	221.85	24" Towel Bar	6
YB0386NL	149.85	Hand Towel Bar	6
YB0390NL	205.85	Vanity Shelf	6
Ⓟ YB0392NL	468.00	Mirror	1
Brushed Gold (BG)			
YB0301BG	144.20	Tank Lever	24
YB0303BG	110.55	Double Robe Hook	24
YB0305BG	29.05	Drawer Knob	48
YB0307BG	58.35	Drawer Pull	48
Ⓟ YB0308BG	203.35	Pivoting Paper Holder	6
YB0318BG	233.95	18" Towel Bar	6
YB0322BG	226.90	24" Double Towel Bar	6
YB0324BG	242.10	24" Towel Bar	6
YB0386BG	163.45	Hand Towel Bar	6
YB0390BG	224.55	Vanity Shelf	6
Ⓟ YB0392BG	510.45	Mirror	1

Ⓟ Denotes pivoting paper holder and mirror



Tank Lever

YB0301



Double Robe Hook

YB0303



Pivoting Paper Holder

YB0308 | Ⓟ



Hand Towel Bar

YB0386



18" Towel Bar

YB0318



24" Double Towel Bar

YB0322

24" Towel Bar

YB0324



Drawer Knob

YB0305



Drawer Pull

YB0307



Vanity Shelf

YB0390



Mirror

YB0392 | Ⓟ

GRAB BARS 

MODEL NUMBER LIST EACH DESCRIPTION QTY

PREMIUM

1½" • Chrome (CH)

YG0312CH	214.20	12" Designer Grab Bar	6
YG0318CH	223.85	18" Designer Grab Bar	6
YG0324CH	233.90	24" Designer Grab Bar	6
YG0336CH	266.20	36" Designer Grab Bar	6
YG0342CH	391.75	42" Designer Grab Bar	6

1½" • Brushed Nickel (BN)

YG0312BN	278.40	12" Designer Grab Bar	6
YG0318BN	290.95	18" Designer Grab Bar	6
YG0324BN	303.90	24" Designer Grab Bar	6
YG0336BN	346.10	36" Designer Grab Bar	6
YG0342BN	509.25	42" Designer Grab Bar	6

1½" • Brushed Gold (BG)

YG0312BG	334.15	12" Designer Grab Bar	6
YG0318BG	349.10	18" Designer Grab Bar	6
YG0324BG	364.75	24" Designer Grab Bar	6
YG0336BG	415.30	36" Designer Grab Bar	6
YG0342BG	611.15	42" Designer Grab Bar	6

1½" • Polished Nickel (NL)

YG0312NL	306.25	12" Designer Grab Bar	6
YG0318NL	320.10	18" Designer Grab Bar	6
YG0324NL	334.40	24" Designer Grab Bar	6
YG0336NL	380.65	36" Designer Grab Bar	6
YG0342NL	560.20	42" Designer Grab Bar	6

LIGHTING

MODEL NUMBER LIST EACH DESCRIPTION QTY

PREMIUM

Chrome (CH)

YB0361CH	237.45	One Globe Bath Light	2
YB0362CH	332.15	Two Globe Bath Light	2
YB0363CH	412.60	Three Globe Bath Light	2
YB0364CH	515.70	Four Globe Bath Light	2

Brushed Nickel (BN)

YB0361BN	308.65	One Globe Bath Light	2
YB0362BN	431.80	Two Globe Bath Light	2
YB0363BN	536.30	Three Globe Bath Light	2
YB0364BN	670.45	Four Globe Bath Light	2

Brushed Gold (BG)

YB0361BG	370.35	One Globe Bath Light	2
YB0362BG	518.25	Two Globe Bath Light	2
YB0363BG	643.55	Three Globe Bath Light	2
YB0364BG	804.35	Four Globe Bath Light	2

Polished Nickel (NL)

YB0361NL	339.50	One Globe Bath Light	2
YB0362NL	475.05	Two Globe Bath Light	2
YB0363NL	589.90	Three Globe Bath Light	2
YB0364NL	737.40	Four Globe Bath Light	2

Replacement Globe

YB0369	40.90	Replacement Globe	3
--------	-------	-------------------	---

SECUREMOUNT™

- SecureMount™ Grab Bars are manufactured with an innovative flange design that makes it easy to connect to the stud at multiple points.
- Tested to withstand 500lbs.
- To install grab bars securely without studs, use SecureMount™ Anchors. Sold separately.



24" Designer Grab Bar

YG0324



One Globe Bath Light

YB0361



Two Globe Bath Light

YB0362



Three Globe Bath Light

YB0363



Four Globe Bath Light

YB0364



Replacement Globe





























YB0369

 Complies with Americans with Disabilities Act (ADA) specifications. SecureMount™ Grab Bars are tested to withstand 500 lb. pull when securely installed per instructions.

 Bulbs not included. List price is per each (unless otherwise noted). Product can be ordered by case quantity or individually. All Flara™ lighting Fixtures can be mounted facing either upward or downward.





















COLINET™ Collection

		MODEL	LIST	FINISH/CONNECT	CASE QTY
ONE-HANDLE BATHROOM FAUCET - PREMIUM					
 <ul style="list-style-type: none"> • application: one hole • supply lines: flexible • connection: 3/8" compression • drain assembly: metal • drain assembly type: spring loaded pop-up <p> DURALAST®</p>	<p> 1.2 GPM (4.5L/min) max.</p>				
	S44101	596.90	Chrome	3	
	S44101BN	775.95	Brushed Nickel	3	
	S44101BL	835.65	Matte Black	3	
	S44101BG	865.50	Brushed Gold	3	
TWO-HANDLE WIDESPREAD BATHROOM FAUCET TRIM - PREMIUM					
 <ul style="list-style-type: none"> • application: three hole • center dimensions: 8" - 16" center • drain assembly: metal with lift rod • valve: sold separately <p> </p>	<p> 1.2 GPM (4.5L/min) max.</p>				
	TS44102	534.30	Chrome	3	
	TS44102BN	694.60	Brushed Nickel	3	
	TS44102BL	748.05	Matte Black	3	
 <ul style="list-style-type: none"> • application: three hole • center dimensions: 8" - 16" center • drain assembly: metal with lift rod • valve: sold separately <p></p>	<p> 1.2 GPM (4.5L/min) max.</p>				
	TS44103	559.80	Chrome	3	
	TS44103BN	727.75	Brushed Nickel	3	
	TS44103BL	783.75	Matte Black	3	
WIDESPREAD FAUCET VALVE					
 <ul style="list-style-type: none"> • application: three hole • center dimensions: 8" - 16" center • drain assembly: metal with lift rod <p> DURALOCK® DURALAST®</p>		9000♦	165.40	1/2" IPS	6
<p>HOW TO ORDER VALVES: PAGE 469</p> <p>  TRIM PART # +  VALVE PART # =  COMPLETE FAUCET </p>					
TWO-HANDLE WALLMOUNT BATHROOM FAUCET TRIM - PREMIUM					
 <ul style="list-style-type: none"> • application: three hole • center dimensions: 8" center • drain assembly: 140780 sold separately • valve: sold separately <p> </p>	<p> 1.2 GPM (4.5L/min) max.</p>				
	TS44104	561.10	Chrome	3	
	TS44104BN	729.40	Brushed Nickel	3	
	TS44104BL	785.50	Matte Black	3	
 <ul style="list-style-type: none"> • application: three hole • center dimensions: 8" center • drain assembly: 140780 sold separately • valve: sold separately <p></p>	<p> 1.2 GPM (4.5L/min) max.</p>				
	TS44105	586.60	Chrome	3	
	TS44105BN	762.55	Brushed Nickel	3	
	TS44105BL	821.20	Matte Black	3	
TWO-HANDLE WALLMOUNT FAUCET VALVE					
 <ul style="list-style-type: none"> • application: three hole • center dimensions: 8" center • drain assembly: 140780 sold separately • includes: mounting brackets <p> DURALAST®</p>		9700	233.95	1/2" CC	3
<p>HOW TO ORDER VALVES: PAGE 469</p> <p>  TRIM PART # +  VALVE PART # =  COMPLETE FAUCET </p>					
OPTION: DRAIN ASSEMBLY					
 <ul style="list-style-type: none"> • drain assembly: metal • drain assembly type: spring loaded pop-up • drain assembly size: 1-1/4" • drain assembly: 1-1/4" non-overflow 		140780	78.35	Chrome	12
	140780BN	109.20	Brushed Nickel	12	
	140780BL	123.30	Matte Black	12	
	140780BG	109.20	Brushed Gold	12	



















COLINET™

COLINET™ Collection

		MODEL	LIST	FINISH/CONNECT	CASE QTY			
FREESTANDING TUB FILLER TRIM - PREMIUM								
	<ul style="list-style-type: none"> • application: one hole • showerhead type: handshower • handshower functions: one-function • handshower flow rate: 1.75 gpm (6.65 L/min) max. • spout reach: 11.10" • mounting kit: sold separately 	S44507	2235.60	Chrome	1			
		S44507BN	3018.00	Brushed Nickel	1			
		S44507BG	3018.00	Brushed Gold	1			
		S44507BL	3319.90	Matte Black	1			
	 							
FREESTANDING TUB FILLER VALVE AND MOUNTING KIT - PREMIUM								
	<ul style="list-style-type: none"> • description: single riser floor joist mounting kit • application: one hole • quarter turn stops: included 	TS50100	408.90	1/2" CC, NPT	2			
								
	<ul style="list-style-type: none"> • description: single riser concrete mounting kit • application: one hole • connection size: 1/2" 	TS50110	332.45	1/2" CC, NPT	2			
								
HOW TO ORDER VALVES: PAGE 469		TRIM PART #	+		VALVE PART #	=		COMPLETE FAUCET

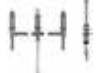

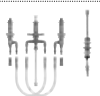





ONE-HANDLE WALLMOUNT TUB FILLER TRIM - PREMIUM								
	<ul style="list-style-type: none"> • application: two hole • connection: 1/2" slip fit • tub spout type: non diverter • spout reach: 10.00" • includes: high flow volume control cartridge • WMV130 series valve kit: sold separately 	WTS44501	828.30	Chrome	3			
		WTS44501BN	1134.75	Brushed Nickel	3			
		WTS44501BG	1134.75	Brushed Gold	3			
		WTS44501BL	1248.20	Matte Black	3			
	 							
ONE-HANDLE WALLMOUNT TUB FILLER VALVE KIT								
	<ul style="list-style-type: none"> • application: two hole with adj. center dimensions • ports: three • quarter turn stops: included • includes: test plug • includes: spout manifold 	WMV130CIS	154.05	1/2" CC/IPS	6			
		WMV130XS	154.05	1/2" Crimp Ring PEX	6			
		WMV130CXS	154.05	1/2" Cold Exp. PEX	6			
								
HOW TO ORDER VALVES: PAGE 469		TRIM PART #	+		VALVE PART #	=		COMPLETE FAUCET









COLINET™ Collection

	MODEL	LIST	FINISH/CONNECT	CASE QTY
TWO-HANDLE ROMAN TUB TRIM - PREMIUM				
 <ul style="list-style-type: none"> • application: three hole • spout reach: 8.00" • valve: sold separately 	TS44503	1009.85	Chrome	3
	TS44503BN	1464.25	Brushed Nickel	3
	TS44503BG	1464.25	Brushed Gold	3
	TS44503BL	1610.65	Matte Black	3
 <ul style="list-style-type: none"> • application: three hole • spout reach: 8.00" • valve: sold separately 	TS44505	1035.85	Chrome	3
	TS44505BN	1490.25	Brushed Nickel	3
	TS44505BG	1490.25	Brushed Gold	3
	TS44505BL	1636.70	Matte Black	3
TWO-HANDLE ROMAN TUB TRIM WITH HANDSHOWER - PREMIUM				
 <ul style="list-style-type: none"> • application: four hole • showerhead type: handshower • handshower flow rate: 1.75 gpm (6.65 L/min) max. • spray functions: one-function • spout reach: 8.00" • valve: sold separately 	TS44504	1222.45	Chrome	3
	TS44504BN	1772.65	Brushed Nickel	3
	TS44504BG	1772.65	Brushed Gold	3
	TS44504BL	1949.95	Matte Black	3
 <ul style="list-style-type: none"> • application: four hole • showerhead type: handshower • handshower flow rate: 1.75 gpm (6.65 L/min) max. • spray functions: one-function • spout reach: 8.00" • valve: sold separately 	TS44506	1248.50	Chrome	3
	TS44506BN	1798.65	Brushed Nickel	3
	TS44506BG	1798.65	Brushed Gold	3
	TS44506BL	1975.95	Matte Black	3
TWO-HANDLE ROMAN TUB VALVE				
 <ul style="list-style-type: none"> • deck thickness: 1/8" to 3-3/8" rough-in deck • adjustable spout shank: adjustable center dimensions 	4792	192.30	1/2" CC	6
 <ul style="list-style-type: none"> • deck thickness: 1/8" to 2-3/4" rough-in deck • adjustable spout shank: 10" - 24" center dimensions 	4793	217.80	1/2" CPVC, Crimp Ring PEX	6
	4794	207.65	1/2" Crimp Ring PEX, Cold Exp. PEX	6
 <ul style="list-style-type: none"> • deck thickness: 1/8" to 3-3/16" rough-in deck • Non-adjustable spout shank: 10" center dimensions 	4796	181.20	1/2" CC	6
	4797	184.70	1/2" CPVC, Crimp Ring PEX	6
	4798	184.70	1/2" Crimp Ring PEX, Cold Exp. PEX	6
TWO-HANDLE ROMAN TUB VALVE WITH HANDSHOWER				
 <ul style="list-style-type: none"> • deck thickness: 1/8" to 2-5/8" rough-in deck • non-adj spout shank: adjustable center dim's 	9792	433.35	1/2" CC	6
 <ul style="list-style-type: none"> • deck thickness: 1/8" to 2-5/8" rough-in deck • adj spout shank: 10" - 24" center dimensions 	9793	443.50	1/2" CPVC, Crimp Ring PEX	6
For more product details, reference page 470 in valve section.				
HOW TO ORDER VALVES: PAGE 470				

COLINET™















COLINET™ Collection

		MODEL	LIST	FINISH/CONNECT	CASE QTY	
EXACTTEMP® VALVE ONLY TRIM - PREMIUM						
 <ul style="list-style-type: none"> • description: temperature control valve trim • requires: separate volume control valve • valve: sold separately  		TS44401	392.20	Chrome	3	
		TS44401BN	588.25	Brushed Nickel	3	
		TS44401BG	588.25	Brushed Gold	3	
		TS44401BL	647.15	Matte Black	3	
EXACTTEMP® THERMOSTATIC MIXING SHOWER VALVE - PREMIUM						
 <ul style="list-style-type: none"> • description: thermostatic rough-in valve • ports: four with adjustable temp. limit stops • check stops: included 		S3371	728.95	¾" IPS	6	
HOW TO ORDER VALVES: PAGE 471		 TRIM PART #	+	 VALVE PART #	=	 COMPLETE FAUCET

















EXACTTEMP® VOLUME CONTROL VALVE TRIM - PREMIUM						
 <ul style="list-style-type: none"> • valve: sold separately  		TS44402	181.05	Chrome	6	
		TS44402BN	271.65	Brushed Nickel	6	
		TS44402BG	271.65	Brushed Gold	6	
		TS44402BL	298.75	Matte Black	6	
EXACTTEMP® VOLUME CONTROL SHOWER VALVE - PREMIUM						
 <ul style="list-style-type: none"> • includes: volume control 		S3600	185.35	¾" IPS	12	
HOW TO ORDER VALVES: PAGE 471		 TRIM PART #	+	 VALVE PART #	=	 COMPLETE FAUCET









COLINET™ Collection







		MODEL	LIST	FINISH/CONNECT	CASE QTY
M-CORE® 4-SERIES TUB/SHOWER TRIM - PREMIUM					
 <ul style="list-style-type: none"> • showerhead: single-function eco-performance rainshower • showerhead size: 10" diameter • type of function: one function • tub spout length: 9" • tub spout connection type: slip fit • tub spout type: diverter • includes: thermostatic cartridge with volume and temperature control • valve: sold separately 	<ul style="list-style-type: none"> • 1.75 GPM (6.65 L/min) max. 				
	UTS444303EP	828.45	Chrome	3	
	UTS444303EPBN	1117.70	Brushed Nickel	3	
	UTS444303EPBG	1117.70	Brushed Gold	3	
	UTS444303EPBL	1215.70	Matte Black	3	
M-CORE® 4-SERIES SHOWER ONLY TRIM - PREMIUM					
 <ul style="list-style-type: none"> • showerhead type: eco-performance rainshower • showerhead size: 10" diameter • type of function: one function • includes: thermostatic cartridge with volume and temperature control • valve: sold separately 	<ul style="list-style-type: none"> • 1.75 GPM (6.65 L/min) max. 				
	UTS444302EP	717.25	Chrome	3	
	UTS444302EPBN	939.40	Brushed Nickel	3	
	UTS444302EPBG	939.40	Brushed Gold	3	
	UTS444302EPBL	1019.70	Matte Black	3	
M-CORE® 4-SERIES VALVE ONLY TRIM - PREMIUM					
 <ul style="list-style-type: none"> • includes: thermostatic cartridge with volume and temperature control • valve: sold separately 					
	UTS444301	624.90	Chrome	3	
	UTS444301BN	783.85	Brushed Nickel	3	
	UTS444301BG	783.85	Brushed Gold	3	
UTS444301BL	848.45	Matte Black	3		
M-CORE® MIXING SHOWER VALVE					
 <ul style="list-style-type: none"> • tub/shower or shower only application • ports: four with adj. temp. limit stops • included: test plug and cross flow plug 					
	U140CI	72.60	1/2" CC/IPS	6	
	U140X	72.60	1/2" Crimp Ring PEX + CC/IPS Tub	6	
	U140CX	72.60	1/2" Cold Exp. PEX + CC/IPS Tub	6	
 <ul style="list-style-type: none"> • tub/shower or shower only application • ports: four with adj. temp. limit stops • quarter turn stops: included 					
	U140CIS	104.50	1/2" CC/IPS	6	
	U140XS	104.50	1/2" Crimp Ring PEX + CC/IPS Tub	6	
	U140CXS	104.50	1/2" Cold Exp. PEX + CC/IPS Tub	6	
 <ul style="list-style-type: none"> • shower only application • ports: three 					
	U130CI	72.60	1/2" CC/IPS	6	
	U130X	72.60	1/2" Crimp Ring PEX	6	
 <ul style="list-style-type: none"> • shower only application • ports: three • quarter turn stops: included 					
	U130CIS	104.50	1/2" CC/IPS	6	
	U130XS	104.50	1/2" Crimp Ring PEX	6	
U130CXS	104.50	1/2" Cold Exp. PEX	6		
<p>Four port valves can be used with either Tub/Shower or Shower Only applications. Three port valves can ONLY be used with Shower Only applications. For more product details, reference page 471 in valve section.</p>					
<p>HOW TO ORDER VALVES: PAGE 471</p>					

COLINET™













		MODEL	LIST	FINISH/CONNECT	CASE QTY	
M-CORE® 3-SERIES TUB/SHOWER TRIM – PREMIUM						
 <ul style="list-style-type: none"> • showerhead: single-function rainshower • showerhead size: 10" diameter • tub spout length: 9" • tub spout connection type: slip fit • tub spout type: diverter • includes: pressure balanced cartridge with volume and temperature control • valve: sold separately 		2.5 GPM (9.5 L/min) max.				
		UTS344303	752.90	Chrome	3	
		UTS344303BN	1068.20	Brushed Nickel	3	
		UTS344303BG	1068.20	Brushed Gold	3	
		UTS344303BL	1175.00	Matte Black	3	
						
 <ul style="list-style-type: none"> • showerhead: single-function eco-performance rainshower • showerhead size: 10" diameter • tub spout length: 9" • tub spout connection type: slip fit • tub spout type: diverter • includes: pressure balanced cartridge with volume and temperature control • valve: sold separately 		1.75 GPM (6.65 L/min) max.				
		UTS344303EP	752.90	Chrome	3	
		UTS344303EPBN	1068.20	Brushed Nickel	3	
		UTS344303EPBG	1068.20	Brushed Gold	3	
		UTS344303EPBL	1175.00	Matte Black	3	
						
M-CORE® 3-SERIES SHOWER ONLY TRIM – PREMIUM						
 <ul style="list-style-type: none"> • showerhead: single-function rainshower • showerhead size: 10" diameter • includes: pressure balanced cartridge with volume and temperature control • valve: sold separately 		2.5 GPM (9.5 L/min) max.				
		UTS344302	631.75	Chrome	3	
		UTS344302BN	873.90	Brushed Nickel	3	
		UTS344302BG	873.90	Brushed Gold	3	
		UTS344302BL	961.35	Matte Black	3	
						
 <ul style="list-style-type: none"> • showerhead: single-function eco-performance rainshower • showerhead size: 10" diameter • includes: pressure balanced cartridge with volume and temperature control • valve: sold separately 		1.75 GPM (6.65 L/min) max.				
		UTS344302EP	631.75	Chrome	3	
		UTS344302EPBN	873.90	Brushed Nickel	3	
		UTS344302EPBG	873.90	Brushed Gold	3	
		UTS344302EPBL	961.35	Matte Black	3	
M-CORE® 3-SERIES VALVE ONLY TRIM – PREMIUM						
 <ul style="list-style-type: none"> • includes: pressure balanced cartridge with volume and temperature control • valve: sold separately 		UTS344301	531.05	Chrome	3	
		UTS344301BN	704.30	Brushed Nickel	3	
		UTS344301BG	704.30	Brushed Gold	3	
		UTS344301BL	774.70	Matte Black	3	
						
M-CORE® MIXING SHOWER VALVE						
 <ul style="list-style-type: none"> • tub/shower or shower only application • ports: four with adj. temp. limit stops • included: test plug and cross flow plug 		U140CI	72.60	1/2" CC/IPS	6	
		U140X	72.60	1/2" Crimp Ring PEX + CC/IPS Tub	6	
		U140CX	72.60	1/2" Cold Exp. PEX + CC/IPS Tub	6	
		U140V	88.95	1/2" CPVC + CC/IPS Tub	6	
 <ul style="list-style-type: none"> • tub/shower or shower only application • ports: four with adj. temp. limit stops • quarter turn stops: included 		U140CIS	104.50	1/2" CC/IPS	6	
		U140XS	104.50	1/2" Crimp Ring PEX + CC/IPS Tub	6	
		U140CXS	104.50	1/2" Cold Exp. PEX + CC/IPS Tub	6	
		U140VS	120.85	1/2" CPVC + CC/IPS Tub	6	
 <ul style="list-style-type: none"> • shower only application • ports: three 		U130CI	72.60	1/2" CC/IPS	6	
		U130X	72.60	1/2" Crimp Ring PEX	6	
		U130CX	72.60	1/2" Cold Exp. PEX	6	
 <ul style="list-style-type: none"> • shower only application • ports: three • quarter turn stops: included 		U130CIS	104.50	1/2" CC/IPS	6	
		U130XS	104.50	1/2" Crimp Ring PEX	6	
		U130CXS	104.50	1/2" Cold Exp. PEX	6	
<p>Four port valves can be used with either Tub/Shower or Shower Only applications. Three port valves can ONLY be used with Shower Only applications. For more product details, reference page 471 in valve section.</p>						
HOW TO ORDER VALVES: PAGE 471		 TRIM PART #	+	 VALVE PART #	=	 COMPLETE FAUCET

COLINET™ Collection















		MODEL	LIST	FINISH/CONNECT	CASE QTY		
M-CORE® 3-SERIES WITH INTEGRATED TRANSFER VALVE TRIM - PREMIUM							
 <ul style="list-style-type: none"> • includes: pressure balanced cartridge with volume and temperature control • valve: sold separately 		UTS9211	495.40	Chrome	4		
		UTS9211BN	718.40	Brushed Nickel	4		
		UTS9211BG	718.40	Brushed Gold	4		
		UTS9211BL	790.20	Matte Black	4		
M-CORE® WITH INTEGRATED TRANSFER VALVE							
Three Function (2 independent/1 shared) OR Six Function (3 independent/3 shared) - plumbing configuration page 478							
 <ul style="list-style-type: none"> • ports: four with adj. temp. limit stops • check stops: included 		U362CIS	270.70	1/2" CC/IPS	6		
		U362CXS	270.70	1/2" Cold Exp. PEX	6		
		U362XS	270.70	1/2" Crimp Ring PEX	6		
Two Independent Functions OR Three Independent Functions - plumbing configurations page 478							
 <ul style="list-style-type: none"> • ports: four with adj. temp. limit stops • check stops: included 		U232CIS	270.70	1/2" CC/IPS	6		
		U232CXS	270.70	1/2" Cold Exp. PEX	6		
		U232XS	270.70	1/2" Crimp Ring PEX	6		
For more product details, reference page 472 in valve section. See page 478 for plumbing configurations.							
HOW TO ORDER VALVES: PAGE 472		TRIM PART #	+		=		COMPLETE FAUCET

M-CORE® TRANSFER VALVE TRIM - PREMIUM							
 <ul style="list-style-type: none"> • use with the M-CORE® transfer valve • valve: sold separately 		UTS9381	322.20	Chrome	12		
		UTS9381BN	437.45	Brushed Nickel	12		
		UTS9381BG	437.45	Brushed Gold	12		
		UTS9381BL	481.20	Matte Black	12		
M-CORE® TRANSFER VALVE							
Three Function (2 independent/1 shared) OR Six Function (3 independent/3 shared) - plumbing configuration page 478							
 <ul style="list-style-type: none"> • number of functions: three or six • ports: four 		U361CI	152.70	1/2" CC/IPS	6		
		U361CX	152.70	1/2" Cold Exp. PEX	6		
		U361X	152.70	1/2" Crimp Ring PEX	6		
Two Independent Functions OR Three Independent Functions - plumbing configurations page 478							
 <ul style="list-style-type: none"> • number of functions: two or three • ports: four 		U231CI	152.70	1/2" CC/IPS	6		
		U231CX	152.70	1/2" Cold Exp. PEX	6		
		U231X	152.70	1/2" Crimp Ring PEX	6		
For more product details, reference page 472 in valve section. See page 478 for plumbing configurations.							
HOW TO ORDER VALVES: PAGE 472		TRIM PART #	+		=		COMPLETE FAUCET

MODEL LIST FINISH/CONNECT CASE QTY

M-CORE® 2-SERIES TUB/SHOWER TRIM – PREMIUM					
	<ul style="list-style-type: none"> • showerhead: single-function eco-performance rainshower • showerhead size: 10" diameter • tub spout length: 9" • tub spout connection type: slip fit • tub spout type: diverter • includes: pressure balanced cartridge with temperature control • valve: sold separately 	<p>1.75 GPM (6.65 L/min) max.</p>			
		UTS244203EP	692.65	Chrome	3
		UTS244203EPBN	961.95	Brushed Nickel	3
		UTS244203EPBG	961.95	Brushed Gold	3
		UTS244203EPBL	1042.75	Matte Black	3
<p> IMMERSON</p>					
M-CORE® 2-SERIES SHOWER ONLY TRIM – PREMIUM					
	<ul style="list-style-type: none"> • showerhead: single-function eco-performance rainshower • showerhead size: 10" diameter • includes: pressure balanced cartridge with temperature control • valve: sold separately 	<p>1.75 GPM (6.65 L/min) max.</p>			
		UTS244202EP	577.65	Chrome	3
		UTS244202EPBN	789.40	Brushed Nickel	3
		UTS244202EPBG	789.40	Brushed Gold	3
		UTS244202EPBL	852.85	Matte Black	3
<p> IMMERSON</p>					
M-CORE® 2-SERIES VALVE ONLY TRIM – PREMIUM					
	<ul style="list-style-type: none"> • includes: pressure balanced cartridge with temperature control • valve: sold separately 				
		UTS244201	433.85	Chrome	3
		UTS244201BN	573.85	Brushed Nickel	3
		UTS244201BG	573.85	Brushed Gold	3
		UTS244201BL	615.85	Matte Black	3
<p></p>					
M-CORE® MIXING SHOWER VALVE					
	<ul style="list-style-type: none"> • tub/shower or shower only application • ports: four with adj. temp. limit stops • included: test plug and cross flow plug 				
		U140CI	72.60	1/2" CC/IPS	6
		U140X	72.60	1/2" Crimp Ring PEX + CC/IPS Tub	6
		U140CX	72.60	1/2" Cold Exp. PEX + CC/IPS Tub	6
		U140V	88.95	1/2" CPVC + CC/IPS Tub	6
	<ul style="list-style-type: none"> • tub/shower or shower only application • ports: four with adj. temp. limit stops • quarter turn stops: included 				
		U140CIS	104.50	1/2" CC/IPS	6
		U140XS	104.50	1/2" Crimp Ring PEX + CC/IPS Tub	6
		U140CXS	104.50	1/2" Cold Exp. PEX + CC/IPS Tub	6
		U140VS	120.85	1/2" CPVC + CC/IPS Tub	6
	<ul style="list-style-type: none"> • shower only application • ports: three 				
		U130CI	72.60	1/2" CC/IPS	6
		U130X	72.60	1/2" Crimp Ring PEX	6
	<ul style="list-style-type: none"> • shower only application • ports: three • quarter turn stops: included 				
		U130CIS	104.50	1/2" CC/IPS	6
		U130XS	104.50	1/2" Crimp Ring PEX	6
	U130CXS	104.50	1/2" Cold Exp. PEX	6	
<p></p>					
<p>Four port valves can be used with either Tub/Shower or Shower Only applications. Three port valves can ONLY be used with Shower Only applications. For more product details, reference page 471 in valve section.</p>					
<p>HOW TO ORDER VALVES: PAGE 471</p>					

COLINET™ Collection

		MODEL	LIST	FINISH/CONNECT	CASE QTY	
POSI-TEMP® VALVE ONLY TRIM - PREMIUM						
 <ul style="list-style-type: none"> • valve: sold separately 	 	TS44201	279.85	Chrome	3	
		TS44201BN	419.85	Brushed Nickel	3	
		TS44201BG	419.85	Brushed Gold	3	
		TS44201BL	461.80	Matte Black	3	
POSI-TEMP® SHOWER MIXING VALVES						
 <ul style="list-style-type: none"> • tub/shower or shower only application • ports: four with adjustable temp. limit stops • test plug: included 		2520 ◆	159.20	1/2" CC	6	
		2510 ◆	159.20	1/2" IPS	6	
 <ul style="list-style-type: none"> • tub/shower or shower only application • ports: four with adjustable temp. limit stops • quarter turn stops: included • test plug: included 		2570 ◆	193.35	1/2" CC	6	
		2590 ◆	193.35	1/2" IPS	6	
		2580 ◆	159.20	1/2" Crimp ring PEX	6	
 <ul style="list-style-type: none"> • tub/shower only application • ports: four with adjustable temp. limit stops • quarter turn stops: included • test plug: included 		2360PF	212.60	1/2" Crimp Ring PEX	3	
 <ul style="list-style-type: none"> • shower only application • ports: three with adjustable temp. limit stops • quarter turn stops: included • test plug: included 		2326PF	205.20	1/2" Crimp Ring PEX	6	
		2328PF	205.20	1/2" Cold Exp. PEX	6	
Four port valves can be used with either Tub/Shower or Shower Only applications. Three port valves can ONLY be used with Shower Only applications. For more product details, reference page 473-476 in valve section.						
HOW TO ORDER VALVES: PAGES 473-476		 TRIM PART #	+	 VALVE PART #	=	 COMPLETE FAUCET

Moen® bath accessories CANNOT be combined with Moen faucet parts on a Purchase Order.

A line of matching accessories - including tank levers and towel bars - allow for a completely cohesive look in the bath.

MODEL NUMBER	LIST EACH	DESCRIPTION	QTY
PREMIUM			
Chrome (CH)			
YB0501CH	92.45	Tank Lever	24
YB0503CH	70.90	Double Robe Hook	24
YB0505CH	18.60	Drawer Knob	48
YB0507CH	37.40	Drawer Pull	48
Ⓟ YB0508CH	130.35	Pivoting Paper Holder	6
YB0518CH	150.00	18" Towel Bar	6
YB0524CH	155.30	24" Towel Bar	6
YB0586CH	104.75	Towel Ring	6
Brushed Nickel (BN)			
YB0501BN	120.20	Tank Lever	9
YB0503BN	92.15	Double Robe Hook	24
YB0505BN	24.25	Drawer Knob	48
YB0507BN	48.65	Drawer Pull	48
Ⓟ YB0508BN	169.45	Pivoting Paper Holder	6
YB0518BN	194.95	18" Towel Bar	6
YB0524BN	201.85	24" Towel Bar	6
YB0586BN	136.25	Towel Ring	6
Matte Black (BL)			
YB0501BL	132.25	Tank Lever	24
YB0503BL	101.40	Double Robe Hook	24
YB0505BL	26.70	Drawer Knob	48
YB0507BL	53.45	Drawer Pull	48
Ⓟ YB0508BL	186.50	Pivoting Paper Holder	6
YB0518BL	214.50	18" Towel Bar	6
YB0524BL	222.00	24" Towel Bar	6
YB0586BL	149.90	Towel Ring	6
Brushed Gold (BG)			
YB0501BG	138.75	Tank Lever	24
YB0503BG	106.30	Double Robe Hook	24
YB0505BG	28.00	Drawer Knob	48
YB0507BG	56.15	Drawer Pull	48
Ⓟ YB0508BG	195.60	Pivoting Paper Holder	6
YB0518BG	224.95	18" Towel Bar	6
YB0524BG	232.90	24" Towel Bar	6
YB0586BG	157.20	Towel Ring	6

Ⓟ Denotes pivoting paper holder



Tank Lever

YB0501



Double Robe Hook

YB0503



Towel Ring

YB0586



Pivoting Paper Holder

YB0508 | Ⓟ



Drawer Knob

YB0505



18" Towel Bar

YB0518

24" Towel Bar

YB0524



Drawer Pull

YB0507





LIGHTING

MODEL NUMBER	LIST EACH	DESCRIPTION	QTY
PREMIUM			
Chrome (CH)			
YB0561CH	237.55	One Globe Bath Light	2
YB0562CH	332.40	Two Globe Bath Light	2
YB0563CH	412.80	Three Globe Bath Light	2
YB0564CH	515.90	Four Globe Bath Light	2
Brushed Nickel (BN)			
YB0561BN	308.75	One Globe Bath Light	2
YB0562BN	432.10	Two Globe Bath Light	2
YB0563BN	536.55	Three Globe Bath Light	2
YB0564BN	670.70	Four Globe Bath Light	2
Matte Black (BL)			
YB0561BL	339.65	One Globe Bath Light	2
YB0562BL	475.30	Two Globe Bath Light	2
YB0563BL	590.20	Three Globe Bath Light	2
YB0564BL	737.75	Four Globe Bath Light	2
Brushed Gold (BG)			
YB0561BG	356.35	One Globe Bath Light	2
YB0562BG	498.70	Two Globe Bath Light	2
YB0563BG	619.15	Three Globe Bath Light	2
YB0564BG	773.95	Four Globe Bath Light	2
Replacement Globe			
YB0569	42.80	Replacement Globe	3



One Globe Bath Light

YB0561



Two Globe Bath Light

YB0562



Three Globe Bath Light

YB0563



Four Globe Bath Light

YB0564



Replacement Globe

YB0569













Bulbs not included.



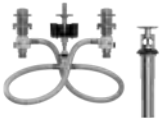





List price is per each (unless otherwise noted).









Product can be ordered by case quantity or individually.









One, Three and Four Colinet lighting fixtures can be mounted facing either upward or downward
Two Globe lighting can be mounted facing either vertically or horizontally without the need to remove the rings.



















	MODEL	LIST	FINISH/CONNECT	CASE QTY	
ONE-HANDLE BATHROOM FAUCET - PREMIUM					
 DECKPLATE SOLD SEPARATELY 	<ul style="list-style-type: none"> • application: one or three hole • supply lines: flexible • connection: 3/8" compression • deckplate: sold separately • drain assembly: metal with lift rod 	1.2 GPM (4.5L/min) max. S6710	604.20	Chrome	3
	<ul style="list-style-type: none"> • application: one or three hole • supply lines: flexible • connection: 3/8" compression • deckplate: sold separately • drain assembly: 140780 sold separately 	S6710BN S6710BL	906.30 936.50	Brushed Nickel Matte Black	3 3
OPTIONAL DECKPLATE SOLD SEPARATELY					
		147204	31.05	Chrome	12
		147204BN	75.20	Brushed Nickel	12
		147204BL	82.70	Matte Black	12
ONE-HANDLE BATHROOM FAUCET - PREMIUM					
 DECKPLATE SOLD SEPARATELY 	<ul style="list-style-type: none"> • application: one or three hole • supply lines: flexible • connection: 3/8" compression • deckplate: sold separately • drain assembly: 140780 sold separately 	1.2 GPM (4.5L/min) max. S6712	845.70	Chrome	3
	<ul style="list-style-type: none"> • application: one or three hole • supply lines: flexible • connection: 3/8" compression • deckplate: sold separately • drain assembly: 140780 sold separately 	S6712BN S6712BL	1099.40 1141.65	Brushed Nickel Matte Black	3 3
OPTIONAL DECKPLATE SOLD SEPARATELY					
		147204	31.05	Chrome	12
		147204BN	75.20	Brushed Nickel	12
		147204BL	82.70	Matte Black	12
OPTION: VESSEL EXTENSION KIT					
	<ul style="list-style-type: none"> • description: vessel extension kit • included: parts to convert to grid drain • included: two extensions • fits S6710 and S6718 	147556	163.35	Chrome	6
		147556BN	239.55	Brushed Nickel	6
		147556BL	263.50	Matte Black	6
OPTION: DRAIN ASSEMBLY					
	<ul style="list-style-type: none"> • drain assembly: metal • drain assembly type: spring loaded pop-up • drain assembly size: 1-1/4" • drain assembly: 1-1/4" non-overflow 	140780	78.35	Chrome	12
TWO-HANDLE WIDESPREAD BATHROOM FAUCET TRIM - PREMIUM					
	<ul style="list-style-type: none"> • application: three hole • center dimensions: 8" - 16" center • drain assembly: metal with lift rod • red/blue markings: included • valve: sold separately 	1.2 GPM (4.5L/min) max. TS6721	540.90	Chrome	3
		TS6721BN	811.35	Brushed Nickel	3
		TS6721BL	838.40	Matte Black	3
WIDESPREAD FAUCET VALVE					
	<ul style="list-style-type: none"> • application: three hole • center dimensions: 8" - 16" center • drain assembly: metal with lift rod 	9000 ◆	165.40	1/2" IPS	6
	<ul style="list-style-type: none"> • application: three hole • center dimensions: 8" - 16" center • drain assembly: metal with lift rod 				
					
HOW TO ORDER VALVES: PAGE 469					
 TRIM PART # +  VALVE PART # =  COMPLETE FAUCET					











		MODEL	LIST	FINISH/CONNECT	CASE QTY
TWO-HANDLE WALLMOUNT BATHROOM FAUCET TRIM - PREMIUM					
 <ul style="list-style-type: none"> • application: three hole • center dimensions: 8" center • drain assembly: 140780 sold separately • valve: sold separately 			1.2 GPM (4.5L/min) max.		
		TS6731	627.35	Chrome	3
		TS6731BN	846.90	Brushed Nickel	3
		TS6731BL	878.30	Matte Black	3
TWO-HANDLE WALLMOUNT FAUCET VALVE					
 <ul style="list-style-type: none"> • application: three hole • center dimensions: 8" center • drain assembly: 140780 sold separately • includes: mounting brackets  DURALAST®		9700	233.95	1/2" CC	3
	HOW TO ORDER VALVES: PAGE 469  TRIM PART # +  VALVE PART # =  COMPLETE FAUCET				
OPTION: DRAIN ASSEMBLY					
 <ul style="list-style-type: none"> • drain assembly: metal • drain assembly type: spring loaded pop-up • drain assembly size: 1-1/4" • drain assembly: 1-1/4" non-overflow 		140780	78.35	Chrome	12
		140780BN	109.20	Brushed Nickel	12
		140780BL	123.30	Matte Black	12









FREESTANDING TUB FILLER TRIM - PREMIUM					
 <ul style="list-style-type: none"> • application: one hole • showerhead type: handshower • handshower functions: one-function • handshower flow rate: 1.75 gpm (6.65L/min) max. • spout reach: 11.00" • mounting kit: sold separately 		S905	2291.55	Chrome	1
		S905BN	3093.50	Brushed Nickel	1
		S905BL	3093.55	Matte Black	1
	FREESTANDING TUB FILLER VALVE AND MOUNTING KIT - PREMIUM				
 <ul style="list-style-type: none"> • description: single riser floor joist mounting kit • application: one hole • quarter turn stops: included 		TS50100	408.90	1/2" CC, NPT	2
	 <ul style="list-style-type: none"> • description: single riser concrete mounting kit • application: one hole • connection size: 1/2" 		TS50110	332.45	1/2" CC, NPT
HOW TO ORDER VALVES: PAGE 469  TRIM PART # +  VALVE PART # =  COMPLETE FAUCET					















	MODEL	LIST	FINISH/CONNECT	CASE QTY	
ONE-HANDLE WALLMOUNT TUB FILLER TRIM – PREMIUM					
 <ul style="list-style-type: none"> • application: two hole • connection: 1/2" slip fit • tub spout type: non diverter • spout reach: 10.00" • includes: high flow volume control cartridge • WMV130 series valve kit: sold separately 	WTS911	806.05	Chrome	3	
	WTS911BN	1136.55	Brushed Nickel	3	
	WTS911BL	1168.75	Matte Black	3	
ONE-HANDLE WALLMOUNT TUB FILLER VALVE KIT					
 <ul style="list-style-type: none"> • application: two hole with adj. center dimensions • ports: three • quarter turn stops: included • includes: test plug • includes: spout manifold 	WMV130CIS	154.05	1/2" CC/IPS	6	
	WMV130XS	154.05	1/2" Crimp Ring PEX	6	
	WMV130CXS	154.05	1/2" Cold Exp. PEX	6	
HOW TO ORDER VALVES: PAGE 469	 TRIM PART # 		 VALVE PART # 		 COMPLETE FAUCET

















TWO-HANDLE ROMAN TUB TRIM – PREMIUM					
 <ul style="list-style-type: none"> • application: three hole • spout reach: 8.20" • valve: sold separately 	TS913	756.75	Chrome	3	
	TS913BN	1059.40	Brushed Nickel	3	
	TS913BL	1097.25	Matte Black	3	
TWO-HANDLE ROMAN TUB TRIM WITH HANDSHOWER – PREMIUM					
 <ul style="list-style-type: none"> • application: four hole • showerhead type: handshower • handshower flow rate: 1.75 gpm (6.65 L/min) max. • spray functions: one-function • spout reach: 8.20" • valve: sold separately 	TS914	1178.60	Chrome	3	
	TS914BN	1977.55	Brushed Nickel	3	
	TS914BL	2003.65	Matte Black	3	
TWO-HANDLE ROMAN TUB VALVE					
 <ul style="list-style-type: none"> • deck thickness: 1/8" to 3-3/8" rough-in deck • adjustable spout shank: adjustable center dimensions  DURALAST®	4792	192.30	1/2" CC	6	
	 <ul style="list-style-type: none"> • deck thickness: 1/8" to 2-3/4" rough-in deck • adjustable spout shank: 10" - 24" center dimensions  DURALOCK® DURALAST®	4793	217.80	1/2" CPVC, Crimp Ring PEX	6
 <ul style="list-style-type: none"> • deck thickness: 1/8" to 3-3/16" rough-in deck • Non-adjustable spout shank: 10" center dimensions  DURALAST®		4796	181.20	1/2" CC	6
	4797	184.70	1/2" CPVC, Crimp Ring PEX	6	
	4798	184.70	1/2" Crimp Ring PEX, Cold Exp. PEX	6	
TWO-HANDLE ROMAN TUB VALVE WITH HANDSHOWER					
 <ul style="list-style-type: none"> • deck thickness: 1/8" to 2-5/8" rough-in deck • non-adj spout shank: adjustable center dim's  DURALAST®	9792	433.35	1/2" CC	6	
	 <ul style="list-style-type: none"> • deck thickness: 1/8" to 2-5/8" rough-in deck • adj spout shank: 10" - 24" center dimensions  DURALOCK® DURALAST®	9793	443.50	1/2" CPVC, Crimp Ring PEX	6
For more product details, reference page 470 in valve section.					
HOW TO ORDER VALVES: PAGE 470	 TRIM PART # 		 VALVE PART # 		 COMPLETE FAUCET











90°® Collection











		MODEL	LIST	FINISH/CONNECT	CASE QTY	
EXACTTEMP® VALVE ONLY TRIM - PREMIUM						
 <ul style="list-style-type: none"> • description: temperature control valve trim • requires: separate volume control valve • valve: sold separately  		TS3100	406.20	Chrome	3	
		TS3100BN	614.45	Brushed Nickel	3	
		TS3100BL	629.60	Matte Black	3	
EXACTTEMP® THERMOSTATIC MIXING SHOWER VALVE - PREMIUM						
 <ul style="list-style-type: none"> • description: thermostatic rough-in valve • ports: four with adjustable temp. limit stops • check stops: included 		S3371	728.95	¾" IPS	6	
HOW TO ORDER VALVES: PAGE 471		 TRIM PART #	+	 VALVE PART #	=	 COMPLETE FAUCET



















EXACTTEMP® VOLUME CONTROL VALVE TRIM - PREMIUM						
 <ul style="list-style-type: none"> • valve: sold separately  		TS3300	187.55	Chrome	6	
		TS3300BN	250.05	Brushed Nickel	6	
		TS3300BL	253.10	Matte Black	6	
EXACTTEMP® VOLUME CONTROL SHOWER VALVE - PREMIUM						
 <ul style="list-style-type: none"> • includes: volume control 		S3600	185.35	¾" IPS	12	
HOW TO ORDER VALVES: PAGE 471		 TRIM PART #	+	 VALVE PART #	=	 COMPLETE FAUCET

















		MODEL	LIST	FINISH/CONNECT	CASE QTY
M-CORE® 4-SERIES TUB/SHOWER TRIM – PREMIUM					
 <ul style="list-style-type: none"> • showerhead: single-function eco-performance rainshower • showerhead size: 6" diameter • tub spout length: 7 1/4" • tub spout connection type: slip fit • tub spout type: diverter • includes: thermostatic cartridge with volume and temperature control • valve: sold separately 	<ul style="list-style-type: none"> • 1.75 GPM (6.65 L/min) max. 				
		UTS4713EP	791.95	Chrome	4
		UTS4713EPBN	1391.60	Brushed Nickel	4
		UTS4713EPBL	1413.45	Matte Black	4
M-CORE® 4-SERIES SHOWER ONLY TRIM – PREMIUM					
 <ul style="list-style-type: none"> • showerhead: single-function eco-performance rainshower • showerhead size: 6" diameter • includes: thermostatic cartridge with volume and temperature control • valve: sold separately 	<ul style="list-style-type: none"> • 1.75 GPM (6.65 L/min) max. 				
		UTS4715EP	668.20	Chrome	4
		UTS4715EPBN	1159.75	Brushed Nickel	4
		UTS4715EPBL	1172.20	Matte Black	4
M-CORE® 4-SERIES VALVE ONLY TRIM – PREMIUM					
 <ul style="list-style-type: none"> • includes: thermostatic cartridge with volume and temperature control • valve: sold separately 					
		UTS4711	581.60	Chrome	3
		UTS4711BN	968.30	Brushed Nickel	3
	UTS4711BL	981.10	Matte Black	3	
M-CORE® MIXING SHOWER VALVE					
 <ul style="list-style-type: none"> • tub/shower or shower only application • ports: four with adj. temp. limit stops • included: test plug and cross flow plug 					
		U140CI	72.60	1/2" CC/IPS	6
		U140X	72.60	1/2" Crimp Ring PEX + CC/IPS Tub	6
		U140CX	72.60	1/2" Cold Exp. PEX + CC/IPS Tub	6
 <ul style="list-style-type: none"> • tub/shower or shower only application • ports: four with adj. temp. limit stops • quarter turn stops: included 					
		U140CIS	104.50	1/2" CC/IPS	6
		U140XS	104.50	1/2" Crimp Ring PEX + CC/IPS Tub	6
		U140CXS	104.50	1/2" Cold Exp. PEX + CC/IPS Tub	6
 <ul style="list-style-type: none"> • shower only application • ports: three 					
		U140VS	120.85	1/2" CPVC + CC/IPS Tub	6
		U130CI	72.60	1/2" CC/IPS	6
		U130X	72.60	1/2" Crimp Ring PEX	6
 <ul style="list-style-type: none"> • shower only application • ports: three • quarter turn stops: included 					
		U130CX	72.60	1/2" Cold Exp. PEX	6
		U130CIS	104.50	1/2" CC/IPS	6
		U130XS	104.50	1/2" Crimp Ring PEX	6
	U130CXS	104.50	1/2" Cold Exp. PEX	6	
<p>Four port valves can be used with either Tub/Shower or Shower Only applications. Three port valves can ONLY be used with Shower Only applications. For more product details, reference page 471 in valve section.</p>					
<p>HOW TO ORDER VALVES: PAGE 471</p>					















		MODEL	LIST	FINISH/CONNECT	CASE QTY	
M-CORE® 3-SERIES TUB/SHOWER TRIM – PREMIUM						
 <ul style="list-style-type: none"> • showerhead: single-function rainshower • showerhead size: 6" diameter • tub spout length: 7 1/4" • tub spout connection type: slip fit • tub spout type: diverter • includes: pressure balanced cartridge with volume and temperature control • valve: sold separately 		2.5 GPM (9.5 L/min) max.				
		UTS3713	654.25	Chrome	4	
		UTS3713BN	1253.90	Brushed Nickel	4	
		UTS3713BL	1275.75	Matte Black	4	
		1.75 GPM (6.65 L/min) max.				
		UTS3713EP	654.25	Chrome	4	
		UTS3713EPBN	1253.90	Brushed Nickel	4	
		UTS3713EPBL	1275.75	Matte Black	4	
	M-CORE® 3-SERIES SHOWER ONLY TRIM – PREMIUM					
	 <ul style="list-style-type: none"> • showerhead: single-function rainshower • showerhead size: 6" diameter • includes: pressure balanced cartridge with volume and temperature control • valve: sold separately 		2.5 GPM (9.5 L/min) max.			
		UTS3715	530.50	Chrome	4	
		UTS3715BN	1022.05	Brushed Nickel	4	
		UTS3715BL	1034.50	Matte Black	4	
		1.75 GPM (6.65 L/min) max.				
		UTS3715EP	530.50	Chrome	4	
		UTS3715EPBN	1022.05	Brushed Nickel	4	
		UTS3715EPBL	1034.50	Matte Black	4	
M-CORE® 3-SERIES VALVE ONLY TRIM – PREMIUM						
 <ul style="list-style-type: none"> • includes: pressure balanced cartridge with volume and temperature control • valve: sold separately 			UTS3711	443.90	Chrome	3
		UTS3711BN	830.60	Brushed Nickel	3	
		UTS3711BL	843.40	Matte Black	3	
	M-CORE® MIXING SHOWER VALVE					
 <ul style="list-style-type: none"> • tub/shower or shower only application • ports: four with adj. temp. limit stops • included: test plug and cross flow plug 		U140CI	72.60	1/2" CC/IPS	6	
		U140X	72.60	1/2" Crimp Ring PEX + CC/IPS Tub	6	
		U140CX	72.60	1/2" Cold Exp. PEX + CC/IPS Tub	6	
		U140V	88.95	1/2" CPVC + CC/IPS Tub	6	
 <ul style="list-style-type: none"> • tub/shower or shower only application • ports: four with adj. temp. limit stops • quarter turn stops: included 		U140CIS	104.50	1/2" CC/IPS	6	
		U140XS	104.50	1/2" Crimp Ring PEX + CC/IPS Tub	6	
		U140CXS	104.50	1/2" Cold Exp. PEX + CC/IPS Tub	6	
		U140VS	120.85	1/2" CPVC + CC/IPS Tub	6	
 <ul style="list-style-type: none"> • shower only application • ports: three 		U130CI	72.60	1/2" CC/IPS	6	
		U130X	72.60	1/2" Crimp Ring PEX	6	
		U130CX	72.60	1/2" Cold Exp. PEX	6	
 <ul style="list-style-type: none"> • shower only application • ports: three • quarter turn stops: included 		U130CIS	104.50	1/2" CC/IPS	6	
		U130XS	104.50	1/2" Crimp Ring PEX	6	
		U130CXS	104.50	1/2" Cold Exp. PEX	6	
Four port valves can be used with either Tub/Shower or Shower Only applications. Three port valves can ONLY be used with Shower Only applications. For more product details, reference page 471 in valve section.						
HOW TO ORDER VALVES: PAGE 471		 TRIM PART # +  VALVE PART # =  COMPLETE FAUCET				

		MODEL	LIST	FINISH/CONNECT	CASE QTY			
M-CORE® 3-SERIES WITH INTEGRATED TRANSFER VALVE TRIM - PREMIUM								
 <ul style="list-style-type: none"> • includes: pressure balanced cartridge with volume and temperature control • valve: sold separately  		UTS9011	428.80	Chrome	4			
		UTS9011BN	620.85	Brushed Nickel	4			
		UTS9011BL	643.20	Matte Black	4			
M-CORE® WITH INTEGRATED TRANSFER VALVE								
Three Function (2 independent/1 shared) OR Six Function (3 independent/3 shared) - plumbing configuration page 478								
 <ul style="list-style-type: none"> • ports: four with adj. temp. limit stops • check stops: included 		U362CIS	270.70	1/2" CC/IPS	6			
		U362CXS	270.70	1/2" Cold Exp. PEX	6			
		U362XS	270.70	1/2" Crimp Ring PEX	6			
Two Independent Functions OR Three Independent Functions - plumbing configurations page 478								
 <ul style="list-style-type: none"> • ports: four with adj. temp. limit stops • check stops: included 		U232CIS	270.70	1/2" CC/IPS	6			
		U232CXS	270.70	1/2" Cold Exp. PEX	6			
		U232XS	270.70	1/2" Crimp Ring PEX	6			
For more product details, reference page 472 in valve section. See page 478 for plumbing configurations.								
HOW TO ORDER VALVES: PAGE 472		TRIM PART #	+		VALVE PART #	=		COMPLETE FAUCET

M-CORE® TRANSFER VALVE TRIM - PREMIUM								
 <ul style="list-style-type: none"> • use with the M-CORE® transfer valve • valve: sold separately  		UTS4172	303.45	Chrome	12			
		UTS4172BN	377.80	Brushed Nickel	12			
		UTS4172BL	394.50	Matte Black	12			
M-CORE® TRANSFER VALVE								
Three Function (2 independent/1 shared) OR Six Function (3 independent/3 shared) - plumbing configuration page 478								
 <ul style="list-style-type: none"> • number of functions: three or six • ports: four 		U361CI	152.70	1/2" CC/IPS	6			
		U361CX	152.70	1/2" Cold Exp. PEX	6			
		U361X	152.70	1/2" Crimp Ring PEX	6			
Two Independent Functions OR Three Independent Functions - plumbing configurations page 478								
 <ul style="list-style-type: none"> • number of functions: two or three • ports: four 		U231CI	152.70	1/2" CC/IPS	6			
		U231CX	152.70	1/2" Cold Exp. PEX	6			
		U231X	152.70	1/2" Crimp Ring PEX	6			
For more product details, reference page 472 in valve section. See page 478 for plumbing configurations.								
HOW TO ORDER VALVES: PAGE 472		TRIM PART #	+		VALVE PART #	=		COMPLETE FAUCET

		MODEL	LIST	FINISH/CONNECT	CASE QTY
M-CORE® 2-SERIES TUB/SHOWER TRIM – PREMIUM					
 <ul style="list-style-type: none"> • showerhead: single-function eco-performance rainshower • showerhead size: 6" diameter • tub spout length: 7 1/4" • tub spout connection type: slip fit • tub spout type: diverter • includes: pressure balanced cartridge with temperature control • valve: sold separately 		 1.75 GPM (6.65 L/min) max.			
		UTS2713EP	555.45	Chrome	4
		UTS2713EPBN	903.85	Brushed Nickel	4
		UTS2713EPBL	916.50	Matte Black	4
M-CORE® 2-SERIES SHOWER ONLY TRIM – PREMIUM					
 <ul style="list-style-type: none"> • showerhead: single-function eco-performance rainshower • showerhead size: 6" diameter • includes: pressure balanced cartridge with temperature control • valve: sold separately 		 1.75 GPM (6.65 L/min) max.			
		UTS2712EP	468.25	Chrome	4
		UTS2712EPBN	742.25	Brushed Nickel	4
		UTS2712EPBL	772.60	Matte Black	4
M-CORE® 2-SERIES VALVE ONLY TRIM – PREMIUM					
 <ul style="list-style-type: none"> • includes: pressure balanced cartridge with temperature control • valve: sold separately 		UTS2711	387.75	Chrome	3
		UTS2711BN	593.05	Brushed Nickel	3
		UTS2711BL	598.50	Matte Black	3
	M-CORE® MIXING SHOWER VALVE				
 <ul style="list-style-type: none"> • tub/shower or shower only application • ports: four with adj. temp. limit stops • included: test plug and cross flow plug 		U140CI	72.60	1/2" CC/IPS	6
		U140X	72.60	1/2" Crimp Ring PEX + CC/IPS Tub	6
		U140CX	72.60	1/2" Cold Exp. PEX + CC/IPS Tub	6
		U140V	88.95	1/2" CPVC + CC/IPS Tub	6
 <ul style="list-style-type: none"> • tub/shower or shower only application • ports: four with adj. temp. limit stops • quarter turn stops: included 		U140CIS	104.50	1/2" CC/IPS	6
		U140XS	104.50	1/2" Crimp Ring PEX + CC/IPS Tub	6
		U140CXS	104.50	1/2" Cold Exp. PEX + CC/IPS Tub	6
		U140VS	120.85	1/2" CPVC + CC/IPS Tub	6
 <ul style="list-style-type: none"> • shower only application • ports: three 		U130CI	72.60	1/2" CC/IPS	6
		U130X	72.60	1/2" Crimp Ring PEX	6
		U130CX	72.60	1/2" Cold Exp. PEX	6
 <ul style="list-style-type: none"> • shower only application • ports: three • quarter turn stops: included 		U130CIS	104.50	1/2" CC/IPS	6
		U130XS	104.50	1/2" Crimp Ring PEX	6
		U130CXS	104.50	1/2" Cold Exp. PEX	6
<p>Four port valves can be used with either Tub/Shower or Shower Only applications. Three port valves can ONLY be used with Shower Only applications. For more product details, reference page 471 in valve section.</p>					
<p>HOW TO ORDER VALVES: PAGE 471</p>		 TRIM PART # +  VALVE PART # =  COMPLETE FAUCET			

		MODEL	LIST	FINISH/CONNECT	CASE QTY		
POSI-TEMP® TUB/SHOWER TRIM - PREMIUM							
	<ul style="list-style-type: none"> • showerhead: single-function rainshower • showerhead size: 6" diameter • tub spout length: 7 1/4" • tub spout connection type: slip fit • tub spout type: diverter • valve: sold separately 	2.5 GPM (9.5 L/min) max.					
		TS2713	408.70	Chrome	3		
		TS2713BN	757.20	Brushed Nickel	3		
		TS2713BL	776.55	Matte Black	3		
		1.75 GPM (6.65 L/min) max.					
		TS2713EP	408.70	Chrome	3		
		TS2713EPBN	757.20	Brushed Nickel	3		
		TS2713EPBL	776.55	Matte Black	3		
		POSI-TEMP® SHOWER ONLY TRIM - PREMIUM					
			<ul style="list-style-type: none"> • showerhead: single-function rainshower • showerhead size: 6" diameter • valve: sold separately 	2.5 GPM (9.5 L/min) max.			
TS2712	321.55			Chrome	3		
TS2712BN	595.55			Brushed Nickel	3		
TS2712BL	610.95			Matte Black	3		
1.75 GPM (6.65 L/min) max.							
TS2712EP	321.55			Chrome	3		
TS2712EPBN	595.55			Brushed Nickel	3		
TS2712EPBL	610.95	Matte Black	3				
POSI-TEMP® VALVE ONLY TRIM - PREMIUM							
	<ul style="list-style-type: none"> • valve: sold separately 	TS2711	241.05	Chrome	3		
		TS2711BN	446.35	Brushed Nickel	3		
		TS2711BL	450.45	Matte Black	3		
		POSI-TEMP® SHOWER MIXING VALVES					
	<ul style="list-style-type: none"> • tub/shower or shower only application • ports: four with adjustable temp. limit stops • test plug: included 	2520 ◆	159.20	1/2" CC	6		
		2510 ◆	159.20	1/2" IPS	6		
	<ul style="list-style-type: none"> • tub/shower or shower only application • ports: four with adjustable temp. limit stops • quarter turn stops: included • test plug: included 	2570 ◆	193.35	1/2" CC	6		
		2590 ◆	193.35	1/2" IPS	6		
		2580 ◆	159.20	1/2" Crimp ring PEX	6		
		POSI-TEMP® SHOWER MIXING VALVES					
	<ul style="list-style-type: none"> • tub/shower only application • ports: four with adjustable temp. limit stops • quarter turn stops: included • test plug: included 	2360PF	212.60	1/2" Crimp Ring PEX	3		
		POSI-TEMP® SHOWER MIXING VALVES					
	<ul style="list-style-type: none"> • shower only application • ports: three with adjustable temp. limit stops • quarter turn stops: included • test plug: included 	2326PF	205.20	1/2" Crimp Ring PEX	6		
		2328PF	205.20	1/2" Cold Exp. PEX	6		
<p>Four port valves can be used with either Tub/Shower or Shower Only applications. Three port valves can ONLY be used with Shower Only applications. For more product details, reference page 473-476 in valve section.</p>							
HOW TO ORDER VALVES: PAGES 473-476		 TRIM PART #	+	 VALVE PART #	=	 COMPLETE FAUCET	

		MODEL	LIST	FINISH/CONNECT	CASE QTY
POSI-TEMP® WITH INTEGRATED TRANSFER VALVE TRIM - PREMIUM					
 <ul style="list-style-type: none"> • valve: sold separately 		TS2710	495.85	Chrome	4
	 	TS2710BN	918.05	Brushed Nickel	4
		TS2710BL	942.10	Matte Black	4
POSI-TEMP® WITH INTEGRATED TRANSFER VALVE					
 <ul style="list-style-type: none"> • functions: three (two independent and one shared) • ports: four with adjustable temp. limit stops • test plug: included 		2551	287.50	1/2" IPS	6
					
 <ul style="list-style-type: none"> • functions: three (two independent and one shared) • ports: four with adjustable temp. limit stops • stops: included • test plug: included 		2581	323.75	1/2" IPS	6
					
 <ul style="list-style-type: none"> • functions: two independent • ports: four with adjustable temp. limit stops • test plug: included 		2521	287.50	1/2" IPS	6
					
 <ul style="list-style-type: none"> • functions: two independent • ports: four with adjustable temp. limit stops • stops: included • test plug: included 		2571	323.75	1/2" IPS	6
					
For more product details, reference page 477 in valve section.					
HOW TO ORDER VALVES: PAGE 477	 TRIM PART #	+	 VALVE PART #	=	 COMPLETE FAUCET

Moen® bath accessories CANNOT be combined with Moen faucet parts on a Purchase Order.

A line of matching accessories - including tank levers and towel bars - allow for a completely cohesive look in the bath.

MODEL NUMBER	LIST EACH	DESCRIPTION	QTY
PREMIUM			
Chrome (CH)			
YB8801CH	84.75	Tank Lever	24
YB8803CH	64.90	Single Robe Hook	24
YB8805CH	17.15	Drawer Knob	48
YB8807CH	34.30	Drawer Pull	48
Ⓟ YB8808CH	119.50	Pivoting Paper Holder	6
YB8818CH	137.50	18" Towel Bar	6
YB8824CH	142.45	24" Towel Bar	6
YB8886CH	96.00	Hand Towel Bar	6
Brushed Nickel (BN)			
YB8801BN	91.50	Tank Lever	24
YB8803BN	70.30	Single Robe Hook	24
YB8805BN	19.80	Drawer Knob	48
YB8807BN	37.10	Drawer Pull	48
Ⓟ YB8808BN	128.95	Pivoting Paper Holder	6
YB8818BN	148.45	18" Towel Bar	6
YB8824BN	153.90	24" Towel Bar	6
YB8886BN	103.60	Hand Towel Bar	6
Matte Black (BL)			
YB8801BL	99.70	Tank Lever	24
YB8803BL	76.60	Single Robe Hook	24
YB8805BL	21.55	Drawer Knob	48
YB8807BL	40.40	Drawer Pull	48
Ⓟ YB8808BL	140.55	Pivoting Paper Holder	6
YB8818BL	161.80	18" Towel Bar	6
YB8824BL	167.75	24" Towel Bar	6
YB8886BL	112.90	Hand Towel Bar	6

Ⓟ Denotes pivoting paper holder

GRAB BARS

MODEL NUMBER	LIST EACH	DESCRIPTION	QTY
PREMIUM			
1½" • Chrome (CH)			
YG8812CH	196.40	12" Designer Grab Bar	6
YG8818CH	205.20	18" Designer Grab Bar	6
YG8824CH	214.40	24" Designer Grab Bar	6
YG8836CH	244.05	36" Designer Grab Bar	6
YG8842CH	359.25	42" Designer Grab Bar	6
1½" • Brushed Nickel (BN)			
YG8812BN	212.25	12" Designer Grab Bar	6
YG8818BN	222.45	18" Designer Grab Bar	6
YG8824BN	240.10	24" Designer Grab Bar	6
YG8836BN	270.35	36" Designer Grab Bar	6
YG8842BN	397.15	42" Designer Grab Bar	6
1½" • Matte Black (BL)			
YG8812BL	231.40	12" Designer Grab Bar	6
YG8818BL	242.50	18" Designer Grab Bar	6
YG8824BL	261.70	24" Designer Grab Bar	6
YG8836BL	294.70	36" Designer Grab Bar	6
YG8842BL	432.90	42" Designer Grab Bar	6

Ⓢ Complies with Americans with Disabilities Act (ADA) specifications. SecureMount™ Grab Bars are tested to withstand 500 lb. pull when securely installed per instructions.



Tank Lever
YB8801



Single Robe Hook
YB8803



Pivoting Paper Holder
YB8808 | Ⓟ



Hand Towel Bar
YB8886



Drawer Knob
YB8805



18" Towel Bar
YB8818



Drawer Pull
YB8807

24" Towel Bar
YB8824

SECUREMOUNT

- SecureMount™ Grab Bars are manufactured with an innovative flange design that makes it easy to connect to the stud at multiple points.
- Tested to withstand 500lbs.
- To install grab bars securely without studs, use SecureMount™ Anchors. Sold separately.



18" Designer Grab Bar
YG8818



List price is per each (unless otherwise noted). Product can be ordered by case quantity or individually.



LIGHTING

MODEL NUMBER	LIST EACH	DESCRIPTION	QTY
PREMIUM			
Chrome (CH)			
YB8861CH	217.70	One Globe Bath Light	2
YB8862CH	304.55	Two Globe Bath Light	2
YB8863CH	378.25	Three Globe Bath Light	2
YB8864CH	484.55	Four Globe Bath Light	2
Brushed Nickel (BN)			
YB8861BN	272.05	One Globe Bath Light	2
YB8862BN	380.80	Two Globe Bath Light	2
YB8863BN	473.15	Three Globe Bath Light	2
YB8864BN	605.65	Four Globe Bath Light	2
Matte Black (BL)			
YB8861BL	296.50	One Globe Bath Light	2
YB8862BL	415.10	Two Globe Bath Light	2
YB8863BL	515.70	Three Globe Bath Light	2
YB8864BL	660.10	Four Globe Bath Light	2
Replacement Globe			
YB8869	40.00	Replacement Globe	3



One Globe Bath Light

YB8861



Two Globe Bath Light

YB8862



Three Globe Bath Light

YB8863



Four Globe Bath Light

YB8864



Replacement Globe

YB8869









Bulbs not included.



List price is per each (unless otherwise noted).

Product can be ordered by case quantity or individually.

All 90° lighting fixtures can be mounted facing either upward or downward.

		MODEL	LIST	FINISH/CONNECT	CASE QTY
TOUCHLESS ONE-HANDLE BATHROOM FAUCET - MOTIONSENSE WAVE™ - PREMIUM					
 <p>DECKPLATE INCLUDED</p> 	<ul style="list-style-type: none"> • application: one or three hole • supply lines: flexible • connection: 3/8" compression • deckplate: included • drain assembly: metal • drain assembly type: spring loaded pop-up • DC powered: 6 AA batteries included <p> DURALOCK® DURALAST®</p>	1.2 GPM (4.5L/min) max.			
		S6910EW	825.90	Chrome	3
		S6910EWBN	1060.80	Brushed Nickel	3
		S6910EWBL	1156.25	Matte Black	3
OPTIONAL AC ADAPTERS SOLD SEPARATELY					
		169031	159.60	N/A or Unfinished	12

ONE-HANDLE BATHROOM FAUCET - PREMIUM					
 <p>DECKPLATE INCLUDED</p> 	<ul style="list-style-type: none"> • application: one or three hole • supply lines: flexible • connection: 3/8" compression • deckplate: included • drain assembly: metal with lift rod <p> DURALAST®</p>	1.2 GPM (4.5L/min) max.			
		S6910	460.40	Chrome	3
		S6910BN	598.55	Brushed Nickel	3
		S6910BL	644.60	Matte Black	3

TWO-HANDLE WIDESPREAD BATHROOM FAUCET TRIM - PREMIUM					
	<ul style="list-style-type: none"> • application: three hole • center dimensions: 8" - 16" center • drain assembly: metal with lift rod • valve: sold separately <p> </p>	1.2 GPM (4.5L/min) max.			
		TS6925	409.60	Chrome	3
		TS6925BN	532.50	Brushed Nickel	3
		TS6925BL	573.45	Matte Black	3











WIDESPREAD FAUCET VALVE					
	<ul style="list-style-type: none"> • application: three hole • center dimensions: 8" - 16" center • drain assembly: metal with lift rod <p> DURALOCK® DURALAST®</p>	9000◆	165.40	1/2" IPS	6









HOW TO ORDER
VALVES: PAGE 469













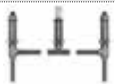

 TRIM PART # +  VALVE PART # =  COMPLETE FAUCET

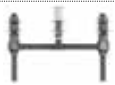

DOUX™ Collection









		MODEL	LIST	FINISH/CONNECT	CASE QTY	
FREESTANDING TUB FILLER TRIM - PREMIUM						
	<ul style="list-style-type: none"> • application: one hole • showerhead type: handshower • handshower functions: one-function • handshower flow rate: 1.75 gpm (6.65 L/min) max. • spout reach: 11.00" • mounting kit: sold separately  	S3105	2291.55	Chrome	1	
		S3105BN	3093.50	Brushed Nickel	1	
		S3105BL	3402.90	Matte Black	1	
FREESTANDING TUB FILLER VALVE AND MOUNTING KIT - PREMIUM						
	<ul style="list-style-type: none"> • description: single riser floor joist mounting kit • application: one hole • quarter turn stops: included 	TS50100	408.90	1/2" CC, NPT	2	
	<ul style="list-style-type: none"> • description: single riser concrete mounting kit • application: one hole • connection size: 1/2" 	TS50110	332.45	1/2" CC, NPT	2	
HOW TO ORDER VALVES: PAGE 469		 TRIM PART #	+	 VALVE PART #	=	 COMPLETE FAUCET









ONE-HANDLE WALLMOUNT TUB FILLER TRIM - PREMIUM						
	<ul style="list-style-type: none"> • application: two hole • connection: 1/2" slip fit • tub spout type: non diverter • spout reach: 10.00" • includes: high flow volume control cartridge • WMV130 series valve kit: sold separately  	WTS981	806.05	Chrome	3	
		WTS981BN	1007.55	Brushed Nickel	3	
		WTS981BL	1108.35	Matte Black	3	
ONE-HANDLE WALLMOUNT TUB FILLER VALVE KIT						
	<ul style="list-style-type: none"> • application: two hole with adj. center dimensions • ports: three • quarter turn stops: included • includes: test plug • includes: spout manifold 	WMV130CIS	154.05	1/2" CC/IPS	6	
		WMV130XS	154.05	1/2" Crimp Ring PEX	6	
		WMV130CXS	154.05	1/2" Cold Exp. PEX	6	
HOW TO ORDER VALVES: PAGE 469		 TRIM PART #	+	 VALVE PART #	=	 COMPLETE FAUCET

















	MODEL	LIST	FINISH/CONNECT	CASE QTY
TWO-HANDLE ROMAN TUB TRIM - PREMIUM				
 <ul style="list-style-type: none"> • application: three hole • spout reach: 8.40" • valve: sold separately 	TS983	515.50	Chrome	3
	TS983BN	721.65	Brushed Nickel	3
	TS983BL	793.80	Matte Black	3
TWO-HANDLE ROMAN TUB TRIM WITH HANDSHOWER - PREMIUM				
 <ul style="list-style-type: none"> • application: four hole • showerhead type: handshower • handshower flow rate: 1.75 gpm (6.65 L/min) max. • spray functions: one-function • spout reach: 8.40" • valve: sold separately 	TS984	803.00	Chrome	3
	TS984BN	1124.25	Brushed Nickel	3
	TS984BL	1236.65	Matte Black	3
TWO-HANDLE ROMAN TUB VALVE				
 <ul style="list-style-type: none"> • deck thickness: 1/8" to 3-3/8" rough-in deck • adjustable spout shank: adjustable center dimensions  DURALAST®	4792	192.30	1/2" CC	6
 <ul style="list-style-type: none"> • deck thickness: 1/8" to 2-3/4" rough-in deck • adjustable spout shank: 10" - 24" center dimensions  DURALOCK® DURALAST®	4793	217.80	1/2" CPVC, Crimp Ring PEX	6
	4794	207.65	1/2" Crimp Ring PEX, Cold Exp. PEX	6
 <ul style="list-style-type: none"> • deck thickness: 1/8" to 3-3/16" rough-in deck • Non-adjustable spout shank: 10" center dimensions  DURALAST®	4796	181.20	1/2" CC	6
	4797	184.70	1/2" CPVC, Crimp Ring PEX	6
	4798	184.70	1/2" Crimp Ring PEX, Cold Exp. PEX	6
TWO-HANDLE ROMAN TUB VALVE WITH HANDSHOWER				
 <ul style="list-style-type: none"> • deck thickness: 1/8" to 2-5/8" rough-in deck • non-adj spout shank: adjustable center dim's  DURALAST®	9792	433.35	1/2" CC	6
 <ul style="list-style-type: none"> • deck thickness: 1/8" to 2-5/8" rough-in deck • adj spout shank: 10" - 24" center dimensions  DURALOCK® DURALAST®	9793	443.50	1/2" CPVC, Crimp Ring PEX	6
For more product details, reference page 470 in valve section.				
HOW TO ORDER VALVES: PAGE 470				



DOUX™ Collection

















		MODEL	LIST	FINISH/CONNECT	CASE QTY	
EXACTTEMP® VALVE ONLY TRIM - PREMIUM						
 <ul style="list-style-type: none"> • description: temperature control valve trim • requires: separate volume control valve • valve: sold separately  		TS3101	429.90	Chrome	3	
		TS3101BN	623.25	Brushed Nickel	3	
		TS3101BL	685.60	Matte Black	3	
EXACTTEMP® THERMOSTATIC MIXING SHOWER VALVE - PREMIUM						
 <ul style="list-style-type: none"> • description: thermostatic rough-in valve • ports: four with adjustable temp. limit stops • check stops: included 		S3371	728.95	3/4" IPS	6	
HOW TO ORDER VALVES: PAGE 471		 TRIM PART #	+	 VALVE PART #	=	 COMPLETE FAUCET











EXACTTEMP® VOLUME CONTROL VALVE TRIM - PREMIUM						
 <ul style="list-style-type: none"> • valve: sold separately  		TS3102	198.40	Chrome	6	
		TS3102BN	287.75	Brushed Nickel	6	
		TS3102BL	316.45	Matte Black	6	
EXACTTEMP® VOLUME CONTROL SHOWER VALVE - PREMIUM						
 <ul style="list-style-type: none"> • includes: volume control 		S3600	185.35	3/4" IPS	12	
HOW TO ORDER VALVES: PAGE 471		 TRIM PART #	+	 VALVE PART #	=	 COMPLETE FAUCET











		MODEL	LIST	FINISH/CONNECT	CASE QTY	
M-CORE® 4-SERIES TUB/SHOWER TRIM – PREMIUM						
	<ul style="list-style-type: none"> • showerhead: single-function eco-performance rainshower • showerhead size: 6-3/4" diameter • tub spout length: 7 3/4" • tub spout connection type: slip fit • tub spout type: diverter • includes: thermostatic cartridge with volume and temperature control • valve: sold separately 	1.75 GPM (6.65 L/min) max.				
		UTS4203EP	796.45	Chrome	4	
		UTS4203EPBN	1044.35	Brushed Nickel	4	
		UTS4203EPBL	1159.85	Matte Black	4	
						
M-CORE® 4-SERIES SHOWER ONLY TRIM – PREMIUM						
	<ul style="list-style-type: none"> • showerhead: single-function eco-performance rainshower • showerhead size: 6-3/4" diameter • includes: thermostatic cartridge with volume and temperature control • valve: sold separately 	1.75 GPM (6.65 L/min) max.				
		UTS4202EP	692.95	Chrome	4	
		UTS4202EPBN	878.50	Brushed Nickel	4	
		UTS4202EPBL	973.60	Matte Black	4	
						
M-CORE® 4-SERIES VALVE ONLY TRIM – PREMIUM						
	<ul style="list-style-type: none"> • includes: thermostatic cartridge with volume and temperature control • valve: sold separately 	UTS4201	598.25	Chrome	3	
		UTS4201BN	718.40	Brushed Nickel	3	
		UTS4201BL	757.15	Matte Black	3	
						
M-CORE® MIXING SHOWER VALVE						
	<ul style="list-style-type: none"> • tub/shower or shower only application • ports: four with adj. temp. limit stops • included: test plug and cross flow plug 	U140CI	72.60	1/2" CC/IPS	6	
		U140X	72.60	1/2" Crimp Ring PEX + CC/IPS Tub	6	
		U140CX	72.60	1/2" Cold Exp. PEX + CC/IPS Tub	6	
		U140V	88.95	1/2" CPVC + CC/IPS Tub	6	
						
	<ul style="list-style-type: none"> • tub/shower or shower only application • ports: four with adj. temp. limit stops • quarter turn stops: included 	U140CIS	104.50	1/2" CC/IPS	6	
		U140XS	104.50	1/2" Crimp Ring PEX + CC/IPS Tub	6	
		U140CXS	104.50	1/2" Cold Exp. PEX + CC/IPS Tub	6	
		U140VS	120.85	1/2" CPVC + CC/IPS Tub	6	
						
	<ul style="list-style-type: none"> • shower only application • ports: three 	U130CI	72.60	1/2" CC/IPS	6	
		U130X	72.60	1/2" Crimp Ring PEX	6	
		U130CX	72.60	1/2" Cold Exp. PEX	6	
						
	<ul style="list-style-type: none"> • shower only application • ports: three • quarter turn stops: included 	U130CIS	104.50	1/2" CC/IPS	6	
		U130XS	104.50	1/2" Crimp Ring PEX	6	
		U130CXS	104.50	1/2" Cold Exp. PEX	6	
						
<p>Four port valves can be used with either Tub/Shower or Shower Only applications. Three port valves can ONLY be used with Shower Only applications. For more product details, reference page 471 in valve section.</p>						
HOW TO ORDER VALVES: PAGE 471		 TRIM PART #	+	 VALVE PART #	=	 COMPLETE FAUCET



















DOUX™ Collection

		MODEL	LIST	FINISH/CONNECT	CASE QTY	
M-CORE® 3-SERIES TUB/SHOWER TRIM – PREMIUM						
 <ul style="list-style-type: none"> • showerhead: single-function rainshower • showerhead size: 6-3/4" diameter • tub spout length: 7 3/4" • tub spout connection type: slip fit • tub spout type: diverter • includes: pressure balanced cartridge with volume and temperature control • valve: sold separately 		2.5 GPM (9.5 L/min) max.				
		UTS3203	658.75	Chrome	4	
		UTS3203BN	906.65	Brushed Nickel	4	
		UTS3203BL	1022.15	Matte Black	4	
		1.75 GPM (6.65 L/min) max.				
		UTS3203EP	658.75	Chrome	4	
		UTS3203EPBN	906.65	Brushed Nickel	4	
		UTS3203EPBL	1022.15	Matte Black	4	
	M-CORE® 3-SERIES SHOWER ONLY TRIM – PREMIUM					
	 <ul style="list-style-type: none"> • showerhead: single-function rainshower • showerhead size: 6-3/4" diameter • includes: pressure balanced cartridge with volume and temperature control • valve: sold separately 		2.5 GPM (9.5 L/min) max.			
		UTS3202	555.25	Chrome	4	
		UTS3202BN	740.75	Brushed Nickel	4	
		UTS3202BL	835.90	Matte Black	4	
		1.75 GPM (6.65 L/min) max.				
		UTS3202EP	555.25	Chrome	4	
		UTS3202EPBN	740.75	Brushed Nickel	4	
		UTS3202EPBL	835.90	Matte Black	4	
M-CORE® 3-SERIES VALVE ONLY TRIM – PREMIUM						
 <ul style="list-style-type: none"> • includes: pressure balanced cartridge with volume and temperature control • valve: sold separately 			UTS3201	460.55	Chrome	3
		UTS3201BN	580.70	Brushed Nickel	3	
		UTS3201BL	619.45	Matte Black	3	
	M-CORE® MIXING SHOWER VALVE					
 <ul style="list-style-type: none"> • tub/shower or shower only application • ports: four with adj. temp. limit stops • included: test plug and cross flow plug 		U140CI	72.60	1/2" CC/IPS	6	
		U140X	72.60	1/2" Crimp Ring PEX + CC/IPS Tub	6	
		U140CX	72.60	1/2" Cold Exp. PEX + CC/IPS Tub	6	
		U140V	88.95	1/2" CPVC + CC/IPS Tub	6	
 <ul style="list-style-type: none"> • tub/shower or shower only application • ports: four with adj. temp. limit stops • quarter turn stops: included 		U140CIS	104.50	1/2" CC/IPS	6	
		U140XS	104.50	1/2" Crimp Ring PEX + CC/IPS Tub	6	
		U140CXS	104.50	1/2" Cold Exp. PEX + CC/IPS Tub	6	
		U140VS	120.85	1/2" CPVC + CC/IPS Tub	6	
 <ul style="list-style-type: none"> • shower only application • ports: three 		U130CI	72.60	1/2" CC/IPS	6	
		U130X	72.60	1/2" Crimp Ring PEX	6	
		U130CX	72.60	1/2" Cold Exp. PEX	6	
 <ul style="list-style-type: none"> • shower only application • ports: three • quarter turn stops: included 		U130CIS	104.50	1/2" CC/IPS	6	
		U130XS	104.50	1/2" Crimp Ring PEX	6	
		U130CXS	104.50	1/2" Cold Exp. PEX	6	
<p>Four port valves can be used with either Tub/Shower or Shower Only applications. Three port valves can ONLY be used with Shower Only applications. For more product details, reference page 471 in valve section.</p>						
<p>HOW TO ORDER VALVES: PAGE 471</p>		 <p>TRIM PART #</p>	+	 <p>VALVE PART #</p>	=	 <p>COMPLETE FAUCET</p>

		MODEL	LIST	FINISH/CONNECT	CASE QTY
M-CORE® 3-SERIES WITH INTEGRATED TRANSFER VALVE TRIM - PREMIUM					
 <ul style="list-style-type: none"> • includes: pressure balanced cartridge with volume and temperature control • valve: sold separately  		UTS2611	453.15	Chrome	4
		UTS2611BN	657.05	Brushed Nickel	4
		UTS2611BL	722.70	Matte Black	4
M-CORE® WITH INTEGRATED TRANSFER VALVE					
Three Function (2 independent/1 shared) OR Six Function (3 independent/3 shared) - plumbing configuration page 478					
 <ul style="list-style-type: none"> • ports: four with adj. temp. limit stops • check stops: included 		U362CIS	270.70	1/2" CC/IPS	6
		U362CXS	270.70	1/2" Cold Exp. PEX	6
		U362XS	270.70	1/2" Crimp Ring PEX	6
Two Independent Functions OR Three Independent Functions - plumbing configurations page 478					
 <ul style="list-style-type: none"> • ports: four with adj. temp. limit stops • check stops: included 		U232CIS	270.70	1/2" CC/IPS	6
		U232CXS	270.70	1/2" Cold Exp. PEX	6
		U232XS	270.70	1/2" Crimp Ring PEX	6
For more product details, reference page 472 in valve section. See page 478 for plumbing configurations.					
HOW TO ORDER VALVES: PAGE 472	 TRIM PART #	+	 VALVE PART #	=	 COMPLETE FAUCET















M-CORE® TRANSFER VALVE TRIM - PREMIUM					
 <ul style="list-style-type: none"> • use with the M-CORE® transfer valve • valve: sold separately  		UTS9204	320.40	Chrome	12
		UTS9204BN	421.40	Brushed Nickel	12
		UTS9204BL	454.00	Matte Black	12
M-CORE® TRANSFER VALVE					
Three Function (2 independent/1 shared) OR Six Function (3 independent/3 shared) - plumbing configuration page 478					
 <ul style="list-style-type: none"> • number of functions: three or six • ports: four 		U361CI	152.70	1/2" CC/IPS	6
		U361CX	152.70	1/2" Cold Exp. PEX	6
		U361X	152.70	1/2" Crimp Ring PEX	6
Two Independent Functions OR Three Independent Functions - plumbing configurations page 478					
 <ul style="list-style-type: none"> • number of functions: two or three • ports: four 		U231CI	152.70	1/2" CC/IPS	6
		U231CX	152.70	1/2" Cold Exp. PEX	6
		U231X	152.70	1/2" Crimp Ring PEX	6
For more product details, reference page 472 in valve section. See page 478 for plumbing configurations.					
HOW TO ORDER VALVES: PAGE 472	 TRIM PART #	+	 VALVE PART #	=	 COMPLETE FAUCET



		MODEL	LIST	FINISH/CONNECT	CASE QTY	
POSI-TEMP® TUB/SHOWER TRIM - PREMIUM						
 <ul style="list-style-type: none"> • showerhead: single-function rainshower • showerhead size: 6-3/4" diameter • tub spout length: 7 3/4" • tub spout connection type: slip fit • tub spout type: diverter • valve: sold separately 		2.5 GPM (9.5 L/min) max.				
		TS2203	432.60	Chrome	4	
		TS2203BN	627.30	Brushed Nickel	4	
		TS2203BL	689.90	Matte Black	4	
		1.75 GPM (6.65 L/min) max.				
		TS2203EP	432.60	Chrome	4	
		TS2203EPBN	627.30	Brushed Nickel	4	
		TS2203EPBL	689.90	Matte Black	4	
	POSI-TEMP® SHOWER ONLY TRIM - PREMIUM					
	 <ul style="list-style-type: none"> • showerhead: single-function rainshower • showerhead size: 6-3/4" diameter • valve: sold separately 		2.5 GPM (9.5 L/min) max.			
		TS2202	340.20	Chrome	4	
		TS2202BN	493.25	Brushed Nickel	4	
		TS2202BL	542.70	Matte Black	4	
		1.75 GPM (6.65 L/min) max.				
		TS2202EP	340.20	Chrome	4	
		TS2202EPBN	493.25	Brushed Nickel	4	
	TS2202EPBL	542.70	Matte Black	4		
POSI-TEMP® VALVE ONLY TRIM - PREMIUM						
 <ul style="list-style-type: none"> • valve: sold separately 		TS2201	255.15	Chrome	3	
		TS2201BN	370.05	Brushed Nickel	3	
		TS2201BL	407.05	Matte Black	3	
	POSI-TEMP® SHOWER MIXING VALVES					
 <ul style="list-style-type: none"> • tub/shower or shower only application • ports: four with adjustable temp. limit stops • test plug: included 		2520 ◆	159.20	1/2" CC	6	
		2510 ◆	159.20	1/2" IPS	6	
 <ul style="list-style-type: none"> • tub/shower or shower only application • ports: four with adjustable temp. limit stops • quarter turn stops: included • test plug: included 		2570 ◆	193.35	1/2" CC	6	
		2590 ◆	193.35	1/2" IPS	6	
		2580 ◆	159.20	1/2" Crimp ring PEX	6	
	 <ul style="list-style-type: none"> • tub/shower only application • ports: four with adjustable temp. limit stops • quarter turn stops: included • test plug: included 		2360PF	212.60	1/2" Crimp Ring PEX	3
 <ul style="list-style-type: none"> • shower only application • ports: three with adjustable temp. limit stops • quarter turn stops: included • test plug: included 			2326PF	205.20	1/2" Crimp Ring PEX	6
		2328PF	205.20	1/2" Cold Exp. PEX	6	
<p>Four port valves can be used with either Tub/Shower or Shower Only applications. Three port valves can ONLY be used with Shower Only applications. For more product details, reference page 473-476 in valve section.</p>						
HOW TO ORDER VALVES: PAGES 473-476		 TRIM PART #	+	 VALVE PART #	=	 COMPLETE FAUCET



DOUX™ Collection

		MODEL	LIST	FINISH/CONNECT	CASE QTY
POSI-TEMP® WITH INTEGRATED TRANSFER VALVE TRIM - PREMIUM					
 <ul style="list-style-type: none"> • valve: sold separately 	 	TS2200	533.50	Chrome	4
		TS2200BN	773.55	Brushed Nickel	4
		TS2200BL	851.00	Matte Black	4
POSI-TEMP® WITH INTEGRATED TRANSFER VALVE					
 <ul style="list-style-type: none"> • functions: three (two independent and one shared) • ports: four with adjustable temp. limit stops • test plug: included 		2551	287.50	1/2" IPS	6
 <ul style="list-style-type: none"> • functions: three (two independent and one shared) • ports: four with adjustable temp. limit stops • stops: included • test plug: included 		2581	323.75	1/2" IPS	6
 <ul style="list-style-type: none"> • functions: two independent • ports: four with adjustable temp. limit stops • test plug: included 		2521	287.50	1/2" IPS	6
 <ul style="list-style-type: none"> • functions: two independent • ports: four with adjustable temp. limit stops • stops: included • test plug: included 		2571	323.75	1/2" IPS	6
For more product details, reference page 477 in valve section.					
HOW TO ORDER VALVES: PAGE 477	 TRIM PART #	+	 VALVE PART #	=	 COMPLETE FAUCET

Moen® bath accessories CANNOT be combined with Moen faucet parts on a Purchase Order.

A line of matching accessories - including tank levers and towel bars - allow for a completely cohesive look in the bath.

MODEL NUMBER	LIST EACH	DESCRIPTION	QTY
PREMIUM			
Chrome (CH)			
YB0201CH	81.10	Tank Lever	24
YB0203CH	62.10	Single Robe Hook	24
(P) YB0208CH	114.35	Pivoting Paper Holder	6
YB0218CH	131.40	18" Towel Bar	6
YB0224CH	136.10	24" Towel Bar	6
YB0275CH	81.70	Corner Shower Basket	6
YB0286CH	91.75	Hand Towel Bar	6
Brushed Nickel (BN)			
YB0201BN	87.45	Tank Lever	24
YB0203BN	66.60	Single Robe Hook	24
(P) YB0208BN	123.25	Pivoting Paper Holder	6
YB0218BN	141.95	18" Towel Bar	6
YB0224BN	147.15	24" Towel Bar	6
YB0275BN	89.90	Corner Shower Basket	6
YB0286BN	99.00	Hand Towel Bar	6
Matte Black (BL)			
YB0201BL	96.25	Tank Lever	24
YB0203BL	73.10	Single Robe Hook	24
(P) YB0208BL	135.55	Pivoting Paper Holder	6
YB0218BL	156.05	18" Towel Bar	6
YB0224BL	161.95	24" Towel Bar	6
YB0275BL	99.40	Corner Shower Basket	6
YB0286BL	108.90	Hand Towel Bar	6

(P) Denotes pivoting paper holder



Tank Lever

YB0201



Single Robe Hook

YB0203



Pivoting Paper Holder

YB0208 | (P)



Hand Towel Bar

YB0286



18" Towel Bar

YB0218



Corner Shower Basket



YB0275



24" Towel Bar



YB0224







GREENFIELD™ Collection

	MODEL	LIST	FINISH/CONNECT	CASE QTY
ONE-HANDLE BATHROOM FAUCET				
 <p>DECKPLATE SOLD SEPARATELY</p> 	<ul style="list-style-type: none"> • application: one or three hole • supply lines: flexible • connection: 3/8" compression • deckplate: sold separately • drain assembly: metal with lift rod 	<p>1.2 GPM (4.5L/min) max.</p>		
	<ul style="list-style-type: none"> •  DURALAST® 	<p>6504 363.60 Chrome 3</p> <p>6504BN 454.50 Brushed Nickel 3</p> <p>6504BL 490.85 Matte Black 3</p> <p>6504BG 527.20 Brushed Gold 3</p>	<p>OPTIONAL DECKPLATE SOLD SEPARATELY</p>	
		<p>215667 19.10 Chrome 12</p> <p>215667BN 23.70 Brushed Nickel 12</p> <p>215667BL 33.35 Matte Black 12</p> <p>215667BG 23.70 Brushed Gold 12</p>		

TWO-HANDLE WIDESPREAD BATHROOM FAUCET				
	<ul style="list-style-type: none"> • application: three hole • center dimensions: 8" - 16" center • drain assembly: metal with lift rod • 9000 valve included 	<p>1.2 GPM (4.5L/min) max.</p>		
	<ul style="list-style-type: none"> •  DURALOCK® •  DURALAST® 	<p>TV6507 548.95 Chrome 3</p> <p>TV6507BN 686.20 Brushed Nickel 3</p> <p>TV6507BL 741.10 Matte Black 3</p> <p>TV6507BG 796.00 Brushed Gold 3</p>		

FREESTANDING TUB FILLER TRIM				
	<ul style="list-style-type: none"> • application: one hole • showerhead type: handshower • handshower functions: one-function • handshower flow rate: 1.75 gpm (6.65 L/min) max. • spout reach: 10.00" • mounting kit: sold separately 	<p>620 1752.20 Chrome 1</p> <p>620BN 2365.55 Brushed Nickel 1</p> <p>620BG 2365.55 Brushed Gold 1</p> <p>620BL 2601.95 Matte Black 1</p>		
	<ul style="list-style-type: none"> •   			

FREESTANDING TUB FILLER VALVE AND MOUNTING KIT - PREMIUM				
	<ul style="list-style-type: none"> • description: single riser floor joist mounting kit • application: one hole • quarter turn stops: included 	<p>TS50100 408.90 1/2" CC, NPT 2</p>		
	<ul style="list-style-type: none"> •  			
	<ul style="list-style-type: none"> • description: single riser concrete mounting kit • application: one hole • connection size: 1/2" 	<p>TS50110 332.45 1/2" CC, NPT 2</p>		
	<ul style="list-style-type: none"> •  			







HOW TO ORDER
VALVES: PAGE 469













TRIM PART #

VALVE PART #









COMPLETE FAUCET









GREENFIELD™ Collection

















		MODEL	LIST	FINISH/CONNECT	CASE QTY	
ONE-HANDLE WALLMOUNT TUB FILLER TRIM						
 <ul style="list-style-type: none"> • application: two hole • connection: 1/2" slip fit • tub spout type: non diverter • spout reach: 10.00" • includes: high flow volume control cartridge • WMV130 series valve kit: sold separately 		WT621	734.65	Chrome	3	
		WT621BN	984.45	Brushed Nickel	3	
		WT621BG	984.45	Brushed Gold	3	
		WT621BL	1082.85	Matte Black	3	
ONE-HANDLE WALLMOUNT TUB FILLER VALVE KIT						
 <ul style="list-style-type: none"> • application: two hole with adj. center dimensions • ports: three • quarter turn stops: included • includes: test plug • includes: spout manifold 		WMV130CIS	154.05	1/2" CC/IPS	6	
		WMV130XS	154.05	1/2" Crimp Ring PEX	6	
		WMV130CXS	154.05	1/2" Cold Exp. PEX	6	
HOW TO ORDER VALVES: PAGE 469		 TRIM PART #	+	 VALVE PART #	=	 COMPLETE FAUCET

TWO-HANDLE ROMAN TUB TRIM						
 <ul style="list-style-type: none"> • application: three hole • spout reach: 7.25" • valve: sold separately 		T6503	534.35	Chrome	3	
		T6503BN	746.60	Brushed Nickel	3	
		T6503BG	746.60	Brushed Gold	3	
		T6503BL	791.20	Matte Black	3	
TWO-HANDLE ROMAN TUB VALVE						
 <ul style="list-style-type: none"> • deck thickness: 1/8" to 3-3/8" rough-in deck • adjustable spout shank: adjustable center dimensions  DURALAST®		4792	192.30	1/2" CC	6	
	 <ul style="list-style-type: none"> • deck thickness: 1/8" to 2-3/4" rough-in deck • adjustable spout shank: 10" - 24" center dimensions  DURALOCK® DURALAST®		4793	217.80	1/2" CPVC, Crimp Ring PEX	6
		4794	207.65	1/2" Crimp Ring PEX, Cold Exp. PEX	6	
 <ul style="list-style-type: none"> • deck thickness: 1/8" to 3-3/16" rough-in deck • Non-adjustable spout shank: 10" center dimensions  DURALAST®		4796	181.20	1/2" CC	6	
		4797	184.70	1/2" CPVC, Crimp Ring PEX	6	
		4798	184.70	1/2" Crimp Ring PEX, Cold Exp. PEX	6	
For more product details, reference page 470 in valve section.						
HOW TO ORDER VALVES: PAGE 470		 TRIM PART #	+	 VALVE PART #	=	 COMPLETE FAUCET

GREENFIELD™ Collection















		MODEL	LIST	FINISH/CONNECT	CASE QTY	
EXACTTEMP® VALVE ONLY TRIM						
 <ul style="list-style-type: none"> • description: temperature control valve trim • requires: separate volume control valve • valve: sold separately  		T4401	309.60	Chrome	3	
		T4401BN	467.55	Brushed Nickel	3	
		T4401BG	467.55	Brushed Gold	3	
		T4401BL	503.10	Matte Black	3	
EXACTTEMP® THERMOSTATIC MIXING SHOWER VALVE - PREMIUM						
 <ul style="list-style-type: none"> • description: thermostatic rough-in valve • ports: four with adjustable temp. limit stops • check stops: included 		S3371	728.95	¾" IPS	6	
HOW TO ORDER VALVES: PAGE 471		 TRIM PART #	+	 VALVE PART #	=	 COMPLETE FAUCET

EXACTTEMP® VOLUME CONTROL VALVE TRIM						
 <ul style="list-style-type: none"> • valve: sold separately  		T4402	157.60	Chrome	6	
		T4402BN	237.55	Brushed Nickel	6	
		T4402BG	237.55	Brushed Gold	6	
		T4402BL	256.15	Matte Black	6	
EXACTTEMP® VOLUME CONTROL SHOWER VALVE - PREMIUM						
 <ul style="list-style-type: none"> • includes: volume control 		S3600	185.35	¾" IPS	12	
HOW TO ORDER VALVES: PAGE 471		 TRIM PART #	+	 VALVE PART #	=	 COMPLETE FAUCET









		MODEL	LIST	FINISH/CONNECT	CASE QTY	
M-CORE® 4-SERIES TUB/SHOWER TRIM						
 <ul style="list-style-type: none"> • showerhead: single-function eco-performance rainshower • showerhead size: 6-3/4" diameter • tub spout length: 7-3/8" • tub spout connection type: slip fit • tub spout type: diverter • includes: thermostatic cartridge with volume and temperature control • valve: sold separately 	<ul style="list-style-type: none"> • 1.75 GPM (6.65 L/min) max. 					
	UT4323EP	656.20	Chrome	4		
	UT4323EPBN	1001.75	Brushed Nickel	4		
	UT4323EPBG	1001.75	Brushed Gold	4		
	UT4323EPBL	1088.15	Matte Black	4		
M-CORE® 4-SERIES SHOWER ONLY TRIM						
 <ul style="list-style-type: none"> • showerhead: single-function eco-performance rainshower • showerhead size: 6-3/4" diameter • includes: thermostatic cartridge with volume and temperature control • valve: sold separately 	<ul style="list-style-type: none"> • 1.75 GPM (6.65 L/min) max. 					
	UT4322EP	560.15	Chrome	4		
	UT4322EPBN	847.60	Brushed Nickel	4		
	UT4322EPBG	847.60	Brushed Gold	4		
	UT4322EPBL	918.60	Matte Black	4		
M-CORE® 4-SERIES VALVE ONLY TRIM						
 <ul style="list-style-type: none"> • includes: thermostatic cartridge with volume and temperature control • valve: sold separately 						
	UT4321	492.70	Chrome	3		
	UT4321BN	720.45	Brushed Nickel	3		
	UT4321BG	720.45	Brushed Gold	3		
	UT4321BL	778.65	Matte Black	3		
M-CORE® MIXING SHOWER VALVE						
 <ul style="list-style-type: none"> • tub/shower or shower only application • ports: four with adj. temp. limit stops • included: test plug and cross flow plug 						
	U140CI	72.60	1/2" CC/IPS	6		
	U140X	72.60	1/2" Crimp Ring PEX + CC/IPS Tub	6		
	U140CX	72.60	1/2" Cold Exp. PEX + CC/IPS Tub	6		
	U140V	88.95	1/2" CPVC + CC/IPS Tub	6		
 <ul style="list-style-type: none"> • tub/shower or shower only application • ports: four with adj. temp. limit stops • quarter turn stops: included 						
	U140CIS	104.50	1/2" CC/IPS	6		
	U140XS	104.50	1/2" Crimp Ring PEX + CC/IPS Tub	6		
	U140CXS	104.50	1/2" Cold Exp. PEX + CC/IPS Tub	6		
	U140VS	120.85	1/2" CPVC + CC/IPS Tub	6		
 <ul style="list-style-type: none"> • shower only application • ports: three 						
	U130CI	72.60	1/2" CC/IPS	6		
	U130X	72.60	1/2" Crimp Ring PEX	6		
	U130CX	72.60	1/2" Cold Exp. PEX	6		
 <ul style="list-style-type: none"> • shower only application • ports: three • quarter turn stops: included 						
	U130CIS	104.50	1/2" CC/IPS	6		
	U130XS	104.50	1/2" Crimp Ring PEX	6		
	U130CXS	104.50	1/2" Cold Exp. PEX	6		
<p>Four port valves can be used with either Tub/Shower or Shower Only applications. Three port valves can ONLY be used with Shower Only applications. For more product details, reference page 471 in valve section.</p>						
<p>HOW TO ORDER VALVES: PAGE 471</p>		 <p>TRIM PART #</p>	+	 <p>VALVE PART #</p>	=	 <p>COMPLETE FAUCET</p>









GREENFIELD™ Collection











		MODEL	LIST	FINISH/CONNECT	CASE QTY	
M-CORE® 3-SERIES TUB/SHOWER TRIM						
 <ul style="list-style-type: none"> • showerhead: single-function rainshower • showerhead size: 6-3/4" diameter • tub spout length: 7-3/8" • tub spout connection type: slip fit • tub spout type: diverter • includes: pressure balanced cartridge with volume and temperature control • valve: sold separately 		2.5 GPM (9.5 L/min) max.				
		UT33323	518.50	Chrome	4	
		UT33323BN	864.05	Brushed Nickel	4	
		UT33323BG	864.05	Brushed Gold	4	
		UT33323BL	950.45	Matte Black	4	
		1.75 GPM (6.65 L/min) max.				
		UT33323EP	518.50	Chrome	4	
		UT33323EPBN	864.05	Brushed Nickel	4	
		UT33323EPBG	864.05	Brushed Gold	4	
		UT33323EPBL	950.45	Matte Black	4	
M-CORE® 3-SERIES SHOWER ONLY TRIM						
 <ul style="list-style-type: none"> • showerhead: single-function rainshower • showerhead size: 6-3/4" diameter • includes: pressure balanced cartridge with volume and temperature control • valve: sold separately 		2.5 GPM (9.5 L/min) max.				
		UT33322	422.45	Chrome	4	
		UT33322BN	709.90	Brushed Nickel	4	
		UT33322BG	709.90	Brushed Gold	4	
		UT33322BL	780.90	Matte Black	4	
		1.75 GPM (6.65 L/min) max.				
		UT33322EP	422.45	Chrome	4	
		UT33322EPBN	709.90	Brushed Nickel	4	
		UT33322EPBG	709.90	Brushed Gold	4	
		UT33322EPBL	780.90	Matte Black	4	
M-CORE® MIXING SHOWER VALVE						
 <ul style="list-style-type: none"> • tub/shower or shower only application • ports: four with adj. temp. limit stops • included: test plug and cross flow plug 		U140CI	72.60	1/2" CC/IPS	6	
		U140X	72.60	1/2" Crimp Ring PEX + CC/IPS Tub	6	
		U140CX	72.60	1/2" Cold Exp. PEX + CC/IPS Tub	6	
		U140V	88.95	1/2" CPVC + CC/IPS Tub	6	
 <ul style="list-style-type: none"> • tub/shower or shower only application • ports: four with adj. temp. limit stops • quarter turn stops: included 		U140CIS	104.50	1/2" CC/IPS	6	
		U140XS	104.50	1/2" Crimp Ring PEX + CC/IPS Tub	6	
		U140CXS	104.50	1/2" Cold Exp. PEX + CC/IPS Tub	6	
		U140VS	120.85	1/2" CPVC + CC/IPS Tub	6	
 <ul style="list-style-type: none"> • shower only application • ports: three 		U130CI	72.60	1/2" CC/IPS	6	
		U130X	72.60	1/2" Crimp Ring PEX	6	
		U130CX	72.60	1/2" Cold Exp. PEX	6	
 <ul style="list-style-type: none"> • shower only application • ports: three • quarter turn stops: included 		U130CIS	104.50	1/2" CC/IPS	6	
		U130XS	104.50	1/2" Crimp Ring PEX	6	
		U130CXS	104.50	1/2" Cold Exp. PEX	6	
<p>Four port valves can be used with either Tub/Shower or Shower Only applications. Three port valves can ONLY be used with Shower Only applications. For more product details, reference page 471 in valve section.</p>						
<p>HOW TO ORDER VALVES: PAGE 471</p>		 <p>TRIM PART #</p>	+	 <p>VALVE PART #</p>	=	 <p>COMPLETE FAUCET</p>

GREENFIELD™ Collection











		MODEL	LIST	FINISH/CONNECT	CASE QTY	
M-CORE® 3-SERIES VALVE ONLY TRIM						
 <ul style="list-style-type: none"> includes: pressure balanced cartridge with volume and temperature control valve: sold separately 		UT33321	355.00	Chrome	3	
		UT33321BN	582.75	Brushed Nickel	3	
		UT33321BG	582.75	Brushed Gold	3	
		UT33321BL	640.95	Matte Black	3	
M-CORE® MIXING SHOWER VALVE						
 <ul style="list-style-type: none"> tub/shower or shower only application ports: four with adj. temp. limit stops included: test plug and cross flow plug 		U140CI	72.60	1/2" CC/IPS	6	
		U140X	72.60	1/2" Crimp Ring PEX + CC/IPS Tub	6	
		U140CX	72.60	1/2" Cold Exp. PEX + CC/IPS Tub	6	
		U140V	88.95	1/2" CPVC + CC/IPS Tub	6	
 <ul style="list-style-type: none"> tub/shower or shower only application ports: four with adj. temp. limit stops quarter turn stops: included 		U140CIS	104.50	1/2" CC/IPS	6	
		U140XS	104.50	1/2" Crimp Ring PEX + CC/IPS Tub	6	
		U140CXS	104.50	1/2" Cold Exp. PEX + CC/IPS Tub	6	
		U140VS	120.85	1/2" CPVC + CC/IPS Tub	6	
 <ul style="list-style-type: none"> shower only application ports: three 		U130CI	72.60	1/2" CC/IPS	6	
		U130X	72.60	1/2" Crimp Ring PEX	6	
		U130CX	72.60	1/2" Cold Exp. PEX	6	
 <ul style="list-style-type: none"> shower only application ports: three quarter turn stops: included 		U130CIS	104.50	1/2" CC/IPS	6	
		U130XS	104.50	1/2" Crimp Ring PEX	6	
		U130CXS	104.50	1/2" Cold Exp. PEX	6	
Four port valves can be used with either Tub/Shower or Shower Only applications. Three port valves can ONLY be used with Shower Only applications. For more product details, reference page 471 in valve section.						
HOW TO ORDER VALVES: PAGE 471		 TRIM PART #	+	 VALVE PART #	=	 COMPLETE FAUCET

M-CORE® 3-SERIES WITH INTEGRATED TRANSFER VALVE TRIM						
 <ul style="list-style-type: none"> includes: pressure balanced cartridge with volume and temperature control valve: sold separately 		UT33341	335.50	Chrome	4	
		UT33341BN	415.90	Brushed Nickel	4	
		UT33341BG	415.90	Brushed Gold	4	
		UT33341BL	457.50	Matte Black	4	
M-CORE® WITH INTEGRATED TRANSFER VALVE						
Three Function (2 independent/1 shared) OR Six Function (3 independent/3 shared) - plumbing configuration page 478						
 <ul style="list-style-type: none"> ports: four with adj. temp. limit stops check stops: included 		U362CIS	270.70	1/2" CC/IPS	6	
		U362CXS	270.70	1/2" Cold Exp. PEX	6	
		U362XS	270.70	1/2" Crimp Ring PEX	6	
Two Independent Functions OR Three Independent Functions - plumbing configurations page 478						
 <ul style="list-style-type: none"> ports: four with adj. temp. limit stops check stops: included 		U232CIS	270.70	1/2" CC/IPS	6	
		U232CXS	270.70	1/2" Cold Exp. PEX	6	
		U232XS	270.70	1/2" Crimp Ring PEX	6	
For more product details, reference page 472 in valve section. See page 478 for plumbing configurations.						
HOW TO ORDER VALVES: PAGE 472		 TRIM PART #	+	 VALVE PART #	=	 COMPLETE FAUCET

























GREENFIELD™ Collection

		MODEL	LIST	FINISH/CONNECT	CASE QTY	
M-CORE® TRANSFER VALVE TRIM						
 <ul style="list-style-type: none"> • use with the M-CORE® transfer valve • valve: sold separately  		UT6501	232.25	Chrome	12	
		UT6501BN	285.90	Brushed Nickel	12	
		UT6501BG	285.90	Brushed Gold	12	
		UT6501BL	306.80	Matte Black	12	
M-CORE® TRANSFER VALVE						
Three Function (2 independent/1 shared) OR Six Function (3 independent/3 shared) - plumbing configuration page 478						
 <ul style="list-style-type: none"> • number of functions: three or six • ports: four 		U361CI	152.70	1/2" CC/IPS	6	
		U361CX	152.70	1/2" Cold Exp. PEX	6	
		U361X	152.70	1/2" Crimp Ring PEX	6	
Two Independent Functions OR Three Independent Functions - plumbing configurations page 478						
 <ul style="list-style-type: none"> • number of functions: two or three • ports: four 		U231CI	152.70	1/2" CC/IPS	6	
		U231CX	152.70	1/2" Cold Exp. PEX	6	
		U231X	152.70	1/2" Crimp Ring PEX	6	
For more product details, reference page 472 in valve section. See page 478 for plumbing configurations.						
HOW TO ORDER VALVES: PAGE 472		 TRIM PART #	+	 VALVE PART #	=	 COMPLETE FAUCET

GREENFIELD™ Collection

		MODEL	LIST	FINISH/CONNECT	CASE QTY	
M-CORE® 2-SERIES TUB/SHOWER TRIM						
 <ul style="list-style-type: none"> • showerhead: single-function eco-performance • showerhead size: 3-5/8" diameter • tub spout length: 7-3/8" • tub spout connection type: slip fit • tub spout type: diverter • includes: pressure balanced cartridge with temperature control • valve: sold separately 		1.75 GPM (6.65 L/min) max.				
		UT2323EP	417.30	Chrome	3	
		UT2323EPBN	653.20	Brushed Nickel	3	
		UT2323EPBG	653.20	Brushed Gold	3	
		UT2323EPBL	705.60	Matte Black	3	
M-CORE® 2-SERIES SHOWER ONLY TRIM						
 <ul style="list-style-type: none"> • showerhead: single-function eco-performance • showerhead size: 3-5/8" diameter • includes: pressure balanced cartridge with temperature control • valve: sold separately 		1.75 GPM (6.65 L/min) max.				
		UT2322EP	355.45	Chrome	3	
		UT2322EPBN	541.25	Brushed Nickel	3	
		UT2322EPBG	541.25	Brushed Gold	3	
		UT2322EPBL	582.55	Matte Black	3	
M-CORE® 2-SERIES VALVE ONLY TRIM						
 <ul style="list-style-type: none"> • includes: pressure balanced cartridge with temperature control • valve: sold separately 						
		UT2321	298.90	Chrome	3	
		UT2321BN	437.75	Brushed Nickel	3	
		UT2321BG	437.75	Brushed Gold	3	
		UT2321BL	468.75	Matte Black	3	
M-CORE® MIXING SHOWER VALVE						
 <ul style="list-style-type: none"> • tub/shower or shower only application • ports: four with adj. temp. limit stops • included: test plug and cross flow plug 						
		U140CI	72.60	1/2" CC/IPS	6	
		U140X	72.60	1/2" Crimp Ring PEX + CC/IPS Tub	6	
		U140CX	72.60	1/2" Cold Exp. PEX + CC/IPS Tub	6	
		U140V	88.95	1/2" CPVC + CC/IPS Tub	6	
 <ul style="list-style-type: none"> • tub/shower or shower only application • ports: four with adj. temp. limit stops • quarter turn stops: included 						
		U140CIS	104.50	1/2" CC/IPS	6	
		U140XS	104.50	1/2" Crimp Ring PEX + CC/IPS Tub	6	
		U140CXS	104.50	1/2" Cold Exp. PEX + CC/IPS Tub	6	
		U140VS	120.85	1/2" CPVC + CC/IPS Tub	6	
 <ul style="list-style-type: none"> • shower only application • ports: three 						
		U130CI	72.60	1/2" CC/IPS	6	
		U130X	72.60	1/2" Crimp Ring PEX	6	
		U130CX	72.60	1/2" Cold Exp. PEX	6	
 <ul style="list-style-type: none"> • shower only application • ports: three • quarter turn stops: included 						
		U130CIS	104.50	1/2" CC/IPS	6	
		U130XS	104.50	1/2" Crimp Ring PEX	6	
		U130CXS	104.50	1/2" Cold Exp. PEX	6	
<p>Four port valves can be used with either Tub/Shower or Shower Only applications. Three port valves can ONLY be used with Shower Only applications. For more product details, reference page 471 in valve section.</p>						
<p>HOW TO ORDER VALVES: PAGE 471</p>		 <p>TRIM PART #</p>	+	 <p>VALVE PART #</p>	=	 <p>COMPLETE FAUCET</p>

GREENFIELD™ Collection

		MODEL	LIST	FINISH/CONNECT	CASE QTY	
POSI-TEMP® TUB/SHOWER TRIM						
 <ul style="list-style-type: none"> • showerhead: single-function eco-performance • showerhead size: 3-5/8" diameter • tub spout length: 7-3/8" • tub spout connection type: slip fit • tub spout type: diverter • valve: sold separately 		 1.75 GPM (6.65 L/min) max.				
		T2223EP	288.70	Chrome	3	
		T2223EPBN	524.55	Brushed Nickel	3	
		T2223EPBG	524.55	Brushed Gold	3	
		T2223EPBL	576.90	Matte Black	3	
POSI-TEMP® SHOWER ONLY TRIM						
 <ul style="list-style-type: none"> • showerhead: single-function eco-performance • showerhead size: 3-5/8" diameter • valve: sold separately 		 1.75 GPM (6.65 L/min) max.				
		T2222EP	226.85	Chrome	3	
		T2222EPBN	412.60	Brushed Nickel	3	
		T2222EPBG	412.60	Brushed Gold	3	
		T2222EPBL	453.95	Matte Black	3	
POSI-TEMP® VALVE ONLY TRIM						
 <ul style="list-style-type: none"> • valve: sold separately 		T2221	170.25	Chrome	3	
		T2221BN	309.05	Brushed Nickel	3	
		T2221BG	309.05	Brushed Gold	3	
		T2221BL	340.05	Matte Black	3	
	POSI-TEMP® SHOWER MIXING VALVES					
 <ul style="list-style-type: none"> • tub/shower or shower only application • ports: four with adjustable temp. limit stops • test plug: included 		2520 	159.20	1/2" CC	6	
		2510 	159.20	1/2" IPS	6	
 <ul style="list-style-type: none"> • tub/shower or shower only application • ports: four with adjustable temp. limit stops • quarter turn stops: included • test plug: included 		2570 	193.35	1/2" CC	6	
		2590 	193.35	1/2" IPS	6	
		2580 	159.20	1/2" Crimp ring PEX	6	
 <ul style="list-style-type: none"> • tub/shower only application • ports: four with adjustable temp. limit stops • quarter turn stops: included • test plug: included 		2360PF	212.60	1/2" Crimp Ring PEX	3	
 <ul style="list-style-type: none"> • shower only application • ports: three with adjustable temp. limit stops • quarter turn stops: included • test plug: included 		2326PF	205.20	1/2" Crimp Ring PEX	6	
		2328PF	205.20	1/2" Cold Exp. PEX	6	
<p>Four port valves can be used with either Tub/Shower or Shower Only applications. Three port valves can ONLY be used with Shower Only applications. For more product details, reference page 473-476 in valve section.</p>						
<p>HOW TO ORDER VALVES: PAGES 473-476</p>		 <p>TRIM PART #</p>	+	 <p>VALVE PART #</p>	=	 <p>COMPLETE FAUCET</p>

Moen® bath accessories CANNOT be combined with Moen faucet parts on a Purchase Order.

A line of matching accessories - including tank levers and towel bars - allow for a completely cohesive look in the bath.

MODEL NUMBER	LIST EACH	DESCRIPTION	QTY
Chrome (CH)			
YB1701CH	48.05	Tank Lever	24
YB1703CH	37.00	Double Robe Hook	24
Ⓟ YB1708CH	67.45	Pivoting Paper Holder	6
YB1718CH	78.35	18" Towel Bar	6
YB1724CH	80.80	24" Towel Bar	6
YB1786CH	55.00	Towel Ring	6
YB1788CH	97.80	Double Paper Holder	3
YB1794CH	318.35	Towel Shelf	2
Brushed Nickel (BN)			
YB1701BN	53.05	Tank Lever	24
YB1703BN	40.70	Double Robe Hook	24
Ⓟ YB1708BN	74.60	Pivoting Paper Holder	6
YB1718BN	86.15	18" Towel Bar	6
YB1724BN	89.20	24" Towel Bar	6
YB1786BN	60.15	Towel Ring	6
YB1788BN	108.20	Double Paper Holder	3
YB1794BN	349.15	Towel Shelf	2
Matte Black (BL)			
YB1701BL	57.85	Tank Lever	24
YB1703BL	44.70	Double Robe Hook	24
Ⓟ YB1708BL	82.05	Pivoting Paper Holder	6
YB1718BL	94.70	18" Towel Bar	6
YB1724BL	98.05	24" Towel Bar	6
YB1786BL	66.15	Towel Ring	6
YB1788BL	119.00	Double Paper Holder	3
YB1794BL	380.60	Towel Shelf	2
Brushed Gold (BG)			
YB1701BG	68.95	Tank Lever	24
YB1703BG	48.85	Double Robe Hook	24
Ⓟ YB1708BG	108.20	Pivoting Paper Holder	6
YB1718BG	120.60	18" Towel Bar	6
YB1724BG	124.75	24" Towel Bar	6
YB1786BG	87.15	Towel Ring	6
YB1788BG	156.95	Double Paper Holder	3
YB1794BG	453.90	Towel Shelf	2

Ⓟ Denotes pivoting paper holder



Tank Lever
YB1701



Double Robe Hook
YB1703



Towel Ring
YB1786



Pivoting Paper Holder
YB1708 | Ⓟ



Double Paper Holder
YB1788



18" Towel Bar
YB1718



Towel Shelf
YB1794

24" Towel Bar
YB1724

GREENFIELD™

GREENFIELD™ Matching Bath Accessories



LIGHTING

MODEL NUMBER	LIST EACH	DESCRIPTION	QTY
Chrome (CH)			
YB1761CH	180.65	One Globe Bath Light	1
YB1762CH	252.75	Two Globe Bath Light	1
YB1763CH	313.95	Three Globe Bath Light	1
YB1764CH	402.00	Four Globe Bath Light	1
Brushed Nickel (BN)			
YB1761BN	225.90	One Globe Bath Light	1
YB1762BN	315.95	Two Globe Bath Light	1
YB1763BN	392.40	Three Globe Bath Light	1
YB1764BN	502.50	Four Globe Bath Light	1
Matte Black (BL)			
YB1761BL	246.25	One Globe Bath Light	1
YB1762BL	344.35	Two Globe Bath Light	1
YB1763BL	427.70	Three Globe Bath Light	1
YB1764BL	547.75	Four Globe Bath Light	1
Brushed Gold (BG)			
YB1761BG	271.10	One Globe Bath Light	1
YB1762BG	379.15	Two Globe Bath Light	1
YB1763BG	470.95	Three Globe Bath Light	1
YB1764BG	602.95	Four Globe Bath Light	1
Replacement Globe			
YB1769	33.10	Replacement Globe	3



One Globe Bath Light
YB1761



Two Globe Bath Light
YB1762



Three Globe Bath Light
YB1763



Four Globe Bath Light
YB1764



Replacement Globe
YB1769





Bulbs not included.

List price is per each (unless otherwise noted).



Product can be ordered by case quantity or individually.

One, Three and Four Greenfield lighting fixtures can be mounted facing either upward or downward
Two Globe lighting can be mounted facing either vertically or horizontally without the need to remove the rings.

WYNFORD® Collection

	MODEL	LIST	FINISH/CONNECT	CASE QTY
ONE-HANDLE BATHROOM FAUCET				
 DECKPLATE INCLUDED 				
OPTION: DRAIN ASSEMBLY				
				

TWO-HANDLE CENTERSET BATHROOM FAUCET				
				



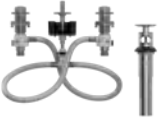







TWO-HANDLE WIDESPREAD BATHROOM FAUCET TRIM				
				
				

WIDESPREAD FAUCET VALVE				
				

HOW TO ORDER
VALVES: PAGE 469















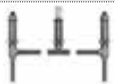

 TRIM PART #
 +
  VALVE PART #
 =
  COMPLETE FAUCET

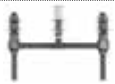

		MODEL	LIST	FINISH/CONNECT	CASE QTY
FREESTANDING TUB FILLER TRIM					
 <p>CROSS AND LEVER HANDLE INCLUDED</p> 	<ul style="list-style-type: none"> • application: one hole • showerhead type: handshower • handshower functions: one-function • handshower flow rate: 1.75 gpm (6.65 L/min) max. • spout reach: 9.75" • optional cross handle: included • mounting kit: sold separately  	655	1912.45	Chrome	1
		655BN	2581.80	Brushed Nickel	1
		655ORB	2840.05	Oil Rubbed Bronze	1
FREESTANDING TUB FILLER VALVE AND MOUNTING KIT - PREMIUM					
	<ul style="list-style-type: none"> • description: single riser floor joist mounting kit • application: one hole • quarter turn stops: included 	TS50100	408.90	1/2" CC, NPT	2
	<ul style="list-style-type: none"> • description: single riser concrete mounting kit • application: one hole • connection size: 1/2" 	TS50110	332.45	1/2" CC, NPT	2
<p>HOW TO ORDER VALVES: PAGE 469</p>	 <p>TRIM PART #</p>	+	 <p>VALVE PART #</p>	=	 <p>COMPLETE FAUCET</p>



















WYNFORD® Collection













	MODEL	LIST	FINISH/CONNECT	CASE QTY	
TWO-HANDLE ROMAN TUB TRIM					
 <ul style="list-style-type: none"> • application: three hole • spout reach: 7.50" • valve: sold separately 	T653	534.35	Chrome	3	
	T653BN	746.60	Brushed Nickel	3	
	T653ORB	821.20	Oil Rubbed Bronze	3	
TWO-HANDLE ROMAN TUB TRIM WITH HANDSHOWER					
 <ul style="list-style-type: none"> • application: four hole • showerhead type: handshower • handshower flow rate: 1.75 gpm (6.65 L/min) max. • spray functions: one-function • spout reach: 7.50" • valve: sold separately 	T654	832.15	Chrome	3	
	T654BN	1369.95	Brushed Nickel	3	
	T654ORB	1507.00	Oil Rubbed Bronze	3	
TWO-HANDLE ROMAN TUB VALVE					
 <ul style="list-style-type: none"> • deck thickness: 1/8" to 3-3/8" rough-in deck • adjustable spout shank: adjustable center dimensions 	4792	192.30	1/2" CC	6	
 <ul style="list-style-type: none"> • deck thickness: 1/8" to 2-3/4" rough-in deck • adjustable spout shank: 10" - 24" center dimensions 	4793	217.80	1/2" CPVC, Crimp Ring PEX	6	
	4794	207.65	1/2" Crimp Ring PEX, Cold Exp. PEX	6	
 <ul style="list-style-type: none"> • deck thickness: 1/8" to 3-3/16" rough-in deck • Non-adjustable spout shank: 10" center dimensions 	4796	181.20	1/2" CC	6	
	4797	184.70	1/2" CPVC, Crimp Ring PEX	6	
	4798	184.70	1/2" Crimp Ring PEX, Cold Exp. PEX	6	
TWO-HANDLE ROMAN TUB VALVE WITH HANDSHOWER					
 <ul style="list-style-type: none"> • deck thickness: 1/8" to 2-5/8" rough-in deck • non-adj spout shank: adjustable center dim's 	9792	433.35	1/2" CC	6	
 <ul style="list-style-type: none"> • deck thickness: 1/8" to 2-5/8" rough-in deck • adj spout shank: 10" - 24" center dimensions 	9793	443.50	1/2" CPVC, Crimp Ring PEX	6	
For more product details, reference page 470 in valve section.					
HOW TO ORDER VALVES: PAGE 470	 TRIM PART #	+	 VALVE PART #	=	 COMPLETE FAUCET



WYNFORD® Collection

















		MODEL	LIST	FINISH/CONNECT	CASE QTY	
EXACTTEMP® VALVE ONLY TRIM						
 <ul style="list-style-type: none"> • description: temperature control valve trim • requires: separate volume control valve • valve: sold separately  		T6601	310.40	Chrome	3	
		T6601BN	467.55	Brushed Nickel	3	
		T6601ORB	504.40	Oil Rubbed Bronze	3	
EXACTTEMP® THERMOSTATIC MIXING SHOWER VALVE - PREMIUM						
 <ul style="list-style-type: none"> • description: thermostatic rough-in valve • ports: four with adjustable temp. limit stops • check stops: included 		S3371	728.95	3/4" IPS	6	
HOW TO ORDER VALVES: PAGE 471		 TRIM PART #	+	 VALVE PART #	=	 COMPLETE FAUCET







EXACTTEMP® VOLUME CONTROL VALVE TRIM						
 <ul style="list-style-type: none"> • valve: sold separately  		T6602	157.60	Chrome	6	
		T6602BN	237.55	Brushed Nickel	6	
		T6602ORB	256.15	Oil Rubbed Bronze	6	
EXACTTEMP® VOLUME CONTROL SHOWER VALVE - PREMIUM						
 <ul style="list-style-type: none"> • includes: volume control 		S3600	185.35	3/4" IPS	12	
HOW TO ORDER VALVES: PAGE 471		 TRIM PART #	+	 VALVE PART #	=	 COMPLETE FAUCET







		MODEL	LIST	FINISH/CONNECT	CASE QTY
M-CORE® 4-SERIES TUB/SHOWER TRIM					
	<ul style="list-style-type: none"> • showerhead: single-function eco-performance rainshower • showerhead size: 7" diameter • tub spout length: 7 15/16" • tub spout connection type: slip fit • tub spout type: diverter • includes: thermostatic cartridge with volume and temperature control • valve: sold separately 	1.75 GPM (6.65 L/min) max.			
		UT45503EP	620.05	Chrome	4
		UT45503EPBN	941.45	Brushed Nickel	4
		UT45503EPORB	1072.75	Oil Rubbed Bronze	4
					
M-CORE® 4-SERIES SHOWER ONLY TRIM					
	<ul style="list-style-type: none"> • showerhead: single-function eco-performance rainshower • showerhead size: 7" diameter • includes: thermostatic cartridge with volume and temperature control • valve: sold separately 	1.75 GPM (6.65 L/min) max.			
		UT45502EP	530.65	Chrome	4
		UT45502EPBN	798.10	Brushed Nickel	4
		UT45502EPORB	903.25	Oil Rubbed Bronze	4
					
M-CORE® 4-SERIES VALVE ONLY TRIM					
	<ul style="list-style-type: none"> • includes: thermostatic cartridge with volume and temperature control • valve: sold separately 	UT45501	467.95	Chrome	3
		UT45501BN	679.80	Brushed Nickel	3
		UT45501ORB	763.45	Oil Rubbed Bronze	3
					
M-CORE® MIXING SHOWER VALVE					
	<ul style="list-style-type: none"> • tub/shower or shower only application • ports: four with adj. temp. limit stops • included: test plug and cross flow plug 	U140CI	72.60	1/2" CC/IPS	6
		U140X	72.60	1/2" Crimp Ring PEX + CC/IPS Tub	6
		U140CX	72.60	1/2" Cold Exp. PEX + CC/IPS Tub	6
		U140V	88.95	1/2" CPVC + CC/IPS Tub	6
	<ul style="list-style-type: none"> • tub/shower or shower only application • ports: four with adj. temp. limit stops • quarter turn stops: included 	U140CIS	104.50	1/2" CC/IPS	6
		U140XS	104.50	1/2" Crimp Ring PEX + CC/IPS Tub	6
		U140CXS	104.50	1/2" Cold Exp. PEX + CC/IPS Tub	6
		U140VS	120.85	1/2" CPVC + CC/IPS Tub	6
	<ul style="list-style-type: none"> • shower only application • ports: three 	U130CI	72.60	1/2" CC/IPS	6
		U130X	72.60	1/2" Crimp Ring PEX	6
		U130CX	72.60	1/2" Cold Exp. PEX	6
	<ul style="list-style-type: none"> • shower only application • ports: three • quarter turn stops: included 	U130CIS	104.50	1/2" CC/IPS	6
		U130XS	104.50	1/2" Crimp Ring PEX	6
		U130CXS	104.50	1/2" Cold Exp. PEX	6
					
<p>Four port valves can be used with either Tub/Shower or Shower Only applications. Three port valves can ONLY be used with Shower Only applications. For more product details, reference page 471 in valve section.</p>					
<p>HOW TO ORDER VALVES: PAGE 471</p>					



















WYNFORD® Collection

		MODEL	LIST	FINISH/CONNECT	CASE QTY	
M-CORE® 3-SERIES TUB/SHOWER TRIM						
 <ul style="list-style-type: none"> • showerhead: single-function rainshower • showerhead size: 7" diameter • tub spout length: 7 15/16" • tub spout connection type: slip fit • tub spout type: diverter • includes: pressure balanced cartridge with volume and temperature control • valve: sold separately 		2.5 GPM (9.5 L/min) max.				
		UT35503	518.50	Chrome	4	
		UT35503BN	864.05	Brushed Nickel	4	
		UT35503ORB	935.05	Oil Rubbed Bronze	4	
		1.75 GPM (6.65 L/min) max.				
		UT35503EP	518.50	Chrome	4	
		UT35503EPBN	864.05	Brushed Nickel	4	
		UT35503EPORB	935.05	Oil Rubbed Bronze	4	
	M-CORE® 3-SERIES SHOWER ONLY TRIM					
	 <ul style="list-style-type: none"> • showerhead: single-function rainshower • showerhead size: 7" diameter • includes: pressure balanced cartridge with volume and temperature control • valve: sold separately 		2.5 GPM (9.5 L/min) max.			
		UT35502	422.45	Chrome	4	
		UT35502BN	709.90	Brushed Nickel	4	
		UT35502ORB	765.55	Oil Rubbed Bronze	4	
		1.75 GPM (6.65 L/min) max.				
		UT35502EP	422.45	Chrome	4	
		UT35502EPBN	709.90	Brushed Nickel	4	
		UT35502EPORB	765.55	Oil Rubbed Bronze	4	
M-CORE® 3-SERIES VALVE ONLY TRIM						
 <ul style="list-style-type: none"> • includes: pressure balanced cartridge with volume and temperature control • valve: sold separately 			UT35501	355.00	Chrome	3
		UT35501BN	582.75	Brushed Nickel	3	
		UT35501ORB	625.75	Oil Rubbed Bronze	3	
	M-CORE® MIXING SHOWER VALVE					
 <ul style="list-style-type: none"> • tub/shower or shower only application • ports: four with adj. temp. limit stops • included: test plug and cross flow plug 		U140CI	72.60	1/2" CC/IPS	6	
		U140X	72.60	1/2" Crimp Ring PEX + CC/IPS Tub	6	
		U140CX	72.60	1/2" Cold Exp. PEX + CC/IPS Tub	6	
		U140V	88.95	1/2" CPVC + CC/IPS Tub	6	
 <ul style="list-style-type: none"> • tub/shower or shower only application • ports: four with adj. temp. limit stops • quarter turn stops: included 		U140CIS	104.50	1/2" CC/IPS	6	
		U140XS	104.50	1/2" Crimp Ring PEX + CC/IPS Tub	6	
		U140CXS	104.50	1/2" Cold Exp. PEX + CC/IPS Tub	6	
		U140VS	120.85	1/2" CPVC + CC/IPS Tub	6	
 <ul style="list-style-type: none"> • shower only application • ports: three 		U130CI	72.60	1/2" CC/IPS	6	
		U130X	72.60	1/2" Crimp Ring PEX	6	
		U130CX	72.60	1/2" Cold Exp. PEX	6	
 <ul style="list-style-type: none"> • shower only application • ports: three • quarter turn stops: included 		U130CIS	104.50	1/2" CC/IPS	6	
		U130XS	104.50	1/2" Crimp Ring PEX	6	
		U130CXS	104.50	1/2" Cold Exp. PEX	6	
Four port valves can be used with either Tub/Shower or Shower Only applications. Three port valves can ONLY be used with Shower Only applications. For more product details, reference page 471 in valve section.						
HOW TO ORDER VALVES: PAGE 471		 TRIM PART #	+	 VALVE PART #	=	 COMPLETE FAUCET

		MODEL	LIST	FINISH/CONNECT	CASE QTY		
M-CORE® 3-SERIES WITH INTEGRATED TRANSFER VALVE TRIM							
 <ul style="list-style-type: none"> • includes: pressure balanced cartridge with volume and temperature control • valve: sold separately 		UT5500	327.30	Chrome	4		
		UT5500BN	415.90	Brushed Nickel	4		
		UT5500ORB	447.40	Oil Rubbed Bronze	4		
M-CORE® WITH INTEGRATED TRANSFER VALVE							
Three Function (2 independent/1 shared) OR Six Function (3 independent/3 shared) - plumbing configuration page 478							
 <ul style="list-style-type: none"> • ports: four with adj. temp. limit stops • check stops: included 		U362CIS	270.70	1/2" CC/IPS	6		
		U362CXS	270.70	1/2" Cold Exp. PEX	6		
		U362XS	270.70	1/2" Crimp Ring PEX	6		
Two Independent Functions OR Three Independent Functions - plumbing configurations page 478							
 <ul style="list-style-type: none"> • ports: four with adj. temp. limit stops • check stops: included 		U232CIS	270.70	1/2" CC/IPS	6		
		U232CXS	270.70	1/2" Cold Exp. PEX	6		
		U232XS	270.70	1/2" Crimp Ring PEX	6		
For more product details, reference page 472 in valve section. See page 478 for plumbing configurations.							
HOW TO ORDER VALVES: PAGE 472		TRIM PART #	+		=		COMPLETE FAUCET

















M-CORE® TRANSFER VALVE TRIM							
 <ul style="list-style-type: none"> • use with the M-CORE® transfer valve • valve: sold separately 		UT4511	232.25	Chrome	12		
		UT4511BN	285.90	Brushed Nickel	12		
		UT4511ORB	306.80	Oil Rubbed Bronze	12		
M-CORE® TRANSFER VALVE							
Three Function (2 independent/1 shared) OR Six Function (3 independent/3 shared) - plumbing configuration page 478							
 <ul style="list-style-type: none"> • number of functions: three or six • ports: four 		U361CI	152.70	1/2" CC/IPS	6		
		U361CX	152.70	1/2" Cold Exp. PEX	6		
		U361X	152.70	1/2" Crimp Ring PEX	6		
Two Independent Functions OR Three Independent Functions - plumbing configurations page 478							
 <ul style="list-style-type: none"> • number of functions: two or three • ports: four 		U231CI	152.70	1/2" CC/IPS	6		
		U231CX	152.70	1/2" Cold Exp. PEX	6		
		U231X	152.70	1/2" Crimp Ring PEX	6		
For more product details, reference page 472 in valve section. See page 478 for plumbing configurations.							
HOW TO ORDER VALVES: PAGE 472		TRIM PART #	+		=		COMPLETE FAUCET

WYNFORD® Collection

		MODEL	LIST	FINISH/CONNECT	CASE QTY	
M-CORE® 2-SERIES TUB/SHOWER TRIM						
 <ul style="list-style-type: none"> • showerhead: single-function eco-performance rainshower • showerhead size: 5-7/8" diameter • tub spout length: 7 15/16" • tub spout connection type: slip fit • tub spout type: diverter • includes: pressure balanced cartridge with temperature control • valve: sold separately 	<ul style="list-style-type: none"> • showerhead: single-function eco-performance rainshower • showerhead size: 5-7/8" diameter • tub spout length: 7 15/16" • tub spout connection type: slip fit • tub spout type: diverter • includes: pressure balanced cartridge with temperature control • valve: sold separately 	1.75 GPM (6.65 L/min) max. UT24503EP	417.30	Chrome	3	
		UT24503EPBN	653.20	Brushed Nickel	3	
		UT24503EPORB	705.90	Oil Rubbed Bronze	3	
	M-CORE® 2-SERIES SHOWER ONLY TRIM					
 <ul style="list-style-type: none"> • showerhead: single-function eco-performance rainshower • showerhead size: 5-7/8" diameter • includes: pressure balanced cartridge with temperature control • valve: sold separately 	<ul style="list-style-type: none"> • showerhead: single-function eco-performance rainshower • showerhead size: 5-7/8" diameter • includes: pressure balanced cartridge with temperature control • valve: sold separately 	1.75 GPM (6.65 L/min) max. UT24502EP	355.45	Chrome	3	
		UT24502EPBN	541.25	Brushed Nickel	3	
		UT24502EPORB	582.45	Oil Rubbed Bronze	3	
	M-CORE® 2-SERIES VALVE ONLY TRIM					
 <ul style="list-style-type: none"> • includes: pressure balanced cartridge with temperature control • valve: sold separately 	<ul style="list-style-type: none"> • includes: pressure balanced cartridge with temperature control • valve: sold separately 	UT24501	298.90	Chrome	3	
		UT24501BN	437.75	Brushed Nickel	3	
		UT24501ORB	468.75	Oil Rubbed Bronze	3	
	M-CORE® MIXING SHOWER VALVE					
 <ul style="list-style-type: none"> • tub/shower or shower only application • ports: four with adj. temp. limit stops • included: test plug and cross flow plug 	<ul style="list-style-type: none"> • tub/shower or shower only application • ports: four with adj. temp. limit stops • included: test plug and cross flow plug 	U140CI	72.60	1/2" CC/IPS	6	
		U140X	72.60	1/2" Crimp Ring PEX + CC/IPS Tub	6	
		U140CX	72.60	1/2" Cold Exp. PEX + CC/IPS Tub	6	
		U140V	88.95	1/2" CPVC + CC/IPS Tub	6	
 <ul style="list-style-type: none"> • tub/shower or shower only application • ports: four with adj. temp. limit stops • quarter turn stops: included 	<ul style="list-style-type: none"> • tub/shower or shower only application • ports: four with adj. temp. limit stops • quarter turn stops: included 	U140CIS	104.50	1/2" CC/IPS	6	
		U140XS	104.50	1/2" Crimp Ring PEX + CC/IPS Tub	6	
		U140CXXS	104.50	1/2" Cold Exp. PEX + CC/IPS Tub	6	
		U140VS	120.85	1/2" CPVC + CC/IPS Tub	6	
 <ul style="list-style-type: none"> • shower only application • ports: three 	<ul style="list-style-type: none"> • shower only application • ports: three 	U130CI	72.60	1/2" CC/IPS	6	
		U130X	72.60	1/2" Crimp Ring PEX	6	
		U130CX	72.60	1/2" Cold Exp. PEX	6	
 <ul style="list-style-type: none"> • shower only application • ports: three • quarter turn stops: included 	<ul style="list-style-type: none"> • shower only application • ports: three • quarter turn stops: included 	U130CIS	104.50	1/2" CC/IPS	6	
		U130XS	104.50	1/2" Crimp Ring PEX	6	
		U130CXXS	104.50	1/2" Cold Exp. PEX	6	
<p>Four port valves can be used with either Tub/Shower or Shower Only applications. Three port valves can ONLY be used with Shower Only applications. For more product details, reference page 471 in valve section.</p>						
<p>HOW TO ORDER VALVES: PAGE 471</p>		 <p>TRIM PART #</p>	+	 <p>VALVE PART #</p>	=	 <p>COMPLETE FAUCET</p>















WYNFORD® Collection

MODEL LIST FINISH/CONNECT CASE QTY

POSI-TEMP® TUB/SHOWER TRIM					
 <ul style="list-style-type: none"> • showerhead: single-function standard • showerhead size: 5-7/8" diameter • tub spout length: 7 15/16" • tub spout connection type: slip fit • tub spout type: diverter • valve: sold separately 	2.5 GPM (9.5 L/min) max.				
	T4503	288.70	Chrome	3	
	T4503BN	524.55	Brushed Nickel	3	
	T4503ORB	577.20	Oil Rubbed Bronze	3	
	1.75 GPM (6.65 L/min) max.				
	T4503EP	288.70	Chrome	3	
	T4503EPBN	524.55	Brushed Nickel	3	
T4503EPORB	577.20	Oil Rubbed Bronze	3		
POSI-TEMP® SHOWER ONLY TRIM					
 <ul style="list-style-type: none"> • showerhead: single-function standard • showerhead size: 5-7/8" diameter • valve: sold separately 	2.5 GPM (9.5 L/min) max.				
	T4502	226.85	Chrome	3	
	T4502BN	412.60	Brushed Nickel	3	
	T4502ORB	453.80	Oil Rubbed Bronze	3	
	1.75 GPM (6.65 L/min) max.				
	T4502EP	226.85	Chrome	3	
	T4502EPBN	412.60	Brushed Nickel	3	
T4502EPORB	453.80	Oil Rubbed Bronze	3		
POSI-TEMP® VALVE ONLY TRIM					
 <ul style="list-style-type: none"> • valve: sold separately 	T4501	170.25	Chrome	3	
	T4501BN	309.05	Brushed Nickel	3	
	T4501ORB	340.05	Oil Rubbed Bronze	3	
	POSI-TEMP® SHOWER MIXING VALVES				
 <ul style="list-style-type: none"> • tub/shower or shower only application • ports: four with adjustable temp. limit stops • test plug: included 	2520 ◆	159.20	1/2" CC	6	
	2510 ◆	159.20	1/2" IPS	6	
 <ul style="list-style-type: none"> • tub/shower or shower only application • ports: four with adjustable temp. limit stops • quarter turn stops: included • test plug: included 	2570 ◆	193.35	1/2" CC	6	
	2590 ◆	193.35	1/2" IPS	6	
	2580 ◆	159.20	1/2" Crimp ring PEX	6	
	 <ul style="list-style-type: none"> • tub/shower only application • ports: four with adjustable temp. limit stops • quarter turn stops: included • test plug: included 	2360PF	212.60	1/2" Crimp Ring PEX	3
 <ul style="list-style-type: none"> • shower only application • ports: three with adjustable temp. limit stops • quarter turn stops: included • test plug: included 		2326PF	205.20	1/2" Crimp Ring PEX	6
	2328PF	205.20	1/2" Cold Exp. PEX	6	
<p>Four port valves can be used with either Tub/Shower or Shower Only applications. Three port valves can ONLY be used with Shower Only applications. For more product details, reference page 473-476 in valve section.</p>					
<p>HOW TO ORDER VALVES: PAGES 473-476</p>	 <p>TRIM PART #</p>	+	 <p>VALVE PART #</p>	=	 <p>COMPLETE FAUCET</p>

WYNFORD®

WYNFORD® Collection

		MODEL	LIST	FINISH/CONNECT	CASE QTY
POSI-TEMP® WITH INTEGRATED TRANSFER VALVE TRIM					
 <ul style="list-style-type: none"> • valve: sold separately  		T4500	307.35	Chrome	4
		T4500BN	558.00	Brushed Nickel	4
		T4500ORB	613.95	Oil Rubbed Bronze	4
POSI-TEMP® WITH INTEGRATED TRANSFER VALVE					
 <ul style="list-style-type: none"> • functions: three (two independent and one shared) • ports: four with adjustable temp. limit stops • test plug: included 		2551	287.50	1/2" IPS	6
 <ul style="list-style-type: none"> • functions: three (two independent and one shared) • ports: four with adjustable temp. limit stops • stops: included • test plug: included 		2581	323.75	1/2" IPS	6
 <ul style="list-style-type: none"> • functions: two independent • ports: four with adjustable temp. limit stops • test plug: included 		2521	287.50	1/2" IPS	6
 <ul style="list-style-type: none"> • functions: two independent • ports: four with adjustable temp. limit stops • stops: included • test plug: included 		2571	323.75	1/2" IPS	6
For more product details, reference page 477 in valve section.					
HOW TO ORDER VALVES: PAGE 477	 TRIM PART #	+	 VALVE PART #	=	 COMPLETE FAUCET

Moen® bath accessories CANNOT be combined with Moen faucet parts on a Purchase Order.

A line of matching accessories - including tank levers and towel bars - allow for a completely cohesive look in the bath.

MODEL NUMBER	LIST EACH	DESCRIPTION	QTY
Chrome (CH)			
YB5201CH	48.05	Tank Lever	6
YB5203CH	37.00	Double Robe Hook	24
Ⓟ YB5208CH	67.45	Pivoting Paper Holder	6
YB5218CH	78.35	18" Towel Bar	6
YB5222CH	107.25	24" Double Towel Bar	6
YB5224CH	80.80	24" Towel Bar	6
YB5275CH	167.20	Corner Shower Basket	6
YB5286CH	55.00	Towel Ring	6
Brushed Nickel (BN)			
YB5201BN	53.05	Tank Lever	6
YB5203BN	40.70	Double Robe Hook	24
Ⓟ YB5208BN	74.60	Pivoting Paper Holder	6
YB5218BN	86.15	18" Towel Bar	6
YB5222BN	113.05	24" Double Towel Bar	6
YB5224BN	89.20	24" Towel Bar	6
YB5275BN	191.25	Corner Shower Basket	6
YB5286BN	60.15	Towel Ring	6
Oil Rubbed Bronze (ORB)			
YB5201ORB	58.25	Tank Lever	6
YB5203ORB	44.70	Double Robe Hook	24
Ⓟ YB5208ORB	82.10	Pivoting Paper Holder	6
YB5218ORB	94.70	18" Towel Bar	6
YB5222ORB	118.70	24" Double Towel Bar	6
YB5224ORB	98.15	24" Towel Bar	6
YB5286ORB	66.15	Towel Ring	6
Old World Bronze (OWB)			
YB5275OWB	207.25	Corner Shower Basket	6

Ⓟ Denotes pivoting paper holder



Tank Lever
YB5201



Double Robe Hook
YB5203



Towel Ring
YB5286



Pivoting Paper Holder
YB5208 | Ⓟ



18" Towel Bar
YB5218



24" Double Towel Bar
YB5222

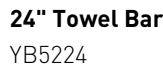

















24" Towel Bar
YB5224



















Shower Basket
YB5275



















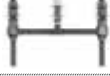







			MODEL	LIST	FINISH/CONNECT	CASE QTY		
ONE-HANDLE BATHROOM FAUCET								
 DECKPLATE INCLUDED 	<ul style="list-style-type: none"> • application: one or three hole • supply lines: flexible • connection: 3/8" compression • deckplate: included • drain assembly: metal with lift rod • red/blue markings: included ♿ DURALAST®	1.2 GPM (4.5L/min) max.	6190	363.60	Chrome	3		
			6190BN	481.25	Brushed Nickel	3		
			6190BL	516.90	Matte Black	3		
			6190BG	527.20	Brushed Gold	3		
 DECKPLATE INCLUDED NEW! Q3 	<ul style="list-style-type: none"> • application: one or three hole • supply lines: flexible • connection: 3/8" compression • deckplate: included • drain assembly: metal with lift rod • red/blue markings: included ♿ DURALAST®	1.0 GPM (3.8L/min) max.	6198	363.60	Chrome	3		
			6198BN	481.25	Brushed Nickel	3		
			6198BL	516.90	Matte Black	3		
 DECKPLATE SOLD SEPARATELY 	<ul style="list-style-type: none"> • application: one or three hole • supply lines: flexible • connection: 3/8" compression • deckplate: sold separately • drain assembly: metal with lift rod • red/blue markings: included ♿ DURALAST®	1.2 GPM (4.5L/min) max.	6191	353.85	Chrome	3		
			6191BN	468.30	Brushed Nickel	3		
			6191BL	485.65	Matte Black	3		
			6191BG	513.05	Brushed Gold	3		
			OPTIONAL DECKPLATE SOLD SEPARATELY					
			172666	19.50	Chrome	20		
			172666BN	24.15	Brushed Nickel	20		
			172666BL	34.00	Matte Black	20		
			172666BG	24.15	Brushed Gold	20		
 DECKPLATE SOLD SEPARATELY 	<ul style="list-style-type: none"> • application: one or three hole • supply lines: flexible • connection: 3/8" compression • deckplate: sold separately • drain assembly: 140780 sold separately • red/blue markings: included ♿ DURALAST®	1.2 GPM (4.5L/min) max.	6192	538.25	Chrome	3		
			6192BN	699.75	Brushed Nickel	3		
			6192BL	726.65	Matte Black	3		
			6192BG	780.45	Brushed Gold	3		
			OPTIONAL DECKPLATE SOLD SEPARATELY					
			172666	19.50	Chrome	20		
			172666BN	24.15	Brushed Nickel	20		
			172666BL	34.00	Matte Black	20		
			172666BG	24.15	Brushed Gold	20		
OPTION: DRAIN ASSEMBLY								
	<ul style="list-style-type: none"> • drain assembly: metal • drain assembly type: spring loaded pop-up • drain assembly size: 1-1/4" • drain assembly: 1-1/4" non-overflow 		140780	78.35	Chrome	12		
			140780BN	109.20	Brushed Nickel	12		
			140780BL	123.30	Matte Black	12		
			140780BG	109.20	Brushed Gold	12		









		MODEL	LIST	FINISH/CONNECT	CASE QTY	
TWO-HANDLE WIDESPREAD BATHROOM FAUCET TRIM						
 <ul style="list-style-type: none"> • application: three hole • center dimensions: 8" - 16" center • drain assembly: metal with lift rod • valve: sold separately 			1.2 GPM (4.5L/min) max.			
	T6193	377.60	Chrome	3		
	T6193BN	573.75	Brushed Nickel	3		
	T6193BL	592.30	Matte Black	3		
	T6193BG	610.80	Brushed Gold	3		
WIDESPREAD FAUCET VALVE						
 <ul style="list-style-type: none"> • application: three hole • center dimensions: 8" - 16" center • drain assembly: metal with lift rod  DURALOCK® DURALAST®	9000◆	165.40	1/2" IPS	6		
HOW TO ORDER VALVES: PAGE 469		 TRIM PART #	+	 VALVE PART #	=	 COMPLETE FAUCET

FREESTANDING TUB FILLER TRIM						
 <ul style="list-style-type: none"> • application: one hole • showerhead type: handshower • handshower functions: one-function • handshower flow rate: 1.75 gpm (6.65L/min) max. • spout reach: 9.75" • mounting kit: sold separately 	395	1752.20	Chrome	1		
	395BN	2365.55	Brushed Nickel	1		
	395BG	2365.55	Brushed Gold	1		
	395BL	2601.95	Matte Black	1		
	FREESTANDING TUB FILLER VALVE AND MOUNTING KIT - PREMIUM					
 <ul style="list-style-type: none"> • description: single riser floor joist mounting kit • application: one hole • quarter turn stops: included 	TS50100	408.90	1/2" CC, NPT	2		
 <ul style="list-style-type: none"> • description: single riser concrete mounting kit • application: one hole • connection size: 1/2" 	TS50110	332.45	1/2" CC, NPT	2		
HOW TO ORDER VALVES: PAGE 469		 TRIM PART #	+	 VALVE PART #	=	 COMPLETE FAUCET

















ONE-HANDLE WALLMOUNT TUB FILLER TRIM						
 <ul style="list-style-type: none"> • application: two hole • connection: 1/2" slip fit • tub spout type: non diverter • spout reach: 10.00" • includes: high flow volume control cartridge • WMV130 series valve kit: sold separately 	WT391	734.65	Chrome	3		
	WT391BN	984.45	Brushed Nickel	3		
	WT391BG	984.45	Brushed Gold	3		
	WT391BL	1082.85	Matte Black	3		
	ONE-HANDLE WALLMOUNT TUB FILLER VALVE KIT					
 <ul style="list-style-type: none"> • application: two hole with adj. center dimensions • ports: three • quarter turn stops: included • includes: test plug • includes: spout manifold 	WMV130CIS	154.05	1/2" CC/IPS	6		
WMV130XS	154.05	1/2" Crimp Ring PEX	6			
WMV130CXS	154.05	1/2" Cold Exp. PEX	6			
HOW TO ORDER VALVES: PAGE 469		 TRIM PART #	+	 VALVE PART #	=	 COMPLETE FAUCET

		MODEL	LIST	FINISH/CONNECT	CASE QTY
TWO-HANDLE ROMAN TUB TRIM					
 <ul style="list-style-type: none"> • application: three hole • spout reach: 7.90" • valve: sold separately 		T393	534.35	Chrome	3
		T393BN	746.60	Brushed Nickel	3
		T393BG	746.60	Brushed Gold	3
		T393BL	791.20	Matte Black	3
TWO-HANDLE ROMAN TUB TRIM WITH HANDSHOWER					
 <ul style="list-style-type: none"> • application: four hole • showerhead type: handshower • handshower flow rate: 1.75 gpm (6.65 L/min) max. • spray functions: one-function • spout reach: 7.90" • valve: sold separately 		T394	832.15	Chrome	3
		T394BN	1369.95	Brushed Nickel	3
		T394BG	1369.95	Brushed Gold	3
TWO-HANDLE ROMAN TUB VALVE					
 <ul style="list-style-type: none"> • deck thickness: 1/8" to 3-3/8" rough-in deck • adjustable spout shank: adjustable center dimensions 	4792	192.30	1/2" CC	6	
 <ul style="list-style-type: none"> • deck thickness: 1/8" to 2-3/4" rough-in deck • adjustable spout shank: 10" - 24" center dimensions 	4793	217.80	1/2" CPVC, Crimp Ring PEX	6	
	4794	207.65	1/2" Crimp Ring PEX, Cold Exp. PEX	6	
 <ul style="list-style-type: none"> • deck thickness: 1/8" to 3-3/16" rough-in deck • Non-adjustable spout shank: 10" center dimensions 	4796	181.20	1/2" CC	6	
	4797	184.70	1/2" CPVC, Crimp Ring PEX	6	
	4798	184.70	1/2" Crimp Ring PEX, Cold Exp. PEX	6	
TWO-HANDLE ROMAN TUB VALVE WITH HANDSHOWER					
 <ul style="list-style-type: none"> • deck thickness: 1/8" to 2-5/8" rough-in deck • non-adj spout shank: adjustable center dim's 	9792	433.35	1/2" CC	6	
 <ul style="list-style-type: none"> • deck thickness: 1/8" to 2-5/8" rough-in deck • adj spout shank: 10" - 24" center dimensions 	9793	443.50	1/2" CPVC, Crimp Ring PEX	6	
For more product details, reference page 470 in valve section.					
HOW TO ORDER VALVES: PAGE 470	 TRIM PART #	+	 VALVE PART #	=	 COMPLETE FAUCET

















		MODEL	LIST	FINISH/CONNECT	CASE QTY	
EXACTTEMP® VALVE ONLY TRIM						
 <ul style="list-style-type: none"> • description: temperature control valve trim • requires: separate volume control valve • valve: sold separately  		T4291	309.60	Chrome	3	
		T4291BN	467.55	Brushed Nickel	3	
		T4291BG	467.55	Brushed Gold	3	
		T4291BL	503.10	Matte Black	3	
EXACTTEMP® THERMOSTATIC MIXING SHOWER VALVE - PREMIUM						
 <ul style="list-style-type: none"> • description: thermostatic rough-in valve • ports: four with adjustable temp. limit stops • check stops: included 		S3371	728.95	¾" IPS	6	
HOW TO ORDER VALVES: PAGE 471		 TRIM PART #	+	 VALVE PART #	=	 COMPLETE FAUCET

EXACTTEMP® VOLUME CONTROL VALVE TRIM						
 <ul style="list-style-type: none"> • valve: sold separately  		T4292	157.60	Chrome	6	
		T4292BN	237.55	Brushed Nickel	6	
		T4292BG	237.55	Brushed Gold	6	
		T4292BL	256.15	Matte Black	6	
EXACTTEMP® VOLUME CONTROL SHOWER VALVE - PREMIUM						
 <ul style="list-style-type: none"> • includes: volume control 		S3600	185.35	¾" IPS	12	
HOW TO ORDER VALVES: PAGE 471		 TRIM PART #	+	 VALVE PART #	=	 COMPLETE FAUCET

ALIGN® Collection











		MODEL	LIST	FINISH/CONNECT	CASE QTY	
M-CORE® 4-SERIES TUB/SHOWER TRIM						
 <ul style="list-style-type: none"> • showerhead: single-function eco-performance rainshower • showerhead size: 7" diameter • tub spout length: 7" • tub spout connection type: slip fit • tub spout type: diverter • includes: thermostatic cartridge with volume and temperature control • valve: sold separately 	<ul style="list-style-type: none"> • 1.75 GPM (6.65 L/min) max. 					
		UT4293EP	656.20	Chrome	4	
		UT4293EPBN	1001.75	Brushed Nickel	4	
		UT4293EPBG	1001.75	Brushed Gold	4	
		UT4293EPBL	1088.15	Matte Black	4	
M-CORE® 4-SERIES SHOWER ONLY TRIM						
 <ul style="list-style-type: none"> • showerhead: single-function eco-performance rainshower • showerhead size: 7" diameter • includes: thermostatic cartridge with volume and temperature control • valve: sold separately 	<ul style="list-style-type: none"> • 1.75 GPM (6.65 L/min) max. 					
		UT4292EP	560.15	Chrome	4	
		UT4292EPBN	847.60	Brushed Nickel	4	
		UT4292EPBG	847.60	Brushed Gold	4	
		UT4292EPBL	918.60	Matte Black	4	
M-CORE® 4-SERIES VALVE ONLY TRIM						
 <ul style="list-style-type: none"> • includes: thermostatic cartridge with volume and temperature control • valve: sold separately 						
		UT4291	492.70	Chrome	3	
		UT4291BN	720.45	Brushed Nickel	3	
		UT4291BG	720.45	Brushed Gold	3	
		UT4291BL	778.65	Matte Black	3	
M-CORE® MIXING SHOWER VALVE						
 <ul style="list-style-type: none"> • tub/shower or shower only application • ports: four with adj. temp. limit stops • included: test plug and cross flow plug 						
		U140CI	72.60	1/2" CC/IPS	6	
		U140X	72.60	1/2" Crimp Ring PEX + CC/IPS Tub	6	
		U140CX	72.60	1/2" Cold Exp. PEX + CC/IPS Tub	6	
 <ul style="list-style-type: none"> • tub/shower or shower only application • ports: four with adj. temp. limit stops • quarter turn stops: included 						
		U140V	88.95	1/2" CPVC + CC/IPS Tub	6	
		U140CIS	104.50	1/2" CC/IPS	6	
		U140XS	104.50	1/2" Crimp Ring PEX + CC/IPS Tub	6	
 <ul style="list-style-type: none"> • shower only application • ports: three 						
		U140CXS	104.50	1/2" Cold Exp. PEX + CC/IPS Tub	6	
		U140VS	120.85	1/2" CPVC + CC/IPS Tub	6	
		U130CI	72.60	1/2" CC/IPS	6	
 <ul style="list-style-type: none"> • shower only application • ports: three • quarter turn stops: included 						
		U130X	72.60	1/2" Crimp Ring PEX	6	
		U130CX	72.60	1/2" Cold Exp. PEX	6	
		U130CIS	104.50	1/2" CC/IPS	6	
	U130XS	104.50	1/2" Crimp Ring PEX	6		
	U130CXS	104.50	1/2" Cold Exp. PEX	6		
<p>Four port valves can be used with either Tub/Shower or Shower Only applications. Three port valves can ONLY be used with Shower Only applications. For more product details, reference page 471 in valve section.</p>						
<p>HOW TO ORDER VALVES: PAGE 471</p>		 <p>TRIM PART #</p>	+	 <p>VALVE PART #</p>	=	 <p>COMPLETE FAUCET</p>











MODEL LIST FINISH/CONNECT CASE QTY



















M-CORE® 3-SERIES TUB/SHOWER TRIM					
 <ul style="list-style-type: none"> • showerhead: single-function rainshower • showerhead size: 6-3/4" diameter • tub spout length: 7 3/8" • tub spout connection type: slip fit • tub spout type: diverter • includes: pressure balanced cartridge with volume and temperature control • valve: sold separately 	<ul style="list-style-type: none"> • 2.5 GPM (9.5 L/min) max. 				
	UT3293	518.50	Chrome	4	
	UT3293BN	864.05	Brushed Nickel	4	
	UT3293BG	864.05	Brushed Gold	4	
	UT3293BL	950.45	Matte Black	4	
	<ul style="list-style-type: none"> • 1.75 GPM (6.65 L/min) max. 				
	UT3293EP	518.50	Chrome	4	
	UT3293EPBN	864.05	Brushed Nickel	4	
	UT3293EPBG	864.05	Brushed Gold	4	
	UT3293EPBL	950.45	Matte Black	4	
M-CORE® 3-SERIES SHOWER ONLY TRIM					
 <ul style="list-style-type: none"> • showerhead: single-function rainshower • showerhead size: 6-3/4" diameter • includes: pressure balanced cartridge with volume and temperature control • valve: sold separately 	<ul style="list-style-type: none"> • 2.5 GPM (9.5 L/min) max. 				
	UT3292	422.45	Chrome	4	
	UT3292BN	709.90	Brushed Nickel	4	
	UT3292BG	709.90	Brushed Gold	4	
	UT3292BL	780.90	Matte Black	4	
	<ul style="list-style-type: none"> • 1.75 GPM (6.65 L/min) max. 				
	UT3292EP	422.45	Chrome	4	
	UT3292EPBN	709.90	Brushed Nickel	4	
	UT3292EPBG	709.90	Brushed Gold	4	
	UT3292EPBL	780.90	Matte Black	4	
M-CORE® 3-SERIES VALVE ONLY TRIM					
 <ul style="list-style-type: none"> • includes: pressure balanced cartridge with volume and temperature control • valve: sold separately 	UT3291	355.00	Chrome	3	
	UT3291BN	582.75	Brushed Nickel	3	
	UT3291BG	582.75	Brushed Gold	3	
	UT3291BL	640.95	Matte Black	3	
	M-CORE® MIXING SHOWER VALVE				
 <ul style="list-style-type: none"> • tub/shower or shower only application • ports: four with adj. temp. limit stops • included: test plug and cross flow plug 	U140CI	72.60	1/2" CC/IPS	6	
	U140X	72.60	1/2" Crimp Ring PEX + CC/IPS Tub	6	
	U140CX	72.60	1/2" Cold Exp. PEX + CC/IPS Tub	6	
	U140V	88.95	1/2" CPVC + CC/IPS Tub	6	
	 <ul style="list-style-type: none"> • tub/shower or shower only application • ports: four with adj. temp. limit stops • quarter turn stops: included 	U140CIS	104.50	1/2" CC/IPS	6
U140XS		104.50	1/2" Crimp Ring PEX + CC/IPS Tub	6	
U140CXS		104.50	1/2" Cold Exp. PEX + CC/IPS Tub	6	
U140VS		120.85	1/2" CPVC + CC/IPS Tub	6	
 <ul style="list-style-type: none"> • shower only application • ports: three 	U130CI	72.60	1/2" CC/IPS	6	
	U130X	72.60	1/2" Crimp Ring PEX	6	
	U130CX	72.60	1/2" Cold Exp. PEX	6	
 <ul style="list-style-type: none"> • shower only application • ports: three • quarter turn stops: included 	U130CIS	104.50	1/2" CC/IPS	6	
	U130XS	104.50	1/2" Crimp Ring PEX	6	
	U130CXS	104.50	1/2" Cold Exp. PEX	6	
<p>Four port valves can be used with either Tub/Shower or Shower Only applications. Three port valves can ONLY be used with Shower Only applications. For more product details, reference page 471 in valve section.</p>					
<p>HOW TO ORDER VALVES: PAGE 471</p>	 <p>TRIM PART #</p>	+	 <p>VALVE PART #</p>	=	 <p>COMPLETE FAUCET</p>



ALIGN® Collection















		MODEL	LIST	FINISH/CONNECT	CASE QTY			
M-CORE® 3-SERIES WITH INTEGRATED TRANSFER VALVE TRIM								
 <ul style="list-style-type: none"> • includes: pressure balanced cartridge with volume and temperature control • valve: sold separately 	 	UT3290	335.50	Chrome	4			
		UT3290BN	415.90	Brushed Nickel	4			
		UT3290BG	415.90	Brushed Gold	4			
		UT3290BL	457.50	Matte Black	4			
M-CORE® WITH INTEGRATED TRANSFER VALVE								
Three Function (2 independent/1 shared) OR Six Function (3 independent/3 shared) - plumbing configuration page 478								
 <ul style="list-style-type: none"> • ports: four with adj. temp. limit stops • check stops: included 		U362CIS	270.70	1/2" CC/IPS	6			
		U362CXS	270.70	1/2" Cold Exp. PEX	6			
		U362XS	270.70	1/2" Crimp Ring PEX	6			
Two Independent Functions OR Three Independent Functions - plumbing configurations page 478								
 <ul style="list-style-type: none"> • ports: four with adj. temp. limit stops • check stops: included 		U232CIS	270.70	1/2" CC/IPS	6			
		U232CXS	270.70	1/2" Cold Exp. PEX	6			
		U232XS	270.70	1/2" Crimp Ring PEX	6			
For more product details, reference page 472 in valve section. See page 478 for plumbing configurations.								
HOW TO ORDER VALVES: PAGE 472		TRIM PART #	+		VALVE PART #	=		COMPLETE FAUCET





















M-CORE® TRANSFER VALVE TRIM								
 <ul style="list-style-type: none"> • use with the M-CORE® transfer valve • valve: sold separately 	 	UT4191	232.25	Chrome	12			
		UT4191BN	285.90	Brushed Nickel	12			
		UT4191BG	285.90	Brushed Gold	12			
		UT4191BL	306.80	Matte Black	12			
M-CORE® TRANSFER VALVE								
Three Function (2 independent/1 shared) OR Six Function (3 independent/3 shared) - plumbing configuration page 478								
 <ul style="list-style-type: none"> • number of functions: three or six • ports: four 		U361CI	152.70	1/2" CC/IPS	6			
		U361CX	152.70	1/2" Cold Exp. PEX	6			
		U361X	152.70	1/2" Crimp Ring PEX	6			
Two Independent Functions OR Three Independent Functions - plumbing configurations page 478								
 <ul style="list-style-type: none"> • number of functions: two or three • ports: four 		U231CI	152.70	1/2" CC/IPS	6			
		U231CX	152.70	1/2" Cold Exp. PEX	6			
		U231X	152.70	1/2" Crimp Ring PEX	6			
For more product details, reference page 472 in valve section. See page 478 for plumbing configurations.								
HOW TO ORDER VALVES: PAGE 472		TRIM PART #	+		VALVE PART #	=		COMPLETE FAUCET

		MODEL	LIST	FINISH/CONNECT	CASE QTY	
M-CORE® 2-SERIES TUB/SHOWER TRIM						
 <ul style="list-style-type: none"> • showerhead: single-function eco-performance • showerhead size: 3-5/8" diameter • tub spout length: 7 3/8" • tub spout connection type: slip fit • tub spout type: diverter • red/blue markings: included • includes: pressure balanced cartridge with temperature control • valve: sold separately 		1.75 GPM (6.65 L/min) max.				
		UT2193EP	417.30	Chrome	3	
		UT2193EPBN	653.20	Brushed Nickel	3	
		UT2193EPBG	653.20	Brushed Gold	3	
		UT2193EPBL	705.60	Matte Black	3	
 <ul style="list-style-type: none"> • showerhead type: showerhead sold separately • tub spout length: 7 3/8" • tub spout connection type: slip fit • tub spout type: diverter • red/blue markings: included • includes: pressure balanced cartridge with temperature control • valve: sold separately 		UT2193NH	323.10	Chrome	3	
		UT2193NHBN	508.75	Brushed Nickel	3	
		UT2193NHBG	508.75	Brushed Gold	3	
		UT2193NHBL	546.80	Matte Black	3	
	M-CORE® 2-SERIES SHOWER ONLY TRIM					
 <ul style="list-style-type: none"> • showerhead: single-function eco-performance • showerhead size: 3-5/8" diameter • red/blue markings: included • includes: pressure balanced cartridge with temperature control • valve: sold separately 		1.75 GPM (6.65 L/min) max.				
		UT2192EP	355.45	Chrome	12	
		UT2192EPBN	541.25	Brushed Nickel	12	
		UT2192EPBG	541.25	Brushed Gold	12	
		UT2192EPBL	582.55	Matte Black	12	
 <ul style="list-style-type: none"> • showerhead type: showerhead sold separately • red/blue markings: included • includes: pressure balanced cartridge with temperature control • valve: sold separately 		UT2192NH	309.05	Chrome	3	
		UT2192NHBN	456.40	Brushed Nickel	3	
		UT2192NHBG	456.40	Brushed Gold	3	
		UT2192NHBL	489.25	Matte Black	3	
	M-CORE® MIXING SHOWER VALVE					
 <ul style="list-style-type: none"> • tub/shower or shower only application • ports: four with adj. temp. limit stops • included: test plug and cross flow plug 		U140CI	72.60	1/2" CC/IPS	6	
		U140X	72.60	1/2" Crimp Ring PEX + CC/IPS Tub	6	
		U140CX	72.60	1/2" Cold Exp. PEX + CC/IPS Tub	6	
		U140V	88.95	1/2" CPVC + CC/IPS Tub	6	
	 <ul style="list-style-type: none"> • tub/shower or shower only application • ports: four with adj. temp. limit stops • quarter turn stops: included 		U140CIS	104.50	1/2" CC/IPS	6
		U140XS	104.50	1/2" Crimp Ring PEX + CC/IPS Tub	6	
		U140CXS	104.50	1/2" Cold Exp. PEX + CC/IPS Tub	6	
		U140VS	120.85	1/2" CPVC + CC/IPS Tub	6	
 <ul style="list-style-type: none"> • shower only application • ports: three 			U130CI	72.60	1/2" CC/IPS	6
		U130X	72.60	1/2" Crimp Ring PEX	6	
		U130CX	72.60	1/2" Cold Exp. PEX	6	
 <ul style="list-style-type: none"> • shower only application • ports: three • quarter turn stops: included 		U130CIS	104.50	1/2" CC/IPS	6	
		U130XS	104.50	1/2" Crimp Ring PEX	6	
		U130CXS	104.50	1/2" Cold Exp. PEX	6	
<p>Four port valves can be used with either Tub/Shower or Shower Only applications. Three port valves can ONLY be used with Shower Only applications. For more product details, reference page 471 in valve section.</p>						
<p>HOW TO ORDER VALVES: PAGE 471</p>		 <p>TRIM PART #</p>	+	 <p>VALVE PART #</p>	=	 <p>COMPLETE FAUCET</p>

















ALIGN® Collection

		MODEL	LIST	FINISH/CONNECT	CASE QTY	
M-CORE® 2-SERIES VALVE ONLY TRIM						
 <ul style="list-style-type: none"> • red/blue markings: included • includes: pressure balanced cartridge with temperature control • valve: sold separately  		UT2191	298.90	Chrome	3	
		UT2191BN	437.75	Brushed Nickel	3	
		UT2191BG	437.75	Brushed Gold	3	
		UT2191BL	468.75	Matte Black	3	
M-CORE® MIXING SHOWER VALVE						
 <ul style="list-style-type: none"> • tub/shower or shower only application • ports: four with adj. temp. limit stops • included: test plug and cross flow plug 		U140CI	72.60	1/2" CC/IPS	6	
		U140X	72.60	1/2" Crimp Ring PEX + CC/IPS Tub	6	
		U140CX	72.60	1/2" Cold Exp. PEX + CC/IPS Tub	6	
		U140V	88.95	1/2" CPVC + CC/IPS Tub	6	
 <ul style="list-style-type: none"> • tub/shower or shower only application • ports: four with adj. temp. limit stops • quarter turn stops: included 		U140CIS	104.50	1/2" CC/IPS	6	
		U140XS	104.50	1/2" Crimp Ring PEX + CC/IPS Tub	6	
		U140CXS	104.50	1/2" Cold Exp. PEX + CC/IPS Tub	6	
		U140VS	120.85	1/2" CPVC + CC/IPS Tub	6	
 <ul style="list-style-type: none"> • shower only application • ports: three 		U130CI	72.60	1/2" CC/IPS	6	
		U130X	72.60	1/2" Crimp Ring PEX	6	
		U130CX	72.60	1/2" Cold Exp. PEX	6	
 <ul style="list-style-type: none"> • shower only application • ports: three • quarter turn stops: included 		U130CIS	104.50	1/2" CC/IPS	6	
		U130XS	104.50	1/2" Crimp Ring PEX	6	
		U130CXS	104.50	1/2" Cold Exp. PEX	6	
Four port valves can be used with either Tub/Shower or Shower Only applications. Three port valves can ONLY be used with Shower Only applications. For more product details, reference page 471 in valve section.						
HOW TO ORDER VALVES: PAGE 471		 TRIM PART #	+	 VALVE PART #	=	 COMPLETE FAUCET

		MODEL	LIST	FINISH/CONNECT	CASE QTY	
POSI-TEMP® TUB/SHOWER TRIM						
 <ul style="list-style-type: none"> • showerhead: single-function standard • showerhead size: 3-5/8" diameter • tub spout length: 7 3/8" • tub spout connection type: slip fit • tub spout type: diverter • red/blue markings: included • valve: sold separately 		2.5 GPM (9.5 L/min) max.				
		T2193	288.70	Chrome	3	
		T2193BN	524.55	Brushed Nickel	3	
		T2193BG	524.55	Brushed Gold	3	
		T2193BL	576.90	Matte Black	3	
		1.75 GPM (6.65 L/min) max.				
		T2193EP	288.70	Chrome	3	
		T2193EPBN	524.55	Brushed Nickel	3	
		T2193EPBG	524.55	Brushed Gold	3	
		T2193EPBL	576.90	Matte Black	3	
 <ul style="list-style-type: none"> • showerhead type: showerhead sold separately • tub spout length: 7 3/8" • tub spout connection type: slip fit • tub spout type: diverter • red/blue markings: included • valve: sold separately 		T2193NH	194.40	Chrome	3	
		T2193NHBN	380.05	Brushed Nickel	3	
		T2193NHBG	380.05	Brushed Gold	3	
		T2193NHBL	418.15	Matte Black	3	
POSI-TEMP® SHOWER ONLY TRIM						
 <ul style="list-style-type: none"> • showerhead: single-function standard • showerhead size: 3-5/8" diameter • red/blue markings: included • valve: sold separately 		2.5 GPM (9.5 L/min) max.				
		T2192	226.85	Chrome	3	
		T2192BN	412.60	Brushed Nickel	3	
		T2192BG	412.60	Brushed Gold	3	
		T2192BL	453.95	Matte Black	3	
		1.75 GPM (6.65 L/min) max.				
		T2192EP	226.85	Chrome	3	
		T2192EPBN	412.60	Brushed Nickel	3	
		T2192EPBG	412.60	Brushed Gold	3	
		T2192EPBL	453.95	Matte Black	3	
 <ul style="list-style-type: none"> • showerhead type: showerhead sold separately • red/blue markings: included • valve: sold separately 		T2192NH	180.50	Chrome	3	
		T2192NHBN	327.80	Brushed Nickel	3	
		T2192NHBG	327.80	Brushed Gold	3	
		T2192NHBL	360.55	Matte Black	3	
POSI-TEMP® VALVE ONLY TRIM						
 <ul style="list-style-type: none"> • red/blue markings: included • valve: sold separately 		T2191	170.25	Chrome	3	
		T2191BN	309.05	Brushed Nickel	3	
		T2191BG	309.05	Brushed Gold	3	
		T2191BL	340.05	Matte Black	3	
POSI-TEMP® SHOWER MIXING VALVES						
 <ul style="list-style-type: none"> • tub/shower or shower only application • ports: four with adjustable temp. limit stops • test plug: included 		2520 ◆	159.20	1/2" CC	6	
		2510 ◆	159.20	1/2" IPS	6	
 <ul style="list-style-type: none"> • tub/shower or shower only application • ports: four with adjustable temp. limit stops • quarter turn stops: included • test plug: included 		2570 ◆	193.35	1/2" CC	6	
		2590 ◆	193.35	1/2" IPS	6	
		2580 ◆	159.20	1/2" Crimp ring PEX	6	
 <ul style="list-style-type: none"> • tub/shower only application • ports: four with adjustable temp. limit stops • quarter turn stops: included • test plug: included 		2360PF	212.60	1/2" Crimp Ring PEX	3	
 <ul style="list-style-type: none"> • shower only application • ports: three with adjustable temp. limit stops • quarter turn stops: included • test plug: included 		2326PF	205.20	1/2" Crimp Ring PEX	6	
		2328PF	205.20	1/2" Cold Exp. PEX	6	
<p>Four port valves can be used with either Tub/Shower or Shower Only applications. Three port valves can ONLY be used with Shower Only applications. For more product details, reference page 473-476 in valve section.</p>						
HOW TO ORDER VALVES: PAGES 473-476		 TRIM PART #	+	 VALVE PART #	=	 COMPLETE FAUCET



ALIGN® Collection

		MODEL	LIST	FINISH/CONNECT	CASE QTY
POSI-TEMP® WITH INTEGRATED TRANSFER VALVE TRIM					
 <ul style="list-style-type: none"> • red/blue markings: included • valve: sold separately  		T2190	307.35	Chrome	4
		T2190BN	558.00	Brushed Nickel	4
		T2190BG	558.00	Brushed Gold	4
		T2190BL	613.95	Matte Black	4
POSI-TEMP® WITH INTEGRATED TRANSFER VALVE					
 <ul style="list-style-type: none"> • functions: three (two independent and one shared) • ports: four with adjustable temp. limit stops • test plug: included 		2551	287.50	1/2" IPS	6
 <ul style="list-style-type: none"> • functions: three (two independent and one shared) • ports: four with adjustable temp. limit stops • stops: included • test plug: included 		2581	323.75	1/2" IPS	6
 <ul style="list-style-type: none"> • functions: two independent • ports: four with adjustable temp. limit stops • test plug: included 		2521	287.50	1/2" IPS	6
 <ul style="list-style-type: none"> • functions: two independent • ports: four with adjustable temp. limit stops • stops: included • test plug: included 		2571	323.75	1/2" IPS	6
For more product details, reference page 477 in valve section.					
HOW TO ORDER VALVES: PAGE 477	 TRIM PART #	+	 VALVE PART #	=	 COMPLETE FAUCET

Moen® bath accessories CANNOT be combined with Moen faucet parts on a Purchase Order.

A line of matching accessories - including tank levers and towel bars - allow for a completely cohesive look in the bath.

MODEL NUMBER	LIST EACH	DESCRIPTION	QTY
Chrome (CH)			
YB0402CH	66.85	Swiveling Double Robe Hook	24
YB0403CH	37.00	Single Robe Hook	24
Ⓟ YB0408CH	67.45	Pivoting Paper Holder	6
YB0409CH	57.45	Single-Post Paper Holder	6
YB0418CH	78.35	18" Towel Bar	6
YB0424CH	80.80	24" Towel Bar	6
YB0486CH	55.00	Hand Towel Bar	6
Brushed Nickel (BN)			
YB0402BN	76.15	Swiveling Double Robe Hook	24
YB0403BN	40.70	Single Robe Hook	24
Ⓟ YB0408BN	74.60	Pivoting Paper Holder	6
YB0409BN	63.20	Single-Post Paper Holder	6
YB0418BN	86.15	18" Towel Bar	6
YB0424BN	89.20	24" Towel Bar	6
YB0486BN	60.15	Hand Towel Bar	6
Matte Black (BL)			
YB0402BL	83.55	Swiveling Double Robe Hook	24
YB0403BL	44.70	Single Robe Hook	24
Ⓟ YB0408BL	82.05	Pivoting Paper Holder	6
YB0409BL	69.45	Single-Post Paper Holder	6
YB0418BL	94.70	18" Towel Bar	6
YB0424BL	98.05	24" Towel Bar	6
YB0486BL	66.15	Hand Towel Bar	6
Brushed Gold (BG)			
YB0403BG	48.85	Single Robe Hook	24
Ⓟ YB0408BG	108.20	Pivoting Paper Holder	6
YB0418BG	120.60	18" Towel Bar	6
YB0424BG	124.75	24" Towel Bar	6
YB0486BG	87.15	Hand Towel Bar	6

Ⓟ Denotes pivoting paper holder



Single Robe Hook
YB0403



Swiveling Double Robe Hook
YB0402



Pivoting Paper Holder
YB0408 | Ⓟ



Single Post Paper Holder
YB0409



Hand Towel Bar
YB0486











18" Towel Bar
YB0418

24" Towel Bar
YB0424



ALIGN® Matching Bath Accessories**GRAB BARS** 



MODEL NUMBER	LIST EACH	DESCRIPTION	QTY
1½" • Chrome (CH)			
YG0412CH	123.55	12" Designer Grab Bar	6
YG0418CH	132.25	18" Designer Grab Bar	6
YG0424CH	138.10	24" Designer Grab Bar	6
YG0436CH	157.45	36" Designer Grab Bar	6
YG0442CH	189.00	42" Designer Grab Bar	6
1½" • Brushed Nickel (BN)			
YG0412BN	154.45	12" Designer Grab Bar	6
YG0418BN	165.30	18" Designer Grab Bar	6
YG0424BN	172.65	24" Designer Grab Bar	6
YG0436BN	196.80	36" Designer Grab Bar	6
YG0442BN	236.25	42" Designer Grab Bar	6
1½" • Brushed Gold (BG)			
YG0412BG	159.35	12" Designer Grab Bar	6 
YG0418BG	191.80	18" Designer Grab Bar	6
YG0424BG	200.25	24" Designer Grab Bar	6
YG0436BG	203.10	36" Designer Grab Bar	6 
YG0442BG	274.05	42" Designer Grab Bar	6 
1½" • Matte Black (BL)			
YG0412BL	155.65	12" Designer Grab Bar	6 
YG0418BL	166.65	18" Designer Grab Bar	6 
YG0424BL	174.00	24" Designer Grab Bar	6 
YG0436BL	198.35	36" Designer Grab Bar	6 
YG0442BL	245.70	42" Designer Grab Bar	6 



SECUREMOUNT™

- SecureMount™ Grab Bars are manufactured with an innovative flange design that makes it easy to connect to the stud at multiple points.
- Tested to withstand 500lbs.
- To install grab bars securely without studs, use SecureMount™ Anchors. Sold separately.

**18" Designer Grab Bar**

YG0418

ONE-HANDLE BATHROOM FAUCET		MODEL	LIST	FINISH/CONNECT	CASE QTY	
 <p>DECKPLATE SOLD SEPARATELY</p>	<ul style="list-style-type: none"> • application: one or three hole • supply lines: flexible • connection: 3/8" compression • deckplate: sold separately • drain assembly: metal with lift rod • red/blue markings: included 	<p>1.2 GPM (4.5L/min) max.</p>				
		6900	363.60	Chrome	3	
	<p> DURALAST®</p>	6900BL	516.90	Matte Black	3	
		OPTIONAL DECKPLATE SOLD SEPARATELY				
		165006	28.45	Chrome	20	
		165006BL	58.75	Matte Black	20	

TWO-HANDLE WIDESPREAD BATHROOM FAUCET TRIM		MODEL	LIST	FINISH/CONNECT	CASE QTY
	<ul style="list-style-type: none"> • application: three hole • center dimensions: 8" - 16" center • drain assembly: metal with lift rod • red/blue markings: included • valve: sold separately 	<p>1.2 GPM (4.5L/min) max.</p>			
		T6920	377.60	Chrome	3
<p> </p>		T6920BL	610.80	Matte Black	3

















WIDESPREAD FAUCET VALVE		MODEL	LIST	FINISH/CONNECT	CASE QTY
	<ul style="list-style-type: none"> • application: three hole • center dimensions: 8" - 16" center • drain assembly: metal with lift rod 	9000◆	165.40	1/2" IPS	6
		<p> DURALOCK® DURALAST®</p>			













HOW TO ORDER
VALVES: PAGE 469

 TRIM PART #
 +
  VALVE PART #
 =
  COMPLETE FAUCET



















RIZON® Collection











		MODEL	LIST	FINISH/CONNECT	CASE QTY
TWO-HANDLE ROMAN TUB TRIM					
 <ul style="list-style-type: none"> • application: three hole • spout reach: 7.75" • valve: sold separately 		T935	534.35	Chrome	3
		T935BL	821.25	Matte Black	3
TWO-HANDLE ROMAN TUB TRIM WITH HANDSHOWER					
 <ul style="list-style-type: none"> • application: four hole • showerhead type: handshower • handshower flow rate: 1.75 gpm (6.65 L/min) max. • spray functions: one-function • spout reach: 7.75" • valve: sold separately 		T936	832.15	Chrome	3
TWO-HANDLE ROMAN TUB VALVE					
 <ul style="list-style-type: none"> • deck thickness: 1/8" to 3-3/8" rough-in deck • adjustable spout shank: adjustable center dimensions 		4792	192.30	1/2" CC	6
 <ul style="list-style-type: none"> • deck thickness: 1/8" to 2-3/4" rough-in deck • adjustable spout shank: 10" - 24" center dimensions 		4793	217.80	1/2" CPVC, Crimp Ring PEX	6
		4794	207.65	1/2" Crimp Ring PEX, Cold Exp. PEX	6
 <ul style="list-style-type: none"> • deck thickness: 1/8" to 3-3/16" rough-in deck • Non-adjustable spout shank: 10" center dimensions 		4796	181.20	1/2" CC	6
		4797	184.70	1/2" CPVC, Crimp Ring PEX	6
		4798	184.70	1/2" Crimp Ring PEX, Cold Exp. PEX	6
TWO-HANDLE ROMAN TUB VALVE WITH HANDSHOWER					
 <ul style="list-style-type: none"> • deck thickness: 1/8" to 2-5/8" rough-in deck • non-adj spout shank: adjustable center dim's 		9792	433.35	1/2" CC	6
 <ul style="list-style-type: none"> • deck thickness: 1/8" to 2-5/8" rough-in deck • adj spout shank: 10" - 24" center dimensions 		9793	443.50	1/2" CPVC, Crimp Ring PEX	6
For more product details, reference page 470 in valve section.					
HOW TO ORDER VALVES: PAGE 470		 TRIM PART # +  VALVE PART # =  COMPLETE FAUCET			

		MODEL	LIST	FINISH/CONNECT	CASE QTY	
M-CORE® 4-SERIES TUB/SHOWER TRIM						
	<ul style="list-style-type: none"> • showerhead type: eco-performance rainshower • showerhead size: 6-3/4" diameter • tub spout length: 7" • tub spout connection type: slip fit • tub spout type: diverter • includes: thermostatic cartridge with volume and temperature control • valve: sold separately 	1.75 GPM (6.65 L/min) max.				
		UT4813EP	656.20	Chrome	4	
		UT4813EPBL	1072.75	Matte Black	4	
						
M-CORE® 4-SERIES SHOWER ONLY TRIM						
	<ul style="list-style-type: none"> • showerhead type: eco-performance rainshower • showerhead size: 6-3/4" diameter • includes: thermostatic cartridge with volume and temperature control • valve: sold separately 	1.75 GPM (6.65 L/min) max.				
		UT4812EP	560.15	Chrome	4	
		UT4812EPBL	903.25	Matte Black	4	
						
M-CORE® 4-SERIES VALVE ONLY TRIM						
	<ul style="list-style-type: none"> • includes: thermostatic cartridge with volume and temperature control • valve: sold separately 	UT4811	492.70	Chrome	3	
		UT4811BL	763.45	Matte Black	3	
						
M-CORE® MIXING SHOWER VALVE						
	<ul style="list-style-type: none"> • tub/shower or shower only application • ports: four with adj. temp. limit stops • included: test plug and cross flow plug 	U140CI	72.60	1/2" CC/IPS	6	
		U140X	72.60	1/2" Crimp Ring PEX + CC/IPS Tub	6	
		U140CX	72.60	1/2" Cold Exp. PEX + CC/IPS Tub	6	
		U140V	88.95	1/2" CPVC + CC/IPS Tub	6	
	<ul style="list-style-type: none"> • tub/shower or shower only application • ports: four with adj. temp. limit stops • quarter turn stops: included 	U140CIS	104.50	1/2" CC/IPS	6	
		U140XS	104.50	1/2" Crimp Ring PEX + CC/IPS Tub	6	
		U140CXS	104.50	1/2" Cold Exp. PEX + CC/IPS Tub	6	
		U140VS	120.85	1/2" CPVC + CC/IPS Tub	6	
	<ul style="list-style-type: none"> • shower only application • ports: three 	U130CI	72.60	1/2" CC/IPS	6	
		U130X	72.60	1/2" Crimp Ring PEX	6	
		U130CX	72.60	1/2" Cold Exp. PEX	6	
	<ul style="list-style-type: none"> • shower only application • ports: three • quarter turn stops: included 	U130CIS	104.50	1/2" CC/IPS	6	
		U130XS	104.50	1/2" Crimp Ring PEX	6	
		U130CXS	104.50	1/2" Cold Exp. PEX	6	
<p>Four port valves can be used with either Tub/Shower or Shower Only applications. Three port valves can ONLY be used with Shower Only applications. For more product details, reference page 471 in valve section.</p>						
HOW TO ORDER VALVES: PAGE 471		 TRIM PART #	+	 VALVE PART #	=	 COMPLETE FAUCET



































RIZON® Collection















		MODEL	LIST	FINISH/CONNECT	CASE QTY	
M-CORE® 3-SERIES TUB/SHOWER TRIM						
 <ul style="list-style-type: none"> • showerhead type: eco-performance rainshower • showerhead size: 6-3/4" diameter • tub spout length: 7" • tub spout connection type: slip fit • tub spout type: diverter • includes: pressure balanced cartridge with volume and temperature control • valve: sold separately 			1.75 GPM (6.65 L/min) max.			
		UT3813EP	518.50	Chrome	4	
		UT3813EPBL	935.05	Matte Black	4	
M-CORE® 3-SERIES SHOWER ONLY TRIM						
 <ul style="list-style-type: none"> • showerhead type: eco-performance rainshower • showerhead size: 6-3/4" diameter • includes: pressure balanced cartridge with volume and temperature control • valve: sold separately 			1.75 GPM (6.65 L/min) max.			
		UT3812EP	422.45	Chrome	4	
		UT3812EPBL	765.55	Matte Black	4	
M-CORE® 3-SERIES VALVE ONLY TRIM						
 <ul style="list-style-type: none"> • includes: pressure balanced cartridge with volume and temperature control • valve: sold separately 		UT3811	355.00	Chrome	3	
		UT3811BL	625.75	Matte Black	3	
M-CORE® MIXING SHOWER VALVE						
 <ul style="list-style-type: none"> • tub/shower or shower only application • ports: four with adj. temp. limit stops • included: test plug and cross flow plug 		U140CI	72.60	1/2" CC/IPS	6	
		U140X	72.60	1/2" Crimp Ring PEX + CC/IPS Tub	6	
		U140CX	72.60	1/2" Cold Exp. PEX + CC/IPS Tub	6	
		U140V	88.95	1/2" CPVC + CC/IPS Tub	6	
 <ul style="list-style-type: none"> • tub/shower or shower only application • ports: four with adj. temp. limit stops • quarter turn stops: included 		U140CIS	104.50	1/2" CC/IPS	6	
		U140XS	104.50	1/2" Crimp Ring PEX + CC/IPS Tub	6	
		U140CXS	104.50	1/2" Cold Exp. PEX + CC/IPS Tub	6	
		U140VS	120.85	1/2" CPVC + CC/IPS Tub	6	
 <ul style="list-style-type: none"> • shower only application • ports: three 		U130CI	72.60	1/2" CC/IPS	6	
		U130X	72.60	1/2" Crimp Ring PEX	6	
		U130CX	72.60	1/2" Cold Exp. PEX	6	
 <ul style="list-style-type: none"> • shower only application • ports: three • quarter turn stops: included 		U130CIS	104.50	1/2" CC/IPS	6	
		U130XS	104.50	1/2" Crimp Ring PEX	6	
		U130CXS	104.50	1/2" Cold Exp. PEX	6	
<p>Four port valves can be used with either Tub/Shower or Shower Only applications. Three port valves can ONLY be used with Shower Only applications. For more product details, reference page 471 in valve section.</p>						
<p>HOW TO ORDER VALVES: PAGE 471</p>		 <p>TRIM PART #</p>	+	 <p>VALVE PART #</p>	=	 <p>COMPLETE FAUCET</p>

		MODEL	LIST	FINISH/CONNECT	CASE QTY			
M-CORE® TRANSFER VALVE TRIM								
 <ul style="list-style-type: none"> • use with the M-CORE® transfer valve • valve: sold separately  		UT2081	232.25	Chrome	12			
		UT2081BL	306.85	Matte Black	12			
M-CORE® TRANSFER VALVE								
Three Function (2 independent/1 shared) OR Six Function (3 independent/3 shared) - plumbing configuration page 478								
 <ul style="list-style-type: none"> • number of functions: three or six • ports: four 		U361CI	152.70	1/2" CC/IPS	6			
		U361CX	152.70	1/2" Cold Exp. PEX	6			
		U361X	152.70	1/2" Crimp Ring PEX	6			
Two Independent Functions OR Three Independent Functions - plumbing configurations page 478								
 <ul style="list-style-type: none"> • number of functions: two or three • ports: four 		U231CI	152.70	1/2" CC/IPS	6			
		U231CX	152.70	1/2" Cold Exp. PEX	6			
		U231X	152.70	1/2" Crimp Ring PEX	6			
For more product details, reference page 472 in valve section. See page 478 for plumbing configurations.								
HOW TO ORDER VALVES: PAGE 472		TRIM PART #	+		VALVE PART #	=		COMPLETE FAUCET























RIZON® Collection

















		MODEL	LIST	FINISH/CONNECT	CASE QTY				
M-CORE® 2-SERIES TUB/SHOWER TRIM									
  	<ul style="list-style-type: none"> • showerhead: single-function eco-performance • showerhead size: 3.75" diameter • tub spout length: 7" • tub spout connection type: slip fit • tub spout type: diverter • red/blue markings: included • includes: pressure balanced cartridge with temperature control • valve: sold separately  	 1.75 GPM (6.65 L/min) max. UT2813EP	417.30	Chrome	12				
		UT2813EPBL	705.60	Matte Black	12				
  	<ul style="list-style-type: none"> • showerhead type: showerhead sold separately • tub spout length: 7" • tub spout connection type: slip fit • tub spout type: diverter • red/blue markings: included • includes: pressure balanced cartridge with temperature control • valve: sold separately  	UT2813NH	323.10	Chrome	3				
		UT2813NHBL	546.70	Matte Black	3				
M-CORE® 2-SERIES SHOWER ONLY TRIM									
  	<ul style="list-style-type: none"> • showerhead: single-function eco-performance • showerhead size: 3.75" diameter • red/blue markings: included • includes: pressure balanced cartridge with temperature control • valve: sold separately  	 1.75 GPM (6.65 L/min) max. UT2812EP	355.45	Chrome	12				
		UT2812EPBL	582.50	Matte Black	12				
  	<ul style="list-style-type: none"> • showerhead type: showerhead sold separately • red/blue markings: included • includes: pressure balanced cartridge with temperature control • valve: sold separately  	UT2812NH	309.05	Chrome	3				
		UT2812NHBL	489.25	Matte Black	3				
M-CORE® MIXING SHOWER VALVE									
	<ul style="list-style-type: none"> • tub/shower or shower only application • ports: four with adj. temp. limit stops • included: test plug and cross flow plug 	U140CI	72.60	1/2" CC/IPS	6				
		U140X	72.60	1/2" Crimp Ring PEX + CC/IPS Tub	6				
		U140CX	72.60	1/2" Cold Exp. PEX + CC/IPS Tub	6				
		U140V	88.95	1/2" CPVC + CC/IPS Tub	6				
	<ul style="list-style-type: none"> • tub/shower or shower only application • ports: four with adj. temp. limit stops • quarter turn stops: included 	U140CIS	104.50	1/2" CC/IPS	6				
		U140XS	104.50	1/2" Crimp Ring PEX + CC/IPS Tub	6				
		U140CXS	104.50	1/2" Cold Exp. PEX + CC/IPS Tub	6				
		U140VS	120.85	1/2" CPVC + CC/IPS Tub	6				
	<ul style="list-style-type: none"> • shower only application • ports: three 	U130CI	72.60	1/2" CC/IPS	6				
		U130X	72.60	1/2" Crimp Ring PEX	6				
		U130CX	72.60	1/2" Cold Exp. PEX	6				
	<ul style="list-style-type: none"> • shower only application • ports: three • quarter turn stops: included 	U130CIS	104.50	1/2" CC/IPS	6				
		U130XS	104.50	1/2" Crimp Ring PEX	6				
		U130CXS	104.50	1/2" Cold Exp. PEX	6				
<p>Four port valves can be used with either Tub/Shower or Shower Only applications. Three port valves can ONLY be used with Shower Only applications. For more product details, reference page 471 in valve section.</p>									
<p>HOW TO ORDER VALVES: PAGE 471</p>			<p>TRIM PART #</p>	+		<p>VALVE PART #</p>	=		<p>COMPLETE FAUCET</p>

		MODEL	LIST	FINISH/CONNECT	CASE QTY	
M-CORE® 2-SERIES VALVE ONLY TRIM						
 <ul style="list-style-type: none"> • red/blue markings: included • includes: pressure balanced cartridge with temperature control • valve: sold separately  		UT2811	298.90	Chrome	3	
		UT2811BL	468.70	Matte Black	3	
M-CORE® MIXING SHOWER VALVE						
 <ul style="list-style-type: none"> • tub/shower or shower only application • ports: four with adj. temp. limit stops • included: test plug and cross flow plug 		U140CI	72.60	1/2" CC/IPS	6	
		U140X	72.60	1/2" Crimp Ring PEX + CC/IPS Tub	6	
		U140CX	72.60	1/2" Cold Exp. PEX + CC/IPS Tub	6	
		U140V	88.95	1/2" CPVC + CC/IPS Tub	6	
 <ul style="list-style-type: none"> • tub/shower or shower only application • ports: four with adj. temp. limit stops • quarter turn stops: included 		U140CIS	104.50	1/2" CC/IPS	6	
		U140XS	104.50	1/2" Crimp Ring PEX + CC/IPS Tub	6	
		U140CXS	104.50	1/2" Cold Exp. PEX + CC/IPS Tub	6	
		U140VS	120.85	1/2" CPVC + CC/IPS Tub	6	
 <ul style="list-style-type: none"> • shower only application • ports: three 		U130CI	72.60	1/2" CC/IPS	6	
		U130X	72.60	1/2" Crimp Ring PEX	6	
		U130CX	72.60	1/2" Cold Exp. PEX	6	
 <ul style="list-style-type: none"> • shower only application • ports: three • quarter turn stops: included 		U130CIS	104.50	1/2" CC/IPS	6	
		U130XS	104.50	1/2" Crimp Ring PEX	6	
		U130CXS	104.50	1/2" Cold Exp. PEX	6	
<p>Four port valves can be used with either Tub/Shower or Shower Only applications. Three port valves can ONLY be used with Shower Only applications. For more product details, reference page 471 in valve section.</p>						
<p>HOW TO ORDER VALVES: PAGE 471</p>		 <p>TRIM PART #</p>	+	 <p>VALVE PART #</p>	=	 <p>COMPLETE FAUCET</p>



		MODEL	LIST	FINISH/CONNECT	CASE QTY	
POSI-TEMP® TUB/SHOWER TRIM						
 <ul style="list-style-type: none"> • showerhead: single-function standard • showerhead size: 3.75" diameter • tub spout length: 7" • tub spout connection type: slip fit • tub spout type: diverter • red/blue markings: included • valve: sold separately 		2.5 GPM (9.5 L/min) max.				
		T2813	288.70	Chrome	3	
		T2813BL	576.90	Matte Black	3	
		1.75 GPM (6.65 L/min) max.				
		T2813EP	288.70	Chrome	3	
		T2813EPBL	576.90	Matte Black	3	
 <ul style="list-style-type: none"> • showerhead type: showerhead sold separately • tub spout length: 7" • tub spout connection type: slip fit • tub spout type: diverter • red/blue markings: included • valve: sold separately 		T2813NH	194.40	Chrome	3	
		T2813NHBL	418.10	Matte Black	3	
POSI-TEMP® SHOWER ONLY TRIM						
 <ul style="list-style-type: none"> • showerhead: single-function standard • showerhead size: 3.75" diameter • red/blue markings: included • valve: sold separately 		2.5 GPM (9.5 L/min) max.				
		T2812	226.85	Chrome	3	
		T2812BL	453.90	Matte Black	3	
		1.75 GPM (6.65 L/min) max.				
	T2812EP	226.85	Chrome	3		
	T2812EPBL	453.90	Matte Black	3		
 <ul style="list-style-type: none"> • showerhead type: showerhead sold separately • red/blue markings: included • valve: sold separately 		T2812NH	180.50	Chrome	3	
		T2812NHBL	360.55	Matte Black	3	
POSI-TEMP® VALVE ONLY TRIM						
 <ul style="list-style-type: none"> • red/blue markings: included • valve: sold separately 		T2811	170.25	Chrome	3	
		T2811BL	340.00	Matte Black	3	
POSI-TEMP® SHOWER MIXING VALVES						
 <ul style="list-style-type: none"> • tub/shower or shower only application • ports: four with adjustable temp. limit stops • test plug: included 		2520 ◆	159.20	1/2" CC	6	
		2510 ◆	159.20	1/2" IPS	6	
 <ul style="list-style-type: none"> • tub/shower or shower only application • ports: four with adjustable temp. limit stops • quarter turn stops: included • test plug: included 		2570 ◆	193.35	1/2" CC	6	
		2590 ◆	193.35	1/2" IPS	6	
		2580 ◆	159.20	1/2" Crimp ring PEX	6	
 <ul style="list-style-type: none"> • tub/shower only application • ports: four with adjustable temp. limit stops • quarter turn stops: included • test plug: included 		2360PF	212.60	1/2" Crimp Ring PEX	3	
 <ul style="list-style-type: none"> • shower only application • ports: three with adjustable temp. limit stops • quarter turn stops: included • test plug: included 		2326PF	205.20	1/2" Crimp Ring PEX	6	
		2328PF	205.20	1/2" Cold Exp. PEX	6	
<p>Four port valves can be used with either Tub/Shower or Shower Only applications. Three port valves can ONLY be used with Shower Only applications. For more product details, reference page 473-476 in valve section.</p>						
<p>HOW TO ORDER VALVES: PAGES 473-476</p>		 TRIM PART #	+	 VALVE PART #	=	 COMPLETE FAUCET

RIZON®

		MODEL	LIST	FINISH/CONNECT	CASE QTY
POSI-TEMP® WITH INTEGRATED TRANSFER VALVE TRIM					
 <ul style="list-style-type: none"> • red/blue markings: included • valve: sold separately  		T2810	307.35	Chrome	4
		T2810BL	613.95	Matte Black	4
POSI-TEMP® WITH INTEGRATED TRANSFER VALVE					
 <ul style="list-style-type: none"> • functions: three (two independent and one shared) • ports: four with adjustable temp. limit stops • test plug: included 		2551	287.50	½" IPS	6
 <ul style="list-style-type: none"> • functions: three (two independent and one shared) • ports: four with adjustable temp. limit stops • stops: included • test plug: included 		2581	323.75	½" IPS	6
 <ul style="list-style-type: none"> • functions: two independent • ports: four with adjustable temp. limit stops • test plug: included 		2521	287.50	½" IPS	6
 <ul style="list-style-type: none"> • functions: two independent • ports: four with adjustable temp. limit stops • stops: included • test plug: included 		2571	323.75	½" IPS	6
For more product details, reference page 477 in valve section.					
HOW TO ORDER VALVES: PAGE 477		 TRIM PART #   VALVE PART #   COMPLETE FAUCET			



GENTA™ LX Coordinating Bath Accessories

Moen® bath accessories CANNOT be combined with Moen faucet parts on a Purchase Order.

COORDINATING ACCESSORIES

Complimentary styles for a cohesive look. From robe hooks to towel bars, paper holders to knobs and pulls, Moen offers a variety of coordinating accessories to complete any room.

MODEL NUMBER	LIST EACH	DESCRIPTION	QTY
--------------	-----------	-------------	-----

Chrome (CH)

BH3803CH	29.75	Single Robe Hook	12 ▲
Ⓟ BH3808CH	51.10	Pivoting Paper Holder	3 ▲
BH3818CH	51.50	18" Towel Bar	3 ▲
BH3824CH	55.90	24" Towel Bar	3 ▲
BH3886CH	41.00	Hand Towel Bar	3 ▲

Matte Black (BL)

BH3803BL	36.05	Single Robe Hook	24
Ⓟ BH3808BL	61.85	Pivoting Paper Holder	6
BH3818BL	62.30	18" Towel Bar	6
BH3824BL	67.60	24" Towel Bar	6
BH3886BL	49.55	Hand Towel Bar	6

Ⓟ Denotes pivoting paper holder



Single Robe Hook
BH3803



Pivoting Paper Holder
BH3808 | Ⓟ



Hand Towel Bar
BH3886



18" Towel Bar
BH3818

24" Towel Bar
BH3824

GRAB BARS ♿

MODEL NUMBER	LIST EACH	DESCRIPTION	QTY
--------------	-----------	-------------	-----

1 1/4" • Chrome (CH)

MBHG3818CH	141.40	18" Designer Grab Bar	3 ▲
------------	--------	-----------------------	-----

SECUREMOUNT™

- SecureMount™ Grab Bars are manufactured with an innovative flange design that makes it easy to connect to the stud at multiple points.
- Tested to withstand 500lbs.
- To install grab bars securely without studs, use SecureMount™ Anchors. Sold separately.



18" Designer Grab Bar
MBHG3818



▲ Retail Packaging



- ♿ Complies with Americans with Disabilities Act (ADA) specifications. SecureMount™ Grab Bars are tested to withstand 500 lb. pull when securely installed per instructions.



List price is per each (unless otherwise noted).
Product can be ordered by case quantity or individually.



BELFIELD™ Collection

MODEL LIST FINISH/CONNECT CASE QTY

ONE-HANDLE BATHROOM FAUCET				
 <p>DECKPLATE INCLUDED</p> 	<ul style="list-style-type: none"> • application: one or three hole • supply lines: flexible • connection: 3/8" compression • deckplate: included • drain assembly: metal with lift rod 	<p>1.2 GPM (4.5L/min) max.</p>		
	6402	358.30	Chrome	3
	6402BN	465.75	Brushed Nickel	3
	6402BL	483.65	Matte Black	3
	6402NL	501.60	Polished Nickel	3
	6402ORB	501.60	Oil Rubbed Bronze	3
	<p> DURALAST®</p>			

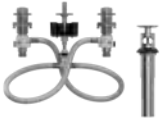

TWO-HANDLE CENTERSET BATHROOM FAUCET				
	<ul style="list-style-type: none"> • application: three hole • center dimensions: 4" center • connection: 1/2" IPS • drain assembly: metal with lift rod 	<p>1.2 GPM (4.5L/min) max.</p>		
	6401	371.65	Chrome	3
	6401BN	483.15	Brushed Nickel	3
	6401BL	501.70	Matte Black	3
	6401NL	520.30	Polished Nickel	3
	6401ORB	520.30	Oil Rubbed Bronze	3
	<p> DURALAST®</p>			





TWO-HANDLE WIDESPREAD BATHROOM FAUCET TRIM				
	<ul style="list-style-type: none"> • application: three hole • center dimensions: 8" - 16" center • drain assembly: metal with lift rod • valve: sold separately 	<p>1.2 GPM (4.5L/min) max.</p>		
	T6405	389.70	Chrome	3
	T6405BN	534.90	Brushed Nickel	3
	T6405BL	554.00	Matte Black	3
	T6405NL	554.00	Polished Nickel	3
	T6405ORB	573.10	Oil Rubbed Bronze	3
<p> </p>				

WIDESPREAD FAUCET VALVE					
	<ul style="list-style-type: none"> • application: three hole • center dimensions: 8" - 16" center • drain assembly: metal with lift rod 	9000◆	165.40	1/2" IPS	6
	<p> DURALOCK® DURALAST®</p>				

HOW TO ORDER
VALVES: PAGE 469

 TRIM PART # +  VALVE PART # =  COMPLETE FAUCET

FREESTANDING TUB FILLER TRIM				
	<ul style="list-style-type: none"> • application: one hole • showerhead type: handshower • handshower functions: one-function • handshower flow rate: 1.75 gpm (6.65 L/min) max. • spout reach: 9.75" • mounting kit: sold separately 	<p>1.75 GPM (6.65 L/min) max.</p>		
	9025	1912.45	Chrome	1
	9025BN	2581.80	Brushed Nickel	1
	9025NL	2581.80	Polished Nickel	1
	9025BL	2677.45	Matte Black	1
	9025ORB	2840.05	Oil Rubbed Bronze	1
<p> </p>				





FREESTANDING TUB FILLER VALVE AND MOUNTING KIT - PREMIUM					
	<ul style="list-style-type: none"> • description: single riser floor joist mounting kit • application: one hole • quarter turn stops: included 	TS50100	408.90	1/2" CC, NPT	2
		<ul style="list-style-type: none"> • description: single riser concrete mounting kit • application: one hole • connection size: 1/2" 	TS50110	332.45	1/2" CC, NPT
<p> </p>					











HOW TO ORDER
VALVES: PAGE 469

 TRIM PART # +  VALVE PART # =  COMPLETE FAUCET











BELFIELD™ Collection









		MODEL	LIST	FINISH/CONNECT	CASE QTY
ONE-HANDLE WALLMOUNT TUB FILLER TRIM					
 <ul style="list-style-type: none"> • application: two hole • connection: 1/2" slip fit • tub spout type: non diverter • spout reach: 10.00" • includes: high flow volume control cartridge • WMV130 series valve kit: sold separately 		WT9021	642.60	Chrome	3
		WT9021BN	893.20	Brushed Nickel	3
		WT9021NL	893.20	Polished Nickel	3
		WT9021BL	932.60	Matte Black	3
		WT9021ORB	982.55	Oil Rubbed Bronze	3
ONE-HANDLE WALLMOUNT TUB FILLER VALVE KIT					
 <ul style="list-style-type: none"> • application: two hole with adj. center dimensions • ports: three • quarter turn stops: included • includes: test plug • includes: spout manifold 		WMV130CIS	154.05	1/2" CC/IPS	6
		WMV130XS	154.05	1/2" Crimp Ring PEX	6
		WMV130CXS	154.05	1/2" Cold Exp. PEX	6
<p>HOW TO ORDER VALVES: PAGE 469</p>  TRIM PART # +  VALVE PART # =  COMPLETE FAUCET					

TWO-HANDLE ROMAN TUB TRIM					
 <ul style="list-style-type: none"> • application: three hole • spout reach: 7.50" • valve: sold separately 		T9023	481.30	Chrome	3
		T9023BN	676.35	Brushed Nickel	3
		T9023NL	676.35	Polished Nickel	3
		T9023BL	697.90	Matte Black	3
		T9023ORB	734.45	Oil Rubbed Bronze	3
1.75 GPM (6.65 L/min) max.					
 <ul style="list-style-type: none"> • application: four hole • showerhead type: handshower • handshower flow rate: 1.75 gpm (6.65 L/min) max. • spray functions: one-function • spout reach: 7.50" • valve: sold separately 		T9024	654.15	Chrome	3
		T9024BN	921.10	Brushed Nickel	3
		T9024NL	921.10	Polished Nickel	3
		T9024BL	948.45	Matte Black	3
		T9024ORB	987.85	Oil Rubbed Bronze	3
TWO-HANDLE ROMAN TUB VALVE					
 <ul style="list-style-type: none"> • deck thickness: 1/8" to 3-3/8" rough-in deck • adjustable spout shank: adjustable center dimensions 		4792	192.30	1/2" CC	6
		DURALAST®			
 <ul style="list-style-type: none"> • deck thickness: 1/8" to 2-3/4" rough-in deck • adjustable spout shank: 10" - 24" center dimensions 		4793	217.80	1/2" CPVC, Crimp Ring PEX	6
		4794	207.65	1/2" Crimp Ring PEX, Cold Exp. PEX	6
	DURALOCK® DURALAST®				
 <ul style="list-style-type: none"> • deck thickness: 1/8" to 3-3/16" rough-in deck • Non-adjustable spout shank: 10" center dimensions 		4796	181.20	1/2" CC	6
		4797	184.70	1/2" CPVC, Crimp Ring PEX	6
		4798	184.70	1/2" Crimp Ring PEX, Cold Exp. PEX	6
	DURALAST®				
TWO-HANDLE ROMAN TUB VALVE WITH HANDSHOWER					
 <ul style="list-style-type: none"> • deck thickness: 1/8" to 2-5/8" rough-in deck • non-adj spout shank: adjustable center dim's 		9792	433.35	1/2" CC	6
		DURALAST®			
 <ul style="list-style-type: none"> • deck thickness: 1/8" to 2-5/8" rough-in deck • adj spout shank: 10" - 24" center dimensions 		9793	443.50	1/2" CPVC, Crimp Ring PEX	6
		DURALOCK® DURALAST®			
For more product details, reference page 470 in valve section.					
<p>HOW TO ORDER VALVES: PAGE 470</p>  TRIM PART # +  VALVE PART # =  COMPLETE FAUCET					

















BELFIELD™

BELFIELD™ Collection















		MODEL	LIST	FINISH/CONNECT	CASE QTY	
EXACTTEMP® VALVE ONLY TRIM						
 <ul style="list-style-type: none"> • description: temperature control valve trim • requires: separate volume control valve • valve: sold separately  		T4411	310.40	Chrome	3	
		T4411BN	467.55	Brushed Nickel	3	
		T4411NL	467.55	Polished Nickel	3	
		T4411BL	481.10	Matte Black	3	
		T4411ORB	504.40	Oil Rubbed Bronze	3	
EXACTTEMP® THERMOSTATIC MIXING SHOWER VALVE - PREMIUM						
 <ul style="list-style-type: none"> • description: thermostatic rough-in valve • ports: four with adjustable temp. limit stops • check stops: included 		S3371	728.95	¾" IPS	6	
HOW TO ORDER VALVES: PAGE 471		 TRIM PART #	+	 VALVE PART #	=	 COMPLETE FAUCET

EXACTTEMP® VOLUME CONTROL VALVE TRIM						
 <ul style="list-style-type: none"> • valve: sold separately  		T4412	157.60	Chrome	6	
		T4412BN	237.55	Brushed Nickel	6	
		T4412NL	237.55	Polished Nickel	6	
		T4412BL	244.25	Matte Black	6	
		T4412ORB	256.15	Oil Rubbed Bronze	6	
EXACTTEMP® VOLUME CONTROL SHOWER VALVE - PREMIUM						
 <ul style="list-style-type: none"> • includes: volume control 		S3600	185.35	¾" IPS	12	
HOW TO ORDER VALVES: PAGE 471		 TRIM PART #	+	 VALVE PART #	=	 COMPLETE FAUCET

BELFIELD™ Collection









		MODEL	LIST	FINISH/CONNECT	CASE QTY	
M-CORE® 4-SERIES TUB/SHOWER TRIM						
 <ul style="list-style-type: none"> • showerhead: single-function eco-performance rainshower • showerhead size: 7" diameter • tub spout length: 7 3/4" • tub spout connection type: slip fit • tub spout type: diverter • includes: thermostatic cartridge with volume and temperature control • valve: sold separately 		1.75 GPM (6.65 L/min) max.				
		UT4313EP	628.65	Chrome	4	
		UT4313EPBN	966.45	Brushed Nickel	4	
		UT4313EPNL	966.45	Polished Nickel	4	
		UT4313EPBL	996.80	Matte Black	4	
		UT4313EPORB	1076.15	Oil Rubbed Bronze	4	
M-CORE® 4-SERIES SHOWER ONLY TRIM						
 <ul style="list-style-type: none"> • showerhead: single-function eco-performance rainshower • showerhead size: 7" diameter • includes: thermostatic cartridge with volume and temperature control • valve: sold separately 		1.75 GPM (6.65 L/min) max.				
		UT4312EP	535.35	Chrome	4	
		UT4312EPBN	794.70	Brushed Nickel	4	
		UT4312EPNL	794.70	Polished Nickel	4	
		UT4312EPBL	813.70	Matte Black	4	
		UT4312EPORB	883.25	Oil Rubbed Bronze	4	
M-CORE® 4-SERIES VALVE ONLY TRIM						
 <ul style="list-style-type: none"> • includes: thermostatic cartridge with volume and temperature control • valve: sold separately 						
		UT4311	464.85	Chrome	3	
		UT4311BN	696.45	Brushed Nickel	3	
		UT4311NL	696.45	Polished Nickel	3	
		UT4311BL	709.15	Matte Black	3	
		UT4311ORB	736.90	Oil Rubbed Bronze	3	
M-CORE® MIXING SHOWER VALVE						
 <ul style="list-style-type: none"> • tub/shower or shower only application • ports: four with adj. temp. limit stops • included: test plug and cross flow plug 						
		U140CI	72.60	1/2" CC/IPS	6	
		U140X	72.60	1/2" Crimp Ring PEX + CC/IPS Tub	6	
		U140CX	72.60	1/2" Cold Exp. PEX + CC/IPS Tub	6	
		U140V	88.95	1/2" CPVC + CC/IPS Tub	6	
 <ul style="list-style-type: none"> • tub/shower or shower only application • ports: four with adj. temp. limit stops • quarter turn stops: included 						
		U140CIS	104.50	1/2" CC/IPS	6	
		U140XS	104.50	1/2" Crimp Ring PEX + CC/IPS Tub	6	
		U140CXXS	104.50	1/2" Cold Exp. PEX + CC/IPS Tub	6	
		U140VS	120.85	1/2" CPVC + CC/IPS Tub	6	
 <ul style="list-style-type: none"> • shower only application • ports: three 						
		U130CI	72.60	1/2" CC/IPS	6	
		U130X	72.60	1/2" Crimp Ring PEX	6	
 <ul style="list-style-type: none"> • shower only application • ports: three • quarter turn stops: included 						
		U130CIS	104.50	1/2" CC/IPS	6	
		U130XS	104.50	1/2" Crimp Ring PEX	6	
	U130CXXS	104.50	1/2" Cold Exp. PEX	6		
<p>Four port valves can be used with either Tub/Shower or Shower Only applications. Three port valves can ONLY be used with Shower Only applications. For more product details, reference page 471 in valve section.</p>						
<p>HOW TO ORDER VALVES: PAGE 471</p>		 <p>TRIM PART #</p>	+	 <p>VALVE PART #</p>	=	 <p>COMPLETE FAUCET</p>











MODEL LIST FINISH/CONNECT CASE QTY











M-CORE® 3-SERIES TUB/SHOWER TRIM					
 <ul style="list-style-type: none"> • showerhead: single-function rainshower • showerhead size: 7" diameter • tub spout length: 7 3/4" • tub spout connection type: slip fit • tub spout type: diverter • includes: pressure balanced cartridge with volume and temperature control • valve: sold separately 	2.5 GPM (9.5 L/min) max.				
	UT3313	490.95	Chrome	4	
	UT3313BN	828.75	Brushed Nickel	4	
	UT3313NL	828.75	Polished Nickel	4	
	UT3313BL	840.75	Matte Black	4	
	UT3313ORB	938.45	Oil Rubbed Bronze	4	
	1.75 GPM (6.65 L/min) max.				
	UT3313EP	490.95	Chrome	4	
	UT3313EPBN	828.75	Brushed Nickel	4	
	UT3313EPNL	828.75	Polished Nickel	4	
UT3313EPBL	840.75	Matte Black	4		
UT3313EPORB	938.45	Oil Rubbed Bronze	4		
M-CORE® 3-SERIES SHOWER ONLY TRIM					
 <ul style="list-style-type: none"> • showerhead: single-function rainshower • showerhead size: 7" diameter • includes: pressure balanced cartridge with volume and temperature control • valve: sold separately 	2.5 GPM (9.5 L/min) max.				
	UT3312	397.65	Chrome	4	
	UT3312BN	657.00	Brushed Nickel	4	
	UT3312NL	657.00	Polished Nickel	4	
	UT3312BL	676.00	Matte Black	4	
	UT3312ORB	745.55	Oil Rubbed Bronze	4	
	1.75 GPM (6.65 L/min) max.				
	UT3312EP	397.65	Chrome	4	
	UT3312EPBN	657.00	Brushed Nickel	4	
	UT3312EPNL	657.00	Polished Nickel	4	
UT3312EPBL	676.00	Matte Black	4		
UT3312EPORB	745.55	Oil Rubbed Bronze	4		
M-CORE® MIXING SHOWER VALVE					
 <ul style="list-style-type: none"> • tub/shower or shower only application • ports: four with adj. temp. limit stops • included: test plug and cross flow plug 	U140CI	72.60	1/2" CC/IPS	6	
	U140X	72.60	1/2" Crimp Ring PEX + CC/IPS Tub	6	
	U140CX	72.60	1/2" Cold Exp. PEX + CC/IPS Tub	6	
	U140V	88.95	1/2" CPVC + CC/IPS Tub	6	
	 <ul style="list-style-type: none"> • tub/shower or shower only application • ports: four with adj. temp. limit stops • quarter turn stops: included 	U140CIS	104.50	1/2" CC/IPS	6
U140XS		104.50	1/2" Crimp Ring PEX + CC/IPS Tub	6	
U140CXS		104.50	1/2" Cold Exp. PEX + CC/IPS Tub	6	
U140VS		120.85	1/2" CPVC + CC/IPS Tub	6	
 <ul style="list-style-type: none"> • shower only application • ports: three 		U130CI	72.60	1/2" CC/IPS	6
	U130X	72.60	1/2" Crimp Ring PEX	6	
	U130CX	72.60	1/2" Cold Exp. PEX	6	
 <ul style="list-style-type: none"> • shower only application • ports: three • quarter turn stops: included 	U130CIS	104.50	1/2" CC/IPS	6	
	U130XS	104.50	1/2" Crimp Ring PEX	6	
	U130CXS	104.50	1/2" Cold Exp. PEX	6	
Four port valves can be used with either Tub/Shower or Shower Only applications. Three port valves can ONLY be used with Shower Only applications. For more product details, reference page 471 in valve section.					
HOW TO ORDER VALVES: PAGE 471	 TRIM PART #	+	 VALVE PART #	=	 COMPLETE FAUCET



BELFIELD™ Collection

















		MODEL	LIST	FINISH/CONNECT	CASE QTY	
M-CORE® 3-SERIES VALVE ONLY TRIM						
 <ul style="list-style-type: none"> • includes: pressure balanced cartridge with volume and temperature control • valve: sold separately 		UT3311	327.15	Chrome	3	
		UT3311BN	558.75	Brushed Nickel	3	
		UT3311NL	558.75	Polished Nickel	3	
		UT3311BL	572.50	Matte Black	3	
		UT3311ORB	599.20	Oil Rubbed Bronze	3	
M-CORE® MIXING SHOWER VALVE						
 <ul style="list-style-type: none"> • tub/shower or shower only application • ports: four with adj. temp. limit stops • included: test plug and cross flow plug 		U140CI	72.60	1/2" CC/IPS	6	
		U140X	72.60	1/2" Crimp Ring PEX + CC/IPS Tub	6	
		U140CX	72.60	1/2" Cold Exp. PEX + CC/IPS Tub	6	
		U140V	88.95	1/2" CPVC + CC/IPS Tub	6	
 <ul style="list-style-type: none"> • tub/shower or shower only application • ports: four with adj. temp. limit stops • quarter turn stops: included 		U140CIS	104.50	1/2" CC/IPS	6	
		U140XS	104.50	1/2" Crimp Ring PEX + CC/IPS Tub	6	
		U140CXS	104.50	1/2" Cold Exp. PEX + CC/IPS Tub	6	
		U140VS	120.85	1/2" CPVC + CC/IPS Tub	6	
 <ul style="list-style-type: none"> • shower only application • ports: three 		U130CI	72.60	1/2" CC/IPS	6	
		U130X	72.60	1/2" Crimp Ring PEX	6	
		U130CX	72.60	1/2" Cold Exp. PEX	6	
 <ul style="list-style-type: none"> • shower only application • ports: three • quarter turn stops: included 		U130CIS	104.50	1/2" CC/IPS	6	
		U130XS	104.50	1/2" Crimp Ring PEX	6	
		U130CXS	104.50	1/2" Cold Exp. PEX	6	
<p>Four port valves can be used with either Tub/Shower or Shower Only applications. Three port valves can ONLY be used with Shower Only applications. For more product details, reference page 471 in valve section.</p>						
<p>HOW TO ORDER VALVES: PAGE 471</p>		 <p>TRIM PART #</p>	+	 <p>VALVE PART #</p>	=	 <p>COMPLETE FAUCET</p>

		MODEL	LIST	FINISH/CONNECT	CASE QTY		
M-CORE® 3-SERIES WITH INTEGRATED TRANSFER VALVE TRIM							
 <ul style="list-style-type: none"> • includes: pressure balanced cartridge with volume and temperature control • valve: sold separately  		UT3322	335.50	Chrome	4		
		UT3322BN	415.90	Brushed Nickel	4		
		UT3322NL	415.90	Polished Nickel	4		
		UT3322BL	436.10	Matte Black	4		
		UT3322ORB	447.40	Oil Rubbed Bronze	4		
M-CORE® WITH INTEGRATED TRANSFER VALVE							
Three Function (2 independent/1 shared) OR Six Function (3 independent/3 shared) - plumbing configuration page 478							
 <ul style="list-style-type: none"> • ports: four with adj. temp. limit stops • check stops: included 		U362CIS	270.70	1/2" CC/IPS	6		
		U362CXS	270.70	1/2" Cold Exp. PEX	6		
		U362XS	270.70	1/2" Crimp Ring PEX	6		
Two Independent Functions OR Three Independent Functions - plumbing configurations page 478							
 <ul style="list-style-type: none"> • ports: four with adj. temp. limit stops • check stops: included 		U232CIS	270.70	1/2" CC/IPS	6		
		U232CXS	270.70	1/2" Cold Exp. PEX	6		
		U232XS	270.70	1/2" Crimp Ring PEX	6		
For more product details, reference page 472 in valve section. See page 478 for plumbing configurations.							
HOW TO ORDER VALVES: PAGE 472		TRIM PART #	+		=		COMPLETE FAUCET

















M-CORE® TRANSFER VALVE TRIM							
 <ul style="list-style-type: none"> • use with the M-CORE® transfer valve • valve: sold separately  		UT4301	226.45	Chrome	12		
		UT4301BN	278.20	Brushed Nickel	12		
		UT4301NL	278.20	Polished Nickel	12		
		UT4301BL	283.05	Matte Black	12		
		UT4301ORB	298.30	Oil Rubbed Bronze	12		
M-CORE® TRANSFER VALVE							
Three Function (2 independent/1 shared) OR Six Function (3 independent/3 shared) - plumbing configuration page 478							
 <ul style="list-style-type: none"> • number of functions: three or six • ports: four 		U361CI	152.70	1/2" CC/IPS	6		
		U361CX	152.70	1/2" Cold Exp. PEX	6		
		U361X	152.70	1/2" Crimp Ring PEX	6		
Two Independent Functions OR Three Independent Functions - plumbing configurations page 478							
 <ul style="list-style-type: none"> • number of functions: two or three • ports: four 		U231CI	152.70	1/2" CC/IPS	6		
		U231CX	152.70	1/2" Cold Exp. PEX	6		
		U231X	152.70	1/2" Crimp Ring PEX	6		
For more product details, reference page 472 in valve section. See page 478 for plumbing configurations.							
HOW TO ORDER VALVES: PAGE 472		TRIM PART #	+		=		COMPLETE FAUCET



BELFIELD™ Collection















		MODEL	LIST	FINISH/CONNECT	CASE QTY	
M-CORE® 2-SERIES TUB/SHOWER TRIM						
 <ul style="list-style-type: none"> • showerhead: single-function eco-performance rainshower • showerhead size: 7" diameter • tub spout length: 7 3/4" • tub spout connection type: slip fit • tub spout type: diverter • includes: pressure balanced cartridge with temperature control • valve: sold separately 		1.75 GPM (6.65 L/min) max.				
		UT2313EP	406.55	Chrome	4	
		UT2313EPBN	634.00	Brushed Nickel	4	
		UT2313EPNL	634.00	Polished Nickel	4	
		UT2313EPBL	687.30	Matte Black	4	
		UT2313EPORB	684.80	Oil Rubbed Bronze	4	
M-CORE® 2-SERIES SHOWER ONLY TRIM						
 <ul style="list-style-type: none"> • showerhead: single-function eco-performance rainshower • showerhead size: 7" diameter • includes: pressure balanced cartridge with temperature control • valve: sold separately 		1.75 GPM (6.65 L/min) max.				
		UT2312EP	347.25	Chrome	4	
		UT2312EPBN	526.25	Brushed Nickel	3	
		UT2312EPNL	526.25	Polished Nickel	4	
		UT2312EPBL	538.25	Matte Black	4	
		UT2312EPORB	565.85	Oil Rubbed Bronze	4	
M-CORE® 2-SERIES VALVE ONLY TRIM						
 <ul style="list-style-type: none"> • includes: pressure balanced cartridge with temperature control • valve: sold separately 						
		UT2311	292.70	Chrome	3	
		UT2311BN	426.45	Brushed Nickel	3	
		UT2311NL	426.45	Polished Nickel	3	
		UT2311BL	439.05	Matte Black	3	
		UT2311ORB	456.30	Oil Rubbed Bronze	3	
M-CORE® MIXING SHOWER VALVE						
 <ul style="list-style-type: none"> • tub/shower or shower only application • ports: four with adj. temp. limit stops • included: test plug and cross flow plug 						
		U140CI	72.60	1/2" CC/IPS	6	
		U140X	72.60	1/2" Crimp Ring PEX + CC/IPS Tub	6	
		U140CX	72.60	1/2" Cold Exp. PEX + CC/IPS Tub	6	
 <ul style="list-style-type: none"> • tub/shower or shower only application • ports: four with adj. temp. limit stops • quarter turn stops: included 						
		U140V	88.95	1/2" CPVC + CC/IPS Tub	6	
		U140CIS	104.50	1/2" CC/IPS	6	
		U140XS	104.50	1/2" Crimp Ring PEX + CC/IPS Tub	6	
 <ul style="list-style-type: none"> • shower only application • ports: three 						
		U140CX	104.50	1/2" Cold Exp. PEX + CC/IPS Tub	6	
		U140VS	120.85	1/2" CPVC + CC/IPS Tub	6	
		U130CI	72.60	1/2" CC/IPS	6	
 <ul style="list-style-type: none"> • shower only application • ports: three • quarter turn stops: included 						
		U130X	72.60	1/2" Crimp Ring PEX	6	
		U130CX	72.60	1/2" Cold Exp. PEX	6	
		U130CIS	104.50	1/2" CC/IPS	6	
	U130XS	104.50	1/2" Crimp Ring PEX	6		
	U130CXS	104.50	1/2" Cold Exp. PEX	6		
<p>Four port valves can be used with either Tub/Shower or Shower Only applications. Three port valves can ONLY be used with Shower Only applications. For more product details, reference page 471 in valve section.</p>						
<p>HOW TO ORDER VALVES: PAGE 471</p>		 <p>TRIM PART #</p>	+	 <p>VALVE PART #</p>	=	 <p>COMPLETE FAUCET</p>

MODEL LIST FINISH/CONNECT CASE QTY

POSI-TEMP® TUB/SHOWER TRIM				
 <ul style="list-style-type: none"> • showerhead: single-function rainshower • showerhead size: 7" diameter • tub spout length: 7 3/4" • tub spout connection type: slip fit • tub spout type: diverter • valve: sold separately 	2.5 GPM (9.5 L/min) max.			
	T2313	277.95	Chrome	4
	T2313BN	505.30	Brushed Nickel	4
	T2313NL	505.30	Polished Nickel	4
	T2313BL	514.25	Matte Black	4
	T2313ORB	556.15	Oil Rubbed Bronze	4
	1.75 GPM (6.65 L/min) max.			
	T2313EP	277.95	Chrome	4
	T2313EPBN	505.30	Brushed Nickel	4
	T2313EPNL	505.30	Polished Nickel	4
T2313EPBL	514.25	Matte Black	4	
T2313EPORB	556.15	Oil Rubbed Bronze	4	
POSI-TEMP® SHOWER ONLY TRIM				
 <ul style="list-style-type: none"> • showerhead: single-function rainshower • showerhead size: 7" diameter • valve: sold separately 	2.5 GPM (9.5 L/min) max.			
	T2312	218.60	Chrome	4
	T2312BN	397.60	Brushed Nickel	4
	T2312NL	397.60	Polished Nickel	4
	T2312BL	404.40	Matte Black	4
	T2312ORB	437.15	Oil Rubbed Bronze	4
	1.75 GPM (6.65 L/min) max.			
	T2312EP	218.60	Chrome	4
	T2312EPBN	397.60	Brushed Nickel	4
	T2312EPNL	397.60	Polished Nickel	4
T2312EPBL	404.40	Matte Black	4	
T2312EPORB	437.15	Oil Rubbed Bronze	4	
POSI-TEMP® VALVE ONLY TRIM				
 <ul style="list-style-type: none"> • valve: sold separately 	T2311	164.05	Chrome	3
	T2311BN	297.85	Brushed Nickel	3
	T2311NL	297.85	Polished Nickel	3
	T2311BL	303.55	Matte Black	3
	T2311ORB	327.60	Oil Rubbed Bronze	3
	POSI-TEMP® SHOWER MIXING VALVES			
 <ul style="list-style-type: none"> • tub/shower or shower only application • ports: four with adjustable temp. limit stops • test plug: included 	2520 ◆	159.20	1/2" CC	6
	2510 ◆	159.20	1/2" IPS	6
 <ul style="list-style-type: none"> • tub/shower or shower only application • ports: four with adjustable temp. limit stops • quarter turn stops: included • test plug: included 	2570 ◆	193.35	1/2" CC	6
	2590 ◆	193.35	1/2" IPS	6
	2580 ◆	159.20	1/2" Crimp ring PEX	6
 <ul style="list-style-type: none"> • tub/shower only application • ports: four with adjustable temp. limit stops • quarter turn stops: included • test plug: included 	2360PF	212.60	1/2" Crimp Ring PEX	3
 <ul style="list-style-type: none"> • shower only application • ports: three with adjustable temp. limit stops • quarter turn stops: included • test plug: included 	2326PF	205.20	1/2" Crimp Ring PEX	6
	2328PF	205.20	1/2" Cold Exp. PEX	6
<p>Four port valves can be used with either Tub/Shower or Shower Only applications. Three port valves can ONLY be used with Shower Only applications. For more product details, reference page 473-476 in valve section.</p>				
<p>HOW TO ORDER VALVES: PAGES 473-476</p>		 TRIM PART # +  VALVE PART # =  COMPLETE FAUCET		



BELFIELD™ Collection

		MODEL	LIST	FINISH/CONNECT	CASE QTY	
POSI-TEMP® WITH INTEGRATED TRANSFER VALVE TRIM						
 <ul style="list-style-type: none"> • valve: sold separately 	 	T2310	296.15	Chrome	4	
		T2310BN	537.75	Brushed Nickel	4	
		T2310NL	537.75	Polished Nickel	4	
		T2310BL	547.90	Matte Black	4	
		T2310ORB	591.55	Oil Rubbed Bronze	4	
POSI-TEMP® WITH INTEGRATED TRANSFER VALVE						
 <ul style="list-style-type: none"> • functions: three (two independent and one shared) • ports: four with adjustable temp. limit stops • test plug: included 		2551	287.50	1/2" IPS	6	
 <ul style="list-style-type: none"> • functions: three (two independent and one shared) • ports: four with adjustable temp. limit stops • stops: included • test plug: included 		2581	323.75	1/2" IPS	6	
 <ul style="list-style-type: none"> • functions: two independent • ports: four with adjustable temp. limit stops • test plug: included 		2521	287.50	1/2" IPS	6	
 <ul style="list-style-type: none"> • functions: two independent • ports: four with adjustable temp. limit stops • stops: included • test plug: included 		2571	323.75	1/2" IPS	6	
For more product details, reference page 477 in valve section.						
HOW TO ORDER VALVES: PAGE 477		 TRIM PART #	+	 VALVE PART #	=	 COMPLETE FAUCET



Moen® bath accessories CANNOT be combined with Moen faucet parts on a Purchase Order.

A line of matching accessories - including tank levers and towel bars - allow for a completely cohesive look in the bath.

MODEL NUMBER	LIST EACH	DESCRIPTION	QTY
Chrome (CH)			
YB6401CH	46.25	Tank Lever	24
YB6403CH	35.60	Double Robe Hook	24
(P) YB6408CH	64.95	Pivoting Paper Holder	6
YB6418CH	75.55	18" Towel Bar	6
YB6422CH	101.10	24" Double Towel Bar	6
YB6424CH	77.90	24" Towel Bar	6
YB6486CH	53.05	Hand Towel Bar	6
Brushed Nickel (BN)			
YB6401BN	51.05	Tank Lever	24
YB6403BN	39.15	Double Robe Hook	24
(P) YB6408BN	71.85	Pivoting Paper Holder	6
YB6418BN	82.95	18" Towel Bar	6
YB6422BN	108.85	24" Double Towel Bar	6
YB6424BN	86.00	24" Towel Bar	6
YB6486BN	57.95	Hand Towel Bar	6
Matte Black (BL)			
YB6401BL	56.15	Tank Lever	24
YB6403BL	43.20	Double Robe Hook	24
(P) YB6408BL	79.15	Pivoting Paper Holder	6
YB6418BL	91.30	18" Towel Bar	6
YB6422BL	119.85	24" Double Towel Bar	6
YB6424BL	94.55	24" Towel Bar	6
YB6486BL	63.80	Hand Towel Bar	6
Polished Nickel (NL)			
YB6401NL	56.00	Tank Lever	24
YB6403NL	43.20	Double Robe Hook	24
(P) YB6408NL	84.65	Pivoting Paper Holder	6
YB6418NL	91.40	18" Towel Bar	6
YB6422NL	122.45	24" Double Towel Bar	6
YB6424NL	94.30	24" Towel Bar	6
YB6486NL	68.80	Hand Towel Bar	6
Oil Rubbed Bronze (ORB)			
YB6401ORB	56.15	Tank Lever	24
YB6403ORB	43.20	Double Robe Hook	24
(P) YB6408ORB	79.15	Pivoting Paper Holder	6
YB6418ORB	91.30	18" Towel Bar	6
YB6422ORB	119.85	24" Double Towel Bar	6
YB6424ORB	94.55	24" Towel Bar	6
YB6486ORB	63.80	Hand Towel Bar	6

(P) Denotes pivoting paper holder



Tank Lever
YB6401



Double Robe Hook
YB6403



Pivoting Paper Holder
YB6408 | (P)



Hand Towel Bar
YB6486



18" Towel Bar
YB6418



24" Double Towel Bar
YB6422

24" Towel Bar
YB6424



BELFIELD™ Matching Bath Accessories



GRAB BARS ♿

MODEL NUMBER	LIST EACH	DESCRIPTION	QTY
1½" • Chrome (CH)			
YG6412CH	123.55	12" Designer Grab Bar	6
YG6418CH	129.10	18" Designer Grab Bar	6
YG6424CH	134.90	24" Designer Grab Bar	6
1½" • Brushed Nickel (BN)			
YG6412BN	150.75	12" Designer Grab Bar	6
YG6418BN	157.50	18" Designer Grab Bar	6
YG6424BN	168.65	24" Designer Grab Bar	6
1½" • Polished Nickel (NL)			
YG6412NL	155.65	12" Designer Grab Bar	6
YG6418NL	162.65	18" Designer Grab Bar	6
YG6424NL	169.95	24" Designer Grab Bar	6
1½" • Oil Rubbed Bronze (ORB)			
YG6412ORB	166.80	12" Designer Grab Bar	6
YG6418ORB	174.30	18" Designer Grab Bar	6
YG6424ORB	188.85	24" Designer Grab Bar	6
1½" • Matte Black (BL)			
YG6412BL	153.20	12" Designer Grab Bar	6
YG6418BL	160.10	18" Designer Grab Bar	6
YG6424BL	167.30	24" Designer Grab Bar	6

SECUREMOUNT™

- SecureMount™ Grab Bars are manufactured with an innovative flange design that makes it easy to connect to the stud at multiple points.
- Tested to withstand 500lbs.
- To install grab bars securely without studs, use SecureMount™ Anchors. Sold separately.



24" Designer Grab Bar

YG6424

BELFIELD™

♿ Complies with Americans with Disabilities Act (ADA) specifications. SecureMount™ Grab Bars are tested to withstand 500 lb. pull when securely installed per instructions.

List price is per each (unless otherwise noted). Product can be ordered by case quantity or individually.



LIGHTING

MODEL NUMBER	LIST EACH	DESCRIPTION	QTY
Chrome (CH)			
YB6461CH	181.45	One Globe Bath Light	1
YB6462CH	253.85	Two Globe Bath Light	1
YB6463CH	315.10	Three Globe Bath Light	1
YB6464CH	403.55	Four Globe Bath Light	1
Brushed Nickel (BN)			
YB6461BN	226.75	One Globe Bath Light	1
YB6462BN	317.20	Two Globe Bath Light	1
YB6463BN	393.90	Three Globe Bath Light	1
YB6464BN	504.50	Four Globe Bath Light	1
Polished Nickel (NL)			
YB6461NL	219.65	One Globe Bath Light	1
YB6462NL	307.40	Two Globe Bath Light	1
YB6463NL	393.90	Three Globe Bath Light	1
YB6464NL	523.85	Four Globe Bath Light	1
Oil Rubbed Bronze (ORB)			
YB6461ORB	226.75	One Globe Bath Light	1
YB6462ORB	317.20	Two Globe Bath Light	1
YB6463ORB	393.90	Three Globe Bath Light	1
YB6464ORB	504.50	Four Globe Bath Light	1
Matte Black (BL)			
YB6461BL	219.65	One Globe Bath Light	1
YB6462BL	307.40	Two Globe Bath Light	1
YB6463BL	410.15	Three Globe Bath Light	1
YB6464BL	523.85	Four Globe Bath Light	1
Replacement Globe			
YB6469	33.30	Replacement Globe	3



One Globe Bath Light
YB6461



Two Globe Bath Light
YB6462



Three Globe Bath Light
YB6463



Four Globe Bath Light
YB6464











Replacement Globe
YB6469



BELFIELD™



Bulbs not included.
List price is per each (unless otherwise noted).
Product can be ordered by case quantity or individually.
All Belfield™ lighting Fixtures can be mounted facing either upward or downward.

		MODEL	LIST	FINISH/CONNECT	CASE QTY
TOUCHLESS ONE-HANDLE BATHROOM FAUCET - MOTIONSENSE WAVE™					
 <p>DECKPLATE INCLUDED</p>  <ul style="list-style-type: none"> • application: one or three hole • supply lines: flexible • connection: 3/8" compression • deckplate: included • drain assembly: metal • drain assembly type: spring loaded pop-up • red/blue markings: included • matte black faucet includes optional brushed gold escutcheon • DC powered: 6 AA batteries included 	 1.2 GPM (4.5L/min) max.				
	6221EW	627.70	Chrome	3	
	6221EWBN	847.40	Brushed Nickel	3	
	6221EWBL	910.15	Matte Black	3	
	6221EWBG	910.15	Brushed Gold	3	
	OPTIONAL AC ADAPTERS SOLD SEPARATELY				
169031	159.60	N/A or Unfinished	12		











ONE-HANDLE BATHROOM FAUCET					
 <p>DECKPLATE INCLUDED</p>  <ul style="list-style-type: none"> • application: one or three hole • supply lines: flexible • connection: 3/8" compression • deckplate: included • drain assembly: metal with lift rod • matte black faucet includes optional brushed gold escutcheon and lift rod • red/blue markings: included 	 1.2 GPM (4.5L/min) max.				
	6221	348.95	Chrome	3	
	6221BN	461.85	Brushed Nickel	3	
	6221BL	496.05	Matte Black	3	
	6221BG	505.95	Brushed Gold	3	









TWO-HANDLE WIDESPREAD BATHROOM FAUCET TRIM					
 <ul style="list-style-type: none"> • application: three hole • center dimensions: 8" - 16" center • drain assembly: metal with lift rod • matte black faucet includes optional brushed gold escutcheon and lift rod • valve: sold separately 	 1.2 GPM (4.5L/min) max.				
	T6222	362.35	Chrome	3	
	T6222BN	525.40	Brushed Nickel	3	
	T6222BL	579.75	Matte Black	3	
	T6222BG	579.75	Brushed Gold	3	











WIDESPREAD FAUCET VALVE					
 <ul style="list-style-type: none"> • application: three hole • center dimensions: 8" - 16" center • drain assembly: metal with lift rod 	9000◆	165.40	1/2" IPS	6	







HOW TO ORDER
VALVES: PAGE 469







 TRIM PART # +
  VALVE PART # =
  COMPLETE FAUCET

















		MODEL	LIST	FINISH/CONNECT	CASE QTY
FREESTANDING TUB FILLER TRIM					
 <ul style="list-style-type: none"> • application: one hole • showerhead type: handshower • handshower functions: one-function • handshower flow rate: 1.75 gpm (6.65 L/min) max. • spout reach: 8.81" • mounting kit: sold separately  		615	1752.20	Chrome	1
		615BN	2365.55	Brushed Nickel	1
		615BG	2365.55	Brushed Gold	1
		615BL	2601.95	Matte Black	1
FREESTANDING TUB FILLER VALVE AND MOUNTING KIT - PREMIUM					
 <ul style="list-style-type: none"> • description: single riser floor joist mounting kit • application: one hole • quarter turn stops: included 		TS50100	408.90	1/2" CC, NPT	2
	 <ul style="list-style-type: none"> • description: single riser concrete mounting kit • application: one hole • connection size: 1/2" 		TS50110	332.45	1/2" CC, NPT
<p>HOW TO ORDER VALVES: PAGE 469</p>  TRIM PART # +  VALVE PART # =  COMPLETE FAUCET					

















ONE-HANDLE WALLMOUNT TUB FILLER TRIM					
 <ul style="list-style-type: none"> • application: two hole • connection: 1/2" slip fit • tub spout type: non diverter • spout reach: 10.00" • includes: high flow volume control cartridge • WMV130 series valve kit: sold separately  		WT6221	712.75	Chrome	3
		WT6221BN	962.15	Brushed Nickel	3
		WT6221BG	962.15	Brushed Gold	3
		WT6221BL	1058.40	Matte Black	3
ONE-HANDLE WALLMOUNT TUB FILLER VALVE KIT					
 <ul style="list-style-type: none"> • application: two hole with adj. center dimensions • ports: three • quarter turn stops: included • includes: test plug • includes: spout manifold 		WMV130CIS	154.05	1/2" CC/IPS	6
		WMV130XS	154.05	1/2" Crimp Ring PEX	6
		WMV130CXS	154.05	1/2" Cold Exp. PEX	6
<p>HOW TO ORDER VALVES: PAGE 469</p>  TRIM PART # +  VALVE PART # =  COMPLETE FAUCET					











		MODEL	LIST	FINISH/CONNECT	CASE QTY
TWO-HANDLE ROMAN TUB TRIM					
 <ul style="list-style-type: none"> • application: three hole • spout reach: 8.00" • matte black faucet includes optional brushed gold escutcheon • valve: sold separately  		T6223	512.75	Chrome	3
		T6223BN	716.50	Brushed Nickel	3
		T6223BG	716.50	Brushed Gold	3
		T6223BL	788.15	Matte Black	3
TWO-HANDLE ROMAN TUB VALVE					
 <ul style="list-style-type: none"> • deck thickness: 1/8" to 3-3/8" rough-in deck • adjustable spout shank: adjustable center dimensions  DURALAST®		4792	192.30	1/2" CC	6
 <ul style="list-style-type: none"> • deck thickness: 1/8" to 2-3/4" rough-in deck • adjustable spout shank: 10" - 24" center dimensions  DURALOCK® DURALAST®		4793	217.80	1/2" CPVC, Crimp Ring PEX	6
		4794	207.65	1/2" Crimp Ring PEX, Cold Exp. PEX	6
 <ul style="list-style-type: none"> • deck thickness: 1/8" to 3-3/16" rough-in deck • Non-adjustable spout shank: 10" center dimensions  DURALAST®		4796	181.20	1/2" CC	6
		4797	184.70	1/2" CPVC, Crimp Ring PEX	6
		4798	184.70	1/2" Crimp Ring PEX, Cold Exp. PEX	6
For more product details, reference page 470 in valve section.					
HOW TO ORDER VALVES: PAGE 470					











EXACTTEMP® VALVE ONLY TRIM					
 <ul style="list-style-type: none"> • description: temperature control valve trim • requires: separate volume control valve • valve: sold separately  		T4621	297.05	Chrome	3
		T4621BN	448.75	Brushed Nickel	3
		T4621BG	448.75	Brushed Gold	3
		T4621BL	482.85	Matte Black	3
EXACTTEMP® THERMOSTATIC MIXING SHOWER VALVE - PREMIUM					
 <ul style="list-style-type: none"> • description: thermostatic rough-in valve • ports: four with adjustable temp. limit stops • check stops: included 		S3371	728.95	3/4" IPS	6
HOW TO ORDER VALVES: PAGE 471					

















EXACTTEMP® VOLUME CONTROL VALVE TRIM					
 <ul style="list-style-type: none"> • valve: sold separately  		T4622	151.25	Chrome	6
		T4622BN	227.95	Brushed Nickel	6
		T4622BG	227.95	Brushed Gold	6
		T4622BL	245.80	Matte Black	6
EXACTTEMP® VOLUME CONTROL SHOWER VALVE - PREMIUM					
 <ul style="list-style-type: none"> • includes: volume control 		S3600	185.35	3/4" IPS	12
HOW TO ORDER VALVES: PAGE 471					

















		MODEL	LIST	FINISH/CONNECT	CASE QTY	
M-CORE® 4-SERIES TUB/SHOWER TRIM						
 <ul style="list-style-type: none"> • showerhead functions: one-function • showerhead size: 10" diameter • tub spout length: 7 1/4" • tub spout connection type: slip fit • includes: thermostatic cartridge with volume and temperature control • valve: sold separately 			1.75 GPM (6.65 L/min) max.			
		UT4363EP	635.30	Chrome	3	
		UT4363EPBN	966.90	Brushed Nickel	3	
		UT4363EPBG	966.90	Brushed Gold	3	
		UT4363EPBL	1049.90	Matte Black	3	
M-CORE® 4-SERIES SHOWER ONLY TRIM						
 <ul style="list-style-type: none"> • showerhead functions: one-function • showerhead size: 10" diameter • includes: thermostatic cartridge with volume and temperature control • valve: sold separately 			1.75 GPM (6.65 L/min) max.			
		UT4362EP	543.15	Chrome	3	
		UT4362EPBN	819.00	Brushed Nickel	3	
		UT4362EPBG	819.00	Brushed Gold	3	
		UT4362EPBL	887.15	Matte Black	3	
M-CORE® 4-SERIES VALVE ONLY TRIM						
 <ul style="list-style-type: none"> • includes: thermostatic cartridge with volume and temperature control • valve: sold separately 		UT4361	478.40	Chrome	3	
		UT4361BN	696.90	Brushed Nickel	3	
		UT4361BG	696.90	Brushed Gold	3	
		UT4361BL	752.80	Matte Black	3	
	M-CORE® MIXING SHOWER VALVE					
 <ul style="list-style-type: none"> • tub/shower or shower only application • ports: four with adj. temp. limit stops • included: test plug and cross flow plug 		U140CI	72.60	1/2" CC/IPS	6	
		U140X	72.60	1/2" Crimp Ring PEX + CC/IPS Tub	6	
		U140CX	72.60	1/2" Cold Exp. PEX + CC/IPS Tub	6	
		U140V	88.95	1/2" CPVC + CC/IPS Tub	6	
	 <ul style="list-style-type: none"> • tub/shower or shower only application • ports: four with adj. temp. limit stops • quarter turn stops: included 		U140CIS	104.50	1/2" CC/IPS	6
		U140XS	104.50	1/2" Crimp Ring PEX + CC/IPS Tub	6	
		U140CXS	104.50	1/2" Cold Exp. PEX + CC/IPS Tub	6	
		U140VS	120.85	1/2" CPVC + CC/IPS Tub	6	
 <ul style="list-style-type: none"> • shower only application • ports: three 			U130CI	72.60	1/2" CC/IPS	6
		U130X	72.60	1/2" Crimp Ring PEX	6	
		U130CX	72.60	1/2" Cold Exp. PEX	6	
 <ul style="list-style-type: none"> • shower only application • ports: three • quarter turn stops: included 		U130CIS	104.50	1/2" CC/IPS	6	
		U130XS	104.50	1/2" Crimp Ring PEX	6	
		U130CXS	104.50	1/2" Cold Exp. PEX	6	
<p>Four port valves can be used with either Tub/Shower or Shower Only applications. Three port valves can ONLY be used with Shower Only applications. For more product details, reference page 471 in valve section.</p>						
<p>HOW TO ORDER VALVES: PAGE 471</p>		 <p>TRIM PART #</p>	+	 <p>VALVE PART #</p>	=	 <p>COMPLETE FAUCET</p>

		MODEL	LIST	FINISH/CONNECT	CASE QTY	
M-CORE® 3-SERIES TUB/SHOWER TRIM						
 <ul style="list-style-type: none"> • showerhead: single-function rainshower • showerhead size: 10" diameter • tub spout length: 7 1/4" • tub spout connection type: slip fit • tub spout type: diverter • includes: pressure balanced cartridge with volume and temperature control • valve: sold separately 		2.5 GPM (9.5 L/min) max.				
		UT3363	497.60	Chrome	3	
		UT3363BN	829.20	Brushed Nickel	3	
		UT3363BG	829.20	Brushed Gold	3	
		UT3363BL	912.20	Matte Black	3	
		1.75 GPM (6.65 L/min) max.				
		UT3363EP	497.60	Chrome	3	
		UT3363EPBN	829.20	Brushed Nickel	3	
		UT3363EPBG	829.20	Brushed Gold	3	
		UT3363EPBL	912.20	Matte Black	3	
M-CORE® 3-SERIES SHOWER ONLY TRIM						
 <ul style="list-style-type: none"> • showerhead: single-function rainshower • showerhead size: 10" diameter • includes: pressure balanced cartridge with volume and temperature control • valve: sold separately 		2.5 GPM (9.5 L/min) max.				
		UT3362	405.45	Chrome	3	
		UT3362BN	681.30	Brushed Nickel	3	
		UT3362BG	681.30	Brushed Gold	3	
		UT3362BL	749.45	Matte Black	3	
		1.75 GPM (6.65 L/min) max.				
		UT3362EP	405.45	Chrome	3	
		UT3362EPBN	681.30	Brushed Nickel	3	
		UT3362EPBG	681.30	Brushed Gold	3	
		UT3362EPBL	749.45	Matte Black	3	
M-CORE® 3-SERIES VALVE ONLY TRIM						
 <ul style="list-style-type: none"> • includes: pressure balanced cartridge with volume and temperature control • valve: sold separately 		UT3361	340.70	Chrome	3	
		UT3361BN	559.20	Brushed Nickel	3	
		UT3361BG	559.20	Brushed Gold	3	
		UT3361BL	615.10	Matte Black	3	
	M-CORE® MIXING SHOWER VALVE					
 <ul style="list-style-type: none"> • tub/shower or shower only application • ports: four with adj. temp. limit stops • included: test plug and cross flow plug 		U140CI	72.60	1/2" CC/IPS	6	
		U140X	72.60	1/2" Crimp Ring PEX + CC/IPS Tub	6	
		U140CX	72.60	1/2" Cold Exp. PEX + CC/IPS Tub	6	
		U140V	88.95	1/2" CPVC + CC/IPS Tub	6	
	 <ul style="list-style-type: none"> • tub/shower or shower only application • ports: four with adj. temp. limit stops • quarter turn stops: included 		U140CIS	104.50	1/2" CC/IPS	6
		U140XS	104.50	1/2" Crimp Ring PEX + CC/IPS Tub	6	
		U140CXS	104.50	1/2" Cold Exp. PEX + CC/IPS Tub	6	
		U140VS	120.85	1/2" CPVC + CC/IPS Tub	6	
 <ul style="list-style-type: none"> • shower only application • ports: three 			U130CI	72.60	1/2" CC/IPS	6
		U130X	72.60	1/2" Crimp Ring PEX	6	
		U130CX	72.60	1/2" Cold Exp. PEX	6	
 <ul style="list-style-type: none"> • shower only application • ports: three • quarter turn stops: included 		U130CIS	104.50	1/2" CC/IPS	6	
		U130XS	104.50	1/2" Crimp Ring PEX	6	
		U130CXS	104.50	1/2" Cold Exp. PEX	6	
<p>Four port valves can be used with either Tub/Shower or Shower Only applications. Three port valves can ONLY be used with Shower Only applications. For more product details, reference page 471 in valve section.</p>						
<p>HOW TO ORDER VALVES: PAGE 471</p>		 <p>TRIM PART #</p>	+	 <p>VALVE PART #</p>	=	 <p>COMPLETE FAUCET</p>

		MODEL	LIST	FINISH/CONNECT	CASE QTY		
M-CORE® 3-SERIES WITH INTEGRATED TRANSFER VALVE TRIM							
 <ul style="list-style-type: none"> • includes: pressure balanced cartridge with volume and temperature control • valve: sold separately  		UT3331	321.95	Chrome	4		
		UT3331BN	399.15	Brushed Nickel	4		
		UT3331BG	399.15	Brushed Gold	4		
		UT3331BL	439.05	Matte Black	4		
M-CORE® WITH INTEGRATED TRANSFER VALVE							
Three Function (2 independent/1 shared) OR Six Function (3 independent/3 shared) - plumbing configuration page 478							
 <ul style="list-style-type: none"> • ports: four with adj. temp. limit stops • check stops: included 		U362CIS	270.70	1/2" CC/IPS	6		
		U362CXS	270.70	1/2" Cold Exp. PEX	6		
		U362XS	270.70	1/2" Crimp Ring PEX	6		
Two Independent Functions OR Three Independent Functions - plumbing configurations page 478							
 <ul style="list-style-type: none"> • ports: four with adj. temp. limit stops • check stops: included 		U232CIS	270.70	1/2" CC/IPS	6		
		U232CXS	270.70	1/2" Cold Exp. PEX	6		
		U232XS	270.70	1/2" Crimp Ring PEX	6		
For more product details, reference page 472 in valve section. See page 478 for plumbing configurations.							
HOW TO ORDER VALVES: PAGE 472		TRIM PART #	+		=		COMPLETE FAUCET

M-CORE® TRANSFER VALVE TRIM							
 <ul style="list-style-type: none"> • use with the M-CORE® transfer valve • valve: sold separately  		UT4620	222.85	Chrome	12		
		UT4620BN	274.35	Brushed Nickel	12		
		UT4620BG	274.35	Brushed Gold	12		
		UT4620BL	294.40	Matte Black	12		
M-CORE® TRANSFER VALVE							
Three Function (2 independent/1 shared) OR Six Function (3 independent/3 shared) - plumbing configuration page 478							
 <ul style="list-style-type: none"> • number of functions: three or six • ports: four 		U361CI	152.70	1/2" CC/IPS	6		
		U361CX	152.70	1/2" Cold Exp. PEX	6		
		U361X	152.70	1/2" Crimp Ring PEX	6		
Two Independent Functions OR Three Independent Functions - plumbing configurations page 478							
 <ul style="list-style-type: none"> • number of functions: two or three • ports: four 		U231CI	152.70	1/2" CC/IPS	6		
		U231CX	152.70	1/2" Cold Exp. PEX	6		
		U231X	152.70	1/2" Crimp Ring PEX	6		
For more product details, reference page 472 in valve section. See page 478 for plumbing configurations.							
HOW TO ORDER VALVES: PAGE 472		TRIM PART #	+		=		COMPLETE FAUCET

		MODEL	LIST	FINISH/CONNECT	CASE QTY	
M-CORE® 2-SERIES TUB/SHOWER TRIM						
 <ul style="list-style-type: none"> • showerhead: single-function eco-performance rainshower • showerhead size: 6-3/4" diameter • type of function: one function • tub spout length: 7 1/4" • tub spout connection type: slip fit • tub spout type: diverter • red/blue markings: included • includes: pressure balanced cartridge with temperature control • valve: sold separately 	<ul style="list-style-type: none"> • 1.75 GPM (6.65 L/min) max. 					
		UT2263EP	400.50	Chrome	4	
		UT2263EPBN	626.80	Brushed Nickel	4	
		UT2263EPBG	626.80	Brushed Gold	4	
		UT2263EPBL	677.15	Matte Black	4	
M-CORE® 2-SERIES SHOWER ONLY TRIM						
 <ul style="list-style-type: none"> • showerhead: single-function eco-performance rainshower • showerhead size: 6-3/4" diameter • red/blue markings: included • includes: pressure balanced cartridge with temperature control • valve: sold separately 	<ul style="list-style-type: none"> • 1.75 GPM (6.65 L/min) max. 					
		UT2262EP	341.20	Chrome	4	
		UT2262EPBN	519.50	Brushed Nickel	4	
		UT2262EPBG	519.50	Brushed Gold	4	
		UT2262EPBL	559.10	Matte Black	4	
M-CORE® 2-SERIES VALVE ONLY TRIM						
 <ul style="list-style-type: none"> • includes: pressure balanced cartridge with temperature control • valve: sold separately 						
		UT2261	286.80	Chrome	3	
		UT2261BN	420.15	Brushed Nickel	3	
		UT2261BG	420.15	Brushed Gold	3	
		UT2261BL	449.85	Matte Black	3	
M-CORE® MIXING SHOWER VALVE						
 <ul style="list-style-type: none"> • tub/shower or shower only application • ports: four with adj. temp. limit stops • included: test plug and cross flow plug 						
		U140CI	72.60	1/2" CC/IPS	6	
		U140X	72.60	1/2" Crimp Ring PEX + CC/IPS Tub	6	
		U140CX	72.60	1/2" Cold Exp. PEX + CC/IPS Tub	6	
		U140V	88.95	1/2" CPVC + CC/IPS Tub	6	
 <ul style="list-style-type: none"> • tub/shower or shower only application • ports: four with adj. temp. limit stops • quarter turn stops: included 						
		U140CIS	104.50	1/2" CC/IPS	6	
		U140XS	104.50	1/2" Crimp Ring PEX + CC/IPS Tub	6	
		U140CXS	104.50	1/2" Cold Exp. PEX + CC/IPS Tub	6	
		U140VS	120.85	1/2" CPVC + CC/IPS Tub	6	
 <ul style="list-style-type: none"> • shower only application • ports: three 						
		U130CI	72.60	1/2" CC/IPS	6	
		U130X	72.60	1/2" Crimp Ring PEX	6	
 <ul style="list-style-type: none"> • shower only application • ports: three • quarter turn stops: included 						
		U130CIS	104.50	1/2" CC/IPS	6	
		U130XS	104.50	1/2" Crimp Ring PEX	6	
	U130CXS	104.50	1/2" Cold Exp. PEX	6		
<p>Four port valves can be used with either Tub/Shower or Shower Only applications. Three port valves can ONLY be used with Shower Only applications. For more product details, reference page 471 in valve section.</p>						
<p>HOW TO ORDER VALVES: PAGE 471</p>		 <p>TRIM PART #</p>	+	 <p>VALVE PART #</p>	=	 <p>COMPLETE FAUCET</p>

		MODEL	LIST	FINISH/CONNECT	CASE QTY	
POSI-TEMP® TUB/SHOWER TRIM						
	<ul style="list-style-type: none"> • showerhead: single-function eco-performance rainshower • showerhead size: 6-3/4" diameter • tub spout length: 7 1/4" • tub spout connection type: slip fit • tub spout type: diverter • red/blue markings: included • valve: sold separately 	1.75 GPM (6.65 L/min) max.				
		T2263EP	277.05	Chrome	4	
		T2263EPBN	503.35	Brushed Nickel	4	
		T2263EPBG	503.35	Brushed Gold	4	
		T2263EPBL	553.65	Matte Black	4	
						
POSI-TEMP® SHOWER ONLY TRIM						
	<ul style="list-style-type: none"> • showerhead: single-function eco-performance rainshower • showerhead size: 6-3/4" diameter • red/blue markings: included • valve: sold separately 	1.75 GPM (6.65 L/min) max.				
		T2262EP	217.70	Chrome	4	
		T2262EPBN	396.00	Brushed Nickel	4	
		T2262EPBG	396.00	Brushed Gold	4	
		T2262EPBL	435.65	Matte Black	4	
						
POSI-TEMP® VALVE ONLY TRIM						
	<ul style="list-style-type: none"> • red/blue markings: included • valve: sold separately 	T2261	163.35	Chrome	3	
		T2261BN	296.65	Brushed Nickel	3	
		T2261BG	296.65	Brushed Gold	3	
		T2261BL	326.45	Matte Black	3	
						
POSI-TEMP® SHOWER MIXING VALVES						
	<ul style="list-style-type: none"> • tub/shower or shower only application • ports: four with adjustable temp. limit stops • test plug: included 	2520 ◆	159.20	1/2" CC	6	
		2510 ◆	159.20	1/2" IPS	6	
	<ul style="list-style-type: none"> • tub/shower or shower only application • ports: four with adjustable temp. limit stops • quarter turn stops: included • test plug: included 	2570 ◆	193.35	1/2" CC	6	
		2590 ◆	193.35	1/2" IPS	6	
		2580 ◆	159.20	1/2" Crimp ring PEX	6	
						
	<ul style="list-style-type: none"> • tub/shower only application • ports: four with adjustable temp. limit stops • quarter turn stops: included • test plug: included 	2360PF	212.60	1/2" Crimp Ring PEX	3	
						
	<ul style="list-style-type: none"> • shower only application • ports: three with adjustable temp. limit stops • quarter turn stops: included • test plug: included 	2326PF	205.20	1/2" Crimp Ring PEX	6	
		2328PF	205.20	1/2" Cold Exp. PEX	6	
						
<p>Four port valves can be used with either Tub/Shower or Shower Only applications. Three port valves can ONLY be used with Shower Only applications. For more product details, reference page 473-476 in valve section.</p>						
HOW TO ORDER						
VALVES: PAGES 473-476		 TRIM PART #	+	 VALVE PART #	=	 COMPLETE FAUCET



ALIGN® Coordinating Bath Accessories

Moen® bath accessories CANNOT be combined with Moen faucet parts on a Purchase Order.

COORDINATING ACCESSORIES

Complimentary styles for a cohesive look. From robe hooks to towel bars, paper holders to knobs and pulls, Moen offers a variety of coordinating accessories to complete any room.

MODEL NUMBER	LIST EACH	DESCRIPTION	QTY
Chrome (CH)			
YB0402CH	66.85	Swiveling Double Robe Hook	24
YB0403CH	37.00	Single Robe Hook	24
(P) YB0408CH	67.45	Pivoting Paper Holder	6
YB0409CH	57.45	Single-Post Paper Holder	6
YB0418CH	78.35	18" Towel Bar	6
YB0424CH	80.80	24" Towel Bar	6
YB0486CH	55.00	Hand Towel Bar	6
Brushed Nickel (BN)			
YB0402BN	76.15	Swiveling Double Robe Hook	24
YB0403BN	40.70	Single Robe Hook	24
(P) YB0408BN	74.60	Pivoting Paper Holder	6
YB0409BN	63.20	Single-Post Paper Holder	6
YB0418BN	86.15	18" Towel Bar	6
YB0424BN	89.20	24" Towel Bar	6
YB0486BN	60.15	Hand Towel Bar	6
Brushed Gold (BG)			
YB0403BG	48.85	Single Robe Hook	24
(P) YB0408BG	108.20	Pivoting Paper Holder	6
YB0418BG	120.60	18" Towel Bar	6
YB0424BG	124.75	24" Towel Bar	6
YB0486BG	87.15	Hand Towel Bar	6
Matte Black (BL)			
YB0402BL	83.55	Swiveling Double Robe Hook	24
YB0403BL	44.70	Single Robe Hook	24
(P) YB0408BL	82.05	Pivoting Paper Holder	6
YB0409BL	69.45	Single-Post Paper Holder	6
YB0418BL	94.70	18" Towel Bar	6
YB0424BL	98.05	24" Towel Bar	6
YB0486BL	66.15	Hand Towel Bar	6

(P) Denotes pivoting paper holder and mirror



Single Robe Hook
YB0403



Swiveling Double Robe Hook
YB0402



Pivoting Paper Holder
YB0408 | (P)



Single Post Paper Holder
YB0409



Hand Towel Bar
YB0486



18" Towel Bar
YB0418

24" Towel Bar
YB0424









GRAB BARS 

SECUREMOUNT

- SecureMount™ Grab Bars are manufactured with an innovative flange design that makes it easy to connect to the stud at multiple points.
- Tested to withstand 500lbs.
- To install grab bars securely without studs, use SecureMount™ Anchors. Sold separately.



18" Designer Grab Bar
YG0418













MODEL NUMBER	LIST EACH	DESCRIPTION	QTY
1 1/4" • Chrome (CH)			
YG0412CH	123.55	12" Designer Grab Bar	6
YG0418CH	132.25	18" Designer Grab Bar	6
YG0424CH	138.10	24" Designer Grab Bar	6
YG0436CH	157.45	36" Designer Grab Bar	6
YG0442CH	189.00	42" Designer Grab Bar	6
1 1/4" • Brushed Nickel (BN)			
YG0412BN	154.45	12" Designer Grab Bar	6
YG0418BN	165.30	18" Designer Grab Bar	6
YG0424BN	172.65	24" Designer Grab Bar	6
YG0436BN	196.80	36" Designer Grab Bar	6
YG0442BN	236.25	42" Designer Grab Bar	6
1 1/4" • Brushed Gold (BG)			
YG0412BG	159.35	12" Designer Grab Bar	6 
YG0418BG	191.80	18" Designer Grab Bar	6
YG0424BG	200.25	24" Designer Grab Bar	6
YG0436BG	203.10	36" Designer Grab Bar	6 
YG0442BG	274.05	42" Designer Grab Bar	6 
1 1/4" • Matte Black (BL)			
YG0412BL	155.65	12" Designer Grab Bar	6 
YG0418BL	166.65	18" Designer Grab Bar	6 
YG0424BL	174.00	24" Designer Grab Bar	6 
YG0436BL	198.35	36" Designer Grab Bar	6 
YG0442BL	245.70	42" Designer Grab Bar	6 





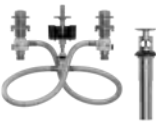



 Complies with Americans with Disabilities Act (ADA) specifications. SecureMount™ Grab Bars are tested to withstand 500 lb. pull when securely installed per instructions.









List price is per each (unless otherwise noted). Product can be ordered by case quantity or individually.



VOSS™ Collection







		MODEL	LIST	FINISH/CONNECT	CASE QTY
ONE-HANDLE BATHROOM FAUCET					
 DECKPLATE INCLUDED 	<ul style="list-style-type: none"> • application: one or three hole • supply lines: flexible • connection: 3/8" compression • deckplate: included • drain assembly: metal with lift rod 	1.2 GPM (4.5L/min) max.			
	<ul style="list-style-type: none"> •  DURALAST® 	6903	348.95	Chrome	3
		6903BN	461.85	Brushed Nickel	3
		6903BL	478.95	Matte Black	3
		6903NL	488.50	Polished Nickel	3
		6903BG	505.95	Brushed Gold	3
		6903ORB	496.05	Oil Rubbed Bronze	3
TWO-HANDLE CENTERSET BATHROOM FAUCET					
	<ul style="list-style-type: none"> • application: three hole • center dimensions: 4" center • connection: 1/2" IPS • drain assembly: metal with lift rod 	1.2 GPM (4.5L/min) max.			
	<ul style="list-style-type: none"> •  DURALAST® 	6901	346.80	Chrome	3
		6901BN	459.05	Brushed Nickel	3
		6901BL	476.05	Matte Black	3
		6901NL	485.50	Polished Nickel	3
		6901BG	502.85	Brushed Gold	3
		6901ORB	493.05	Oil Rubbed Bronze	3
TWO-HANDLE WIDESPREAD BATHROOM FAUCET TRIM					
	<ul style="list-style-type: none"> • application: three hole • center dimensions: 8" - 16" center • drain assembly: metal with lift rod • valve: sold separately 	1.2 GPM (4.5L/min) max.			
	<ul style="list-style-type: none"> •   	T6905	362.35	Chrome	3
		T6905BN	532.85	Brushed Nickel	3
		T6905BL	610.80	Matte Black	3
		T6905NL	550.60	Polished Nickel	3
		T6905BG	586.15	Brushed Gold	3
		T6905ORB	568.35	Oil Rubbed Bronze	3
WIDESPREAD FAUCET VALVE					
	<ul style="list-style-type: none"> • application: three hole • center dimensions: 8" - 16" center • drain assembly: metal with lift rod 	9000◆	165.40	1/2" IPS	6
	<ul style="list-style-type: none"> •  DURALOCK® DURALAST® 				
HOW TO ORDER VALVES: PAGE 469	 TRIM PART #	+	 VALVE PART #	=	 COMPLETE FAUCET















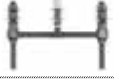

	MODEL	LIST	FINISH/CONNECT	CASE QTY
TWO-HANDLE WALLMOUNT BATHROOM FAUCET TRIM				
 <ul style="list-style-type: none"> • application: three hole • center dimensions: 8" center • drain assembly: 140780 sold separately • valve: sold separately 		1.2 GPM (4.5L/min) max.		
	T6906	413.05	Chrome	3
	T6906BN	587.20	Brushed Nickel	3
	T6906BL	675.00	Matte Black	3
	T6906NL	607.45	Polished Nickel	3
	T6906BG	647.90	Brushed Gold	3
	T6906ORB	627.70	Oil Rubbed Bronze	3
TWO-HANDLE WALLMOUNT FAUCET VALVE				
 <ul style="list-style-type: none"> • application: three hole • center dimensions: 8" center • drain assembly: 140780 sold separately • includes: mounting brackets  DURALAST®	9700	233.95	1/2" CC	3
	HOW TO ORDER VALVES: PAGE 469  TRIM PART # +  VALVE PART # =  COMPLETE FAUCET			
OPTION: DRAIN ASSEMBLY				
 <ul style="list-style-type: none"> • drain assembly: metal • drain assembly type: spring loaded pop-up • drain assembly size: 1-1/4" • drain assembly: 1-1/4" non-overflow 	140780	78.35	Chrome	12
	140780BN	109.20	Brushed Nickel	12
	140780BL	123.30	Matte Black	12
	140780NL	109.20	Polished Nickel	12
	140780BG	109.20	Brushed Gold	12
	140780ORB	131.30	Oil Rubbed Bronze	12

FREESTANDING TUB FILLER TRIM				
 <ul style="list-style-type: none"> • application: one hole • showerhead type: handshower • handshower functions: one-function • handshower flow rate: 1.75 gpm (6.65 L/min) max. • spout reach: 9.75" • mounting kit: sold separately 	695	1912.45	Chrome	1
	695BN	2581.80	Brushed Nickel	1
	695NL	2581.80	Polished Nickel	1
	695BG	2581.80	Brushed Gold	1
	695BL	2641.90	Matte Black	1
	695ORB	2840.05	Oil Rubbed Bronze	1
	FREESTANDING TUB FILLER VALVE AND MOUNTING KIT - PREMIUM			
 <ul style="list-style-type: none"> • description: single riser floor joist mounting kit • application: one hole • quarter turn stops: included 	TS50100	408.90	1/2" CC, NPT	2
	 <ul style="list-style-type: none"> • description: single riser concrete mounting kit • application: one hole • connection size: 1/2" 	TS50110	332.45	1/2" CC, NPT
HOW TO ORDER VALVES: PAGE 469  TRIM PART # +  VALVE PART # =  COMPLETE FAUCET				

















VOSS™ Collection

		MODEL	LIST	FINISH/CONNECT	CASE QTY
ONE-HANDLE WALLMOUNT TUB FILLER TRIM					
 <ul style="list-style-type: none"> • application: two hole • connection: 1/2" slip fit • tub spout type: non diverter • spout reach: 10.00" • includes: high flow volume control cartridge • WMV130 series valve kit: sold separately 		WT691	663.00	Chrome	3
		WT691BN	914.95	Brushed Nickel	3
		WT691NL	914.95	Polished Nickel	3
		WT691BG	914.95	Brushed Gold	3
		WT691BL	962.15	Matte Black	3
		WT691ORB	1006.45	Oil Rubbed Bronze	3
ONE-HANDLE WALLMOUNT TUB FILLER VALVE KIT					
 <ul style="list-style-type: none"> • application: two hole with adj. center dimensions • ports: three • quarter turn stops: included • includes: test plug • includes: spout manifold 		WMV130CIS	154.05	1/2" CC/IPS	6
		WMV130XS	154.05	1/2" Crimp Ring PEX	6
		WMV130CXS	154.05	1/2" Cold Exp. PEX	6
HOW TO ORDER VALVES: PAGE 469	 TRIM PART #	+	 VALVE PART #	=	 COMPLETE FAUCET

TWO-HANDLE ROMAN TUB TRIM					
 <ul style="list-style-type: none"> • application: three hole • spout reach: 8.25" • valve: sold separately 		T693	512.75	Chrome	3
		T693BN	716.50	Brushed Nickel	3
		T693NL	716.50	Polished Nickel	3
		T693BG	716.50	Brushed Gold	3
		T693BL	743.55	Matte Black	3
		T693ORB	788.10	Oil Rubbed Bronze	3
TWO-HANDLE ROMAN TUB TRIM WITH HANDSHOWER					
 <ul style="list-style-type: none"> • application: four hole • showerhead type: handshower • handshower flow rate: 1.75 gpm (6.65 L/min) max. • spray functions: one-function • spout reach: 8.25" • valve: sold separately 		T694	798.70	Chrome	3
		T694BN	1314.80	Brushed Nickel	3
		T694NL	1314.80	Polished Nickel	3
		T694BG	1314.80	Brushed Gold	3
		T694BL	1357.75	Matte Black	3
		T694ORB	1446.20	Oil Rubbed Bronze	3
TWO-HANDLE ROMAN TUB VALVE					
 <ul style="list-style-type: none"> • deck thickness: 1/8" to 3-3/8" rough-in deck • adjustable spout shank: adjustable center dimensions  DURALAST®		4792	192.30	1/2" CC	6
	 <ul style="list-style-type: none"> • deck thickness: 1/8" to 2-3/4" rough-in deck • adjustable spout shank: 10" - 24" center dimensions  DURALOCK® DURALAST®		4793	217.80	1/2" CPVC, Crimp Ring PEX
		4794	207.65	1/2" Crimp Ring PEX, Cold Exp. PEX	6
 <ul style="list-style-type: none"> • deck thickness: 1/8" to 3-3/16" rough-in deck • Non-adjustable spout shank: 10" center dimensions  DURALAST®		4796	181.20	1/2" CC	6
		4797	184.70	1/2" CPVC, Crimp Ring PEX	6
		4798	184.70	1/2" Crimp Ring PEX, Cold Exp. PEX	6
TWO-HANDLE ROMAN TUB VALVE WITH HANDSHOWER					
 <ul style="list-style-type: none"> • deck thickness: 1/8" to 2-5/8" rough-in deck • non-adj spout shank: adjustable center dim's  DURALAST®		9792	433.35	1/2" CC	6
	 <ul style="list-style-type: none"> • deck thickness: 1/8" to 2-5/8" rough-in deck • adj spout shank: 10" - 24" center dimensions  DURALOCK® DURALAST®		9793	443.50	1/2" CPVC, Crimp Ring PEX
For more product details, reference page 470 in valve section.					
HOW TO ORDER VALVES: PAGE 470	 TRIM PART #	+	 VALVE PART #	=	 COMPLETE FAUCET





















VOSS™

		MODEL	LIST	FINISH/CONNECT	CASE QTY	
EXACTTEMP® VALVE ONLY TRIM						
 <ul style="list-style-type: none"> • description: temperature control valve trim • requires: separate volume control valve • valve: sold separately 		T4691	297.95	Chrome	3	
		T4691BN	448.75	Brushed Nickel	3	
		T4691NL	448.75	Polished Nickel	3	
		T4691BG	448.75	Brushed Gold	3	
		T4691BL	461.75	Matte Black	3	
		T4691ORB	484.05	Oil Rubbed Bronze	3	
EXACTTEMP® THERMOSTATIC MIXING SHOWER VALVE - PREMIUM						
 <ul style="list-style-type: none"> • description: thermostatic rough-in valve • ports: four with adjustable temp. limit stops • check stops: included 		S3371	728.95	¾" IPS	6	
HOW TO ORDER VALVES: PAGE 471		 TRIM PART #	+	 VALVE PART #	=	 COMPLETE FAUCET















EXACTTEMP® VOLUME CONTROL VALVE TRIM						
 <ul style="list-style-type: none"> • valve: sold separately 		T4692	151.25	Chrome	6	
		T4692BN	227.95	Brushed Nickel	6	
		T4692NL	227.95	Polished Nickel	6	
		T4692BG	227.95	Brushed Gold	6	
		T4692BL	234.45	Matte Black	6	
		T4692ORB	245.80	Oil Rubbed Bronze	6	
EXACTTEMP® VOLUME CONTROL SHOWER VALVE - PREMIUM						
 <ul style="list-style-type: none"> • includes: volume control 		S3600	185.35	¾" IPS	12	
HOW TO ORDER VALVES: PAGE 471		 TRIM PART #	+	 VALVE PART #	=	 COMPLETE FAUCET



VOSS™ Collection















		MODEL	LIST	FINISH/CONNECT	CASE QTY	
M-CORE® 4-SERIES TUB/SHOWER TRIM						
  	<ul style="list-style-type: none"> • showerhead: single-function eco-performance rainshower • showerhead size: 6" diameter • tub spout length: 7 15/16" • tub spout connection type: slip fit • tub spout type: diverter • includes: thermostatic cartridge with volume and temperature control • valve: sold separately 	1.75 GPM (6.65 L/min) max.				
		UT4693EP	635.30	Chrome	4	
		UT4693EPBN	966.90	Brushed Nickel	4	
		UT4693EPNL	966.90	Polished Nickel	4	
		UT4693EPBG	966.90	Brushed Gold	4	
		UT4693EPBL	983.60	Matte Black	4	
		UT4693EPORB	1035.05	Oil Rubbed Bronze	4	
M-CORE® 4-SERIES SHOWER ONLY TRIM						
 	<ul style="list-style-type: none"> • showerhead: single-function eco-performance rainshower • showerhead size: 6" diameter • includes: thermostatic cartridge with volume and temperature control • valve: sold separately 	1.75 GPM (6.65 L/min) max.				
		UT4692EP	543.15	Chrome	4	
		UT4692EPBN	819.00	Brushed Nickel	4	
		UT4692EPNL	819.00	Polished Nickel	4	
		UT4692EPBG	819.00	Brushed Gold	4	
		UT4692EPBL	826.90	Matte Black	4	
		UT4692EPORB	872.45	Oil Rubbed Bronze	4	
M-CORE® 4-SERIES VALVE ONLY TRIM						
	<ul style="list-style-type: none"> • includes: thermostatic cartridge with volume and temperature control • valve: sold separately 	UT4691	478.40	Chrome	3	
		UT4691BN	696.90	Brushed Nickel	3	
		UT4691NL	696.90	Polished Nickel	3	
		UT4691BG	696.90	Brushed Gold	3	
		UT4691BL	696.40	Matte Black	3	
		UT4691ORB	738.35	Oil Rubbed Bronze	3	
M-CORE® MIXING SHOWER VALVE						
	<ul style="list-style-type: none"> • tub/shower or shower only application • ports: four with adj. temp. limit stops • included: test plug and cross flow plug 	U140CI	72.60	1/2" CC/IPS	6	
		U140X	72.60	1/2" Crimp Ring PEX + CC/IPS Tub	6	
		U140CX	72.60	1/2" Cold Exp. PEX + CC/IPS Tub	6	
		U140V	88.95	1/2" CPVC + CC/IPS Tub	6	
	<ul style="list-style-type: none"> • tub/shower or shower only application • ports: four with adj. temp. limit stops • quarter turn stops: included 	U140CIS	104.50	1/2" CC/IPS	6	
		U140XS	104.50	1/2" Crimp Ring PEX + CC/IPS Tub	6	
		U140CXS	104.50	1/2" Cold Exp. PEX + CC/IPS Tub	6	
		U140VS	120.85	1/2" CPVC + CC/IPS Tub	6	
	<ul style="list-style-type: none"> • shower only application • ports: three 	U130CI	72.60	1/2" CC/IPS	6	
		U130X	72.60	1/2" Crimp Ring PEX	6	
		U130CX	72.60	1/2" Cold Exp. PEX	6	
	<ul style="list-style-type: none"> • shower only application • ports: three • quarter turn stops: included 	U130CIS	104.50	1/2" CC/IPS	6	
		U130XS	104.50	1/2" Crimp Ring PEX	6	
		U130CXS	104.50	1/2" Cold Exp. PEX	6	
<p>Four port valves can be used with either Tub/Shower or Shower Only applications. Three port valves can ONLY be used with Shower Only applications. For more product details, reference page 471 in valve section.</p>						
HOW TO ORDER VALVES: PAGE 471		 TRIM PART #	+	 VALVE PART #	=	 COMPLETE FAUCET











MODEL LIST FINISH/CONNECT CASE QTY











M-CORE® 3-SERIES TUB/SHOWER TRIM										
 <ul style="list-style-type: none"> • showerhead: single-function rainshower • showerhead size: 6" diameter • tub spout length: 7 15/16" • tub spout connection type: slip fit • tub spout type: diverter • includes: pressure balanced cartridge with volume and temperature control • valve: sold separately 	2.5 GPM (9.5 L/min) max.									
	UT3693	497.60	Chrome	4						
	UT3693BN	829.20	Brushed Nickel	4						
	UT3693NL	829.20	Polished Nickel	4						
	UT3693BG	829.20	Brushed Gold	4						
	UT3693BL	845.90	Matte Black	4						
	UT3693ORB	897.35	Oil Rubbed Bronze	4						
	1.75 GPM (6.65 L/min) max.									
	UT3693EP	497.60	Chrome	4						
	UT3693EPBN	829.20	Brushed Nickel	4						
UT3693EPNL	829.20	Polished Nickel	4							
UT3693EPBG	829.20	Brushed Gold	4							
UT3693EPBL	845.90	Matte Black	4							
UT3693EPORB	897.35	Oil Rubbed Bronze	4							
M-CORE® 3-SERIES SHOWER ONLY TRIM										
 <ul style="list-style-type: none"> • showerhead: single-function rainshower • showerhead size: 6" diameter • includes: pressure balanced cartridge with volume and temperature control • valve: sold separately 	2.5 GPM (9.5 L/min) max.									
	UT3692	405.45	Chrome	4						
	UT3692BN	681.30	Brushed Nickel	4						
	UT3692NL	681.30	Polished Nickel	4						
	UT3692BG	681.30	Brushed Gold	4						
	UT3692BL	689.20	Matte Black	4						
	UT3692ORB	734.75	Oil Rubbed Bronze	4						
	1.75 GPM (6.65 L/min) max.									
	UT3692EP	405.45	Chrome	4						
	UT3692EPBN	681.30	Brushed Nickel	4						
UT3692EPNL	681.30	Polished Nickel	4							
UT3692EPBG	681.30	Brushed Gold	4							
UT3692EPBL	689.20	Matte Black	4							
UT3692EPORB	734.75	Oil Rubbed Bronze	4							
M-CORE® MIXING SHOWER VALVE										
 <ul style="list-style-type: none"> • tub/shower or shower only application • ports: four with adj. temp. limit stops • included: test plug and cross flow plug 	U140CI	72.60	1/2" CC/IPS	6						
	U140X	72.60	1/2" Crimp Ring PEX + CC/IPS Tub	6						
	U140CX	72.60	1/2" Cold Exp. PEX + CC/IPS Tub	6						
	U140V	88.95	1/2" CPVC + CC/IPS Tub	6						
 <ul style="list-style-type: none"> • tub/shower or shower only application • ports: four with adj. temp. limit stops • quarter turn stops: included 	U140CIS	104.50	1/2" CC/IPS	6						
	U140XS	104.50	1/2" Crimp Ring PEX + CC/IPS Tub	6						
	U140CXS	104.50	1/2" Cold Exp. PEX + CC/IPS Tub	6						
	U140VS	120.85	1/2" CPVC + CC/IPS Tub	6						
 <ul style="list-style-type: none"> • shower only application • ports: three 	U130CI	72.60	1/2" CC/IPS	6						
	U130X	72.60	1/2" Crimp Ring PEX	6						
	U130CX	72.60	1/2" Cold Exp. PEX	6						
 <ul style="list-style-type: none"> • shower only application • ports: three • quarter turn stops: included 	U130CIS	104.50	1/2" CC/IPS	6						
	U130XS	104.50	1/2" Crimp Ring PEX	6						
	U130CXS	104.50	1/2" Cold Exp. PEX	6						
<p>Four port valves can be used with either Tub/Shower or Shower Only applications. Three port valves can ONLY be used with Shower Only applications. For more product details, reference page 471 in valve section.</p>										
<p>HOW TO ORDER VALVES: PAGE 471</p>		 <p>TRIM PART #</p>			<p>+</p>	 <p>VALVE PART #</p>		<p>=</p>	 <p>COMPLETE FAUCET</p>	

















VOSS™



















VOSS™ Collection

		MODEL	LIST	FINISH/CONNECT	CASE QTY
M-CORE® 3-SERIES VALVE ONLY TRIM					
 <ul style="list-style-type: none"> • includes: pressure balanced cartridge with volume and temperature control • valve: sold separately  		UT3691	340.70	Chrome	3
		UT3691BN	559.20	Brushed Nickel	3
		UT3691NL	559.20	Polished Nickel	3
		UT3691BG	559.20	Brushed Gold	3
		UT3691BL	562.10	Matte Black	3
		UT3691ORB	600.65	Oil Rubbed Bronze	3
M-CORE® MIXING SHOWER VALVE					
 <ul style="list-style-type: none"> • tub/shower or shower only application • ports: four with adj. temp. limit stops • included: test plug and cross flow plug 		U140CI	72.60	1/2" CC/IPS	6
		U140X	72.60	1/2" Crimp Ring PEX + CC/IPS Tub	6
		U140CX	72.60	1/2" Cold Exp. PEX + CC/IPS Tub	6
		U140V	88.95	1/2" CPVC + CC/IPS Tub	6
 <ul style="list-style-type: none"> • tub/shower or shower only application • ports: four with adj. temp. limit stops • quarter turn stops: included 		U140CIS	104.50	1/2" CC/IPS	6
		U140XS	104.50	1/2" Crimp Ring PEX + CC/IPS Tub	6
		U140CXS	104.50	1/2" Cold Exp. PEX + CC/IPS Tub	6
		U140VS	120.85	1/2" CPVC + CC/IPS Tub	6
 <ul style="list-style-type: none"> • shower only application • ports: three 		U130CI	72.60	1/2" CC/IPS	6
		U130X	72.60	1/2" Crimp Ring PEX	6
		U130CX	72.60	1/2" Cold Exp. PEX	6
 <ul style="list-style-type: none"> • shower only application • ports: three • quarter turn stops: included 		U130CIS	104.50	1/2" CC/IPS	6
		U130XS	104.50	1/2" Crimp Ring PEX	6
		U130CXS	104.50	1/2" Cold Exp. PEX	6
<p>Four port valves can be used with either Tub/Shower or Shower Only applications. Three port valves can ONLY be used with Shower Only applications. For more product details, reference page 471 in valve section.</p>					
<p>HOW TO ORDER VALVES: PAGE 471</p>		 <p>TRIM PART #</p> <p>+</p>  <p>VALVE PART #</p> <p>=</p>  <p>COMPLETE FAUCET</p>			

		MODEL	LIST	FINISH/CONNECT	CASE QTY			
M-CORE® 3-SERIES WITH INTEGRATED TRANSFER VALVE TRIM								
 <ul style="list-style-type: none"> • includes: pressure balanced cartridge with volume and temperature control • valve: sold separately  		UT3611	321.90	Chrome	4			
		UT3611BN	399.15	Brushed Nickel	4			
		UT3611NL	399.15	Polished Nickel	4			
		UT3611BG	399.15	Brushed Gold	4			
		UT3611BL	359.25	Matte Black	4			
		UT3611ORB	429.35	Oil Rubbed Bronze	4			
M-CORE® WITH INTEGRATED TRANSFER VALVE								
Three Function (2 independent/1 shared) OR Six Function (3 independent/3 shared) - plumbing configuration page 478								
 <ul style="list-style-type: none"> • ports: four with adj. temp. limit stops • check stops: included 		U362CIS	270.70	1/2" CC/IPS	6			
		U362CXS	270.70	1/2" Cold Exp. PEX	6			
		U362XS	270.70	1/2" Crimp Ring PEX	6			
Two Independent Functions OR Three Independent Functions - plumbing configurations page 478								
 <ul style="list-style-type: none"> • ports: four with adj. temp. limit stops • check stops: included 		U232CIS	270.70	1/2" CC/IPS	6			
		U232CXS	270.70	1/2" Cold Exp. PEX	6			
		U232XS	270.70	1/2" Crimp Ring PEX	6			
For more product details, reference page 472 in valve section. See page 478 for plumbing configurations.								
HOW TO ORDER VALVES: PAGE 472		TRIM PART #	+		VALVE PART #	=		COMPLETE FAUCET













M-CORE® TRANSFER VALVE TRIM								
 <ul style="list-style-type: none"> • use with the M-CORE® transfer valve • valve: sold separately  		UT4611	222.85	Chrome	12			
		UT4611BN	274.35	Brushed Nickel	12			
		UT4611NL	274.35	Polished Nickel	12			
		UT4611BG	274.35	Brushed Gold	12			
		UT4611BL	273.85	Matte Black	12			
		UT4611ORB	294.40	Oil Rubbed Bronze	12			
M-CORE® TRANSFER VALVE								
Three Function (2 independent/1 shared) OR Six Function (3 independent/3 shared) - plumbing configuration page 478								
 <ul style="list-style-type: none"> • number of functions: three or six • ports: four 		U361CI	152.70	1/2" CC/IPS	6			
		U361CX	152.70	1/2" Cold Exp. PEX	6			
		U361X	152.70	1/2" Crimp Ring PEX	6			
Two Independent Functions OR Three Independent Functions - plumbing configurations page 478								
 <ul style="list-style-type: none"> • number of functions: two or three • ports: four 		U231CI	152.70	1/2" CC/IPS	6			
		U231CX	152.70	1/2" Cold Exp. PEX	6			
		U231X	152.70	1/2" Crimp Ring PEX	6			
For more product details, reference page 472 in valve section. See page 478 for plumbing configurations.								
HOW TO ORDER VALVES: PAGE 472		TRIM PART #	+		VALVE PART #	=		COMPLETE FAUCET















		MODEL	LIST	FINISH/CONNECT	CASE QTY	
M-CORE® 2-SERIES TUB/SHOWER TRIM						
 <ul style="list-style-type: none"> • showerhead: single-function eco-performance • showerhead size: 4-1/16" diameter • tub spout length: 7 15/16" • tub spout connection type: slip fit • tub spout type: diverter • includes: pressure balanced cartridge with temperature control • valve: sold separately 		1.75 GPM (6.65 L/min) max.				
		UT2693EP	400.50	Chrome	3	
		UT2693EPBN	626.80	Brushed Nickel	3	
		UT2693EPNL	626.80	Polished Nickel	3	
		UT2693EPBG	626.80	Brushed Gold	3	
		UT2693EPBL	640.80	Matte Black	3	
		UT2693EPORB	677.45	Oil Rubbed Bronze	3	
M-CORE® 2-SERIES SHOWER ONLY TRIM						
 <ul style="list-style-type: none"> • showerhead: single-function eco-performance • showerhead size: 4-1/16" diameter • includes: pressure balanced cartridge with temperature control • valve: sold separately 		1.75 GPM (6.65 L/min) max.				
		UT2692EP	341.20	Chrome	12	
		UT2692EPBN	519.50	Brushed Nickel	12	
		UT2692EPNL	519.50	Polished Nickel	12	
		UT2692EPBG	519.50	Brushed Gold	12	
		UT2692EPBL	528.80	Matte Black	12	
		UT2692EPORB	559.00	Oil Rubbed Bronze	12	
M-CORE® 2-SERIES VALVE ONLY TRIM						
 <ul style="list-style-type: none"> • includes: pressure balanced cartridge with temperature control • valve: sold separately 		UT2691	286.80	Chrome	3	
		UT2691BN	420.15	Brushed Nickel	3	
		UT2691NL	420.15	Polished Nickel	3	
		UT2691BG	420.15	Brushed Gold	3	
		UT2691BL	418.50	Matte Black	3	
		UT2691ORB	449.85	Oil Rubbed Bronze	3	
	M-CORE® MIXING SHOWER VALVE					
 <ul style="list-style-type: none"> • tub/shower or shower only application • ports: four with adj. temp. limit stops • included: test plug and cross flow plug 		U140CI	72.60	1/2" CC/IPS	6	
		U140X	72.60	1/2" Crimp Ring PEX + CC/IPS Tub	6	
		U140CX	72.60	1/2" Cold Exp. PEX + CC/IPS Tub	6	
		U140V	88.95	1/2" CPVC + CC/IPS Tub	6	
	 <ul style="list-style-type: none"> • tub/shower or shower only application • ports: four with adj. temp. limit stops • quarter turn stops: included 		U140CIS	104.50	1/2" CC/IPS	6
		U140XS	104.50	1/2" Crimp Ring PEX + CC/IPS Tub	6	
		U140CXS	104.50	1/2" Cold Exp. PEX + CC/IPS Tub	6	
		U140VS	120.85	1/2" CPVC + CC/IPS Tub	6	
 <ul style="list-style-type: none"> • shower only application • ports: three 			U130CI	72.60	1/2" CC/IPS	6
		U130X	72.60	1/2" Crimp Ring PEX	6	
		U130CX	72.60	1/2" Cold Exp. PEX	6	
 <ul style="list-style-type: none"> • shower only application • ports: three • quarter turn stops: included 		U130CIS	104.50	1/2" CC/IPS	6	
		U130XS	104.50	1/2" Crimp Ring PEX	6	
		U130CXS	104.50	1/2" Cold Exp. PEX	6	
Four port valves can be used with either Tub/Shower or Shower Only applications. Three port valves can ONLY be used with Shower Only applications. For more product details, reference page 471 in valve section.						
HOW TO ORDER VALVES: PAGE 471		 TRIM PART #	+	 VALVE PART #	=	 COMPLETE FAUCET

		MODEL	LIST	FINISH/CONNECT	CASE QTY
POSI-TEMP® TUB/SHOWER TRIM					
 <ul style="list-style-type: none"> • showerhead: single-function standard • showerhead size: 4-1/16" diameter • tub spout length: 7 15/16" • tub spout connection type: slip fit • tub spout type: diverter • valve: sold separately 		2.5 GPM (9.5 L/min) max.			
		T2693	277.05	Chrome	3
		T2693BN	503.35	Brushed Nickel	3
		T2693NL	503.35	Polished Nickel	3
		T2693BG	503.35	Brushed Gold	3
		T2693BL	512.50	Matte Black	3
		T2693ORB	553.95	Oil Rubbed Bronze	3
		1.75 GPM (6.65 L/min) max.			
		T2693EP	277.05	Chrome	3
		T2693EPBN	503.35	Brushed Nickel	3
		T2693EPNL	503.35	Polished Nickel	3
		T2693EPBG	503.35	Brushed Gold	3
		T2693EPBL	512.50	Matte Black	3
		T2693EPORB	553.95	Oil Rubbed Bronze	3
 <ul style="list-style-type: none"> • showerhead type: showerhead sold separately • tub spout length: 7 15/16" • tub spout connection type: slip fit • tub spout type: diverter • valve: sold separately 		T2693NH	186.55	Chrome	3
		T2693NHBN	364.75	Brushed Nickel	3
	POSI-TEMP® SHOWER ONLY TRIM				
 <ul style="list-style-type: none"> • showerhead: single-function standard • showerhead size: 4-1/16" diameter • valve: sold separately 		2.5 GPM (9.5 L/min) max.			
		T2692	217.70	Chrome	3
		T2692BN	396.00	Brushed Nickel	3
		T2692NL	396.00	Polished Nickel	3
		T2692BG	396.00	Brushed Gold	3
		T2692BL	402.75	Matte Black	3
		T2692ORB	435.55	Oil Rubbed Bronze	3
		1.75 GPM (6.65 L/min) max.			
		T2692EP	217.70	Chrome	3
		T2692EPBN	396.00	Brushed Nickel	3
		T2692EPNL	396.00	Polished Nickel	3
		T2692EPBG	396.00	Brushed Gold	3
		T2692EPBL	402.75	Matte Black	3
		T2692EPORB	435.55	Oil Rubbed Bronze	3
 <ul style="list-style-type: none"> • showerhead type: showerhead sold separately • valve: sold separately 		T2692NH	173.20	Chrome	3
		T2692NHBN	314.55	Brushed Nickel	3
POSI-TEMP® SHOWER MIXING VALVES					
 <ul style="list-style-type: none"> • tub/shower or shower only application • ports: four with adjustable temp. limit stops • test plug: included 		2520 ◆	159.20	1/2" CC	6
		2510 ◆	159.20	1/2" IPS	6
 <ul style="list-style-type: none"> • tub/shower or shower only application • ports: four with adjustable temp. limit stops • quarter turn stops: included • test plug: included 		2570 ◆	193.35	1/2" CC	6
		2590 ◆	193.35	1/2" IPS	6
		2580 ◆	159.20	1/2" Crimp ring PEX	6
 <ul style="list-style-type: none"> • tub/shower only application • ports: four with adjustable temp. limit stops • quarter turn stops: included • test plug: included 		2360PF	212.60	1/2" Crimp Ring PEX	3
 <ul style="list-style-type: none"> • shower only application • ports: three with adjustable temp. limit stops • quarter turn stops: included • test plug: included 		2326PF	205.20	1/2" Crimp Ring PEX	6
		2328PF	205.20	1/2" Cold Exp. PEX	6
<p>Four port valves can be used with either Tub/Shower or Shower Only applications. Three port valves can ONLY be used with Shower Only applications. For more product details, reference page 473-476 in valve section.</p>					
<p>HOW TO ORDER VALVES: PAGES 473-476</p>		 TRIM PART # +  VALVE PART # =  COMPLETE FAUCET			



VOSS™ Collection

		MODEL	LIST	FINISH/CONNECT	CASE QTY	
POSI-TEMP® VALVE ONLY TRIM						
 <ul style="list-style-type: none"> • valve: sold separately 	 	T2691	163.35	Chrome	3	
		T2691BN	296.65	Brushed Nickel	3	
		T2691NL	296.65	Polished Nickel	3	
		T2691BG	296.65	Brushed Gold	3	
		T2691BL	303.65	Matte Black	3	
		T2691ORB	326.45	Oil Rubbed Bronze	3	
POSI-TEMP® SHOWER MIXING VALVES						
 <ul style="list-style-type: none"> • tub/shower or shower only application • ports: four with adjustable temp. limit stops • test plug: included 		2520 ◆	159.20	1/2" CC	6	
		2510 ◆	159.20	1/2" IPS	6	
 <ul style="list-style-type: none"> • tub/shower or shower only application • ports: four with adjustable temp. limit stops • quarter turn stops: included • test plug: included 		2570 ◆	193.35	1/2" CC	6	
		2590 ◆	193.35	1/2" IPS	6	
		2580 ◆	159.20	1/2" Crimp ring PEX	6	
 <ul style="list-style-type: none"> • tub/shower only application • ports: four with adjustable temp. limit stops • quarter turn stops: included • test plug: included 		2360PF	212.60	1/2" Crimp Ring PEX	3	
 <ul style="list-style-type: none"> • shower only application • ports: three with adjustable temp. limit stops • quarter turn stops: included • test plug: included 		2326PF	205.20	1/2" Crimp Ring PEX	6	
	2328PF	205.20	1/2" Cold Exp. PEX	6		
Four port valves can be used with either Tub/Shower or Shower Only applications. Three port valves can ONLY be used with Shower Only applications. For more product details, reference page 473-476 in valve section.						
HOW TO ORDER VALVES: PAGES 473-476		 TRIM PART #	+	 VALVE PART #	=	 COMPLETE FAUCET

POSI-TEMP® WITH INTEGRATED TRANSFER VALVE TRIM						
 <ul style="list-style-type: none"> • valve: sold separately 	 	T2690	295.00	Chrome	4	
		T2690BN	535.60	Brushed Nickel	4	
		T2690NL	535.60	Polished Nickel	4	
		T2690BG	535.60	Brushed Gold	4	
		T2690BL	545.65	Matte Black	4	
		T2690ORB	589.15	Oil Rubbed Bronze	4	
POSI-TEMP® WITH INTEGRATED TRANSFER VALVE						
 <ul style="list-style-type: none"> • functions: three (two independent and one shared) • ports: four with adjustable temp. limit stops • test plug: included 		2551	287.50	1/2" IPS	6	
 <ul style="list-style-type: none"> • functions: three (two independent and one shared) • ports: four with adjustable temp. limit stops • stops: included • test plug: included 		2581	323.75	1/2" IPS	6	
 <ul style="list-style-type: none"> • functions: two independent • ports: four with adjustable temp. limit stops • test plug: included 		2521	287.50	1/2" IPS	6	
 <ul style="list-style-type: none"> • functions: two independent • ports: four with adjustable temp. limit stops • stops: included • test plug: included 		2571	323.75	1/2" IPS	6	
For more product details, reference page 477 in valve section.						
HOW TO ORDER VALVES: PAGE 477		 TRIM PART #	+	 VALVE PART #	=	 COMPLETE FAUCET

Moen® bath accessories CANNOT be combined with Moen faucet parts on a Purchase Order.

A line of matching accessories - including tank levers and towel bars - allow for a completely cohesive look in the bath.

MODEL NUMBER	LIST EACH	DESCRIPTION	QTY
Chrome (CH)			
YB5101CH	46.10	Tank Lever	24
YB5103CH	35.50	Double Robe Hook	24
Ⓢ YB5108CH	64.75	Pivoting Paper Holder	6
YB5118CH	75.10	18" Towel Bar	6
YB5124CH	77.55	24" Towel Bar	6
YB5186CH	52.75	Towel Ring	6
Brushed Nickel (BN)			
YB5101BN	50.90	Tank Lever	24
YB5103BN	39.05	Double Robe Hook	24
Ⓢ YB5108BN	71.65	Pivoting Paper Holder	6
YB5118BN	82.65	18" Towel Bar	6
YB5124BN	85.60	24" Towel Bar	6
YB5186BN	57.75	Towel Ring	6
Matte Black (BL)			
YB5101BL	55.90	Tank Lever	24
YB5103BL	42.85	Double Robe Hook	24
Ⓢ YB5108BL	78.90	Pivoting Paper Holder	6
YB5118BL	90.90	18" Towel Bar	6
YB5124BL	94.25	24" Towel Bar	6
YB5186BL	62.90	Towel Ring	6
Polished Nickel (NL)			
YB5101NL	55.80	Tank Lever	24
YB5103NL	42.90	Double Robe Hook	24
Ⓢ YB5108NL	84.25	Pivoting Paper Holder	6
YB5118NL	91.05	18" Towel Bar	6
YB5124NL	96.15	24" Towel Bar	6
YB5186NL	63.95	Towel Ring	6
Brushed Gold (BG)			
YB5101BG	61.05	Tank Lever	24
YB5103BG	46.85	Double Robe Hook	24
Ⓢ YB5108BG	103.90	Pivoting Paper Holder	6
YB5118BG	115.70	18" Towel Bar	6
YB5124BG	119.75	24" Towel Bar	6
YB5186BG	83.60	Towel Ring	6
Oil Rubbed Bronze (ORB)			
YB5101ORB	55.90	Tank Lever	24
YB5103ORB	39.70	Double Robe Hook	24
Ⓢ YB5108ORB	73.05	Pivoting Paper Holder	6
YB5118ORB	84.15	18" Towel Bar	6
YB5124ORB	94.25	24" Towel Bar	6
YB5186ORB	58.80	Towel Ring	6

Ⓢ Denotes pivoting paper holder



Tank Lever
YB5101



Double Robe Hook
YB5103



Towel Ring
YB5186



Pivoting Paper Holder
YB5108 | Ⓢ



18" Towel Bar
YB5118

24" Towel Bar
YB5124





GRAB BARS

MODEL NUMBER	LIST EACH	DESCRIPTION	QTY
1 1/4" • Chrome (CH)			
YG5112CH	123.55	12" Designer Grab Bar	6
YG5118CH	129.10	18" Designer Grab Bar	6
YG5124CH	134.90	24" Designer Grab Bar	6
1 1/4" • Brushed Nickel (BN)			
YG5112BN	152.00	12" Designer Grab Bar	6
YG5118BN	158.80	18" Designer Grab Bar	6
YG5124BN	168.65	24" Designer Grab Bar	6
1 1/4" • Matte Black (BL)			
YG5112BL	160.60	12" Designer Grab Bar	6
YG5118BL	167.85	18" Designer Grab Bar	6
YG5124BL	175.40	24" Designer Grab Bar	6
1 1/4" • Polished Nickel (NL)			
YG5112NL	166.80	12" Designer Grab Bar	6
YG5118NL	174.30	18" Designer Grab Bar	6
YG5124NL	182.15	24" Designer Grab Bar	6
1 1/4" • Brushed Gold (BG)			
YG5112BG	179.15	12" Designer Grab Bar	6
YG5118BG	187.20	18" Designer Grab Bar	6
YG5124BG	195.60	24" Designer Grab Bar	6
1 1/4" • Oil Rubbed Bronze (ORB)			
YG5112ORB	169.25	12" Designer Grab Bar	6
YG5118ORB	176.85	18" Designer Grab Bar	6
YG5124ORB	186.15	24" Designer Grab Bar	6

SECUREMOUNT™

- SecureMount™ Grab Bars are manufactured with an innovative flange design that makes it easy to connect to the stud at multiple points.
- Tested to withstand 500lbs.
- To install grab bars securely without studs, use SecureMount™ Anchors. Sold separately.



18" Designer Grab Bar

YG5118

 Complies with Americans with Disabilities Act (ADA) specifications. SecureMount™ Grab Bars are tested to withstand 500 lb. pull when securely installed per instructions.

List price is per each (unless otherwise noted). Product can be ordered by case quantity or individually.

















LIGHTING

MODEL NUMBER	LIST EACH	DESCRIPTION	QTY
Chrome (CH)			
YB5161CH	180.65	One Globe Bath Light	2
YB5162CH	252.75	Two Globe Bath Light	2
YB5163CH	313.95	Three Globe Bath Light	2
YB5164CH	402.00	Four Globe Bath Light	2
Brushed Nickel (BN)			
YB5161BN	225.90	One Globe Bath Light	2
YB5162BN	315.95	Two Globe Bath Light	2
YB5163BN	392.40	Three Globe Bath Light	2
YB5164BN	502.50	Four Globe Bath Light	2
Matte Black (BL)			
YB5161BL	225.90	One Globe Bath Light	2
YB5162BL	315.95	Two Globe Bath Light	2
YB5163BL	392.40	Three Globe Bath Light	2
YB5164BL	502.50	Four Globe Bath Light	2
Polished Nickel (NL)			
YB5161NL	226.00	One Globe Bath Light	2
YB5162NL	329.00	Two Globe Bath Light	2
YB5163NL	424.20	Three Globe Bath Light	2
YB5164NL	543.30	Four Globe Bath Light	2
Brushed Gold (BG)			
YB5161BG	271.10	One Globe Bath Light	2
YB5162BG	379.15	Two Globe Bath Light	2
YB5163BG	470.95	Three Globe Bath Light	2
YB5164BG	602.95	Four Globe Bath Light	2
Oil Rubbed Bronze (ORB)			
YB5161ORB	225.90	One Globe Bath Light	2
YB5162ORB	315.95	Two Globe Bath Light	2
YB5163ORB	392.40	Three Globe Bath Light	2
YB5164ORB	502.50	Four Globe Bath Light	2
Replacement Globe			
YB5169	33.10	Replacement Globe	3



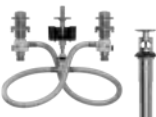





















Bulbs not included.
List price is per each (unless otherwise noted).
Product can be ordered by case quantity or individually.
All Voss™ lighting fixtures can be mounted facing either upward or downward.

DARTMOOR® Collection









		MODEL	LIST	FINISH/CONNECT	CASE QTY
ONE-HANDLE BATHROOM FAUCET					
 <p>DECKPLATE INCLUDED</p> 	<ul style="list-style-type: none"> • application: one or three hole • supply lines: flexible • connection: 3/8" compression • deckplate: included • drain assembly: metal with lift rod <p> DURALAST®</p>	1.2 GPM (4.5L/min) max.			
		6803	306.60	Chrome	3
		6803BN	398.60	Brushed Nickel	3
		6803BL	413.95	Matte Black	3
		6803ORB	429.25	Oil Rubbed Bronze	3
TWO-HANDLE CENTERSET BATHROOM FAUCET					
	<ul style="list-style-type: none"> • application: three hole • center dimensions: 4" center • connection: 1/2" IPS • drain assembly: metal with lift rod <p> DURALAST®</p>	1.2 GPM (4.5L/min) max.			
		6802	220.75	Chrome	3
		6802BN	298.00	Brushed Nickel	3
		6802BL	309.05	Matte Black	3
		6802ORB	320.10	Oil Rubbed Bronze	3
TWO-HANDLE WIDESPREAD BATHROOM FAUCET					
<p>NEW! Q2</p> 	<ul style="list-style-type: none"> • application: three hole • center dimensions: 8" - 16" center • drain assembly: metal with lift rod • includes: 9000 valve <p> DURALOCK® DURALAST®</p>	1.2 GPM (4.5L/min) max.			
		TV6805	364.95	Chrome	3
		TV6805BL	474.00	Matte Black	3
		TV6805BN	452.20	Brushed Nickel	3
		TV6805ORB	484.95	Oil Rubbed Bronze	3
TWO-HANDLE WIDESPREAD BATHROOM FAUCET TRIM					
	<ul style="list-style-type: none"> • application: three hole • center dimensions: 8" - 16" center • drain assembly: metal with lift rod • valve: sold separately <p> </p>	1.2 GPM (4.5L/min) max.			
		T6805	218.15	Chrome	3
		T6805BN	305.40	Brushed Nickel	3
		T6805BL	327.20	Matte Black	3
		T6805ORB	338.15	Oil Rubbed Bronze	3
WIDESPREAD FAUCET VALVE					
	<ul style="list-style-type: none"> • application: three hole • center dimensions: 8" - 16" center • drain assembly: metal with lift rod <p> DURALOCK® DURALAST®</p>	9000◆	165.40	1/2" IPS	6
HOW TO ORDER					
VALVES: PAGE 469		 TRIM PART # +  VALVE PART # =  COMPLETE FAUCET			















DARTMOOR® Collection

		MODEL	LIST	FINISH/CONNECT	CASE QTY
ONE-HANDLE WALLMOUNT TUB FILLER TRIM					
 <ul style="list-style-type: none"> • application: two hole • connection: 1/2" slip fit • tub spout type: non diverter • spout reach: 10.00" • includes: high flow volume control cartridge • WMV130 series valve kit: sold separately 		WT681	443.70	Chrome	3
		WT681BN	585.70	Brushed Nickel	3
		WT681BL	644.25	Matte Black	3
		WT681ORB	644.25	Oil Rubbed Bronze	3
ONE-HANDLE WALLMOUNT TUB FILLER VALVE KIT					
 <ul style="list-style-type: none"> • application: two hole with adj. center dimensions • ports: three • quarter turn stops: included • includes: test plug • includes: spout manifold 		WMV130CIS	154.05	1/2" CC/IPS	6
		WMV130XS	154.05	1/2" Crimp Ring PEX	6
		WMV130CXS	154.05	1/2" Cold Exp. PEX	6
HOW TO ORDER VALVES: PAGE 469	 TRIM PART #   VALVE PART #   COMPLETE FAUCET				

TWO-HANDLE ROMAN TUB TRIM					
 <ul style="list-style-type: none"> • application: three hole • spout reach: 7.64" • valve: sold separately 		T683	355.95	Chrome	3
		T683BN	532.55	Brushed Nickel	3
		T683BL	585.90	Matte Black	3
		T683ORB	585.90	Oil Rubbed Bronze	3
TWO-HANDLE ROMAN TUB VALVE					
 <ul style="list-style-type: none"> • deck thickness: 1/8" to 3-3/8" rough-in deck • adjustable spout shank: adjustable center dimensions  DURALAST®		4792	192.30	1/2" CC	6
 <ul style="list-style-type: none"> • deck thickness: 1/8" to 2-3/4" rough-in deck • adjustable spout shank: 10" - 24" center dimensions  DURALOCK® DURALAST®		4793	217.80	1/2" CPVC, Crimp Ring PEX	6
		4794	207.65	1/2" Crimp Ring PEX, Cold Exp. PEX	6
 <ul style="list-style-type: none"> • deck thickness: 1/8" to 3-3/16" rough-in deck • Non-adjustable spout shank: 10" center dimensions  DURALAST®		4796	181.20	1/2" CC	6
		4797	184.70	1/2" CPVC, Crimp Ring PEX	6
		4798	184.70	1/2" Crimp Ring PEX, Cold Exp. PEX	6
For more product details, reference page 470 in valve section.					
HOW TO ORDER VALVES: PAGE 470	 TRIM PART #   VALVE PART #   COMPLETE FAUCET				





















DARTMOOR® Collection

		MODEL	LIST	FINISH/CONNECT	CASE QTY		
M-CORE® TRANSFER VALVE TRIM							
 <ul style="list-style-type: none"> • use with the M-CORE® transfer valve • valve: sold separately 		UT2031	192.35	Chrome	12		
		UT2031BN	233.65	Brushed Nickel	12		
		UT2031BL	249.70	Matte Black	12		
		UT2031ORB	249.70	Oil Rubbed Bronze	12		
M-CORE® TRANSFER VALVE							
Three Function (2 independent/1 shared) OR Six Function (3 independent/3 shared) - plumbing configuration page 478							
 <ul style="list-style-type: none"> • number of functions: three or six • ports: four 		U361CI	152.70	1/2" CC/IPS	6		
		U361CX	152.70	1/2" Cold Exp. PEX	6		
		U361X	152.70	1/2" Crimp Ring PEX	6		
Two Independent Functions OR Three Independent Functions - plumbing configurations page 478							
 <ul style="list-style-type: none"> • number of functions: two or three • ports: four 		U231CI	152.70	1/2" CC/IPS	6		
		U231CX	152.70	1/2" Cold Exp. PEX	6		
		U231X	152.70	1/2" Crimp Ring PEX	6		
For more product details, reference page 472 in valve section. See page 478 for plumbing configurations.							
HOW TO ORDER VALVES: PAGE 472		TRIM PART #	+		=		COMPLETE FAUCET

M-CORE® 2-SERIES TUB/SHOWER TRIM							
 <ul style="list-style-type: none"> • single-function eco-performance rainshower • showerhead size: 8" diameter • tub spout length: 7" • tub spout connection type: slip fit • tub spout type: diverter • includes: pressure balanced cartridge with temperature control • valve: sold separately 		1.75 GPM (6.65 L/min) max.					
		UT2283EP	313.20	Chrome	4		
		UT2283EPBN	441.95	Brushed Nickel	4		
		UT2283EPBL	468.45	Matte Black	4		
UT2283EPORB	468.45	Oil Rubbed Bronze	4				
 <ul style="list-style-type: none"> • single-function eco-performance • showerhead size: 4" diameter • tub spout length: 7" • tub spout connection type: slip fit • tub spout type: diverter • includes: pressure balanced cartridge with temperature control • valve: sold separately 		1.75 GPM (6.65 L/min) max.					
		UT2183EP	230.25	Chrome	12		
		UT2183EPBN	392.70	Brushed Nickel	12		
		UT2183EPBL	419.80	Matte Black	12		
UT2183EPORB	419.80	Oil Rubbed Bronze	12				
M-CORE® MIXING SHOWER VALVE							
 <ul style="list-style-type: none"> • tub/shower or shower only application • ports: four with adj. temp. limit stops • included: test plug and cross flow plug 		U140CI	72.60	1/2" CC/IPS	6		
		U140X	72.60	1/2" Crimp Ring PEX + CC/IPS Tub	6		
		U140CX	72.60	1/2" Cold Exp. PEX + CC/IPS Tub	6		
		U140V	88.95	1/2" CPVC + CC/IPS Tub	6		
 <ul style="list-style-type: none"> • tub/shower or shower only application • ports: four with adj. temp. limit stops • quarter turn stops: included 		U140CIS	104.50	1/2" CC/IPS	6		
		U140XS	104.50	1/2" Crimp Ring PEX + CC/IPS Tub	6		
		U140CXS	104.50	1/2" Cold Exp. PEX + CC/IPS Tub	6		
		U140VS	120.85	1/2" CPVC + CC/IPS Tub	6		
 <ul style="list-style-type: none"> • shower only application • ports: three 		U130CI	72.60	1/2" CC/IPS	6		
		U130X	72.60	1/2" Crimp Ring PEX	6		
		U130CX	72.60	1/2" Cold Exp. PEX	6		
 <ul style="list-style-type: none"> • shower only application • ports: three • quarter turn stops: included 		U130CIS	104.50	1/2" CC/IPS	6		
		U130XS	104.50	1/2" Crimp Ring PEX	6		
		U130CXS	104.50	1/2" Cold Exp. PEX	6		
Four port valves can be used with either Tub/Shower or Shower Only applications. Three port valves can ONLY be used with Shower Only applications. For more product details, reference page 471 in valve section.							
HOW TO ORDER VALVES: PAGE 471		TRIM PART #	+		=		COMPLETE FAUCET

DARTMOOR®

DARTMOOR® Collection

		MODEL	LIST	FINISH/CONNECT	CASE QTY				
M-CORE® 2-SERIES SHOWER ONLY TRIM									
   	<ul style="list-style-type: none"> • showerhead: single-function eco-performance rainshower • showerhead size: 8" diameter • includes: pressure balanced cartridge with temperature control • valve: sold separately 	1.75 GPM (6.65 L/min) max.							
			UT2282EP	270.75	Chrome	4			
			UT2282EPBN	378.00	Brushed Nickel	4			
			UT2282EPBL	397.90	Matte Black	4			
			UT2282EPORB	397.90	Oil Rubbed Bronze	4			
  	<ul style="list-style-type: none"> • showerhead: single-function eco-performance • showerhead size: 4" diameter • includes: pressure balanced cartridge with temperature control • valve: sold separately 	1.75 GPM (6.65 L/min) max.							
			UT2182EP	190.30	Chrome	12			
			UT2182EPBN	327.40	Brushed Nickel	12			
			UT2182EPBL	347.80	Matte Black	12			
			UT2182EPORB	347.80	Oil Rubbed Bronze	12			
M-CORE® 2-SERIES VALVE ONLY TRIM									
  	<ul style="list-style-type: none"> • includes: pressure balanced cartridge with temperature control • valve: sold separately 	UT2181	181.30	Chrome	3				
			UT2181BN	288.35	Brushed Nickel	3			
			UT2181BL	304.85	Matte Black	3			
			UT2181ORB	304.85	Oil Rubbed Bronze	3			
		M-CORE® MIXING SHOWER VALVE							
 	<ul style="list-style-type: none"> • tub/shower or shower only application • ports: four with adj. temp. limit stops • included: test plug and cross flow plug 	U140CI	72.60	1/2" CC/IPS	6				
			U140X	72.60	1/2" Crimp Ring PEX + CC/IPS Tub	6			
			U140CX	72.60	1/2" Cold Exp. PEX + CC/IPS Tub	6			
			U140V	88.95	1/2" CPVC + CC/IPS Tub	6			
		 	<ul style="list-style-type: none"> • tub/shower or shower only application • ports: four with adj. temp. limit stops • quarter turn stops: included 	U140CIS	104.50	1/2" CC/IPS	6		
	U140XS			104.50	1/2" Crimp Ring PEX + CC/IPS Tub	6			
	U140CXS			104.50	1/2" Cold Exp. PEX + CC/IPS Tub	6			
	U140VS			120.85	1/2" CPVC + CC/IPS Tub	6			
 	<ul style="list-style-type: none"> • shower only application • ports: three 			U130CI	72.60	1/2" CC/IPS	6		
			U130X	72.60	1/2" Crimp Ring PEX	6			
			U130CX	72.60	1/2" Cold Exp. PEX	6			
 	<ul style="list-style-type: none"> • shower only application • ports: three • quarter turn stops: included 	U130CIS	104.50	1/2" CC/IPS	6				
			U130XS	104.50	1/2" Crimp Ring PEX	6			
			U130CXS	104.50	1/2" Cold Exp. PEX	6			
<p>Four port valves can be used with either Tub/Shower or Shower Only applications. Three port valves can ONLY be used with Shower Only applications. For more product details, reference page 471 in valve section.</p>									
<p>HOW TO ORDER VALVES: PAGE 471</p>			<p>TRIM PART #</p>	+		<p>VALVE PART #</p>	=		<p>COMPLETE FAUCET</p>



DARTMOOR® Collection

		MODEL	LIST	FINISH/CONNECT	CASE QTY	
POSI-TEMP® TUB/SHOWER TRIM						
	<ul style="list-style-type: none"> • showerhead: single-function eco-performance rainshower • showerhead size: 8" diameter • tub spout length: 7" • tub spout connection type: slip fit • tub spout type: diverter • valve: sold separately 	1.75 GPM (6.65 L/min) max.				
		T2283EP	190.60	Chrome	4	
		T2283EPBN	319.35	Brushed Nickel	4	
		T2283EPBL	345.85	Matte Black	4	
		T2283EPORB	345.85	Oil Rubbed Bronze	4	
	<ul style="list-style-type: none"> • showerhead: single-function standard • showerhead size: 4" diameter • tub spout length: 7" • tub spout connection type: slip fit • tub spout type: diverter • valve: sold separately 	2.5 GPM (9.5 L/min) max.				
		T2183◆	138.50	Chrome	3	
		T2183BN	270.20	Brushed Nickel	3	
		T2183BL	297.25	Matte Black	3	
		T2183ORB	297.25	Oil Rubbed Bronze	3	
		1.75 GPM (6.65 L/min) max.				
		T2183EP	118.95	Chrome	3	
		T2183EPBN	270.20	Brushed Nickel	3	
		T2183EPBL	297.25	Matte Black	3	
T2183EPORB	297.25	Oil Rubbed Bronze	3			
POSI-TEMP® SHOWER ONLY TRIM						
	<ul style="list-style-type: none"> • showerhead: single-function eco-performance rainshower • showerhead size: 8" diameter • valve: sold separately 	1.75 GPM (6.65 L/min) max.				
		T2282EP	148.15	Chrome	4	
		T2282EPBN	255.45	Brushed Nickel	4	
		T2282EPBL	275.40	Matte Black	4	
		T2282EPORB	275.40	Oil Rubbed Bronze	4	
	<ul style="list-style-type: none"> • showerhead: single-function standard • showerhead size: 4" diameter • valve: sold separately 	2.5 GPM (9.5 L/min) max.				
		T2182◆	95.20	Chrome	3	
		T2182BN	204.85	Brushed Nickel	3	
		T2182BL	225.25	Matte Black	3	
		T2182ORB	225.25	Oil Rubbed Bronze	3	
		1.75 GPM (6.65 L/min) max.				
		T2182EP	78.95	Chrome	3	
		T2182EPBN	204.85	Brushed Nickel	3	
		T2182EPBL	225.25	Matte Black	3	
T2182EPORB	225.25	Oil Rubbed Bronze	3			
POSI-TEMP® VALVE ONLY TRIM						
	<ul style="list-style-type: none"> • valve: sold separately 	T2181	72.55	Chrome	3	
		T2181BN	165.80	Brushed Nickel	3	
		T2181BL	182.25	Matte Black	3	
		T2181ORB	182.25	Oil Rubbed Bronze	3	
		POSI-TEMP® SHOWER MIXING VALVES				
	<ul style="list-style-type: none"> • tub/shower or shower only application • ports: four with adjustable temp. limit stops • test plug: included 	2520◆	159.20	1/2" CC	6	
		2510◆	159.20	1/2" IPS	6	
			<ul style="list-style-type: none"> • tub/shower or shower only application • ports: four with adjustable temp. limit stops • quarter turn stops: included • test plug: included 	2570◆	193.35	1/2" CC
2590◆	193.35			1/2" IPS	6	
2580◆	159.20			1/2" Crimp ring PEX	6	
	<ul style="list-style-type: none"> • tub/shower only application • ports: four with adjustable temp. limit stops • quarter turn stops: included • test plug: included 	2360PF	212.60	1/2" Crimp Ring PEX	3	
			<ul style="list-style-type: none"> • shower only application • ports: three with adjustable temp. limit stops • quarter turn stops: included • test plug: included 	2326PF	205.20	1/2" Crimp Ring PEX
				2328PF	205.20	1/2" Cold Exp. PEX
<p>Four port valves can be used with either Tub/Shower or Shower Only applications. Three port valves can ONLY be used with Shower Only applications. For more product details, reference page 473-476 in valve section.</p>						
<p>HOW TO ORDER VALVES: PAGES 473-476</p>		<p>TRIM PART #</p>	+	<p>VALVE PART #</p>	=	<p>COMPLETE FAUCET</p>

DARTMOOR®

Moen® bath accessories CANNOT be combined with Moen faucet parts on a Purchase Order.

A line of matching accessories - including tank levers and towel bars - allow for a completely cohesive look in the bath.

MODEL NUMBER	LIST EACH	DESCRIPTION	QTY
Chrome (CH)			
YB2101CH	25.50	Tank Lever	24
YB2103CH	18.90	Double Robe Hook	24
YB2108CH	33.25	Paper Holder	6
YB2118CH	41.50	18" Towel Bar	6
YB2124CH	43.55	24" Towel Bar	6
YB2186CH	25.95	Towel Ring	6
Brushed Nickel (BN)			
YB2101BN	40.90	Tank Lever	24
YB2103BN	23.60	Double Robe Hook	24
YB2108BN	41.55	Paper Holder	6
YB2118BN	51.85	18" Towel Bar	6
YB2124BN	54.45	24" Towel Bar	6
YB2186BN	32.40	Towel Ring	6
Matte Black (BL)			
YB2101BL	45.05	Tank Lever	24
YB2103BL	24.55	Double Robe Hook	24
YB2108BL	43.20	Paper Holder	6
YB2118BL	53.95	18" Towel Bar	6
YB2124BL	56.65	24" Towel Bar	6
YB2186BL	33.70	Towel Ring	6
Oil Rubbed Bronze (ORB)			
YB2101ORB	45.05	Tank Lever	24
YB2103ORB	26.45	Double Robe Hook	24
YB2108ORB	46.55	Paper Holder	6
YB2118ORB	58.10	18" Towel Bar	6
YB2124ORB	61.00	24" Towel Bar	6
YB2186ORB	36.30	Towel Ring	6
Pro-Fit® Installation Mounting Template			
YB8081	15.20	Pro-Fit® Installation Mounting Template	25



Tank Lever

YB2101



Double Robe Hook

YB2103



Towel Ring

YB2186



Paper Holder

YB2108



18" Towel Bar

YB2118

24" Towel Bar

YB2124



Pro-Fit® Installation Mounting Template

YB8081

(See page 528 for more information about the Pro-Fit® Installation System.)

PRODUCT DETAILS















5/8" Round Bar







30" towel bar options also available in select finishes.











See page 511 for details.

List price is per each (unless otherwise noted).
Product can be ordered by case quantity or individually.











GLYDE™ Collection





















		MODEL	LIST	FINISH/CONNECT	CASE QTY
ONE-HANDLE BATHROOM FAUCET					
 <p>DECKPLATE INCLUDED</p> 	<ul style="list-style-type: none"> • application: one or three hole • supply lines: flexible • connection: 3/8" compression • deckplate: included • drain assembly: metal with lift rod <p> DURALAST®</p>	1.2 GPM (4.5L/min) max.			
		6170	306.60	Chrome	3
		6170BN	398.60	Brushed Nickel	3
		6170BL	413.95	Matte Black	3
TWO-HANDLE CENTERSET BATHROOM FAUCET					
	<ul style="list-style-type: none"> • application: three hole • center dimensions: 4" center • connection: 1/2" IPS • drain assembly: metal with lift rod <p> DURALAST®</p>	1.2 GPM (4.5L/min) max.			
		6172	220.75	Chrome	3
		6172BN	298.00	Brushed Nickel	3
		6172BL	309.05	Matte Black	1
TWO-HANDLE WIDESPREAD BATHROOM FAUCET					
<p>NEW! Q2</p> 	<ul style="list-style-type: none"> • application: three hole • center dimensions: 8" - 16" center • drain assembly: metal with lift rod • includes: 9000 valve <p> DURALOCK® DURALAST®</p>	1.2 GPM (4.5L/min) max.			
		TV6173	364.95	Chrome	3
		TV6173BN	452.20	Brushed Nickel	3
		TV6173BL	474.00	Matte Black	3
TWO-HANDLE WIDESPREAD BATHROOM FAUCET TRIM					
	<ul style="list-style-type: none"> • application: three hole • center dimensions: 8" - 16" center • drain assembly: metal with lift rod • valve: sold separately <p> </p>	1.2 GPM (4.5L/min) max.			
		T6173	218.15	Chrome	3
		T6173BN	305.40	Brushed Nickel	3
		T6173BL	327.20	Matte Black	3
WIDESPREAD FAUCET VALVE					
	<ul style="list-style-type: none"> • application: three hole • center dimensions: 8" - 16" center • drain assembly: metal with lift rod <p> DURALOCK® DURALAST®</p>	9000◆	165.40	1/2" IPS	6
		<p>HOW TO ORDER VALVES: PAGE 469</p>  TRIM PART # +  VALVE PART # =  COMPLETE FAUCET			

		MODEL	LIST	FINISH/CONNECT	CASE QTY
ONE-HANDLE WALLMOUNT TUB FILLER TRIM					
 <ul style="list-style-type: none"> • application: two hole • connection: 1/2" slip fit • tub spout type: non diverter • spout reach: 10.00" • includes: high flow volume control cartridge • WMV130 series valve kit: sold separately 		WT371	443.70	Chrome	3
		WT371BN	585.70	Brushed Nickel	3
		WT371BL	644.25	Matte Black	3
	ONE-HANDLE WALLMOUNT TUB FILLER VALVE KIT				
 <ul style="list-style-type: none"> • application: two hole with adj. center dimensions • ports: three • quarter turn stops: included • includes: test plug • includes: spout manifold 		WMV130CIS	154.05	1/2" CC/IPS	6
		WMV130XS	154.05	1/2" Crimp Ring PEX	6
		WMV130CXS	154.05	1/2" Cold Exp. PEX	6
	HOW TO ORDER VALVES: PAGE 469  TRIM PART # +  VALVE PART # =  COMPLETE FAUCET				

TWO-HANDLE ROMAN TUB TRIM					
 <ul style="list-style-type: none"> • application: three hole • spout reach: 7.65" • valve: sold separately 		T373	355.95	Chrome	3
		T373BN	532.55	Brushed Nickel	3
		T373BL	585.90	Matte Black	3
	TWO-HANDLE ROMAN TUB VALVE				
 <ul style="list-style-type: none"> • deck thickness: 1/8" to 3-3/8" rough-in deck • adjustable spout shank: adjustable center dimensions  DURALAST®		4792	192.30	1/2" CC	6
	 <ul style="list-style-type: none"> • deck thickness: 1/8" to 2-3/4" rough-in deck • adjustable spout shank: 10" - 24" center dimensions  DURALOCK® DURALAST®		4793	217.80	1/2" CPVC, Crimp Ring PEX
		4794	207.65	1/2" Crimp Ring PEX, Cold Exp. PEX	6
 <ul style="list-style-type: none"> • deck thickness: 1/8" to 3-3/16" rough-in deck • Non-adjustable spout shank: 10" center dimensions  DURALAST®		4796	181.20	1/2" CC	6
		4797	184.70	1/2" CPVC, Crimp Ring PEX	6
		4798	184.70	1/2" Crimp Ring PEX, Cold Exp. PEX	6
For more product details, reference page 470 in valve section.					
HOW TO ORDER VALVES: PAGE 470  TRIM PART # +  VALVE PART # =  COMPLETE FAUCET					















GLYDE™ Collection























		MODEL	LIST	FINISH/CONNECT	CASE QTY			
M-CORE® TRANSFER VALVE TRIM								
 <ul style="list-style-type: none"> • use with the M-CORE® transfer valve • valve: sold separately  		UT2721	192.35	Chrome	12			
		UT2721BN	233.65	Brushed Nickel	12			
		UT2721BL	249.70	Matte Black	12			
M-CORE® TRANSFER VALVE								
Three Function (2 independent/1 shared) OR Six Function (3 independent/3 shared) - plumbing configuration page 478								
 <ul style="list-style-type: none"> • number of functions: three or six • ports: four 		U361CI	152.70	1/2" CC/IPS	6			
		U361CX	152.70	1/2" Cold Exp. PEX	6			
		U361X	152.70	1/2" Crimp Ring PEX	6			
Two Independent Functions OR Three Independent Functions - plumbing configurations page 478								
 <ul style="list-style-type: none"> • number of functions: two or three • ports: four 		U231CI	152.70	1/2" CC/IPS	6			
		U231CX	152.70	1/2" Cold Exp. PEX	6			
		U231X	152.70	1/2" Crimp Ring PEX	6			
For more product details, reference page 472 in valve section. See page 478 for plumbing configurations.								
HOW TO ORDER VALVES: PAGE 472		TRIM PART #	+		VALVE PART #	=		COMPLETE FAUCET

	MODEL	LIST	FINISH/CONNECT	CASE QTY	
M-CORE® 2-SERIES TUB/SHOWER TRIM					
 <ul style="list-style-type: none"> • showerhead: single-function eco-performance rainshower • showerhead size: 8" diameter • tub spout length: 7" • tub spout connection type: slip fit • tub spout type: diverter • includes: pressure balanced cartridge with temperature control • valve: sold separately 	1.75 GPM (6.65 L/min) max.				
	UT2843EP	313.20	Chrome	4	
	UT2843EPBN	441.95	Brushed Nickel	4	
	UT2843EPBL	468.45	Matte Black	4	
 <ul style="list-style-type: none"> • showerhead: single-function eco-performance • showerhead size: 3-3/4" diameter • tub spout length: 7" • tub spout connection type: slip fit • tub spout type: diverter • includes: pressure balanced cartridge with temperature control • valve: sold separately 	1.75 GPM (6.65 L/min) max.				
	UT2743EP	230.25	Chrome	3	
	UT2743EPBN	392.70	Brushed Nickel	3	
	UT2743EPBL	419.75	Matte Black	3	
M-CORE® 2-SERIES SHOWER ONLY TRIM					
 <ul style="list-style-type: none"> • showerhead: single-function eco-performance rainshower • showerhead size: 8" diameter • includes: pressure balanced cartridge with temperature control • valve: sold separately 	1.75 GPM (6.65 L/min) max.				
	UT2842EP	270.75	Chrome	4	
	UT2842EPBN	378.00	Brushed Nickel	4	
 <ul style="list-style-type: none"> • showerhead: single-function eco-performance • showerhead size: 3-3/4" diameter • includes: pressure balanced cartridge with temperature control • valve: sold separately 	1.75 GPM (6.65 L/min) max.				
	UT2742EP	190.30	Chrome	12	
	UT2742EPBN	327.40	Brushed Nickel	12	
 <ul style="list-style-type: none"> • valve: sold separately 	UT2742EPBL	347.80	Matte Black	12	
	M-CORE® MIXING SHOWER VALVE				
	 <ul style="list-style-type: none"> • tub/shower or shower only application • ports: four with adj. temp. limit stops • included: test plug and cross flow plug 	U140CI	72.60	1/2" CC/IPS	6
U140X		72.60	1/2" Crimp Ring PEX + CC/IPS Tub	6	
U140CX		72.60	1/2" Cold Exp. PEX + CC/IPS Tub	6	
U140V		88.95	1/2" CPVC + CC/IPS Tub	6	
 <ul style="list-style-type: none"> • tub/shower or shower only application • ports: four with adj. temp. limit stops • quarter turn stops: included 	U140CIS	104.50	1/2" CC/IPS	6	
	U140XS	104.50	1/2" Crimp Ring PEX + CC/IPS Tub	6	
	U140XCS	104.50	1/2" Cold Exp. PEX + CC/IPS Tub	6	
	U140VS	120.85	1/2" CPVC + CC/IPS Tub	6	
 <ul style="list-style-type: none"> • shower only application • ports: three 	U130CI	72.60	1/2" CC/IPS	6	
	U130X	72.60	1/2" Crimp Ring PEX	6	
	U130CX	72.60	1/2" Cold Exp. PEX	6	
 <ul style="list-style-type: none"> • shower only application • ports: three • quarter turn stops: included 	U130CIS	104.50	1/2" CC/IPS	6	
	U130XS	104.50	1/2" Crimp Ring PEX	6	
	U130CXS	104.50	1/2" Cold Exp. PEX	6	
<p>Four port valves can be used with either Tub/Shower or Shower Only applications. Three port valves can ONLY be used with Shower Only applications. For more product details, reference page 471 in valve section.</p>					
<p>HOW TO ORDER VALVES: PAGE 471</p>	 <p>TRIM PART #</p>	+	 <p>VALVE PART #</p>	=	 <p>COMPLETE FAUCET</p>



GLYDE™ Collection

		MODEL	LIST	FINISH/CONNECT	CASE QTY	
M-CORE® 2-SERIES VALVE ONLY TRIM						
 <ul style="list-style-type: none"> • includes: pressure balanced cartridge with temperature control • valve: sold separately 		UT2741	181.30	Chrome	3	
		UT2741BN	288.35	Brushed Nickel	3	
	 	UT2741BL	304.85	Matte Black	3	
M-CORE® MIXING SHOWER VALVE						
 <ul style="list-style-type: none"> • tub/shower or shower only application • ports: four with adj. temp. limit stops • included: test plug and cross flow plug 		U140CI	72.60	1/2" CC/IPS	6	
		U140X	72.60	1/2" Crimp Ring PEX + CC/IPS Tub	6	
		U140CX	72.60	1/2" Cold Exp. PEX + CC/IPS Tub	6	
		U140V	88.95	1/2" CPVC + CC/IPS Tub	6	
 <ul style="list-style-type: none"> • tub/shower or shower only application • ports: four with adj. temp. limit stops • quarter turn stops: included 		U140CIS	104.50	1/2" CC/IPS	6	
		U140XS	104.50	1/2" Crimp Ring PEX + CC/IPS Tub	6	
		U140CXS	104.50	1/2" Cold Exp. PEX + CC/IPS Tub	6	
		U140VS	120.85	1/2" CPVC + CC/IPS Tub	6	
 <ul style="list-style-type: none"> • shower only application • ports: three 		U130CI	72.60	1/2" CC/IPS	6	
		U130X	72.60	1/2" Crimp Ring PEX	6	
		U130CX	72.60	1/2" Cold Exp. PEX	6	
 <ul style="list-style-type: none"> • shower only application • ports: three • quarter turn stops: included 		U130CIS	104.50	1/2" CC/IPS	6	
		U130XS	104.50	1/2" Crimp Ring PEX	6	
		U130CXS	104.50	1/2" Cold Exp. PEX	6	
<p>Four port valves can be used with either Tub/Shower or Shower Only applications. Three port valves can ONLY be used with Shower Only applications. For more product details, reference page 471 in valve section.</p>						
<p>HOW TO ORDER VALVES: PAGE 471</p>		 <p>TRIM PART #</p>	+	 <p>VALVE PART #</p>	=	 <p>COMPLETE FAUCET</p>

	MODEL	LIST	FINISH/CONNECT	CASE QTY	
POSI-TEMP® TUB/SHOWER TRIM					
 <ul style="list-style-type: none"> • showerhead: single-function eco-performance rainshower • showerhead size: 8" diameter • tub spout length: 7" • tub spout connection type: slip fit • tub spout type: diverter • valve: sold separately 		1.75 GPM (6.65 L/min) max.			
	T2843EP	190.60	Chrome	4	
	T2843EPBN	319.35	Brushed Nickel	4	
	T2843EPBL	345.85	Matte Black	4	
 <ul style="list-style-type: none"> • showerhead: single-function standard • showerhead size: 3-3/4" diameter • tub spout length: 7" • tub spout connection type: slip fit • tub spout type: diverter • valve: sold separately 		2.5 GPM (9.5 L/min) max.			
	T2743◆	138.50	Chrome	3	
	T2743BN	270.20	Brushed Nickel	3	
	T2743BL	297.25	Matte Black	3	
			1.75 GPM (6.65 L/min) max.		
	T2743EP	118.95	Chrome	3	
	T2743EPBN	270.20	Brushed Nickel	3	
T2743EPBL	297.25	Matte Black	3		
POSI-TEMP® SHOWER ONLY TRIM					
 <ul style="list-style-type: none"> • showerhead: single-function eco-performance rainshower • showerhead size: 8" diameter • valve: sold separately 		1.75 GPM (6.65 L/min) max.			
	T2842EP	148.15	Chrome	4	
	T2842EPBN	255.45	Brushed Nickel	4	
 <ul style="list-style-type: none"> • showerhead: single-function standard • showerhead size: 3-3/4" diameter • valve: sold separately 		2.5 GPM (9.5 L/min) max.			
	T2742◆	95.20	Chrome	3	
	T2742BN	204.85	Brushed Nickel	3	
	T2742BL	225.25	Matte Black	3	
			1.75 GPM (6.65 L/min) max.		
	T2742EP	78.95	Chrome	3	
T2742EPBN	204.85	Brushed Nickel	3		
T2742EPBL	225.25	Matte Black	3		
POSI-TEMP® VALVE ONLY TRIM					
 <ul style="list-style-type: none"> • valve: sold separately 	T2741	72.55	Chrome	3	
	T2741BN	165.80	Brushed Nickel	3	
	T2741BL	182.25	Matte Black	3	
POSI-TEMP® SHOWER MIXING VALVES					
 <ul style="list-style-type: none"> • tub/shower or shower only application • ports: four with adjustable temp. limit stops • test plug: included 	2520◆	159.20	1/2" CC	6	
	2510◆	159.20	1/2" IPS	6	
 <ul style="list-style-type: none"> • tub/shower or shower only application • ports: four with adjustable temp. limit stops • quarter turn stops: included • test plug: included 	2570◆	193.35	1/2" CC	6	
	2590◆	193.35	1/2" IPS	6	
	2580◆	159.20	1/2" Crimp ring PEX	6	
 <ul style="list-style-type: none"> • tub/shower only application • ports: four with adjustable temp. limit stops • quarter turn stops: included • test plug: included 	2360PF	212.60	1/2" Crimp Ring PEX	3	
 <ul style="list-style-type: none"> • shower only application • ports: three with adjustable temp. limit stops • quarter turn stops: included • test plug: included 	2326PF	205.20	1/2" Crimp Ring PEX	6	
	2328PF	205.20	1/2" Cold Exp. PEX	6	
Four port valves can be used with either Tub/Shower or Shower Only applications. Three port valves can ONLY be used with Shower Only applications. For more product details, reference page 473-476 in valve section.					
HOW TO ORDER VALVES: PAGES 473-476		 TRIM PART #   VALVE PART #   COMPLETE FAUCET			



GLYDE™ Matching Bath Accessories

Moen® bath accessories CANNOT be combined with Moen faucet parts on a Purchase Order.

A line of matching accessories - including tank levers and towel bars - allow for a completely cohesive look in the bath.

MODEL NUMBER	LIST EACH	DESCRIPTION	QTY
Chrome (CH)			
YB2303CH	18.90	Double Robe Hook	24
YB2308CH	33.25	Paper Holder	6
YB2318CH	41.50	18" Towel Bar	6
YB2324CH	43.55	24" Towel Bar	6
YB2386CH	25.95	Towel Ring	6
Brushed Nickel (BN)			
YB2303BN	23.60	Double Robe Hook	24
YB2308BN	41.55	Paper Holder	6
YB2318BN	51.85	18" Towel Bar	6
YB2324BN	54.45	24" Towel Bar	6
YB2386BN	32.40	Towel Ring	6
Matte Black (BL)			
YB2303BL	24.55	Double Robe Hook	24
YB2308BL	43.20	Paper Holder	6
YB2318BL	53.95	18" Towel Bar	6
YB2324BL	56.65	24" Towel Bar	6
YB2386BL	33.70	Towel Ring	6
Pro-Fit® Installation Mounting Template			
YB8081	15.20	Pro-Fit® Installation Mounting Template	25



Double Robe Hook

YB2303



Towel Ring

YB2386



Paper Holder

YB2308



18" Towel Bar

YB2318

24" Towel Bar

YB2324



Pro-Fit® Installation Mounting Template

YB8081

(See page 528 for more information about the Pro-Fit® Installation System.)

PRODUCT DETAILS

5/8" Round Bar





30" towel bar options also available in select finishes.



See page 511 for details.



List price is per each (unless otherwise noted).



Product can be ordered by case quantity or individually.



MODEL LIST FINISH/CONNECT CASE QTY

ONE-HANDLE BATHROOM FAUCET					
 <p>DECKPLATE INCLUDED</p> 	<ul style="list-style-type: none"> • application: one or three hole • supply lines: flexible • connection: 3/8" compression • deckplate: included • drain assembly: metal with lift rod 	<p>1.2 GPM (4.5L/min) max.</p>			
	6600	306.60	Chrome	3	
	6600BN	398.60	Brushed Nickel	3	
	6600ORB	429.25	Oil Rubbed Bronze	3	
<p> DURALAST®</p>					
OPTION: VESSEL EXTENSION KIT					
	<ul style="list-style-type: none"> • description: vessel extension kit • included: parts to convert to grid drain • Included: two 2.5" extensions 	A1717	178.90	Chrome	6
		A1717BN	256.35	Brushed Nickel	6
		A1717ORB	278.55	Oil Rubbed Bronze	6

TWO-HANDLE CENTERSET BATHROOM FAUCET				
	<ul style="list-style-type: none"> • application: three hole • center dimensions: 4" center • connection: 1/2" IPS • drain assembly: metal with lift rod 	<p>1.2 GPM (4.5L/min) max.</p>		
	6610	220.75	Chrome	6
	6610BN	298.00	Brushed Nickel	6
	6610ORB	320.10	Oil Rubbed Bronze	6
<p> DURALAST®</p>				

TWO-HANDLE WIDESPREAD BATHROOM FAUCET				
<p>NEW! Q2</p> 	<ul style="list-style-type: none"> • application: three hole • center dimensions: 8" - 16" center • drain assembly: metal with lift rod • includes: 9000 valve 	<p>1.2 GPM (4.5L/min) max.</p>		
	TV6620	364.95	Chrome	3
	TV6620BN	452.20	Brushed Nickel	3
	TV6620ORB	484.95	Oil Rubbed Bronze	3
<p> DURALOCK® DURALAST®</p>				

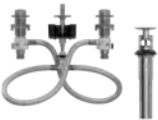
TWO-HANDLE WIDESPREAD BATHROOM FAUCET TRIM				
	<ul style="list-style-type: none"> • application: three hole • center dimensions: 8" - 16" center • drain assembly: metal with lift rod • valve: sold separately 	<p>1.2 GPM (4.5L/min) max.</p>		
	T6620	218.15	Chrome	3
	T6620BN	305.40	Brushed Nickel	3
	T6620ORB	338.15	Oil Rubbed Bronze	3
<p> </p>				

















WIDESPREAD FAUCET VALVE					
	<ul style="list-style-type: none"> • application: three hole • center dimensions: 8" - 16" center • drain assembly: metal with lift rod 	9000◆	165.40	1/2" IPS	6
	<p> DURALOCK® DURALAST®</p>				











HOW TO ORDER
VALVES: PAGE 469

 TRIM PART # +  VALVE PART # =  COMPLETE FAUCET

BRANTFORD®

















BRANTFORD® Collection

		MODEL	LIST	FINISH/CONNECT	CASE QTY
TWO-HANDLE ROMAN TUB TRIM					
 <ul style="list-style-type: none"> • for garden tub application • application: three hole • spout reach: 6.50" • valve: sold separately 		T4943	268.60	Chrome	3
		T4943BN	350.70	Brushed Nickel	3
		T4943ORB	385.60	Oil Rubbed Bronze	3
 <ul style="list-style-type: none"> • application: three hole • spout reach: 8.13" • valve: sold separately 		T933	355.95	Chrome	3
		T933BN	532.55	Brushed Nickel	3
		T933ORB	585.90	Oil Rubbed Bronze	3
TWO-HANDLE ROMAN TUB TRIM WITH HANDSHOWER					
 <ul style="list-style-type: none"> • application: four hole • showerhead type: handshower • handshower flowrate: 1.75 gpm (6.65 L/min) max. • spray functions: one-function • spout reach: 8.13" • valve: sold separately 		T924	558.90	Chrome	3
		T924BN	708.05	Brushed Nickel	3
		T924ORB	778.90	Oil Rubbed Bronze	3
TWO-HANDLE ROMAN TUB VALVE					
 <ul style="list-style-type: none"> • deck thickness: 1/8" to 3-3/8" rough-in deck • adjustable spout shank: adjustable center dimensions  DURALAST®		4792	192.30	1/2" CC	6
	 <ul style="list-style-type: none"> • deck thickness: 1/8" to 2-3/4" rough-in deck • adjustable spout shank: 10" - 24" center dimensions  DURALOCK® DURALAST®	4793	217.80	1/2" CPVC, Crimp Ring PEX	6
 <ul style="list-style-type: none"> • deck thickness: 1/8" to 3-3/16" rough-in deck • Non-adjustable spout shank: 10" center dimensions  DURALAST®		4796	181.20	1/2" CC	6
	4797	184.70	1/2" CPVC, Crimp Ring PEX	6	
	4798	184.70	1/2" Crimp Ring PEX, Cold Exp. PEX	6	
TWO-HANDLE ROMAN TUB VALVE WITH HANDSHOWER					
 <ul style="list-style-type: none"> • deck thickness: 1/8" to 2-5/8" rough-in deck • non-adj spout shank: adjustable center dim's  DURALAST®		9792	433.35	1/2" CC	6
	 <ul style="list-style-type: none"> • deck thickness: 1/8" to 2-5/8" rough-in deck • adj spout shank: 10" - 24" center dimensions  DURALOCK® DURALAST®	9793	443.50	1/2" CPVC, Crimp Ring PEX	6
For more product details, reference page 470 in valve section.					
HOW TO ORDER VALVES: PAGE 470					



















		MODEL	LIST	FINISH/CONNECT	CASE QTY
M-CORE® TRANSFER VALVE TRIM					
 <ul style="list-style-type: none"> • use with the M-CORE® transfer valve • valve: sold separately  		UT2021	192.35	Chrome	12
		UT2021BN	233.65	Brushed Nickel	12
		UT2021ORB	249.70	Oil Rubbed Bronze	12
M-CORE® TRANSFER VALVE					
Three Function (2 independent/1 shared) OR Six Function (3 independent/3 shared) - plumbing configuration page 478					
 <ul style="list-style-type: none"> • number of functions: three or six • ports: four 		U361CI	152.70	½" CC/IPS	6
		U361CX	152.70	½" Cold Exp. PEX	6
		U361X	152.70	½" Crimp Ring PEX	6
Two Independent Functions OR Three Independent Functions - plumbing configurations page 478					
 <ul style="list-style-type: none"> • number of functions: two or three • ports: four 		U231CI	152.70	½" CC/IPS	6
		U231CX	152.70	½" Cold Exp. PEX	6
		U231X	152.70	½" Crimp Ring PEX	6
For more product details, reference page 472 in valve section. See page 478 for plumbing configurations.					
HOW TO ORDER VALVES: PAGE 472	 TRIM PART #	+	 VALVE PART #	=	 COMPLETE FAUCET



BRANTFORD® Collection

		MODEL	LIST	FINISH/CONNECT	CASE QTY	
M-CORE® 2-SERIES TUB/SHOWER TRIM						
	<ul style="list-style-type: none"> • showerhead: single-function eco-performance rainshower • showerhead size: 8" diameter • tub spout length: 6 1/2" • tub spout connection type: slip fit • tub spout type: diverter • includes: pressure balanced cartridge with temperature control • valve: sold separately 	1.75 GPM (6.65 L/min) max. UT2253EP	313.20	Chrome	4	
		UT2253EPBN	441.95	Brushed Nickel	4	
		UT2253EPORB	468.45	Oil Rubbed Bronze	4	
	<ul style="list-style-type: none"> • showerhead: single-function eco-performance • showerhead size: 3-1/2" diameter • tub spout length: 6 1/2" • tub spout connection type: slip fit • tub spout type: diverter • includes: pressure balanced cartridge with temperature control • valve: sold separately 	1.75 GPM (6.65 L/min) max. UT2153EP	230.25	Chrome	3	
		UT2153EPBN	392.70	Brushed Nickel	3	
		UT2153EPORB	419.80	Oil Rubbed Bronze	3	
	<ul style="list-style-type: none"> • showerhead type: showerhead sold separately • tub spout length: 6 1/2" • tub spout connection type: slip fit • tub spout type: diverter • includes: pressure balanced cartridge with temperature control • valve: sold separately 	UT2153NH	224.40	Chrome	3	
		UT2153NHBN	318.35	Brushed Nickel	3	
		UT2153NHORB	344.05	Oil Rubbed Bronze	3	
M-CORE® MIXING SHOWER VALVE						
	<ul style="list-style-type: none"> • tub/shower or shower only application • ports: four with adj. temp. limit stops • included: test plug and cross flow plug 	U140CI	72.60	1/2" CC/IPS	6	
		U140X	72.60	1/2" Crimp Ring PEX + CC/IPS Tub	6	
		U140CX	72.60	1/2" Cold Exp. PEX + CC/IPS Tub	6	
		U140V	88.95	1/2" CPVC + CC/IPS Tub	6	
	<ul style="list-style-type: none"> • tub/shower or shower only application • ports: four with adj. temp. limit stops • quarter turn stops: included 	U140CIS	104.50	1/2" CC/IPS	6	
		U140XS	104.50	1/2" Crimp Ring PEX + CC/IPS Tub	6	
		U140CXS	104.50	1/2" Cold Exp. PEX + CC/IPS Tub	6	
		U140VS	120.85	1/2" CPVC + CC/IPS Tub	6	
	<ul style="list-style-type: none"> • shower only application • ports: three 	U130CI	72.60	1/2" CC/IPS	6	
		U130X	72.60	1/2" Crimp Ring PEX	6	
		U130CX	72.60	1/2" Cold Exp. PEX	6	
	<ul style="list-style-type: none"> • shower only application • ports: three • quarter turn stops: included 	U130CIS	104.50	1/2" CC/IPS	6	
		U130XS	104.50	1/2" Crimp Ring PEX	6	
		U130CXS	104.50	1/2" Cold Exp. PEX	6	
<p>Four port valves can be used with either Tub/Shower or Shower Only applications. Three port valves can ONLY be used with Shower Only applications. For more product details, reference page 471 in valve section.</p>						
<p>HOW TO ORDER VALVES: PAGE 471</p>		 <p>TRIM PART #</p>	+	 <p>VALVE PART #</p>	=	 <p>COMPLETE FAUCET</p>

BRANTFORD®



















		MODEL	LIST	FINISH/CONNECT	CASE QTY	
M-CORE® 2-SERIES SHOWER ONLY TRIM						
 <ul style="list-style-type: none"> • showerhead: single-function eco-performance rainshower • showerhead size: 8" diameter • includes: pressure balanced cartridge with temperature control • valve: sold separately 	<ul style="list-style-type: none"> • showerhead: single-function eco-performance rainshower • showerhead size: 8" diameter • includes: pressure balanced cartridge with temperature control • valve: sold separately 	1.75 GPM (6.65 L/min) max.				
		UT2252EP	270.75	Chrome	4	
		UT2252EPBN	378.00	Brushed Nickel	4	
		UT2252EPORB	397.90	Oil Rubbed Bronze	4	
 <ul style="list-style-type: none"> • showerhead: single-function eco-performance rainshower • showerhead size: 3-1/2" diameter • includes: pressure balanced cartridge with temperature control • valve: sold separately 	<ul style="list-style-type: none"> • showerhead: single-function eco-performance rainshower • showerhead size: 3-1/2" diameter • includes: pressure balanced cartridge with temperature control • valve: sold separately 	1.75 GPM (6.65 L/min) max.				
		UT2152EP	190.30	Chrome	12	
		UT2152EPBN	327.40	Brushed Nickel	12	
		UT2152EPORB	347.80	Oil Rubbed Bronze	12	
 <ul style="list-style-type: none"> • showerhead type: showerhead sold separately • includes: pressure balanced cartridge with temperature control • valve: sold separately 	<ul style="list-style-type: none"> • showerhead type: showerhead sold separately • includes: pressure balanced cartridge with temperature control • valve: sold separately 	UT2152NH	186.25	Chrome	3	
		UT2152NHBN	298.25	Brushed Nickel	3	
		UT2152NHORB	315.80	Oil Rubbed Bronze	3	
		M-CORE® 2-SERIES VALVE ONLY TRIM				
 <ul style="list-style-type: none"> • includes: pressure balanced cartridge with temperature control • valve: sold separately 	<ul style="list-style-type: none"> • includes: pressure balanced cartridge with temperature control • valve: sold separately 	UT2151	181.30	Chrome	3	
		UT2151BN	288.35	Brushed Nickel	3	
		UT2151ORB	304.85	Oil Rubbed Bronze	3	
		M-CORE® MIXING SHOWER VALVE				
 <ul style="list-style-type: none"> • tub/shower or shower only application • ports: four with adj. temp. limit stops • included: test plug and cross flow plug 	<ul style="list-style-type: none"> • tub/shower or shower only application • ports: four with adj. temp. limit stops • included: test plug and cross flow plug 	U140CI	72.60	1/2" CC/IPS	6	
		U140X	72.60	1/2" Crimp Ring PEX + CC/IPS Tub	6	
		U140CX	72.60	1/2" Cold Exp. PEX + CC/IPS Tub	6	
		U140V	88.95	1/2" CPVC + CC/IPS Tub	6	
 <ul style="list-style-type: none"> • tub/shower or shower only application • ports: four with adj. temp. limit stops • quarter turn stops: included 	<ul style="list-style-type: none"> • tub/shower or shower only application • ports: four with adj. temp. limit stops • quarter turn stops: included 	U140CIS	104.50	1/2" CC/IPS	6	
		U140XS	104.50	1/2" Crimp Ring PEX + CC/IPS Tub	6	
		U140CXS	104.50	1/2" Cold Exp. PEX + CC/IPS Tub	6	
		U140VS	120.85	1/2" CPVC + CC/IPS Tub	6	
 <ul style="list-style-type: none"> • shower only application • ports: three 	<ul style="list-style-type: none"> • shower only application • ports: three 	U130CI	72.60	1/2" CC/IPS	6	
		U130X	72.60	1/2" Crimp Ring PEX	6	
		U130CX	72.60	1/2" Cold Exp. PEX	6	
 <ul style="list-style-type: none"> • shower only application • ports: three • quarter turn stops: included 	<ul style="list-style-type: none"> • shower only application • ports: three • quarter turn stops: included 	U130CIS	104.50	1/2" CC/IPS	6	
		U130XS	104.50	1/2" Crimp Ring PEX	6	
		U130CXS	104.50	1/2" Cold Exp. PEX	6	
<p>Four port valves can be used with either Tub/Shower or Shower Only applications. Three port valves can ONLY be used with Shower Only applications. For more product details, reference page 471 in valve section.</p>						
<p>HOW TO ORDER VALVES: PAGE 471</p>		 <p>TRIM PART #</p>	+	 <p>VALVE PART #</p>	=	 <p>COMPLETE FAUCET</p>



BRANTFORD® Collection

		MODEL	LIST	FINISH/CONNECT	CASE QTY	
POSI-TEMP® TUB/SHOWER TRIM						
	<ul style="list-style-type: none"> • showerhead: single-function eco-performance rainshower • showerhead size: 8" diameter • tub spout length: 6 1/2" • tub spout connection type: slip fit • tub spout type: diverter • valve: sold separately 	1.75 GPM (6.65 L/min) max.				
		T2253EP	190.60	Chrome	4	
		T2253EPBN	319.35	Brushed Nickel	4	
		T2253EPORB	345.85	Oil Rubbed Bronze	4	
	<ul style="list-style-type: none"> • showerhead: single-function standard • showerhead size: 3-1/2" diameter • tub spout length: 6 1/2" • tub spout connection type: slip fit • tub spout type: diverter • valve: sold separately 	2.5 GPM (9.5 L/min) max.				
		T2153	138.50	Chrome	3	
		T2153BN	270.20	Brushed Nickel	3	
		T2153ORB	297.25	Oil Rubbed Bronze	3	
	<ul style="list-style-type: none"> • showerhead: single-function eco-performance • showerhead size: 3-1/2" diameter • tub spout length: 6 1/2" • tub spout connection type: slip fit • tub spout type: diverter • used to replace: 2 or 3 hole shower valve • valve: sold separately 	1.75 GPM (6.65 L/min) max.				
		T2157EP	170.00	Chrome	3	
		T2157EPBN	312.60	Brushed Nickel	3	
		T2157EPORB	345.85	Oil Rubbed Bronze	3	
	<ul style="list-style-type: none"> • showerhead: single-function eco-performance • showerhead size: 3-1/2" diameter • tub spout length: 6 1/2" • tub spout connection type: slip fit • tub spout type: diverter • chrome sold in case qty only: no single pack • valve: sold separately 	1.75 GPM (6.65 L/min) max.				
		T62153EP	118.95	Chrome	12	
		T2153EPBN	270.20	Brushed Nickel	3	
		T2153EPORB	297.25	Oil Rubbed Bronze	3	
POSI-TEMP® SHOWER MIXING VALVES						
	<ul style="list-style-type: none"> • tub/shower or shower only application • ports: four with adjustable temp. limit stops • test plug: included 	2520 ◆	159.20	1/2" CC	6	
		2510 ◆	159.20	1/2" IPS	6	
	<ul style="list-style-type: none"> • tub/shower or shower only application • ports: four with adjustable temp. limit stops • quarter turn stops: included • test plug: included 	2570 ◆	193.35	1/2" CC	6	
		2590 ◆	193.35	1/2" IPS	6	
		2580 ◆	159.20	1/2" Crimp ring PEX	6	
		2360PF	212.60	1/2" Crimp Ring PEX	3	
	<ul style="list-style-type: none"> • shower only application • ports: three with adjustable temp. limit stops • quarter turn stops: included • test plug: included 	2326PF	205.20	1/2" Crimp Ring PEX	6	
		2328PF	205.20	1/2" Cold Exp. PEX	6	
Four port valves can be used with either Tub/Shower or Shower Only applications. Three port valves can ONLY be used with Shower Only applications. For more product details, reference page 473-476 in valve section.						
HOW TO ORDER VALVES: PAGES 473-476		TRIM PART #	+	VALVE PART #	=	COMPLETE FAUCET

BRANTFORD® Collection

		MODEL	LIST	FINISH/CONNECT	CASE QTY	
POSI-TEMP® SHOWER ONLY TRIM						
 <ul style="list-style-type: none"> • showerhead: single-function eco-performance rainshower • showerhead size: 8" diameter • valve: sold separately 		1.75 GPM (6.65 L/min) max.				
		T2252EP	148.15	Chrome	4	
		T2252EPBN	255.45	Brushed Nickel	4	
		T2252EPORB	275.40	Oil Rubbed Bronze	4	
 <ul style="list-style-type: none"> • showerhead: single-function standard • showerhead size: 3-1/2" diameter • valve: sold separately 		2.5 GPM (9.5 L/min) max.				
		T2152◆	95.20	Chrome	3	
		T2152BN	204.85	Brushed Nickel	3	
		T2152ORB	225.25	Oil Rubbed Bronze	3	
 <ul style="list-style-type: none"> • showerhead: single-function eco-performance • showerhead size: 3-1/2" diameter • chrome sold in case qty only: no single pack • valve: sold separately 		1.75 GPM (6.65 L/min) max.				
		T62152EP◆◆	78.95	Chrome	12	
		T2152EPBN	204.85	Brushed Nickel	3	
		T2152EPORB	225.25	Oil Rubbed Bronze	3	
POSI-TEMP® VALVE ONLY TRIM						
 <ul style="list-style-type: none"> • valve: sold separately 		T2151◆	72.55	Chrome	3	
		T2151BN	165.80	Brushed Nickel	3	
		T2151ORB	182.25	Oil Rubbed Bronze	3	
POSI-TEMP® SHOWER MIXING VALVES						
 <ul style="list-style-type: none"> • tub/shower or shower only application • ports: four with adjustable temp. limit stops • test plug: included 		2520◆	159.20	1/2" CC	6	
		2510◆	159.20	1/2" IPS	6	
 <ul style="list-style-type: none"> • tub/shower or shower only application • ports: four with adjustable temp. limit stops • quarter turn stops: included • test plug: included 		2570◆	193.35	1/2" CC	6	
		2590◆	193.35	1/2" IPS	6	
		2580◆	159.20	1/2" Crimp ring PEX	6	
 <ul style="list-style-type: none"> • tub/shower only application • ports: four with adjustable temp. limit stops • quarter turn stops: included • test plug: included 		2360PF	212.60	1/2" Crimp Ring PEX	3	
 <ul style="list-style-type: none"> • shower only application • ports: three with adjustable temp. limit stops • quarter turn stops: included • test plug: included 		2326PF	205.20	1/2" Crimp Ring PEX	6	
		2328PF	205.20	1/2" Cold Exp. PEX	6	
<p>Four port valves can be used with either Tub/Shower or Shower Only applications. Three port valves can ONLY be used with Shower Only applications. For more product details, reference page 473-476 in valve section.</p>						
<p>HOW TO ORDER VALVES: PAGES 473-476</p>		 <p>TRIM PART #</p>	+	 <p>VALVE PART #</p>	=	 <p>COMPLETE FAUCET</p>



BRANTFORD® Matching Bath Accessories

Moen® bath accessories CANNOT be combined with Moen faucet parts on a Purchase Order.

A line of matching accessories - including tank levers and towel bars - allow for a completely cohesive look in the bath.

MODEL NUMBER	LIST EACH	DESCRIPTION	QTY
Chrome (CH)			
YB2201CH	25.50	Tank Lever	6
YB2203CH	18.90	Double Robe Hook	24
YB2208CH	33.25	Paper Holder	6
YB2218CH	41.50	18" Towel Bar	6
YB2224CH	43.55	24" Towel Bar	6
YB2286CH	25.95	Towel Ring	6
Brushed Nickel (BN)			
YB2201BN	40.90	Tank Lever	6
YB2203BN	23.60	Double Robe Hook	24
YB2208BN	41.55	Paper Holder	6
YB2218BN	51.85	18" Towel Bar	6
YB2224BN	54.45	24" Towel Bar	6
YB2286BN	32.40	Towel Ring	6
Oil Rubbed Bronze (ORB)			
YB2201ORB	45.05	Tank Lever	6
YB2203ORB	26.45	Double Robe Hook	24
YB2208ORB	46.55	Paper Holder	6
YB2218ORB	58.10	18" Towel Bar	6
YB2224ORB	61.00	24" Towel Bar	6
YB2286ORB	36.30	Towel Ring	6
Pro-Fit® Installation Mounting Template			
YB8081	15.20	Pro-Fit® Installation Mounting Template	25



Tank Lever
YB2201



Double Robe Hook
YB2203



Towel Ring
YB2286



Paper Holder
YB2208



18" Towel Bar
YB2218



Pro-Fit® Installation Mounting Template
YB8081

24" Towel Bar
YB2224

(See page 528 for more information about the Pro-Fit® Installation System.)

GRAB BARS

MODEL NUMBER	LIST EACH	DESCRIPTION	QTY
1 1/4" • Chrome (CH)			
YG2212CH	110.50	12" Designer Grab Bar	6
YG2218CH	115.40	18" Designer Grab Bar	6
YG2224CH	120.80	24" Designer Grab Bar	6
1 1/4" • Brushed Nickel (BN)			
YG2212BN	136.45	12" Designer Grab Bar	6
YG2218BN	142.50	18" Designer Grab Bar	6
YG2224BN	148.60	24" Designer Grab Bar	6
1 1/4" • Oil Rubbed Bronze (ORB)			
YG2212ORB	149.20	12" Designer Grab Bar	6
YG2218ORB	155.60	18" Designer Grab Bar	6
YG2224ORB	163.10	24" Designer Grab Bar	6

SECUREMOUNT™

- SecureMount™ Grab Bars are manufactured with an innovative flange design that makes it easy to connect to the stud at multiple points.
- Tested to withstand 500lbs.
- To install grab bars securely without studs, use SecureMount™ Anchors. Sold separately.



24" Designer Grab Bar
YG2224

PRODUCT DETAILS

5/8" Round Bar

30" towel bar options also available in select finishes.

See page 511 for details.

 Complies with Americans with Disabilities Act (ADA) specifications. SecureMount™ Grab Bars are tested to withstand 500 lb. pull when securely installed per instructions.

List price is per each (unless otherwise noted). Product can be ordered by case quantity or individually.



LIGHTING

MODEL NUMBER	LIST EACH	DESCRIPTION	QTY
Chrome (CH)			
YB2261CH	150.15	One Globe Bath Light	2
YB2262CH	210.20	Two Globe Bath Light	2
YB2263CH	261.00	Three Globe Bath Light	2
YB2264CH	334.35	Four Globe Bath Light	2
Brushed Nickel (BN)			
YB2261BN	187.80	One Globe Bath Light	2
YB2262BN	262.85	Two Globe Bath Light	2
YB2263BN	326.35	Three Globe Bath Light	2
YB2264BN	417.85	Four Globe Bath Light	2
Oil Rubbed Bronze (ORB)			
YB2261ORB	187.80	One Globe Bath Light	2
YB2262ORB	262.85	Two Globe Bath Light	2
YB2263ORB	326.35	Three Globe Bath Light	2
YB2264ORB	417.85	Four Globe Bath Light	2
Replacement Globe			
YB2269	28.15	Replacement Globe	3



One Globe Bath Light
YB2261



Two Globe Bath Light
YB2262



Three Globe Bath Light
YB2263

















Four Globe Bath Light
YB2264





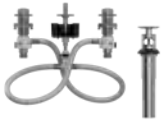









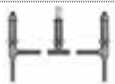



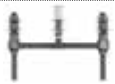









Replacement Globe
YB2269





















Bulbs not included.
List price is per each (unless otherwise noted).
Product can be ordered by case quantity or individually.
All Brantford® lighting Fixtures can be mounted facing either upward or downward.



















		MODEL	LIST	FINISH/CONNECT	CASE QTY
ONE-HANDLE BATHROOM FAUCET					
 <p>DECKPLATE INCLUDED</p> 	<ul style="list-style-type: none"> • application: one or three hole • supply lines: flexible • connection: 3/8" compression • deckplate: included • drain assembly: metal with lift rod <p> DURALAST®</p>	1.2 GPM (4.5L/min) max.			
		6400	306.60	Chrome	3
		6400BN	398.60	Brushed Nickel	3
		6400ORB	429.25	Oil Rubbed Bronze	3
OPTION: VESSEL EXTENSION KIT					
	<ul style="list-style-type: none"> • description: vessel extension kit • included: parts to convert to grid drain • Included: two 2.5" extensions 	A1717	178.90	Chrome	6
		A1717BN	256.35	Brushed Nickel	6
		A1717ORB	278.55	Oil Rubbed Bronze	6
TWO-HANDLE CENTERSET BATHROOM FAUCET					
	<ul style="list-style-type: none"> • application: three hole • center dimensions: 4" center • connection: 1/2" IPS • drain assembly: metal with lift rod <p> DURALAST®</p>	1.2 GPM (4.5L/min) max.			
		6410	220.75	Chrome	6
		6410BN	298.00	Brushed Nickel	6
		6410ORB	320.10	Oil Rubbed Bronze	6
TWO-HANDLE WIDESPREAD BATHROOM FAUCET					
<p>NEW! Q2</p> 	<ul style="list-style-type: none"> • application: three hole • center dimensions: 8" - 16" center • drain assembly: metal with lift rod • includes: 9000 valve <p> DURALOCK® DURALAST®</p>	1.2 GPM (4.5L/min) max.			
		TV6420	364.95	Chrome	3
		TV6420BN	452.20	Brushed Nickel	3
		TV6420ORB	484.95	Oil Rubbed Bronze	3
TWO-HANDLE WIDESPREAD BATHROOM FAUCET TRIM					
	<ul style="list-style-type: none"> • application: three hole • center dimensions: 8" - 16" center • drain assembly: metal with lift rod • valve: sold separately <p>  DURALAST®</p>	1.2 GPM (4.5L/min) max.			
		T6420	218.15	Chrome	3
		T6420BN	305.40	Brushed Nickel	3
		T6420ORB	338.15	Oil Rubbed Bronze	3
WIDESPREAD FAUCET VALVE					
	<ul style="list-style-type: none"> • application: three hole • center dimensions: 8" - 16" center • drain assembly: metal with lift rod <p> DURALOCK® DURALAST®</p>	9000◆	165.40	1/2" IPS	6
<p>HOW TO ORDER VALVES: PAGE 469</p>		 TRIM PART # +  VALVE PART # =  COMPLETE FAUCET			

	MODEL	LIST	FINISH/CONNECT	CASE QTY	
TWO-HANDLE ROMAN TUB TRIM					
 <ul style="list-style-type: none"> • application: three hole • spout reach: 7.67" • valve: sold separately 	T943	355.95	Chrome	3	
	T943BN	532.55	Brushed Nickel	3	
	T943ORB	585.90	Oil Rubbed Bronze	3	
TWO-HANDLE ROMAN TUB TRIM WITH HANDSHOWER					
 <ul style="list-style-type: none"> • application: four hole • showerhead type: handshower • handshower flow rate: 1.75 gpm (6.65 L/min) max. • spray functions: one-function • spout reach: 7.67" • valve: sold separately 	T944	558.90	Chrome	3	
	T944BN	708.05	Brushed Nickel	3	
	T944ORB	778.90	Oil Rubbed Bronze	3	
TWO-HANDLE ROMAN TUB VALVE					
 <ul style="list-style-type: none"> • deck thickness: 1/8" to 3-3/8" rough-in deck • adjustable spout shank: adjustable center dimensions  DURALAST®	4792	192.30	1/2" CC	6	
 <ul style="list-style-type: none"> • deck thickness: 1/8" to 2-3/4" rough-in deck • adjustable spout shank: 10" - 24" center dimensions  DURALOCK® DURALAST®	4793	217.80	1/2" CPVC, Crimp Ring PEX	6	
	4794	207.65	1/2" Crimp Ring PEX, Cold Exp. PEX	6	
 <ul style="list-style-type: none"> • deck thickness: 1/8" to 3-3/16" rough-in deck • Non-adjustable spout shank: 10" center dimensions  DURALAST®	4796	181.20	1/2" CC	6	
	4797	184.70	1/2" CPVC, Crimp Ring PEX	6	
	4798	184.70	1/2" Crimp Ring PEX, Cold Exp. PEX	6	
TWO-HANDLE ROMAN TUB VALVE WITH HANDSHOWER					
 <ul style="list-style-type: none"> • deck thickness: 1/8" to 2-5/8" rough-in deck • non-adj spout shank: adjustable center dim's  DURALAST®	9792	433.35	1/2" CC	6	
 <ul style="list-style-type: none"> • deck thickness: 1/8" to 2-5/8" rough-in deck • adj spout shank: 10" - 24" center dimensions  DURALOCK® DURALAST®	9793	443.50	1/2" CPVC, Crimp Ring PEX	6	
For more product details, reference page 470 in valve section.					
HOW TO ORDER VALVES: PAGE 470	 TRIM PART #	+	 VALVE PART #	=	 COMPLETE FAUCET





















M-CORE® TRANSFER VALVE TRIM					
 <ul style="list-style-type: none"> • use with the M-CORE® transfer valve • valve: sold separately 	UT2011	192.35	Chrome	12	
	UT2011BN	233.65	Brushed Nickel	12	
	UT2011ORB	249.70	Oil Rubbed Bronze	12	
M-CORE® TRANSFER VALVE					
Three Function (2 independent/1 shared) OR Six Function (3 independent/3 shared) - plumbing configuration page 478					
 <ul style="list-style-type: none"> • number of functions: three or six • ports: four 	U361CI	152.70	1/2" CC/IPS	6	
	U361CX	152.70	1/2" Cold Exp. PEX	6	
	U361X	152.70	1/2" Crimp Ring PEX	6	
Two Independent Functions OR Three Independent Functions - plumbing configurations page 478					
 <ul style="list-style-type: none"> • number of functions: two or three • ports: four 	U231CI	152.70	1/2" CC/IPS	6	
	U231CX	152.70	1/2" Cold Exp. PEX	6	
	U231X	152.70	1/2" Crimp Ring PEX	6	
For more product details, reference page 472 in valve section. See page 478 for plumbing configurations.					
HOW TO ORDER VALVES: PAGE 472	 TRIM PART #	+	 VALVE PART #	=	 COMPLETE FAUCET

		MODEL	LIST	FINISH/CONNECT	CASE QTY
M-CORE® 2-SERIES TUB/SHOWER TRIM					
	<ul style="list-style-type: none"> • showerhead: single-function eco-performance rainshower • showerhead size: 8" diameter • tub spout length: 7" • tub spout connection type: slip fit • tub spout type: diverter • includes: pressure balanced cartridge with temperature control • valve: sold separately 	1.75 GPM (6.65 L/min) max.			
		UT2233EP	313.20	Chrome	4
		UT2233EPBN	441.95	Brushed Nickel	4
		UT2233EPORB	468.45	Oil Rubbed Bronze	4
	<ul style="list-style-type: none"> • showerhead: single-function eco-performance • showerhead size: 3-1/2" diameter • tub spout length: 7" • tub spout connection type: slip fit • tub spout type: diverter • includes: pressure balanced cartridge with temperature control • valve: sold separately 	1.75 GPM (6.65 L/min) max.			
		UT2133EP	230.25	Chrome	4
		UT2133EPBN	392.70	Brushed Nickel	4
		UT2133EPORB	419.80	Oil Rubbed Bronze	4
	<ul style="list-style-type: none"> • showerhead type: showerhead sold separately • tub spout length: 7" • tub spout connection type: slip fit • tub spout type: diverter • includes: pressure balanced cartridge with temperature control • valve: sold separately 	UT2133NH	213.15	Chrome	3
		UT2133NHBN	329.45	Brushed Nickel	3
		UT2133NHORB	344.05	Oil Rubbed Bronze	3
M-CORE® MIXING SHOWER VALVE					
	<ul style="list-style-type: none"> • tub/shower or shower only application • ports: four with adj. temp. limit stops • included: test plug and cross flow plug 	U140CI	72.60	1/2" CC/IPS	6
		U140X	72.60	1/2" Crimp Ring PEX + CC/IPS Tub	6
		U140CX	72.60	1/2" Cold Exp. PEX + CC/IPS Tub	6
		U140V	88.95	1/2" CPVC + CC/IPS Tub	6
	<ul style="list-style-type: none"> • tub/shower or shower only application • ports: four with adj. temp. limit stops • quarter turn stops: included 	U140CIS	104.50	1/2" CC/IPS	6
		U140XS	104.50	1/2" Crimp Ring PEX + CC/IPS Tub	6
		U140CXS	104.50	1/2" Cold Exp. PEX + CC/IPS Tub	6
		U140VS	120.85	1/2" CPVC + CC/IPS Tub	6
	<ul style="list-style-type: none"> • shower only application • ports: three 	U130CI	72.60	1/2" CC/IPS	6
		U130X	72.60	1/2" Crimp Ring PEX	6
		U130CX	72.60	1/2" Cold Exp. PEX	6
	<ul style="list-style-type: none"> • shower only application • ports: three • quarter turn stops: included 	U130CIS	104.50	1/2" CC/IPS	6
		U130XS	104.50	1/2" Crimp Ring PEX	6
		U130CXS	104.50	1/2" Cold Exp. PEX	6
<p>Four port valves can be used with either Tub/Shower or Shower Only applications. Three port valves can ONLY be used with Shower Only applications. For more product details, reference page 471 in valve section.</p>					
<p>HOW TO ORDER VALVES: PAGE 471</p>					

		MODEL	LIST	FINISH/CONNECT	CASE QTY	
M-CORE® 2-SERIES SHOWER ONLY TRIM						
 <ul style="list-style-type: none"> • showerhead: single-function eco-performance rainshower • showerhead size: 8" diameter • includes: pressure balanced cartridge with temperature control • valve: sold separately 		1.75 GPM (6.65 L/min) max.				
		UT2232EP	270.75	Chrome	4	
		UT2232EPBN	378.00	Brushed Nickel	4	
		UT2232EPORB	397.90	Oil Rubbed Bronze	4	
 <ul style="list-style-type: none"> • showerhead: single-function eco-performance • showerhead size: 3-1/2" diameter • includes: pressure balanced cartridge with temperature control • valve: sold separately 		1.75 GPM (6.65 L/min) max.				
		UT2132EP	190.30	Chrome	12	
		UT2132EPBN	327.40	Brushed Nickel	12	
		UT2132EPORB	347.80	Oil Rubbed Bronze	12	
 <ul style="list-style-type: none"> • showerhead type: showerhead sold separately • includes: pressure balanced cartridge with temperature control • valve: sold separately 		UT2132NH	186.25	Chrome	3	
		UT2132NHBN	298.25	Brushed Nickel	3	
		UT2132NHORB	315.80	Oil Rubbed Bronze	3	
	M-CORE® 2-SERIES VALVE ONLY TRIM					
 <ul style="list-style-type: none"> • includes: pressure balanced cartridge with temperature control • valve: sold separately 		UT2131	181.30	Chrome	3	
		UT2131BN	288.35	Brushed Nickel	3	
		UT2131ORB	304.85	Oil Rubbed Bronze	3	
	M-CORE® MIXING SHOWER VALVE					
 <ul style="list-style-type: none"> • tub/shower or shower only application • ports: four with adj. temp. limit stops • included: test plug and cross flow plug 		U140CI	72.60	1/2" CC/IPS	6	
		U140X	72.60	1/2" Crimp Ring PEX + CC/IPS Tub	6	
		U140CX	72.60	1/2" Cold Exp. PEX + CC/IPS Tub	6	
		U140V	88.95	1/2" CPVC + CC/IPS Tub	6	
 <ul style="list-style-type: none"> • tub/shower or shower only application • ports: four with adj. temp. limit stops • quarter turn stops: included 		U140CIS	104.50	1/2" CC/IPS	6	
		U140XS	104.50	1/2" Crimp Ring PEX + CC/IPS Tub	6	
		U140CXS	104.50	1/2" Cold Exp. PEX + CC/IPS Tub	6	
		U140VS	120.85	1/2" CPVC + CC/IPS Tub	6	
 <ul style="list-style-type: none"> • shower only application • ports: three 		U130CI	72.60	1/2" CC/IPS	6	
		U130X	72.60	1/2" Crimp Ring PEX	6	
		U130CX	72.60	1/2" Cold Exp. PEX	6	
 <ul style="list-style-type: none"> • shower only application • ports: three • quarter turn stops: included 		U130CIS	104.50	1/2" CC/IPS	6	
		U130XS	104.50	1/2" Crimp Ring PEX	6	
		U130CXS	104.50	1/2" Cold Exp. PEX	6	
<p>Four port valves can be used with either Tub/Shower or Shower Only applications. Three port valves can ONLY be used with Shower Only applications. For more product details, reference page 471 in valve section.</p>						
<p>HOW TO ORDER VALVES: PAGE 471</p>		 <p>TRIM PART #</p>	+	 <p>VALVE PART #</p>	=	 <p>COMPLETE FAUCET</p>







		MODEL	LIST	FINISH/CONNECT	CASE QTY	
POSI-TEMP® TUB/SHOWER TRIM						
	<ul style="list-style-type: none"> • showerhead: single-function eco-performance rainshower • showerhead size: 8" diameter • tub spout length: 7" • tub spout connection type: slip fit • tub spout type: diverter • valve: sold separately 	1.75 GPM (6.65 L/min) max.				
		T2233EP	190.60	Chrome	4	
		T2233EPBN	319.35	Brushed Nickel	4	
		T2233EPORB	345.85	Oil Rubbed Bronze	4	
	<ul style="list-style-type: none"> • showerhead: single-function standard • showerhead size: 3-1/2" diameter • tub spout length: 7" • tub spout connection type: slip fit • tub spout type: diverter • valve: sold separately 	2.5 GPM (9.5 L/min) max.				
		T2133	138.50	Chrome	3	
		T2133BN	270.20	Brushed Nickel	3	
		T2133ORB	297.25	Oil Rubbed Bronze	3	
	<ul style="list-style-type: none"> • showerhead: single-function eco-performance • showerhead size: 3-1/2" diameter • tub spout length: 7" • tub spout connection type: slip fit • tub spout type: diverter • used to replace: 2 or 3 hole shower valve • valve: sold separately 	1.75 GPM (6.65 L/min) max.				
		T2137EP	170.00	Chrome	3	
		T2137EPBN	312.60	Brushed Nickel	3	
		T2137EPORB	345.85	Oil Rubbed Bronze	3	
	<ul style="list-style-type: none"> • showerhead: five-function eco-performance • showerhead size: 4" diameter • tub spout length: 7" • tub spout connection type: slip fit • tub spout type: diverter • used to replace: 2 or 3 hole shower valve • valve: sold separately 	1.75 GPM (6.65 L/min) max.				
		T2139EP	190.60	Chrome	3	
		T2139EPBN	319.35	Brushed Nickel	3	
	<ul style="list-style-type: none"> • showerhead: single-function eco-performance • showerhead size: 3-1/2" diameter • tub spout length: 7" • tub spout connection type: slip fit • tub spout type: diverter • chrome sold in case qty only: no single pack • valve: sold separately 	1.75 GPM (6.65 L/min) max.				
		T62133EP◆◆	118.95	Chrome	12	
		T2133EPBN	270.20	Brushed Nickel	3	
		T2133EPORB	297.25	Oil Rubbed Bronze	3	
POSI-TEMP® SHOWER MIXING VALVES						
	<ul style="list-style-type: none"> • tub/shower or shower only application • ports: four with adjustable temp. limit stops • test plug: included 	2520◆	159.20	1/2" CC	6	
		2510◆	159.20	1/2" IPS	6	
	<ul style="list-style-type: none"> • tub/shower or shower only application • ports: four with adjustable temp. limit stops • quarter turn stops: included • test plug: included 	2570◆	193.35	1/2" CC	6	
		2590◆	193.35	1/2" IPS	6	
		2580◆	159.20	1/2" Crimp ring PEX	6	
		2360PF	212.60	1/2" Crimp Ring PEX	3	
	<ul style="list-style-type: none"> • tub/shower only application • ports: four with adjustable temp. limit stops • quarter turn stops: included • test plug: included 	2326PF	205.20	1/2" Crimp Ring PEX	6	
		2328PF	205.20	1/2" Cold Exp. PEX	6	
<p>Four port valves can be used with either Tub/Shower or Shower Only applications. Three port valves can ONLY be used with Shower Only applications. For more product details, reference page 473-476 in valve section.</p>						
<p>HOW TO ORDER VALVES: PAGES 473-476</p>		 <p>TRIM PART #</p>	+	 <p>VALVE PART #</p>	=	 <p>COMPLETE FAUCET</p>

EVA®

		MODEL	LIST	FINISH/CONNECT	CASE QTY	
POSI-TEMP® SHOWER ONLY TRIM						
 <ul style="list-style-type: none"> • showerhead: single-function eco-performance rainshower • showerhead size: 8" diameter • valve: sold separately 	<ul style="list-style-type: none"> • showerhead: single-function eco-performance rainshower • showerhead size: 8" diameter • valve: sold separately 	1.75 GPM (6.65 L/min) max.				
		T2232EP	148.15	Chrome	4	
		T2232EPBN	255.45	Brushed Nickel	4	
		T2232EPORB	275.40	Oil Rubbed Bronze	4	
 <ul style="list-style-type: none"> • showerhead: single-function standard • showerhead size: 3-1/2" diameter • valve: sold separately 	<ul style="list-style-type: none"> • showerhead: single-function standard • showerhead size: 3-1/2" diameter • valve: sold separately 	2.5 GPM (9.5 L/min) max.				
		T2132	95.20	Chrome	3	
		T2132BN	204.85	Brushed Nickel	3	
		T2132ORB	225.25	Oil Rubbed Bronze	3	
 <ul style="list-style-type: none"> • showerhead: five-function eco-performance • showerhead size: 4" diameter • used to replace: 2 or 3 hole shower valve • valve: sold separately 	<ul style="list-style-type: none"> • showerhead: five-function eco-performance • showerhead size: 4" diameter • used to replace: 2 or 3 hole shower valve • valve: sold separately 	1.75 GPM (6.65 L/min) max.				
		T2138EP	148.15	Chrome	3	
		T2138EPBN	255.45	Brushed Nickel	3	
 <ul style="list-style-type: none"> • showerhead: single-function eco-performance • showerhead size: 3-1/2" diameter • chrome sold in case qty only: no single pack • valve: sold separately 	<ul style="list-style-type: none"> • showerhead: single-function eco-performance • showerhead size: 3-1/2" diameter • chrome sold in case qty only: no single pack • valve: sold separately 	1.75 GPM (6.65 L/min) max.				
		T62132EP	78.95	Chrome	12	
		T2132EPBN	204.85	Brushed Nickel	3	
		T2132EPORB	225.25	Oil Rubbed Bronze	3	
POSI-TEMP® VALVE ONLY TRIM						
 <ul style="list-style-type: none"> • valve: sold separately 	<ul style="list-style-type: none"> • valve: sold separately 	T2131	72.55	Chrome	3	
		T2131BN	165.80	Brushed Nickel	3	
		T2131ORB	182.25	Oil Rubbed Bronze	3	
POSI-TEMP® SHOWER MIXING VALVES						
 <ul style="list-style-type: none"> • tub/shower or shower only application • ports: four with adjustable temp. limit stops • test plug: included 	<ul style="list-style-type: none"> • tub/shower or shower only application • ports: four with adjustable temp. limit stops • test plug: included 	2520 ◆	159.20	1/2" CC	6	
		2510 ◆	159.20	1/2" IPS	6	
 <ul style="list-style-type: none"> • tub/shower or shower only application • ports: four with adjustable temp. limit stops • quarter turn stops: included • test plug: included 	<ul style="list-style-type: none"> • tub/shower or shower only application • ports: four with adjustable temp. limit stops • quarter turn stops: included • test plug: included 	2570 ◆	193.35	1/2" CC	6	
		2590 ◆	193.35	1/2" IPS	6	
		2580 ◆	159.20	1/2" Crimp ring PEX	6	
 <ul style="list-style-type: none"> • tub/shower only application • ports: four with adjustable temp. limit stops • quarter turn stops: included • test plug: included 	<ul style="list-style-type: none"> • tub/shower only application • ports: four with adjustable temp. limit stops • quarter turn stops: included • test plug: included 	2360PF	212.60	1/2" Crimp Ring PEX	3	
 <ul style="list-style-type: none"> • shower only application • ports: three with adjustable temp. limit stops • quarter turn stops: included • test plug: included 	<ul style="list-style-type: none"> • shower only application • ports: three with adjustable temp. limit stops • quarter turn stops: included • test plug: included 	2326PF	205.20	1/2" Crimp Ring PEX	6	
		2328PF	205.20	1/2" Cold Exp. PEX	6	
<p>Four port valves can be used with either Tub/Shower or Shower Only applications. Three port valves can ONLY be used with Shower Only applications. For more product details, reference page 473-476 in valve section.</p>						
HOW TO ORDER VALVES: PAGES 473-476		 TRIM PART #	+	 VALVE PART #	=	 COMPLETE FAUCET



EVA® Collection

	MODEL	LIST	FINISH/CONNECT	CASE QTY	
TWO-HANDLE BIDET FAUCET TRIM					
 <ul style="list-style-type: none"> • center dimensions: 8" - 16" center • valve: sold separately 	T5220	471.55	Chrome	3	
	T5220BN	569.35	Brushed Nickel	3	
BIDET VALVE					
 <ul style="list-style-type: none"> • application: three hole • center dimensions: 8" - 16" center  DURALOCK® DURALAST®	9265	321.95	1/2" IPS	6	
HOW TO ORDER VALVES: PAGE 477	 TRIM PART #	+	 VALVE PART #	=	 COMPLETE FAUCET

Moen® bath accessories CANNOT be combined with Moen faucet parts on a Purchase Order.

A line of matching accessories - including tank levers and towel bars - allow for a completely cohesive look in the bath.

MODEL NUMBER	LIST EACH	DESCRIPTION	QTY
Chrome (CH)			
YB2801CH	25.50	Tank Lever	6
YB2803CH	18.90	Single Robe Hook	24
YB2808CH	33.25	Paper Holder	6
YB2818CH	41.50	18" Towel Bar	6
YB2824CH	43.55	24" Towel Bar	6
YB2886CH	25.95	Towel Ring	6
YB2894CH	202.40	Towel Shelf	2
Brushed Nickel (BN)			
YB2801BN	40.90	Tank Lever	6
YB2803BN	23.60	Single Robe Hook	24
YB2808BN	41.55	Paper Holder	6
YB2818BN	51.85	18" Towel Bar	6
YB2824BN	54.45	24" Towel Bar	6
YB2886BN	32.40	Towel Ring	6
YB2894BN	222.00	Towel Shelf	2
Oil Rubbed Bronze (ORB)			
YB2801ORB	45.05	Tank Lever	6
YB2803ORB	26.45	Single Robe Hook	24
YB2808ORB	46.55	Paper Holder	6
YB2818ORB	58.10	18" Towel Bar	6
YB2824ORB	61.00	24" Towel Bar	6
YB2886ORB	36.30	Towel Ring	6
YB2894ORB	244.15	Towel Shelf	2
Pro-Fit® Installation Mounting Template			
YB8081	15.20	Pro-Fit® Installation Mounting Template	25



Tank Lever
YB2801



Single Robe Hook
YB2803



Towel Ring
YB2886



Paper Holder
YB2808



18" Towel Bar
YB2818



Towel Shelf
YB2894

24" Towel Bar
YB2824



Pro-Fit® Installation Mounting Template
YB8081

(See page 528 for more information about the Pro-Fit® Installation System.)

GRAB BARS

MODEL NUMBER	LIST EACH	DESCRIPTION	QTY
1½" • Chrome (CH)			
YG2812CH	110.50	12" Designer Grab Bar	6
YG2818CH	115.40	18" Designer Grab Bar	6
YG2824CH	120.80	24" Designer Grab Bar	6
1½" • Brushed Nickel (BN)			
YG2812BN	136.45	12" Designer Grab Bar	6
YG2818BN	142.20	18" Designer Grab Bar	6
YG2824BN	148.60	24" Designer Grab Bar	6
1½" • Oil Rubbed Bronze (ORB)			
YG2812ORB	149.20	12" Designer Grab Bar	6
YG2818ORB	155.60	18" Designer Grab Bar	6
YG2824ORB	163.10	24" Designer Grab Bar	6

SECUREMOUNT™

- SecureMount™ Grab Bars are manufactured with an innovative flange design that makes it easy to connect to the stud at multiple points.
- Tested to withstand 500lbs.
- To install grab bars securely without studs, use SecureMount™ Anchors. Sold separately.



24" Designer Grab Bar
YG2824

Complies with Americans with Disabilities Act (ADA) specifications. SecureMount™ Grab Bars are tested to withstand 500 lb. pull when securely installed per instructions.

List price is per each (unless otherwise noted). Product can be ordered by case quantity or individually.





LIGHTING

MODEL NUMBER	LIST EACH	DESCRIPTION	QTY
Chrome (CH)			
YB2861CH	150.15	One Globe Bath Light	2
YB2862CH	210.20	Two Globe Bath Light	2
YB2863CH	261.00	Three Globe Bath Light	2
YB2864CH	334.35	Four Globe Bath Light	2
Brushed Nickel (BN)			
YB2861BN	187.80	One Globe Bath Light	2
YB2862BN	262.85	Two Globe Bath Light	2
YB2863BN	326.35	Three Globe Bath Light	2
YB2864BN	417.85	Four Globe Bath Light	2
Oil Rubbed Bronze (ORB)			
YB2861ORB	187.80	One Globe Bath Light	2
YB2862ORB	262.85	Two Globe Bath Light	2
YB2863ORB	326.35	Three Globe Bath Light	2
YB2864ORB	417.85	Four Globe Bath Light	2
Replacement Globe			
YB2869	28.15	Replacement Globe	3



One Globe Bath Light
YB2861



Two Globe Bath Light
YB2862



Three Globe Bath Light
YB2863



Four Globe Bath Light
YB2864



Replacement Globe
YB2869



Bulbs not included.
List price is per each (unless otherwise noted).
Product can be ordered by case quantity or individually.
All Eva® lighting Fixtures can be mounted facing either upward or downward.

MODEL LIST FINISH/CONNECT CASE QTY

ONE-HANDLE BATHROOM FAUCET



DECKPLATE
SOLD
SEPARATELY



- application: one or three hole
- center dimensions: 4" center
- supply lines: flexible
- connection: 3/8" compression
- deckplate: sold separately
- drain assembly: metal with lift rod
- red/blue markings: included

DURALAST®























1.2 GPM (4.5L/min) max.

6710	280.00	Chrome	3
------	--------	--------	---















OPTIONAL DECKPLATE SOLD SEPARATELY

172666	19.50	Chrome	20
--------	-------	--------	----



		MODEL	LIST	FINISH/CONNECT	CASE QTY	
M-CORE® 2-SERIES TUB/SHOWER TRIM						
	<ul style="list-style-type: none"> • showerhead: single-function eco-performance • showerhead size: 3.75" diameter • tub spout length: 6" • tub spout connection type: slip fit • tub spout type: diverter • red/blue markings: included • includes: pressure balanced cartridge with temperature control • valve: sold separately 	<p> 1.75 GPM (6.65 L/min) max.</p> <p>UT2663EP</p>	238.95	Chrome	12	
	<ul style="list-style-type: none"> • showerhead type: showerhead sold separately • tub spout length: 6" • tub spout connection type: slip fit • tub spout type: diverter • red/blue markings: included • includes: pressure balanced cartridge with temperature control • valve: sold separately 	UT2663NH	222.20	Chrome	3	
M-CORE® 2-SERIES SHOWER ONLY TRIM						
	<ul style="list-style-type: none"> • showerhead: single-function eco-performance • showerhead size: 3.75" diameter • red/blue markings: included • includes: pressure balanced cartridge with temperature control • valve: sold separately 	<p> 1.75 GPM (6.65 L/min) max.</p> <p>UT2662EP</p>	199.85	Chrome	1	
	<ul style="list-style-type: none"> • showerhead type: showerhead sold separately • red/blue markings: included • includes: pressure balanced cartridge with temperature control • valve: sold separately 	UT2662NH	196.05	Chrome	3	
M-CORE® 2-SERIES VALVE ONLY TRIM						
	<ul style="list-style-type: none"> • red/blue markings: included • includes: pressure balanced cartridge with temperature control • valve: sold separately 	UT2661	193.65	Chrome	3	
M-CORE® MIXING SHOWER VALVE						
	<ul style="list-style-type: none"> • tub/shower or shower only application • ports: four with adj. temp. limit stops • included: test plug and cross flow plug 	<p>U140CI 72.60 1/2" CC/IPS</p> <p>U140X 72.60 1/2" Crimp Ring PEX + CC/IPS Tub</p> <p>U140CX 72.60 1/2" Cold Exp. PEX + CC/IPS Tub</p> <p>U140V 88.95 1/2" CPVC + CC/IPS Tub</p>	6	6	6	
	<ul style="list-style-type: none"> • tub/shower or shower only application • ports: four with adj. temp. limit stops • quarter turn stops: included 	<p>U140CIS 104.50 1/2" CC/IPS</p> <p>U140XS 104.50 1/2" Crimp Ring PEX + CC/IPS Tub</p> <p>U140CXS 104.50 1/2" Cold Exp. PEX + CC/IPS Tub</p> <p>U140VS 120.85 1/2" CPVC + CC/IPS Tub</p>	6	6	6	
	<ul style="list-style-type: none"> • shower only application • ports: three 	<p>U130CI 72.60 1/2" CC/IPS</p> <p>U130X 72.60 1/2" Crimp Ring PEX</p> <p>U130CX 72.60 1/2" Cold Exp. PEX</p>	6	6	6	
	<ul style="list-style-type: none"> • shower only application • ports: three • quarter turn stops: included 	<p>U130CIS 104.50 1/2" CC/IPS</p> <p>U130XS 104.50 1/2" Crimp Ring PEX</p> <p>U130CXS 104.50 1/2" Cold Exp. PEX</p>	6	6	6	
<p>Four port valves can be used with either Tub/Shower or Shower Only applications. Three port valves can ONLY be used with Shower Only applications. For more product details, reference page 471 in valve section.</p>						
<p>HOW TO ORDER VALVES: PAGE 471</p>		 <p>TRIM PART #</p>	+	 <p>VALVE PART #</p>	=	 <p>COMPLETE FAUCET</p>

VICHY®

		MODEL	LIST	FINISH/CONNECT	CASE QTY	
POSI-TEMP® TUB/SHOWER TRIM						
	<ul style="list-style-type: none"> • showerhead: single-function eco-performance • showerhead size: 3.75" diameter • tub spout length: 6" • tub spout connection type: slip fit • tub spout type: diverter • red/blue markings: included • valve: sold separately 	1.75 GPM (6.65 L/min) max. T2663EP	116.40	Chrome	3	
						
POSI-TEMP® SHOWER ONLY TRIM						
	<ul style="list-style-type: none"> • showerhead: single-function eco-performance • showerhead size: 3.75" diameter • red/blue markings: included • valve: sold separately 	1.75 GPM (6.65 L/min) max. T2662EP	77.25	Chrome	3	
						
POSI-TEMP® SHOWER MIXING VALVES						
	<ul style="list-style-type: none"> • tub/shower or shower only application • ports: four with adjustable temp. limit stops • test plug: included 	2520 ◆	159.20	1/2" CC	6	
		2510 ◆	159.20	1/2" IPS	6	
	<ul style="list-style-type: none"> • tub/shower or shower only application • ports: four with adjustable temp. limit stops • quarter turn stops: included • test plug: included 	2570 ◆	193.35	1/2" CC	6	
		2590 ◆	193.35	1/2" IPS	6	
		2580 ◆	159.20	1/2" Crimp ring PEX	6	
	<ul style="list-style-type: none"> • tub/shower only application • ports: four with adjustable temp. limit stops • quarter turn stops: included • test plug: included 	2360PF	212.60	1/2" Crimp Ring PEX	3	
						
	<ul style="list-style-type: none"> • shower only application • ports: three with adjustable temp. limit stops • quarter turn stops: included • test plug: included 	2326PF	205.20	1/2" Crimp Ring PEX	6	
		2328PF	205.20	1/2" Cold Exp. PEX	6	
<p>Four port valves can be used with either Tub/Shower or Shower Only applications. Three port valves can ONLY be used with Shower Only applications. For more product details, reference page 473-476 in valve section.</p>						
<p>HOW TO ORDER VALVES: PAGES 473-476</p>		 <p>TRIM PART #</p>	+	 <p>VALVE PART #</p>	=	 <p>COMPLETE FAUCET</p>



GENTA™ LX Coordinating Accessories

Moen® bath accessories CANNOT be combined with Moen faucet parts on a Purchase Order.

COORDINATING ACCESSORIES

Complimentary styles for a cohesive look. From robe hooks to towel bars, paper holders to knobs and pulls, Moen offers a variety of coordinating accessories to complete any room.

MODEL NUMBER	LIST EACH	DESCRIPTION	QTY
Chrome (CH)			
BH3803CH	29.75	Single Robe Hook	12
Ⓟ BH3808CH	51.10	Pivoting Paper Holder	3
BH3818CH	51.50	18" Towel Bar	3
BH3824CH	55.90	24" Towel Bar	3
BH3886CH	41.00	Hand Towel Bar	3

Ⓟ Denotes pivoting paper holder



Single Robe Hook
BH3803



Pivoting Paper Holder
BH3808 | Ⓟ



Hand Towel Bar
BH3886



18" Towel Bar
BH3818

24" Towel Bar
BH3824

GRAB BARS ♿

MODEL NUMBER	LIST EACH	DESCRIPTION	QTY
1½" • Chrome (CH)			
MBHG3818CH	141.40	18" Designer Grab Bar	3 ▲

SECUREMOUNT™

- SecureMount™ Grab Bars are manufactured with an innovative flange design that makes it easy to connect to the stud at multiple points.
- Tested to withstand 500lbs.
- To install grab bars securely without studs, use SecureMount™ Anchors. Sold separately.





18" Designer Grab Bar
MBHG3818



▲ Retail Packaging



- ♿ Complies with Americans with Disabilities Act (ADA) specifications. SecureMount™ Grab Bars are tested to withstand 500 lb. pull when securely installed per instructions.



List price is per each (unless otherwise noted). Product can be ordered by case quantity or individually.

MODEL LIST FINISH/CONNECT CASE QTY

ONE-HANDLE BATHROOM FAUCET				
 <p>DECKPLATE INCLUDED</p> 	<ul style="list-style-type: none"> • application: one or three hole • supply lines: flexible • connection: 3/8" compression • deckplate: included • drain assembly: metal with lift rod • red/blue markings: included 	<p>1.2 GPM (4.5L/min) max.</p>		
	6145	231.45	Chrome	3
	6145BN	312.45	Brushed Nickel	3
	6145BL	347.15	Matte Black	3
<p> DURALAST®</p>				

TWO-HANDLE CENTERSET BATHROOM FAUCET				
	<ul style="list-style-type: none"> • application: three hole • connection: 1/2" IPS • drain assembly: metal with lift rod 	<p>1.2 GPM (4.5L/min) max.</p>		
	6150	194.80	Chrome	3
	6150BN	263.00	Brushed Nickel	3
	6150BL	282.50	Matte Black	3
<p> DURALAST®</p>				

TWO-HANDLE WIDESPREAD BATHROOM FAUCET				
<p>NEW! Q2</p> 	<ul style="list-style-type: none"> • application: three hole • center dimensions: 8" - 16" center • drain assembly: metal with lift rod • includes: 9000 valve 	<p>1.2 GPM (4.5L/min) max.</p>		
	TV6142	360.30	Chrome	3
	TV6142BN	467.05	Brushed Nickel	3
	TV6142BL	499.00	Matte Black	3
<p> DURALOCK® DURALAST®</p>				

TWO-HANDLE WIDESPREAD BATHROOM FAUCET TRIM				
	<ul style="list-style-type: none"> • application: three hole • center dimensions: 8" - 16" center • drain assembly: metal with lift rod • red/blue markings: included • valve: sold separately 	<p>1.2 GPM (4.5L/min) max.</p>		
	T6142	213.50	Chrome	3
	T6142BN	320.25	Brushed Nickel	3
	T6142BL	352.20	Matte Black	3
<p>  DURALAST®</p>				







WIDESPREAD FAUCET VALVE				
	<ul style="list-style-type: none"> • application: three hole • center dimensions: 8" - 16" center • drain assembly: metal with lift rod 	9000◆	165.40	1/2" IPS
	<p> DURALOCK® DURALAST®</p>			











HOW TO ORDER
VALVES: PAGE 469

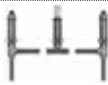









 TRIM PART # +  VALVE PART # =  COMPLETE FAUCET



















GIBSON™ Collection



















		MODEL	LIST	FINISH/CONNECT	CASE QTY
ONE-HANDLE WALLMOUNT TUB FILLER TRIM					
 <ul style="list-style-type: none"> • application: two hole • connection: 1/2" slip fit • tub spout type: non diverter • spout reach: 10.00" • includes: high flow volume control cartridge • WMV130 series valve kit: sold separately 		WT961	483.60	Chrome	3
		WT961BN	628.70	Brushed Nickel	3
		WT961BL	691.55	Matte Black	3
ONE-HANDLE WALLMOUNT TUB FILLER VALVE KIT					
 <ul style="list-style-type: none"> • application: two hole with adj. center dimensions • ports: three • quarter turn stops: included • includes: test plug • includes: spout manifold 		WMV130CIS	154.05	1/2" CC/IPS	6
		WMV130XS	154.05	1/2" Crimp Ring PEX	6
		WMV130CXS	154.05	1/2" Cold Exp. PEX	6
HOW TO ORDER VALVES: PAGE 469	 TRIM PART #	+	 VALVE PART #	=	 COMPLETE FAUCET

TWO-HANDLE ROMAN TUB TRIM					
 <ul style="list-style-type: none"> • application: three hole • spout reach: 7.63" • valve: sold separately 		T961	348.40	Chrome	3
		T961BN	506.50	Brushed Nickel	3
		T961BL	557.10	Matte Black	3
TWO-HANDLE ROMAN TUB VALVE					
 <ul style="list-style-type: none"> • deck thickness: 1/8" to 3-3/8" rough-in deck • adjustable spout shank: adjustable center dimensions  DURALAST®		4792	192.30	1/2" CC	6
 <ul style="list-style-type: none"> • deck thickness: 1/8" to 2-3/4" rough-in deck • adjustable spout shank: 10" - 24" center dimensions  DURALOCK® DURALAST®		4793	217.80	1/2" CPVC, Crimp Ring PEX	6
		4794	207.65	1/2" Crimp Ring PEX, Cold Exp. PEX	6
 <ul style="list-style-type: none"> • deck thickness: 1/8" to 3-3/16" rough-in deck • Non-adjustable spout shank: 10" center dimensions  DURALAST®		4796	181.20	1/2" CC	6
		4797	184.70	1/2" CPVC, Crimp Ring PEX	6
		4798	184.70	1/2" Crimp Ring PEX, Cold Exp. PEX	6
For more product details, reference page 470 in valve section.					
HOW TO ORDER VALVES: PAGE 470	 TRIM PART #	+	 VALVE PART #	=	 COMPLETE FAUCET

		MODEL	LIST	FINISH/CONNECT	CASE QTY	
M-CORE® TRANSFER VALVE TRIM						
 <ul style="list-style-type: none"> • use with the M-CORE® transfer valve • valve: sold separately  		UT2921	192.35	Chrome	12	
		UT2921BN	234.00	Brushed Nickel	12	
		UT2921BL	250.20	Matte Black	12	
M-CORE® TRANSFER VALVE						
Three Function (2 independent/1 shared) OR Six Function (3 independent/3 shared) - plumbing configuration page 478						
 <ul style="list-style-type: none"> • number of functions: three or six • ports: four 		U361CI	152.70	1/2" CC/IPS	6	
		U361CX	152.70	1/2" Cold Exp. PEX	6	
		U361X	152.70	1/2" Crimp Ring PEX	6	
Two Independent Functions OR Three Independent Functions - plumbing configurations page 478						
 <ul style="list-style-type: none"> • number of functions: two or three • ports: four 		U231CI	152.70	1/2" CC/IPS	6	
		U231CX	152.70	1/2" Cold Exp. PEX	6	
		U231X	152.70	1/2" Crimp Ring PEX	6	
For more product details, reference page 472 in valve section. See page 478 for plumbing configurations.						
HOW TO ORDER VALVES: PAGE 472		 TRIM PART #	+	 VALVE PART #	=	 COMPLETE FAUCET





















GIBSON™ Collection

		MODEL	LIST	FINISH/CONNECT	CASE QTY	
M-CORE® 2-SERIES TUB/SHOWER TRIM						
	<ul style="list-style-type: none"> • showerhead: single-function eco-performance rainshower • showerhead size: 8" diameter • tub spout length: 6 1/2" • tub spout connection type: slip fit • tub spout type: diverter • red/blue markings: included • includes: pressure balanced cartridge with temperature control • valve: sold separately 	1.75 GPM (6.65 L/min) max.				
		UT3003EP	293.95	Chrome	4	
		UT3003EPBN	445.50	Brushed Nickel	4	
		UT3003EPBL	477.80	Matte Black	4	
	<ul style="list-style-type: none"> • showerhead: single-function eco-performance • showerhead size: 3.6" diameter • tub spout length: 6 1/2" • tub spout connection type: slip fit • tub spout type: diverter • red/blue markings: included • includes: pressure balanced cartridge with temperature control • valve: sold separately 	1.75 GPM (6.65 L/min) max.				
		UT2903EP	238.95	Chrome	12	
		UT2903EPBN	341.80	Brushed Nickel	12	
		UT2903EPBL	363.75	Matte Black	12	
	<ul style="list-style-type: none"> • showerhead type: showerhead sold separately • tub spout length: 6 1/2" • tub spout connection type: slip fit • tub spout type: diverter • red/blue markings: included • includes: pressure balanced cartridge with temperature control • valve: sold separately 	UT2903NH	222.20	Chrome	3	
		UT2903NHBN	321.35	Brushed Nickel	3	
		UT2903NHBL	341.25	Matte Black	3	
M-CORE® MIXING SHOWER VALVE						
 	<ul style="list-style-type: none"> • tub/shower or shower only application • ports: four with adj. temp. limit stops • included: test plug and cross flow plug 	U140CI	72.60	1/2" CC/IPS	6	
		U140X	72.60	1/2" Crimp Ring PEX + CC/IPS Tub	6	
		U140CX	72.60	1/2" Cold Exp. PEX + CC/IPS Tub	6	
		U140V	88.95	1/2" CPVC + CC/IPS Tub	6	
 	<ul style="list-style-type: none"> • tub/shower or shower only application • ports: four with adj. temp. limit stops • quarter turn stops: included 	U140CIS	104.50	1/2" CC/IPS	6	
		U140XS	104.50	1/2" Crimp Ring PEX + CC/IPS Tub	6	
		U140CXS	104.50	1/2" Cold Exp. PEX + CC/IPS Tub	6	
		U140VS	120.85	1/2" CPVC + CC/IPS Tub	6	
 	<ul style="list-style-type: none"> • shower only application • ports: three 	U130CI	72.60	1/2" CC/IPS	6	
		U130X	72.60	1/2" Crimp Ring PEX	6	
		U130CX	72.60	1/2" Cold Exp. PEX	6	
 	<ul style="list-style-type: none"> • shower only application • ports: three • quarter turn stops: included 	U130CIS	104.50	1/2" CC/IPS	6	
		U130XS	104.50	1/2" Crimp Ring PEX	6	
		U130CXS	104.50	1/2" Cold Exp. PEX	6	
<p>Four port valves can be used with either Tub/Shower or Shower Only applications. Three port valves can ONLY be used with Shower Only applications. For more product details, reference page 471 in valve section.</p>						
<p>HOW TO ORDER VALVES: PAGE 471</p>		 <p>TRIM PART #</p>	+	 <p>VALVE PART #</p>	=	 <p>COMPLETE FAUCET</p>











		MODEL	LIST	FINISH/CONNECT	CASE QTY	
M-CORE® 2-SERIES SHOWER ONLY TRIM						
 <ul style="list-style-type: none"> • showerhead: single-function eco-performance rainshower • showerhead size: 8" diameter • red/blue markings: included • includes: pressure balanced cartridge with temperature control • valve: sold separately 	<ul style="list-style-type: none"> • showerhead: single-function eco-performance rainshower • showerhead size: 8" diameter • red/blue markings: included • includes: pressure balanced cartridge with temperature control • valve: sold separately 	1.75 GPM (6.65 L/min) max.				
		UT3002EP	254.80	Chrome	4	
		UT3002EPBN	357.60	Brushed Nickel	4	
		UT3002EPBL	381.00	Matte Black	4	
 <ul style="list-style-type: none"> • showerhead: single-function eco-performance • showerhead size: 3.6" diameter • red/blue markings: included • includes: pressure balanced cartridge with temperature control • valve: sold separately 	<ul style="list-style-type: none"> • showerhead: single-function eco-performance • showerhead size: 3.6" diameter • red/blue markings: included • includes: pressure balanced cartridge with temperature control • valve: sold separately 	1.75 GPM (6.65 L/min) max.				
		UT2902EP	199.85	Chrome	12	
		UT2902EPBN	281.35	Brushed Nickel	12	
		UT2902EPBL	297.30	Matte Black	12	
 <ul style="list-style-type: none"> • showerhead type: showerhead sold separately • red/blue markings: included • includes: pressure balanced cartridge with temperature control • valve: sold separately 	<ul style="list-style-type: none"> • showerhead type: showerhead sold separately • red/blue markings: included • includes: pressure balanced cartridge with temperature control • valve: sold separately 	UT2902NH	196.05	Chrome	3	
		UT2902NHBN	273.60	Brushed Nickel	3	
		UT2902NHBL	288.75	Matte Black	3	
M-CORE® 2-SERIES VALVE ONLY TRIM						
 <ul style="list-style-type: none"> • red/blue markings: included • includes: pressure balanced cartridge with temperature control • valve: sold separately 	<ul style="list-style-type: none"> • red/blue markings: included • includes: pressure balanced cartridge with temperature control • valve: sold separately 	UT2901	193.65	Chrome	3	
		UT2901BN	268.60	Brushed Nickel	3	
		UT2901BL	283.25	Matte Black	3	
		M-CORE® MIXING SHOWER VALVE				
 <ul style="list-style-type: none"> • tub/shower or shower only application • ports: four with adj. temp. limit stops • included: test plug and cross flow plug 	<ul style="list-style-type: none"> • tub/shower or shower only application • ports: four with adj. temp. limit stops • included: test plug and cross flow plug 	U140CI	72.60	1/2" CC/IPS	6	
		U140X	72.60	1/2" Crimp Ring PEX + CC/IPS Tub	6	
		U140CX	72.60	1/2" Cold Exp. PEX + CC/IPS Tub	6	
		U140V	88.95	1/2" CPVC + CC/IPS Tub	6	
 <ul style="list-style-type: none"> • tub/shower or shower only application • ports: four with adj. temp. limit stops • quarter turn stops: included 	<ul style="list-style-type: none"> • tub/shower or shower only application • ports: four with adj. temp. limit stops • quarter turn stops: included 	U140CIS	104.50	1/2" CC/IPS	6	
		U140XS	104.50	1/2" Crimp Ring PEX + CC/IPS Tub	6	
		U140CXS	104.50	1/2" Cold Exp. PEX + CC/IPS Tub	6	
		U140VS	120.85	1/2" CPVC + CC/IPS Tub	6	
 <ul style="list-style-type: none"> • shower only application • ports: three 	<ul style="list-style-type: none"> • shower only application • ports: three 	U130CI	72.60	1/2" CC/IPS	6	
		U130X	72.60	1/2" Crimp Ring PEX	6	
		U130CX	72.60	1/2" Cold Exp. PEX	6	
 <ul style="list-style-type: none"> • shower only application • ports: three • quarter turn stops: included 	<ul style="list-style-type: none"> • shower only application • ports: three • quarter turn stops: included 	U130CIS	104.50	1/2" CC/IPS	6	
		U130XS	104.50	1/2" Crimp Ring PEX	6	
		U130CXS	104.50	1/2" Cold Exp. PEX	6	
<p>Four port valves can be used with either Tub/Shower or Shower Only applications. Three port valves can ONLY be used with Shower Only applications. For more product details, reference page 471 in valve section.</p>						
<p>HOW TO ORDER VALVES: PAGE 471</p>		 <p>TRIM PART #</p>	+	 <p>VALVE PART #</p>	=	 <p>COMPLETE FAUCET</p>















GIBSON™ Collection

		MODEL	LIST	FINISH/CONNECT	CASE QTY	
POSI-TEMP® TUB/SHOWER TRIM						
	<ul style="list-style-type: none"> • showerhead: single-function eco-performance rainshower • showerhead size: 8" diameter • tub spout length: 6 1/2" • tub spout connection type: slip fit • tub spout type: diverter • red/blue markings: included • valve: sold separately 	1.75 GPM (6.65 L/min) max.				
		T3003EP	171.35	Chrome	4	
		T3003EPBN	323.00	Brushed Nickel	4	
		T3003EPBL	355.30	Matte Black	4	
	<ul style="list-style-type: none"> • showerhead: single-function eco-performance • showerhead size: 3.6" diameter • tub spout length: 6 1/2" • tub spout connection type: slip fit • tub spout type: diverter • red/blue markings: included • valve: sold separately 	1.75 GPM (6.65 L/min) max.				
		T2903EP	116.40	Chrome	3	
		T2903EPBN	219.30	Brushed Nickel	3	
		T2903EPBL	241.30	Matte Black	3	
	<ul style="list-style-type: none"> • showerhead type: showerhead sold separately • tub spout length: 6 1/2" • tub spout connection type: slip fit • tub spout type: diverter • red/blue markings: included • valve: sold separately 	T2903NH	99.65	Chrome	3	
		T2903NHBN	198.80	Brushed Nickel	3	
		T2903NHBL	218.70	Matte Black	3	
POSI-TEMP® SHOWER ONLY TRIM						
	<ul style="list-style-type: none"> • showerhead: single-function eco-performance rainshower • showerhead size: 8" diameter • red/blue markings: included • valve: sold separately 	1.75 GPM (6.65 L/min) max.				
		T3002EP	132.35	Chrome	4	
		T3002EPBN	235.00	Brushed Nickel	4	
	<ul style="list-style-type: none"> • showerhead: single-function eco-performance • showerhead size: 3.6" diameter • red/blue markings: included • valve: sold separately 	1.75 GPM (6.65 L/min) max.				
		T2902EP	77.25	Chrome	3	
		T2902EPBN	158.85	Brushed Nickel	3	
	<ul style="list-style-type: none"> • showerhead type: showerhead sold separately • red/blue markings: included • valve: sold separately 	T2902NH	73.50	Chrome	3	
		T2902NHBN	151.05	Brushed Nickel	3	
		T2902NHBL	166.15	Matte Black	3	
POSI-TEMP® SHOWER MIXING VALVES						
	<ul style="list-style-type: none"> • tub/shower or shower only application • ports: four with adjustable temp. limit stops • test plug: included 	2520 ◆	159.20	1/2" CC	6	
		2510 ◆	159.20	1/2" IPS	6	
	<ul style="list-style-type: none"> • tub/shower or shower only application • ports: four with adjustable temp. limit stops • quarter turn stops: included • test plug: included 	2570 ◆	193.35	1/2" CC	6	
		2590 ◆	193.35	1/2" IPS	6	
		2580 ◆	159.20	1/2" Crimp ring PEX	6	
		2360PF	212.60	1/2" Crimp Ring PEX	3	
	<ul style="list-style-type: none"> • tub/shower only application • ports: four with adjustable temp. limit stops • quarter turn stops: included • test plug: included 	2326PF	205.20	1/2" Crimp Ring PEX	6	
		2328PF	205.20	1/2" Cold Exp. PEX	6	
<p>Four port valves can be used with either Tub/Shower or Shower Only applications. Three port valves can ONLY be used with Shower Only applications. For more product details, reference page 473-476 in valve section.</p>						
<p>HOW TO ORDER VALVES: PAGES 473-476</p>		 <p>TRIM PART #</p>	+	 <p>VALVE PART #</p>	=	 <p>COMPLETE FAUCET</p>

GIBSON™

		MODEL	LIST	FINISH/CONNECT	CASE QTY	
POSI-TEMP® VALVE ONLY TRIM						
 <ul style="list-style-type: none"> • red/blue markings: included • valve: sold separately 		T2901	71.15	Chrome	3	
		T2901BN	146.05	Brushed Nickel	3	
		T2901BL	160.70	Matte Black	3	
POSI-TEMP® SHOWER MIXING VALVES						
 <ul style="list-style-type: none"> • tub/shower or shower only application • ports: four with adjustable temp. limit stops • test plug: included 		2520 ◆	159.20	1/2" CC	6	
		2510 ◆	159.20	1/2" IPS	6	
 <ul style="list-style-type: none"> • tub/shower or shower only application • ports: four with adjustable temp. limit stops • quarter turn stops: included • test plug: included 		2570 ◆	193.35	1/2" CC	6	
		2590 ◆	193.35	1/2" IPS	6	
		2580 ◆	159.20	1/2" Crimp ring PEX	6	
		2360PF	212.60	1/2" Crimp Ring PEX	3	
 <ul style="list-style-type: none"> • shower only application • ports: three with adjustable temp. limit stops • quarter turn stops: included • test plug: included 		2326PF	205.20	1/2" Crimp Ring PEX	6	
		2328PF	205.20	1/2" Cold Exp. PEX	6	
<p>Four port valves can be used with either Tub/Shower or Shower Only applications. Three port valves can ONLY be used with Shower Only applications. For more product details, reference page 473-476 in valve section.</p>						
HOW TO ORDER VALVES: PAGES 473-476		 TRIM PART #	+	 VALVE PART #	=	 COMPLETE FAUCET

POSI-TEMP® WITH INTEGRATED TRANSFER VALVE TRIM						
 <ul style="list-style-type: none"> • red/blue markings: included • valve: sold separately 		T2900	105.55	Chrome	4	
		T2900BN	153.10	Brushed Nickel	4	
		T2900BL	168.45	Matte Black	4	
POSI-TEMP® WITH INTEGRATED TRANSFER VALVE						
 <ul style="list-style-type: none"> • functions: three (two independent and one shared) • ports: four with adjustable temp. limit stops • test plug: included 		2551	287.50	1/2" IPS	6	
		2581	323.75	1/2" IPS	6	
 <ul style="list-style-type: none"> • functions: three (two independent and one shared) • ports: four with adjustable temp. limit stops • stops: included • test plug: included 		2521	287.50	1/2" IPS	6	
		2571	323.75	1/2" IPS	6	
 <ul style="list-style-type: none"> • functions: two independent • ports: four with adjustable temp. limit stops • test plug: included 		2521	287.50	1/2" IPS	6	
		2571	323.75	1/2" IPS	6	
 <ul style="list-style-type: none"> • functions: two independent • ports: four with adjustable temp. limit stops • stops: included • test plug: included 		2521	287.50	1/2" IPS	6	
		2571	323.75	1/2" IPS	6	
<p>For more product details, reference page 477 in valve section.</p>						
HOW TO ORDER VALVES: PAGE 477		 TRIM PART #	+	 VALVE PART #	=	 COMPLETE FAUCET

ISO™ Coordinating Bath Accessories

Moen® bath accessories CANNOT be combined with Moen faucet parts on a Purchase Order.

COORDINATING ACCESSORIES

Complimentary styles for a cohesive look. From robe hooks to towel bars, paper holders to knobs and pulls, Moen offers a variety of coordinating accessories to complete any room.

MODEL NUMBER	LIST EACH	DESCRIPTION	QTY
Chrome (CH)			
DN0703CH	25.90	Single Robe Hook	12 ▲
DN0705CH	11.15	Drawer Knob	48
DN0707CH	22.30	Drawer Pull	48
Ⓟ DN0708CH	51.00	Pivoting Paper Holder	3 ▲
DN0709CH	46.85	Single-Post Paper Holder	3
DN0718CH	46.90	18" Towel Bar	3 ▲
DN0722CH	76.50	24" Double Towel Bar	3 ▲
DN0724CH	51.00	24" Towel Bar	3 ▲
DN0786CH	33.10	Towel Ring	3 ▲
DN0790CH	92.45	Vanity Shelf	3 ▲
Ⓟ DN0792CH	123.75	Mirror	3 ▲
DN0794CH	216.45	Towel Shelf	2
Brushed Nickel (BN)			
DN0703BN	29.10	Single Robe Hook	24 ▲
DN0705BN	13.05	Drawer Knob	48
DN0707BN	24.00	Drawer Pull	48
Ⓟ DN0708BN	57.45	Pivoting Paper Holder	3
DN0709BN	52.45	Single-Post Paper Holder	3
DN0718BN	54.30	18" Towel Bar	3
DN0722BN	85.85	24" Double Towel Bar	3
DN0724BN	59.15	24" Towel Bar	3
DN0786BN	40.20	Towel Ring	3
DN0790BN	104.10	Vanity Shelf	3 ▲
Ⓟ DN0792BN	139.25	Mirror	3
DN0794BN	234.05	Towel Shelf	2
Matte Black (BL)			
DN0703BL	32.10	Single Robe Hook	12 ▲
DN0705BL	13.55	Drawer Knob	48
DN0707BL	26.95	Drawer Pull	48
Ⓟ DN0708BL	63.20	Pivoting Paper Holder	3 ▲
DN0709BL	57.70	Single-Post Paper Holder	3 ▲
DN0718BL	59.70	18" Towel Bar	3 ▲
DN0722BL	94.45	24" Double Towel Bar	3 ▲
DN0724BL	65.10	24" Towel Bar	3 ▲
DN0786BL	44.25	Towel Ring	3 ▲
DN0790BL	114.50	Vanity Shelf	3 ▲
Ⓟ DN0792BL	153.15	Mirror	3 ▲
DN0794BL	257.45	Towel Shelf	2 ▲
Brushed Gold (BG)			
DN0705BG	15.65	Drawer Knob	48
DN0707BG	28.75	Drawer Pull	48

Ⓟ Denotes pivoting paper holder and mirror



Single Robe Hook
DN0703



Towel Ring
DN0786



Pivoting Paper Holder
DN0708 | Ⓟ



Single-Post Paper Holder
DN0709



18" Towel Bar
DN0718



24" Double Towel Bar
DN0722

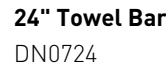

24" Towel Bar
DN0724



Drawer Knob
DN0705



Drawer Pull
DN0707



Towel Shelf
DN0794



Vanity Shelf
DN0790



Pivoting Mirror
DN0792 | Ⓟ

GIBSON™

▲ Retail Packaging

List price is per each (unless otherwise noted).
Product can be ordered by case quantity or individually.

GRAB BARS 

MODEL NUMBER	LIST EACH	DESCRIPTION	QTY
1½" • Chrome (CH)			
YG0712CH	84.45	12" Designer Grab Bar	6
YG0718CH	89.05	18" Designer Grab Bar	6
YG0724CH	93.65	24" Designer Grab Bar	6
YG0736CH	106.65	36" Designer Grab Bar	6
YG0742CH	130.00	42" Designer Grab Bar	6

1½" • Brushed Nickel (BN)

YG0712BN	99.00	12" Designer Grab Bar	6
YG0718BN	104.00	18" Designer Grab Bar	6
YG0724BN	109.50	24" Designer Grab Bar	6
YG0736BN	124.50	36" Designer Grab Bar	6
YG0742BN	162.50	42" Designer Grab Bar	6

1½" • Matte Black (BL)

YG0712BL	106.10	12" Designer Grab Bar	6
YG0718BL	112.00	18" Designer Grab Bar	6
YG0724BL	117.80	24" Designer Grab Bar	6
YG0736BL	134.10	36" Designer Grab Bar	6
YG0742BL	169.00	42" Designer Grab Bar	6

 Complies with Americans with Disabilities Act (ADA) specifications. SecureMount™ Grab Bars are tested to withstand 500 lb. pull when securely installed per instructions.

SECUREMOUNT™

- SecureMount™ Grab Bars are manufactured with an innovative flange design that makes it easy to connect to the stud at multiple points.
- Tested to withstand 500lbs.
- To install grab bars securely without studs, use SecureMount™ Anchors. Sold separately.

**18" Designer Grab Bar**

YG0718

LIGHTING

MODEL NUMBER	LIST EACH	DESCRIPTION	QTY
Chrome (CH)			
DN0761CH	149.80	One Globe Bath Light	2
DN0762CH	213.70	Two Globe Bath Light	2
DN0763CH	262.25	Three Globe Bath Light	2
DN0764CH	335.95	Four Globe Bath Light	2

Brushed Nickel (BN)

DN0761BN	188.60	One Globe Bath Light	2
DN0762BN	264.10	Two Globe Bath Light	2
DN0763BN	327.90	Three Globe Bath Light	2
DN0764BN	419.80	Four Globe Bath Light	2

Brushed Gold (BG)

DN0761BG	226.30	One Globe Bath Light	2
DN0762BG	316.80	Two Globe Bath Light	2
DN0763BG	393.40	Three Globe Bath Light	2
DN0764BG	503.75	Four Globe Bath Light	2

Matte Black (BL)

DN0761BL	181.45	One Globe Bath Light	2
DN0762BL	258.80	Two Globe Bath Light	2
DN0763BL	317.60	Three Globe Bath Light	2
DN0764BL	406.85	Four Globe Bath Light	2

Replacement Globe

DN0769	27.65	Replacement Globe	3
--------	-------	-------------------	---

**One Globe Bath Light**

DN0761

**Two Globe Bath Light**

DN0762

**Three Globe Bath Light**

DN0763

**Four Globe Bath Light**

DN0764

**Replacement Globe**

DN0769















Bulbs not included.

List price is per each (unless otherwise noted).







Product can be ordered by case quantity or individually.











All ISO™ lighting Fixtures can be mounted facing either upward or downward.

GENTA™ LX Collection











		MODEL	LIST	FINISH/CONNECT	CASE QTY
ONE-HANDLE BATHROOM FAUCET					
 <p>DECKPLATE INCLUDED</p> 	<ul style="list-style-type: none"> • application: one or three hole • supply lines: flexible • connection: 3/8" compression • deckplate: included • drain assembly: metal with lift rod • red/blue markings: included <p> DURALAST®</p>	1.2 GPM (4.5L/min) max.			
		6702	221.75	Chrome	3
		6702BN	288.30	Brushed Nickel	3
		6702BL	310.50	Matte Black	3
TWO-HANDLE WIDESPREAD BATHROOM FAUCET					
<p>NEW Q2</p> 	<ul style="list-style-type: none"> • application: three hole • center dimensions: 8" - 16" center • drain assembly: metal with lift rod • includes: 9000 valve <p> DURALOCK® DURALAST®</p>	1.2 GPM (4.5L/min) max.			
		TV6708	326.45	Chrome	3
		TV6708BN	389.35	Brushed Nickel	3
		TV6708BL	407.30	Matte Black	3
TWO-HANDLE WIDESPREAD BATHROOM FAUCET TRIM					
	<ul style="list-style-type: none"> • application: three hole • center dimensions: 8" - 16" center • drain assembly: metal with lift rod • valve: sold separately <p>  DURALAST®</p>	1.2 GPM (4.5L/min) max.			
		T6708	179.65	Chrome	3
		T6708BN	242.55	Brushed Nickel	3
		T6708BL	260.50	Matte Black	3
WIDESPREAD FAUCET VALVE					
	<ul style="list-style-type: none"> • application: three hole • center dimensions: 8" - 16" center • drain assembly: metal with lift rod <p> DURALOCK® DURALAST®</p>	9000◆	165.40	1/2" IPS	6
<p>HOW TO ORDER VALVES: PAGE 469</p>		 TRIM PART # +  VALVE PART # =  COMPLETE FAUCET			

GENTA™ LX Collection





















		MODEL	LIST	FINISH/CONNECT	CASE QTY
ONE-HANDLE WALLMOUNT TUB FILLER TRIM					
 <ul style="list-style-type: none"> • application: two hole • connection: 1/2" slip fit • tub spout type: non diverter • spout reach: 10.00" • includes: high flow volume control cartridge • WMV130 series valve kit: sold separately 		WT901	483.60	Chrome	3
		WT901BN	619.00	Brushed Nickel	3
		WT901BL	680.90	Matte Black	3
ONE-HANDLE WALLMOUNT TUB FILLER VALVE KIT					
 <ul style="list-style-type: none"> • application: two hole with adj. center dimensions • ports: three • quarter turn stops: included • includes: test plug • includes: spout manifold 		WMV130CIS	154.05	1/2" CC/IPS	6
		WMV130XS	154.05	1/2" Crimp Ring PEX	6
		WMV130CXS	154.05	1/2" Cold Exp. PEX	6
HOW TO ORDER VALVES: PAGE 469		 TRIM PART # +  VALVE PART # =  COMPLETE FAUCET			

TWO-HANDLE ROMAN TUB TRIM					
 <ul style="list-style-type: none"> • application: three hole • spout reach: 7.94" • valve: sold separately 		T908	356.00	Chrome	3
		T908BN	532.55	Brushed Nickel	3
		T908BL	585.85	Matte Black	3
TWO-HANDLE ROMAN TUB VALVE					
 <ul style="list-style-type: none"> • deck thickness: 1/8" to 3-3/8" rough-in deck • adjustable spout shank: adjustable center dimensions  DURALAST®		4792	192.30	1/2" CC	6
 <ul style="list-style-type: none"> • deck thickness: 1/8" to 2-3/4" rough-in deck • adjustable spout shank: 10" - 24" center dimensions  DURALOCK® DURALAST®		4793	217.80	1/2" CPVC, Crimp Ring PEX	6
		4794	207.65	1/2" Crimp Ring PEX, Cold Exp. PEX	6
 <ul style="list-style-type: none"> • deck thickness: 1/8" to 3-3/16" rough-in deck • Non-adjustable spout shank: 10" center dimensions  DURALAST®		4796	181.20	1/2" CC	6
		4797	184.70	1/2" CPVC, Crimp Ring PEX	6
		4798	184.70	1/2" Crimp Ring PEX, Cold Exp. PEX	6
For more product details, reference page 470 in valve section.					
HOW TO ORDER VALVES: PAGE 470		 TRIM PART # +  VALVE PART # =  COMPLETE FAUCET			

GENTA™ LX Collection













		MODEL	LIST	FINISH/CONNECT	CASE QTY			
M-CORE® TRANSFER VALVE TRIM								
 <ul style="list-style-type: none"> • use with the M-CORE® transfer valve • valve: sold separately  		UT2401	187.35	Chrome	12			
		UT2401BN	233.65	Brushed Nickel	12			
		UT2401BL	249.70	Matte Black	12			
M-CORE® TRANSFER VALVE								
Three Function (2 independent/1 shared) OR Six Function (3 independent/3 shared) - plumbing configuration page 478								
 <ul style="list-style-type: none"> • number of functions: three or six • ports: four 		U361CI	152.70	1/2" CC/IPS	6			
		U361CX	152.70	1/2" Cold Exp. PEX	6			
		U361X	152.70	1/2" Crimp Ring PEX	6			
Two Independent Functions OR Three Independent Functions - plumbing configurations page 478								
 <ul style="list-style-type: none"> • number of functions: two or three • ports: four 		U231CI	152.70	1/2" CC/IPS	6			
		U231CX	152.70	1/2" Cold Exp. PEX	6			
		U231X	152.70	1/2" Crimp Ring PEX	6			
For more product details, reference page 472 in valve section. See page 478 for plumbing configurations.								
HOW TO ORDER VALVES: PAGE 472		TRIM PART #	+		VALVE PART #	=		COMPLETE FAUCET

GENTA™ LX Collection













		MODEL	LIST	FINISH/CONNECT	CASE QTY
M-CORE® 2-SERIES TUB/SHOWER TRIM					
	<ul style="list-style-type: none"> • showerhead: six-function eco-performance • showerhead size: 4.5" diameter • tub spout length: 7" • tub spout connection type: slip fit • tub spout type: diverter • red/blue markings: included • includes: pressure balanced cartridge with temperature control • valve: sold separately 	1.75 GPM (6.65 L/min) max.			
		UT2473EP	234.10	Chrome	12
		UT2473EPBN	336.95	Brushed Nickel	12
		UT2473EPBL	358.40	Matte Black	12
M-CORE® 2-SERIES SHOWER ONLY TRIM					
	<ul style="list-style-type: none"> • showerhead type: showerhead sold separately • tub spout length: 7" • tub spout connection type: slip fit • tub spout type: diverter • red/blue markings: included • includes: pressure balanced cartridge with temperature control • valve: sold separately 	UT2473NH	218.10	Chrome	3
		UT2473NHBN	312.70	Brushed Nickel	3
		UT2473NHBL	331.65	Matte Black	3
		M-CORE® 2-SERIES SHOWER ONLY TRIM			
	<ul style="list-style-type: none"> • showerhead: six-function eco-performance • showerhead size: 4.5" diameter • red/blue markings: included • includes: pressure balanced cartridge with temperature control • valve: sold separately 	1.75 GPM (6.65 L/min) max.			
		UT2472EP	196.65	Chrome	12
		UT2472EPBN	274.40	Brushed Nickel	12
		UT2472EPBL	289.60	Matte Black	12
	<ul style="list-style-type: none"> • showerhead type: showerhead sold separately • red/blue markings: included • includes: pressure balanced cartridge with temperature control • valve: sold separately 	UT2472NH	193.00	Chrome	3
		UT2472NHBN	266.95	Brushed Nickel	3
		UT2472NHBL	281.30	Matte Black	3
		M-CORE® MIXING SHOWER VALVE			
	<ul style="list-style-type: none"> • tub/shower or shower only application • ports: four with adj. temp. limit stops • included: test plug and cross flow plug 	U140CI	72.60	1/2" CC/IPS	6
		U140X	72.60	1/2" Crimp Ring PEX + CC/IPS Tub	6
		U140CX	72.60	1/2" Cold Exp. PEX + CC/IPS Tub	6
		U140V	88.95	1/2" CPVC + CC/IPS Tub	6
	<ul style="list-style-type: none"> • tub/shower or shower only application • ports: four with adj. temp. limit stops • quarter turn stops: included 	U140CIS	104.50	1/2" CC/IPS	6
		U140XS	104.50	1/2" Crimp Ring PEX + CC/IPS Tub	6
		U140XS	104.50	1/2" Cold Exp. PEX + CC/IPS Tub	6
		U140VS	120.85	1/2" CPVC + CC/IPS Tub	6
	<ul style="list-style-type: none"> • shower only application • ports: three 	U130CI	72.60	1/2" CC/IPS	6
		U130X	72.60	1/2" Crimp Ring PEX	6
		U130CX	72.60	1/2" Cold Exp. PEX	6
	<ul style="list-style-type: none"> • shower only application • ports: three • quarter turn stops: included 	U130CIS	104.50	1/2" CC/IPS	6
		U130XS	104.50	1/2" Crimp Ring PEX	6
		U130CXS	104.50	1/2" Cold Exp. PEX	6
<p>Four port valves can be used with either Tub/Shower or Shower Only applications. Three port valves can ONLY be used with Shower Only applications. For more product details, reference page 471 in valve section.</p>					
<p>HOW TO ORDER VALVES: PAGE 471</p>		 TRIM PART #   VALVE PART #   COMPLETE FAUCET			



GENTA™ LX Collection















		MODEL	LIST	FINISH/CONNECT	CASE QTY	
M-CORE® 2-SERIES VALVE ONLY TRIM						
 <ul style="list-style-type: none"> • red/blue markings: included • includes: pressure balanced cartridge with temperature control • valve: sold separately 		UT2471	190.65	Chrome	3	
		UT2471BN	262.15	Brushed Nickel	3	
		UT2471BL	276.15	Matte Black	3	
M-CORE® MIXING SHOWER VALVE						
 <ul style="list-style-type: none"> • tub/shower or shower only application • ports: four with adj. temp. limit stops • included: test plug and cross flow plug 		U140CI	72.60	1/2" CC/IPS	6	
		U140X	72.60	1/2" Crimp Ring PEX + CC/IPS Tub	6	
		U140CX	72.60	1/2" Cold Exp. PEX + CC/IPS Tub	6	
		U140V	88.95	1/2" CPVC + CC/IPS Tub	6	
 <ul style="list-style-type: none"> • tub/shower or shower only application • ports: four with adj. temp. limit stops • quarter turn stops: included 		U140CIS	104.50	1/2" CC/IPS	6	
		U140XS	104.50	1/2" Crimp Ring PEX + CC/IPS Tub	6	
		U140CXS	104.50	1/2" Cold Exp. PEX + CC/IPS Tub	6	
		U140VS	120.85	1/2" CPVC + CC/IPS Tub	6	
 <ul style="list-style-type: none"> • shower only application • ports: three 		U130CI	72.60	1/2" CC/IPS	6	
		U130X	72.60	1/2" Crimp Ring PEX	6	
		U130CX	72.60	1/2" Cold Exp. PEX	6	
 <ul style="list-style-type: none"> • shower only application • ports: three • quarter turn stops: included 		U130CIS	104.50	1/2" CC/IPS	6	
		U130XS	104.50	1/2" Crimp Ring PEX	6	
		U130CXS	104.50	1/2" Cold Exp. PEX	6	
<p>Four port valves can be used with either Tub/Shower or Shower Only applications. Three port valves can ONLY be used with Shower Only applications. For more product details, reference page 471 in valve section.</p>						
<p>HOW TO ORDER VALVES: PAGE 471</p>		 <p>TRIM PART #</p>	+	 <p>VALVE PART #</p>	=	 <p>COMPLETE FAUCET</p>

GENTA™ LX Collection

		MODEL	LIST	FINISH/CONNECT	CASE QTY	
POSI-TEMP® TUB/SHOWER TRIM						
 <ul style="list-style-type: none"> • showerhead: six-function eco-performance • showerhead size: 4.5" diameter • tub spout length: 7" • tub spout connection type: slip fit • tub spout type: diverter • red/blue markings: included • valve: sold separately 		1.75 GPM (6.65 L/min) max.				
		T2473EP	111.50	Chrome	3	
		T2473EPBN	214.40	Brushed Nickel	3	
		T2473EPBL	235.75	Matte Black	3	
 <ul style="list-style-type: none"> • showerhead type: showerhead sold separately • tub spout length: 7" • tub spout connection type: slip fit • tub spout type: diverter • red/blue markings: included • valve: sold separately 		T2473NH	95.65	Chrome	3	
		T2473NHBN	190.10	Brushed Nickel	3	
		T2473NHBL	209.15	Matte Black	3	
POSI-TEMP® SHOWER ONLY TRIM						
 <ul style="list-style-type: none"> • showerhead: six-function eco-performance • showerhead size: 4.5" diameter • red/blue markings: included • valve: sold separately 		1.75 GPM (6.65 L/min) max.				
		T2472EP	74.10	Chrome	3	
		T2472EPBN	151.85	Brushed Nickel	3	
		T2472EPBL	167.10	Matte Black	3	
 <ul style="list-style-type: none"> • showerhead type: showerhead sold separately • red/blue markings: included • valve: sold separately 		T2472NH	70.40	Chrome	3	
		T2472NHBN	144.35	Brushed Nickel	3	
		T2472NHBL	158.75	Matte Black	3	
POSI-TEMP® VALVE ONLY TRIM						
 <ul style="list-style-type: none"> • red/blue markings: included • valve: sold separately 		T2471	68.15	Chrome	3	
		T2471BN	139.60	Brushed Nickel	3	
		T2471BL	153.60	Matte Black	3	
POSI-TEMP® SHOWER MIXING VALVES						
 <ul style="list-style-type: none"> • tub/shower or shower only application • ports: four with adjustable temp. limit stops • test plug: included 		2520 ◆	159.20	1/2" CC	6	
		2510 ◆	159.20	1/2" IPS	6	
 <ul style="list-style-type: none"> • tub/shower or shower only application • ports: four with adjustable temp. limit stops • quarter turn stops: included • test plug: included 		2570 ◆	193.35	1/2" CC	6	
		2590 ◆	193.35	1/2" IPS	6	
		2580 ◆	159.20	1/2" Crimp ring PEX	6	
 <ul style="list-style-type: none"> • tub/shower only application • ports: four with adjustable temp. limit stops • quarter turn stops: included • test plug: included 		2360PF	212.60	1/2" Crimp Ring PEX	3	
 <ul style="list-style-type: none"> • shower only application • ports: three with adjustable temp. limit stops • quarter turn stops: included • test plug: included 		2326PF	205.20	1/2" Crimp Ring PEX	6	
		2328PF	205.20	1/2" Cold Exp. PEX	6	
<p>Four port valves can be used with either Tub/Shower or Shower Only applications. Three port valves can ONLY be used with Shower Only applications. For more product details, reference page 473-476 in valve section.</p>						
HOW TO ORDER VALVES: PAGES 473-476		 TRIM PART #	+	 VALVE PART #	=	 COMPLETE FAUCET



GENTA™ LX Collection

		MODEL	LIST	FINISH/CONNECT	CASE QTY	
POSI-TEMP® WITH INTEGRATED TRANSFER VALVE TRIM						
 <ul style="list-style-type: none"> • red/blue markings: included • valve: sold separately  		T2470	101.15	Chrome	4	
		T2470BN	146.65	Brushed Nickel	4	
		T2470BL	157.95	Matte Black	4	
POSI-TEMP® WITH INTEGRATED TRANSFER VALVE						
 <ul style="list-style-type: none"> • functions: three (two independent and one shared) • ports: four with adjustable temp. limit stops • test plug: included 		2551	287.50	1/2" IPS	6	
 <ul style="list-style-type: none"> • functions: three (two independent and one shared) • ports: four with adjustable temp. limit stops • stops: included • test plug: included 		2581	323.75	1/2" IPS	6	
 <ul style="list-style-type: none"> • functions: two independent • ports: four with adjustable temp. limit stops • test plug: included 		2521	287.50	1/2" IPS	6	
 <ul style="list-style-type: none"> • functions: two independent • ports: four with adjustable temp. limit stops • stops: included • test plug: included 		2571	323.75	1/2" IPS	6	
For more product details, reference page 477 in valve section.						
HOW TO ORDER VALVES: PAGE 477		 TRIM PART #	+	 VALVE PART #	=	 COMPLETE FAUCET

GENTA™ LX

Moen® bath accessories CANNOT be combined with Moen faucet parts on a Purchase Order.

A line of matching accessories - including tank levers and towel bars - allow for a completely cohesive look in the bath.

MODEL NUMBER	LIST EACH	DESCRIPTION	QTY
Chrome (CH)			
BH3803CH	29.75	Single Robe Hook	12
Ⓟ BH3808CH	51.10	Pivoting Paper Holder	3
BH3818CH	51.50	18" Towel Bar	3
BH3824CH	55.90	24" Towel Bar	3
BH3886CH	41.00	Hand Towel Bar	3

Brushed Nickel (BN)			
BH3803BN	32.75	Single Robe Hook	24
Ⓟ BH3808BN	56.25	Pivoting Paper Holder	6
BH3818BN	56.65	18" Towel Bar	6
BH3824BN	61.45	24" Towel Bar	6
BH3886BN	45.15	Hand Towel Bar	6

Matte Black (BL)			
BH3803BL	36.05	Single Robe Hook	24
Ⓟ BH3808BL	61.85	Pivoting Paper Holder	6
BH3818BL	62.30	18" Towel Bar	6
BH3824BL	67.60	24" Towel Bar	6
BH3886BL	49.55	Hand Towel Bar	6

Ⓟ Denotes pivoting paper holder



Single Robe Hook
BH3803



Pivoting Paper Holder
BH3808 | Ⓟ



Hand Towel Bar
BH3886



18" Towel Bar
BH3818

24" Towel Bar
BH3824

GRAB BARS ♿

MODEL NUMBER	LIST EACH	DESCRIPTION	QTY
1 1/4" • Chrome (CH)			
MBHG3818CH	141.40	18" Designer Grab Bar	3 ▲

1 1/4" • Brushed Nickel (BN)			
MBHG3818BN	147.15	18" Designer Grab Bar	3 ▲

SECUREMOUNT™

- SecureMount™ Grab Bars are manufactured with an innovative flange design that makes it easy to connect to the stud at multiple points.
- Tested to withstand 500lbs.
- To install grab bars securely without studs, use SecureMount™ Anchors. Sold separately.



18" Designer Grab Bar
MBHG3818







▲ **Retail Packaging**













- ♿ Complies with Americans with Disabilities Act (ADA) specifications. SecureMount™ Grab Bars are tested to withstand 500 lb. pull when securely installed per instructions.

List price is per each (unless otherwise noted). Product can be ordered by case quantity or individually.



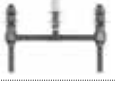































CHATEAU® Collection

		MODEL	LIST	FINISH/CONNECT	CASE QTY
ONE-HANDLE BATHROOM FAUCET					
	<ul style="list-style-type: none"> • application: three hole • center dimensions: 4" center • connection: 1/2" IPS • drain assembly: drain not included 	1.2 GPM (4.5L/min) max. L4601 ♦	175.70	Chrome	12
	<ul style="list-style-type: none"> • application: three hole • center dimensions: 4" center • connection: 1/2" IPS • drain assembly: drain not included • red/blue markings: included 	1.2 GPM (4.5L/min) max. L4605	175.70	Chrome	12
	<ul style="list-style-type: none"> • application: three hole • center dimensions: 4" center • connection: 1/2" IPS • drain assembly: metal with lift rod 	1.2 GPM (4.5L/min) max. L4621 ♦	217.05	Chrome	12
	<ul style="list-style-type: none"> • application: three hole • center dimensions: 4" center • supply line length: 16" • connection: 3/8" compression • drain assembly: metal with lift rod 	1.2 GPM (4.5L/min) max. L4625 ♦	217.05	Chrome	12
TWO-HANDLE CENTERSET BATHROOM FAUCET					
	<ul style="list-style-type: none"> • application: three hole • center dimensions: 4" center • connection: 1/2" IPS • drain assembly: metal with lift rod 	1.2 GPM (4.5L/min) max. 4925 ♦	199.70	Chrome	12
TWO-HANDLE WIDESPREAD BATHROOM FAUCET					
	<ul style="list-style-type: none"> • application: three hole • center dimensions: 8" - 16" center • connection: 1/2" IPS • drain assembly: metal with lift rod • includes: 9000 valve 	1.2 GPM (4.5L/min) max. 4945	349.70	Chrome	6









	MODEL	LIST	FINISH/CONNECT	CASE QTY
TWO-HANDLE ROMAN TUB TRIM				
 <ul style="list-style-type: none"> • application: three hole • spout reach: 9.00" • valve: sold separately 	T990	339.25	Chrome	6
 <ul style="list-style-type: none"> • for garden tub application • application: three hole • spout reach: 7.00" • valve: sold separately 	T994	209.25	Chrome	6
TWO-HANDLE ROMAN TUB VALVE				
 <ul style="list-style-type: none"> • deck thickness: 1/8" to 3-3/8" rough-in deck • adjustable spout shank: adjustable center dimensions  DURALAST®	4792	192.30	1/2" CC	6
 <ul style="list-style-type: none"> • deck thickness: 1/8" to 2-3/4" rough-in deck • adjustable spout shank: 10" - 24" center dimensions  DURALOCK® DURALAST®	4793	217.80	1/2" CPVC, Crimp Ring PEX	6
	4794	207.65	1/2" Crimp Ring PEX, Cold Exp. PEX	6
 <ul style="list-style-type: none"> • deck thickness: 1/8" to 3-3/16" rough-in deck • Non-adjustable spout shank: 10" center dimensions  DURALAST®	4796	181.20	1/2" CC	6
	4797	184.70	1/2" CPVC, Crimp Ring PEX	6
	4798	184.70	1/2" Crimp Ring PEX, Cold Exp. PEX	6
For more product details, reference page 470 in valve section.				
HOW TO ORDER VALVES: PAGE 470		 TRIM PART # +  VALVE PART # =  COMPLETE FAUCET		



		MODEL	LIST	FINISH/CONNECT	CASE QTY	
M-CORE® 2-SERIES TUB/SHOWER TRIM						
	<ul style="list-style-type: none"> • showerhead: single-function eco-performance • showerhead size: 2-1/2" diameter • tub spout length: 5 1/2" • tub spout connection type: slip fit • tub spout type: diverter • red/blue markings: included • includes: pressure balanced cartridge with temperature control • valve: sold separately 	1.75 GPM (6.65 L/min) max. UTL183EP	192.05	Chrome	12	
	<ul style="list-style-type: none"> • showerhead type: showerhead sold separately • tub spout length: 5 1/2" • tub spout connection type: slip fit • tub spout type: diverter • red/blue markings: included • includes: pressure balanced cartridge with temperature control • valve: sold separately 	UTL183NH	182.15	Chrome	12	
M-CORE® 2-SERIES SHOWER ONLY TRIM						
	<ul style="list-style-type: none"> • showerhead: single-function eco-performance • showerhead size: 2-1/2" diameter • red/blue markings: included • includes: pressure balanced cartridge with temperature control • valve: sold separately 	1.75 GPM (6.65 L/min) max. UTL182EP	160.90	Chrome	12	
	<ul style="list-style-type: none"> • showerhead type: showerhead sold separately • red/blue markings: included • includes: pressure balanced cartridge with temperature control • valve: sold separately 	UTL182NH	158.25	Chrome	12	
M-CORE® MIXING SHOWER VALVE						
	<ul style="list-style-type: none"> • tub/shower or shower only application • ports: four with adj. temp. limit stops • included: test plug and cross flow plug 	U140CI	72.60	1/2" CC/IPS	6	
		U140X	72.60	1/2" Crimp Ring PEX + CC/IPS Tub	6	
		U140CX	72.60	1/2" Cold Exp. PEX + CC/IPS Tub	6	
		U140V	88.95	1/2" CPVC + CC/IPS Tub	6	
	<ul style="list-style-type: none"> • tub/shower or shower only application • ports: four with adj. temp. limit stops • quarter turn stops: included 	U140CIS	104.50	1/2" CC/IPS	6	
		U140XS	104.50	1/2" Crimp Ring PEX + CC/IPS Tub	6	
		U140CXS	104.50	1/2" Cold Exp. PEX + CC/IPS Tub	6	
		U140VS	120.85	1/2" CPVC + CC/IPS Tub	6	
	<ul style="list-style-type: none"> • shower only application • ports: three 	U130CI	72.60	1/2" CC/IPS	6	
		U130X	72.60	1/2" Crimp Ring PEX	6	
		U130CX	72.60	1/2" Cold Exp. PEX	6	
	<ul style="list-style-type: none"> • shower only application • ports: three • quarter turn stops: included 	U130CIS	104.50	1/2" CC/IPS	6	
		U130XS	104.50	1/2" Crimp Ring PEX	6	
		U130CXS	104.50	1/2" Cold Exp. PEX	6	
Four port valves can be used with either Tub/Shower or Shower Only applications. Three port valves can ONLY be used with Shower Only applications. For more product details, reference page 471 in valve section.						
HOW TO ORDER VALVES: PAGE 471		 TRIM PART #	+	 VALVE PART #	=	 COMPLETE FAUCET













		MODEL	LIST	FINISH/CONNECT	CASE QTY
M-CORE® 2-SERIES VALVE ONLY TRIM					
 <ul style="list-style-type: none"> • red/blue markings: included • includes: pressure balanced cartridge with temperature control • valve: sold separately 		UTL181	156.35	Chrome	3
	M-CORE® MIXING SHOWER VALVE				
 <ul style="list-style-type: none"> • tub/shower or shower only application • ports: four with adj. temp. limit stops • included: test plug and cross flow plug 		U140CI	72.60	1/2" CC/IPS	6
		U140X	72.60	1/2" Crimp Ring PEX + CC/IPS Tub	6
		U140CX	72.60	1/2" Cold Exp. PEX + CC/IPS Tub	6
		U140V	88.95	1/2" CPVC + CC/IPS Tub	6
 <ul style="list-style-type: none"> • tub/shower or shower only application • ports: four with adj. temp. limit stops • quarter turn stops: included 		U140CIS	104.50	1/2" CC/IPS	6
		U140XS	104.50	1/2" Crimp Ring PEX + CC/IPS Tub	6
		U140CXS	104.50	1/2" Cold Exp. PEX + CC/IPS Tub	6
		U140VS	120.85	1/2" CPVC + CC/IPS Tub	6
 <ul style="list-style-type: none"> • shower only application • ports: three 		U130CI	72.60	1/2" CC/IPS	6
		U130X	72.60	1/2" Crimp Ring PEX	6
		U130CX	72.60	1/2" Cold Exp. PEX	6
 <ul style="list-style-type: none"> • shower only application • ports: three • quarter turn stops: included 		U130CIS	104.50	1/2" CC/IPS	6
		U130XS	104.50	1/2" Crimp Ring PEX	6
		U130CXS	104.50	1/2" Cold Exp. PEX	6
<p>Four port valves can be used with either Tub/Shower or Shower Only applications. Three port valves can ONLY be used with Shower Only applications. For more product details, reference page 471 in valve section.</p>					
<p>HOW TO ORDER VALVES: PAGE 471</p>		 <p>TRIM PART #</p> <p>+</p>  <p>VALVE PART #</p> <p>=</p>  <p>COMPLETE FAUCET</p>			









		MODEL	LIST	FINISH/CONNECT	CASE QTY
POSI-TEMP® TUB/SHOWER					
	<ul style="list-style-type: none"> • ports: four • connection: 1/2" CC • showerhead: single-function standard • showerhead size: 2-1/2" diameter • tub spout length: 5 1/2" • tub spout connection type: slip fit • tub spout type: diverter • red/blue markings: included • adjustable temp limit stop: included 	2.5 GPM (9.5 L/min) max. 2353	229.85	Chrome	12
	<ul style="list-style-type: none"> • ports: four • connection: 1/2" CC • showerhead: single-function standard • showerhead size: 2-1/2" diameter • tub spout length: 5 1/2" • tub spout connection type: slip fit • tub spout type: diverter • red/blue markings: included • adjustable temp limit stop: included • quarter turn stops: included 	2.5 GPM (9.5 L/min) max. 2363	262.70	Chrome	12
	<ul style="list-style-type: none"> • ports: four • connection: 1/2" CC • showerhead: single-function standard • showerhead size: 2-1/2" diameter • tub spout length: 5 1/2" • tub spout connection type: slip fit • tub spout type: diverter • red/blue markings: included • adjustable temp limit stop: included 	2.5 GPM (9.5 L/min) max. L2353	229.85	Chrome	6
	<ul style="list-style-type: none"> • ports: four • connection: 1/2" CC • showerhead: single-function standard • showerhead size: 2-1/2" diameter • tub spout length: 5 1/2" • tub spout connection type: slip fit • tub spout type: diverter • red/blue markings: included • adjustable temp limit stop: included • quarter turn stops: included 	2.5 GPM (9.5 L/min) max. L2363	262.70	Chrome	6
	<ul style="list-style-type: none"> • ports: four • connection: 1/2" CC • showerhead: single-function eco-performance • showerhead size: 2-1/2" diameter • tub spout length: 5 1/2" • tub spout connection type: slip fit • tub spout type: diverter • adjustable temp limit stop: included • quarter turn stops: included 	 1.75 GPM (6.65 L/min) max. L2369EP	313.85	Chrome	3





CHATEAU® Collection









MODEL LIST FINISH/CONNECT CASE QTY

POSI-TEMP® TUB/SHOWER TRIM					
	<ul style="list-style-type: none"> • showerhead: single-function standard • showerhead size: 2-1/2" diameter • tub spout length: 5 1/2" 	2.5 GPM (9.5 L/min) max.			
	<ul style="list-style-type: none"> • tub spout connection type: slip fit • tub spout type: diverter • red/blue markings: included • valve: sold separately 	TL183◆	81.25	Chrome	12
	<ul style="list-style-type: none"> • showerhead: single-function eco-performance • showerhead size: 2-1/2" diameter • tub spout length: 5 1/2" 	1.75 GPM (6.65 L/min) max.			
	<ul style="list-style-type: none"> • tub spout connection type: slip fit • tub spout type: diverter • used to replace: 2 or 3 hole shower valve • valve: sold separately 	TL183EP◆	81.25	Chrome	12
POSI-TEMP® SHOWER MIXING VALVES					
	<ul style="list-style-type: none"> • tub/shower or shower only application • ports: four with adjustable temp. limit stops • test plug: included 	2520◆	159.20	1/2" CC	6
		2510◆	159.20	1/2" IPS	6
	<ul style="list-style-type: none"> • tub/shower or shower only application • ports: four with adjustable temp. limit stops • quarter turn stops: included • test plug: included 	2570◆	193.35	1/2" CC	6
		2590◆	193.35	1/2" IPS	6
	2580◆	159.20	1/2" Crimp ring PEX	6	
		2360PF	212.60	1/2" Crimp Ring PEX	3
	<ul style="list-style-type: none"> • shower only application • ports: three with adjustable temp. limit stops • quarter turn stops: included • test plug: included 	2326PF	205.20	1/2" Crimp Ring PEX	6
		2328PF	205.20	1/2" Cold Exp. PEX	6
<p>Four port valves can be used with either Tub/Shower or Shower Only applications. Three port valves can ONLY be used with Shower Only applications. For more product details, reference page 473-476 in valve section.</p>					
<p>HOW TO ORDER VALVES: PAGES 473-476</p>	 <p>TRIM PART #</p>	+	 <p>VALVE PART #</p>	=	 <p>COMPLETE FAUCET</p>



		MODEL	LIST	FINISH/CONNECT	CASE QTY
POSI-TEMP® SHOWER ONLY					
	<ul style="list-style-type: none"> • ports: four • connection: 1/2" CC • showerhead: single-function standard • showerhead size: 2-1/2" diameter • red/blue markings: included • adjustable temp limit stop: included 	2.5 GPM (9.5 L/min) max. L2352	201.25	Chrome	6
	<ul style="list-style-type: none"> • ports: four • connection: 1/2" CC • showerhead: single-function standard • showerhead size: 2-1/2" diameter • red/blue markings: included • adjustable temp limit stop: included • quarter turn stops: included 	2.5 GPM (9.5 L/min) max. L2362	233.90	Chrome	6
	<ul style="list-style-type: none"> • ports: four • connection: 1/2" CC • showerhead: single-function eco-performance • showerhead size: 2-1/2" diameter • red/blue markings: included • adjustable temp limit stop: included • quarter turn stops: included • used to replace: 2 or 3 hole shower valve 	 1.75 GPM (6.65 L/min) max. L2368EP	290.90	Chrome	3

















POSI-TEMP® SHOWER ONLY TRIM					
	<ul style="list-style-type: none"> • showerhead: single-function standard • showerhead size: 2-1/2" diameter • red/blue markings: included • valve: sold separately 	2.5 GPM (9.5 L/min) max. TL182 ♦	50.05	Chrome	12
	<ul style="list-style-type: none"> • showerhead: single-function eco-performance • showerhead size: 2-1/2" diameter • used to replace: 2 or 3 hole shower valve • valve: sold separately 	 1.75 GPM (6.65 L/min) max. TL2368EP	105.45	Chrome	6

POSI-TEMP® SHOWER MIXING VALVES						
		• tub/shower or shower only application	2520 ♦	159.20	1/2" CC	6
		• ports: four with adjustable temp. limit stops	2510 ♦	159.20	1/2" IPS	6
		• tub/shower or shower only application	2570 ♦	193.35	1/2" CC	6
		• ports: four with adjustable temp. limit stops	2590 ♦	193.35	1/2" IPS	6
		• quarter turn stops: included	2580 ♦	159.20	1/2" Crimp ring PEX	6
		• test plug: included	2360PF	212.60	1/2" Crimp Ring PEX	3
		• tub/shower only application				
		• ports: four with adjustable temp. limit stops	2326PF	205.20	1/2" Crimp Ring PEX	6
		• quarter turn stops: included	2328PF	205.20	1/2" Cold Exp. PEX	6
		• test plug: included				



Four port valves can be used with either Tub/Shower or Shower Only applications. Three port valves can ONLY be used with Shower Only applications. For more product details, reference page 473-476 in valve section.

HOW TO ORDER
VALVES:
PAGES 473-476



		MODEL	LIST	FINISH/CONNECT	CASE QTY				
POSI-TEMP® VALVE ONLY									
	<ul style="list-style-type: none"> • ports: four • connection: 1/2" CC • red/blue markings: included • adjustable temp limit stop: included • quarter turn stops: included 	L2361	219.10	Chrome	6				
POSI-TEMP® VALVE ONLY TRIM									
	<ul style="list-style-type: none"> • red/blue markings: included • valve: sold separately 	T181 ◆	45.45	Chrome	12				
	<ul style="list-style-type: none"> • red/blue markings: included • valve: sold separately 	TL181 ◆	45.45	Chrome	12				
POSI-TEMP® SHOWER MIXING VALVES									
	<ul style="list-style-type: none"> • tub/shower or shower only application • ports: four with adjustable temp. limit stops • test plug: included 	2520 ◆	159.20	1/2" CC	6				
		2510 ◆	159.20	1/2" IPS	6				
	<ul style="list-style-type: none"> • tub/shower or shower only application • ports: four with adjustable temp. limit stops • quarter turn stops: included • test plug: included 	2570 ◆	193.35	1/2" CC	6				
		2590 ◆	193.35	1/2" IPS	6				
		2580 ◆	159.20	1/2" Crimp ring PEX	6				
	<ul style="list-style-type: none"> • tub/shower only application • ports: four with adjustable temp. limit stops • quarter turn stops: included • test plug: included 	2360PF	212.60	1/2" Crimp Ring PEX	3				
	<ul style="list-style-type: none"> • shower only application • ports: three with adjustable temp. limit stops • quarter turn stops: included • test plug: included 	2326PF	205.20	1/2" Crimp Ring PEX	6				
		2328PF	205.20	1/2" Cold Exp. PEX	6				
<p>Four port valves can be used with either Tub/Shower or Shower Only applications. Three port valves can ONLY be used with Shower Only applications. For more product details, reference page 473-476 in valve section.</p>									
<p>HOW TO ORDER VALVES: PAGES 473-476</p>			<p>TRIM PART #</p>	+		<p>VALVE PART #</p>	=		<p>COMPLETE FAUCET</p>



		MODEL	LIST	FINISH/CONNECT	CASE QTY
THREE-HANDLE NON-PRESSURE BALANCED TUB/SHOWER					
	<ul style="list-style-type: none"> • ports: four • connection: 1/2" CC; IPS • showerhead: single-function eco-performance • showerhead size: 2-1/2" diameter • tub spout length: 5 1/2" • tub spout connection type: IPS • tub spout type: non diverter 	<p>1.75 GPM (6.65 L/min) max.</p> <p>2995EP</p>	263.85	Chrome	6
TWO-HANDLE NON-PRESSURE BALANCED TUB/SHOWER					
	<ul style="list-style-type: none"> • ports: four • connection: 1/2" CC • showerhead: single-function eco-performance • showerhead size: 2-1/2" diameter • tub spout length: 5 1/2" • tub spout connection type: slip fit • tub spout type: diverter 	<p>1.75 GPM (6.65 L/min) max.</p> <p>2919EP</p>	225.60	Chrome	6
	<ul style="list-style-type: none"> • ports: four • connection: 1/2" IPS • showerhead: single-function eco-performance • showerhead size: 2-1/2" diameter • tub spout length: 5 1/2" • tub spout connection: 1/2" IPS • tub spout type: diverter 	<p>1.75 GPM (6.65 L/min) max.</p> <p>2982EP</p>	225.60	Chrome	6

Moen® bath accessories CANNOT be combined with Moen faucet parts on a Purchase Order.

COORDINATING ACCESSORIES

Complimentary styles for a cohesive look. From robe hooks to towel bars, paper holders to knobs and pulls, Moen offers a variety of coordinating accessories to complete any room.

MODEL NUMBER	LIST EACH	DESCRIPTION	QTY
Chrome (CH)			
YB8000CH	6.10	Mounting Posts (Pair)	50
YB8003CH	5.35	Double Robe Hook	50
YB8086CH	10.10	Towel Ring	50
YB8094CH	5.10	24" Towel Bar (Bar Only)	50
YB8098CH	4.40	18" Towel Bar (Bar Only)	50
YB8099CH	2.15	Paper Holder (Roller Only)	50
Brushed Chrome (BC)			
YB8000BC	7.80	Mounting Posts (Pair)	50
YB8003BC	6.85	Double Robe Hook	50
YB8086BC	13.30	Towel Ring	50
YB8094BC	6.60	24" Towel Bar (Bar Only)	50
YB8098BC	5.55	18" Towel Bar (Bar Only)	50
YB8099BC	3.60	Paper Holder (Roller Only)	50
Satin Nickel (SN)			
YB8000SN	10.10	Mounting Posts (Pair)	50
YB8003SN	7.00	Double Robe Hook	50
YB8086SN	14.45	Towel Ring	50
YB8094SN	8.35	24" Towel Bar (Bar Only)	50
YB8098SN	6.75	18" Towel Bar (Bar Only)	50
YB8099SN	3.25	Paper Holder (Roller Only)	50
Old World Bronze (OWB)			
YB8000OWB	13.10	Mounting Posts (Pair)	50
YB8003OWB	8.00	Double Robe Hook	50
YB8086OWB	15.45	Towel Ring	50
YB8094OWB	10.35	24" Towel Bar (Bar Only)	50
YB8098OWB	7.80	18" Towel Bar (Bar Only)	50
YB8099OWB	2.75	Paper Holder (Roller Only)	50
Pro-Fit® Installation Mounting Template			
YB8081	15.20	Pro-Fit® Installation Mounting Template	25



Double Robe Hook
YB8003



Towel Ring
YB8086



Paper Holder
YB8099 | Roller Only



18" Towel Bar
YB8098 | Bar Only

Mounting Posts (Pair)
YB8000

24" Towel Bar
YB8094 | Bar Only

Mounting Posts (Pair)
YB8000



Pro-Fit® Installation Mounting Template
YB8081

(See page 528 for more information about the Pro-Fit® Installation System.)





Custom Showering

Indulge in a shower experience as unique as you are. From chic rainshowers to innovative smart home solutions and handshowers with Magnetix™ technology, Moen® provides a range of options to match your style and specific preferences. Elevate your daily ritual with a shower tailored just for you.

Verso® Rainshower | 220R5BG



Custom Showering

Spa and Custom Showering options

FINISHES

Chrome

Brushed Nickel

Brushed Gold

Polished Nickel

Oil Rubbed Bronze

Wrought Iron/Matte Black

Brushed Chrome

LifeShine® Non-Tarnish Finish

All Brushed Nickel, Brushed Gold and Polished Nickel faucet components feature the LifeShine Non-Tarnish Finish.

Wrought Iron/Matte Black

Wrought Iron and Matte Black are the same finish and interchangeable.

ICON KEY

MAGNETIX

Magnetic docking system. Showerhead detaches effortlessly, then returns with a telltale snap that lets you know it's securely docked.



WaterSense Labeled

Product has been tested and is certified to meet EPA flow control criteria.



IMMERSION

Immersion™ Rainshower

Immersion Rainshower's innovative technology provides optimal water pressure and excellent coverage for an unparalleled shower experience.



Moen® M•PACT® Common Valve System

With M•PACT, you can change your faucet style without replacing any plumbing. It's as easy as changing a light bulb.

DURALOCK®

Push-button connector that makes installing faucets quick, secure and hassle-free – no tools required. A telltale 'click' audibly signals a secure connection.

DURALAST®

Provides the smooth feel and reliable operation of a new faucet from the first time you use it to the last.



Also available in bulk pack.
See page 597.



Available in bulk pack only.



Smart Shower Options



Moen has all the components necessary for you to build a custom shower spa. And, we're making it easy for you to pull together the different items you need. Charts of common shower spa configurations are included so that all the components can be ordered. The charts below each illustrate one potential layout with option of showering components. Refer to pages 437 - 466 in the Custom Showering section to choose from our wide array of showering products, styles and finishes to meet your preference. For additional assistance, call your Moen Sales Representative.



CUSTOM SHOWERING

MOEN SMART SHOWER SPA WITH SHOWERHEAD, HANDSHOWER & FLUSHMOUNT BODY SPRAYS

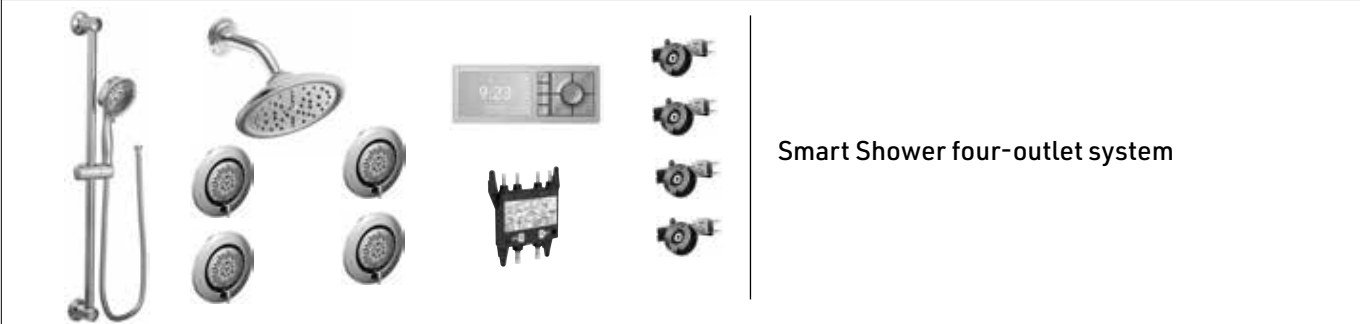

Smart Shower four-outlet system

Moen Smart Shower four-outlet controller	Moen Smart Shower four-outlet valve	Rainshower	Shower arm & flange	Multi-function body spray* & quantity	Body spray rough-in & quantity	Four-function handheld shower with slide bar	Drop ell
TS3304TB or TB3304BL	S3104	S6310	S122	TS1422 x 4	S1300 x 4	3667EP	A725

* Option: Round single function body spray TS1322

Optional	Product
Battery backup (black)	179573

MOEN SMART SHOWER SPA WITH SHOWERHEAD, HANDSHOWER & EXPOSED BODY SPRAYS

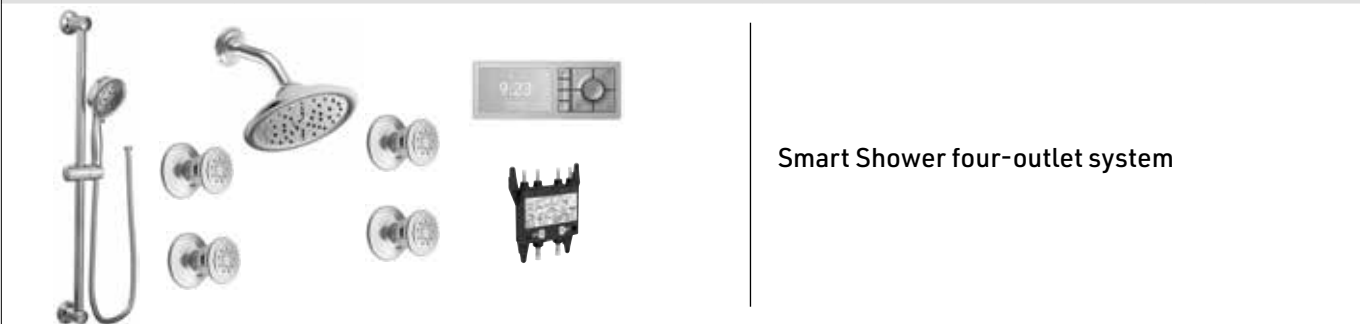

Smart Shower four-outlet system

Moen Smart Shower four-outlet controller	Moen Smart Shower four-outlet valve	Rainshower	Shower arm & flange	Single function body spray & quantity	Four-function handheld shower with slide bar	Drop ell
TS3304TB or TB3304BL	S3104	S6310	S122	A501 x 4	3667EP	A725

Optional	Product
Battery backup (black)	179573

Smart Shower Configurations

CUSTOM SHOWERING

MOEN SMART SHOWER SHOWER SPA WITH SHOWERHEAD & FLUSHMOUNT BODY SPRAYS



Smart Shower two-outlet system.

Moen Smart Shower two outlet controller	Moen Smart Shower two outlet valve	Rainshower	Shower arm & flange	Multi-function body spray* & quantity	Body spray rough-in & quantity
TS3302TB or TB3302BL	S3102	S6310	S122	TS1422 x 3	S1300 x 3

* Option: Round single function body spray TS1322

Optional	Product
Battery backup (black)	179573

MOEN SMART SHOWER SHOWER SPA WITH SHOWERHEAD & HANDSHOWER



Smart Shower two-outlet system.

Moen Smart Shower two-outlet controller	Moen Smart Shower two-outlet valve	Rainshower	Shower arm & flange	Handshower	Drop ell
TS3302TB or TB3302BL	S3102	S6310	S122	3667EP	A725

Valve	Flow Rate @ 20 PSI	Flow Rate @ 40 PSI	Flow Rate @ 60 PSI	Used with 2- or 3-Function Transfer	Maximum Components
Moen Smart Shower S3104	9.0	13.0	16.0	No	4 Components: Any combination of Showerheads, Handshowers and Body Sprays (4 Max)
Moen Smart Shower S3102	6.0	8.5	10.0	No	Showerhead, Handshower or Showerhead, 2 Body Sprays

Smart Shower Configurations

CUSTOM SHOWERING

MOEN® SMART SHOWER 4 OUTLET THERMOSTATIC CONTROLLER - PREMIUM

- description: Wi-Fi connected, app driven shower controller
- precise temperature control
- warm-up and pause mode
- optional shower timer
- compatible with Amazon Alexa, Apple Homekit/ Siri and Google Assistant
- Moen Smart Water App available for Apple iOS and Android OS
- remote activation via smartphone app
- presets: two on controller, 12 in total with smart phone app
- valve sold separately



TS3304TB	859.30	Terra Beige	3
TS3304BL	859.30	Matte Black	3

SMART SHOWER 4 OUTLET VALVE - PREMIUM



- description: digital thermostatic shower valve
- ports: four outlets
- features: precise temperature control
- connection size: 3/4" inlets & 1/2" outlets
- includes: 30 foot data cable
- battery backup: sold separately

S3104	1,836.30	3/4" CC	3
BATTERY BACKUP SOLD SEPARATELY			
179573	78.30	N/A	6

MOEN® SMART SHOWER 2 OUTLET THERMOSTATIC CONTROLLER - PREMIUM

- description: Wi-Fi connected, app driven shower controller
- precise temperature control
- warm-up and pause mode
- optional shower timer
- compatible with Amazon Alexa, Apple Homekit/ Siri and Google Assistant
- Moen Smart Water App available for Apple iOS and Android OS
- remote activation via smartphone app
- presets: two on controller, 12 in total with smart phone app
- valve sold separately



TS3302TB	565.05	Terra Beige	3
TS3302BL	565.05	Matte Black	3

SMART SHOWER 2 OUTLET VALVE - PREMIUM



- description: digital thermostatic shower valve
- ports: two outlets
- features: precise temperature control
- connection size: 1/2" inlets & 1/2" outlets
- includes: 30 foot data cable
- battery backup: sold separately

S3102	1128.00	1/2" CC	3
BATTERY BACKUP SOLD SEPARATELY			
179573	130.05	N/A	6

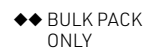
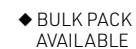

3/4" THERMOSTATIC SHOWERING**ExactTemp® 3/4" Thermostatic Valve and Showering**

Moen has all the components necessary for you to build a custom shower spa. And, we're making it easy for you to pull together the sku numbers you need. Charts of common shower spa configurations are included so that all the components can be ordered. The charts below illustrate one layout and option of showering components. Refer to pages 437 - 466 in the Custom Showering section to choose from our wide array of showering products, styles and finishes to meet your preference. For additional assistance, call your Moen Sales Representative.

**EXACTTEMP® SHOWER SPA WITH SHOWERHEAD, HANDSHOWER & FLUSHMOUNT BODY SPRAYS**

Weymouth® suite shown.

Suite	ExactTemp Valve Only Trim	ExactTemp Valve	Volume Control Trim and Quantity	Volume Control Valve and Quantity	Showerhead	Shower Arm and Flange	Multi-Function Body Spray* and Quantity	Body Spray Rough-in and Quantity	Handheld Shower with Slide Bar	Drop Ell
Weymouth®	TS32110	S3371	TS52104 x 3	S3600 x 3	S1311	S113	TS1422 x 4	S1300 x 4	S12107EP	A725
Arris®	TS33002	S3371	TS33003 x 3	S3600 x 3	S112	S110	TS1422 x 4	S1300 x 4	3887EP	A725
Flara™	TS4201	S3371	TS4202 x 3	S3600 x 3	S6365	123815 + 137488	TS1422 x 4	S1300 x 4	S3880EP	A725
Colinet™	TS44401	S3371	TS44402 x 3	S3600 x 3	A112	151380 + AT2199	TS1422 x 4	S1300 x 4	3887EP	A725
90°®	TS3100	S3371	TS3300 x 3	S3600 x 3	S6340	S122	TS1420 x 4	S1300 x 4	S3880EP	A721
Doux™	TS3101	S3371	TS3102 x 3	S3600 x 3	S176	S122	TS1422 x 4	S1300 x 4	3887EP	A725
Greenfield™	T4401	S3371	T4402 x 3	S3600 x 3	S178	S134	TS1422 x 4	S1300 x 4	3887EP	A725
Wynford®	T6601	S3371	T6602 x 3	S3600 x 3	S6310	S122	TS1422 x 4	S1300 x 4	3667EP	A725
Align®	T4291	S3371	T4292 x 3	S3600 x 3	S176	S122	TS1422 x 4	S1300 x 4	3887EP	A725
Belfield™	T4411	S3371	T4412 x 3	S3600 x 3	S6310	S122	TS1422 x 4	S1300 x 4	3667EP	A725
Cia™	T4621	S3371	T4622 x 3	S3600 x 3	S112	S122	TS1422 x 4	S1300 x 4	3887EP	A725
Voss™	T4691	S3371	T4692 x 3	S3600 x 3	S6365	161951	TS1420 x 4	S1300 x 4	3988EP	A721
Moen	TS3411	S3371	TS3600 x 3	S3600 x 3	S6310	S122	TS1422 x 4	S1300 x 4	3667EP	A725

* Option: Round single function body spray TS1322

* Option: Square single function body spray TS1320

Diverter tub spout options on pages 459-461.

Showering extension kits available on page 557.

Matching tub and shower drains available. See page 466.

Valve	Flow Rate through shower port (GPM) @ 20 PSI	Flow Rate through shower port (GPM) @ 40 PSI	Flow Rate through shower port (GPM) @ 60 PSI	Used with 2- or 3-Function Transfer	Maximum Components
3/4" ExactTemp S3371	11.4	15.7	18.0	No	4 Components: Any combination of Showerheads, Handshowers and Body Sprays (4 Max)

ExactTemp® 3/4" Thermostatic Showering Configurations

CUSTOM SHOWERING

EXACTTEMP® SHOWER SPA WITH SHOWERHEAD, HANDSHOWER & EXPOSED MOUNT BODY SPRAYS



Weymouth® suite shown.

Suite	ExactTemp Valve Only Trim	ExactTemp Valve	Volume Control Trim and Quantity	Volume Control Valve and Quantity	Showerhead	Shower Arm and Flange	Single Function Body Spray and Quantity	Handheld Shower with Slide Bar	Drop Ell
Weymouth®	TS32110	S3371	TS52104 x 3	S3600 x 3	S1311	S113	A501 x 4	S12107EP	A725
Arris®	TS33002	S3371	TS33003 x 3	S3600 x 3	S112	S110	A501 x 4	3887EP	A725
Flara™	TS4201	S3371	TS4202 x 3	S3600 x 3	S6365	123815 + 137488	A501 x 4	S3880EP	A725
Colinet™	TS44401	S3371	TS44402 x 3	S3600 x 3	A112	151380 + AT2199	A501 x 4	3887EP	A725
90°®	TS3100	S3371	TS3300 x 3	S3600 x 3	S6340	S122	A501 x 4	S3880EP	A721
Doux™	TS3101	S3371	TS3102 x 3	S3600 x 3	S176	S122	A501 x 4	3887EP	A725
Greenfield™	T4401	S3371	T4402 x 3	S3600 x 3	S178	S134	A501 x 4	3887EP	A725
Wynford®	T6601	S3371	T6602 x 3	S3600 x 3	S6310	S122	A501 x 4	3667EP	A725
Align®	T4291	S3371	T4292 x 3	S3600 x 3	S176	S122	A501 x 4	3887EP	A725
Belfield™	T4411	S3371	T4412 x 3	S3600 x 3	S6310	S122	A501 x 4	3667EP	A725
Cia™	T4621	S3371	T4622 x 3	S3600 x 3	S112	S122	A501 x 4	3887EP	A725
Voss™	T4691	S3371	T4692 x 3	S3600 x 3	S6365	161951	A501 x 4	3988EP	A721
Moen	TS3411	S3371	TS3600 x 3	S3600 x 3	S6310	S122	A501 x 4	3667EP	A725

Diverter tub spout options on pages 459-461.
 Showering extension kits available on page 557.
 Matching tub and shower drains available. See page 466.

Valve	Flow Rate through shower port (GPM) @ 20 PSI	Flow Rate through shower port (GPM) @ 40 PSI	Flow Rate through shower port (GPM) @ 60 PSI	Used with 2- or 3-Function Transfer	Maximum Components
3/4" ExactTemp S3371	11.4	15.7	18.0	No	4 Components: Any combination of Showerheads, Handshowers and Body Sprays (4 Max)

ExactTemp® 3/4" Thermostatic Showering Configurations

EXACTTEMP® SHOWER SPA WITH SHOWERHEAD & HANDSHOWER



Flara™ suite shown.

Suite	ExactTemp Valve Only Trim	ExactTemp Valve	Volume Control Trim and Quantity	Volume Control Valve and Quantity	Showerhead	Shower Arm and Flange	Handheld Shower with Slide Bar	Drop Ell
Weymouth®	TS32110	S3371	TS52104 x 2	S3600 x 2	S1311	S113	S12107EP	A725
Arris®	TS33002	S3371	TS33003 x 2	S3600 x 2	S112	S110	3887EP	A725
Flara™	TS4201	S3371	TS4202 x 2	S3600 x 2	S6365	123815 + 137488	S3880EP	A725
Colinet™	TS44401	S3371	TS44402 x 2	S3600 x 2	S112	151380 + AT2199	3887EP	A725
90°®	TS3100	S3371	TS3300 x 2	S3600 x 2	S6340	S122	S3880EP	A721
Doux™	TS3101	S3371	TS3102 x 2	S3600 x 2	S176	S122	3887EP	A725
Greenfield™	T4401	S3371	T4402 x 2	S3600 x 2	S178	S134	3887EP	A725
Wynford®	T6601	S3371	T6602 x 2	S3600 x 2	S6310	S122	3667EP	A725
Align®	T4291	S3371	T4292 x 2	S3600 x 2	S176	S122	3887EP	A725
Belfield™	T4411	S3371	T4412 x 2	S3600 x 2	S6310	S122	3667EP	A725
Cia™	T4621	S3371	T4622 x 2	S3600 x 2	S112	S122	3887EP	A725
Voss™	T4691	S3371	T4692 x 2	S3600 x 2	S6365	161951	3988EP	A721
Moen	TS3411	S3371	TS3600 x 2	S3600 x 2	S6310	S122	3667EP	A725

Diverter tub spout options on pages 459-461.



















Showering extension kits available on page 557.

Matching tub and shower drains available. See page 466.



















Valve	Flow Rate through shower port (GPM) @ 20 PSI	Flow Rate through shower port (GPM) @ 40 PSI	Flow Rate through shower port (GPM) @ 60 PSI	Used with 2- or 3-Function Transfer	Maximum Components
3/4" ExactTemp S3371	11.4	15.7	18.0	No	4 Components: Any combination of Showerheads, Handshowers and Body Sprays (4 Max)

ExactTemp® 3/4" Thermostatic Showering Options



























CUSTOM SHOWERING

MOEN®		EXACTTEMP® SHOWER ONLY TRIM - PREMIUM			
	<ul style="list-style-type: none"> • showerhead: single-function rainshower • showerhead size: 7" diameter • requires: separate volume control valve • valve: sold separately 		2.5 GPM (9.5 L/min) max.		
		TS3400	663.45	Chrome	3
		TS3400BN	1127.40	Brushed Nickel	3
		TS3400ORB	1183.60	Oil Rubbed Bronze	3
		IMMERSION			
WEYMOUTH®		EXACTTEMP® VALVE ONLY TRIM - PREMIUM			
	<ul style="list-style-type: none"> • description: temperature control valve trim • requires: separate volume control valve • valve: sold separately 	TS32110	496.00	Chrome	3
		TS32110BN	730.00	Brushed Nickel	3
		TS32110NL	730.00	Polished Nickel	3
		TS32110BG	730.00	Brushed Gold	3
		TS32110BL	787.50	Matte Black	3
		TS32110ORB	787.50	Oil Rubbed Bronze	3
					
WEYMOUTH®		EXACTTEMP® VOLUME CONTROL VALVE TRIM - PREMIUM			
	<ul style="list-style-type: none"> • valve: sold separately 	TS52104	257.50	Chrome	6
		TS52104BN	355.75	Brushed Nickel	6
		TS52104NL	355.75	Polished Nickel	6
		TS52104BG	355.75	Brushed Gold	6
		TS52104BL	383.55	Matte Black	6
		TS52104ORB	383.55	Oil Rubbed Bronze	6
					
ARRIS®		EXACTTEMP® VALVE ONLY TRIM - PREMIUM			
	<ul style="list-style-type: none"> • description: temperature control valve trim • requires: separate volume control valve • valve: sold separately 	TS33002	407.80	Chrome	3
		TS33002BL	673.00	Matte Black	3
					
ARRIS®		EXACTTEMP® VOLUME CONTROL VALVE TRIM - PREMIUM			
	<ul style="list-style-type: none"> • valve: sold separately 	TS33003	232.95	Chrome	6
		TS33003BL	373.95	Matte Black	6
					
FLARA™		EXACTTEMP® VALVE ONLY TRIM - PREMIUM			
	<ul style="list-style-type: none"> • description: temperature control valve trim • requires: separate volume control valve • valve: sold separately 	TS4201	410.05	Chrome	3
		TS4201BN	615.05	Brushed Nickel	3
		TS4201NL	615.05	Polished Nickel	3
		TS4201BG	615.05	Brushed Gold	3
					
FLARA™		EXACTTEMP® VOLUME CONTROL VALVE TRIM - PREMIUM			
	<ul style="list-style-type: none"> • valve: sold separately 	TS4202	189.20	Chrome	6
		TS4202BN	283.95	Brushed Nickel	6
		TS4202NL	283.95	Polished Nickel	6
		TS4202BG	283.95	Brushed Gold	6
					
COLINET™		EXACTTEMP® VALVE ONLY TRIM - PREMIUM			
	<ul style="list-style-type: none"> • description: temperature control valve trim • requires: separate volume control valve • valve: sold separately 	TS44401	392.20	Chrome	3
		TS44401BN	588.25	Brushed Nickel	3
		TS44401BG	588.25	Brushed Gold	3
		TS44401BL	647.15	Matte Black	3
					
COLINET™		EXACTTEMP® VOLUME CONTROL VALVE TRIM - PREMIUM			
	<ul style="list-style-type: none"> • valve: sold separately 	TS44402	181.05	Chrome	6
		TS44402BN	271.65	Brushed Nickel	6
		TS44402BG	271.65	Brushed Gold	6
		TS44402BL	298.75	Matte Black	6
					

ExactTemp® 3/4" Thermostatic Showering Options

		MODEL	LIST	FINISH/CONNECT	CASE QTY
	90°™ EXACTTEMP® VALVE ONLY TRIM - PREMIUM				
	• description: temperature control valve trim	TS3100	406.20	Chrome	3
	• requires: separate volume control valve	TS3100BN	614.45	Brushed Nickel	3
	• valve: sold separately	TS3100BL	629.60	Matte Black	3
					
	90°™ EXACTTEMP® VOLUME CONTROL VALVE TRIM - PREMIUM				
	• valve: sold separately	TS3300	187.55	Chrome	6
		TS3300BN	250.05	Brushed Nickel	6
		TS3300BL	253.10	Matte Black	6
					
	DOUX™ EXACTTEMP® VALVE ONLY TRIM - PREMIUM				
	• description: temperature control valve trim	TS3101	429.90	Chrome	3
	• requires: separate volume control valve	TS3101BN	623.25	Brushed Nickel	3
	• valve: sold separately	TS3101BL	685.60	Matte Black	3
					
	DOUX™ EXACTTEMP® VOLUME CONTROL VALVE TRIM - PREMIUM				
	• valve: sold separately	TS3102	198.40	Chrome	6
		TS3102BN	287.75	Brushed Nickel	6
		TS3102BL	316.45	Matte Black	6
					
	GREENFIELD™ EXACTTEMP® VALVE ONLY TRIM				
	• description: temperature control valve trim	T4401	309.60	Chrome	3
	• requires: separate volume control valve	T4401BN	467.55	Brushed Nickel	3
	• valve: sold separately	T4401BG	467.55	Brushed Gold	3
		T4401BL	503.10	Matte Black	3
					
	GREENFIELD™ EXACTTEMP® VOLUME CONTROL VALVE TRIM				
	• valve: sold separately	T4402	157.60	Chrome	6
		T4402BN	237.55	Brushed Nickel	6
		T4402BG	237.55	Brushed Gold	6
		T4402BL	256.15	Matte Black	6
					
	WYNFORD® EXACTTEMP® VALVE ONLY TRIM				
	• description: temperature control valve trim	T6601	310.40	Chrome	3
	• requires: separate volume control valve	T6601BN	467.55	Brushed Nickel	3
	• valve: sold separately	T6601ORB	504.40	Oil Rubbed Bronze	3
					
	WYNFORD® EXACTTEMP® VOLUME CONTROL VALVE TRIM				
	• valve: sold separately	T6602	157.60	Chrome	6
		T6602BN	237.55	Brushed Nickel	6
		T6602ORB	256.15	Oil Rubbed Bronze	6
					
	ALIGN® EXACTTEMP® VALVE ONLY TRIM				
	• description: temperature control valve trim	T4291	309.60	Chrome	3
	• requires: separate volume control valve	T4291BN	467.55	Brushed Nickel	3
	• valve: sold separately	T4291BG	467.55	Brushed Gold	3
		T4291BL	503.10	Matte Black	3
					

ExactTemp® 3/4" Thermostatic Showering Options

		MODEL	LIST	FINISH/CONNECT	CASE QTY
	EXACTTEMP® VOLUME CONTROL VALVE TRIM • valve: sold separately  	T4292	157.60	Chrome	6
		T4292BN	237.55	Brushed Nickel	6
		T4292BG	237.55	Brushed Gold	6
		T4292BL	256.15	Matte Black	6
		BELFIELD™ EXACTTEMP® VALVE ONLY TRIM			
	• description: temperature control valve trim • requires: separate volume control valve • valve: sold separately  	T4411	310.40	Chrome	3
		T4411BN	467.55	Brushed Nickel	3
		T4411NL	467.55	Polished Nickel	3
		T4411BL	481.10	Matte Black	3
		T4411ORB	504.40	Oil Rubbed Bronze	3
BELFIELD™ EXACTTEMP® VOLUME CONTROL VALVE TRIM					
	• valve: sold separately  	T4412	157.60	Chrome	6
		T4412BN	237.55	Brushed Nickel	6
		T4412NL	237.55	Polished Nickel	6
		T4412BL	244.25	Matte Black	6
		T4412ORB	256.15	Oil Rubbed Bronze	6
CIA™ EXACTTEMP® VALVE ONLY TRIM					
	• description: temperature control valve trim • requires: separate volume control valve • valve: sold separately  	T4621	297.05	Chrome	3
		T4621BN	448.75	Brushed Nickel	3
		T4621BG	448.75	Brushed Gold	3
		T4621BL	482.85	Matte Black	3
CIA™ EXACTTEMP® VOLUME CONTROL VALVE TRIM					
	• valve: sold separately  	T4622	151.25	Chrome	6
		T4622BN	227.95	Brushed Nickel	6
		T4622BG	227.95	Brushed Gold	6
		T4622BL	245.80	Matte Black	6
VOSS™ EXACTTEMP® VALVE ONLY TRIM					
	• description: temperature control valve trim • requires: separate volume control valve • valve: sold separately  	T4691	297.95	Chrome	3
		T4691BN	448.75	Brushed Nickel	3
		T4691NL	448.75	Polished Nickel	3
		T4691BG	448.75	Brushed Gold	3
		T4691BL	461.75	Matte Black	3
		T4691ORB	484.05	Oil Rubbed Bronze	3
VOSS™ EXACTTEMP® VOLUME CONTROL VALVE TRIM					
	• valve: sold separately  	T4692	151.25	Chrome	6
		T4692BN	227.95	Brushed Nickel	6
		T4692NL	227.95	Polished Nickel	6
		T4692BG	227.95	Brushed Gold	6
		T4692BL	234.45	Matte Black	6
		T4692ORB	245.80	Oil Rubbed Bronze	6
MOEN® EXACTTEMP® VALVE ONLY TRIM - PREMIUM					
	• description: temperature control valve trim • requires: separate volume control valve • valve: sold separately  	TS3411	319.10	Chrome	3
		TS3411BN	501.30	Brushed Nickel	3
		TS3411ORB	526.50	Oil Rubbed Bronze	3
MOEN® EXACTTEMP® VOLUME CONTROL VALVE TRIM - PREMIUM					
	• valve: sold separately  	TS3600	164.80	Chrome	6
		TS3600BN	293.15	Brushed Nickel	6
		TS3600ORB	308.00	Oil Rubbed Bronze	6

CUSTOM SHOWERING

M-CORE® 3-Series With Integrated Transfer Valve Shower Spa Options

Moen has all the components necessary for you to build a custom shower spa. And, we're making it easy for you to pull together the sku numbers you need. Charts of common shower spa configurations are included so that all the components can be ordered. The charts below illustrate one layout and option of showering components. Refer to pages 437 - 466 in the Custom Showering section to choose from our wide array of showering products, styles and finishes to meet your preference. For additional assistance, call your Moen Sales Representative.



M-CORE® 3-SERIES SHOWERHEAD, BODY SPRAYS & HANDSHOWER



3 Showering Devices:
(3 Independent Functions or
3 Independent and 3 Shared Functions)
as determined by valve selection
Doux™ suite shown.

Suite	M-CORE 3-Series with Integrated Transfer Valve Trim	Showerhead	Shower Arm and Flange	Multi-Function Body Spray and Quantity	Multi-Function Body Spray Rough-In and Quantity	Handheld Shower with Slide Bar	Drop Ell
Weymouth®	UTS4311	S1311	S113	TS1422 x 2	S1300 x 2	S12107EP	A725
Arris®	UTS3311	S112	S110	TS1422 x 2	S1300 x 2	3887EP	A725
Flara™	UTS2411	S6365	123815 + 137488	TS1422 x 2	S1300 x 2	S3880EP	A725
Colinet™	UTS9211	S112	151380 + AT2199	TS1422 x 2	S1300 x 2	3887EP	A725
90°®	UTS9011	S6340	123815 + 147572	TS1422 x 2	S1300 x 2	S3880EP	A721
Doux™	UTS2611	S176	123815 + 137488	TS1422 x 2	S1300 x 2	3887EP	A725
Greenfield™	UT33341	S178	123815 + 137488	TS1422 x 2	S1300 x 2	3887EP	A725
Wynford®	UT5500	S6310	123815 + AT2199	TS1422 x 2	S1300 x 2	3667EP	A725
Align®	UT3290	S176	123815 + 137488	TS1422 x 2	S1300 x 2	3887EP	A725
Belfield™	UT3322	S6310	123815 + AT2199	TS1422 x 2	S1300 x 2	3667EP	A725
Cia™	UT3331	S112	123815 + 137488	TS1422 x 2	S1300 x 2	3887EP	A725
Voss™	UT3611	S6365	123815 + AT2199	TS1422 x 2	S1300 x 2	3988EP	A721

Use M-CORE U362 or U232 valves
Reference valve section for details

Diverter tub spout options on pages 459-461.

Matching tub and shower drains available. See page 466.

Valve	Flow Rate through shower port (GPM) @ 20 PSI	Flow Rate through shower port (GPM) @ 40 PSI	Flow Rate through shower port (GPM) @ 60 PSI
M-CORE 3 Function 6 Function (U362) or M-CORE 2 Function 3 Function (U232)	3.0	4.5	5.6

M-CORE transfer valve flow is the total flow when used in the shared mode.

When plumbing the U362 valve to flow three shared showering devices, 50 psi or higher is recommended for optimum performance.

M-CORE® 3-Series Multi-Function Showering Configurations

CUSTOM SHOWERING

M-CORE® 3-SERIES CEILING SHOWERHEAD, SHOWERHEAD & HANDSHOWER



3 Showering Devices:
 (3 Independent Functions or
 3 Independent and 3 Shared Functions)
 as determined by valve selection
 Doux™ suite shown.

Suite	M-CORE 3-Series with Integrated Transfer Valve Trim	Ceiling Mount Showerhead	Ceiling Mount Shower Arm	Ceiling Mount Shower Arm Flange	Showerhead	Shower Arm	Shower Arm Flange	Handheld Shower with Slide Bar	Drop Ell
Weymouth®	UTS4311	S1311	226651	AT2199	S1311	S113		S12107EP	A725
Arris®	UTS3311	S112	226651	137488	S112	S110		3887EP	A725
Flara™	UTS2411	S6365	226651	137488	S6365	123815	137488	S3880EP	A725
Colinet™	UTS9211	S112	226651	AT2199	S112	151380	AT2199	3887EP	A725
90°®	UTS9011	S6340	226651	147572	S6340	123815	147572	S3880EP	A721
Doux™	UTS2611	S176	226651	137488	S176	123815	137488	3887EP	A725
Greenfield™	UT33341	S6360	226651	137488	S178	S134		3887EP	A725
Wynford®	UT5500	S6310	226651	AT2199	S6310	123815	AT2199	3667EP	A725
Align®	UT3290	S176	226651	137488	S176	123815	137488	3887EP	A725
Belfield™	UT3322	S6310	226651	AT2199	S6310	123815	AT2199	3667EP	A725
Cia™	UT3331	S112	226651	137488	S112	123815	137488	3887EP	A725
Voss™	UT3611	S6365	226651	AT2199	S6365	123815	AT2199	3988EP	A721

Use M-CORE U362 or U232 valves
 Reference valve section for details

Diverter tub spout options on pages 459-461.
 Matching tub and shower drains available. See page 466.

Valve	Flow Rate through shower port (GPM) @ 20 PSI	Flow Rate through shower port (GPM) @ 40 PSI	Flow Rate through shower port (GPM) @ 60 PSI
M-CORE 3 Function 6 Function (U362) or M-CORE 2 Function 3 Function (U232)	3.0	4.5	5.6

M-CORE transfer valve flow is the total flow when used in the shared mode

M-CORE® 3-Series Multi-Function Showering Configurations

M-CORE® 3-SERIES SHOWERHEAD & HANDSHOWER



2 Showering Devices:
 (2 Independent Functions or
 2 Independent and 1 Shared Function)
 as determined by valve selection
 Colinet™ suite shown.

Suite	M-CORE 3-Series with Integrated Transfer Valve Trim	Showerhead	Shower Arm	Shower Arm Flange	Handheld Shower with Slide Bar	Drop Ell
Weymouth®	UTS4311	S1311	226651		S12107EP	A725
Arris®	UTS3311	S112	226651		3887EP	A725
Flara™	UTS2411	S6365	226651	137488	S3880EP	A725
Colinet™	UTS9211	S112	226651	AT2199	3887EP	A725
90°®	UTS9011	S6340	226651	147572	S3880EP	A721
Doux™	UTS2611	S176	226651	137488	3887EP	A725
Greenfield™	UT33341	S6360	226651		3887EP	A725
Wynford®	UT5500	S6310	226651	AT2199	3667EP	A725
Align®	UT3290	S176	226651	137488	3887EP	A725
Belfield™	UT3322	S6310	226651	AT2199	3667EP	A725
Cia™	UT3331	S112	226651	137488	3887EP	A725
Voss™	UT3611	S6365	226651	AT2199	3988EP	A721

Use with M-CORE U362 or U232 valves
 Reference valve section for details

Diverter tub spout options on pages 459-461.

Matching tub and shower drains available. See page 466.

Valve	Flow Rate through shower port (GPM) @ 20 PSI	Flow Rate through shower port (GPM) @ 40 PSI	Flow Rate through shower port (GPM) @ 60 PSI
M-CORE 3 Function 6 Function (U362) or M-CORE 2 Function 3 Function (U232)	3.0	4.5	5.6

M-CORE transfer valve flow is the total flow when used in the shared mode

M-CORE® 3-Series Multi-Function Showering Configurations

CUSTOM SHOWERING

M-CORE® 3-SERIES SHOWERHEAD & BODY SPRAYS



2 Showering Devices:
 (2 Independent Functions or
 2 Independent and 1 Shared Function)
 as determined by valve selection
 Colinet™ suite shown.

Suite	M-CORE 3-Series with Integrated Transfer Valve Trim	Showerhead	Shower Arm	Shower Arm Flange	Single Function Body Spray and Quantity	Body Spray Rough-in and Quantity
Weymouth®	UTS4311	S1311	S113		TS1322 x 2	S1300 x 2
Arris®	UTS3311	S112	S110		TS1322 x 2	S1300 x 2
Flara™	UTS2411	S6365	123815	137488	TS1322 x 2	S1300 x 2
Colinet™	UTS9211	S112	151380	AT2199	TS1322 x 2	S1300 x 2
90°®	UTS9011	S6340	123815	147572	TS1322 x 2	S1300 x 2
Doux™	UTS2611	S176	123815	137488	TS1322 x 2	S1300 x 2
Greenfield™	UT33341	S178	S134		TS1322 x 2	S1300 x 2
Wynford®	UT5500	S6310	123815	AT2199	TS1322 x 2	S1300 x 2
Align®	UT3290	S176	123815	137488	TS1322 x 2	S1300 x 2
Belfield™	UT3322	S6310	123815	AT2199	TS1322 x 2	S1300 x 2
Cia™	UT3331	S112	123815	137488	TS1322 x 2	S1300 x 2
Voss™	UT3611	S6365	123815	AT2199	TS1322 x 2	S1300 x 2

Use with M-CORE U362 or U232 valves
 Reference valve section for details

Diverter tub spout options on pages 459-461.
 Matching tub and shower drains available. See page 466.

Valve	Flow Rate through shower port (GPM) @ 20 PSI	Flow Rate through shower port (GPM) @ 40 PSI	Flow Rate through shower port (GPM) @ 60 PSI
M-CORE 3 Function 6 Function (U362) or M-CORE 2 Function 3 Function (U232)	3.0	4.5	5.6

M-CORE transfer valve flow is the total flow when used in the shared mode.
 When plumbing the U362 valve to flow three shared showering devices, 50 psi or higher is recommended for optimum performance.

M-CORE® 3-Series Multi-Function Showering Configurations

M-CORE® 3-SERIES SHOWERHEAD & NON-DIVERTING TUB SPOUT



2 Showering Devices:
(2 Independent Functions using U232 valve set
for Independent functionality)
Colinet™ suite shown.

Suite	M-CORE 3-Series with Integrated Transfer Valve Trim	Showerhead	Shower Arm	Shower Arm Flange	Non-Diverting Tub Spout
Weymouth®	UTS4311	S1311	S113		S12105
Arris®	UTS3311	S112	S110		S16900
Flara™	UTS2411	S6365	123815	137488	S990
Colinet™	UTS9211	S112	151380	AT2199	S5001
90°®	UTS9011	S6340	123815	147572	S3898
Doux™	UTS2611	S176	123815	137488	S3869
Greenfield™	UT33341	S178	S134		4326
Wynford®	UT5500	S6310	123815	AT2199	19536
Align®	UT3290	S176	123815	137488	3892
Belfield™	UT3322	S6310	123815	AT2199	3858
Cia™	UT3331	S112	123815	137488	3347
Voss™	UT3611	S6365	123815	AT2199	191956

Use with M-CORE U232 valves
Reference valve section for details

















Diverter tub spout options on pages 459-461.

Matching tub and shower drains available. See page 466.

Valve	Flow Rate through shower port (GPM) @ 20 PSI	Flow Rate through shower port (GPM) @ 40 PSI	Flow Rate through shower port (GPM) @ 60 PSI
M-CORE 2 Function 3 Function (U232)	3.0	4.5	5.6













M-CORE transfer valve flow is the total flow when used in the shared mode

M-CORE® 3-Series Multi-Function Showering Options

		MODEL	LIST	FINISH/CONNECT	CASE QTY
WEYMOUTH®	M-CORE® 3-SERIES WITH INTEGRATED TRANSFER VALVE TRIM - PREMIUM				
	<ul style="list-style-type: none"> includes: pressure balanced cartridge with volume and temperature control valve: sold separately 	UTS4311	753.45	Chrome	4
		UTS4311BN	1092.50	Brushed Nickel	4
		UTS4311NL	1092.50	Polished Nickel	4
		UTS4311BG	1092.50	Brushed Gold	4
		UTS4311BL	1201.75	Matte Black	4
		UTS4311ORB	1201.75	Oil Rubbed Bronze	4
ARRIS®	M-CORE® 3-SERIES WITH INTEGRATED TRANSFER VALVE TRIM - PREMIUM				
	<ul style="list-style-type: none"> includes: pressure balanced cartridge with volume and temperature control valve: sold separately 	UTS3311	513.15	Chrome	4
		UTS3311BL	1116.85	Matte Black	4
FLARA™	M-CORE® 3-SERIES WITH INTEGRATED TRANSFER VALVE TRIM - PREMIUM				
	<ul style="list-style-type: none"> includes: pressure balanced cartridge with volume and temperature control valve: sold separately 	UTS2411	518.80	Chrome	4
		UTS2411BN	752.25	Brushed Nickel	4
		UTS2411NL	752.25	Polished Nickel	4
		UTS2411BG	752.25	Brushed Gold	4
COLINET™	M-CORE® 3-SERIES WITH INTEGRATED TRANSFER VALVE TRIM - PREMIUM				
	<ul style="list-style-type: none"> includes: pressure balanced cartridge with volume and temperature control valve: sold separately 	UTS9211	495.40	Chrome	4
		UTS9211BN	718.40	Brushed Nickel	4
		UTS9211BG	718.40	Brushed Gold	4
		UTS9211BL	790.20	Matte Black	4
90™	M-CORE® 3-SERIES WITH INTEGRATED TRANSFER VALVE TRIM - PREMIUM				
	<ul style="list-style-type: none"> includes: pressure balanced cartridge with volume and temperature control valve: sold separately 	UTS9011	428.80	Chrome	4
		UTS9011BN	620.85	Brushed Nickel	4
		UTS9011BL	643.20	Matte Black	4
DOUX™	M-CORE® 3-SERIES WITH INTEGRATED TRANSFER VALVE TRIM - PREMIUM				
	<ul style="list-style-type: none"> includes: pressure balanced cartridge with volume and temperature control valve: sold separately 	UTS2611	453.15	Chrome	4
		UTS2611BN	657.05	Brushed Nickel	4
		UTS2611BL	722.70	Matte Black	4
GREENFIELD™	M-CORE® 3-SERIES WITH INTEGRATED TRANSFER VALVE TRIM				
	<ul style="list-style-type: none"> includes: pressure balanced cartridge with volume and temperature control valve: sold separately 	UT33341	335.50	Chrome	4
		UT33341BN	415.90	Brushed Nickel	4
		UT33341BG	415.90	Brushed Gold	4
		UT33341BL	457.50	Matte Black	4
WYNFORD®	M-CORE® 3-SERIES WITH INTEGRATED TRANSFER VALVE TRIM				
	<ul style="list-style-type: none"> includes: pressure balanced cartridge with volume and temperature control valve: sold separately 	UT5500	327.30	Chrome	4
		UT5500BN	415.90	Brushed Nickel	4
		UT5500ORB	447.40	Oil Rubbed Bronze	4

CUSTOM SHOWERING

M-CORE® 3-Series Multi-Function Showering Options

		MODEL	LIST	FINISH/CONNECT	CASE QTY
	M-CORE® 3-SERIES WITH INTEGRATED TRANSFER VALVE TRIM <ul style="list-style-type: none"> includes: pressure balanced cartridge with volume and temperature control valve: sold separately  	UT3290	335.50	Chrome	4
		UT3290BN	415.90	Brushed Nickel	4
		UT3290BG	415.90	Brushed Gold	4
		UT3290BL	457.50	Matte Black	4
	M-CORE® 3-SERIES WITH INTEGRATED TRANSFER VALVE TRIM <ul style="list-style-type: none"> includes: pressure balanced cartridge with volume and temperature control valve: sold separately  	UT3322	335.50	Chrome	4
		UT3322BN	415.90	Brushed Nickel	4
		UT3322NL	415.90	Polished Nickel	4
		UT3322BL	436.10	Matte Black	4
		UT3322ORB	447.40	Oil Rubbed Bronze	4
	M-CORE® 3-SERIES WITH INTEGRATED TRANSFER VALVE TRIM <ul style="list-style-type: none"> includes: pressure balanced cartridge with volume and temperature control valve: sold separately  	UT3331	321.95	Chrome	4
		UT3331BN	399.15	Brushed Nickel	4
		UT3331BG	399.15	Brushed Gold	4
		UT3331BL	439.05	Matte Black	4
	M-CORE® 3-SERIES WITH INTEGRATED TRANSFER VALVE TRIM <ul style="list-style-type: none"> includes: pressure balanced cartridge with volume and temperature control valve: sold separately  	UT3611	321.90	Chrome	4
		UT3611BN	399.15	Brushed Nickel	4
		UT3611NL	399.15	Polished Nickel	4
		UT3611BG	399.15	Brushed Gold	4
		UT3611BL	359.25	Matte Black	4
		UT3611ORB	429.35	Oil Rubbed Bronze	4



See Custom Showering Product Icon Key, page 374.

◆ BULK PACK
AVAILABLE◆◆ BULK PACK
ONLY

M-CORE® 4-SERIES, 3-SERIES AND 2-SERIES Transfer Valve Showering Configurations

Moen has all the components necessary for you to build a custom shower spa. And, we're making it easy for you to pull together the sku numbers you need. Charts of common shower spa configurations are included so that all the components can be ordered. The charts below illustrate one layout and option of showering components. Refer to pages 437 - 466 in the Custom Showering section to choose from our wide array of showering products, styles and finishes to meet your preference. For additional assistance, call your Moen Sales Representative.



M-CORE® 4-SERIES, 3-SERIES OR 2-SERIES: SHOWERHEAD, BODYSPRAYS & HANDSHOWER



3 Showering Devices:
(3 Independent Functions or 3 Independent and 3 Shared Functions)
 as determined by valve selection
Arris® suite shown.

*mixing valve image shows M-CORE 3-Series trim

Suite	M-CORE Shower Only Trim PICK YOUR MIXING VALVE TRIM			M-CORE Transfer Valve Trim	Body Spray and Quantity	Handheld Shower with Slide Bar	Drop Ell
	4-Series	3-Series	2-Series				
Weymouth®	UTS43102EP	UTS33102	UTS232102EP	UTS32205	A501 x2	S12107EP	A725
Arris®	UTS42002EP	UTS32002	UTS22002EP	UTS23005	A501 x2	3887EP	A725
Flara™	UTS4912EP	UTS3912	UTS2912EP	UTS4911	A501 x2	S3880EP	A725
Colinet™	UTS444302EP	UTS344302	UTS244202EP	UTS9318	A501 x2	3887EP	A725
90°®	UTS4715EP	UTS3715	UTS2712EP	UTS4172	A501 x2	S3880EP	A721
Doux™	UTS4202EP	UTS3202	UTS2202EP	UTS9204	A501 x2	3887EP	A725
Greenfield™	UT4322EP	UT33322	UT2322EP	UT6501	A501 x2	3887EP	A725
Wynford®	UT45502EP	UT35502	UT24502EP	UT4511	A501 x2	3667EP	A725
Align®	UT4292EP	UT3292	UT2192EP	UT4191	A501 x2	3887EP	A725
Rizon®	UT4812EP	UT3812EP	UT2812EP	UT2081	A501 x2	3988EP	A721
Belfield™	UT4312EP	UT3312	UT2312EP	UT4301	A501 x2	3667EP	A725
Cia™	UT4362EP	UT3362	UT2262EP	UT4620	A501 x2	3887EP	A725
Voss™	UT4692EP	UT3692	UT2692EP	UT4611	A501 x2	3988EP	A721
Dartmoor®			UT2282EP	UT2031	A501 x2	3667EP	A725
Glyde™			UT2842EP	UT2721	A501 x2	3887EP	A725
Brantford®			UT2252EP	UT2021	A501 x2	3667EP	A725
Eva®			UT2232EP	UT2011	A501 x2	3669EP	A725
Gibson™			UT3002EP	UT2921	A501 x2	3669EP	A725
Genta™ LX			UT2472EP	UT2401	A501 x2	3988EP	A721

Use M-CORE mixing valve U130
 Use M-CORE transfer valve U361 or U231
 Reference valve section for details

M-CORE Mixing Valve	Flow Rate through shower port (GPM) @ 20 PSI	Flow Rate through shower port (GPM) @ 40 PSI	Flow Rate through shower port (GPM) @ 60 PSI	Used with M-CORE Transfer Valve
M-CORE U130	3.0	4.5	5.6	M-CORE 3 Function 6 Function (U361) or M-CORE 2 Function 3 Function (U231)

When plumbing the U361 valve to flow three shared showering devices, 50 psi or higher is recommended for optimum performance.

M-CORE® 4-Series, 3-Series and 2-Series Transfer Valve Showering Configurations

M-CORE® 4-SERIES, 3-SERIES, 2-SERIES: CEILING RAINSHOWER, SHOWERHEAD & HANDSHOWER



3 Showering Devices:

(3 Independent Functions or
3 Independent and 3 Shared Functions)
as determined by valve selection

Flara™ suite shown.

*mixing valve image shows M-CORE 3-Series trim

Suite	M-CORE Shower Only Trim PICK YOUR MIXING VALVE TRIM			M-CORE Transfer Valve Trim	Ceiling Mount Showerhead	Ceiling Mount Shower Arm	Ceiling Mount Shower Arm Flange	Handheld Shower with Slide Bar	Drop Ell
	4-Series	3-Series	2-Series						
Weymouth®	UTS43102EP	UTS33102	UTS232102EP	UTS32205	S1311	226651	AT2199	S12107EP	A725
Arris®	UTS42002EP	UTS32002	UTS22002EP	UTS23005	S112	226651	137488	3887EP	A725
Flara™	UTS4912EP	UTS3912	UTS2912EP	UTS4911	S6365	226651	137488	S3880EP	A725
Colinet™	UTS444302EP	UTS344302	UTS244202EP	UTS9318	S112	226651	AT2199	3887EP	A725
90°®	UTS4715EP	UTS3715	UTS2712EP	UTS4172	S6340	226651	147572	S3880EP	A721
Doux™	UTS4202EP	UTS3202	UTS2202EP	UTS9204	S176	226651	137488	3887EP	A725
Greenfield™	UT4322EP	UT33322	UT2322EP	UT6501	S6360	226651	137488	3887EP	A725
Wynford®	UT45502EP	UT35502	UT24502EP	UT4511	S6310	226651	AT2199	3667EP	A725
Align®	UT4292EP	UT3292	UT2192EP	UT4191	S176	226651	137488	3887EP	A725
Rizon®	UT4812EP	UT3812EP	UT2812EP	UT2081	6345	226651	AT2199	3988EP	A721
Belfield™	UT4312EP	UT3312	UT2312EP	UT4301	S6310	226651	AT2199	3667EP	A725
Cia™	UT4362EP	UT3362	UT2262EP	UT4620	S112	226651	137488	3887EP	A725
Voss™	UT4692EP	UT3692	UT2692EP	UT4611	S6365	226651	AT2199	3988EP	A721
Dartmoor®			UT2282EP	UT2031	6345	226651	AT2199	3667EP	A725
Glyde™			UT2842EP	UT2721	6345	226651	137488	3887EP	A725
Brantford®			UT2252EP	UT2021	6345	226651	AT2199	3667EP	A725
Eva®			UT2232EP	UT2011	6345	226651	AT2199	3669EP	A725
Gibson™			UT3002EP	UT2921	6345	226651	137488	3669EP	A725
Genta™ LX			UT2472EP	UT2401	6345	226651	137488	3988EP	A721

Use M-CORE mixing valve U130

Use M-CORE transfer valve U361 or U231

Reference valve section for details

M-CORE Mixing Valve	Flow Rate through shower port (GPM) @ 20 PSI	Flow Rate through shower port (GPM) @ 40 PSI	Flow Rate through shower port (GPM) @ 60 PSI	Used with M-CORE Transfer Valve
M-CORE U130	3.0	4.5	5.6	M-CORE 3 Function 6 Function (U361) or M-CORE 2 Function 3 Function (U231)

M-CORE® 4-Series, 3-Series and 2-Series Transfer Valve Showering Configurations

CUSTOM SHOWERING

M-CORE® 4-SERIES, 3-SERIES OR 2-SERIES: SHOWERHEAD, HANDSHOWER & NON-DIVERTING TUB SPOUT



3 Showering Devices:
 (3 Independent Functions using U231 set for independent functionality)
 Flara™ suite shown.

*mixing valve image shows M-CORE 3-Series trim

Suite	M-CORE Shower Only Trim PICK YOUR MIXING VALVE TRIM			M-CORE Transfer Valve Trim	Handheld Shower with Slide Bar	Drop Ell	Non-Diverting Tub Spout
	4-Series	3-Series	2-Series				
Weymouth®	UTS43102EP	UTS33102	UTS232102EP	UTS32205	S12107EP	A725	S12105
Arris®	UTS42002EP	UTS32002	UTS22002EP	UTS23005	3887EP	A725	S16900
Flara™	UTS4912EP	UTS3912	UTS2912EP	UTS4911	S3880EP	A725	S990
Colinet™	UTS444302EP	UTS344302	UTS244202EP	UTS9318	3887EP	A725	S5001
90°®	UTS4715EP	UTS3715	UTS2712EP	UTS4172	S3880EP	A721	S3898
Doux™	UTS4202EP	UTS3202	UTS2202EP	UTS9204	3887EP	A725	S3869
Greenfield™	UT4322EP	UT33322	UT2322EP	UT6501	3887EP	A725	4326
Wynford®	UT45502EP	UT35502	UT24502EP	UT4511	3667EP	A725	195386
Align®	UT4292EP	UT3292	UT2192EP	UT4191	3887EP	A725	3892
Rizon®	UT4812EP	UT3812EP	UT2812EP	UT2081	3988EP	A721	3829
Belfield™	UT4312EP	UT3312	UT2312EP	UT4301	3667EP	A725	3858
Cia™	UT4362EP	UT3362	UT2262EP	UT4620	3887EP	A725	3347
Voss™	UT4692EP	UT3692	UT2692EP	UT4611	3988EP	A721	191956
Dartmoor®			UT2282EP	UT2031	3667EP	A725	3858
Glyde™			UT2842EP	UT2721	3887EP	A725	3829
Brantford®			UT2252EP	UT2021	3667EP	A725	3858
Eva®			UT2232EP	UT2011	3669EP	A725	3829
Gibson™			UT3002EP	UT2921	3669EP	A725	3892
Genta™ LX			UT2472EP	UT2401	3988EP	A721	3829

Use M-CORE mixing valve U130
 Use M-CORE transfer valve U361 or U231
 Reference valve section for details

M-CORE Mixing Valve	Flow Rate through shower port (GPM) @ 20 PSI	Flow Rate through shower port (GPM) @ 40 PSI	Flow Rate through shower port (GPM) @ 60 PSI	Used with M-CORE Transfer Valve
M-CORE U130	3.0	4.5	5.6	M-CORE 3 Function 6 Function (U361) or M-CORE 2 Function 3 Function (U231)

M-CORE transfer valve flow is the total flow when used in the shared mode.
 When plumbing the U362 valve to flow three shared showering devices, 50 psi or higher is recommended for optimum performance.

M-CORE® 4-Series, 3-Series and 2-Series Transfer Valve Showering Configurations

M-CORE® 4-SERIES, 3-SERIES OR 2-SERIES: SHOWERHEAD & HANDSHOWER



2 Showering Devices:

(2 Independent Functions or
2 Independent and 1 Shared Function) as
determined by valve selection

Flara™ suite shown.

*mixing valve image shows M-CORE 3-Series trim

Suite	M-CORE Shower Only Trim PICK YOUR MIXING VALVE TRIM			M-CORE Transfer Valve Trim	Handheld Shower with Slide Bar	Drop Ell
	4-Series	3-Series	2-Series			
Weymouth®	UTS43102EP	UTS33102	UTS232102EP	UTS32205	S12107EP	A725
Arris®	UTS42002EP	UTS32002	UTS22002EP	UTS23005	3887EP	A725
Flara™	UTS4912EP	UTS3912	UTS2912EP	UTS4911	S3880EP	A725
Colinet™	UTS444302EP	UTS344302	UTS244202EP	UTS9318	3887EP	A725
90°®	UTS4715EP	UTS3715	UTS2712EP	UTS4172	S3880EP	A721
Doux™	UTS4202EP	UTS3202	UTS2202EP	UTS9204	3887EP	A725
Greenfield™	UT4322EP	UT33322	UT2322EP	UT6501	3887EP	A725
Wynford®	UT45502EP	UT35502	UT24502EP	UT4511	3667EP	A725
Align®	UT4292EP	UT3292	UT2192EP	UT4191	3887EP	A725
Rizon®	UT4812EP	UT3812EP	UT2812EP	UT2081	3988EP	A721
Belfield™	UT4312EP	UT3312	UT2312EP	UT4301	3667EP	A725
Cia™	UT4362EP	UT3362	UT2262EP	UT4620	3887EP	A725
Voss™	UT4692EP	UT3692	UT2692EP	UT4611	3988EP	A721
Dartmoor®			UT2282EP	UT2031	3667EP	A725
Glyde™			UT2842EP	UT2721	3887EP	A725
Brantford®			UT2252EP	UT2021	3667EP	A725
Eva®			UT2232EP	UT2011	3669EP	A725
Gibson™			UT3002EP	UT2921	3669EP	A725
Genta™ LX			UT2472EP	UT2401	3988EP	A721

Use M-CORE mixing valve U130

Use M-CORE transfer valve U361 or U231

Reference valve section for details

M-CORE Mixing Valve	Flow Rate through shower port (GPM) @ 20 PSI	Flow Rate through shower port (GPM) @ 40 PSI	Flow Rate through shower port (GPM) @ 60 PSI	Used with M-CORE Transfer Valve
M-CORE U130	3.0	4.5	5.6	M-CORE 3 Function 6 Function (U361) or M-CORE 2 Function 3 Function (U231)

M-CORE® 4-Series, 3-Series and 2-Series Transfer Valve Showering Configurations

CUSTOM SHOWERING

M-CORE® 4-SERIES, 3-SERIES OR 2-SERIES: CEILING RAINSHOWER & SHOWERHEAD



2 Showering Devices:
 (2 Independent Functions or
 2 Independent and 1 Shared Function) as
 determined by valve selection
 Flara™ suite shown.

*mixing valve image shows M-CORE 3-Series trim

Suite	M-CORE Shower Only Trim PICK YOUR MIXING VALVE TRIM			M-CORE Transfer Valve Trim	Ceiling Mount Showerhead	Ceiling Mount Shower Arm	Ceiling Mount Shower Arm Flange
	4-Series	3-Series	2-Series				
Weymouth®	UTS43102EP	UTS33102	UTS232102EP	UTS32205	S1311	226651	AT2199
Arris®	UTS42002EP	UTS32002	UTS22002EP	UTS23005	S112	226651	137488
Flara™	UTS4912EP	UTS3912	UTS2912EP	UTS4911	S6365	226651	137488
Colinet™	UTS444302EP	UTS344302	UTS244202EP	UTS9318	S112	226651	AT2199
90°®	UTS4715EP	UTS3715	UTS2712EP	UTS4172	S6340	226651	147572
Doux™	UTS4202EP	UTS3202	UTS2202EP	UTS9204	S176	226651	137488
Greenfield™	UT4322EP	UT33322	UT2322EP	UT6501	S6360	226651	137488
Wynford®	UT45502EP	UT35502	UT24502EP	UT4511	S6310	226651	AT2199
Align®	UT4292EP	UT3292	UT2192EP	UT4191	S176	226651	137488
Rizon®	UT4812EP	UT3812EP	UT2812EP	UT2081	6345	226651	AT2199
Belfield™	UT4312EP	UT3312	UT2312EP	UT4301	S6310	226651	AT2199
Cia™	UT4362EP	UT3362	UT2262EP	UT4620	S112	226651	137488
Voss™	UT4692EP	UT3692	UT2692EP	UT4611	S6365	226651	AT2199
Dartmoor®			UT2282EP	UT2031	6345	226651	AT2199
Glyde™			UT2842EP	UT2721	6345	226651	137488
Brantford®			UT2252EP	UT2021	6345	226651	AT2199
Eva®			UT2232EP	UT2011	6345	226651	AT2199
Gibson™			UT3002EP	UT2921	6345	226651	137488
Genta™ LX			UT2472EP	UT2401	6345	226651	137488

Use M-CORE mixing valve U130
 Use M-CORE transfer valve U361 or U231
 Reference valve section for details

M-CORE Mixing Valve	Flow Rate through shower port (GPM) @ 20 PSI	Flow Rate through shower port (GPM) @ 40 PSI	Flow Rate through shower port (GPM) @ 60 PSI	Used with M-CORE Transfer Valve
M-CORE U130	3.0	4.5	5.6	M-CORE 3 Function 6 Function (U361) or M-CORE 2 Function 3 Function (U231)

M-CORE® 4-Series, 3-Series and 2-Series Transfer Valve Showering Configurations

M-CORE® 4-SERIES, 3-SERIES OR 2-SERIES: SHOWERHEAD & BODY SPRAYS



2 Showering Devices:
 (2 Independent Functions or
 2 Independent and 1 Shared Function) as
 determined by valve selection
 Flara™ suite shown.

*mixing valve image shows M-CORE 3-Series trim

Suite	M-CORE Shower Only Trim PICK YOUR MIXING VALVE TRIM			M-CORE Transfer Valve Trim	Bodyspray and Quantity
	4-Series	3-Series	2-Series		
Weymouth®	UTS43102EP	UTS33102	UTS232102EP	UTS32205	A501 x2
Arris®	UTS42002EP	UTS32002	UTS22002EP	UTS23005	A501 x2
Flara™	UTS4912EP	UTS3912	UTS2912EP	UTS4911	A501 x2
Colinet™	UTS444302EP	UTS344302	UTS244202EP	UTS9318	A501 x2
90°®	UTS4715EP	UTS3715	UTS2712EP	UTS4172	A501 x2
Doux™	UTS4202EP	UTS3202	UTS2202EP	UTS9204	A501 x2
Greenfield™	UT4322EP	UT33322	UT2322EP	UT6501	A501 x2
Wynford®	UT45502EP	UT35502	UT24502EP	UT4511	A501 x2
Align®	UT4292EP	UT3292	UT2192EP	UT4191	A501 x2
Rizon®	UT4812EP	UT3812EP	UT2812EP	UT2081	A501 x2
Belfield™	UT4312EP	UT3312	UT2312EP	UT4301	A501 x2
Cia™	UT4362EP	UT3362	UT2262EP	UT4620	A501 x2
Voss™	UT4692EP	UT3692	UT2692EP	UT4611	A501 x2
Dartmoor®			UT2282EP	UT2031	A501 x2
Glyde™			UT2842EP	UT2721	A501 x2
Brantford®			UT2252EP	UT2021	A501 x2
Eva®			UT2232EP	UT2011	A501 x2
Gibson™			UT3002EP	UT2921	A501 x2
Genta™ LX			UT2472EP	UT2401	A501 x2

Use M-CORE mixing valve U130
 Use M-CORE transfer valve U361 or U231
 Reference valve section for details

M-CORE Mixing Valve	Flow Rate through shower port (GPM) @ 20 PSI	Flow Rate through shower port (GPM) @ 40 PSI	Flow Rate through shower port (GPM) @ 60 PSI	Used with M-CORE Transfer Valve
M-CORE U130	3.0	4.5	5.6	M-CORE 3 Function 6 Function (U361) or M-CORE 2 Function 3 Function (U231)

When plumbing the U231 or U361 valve to flow three shared showering devices, 50 psi or higher is recommended for optimum performance.

POSI-TEMP® WITH M-CORE® TRANSFER VALVE Showering Configurations

Moen has all the components necessary for you to build a custom shower spa. And, we're making it easy for you to pull together the sku numbers you need. Charts of common shower spa configurations are included so that all the components can be ordered. The charts below illustrate one layout and option of showering components. Refer to pages 437 - 466 in the Custom Showering section to choose from our wide array of showering products, styles and finishes to meet your preference. For additional assistance, call your Moen Sales Representative.



POSI-TEMP® WITH M-CORE®: SHOWERHEAD, BODY SPRAY & HANDSHOWER



3 Showering Devices:
(3 Independent Functions or
3 Independent and 3 Shared Functions)
as determined by valve selection
Arris® suite shown.

Suite	Posi-Temp® Shower Only Trim	M-CORE Transfer Valve Trim	Bodyspray and Quantity	Handheld Shower with Slide Bar	Drop Ell
Weymouth®	TS32102	UTS32205	A501 x 2	S12107EP	A725
Arris®	TS22002	UTS23005	A501 x 2	3887EP	A725
Flara™	TS2912	UTS4911	A501 x 2	S3880EP	A725
90°®	TS2712	UTS4172	A501 x 2	S3880EP	A721
Doux™	TS2202	UTS9204	A501 x 2	3887EP	A725
Greenfield™	T2222EP	UT6501	A501 x 2	3887EP	A725
Wynford®	T4502	UT4511	A501 x 2	3667EP	A725
Align®	T2192	UT4191	A501 x 2	3887EP	A725
Rizon®	T2812	UT2081	A501 x 2	3988EP	A721
Belfield™	T2312	UT4301	A501 x 2	3667EP	A725
Cia™	T2262EP	UT4620	A501 x 2	3887EP	A725
Voss™	T2692	UT4611	A501 x 2	3988EP	A721
Dartmoor®	T2182	UT2031	A501 x 2	3667EP	A725
Glyde™	T2742EP	UT2721	A501 x 2	3887EP	A725
Brantford®	T2152	UT2021	A501 x 2	3667EP	A725
Eva®	T2132	UT2011	A501 x 2	3669EP	A725
Gibson™	T2902EP	UT2921	A501 x 2	3669EP	A725
Genta™ LX	T2472EP	UT2401	A501 x 2	3988EP	A721

Use Posi-Temp® three port valve
Use M-CORE transfer valve U361 or U231

Posi-Temp® Valve	Flow Rate through shower port (GPM) @ 20 PSI	Flow Rate through shower port (GPM) @ 40 PSI	Flow Rate through shower port (GPM) @ 60 PSI	Used with M-CORE Transfer Valve
Posi-Temp® Three Port Valve	3.6	5.1	6.3	M-CORE 3 Function 6 Function (U361) or M-CORE 2 Function 3 Function (U231)

When plumbing the U361 valve to flow three shared showering devices, 50 psi or higher is recommended for optimum performance.

Posi-Temp® with M-CORE® Transfer Valve Showering Configuration

POSI-TEMP® WITH M-CORE®: CEILING RAINSHOWER, SHOWERHEAD & HANDSHOWER



3 Showering Devices:
(3 Independent Functions or
3 Independent and 3 Shared Functions) as
determined by valve selection
Doux™ suite shown.

Suite	Posi-Temp® Shower Only Trim	M-CORE Transfer Valve Trim	Ceiling Mount Showerhead	Ceiling Mount Shower Arm	Ceiling Mount Shower Arm Flange	Handheld Shower with Slide Bar	Drop Ell
Weymouth®	TS32102	UTS32205	S1311	226651	AT2199	S12107EP	A725
Arris®	TS22002	UTS23005	S112	226651	137488	3887EP	A725
Flara™	TS2912	UTS4911	S6365	226651	137488	3988EP	A725
90°®	TS2712	UTS4172	S6340	226651	147572	S3880EP	A721
Doux™	TS2202	UTS9204	S176	226651	137488	3887EP	A725
Greenfield™	T2222EP	UT6501	S178	226651	137488	3887EP	A725
Wynford®	T4502	UT4511	S6310	226651	AT2199	3667EP	A725
Align®	T2192	UT4191	S176	226651	137488	3887EP	A725
Rizon®	T2812	UT2081	6345	226651	AT2199	3988EP	A721
Belfield™	T2312	UT4301	S6310	226651	AT2199	3667EP	A725
Cia™	T2262EP	UT4620	S112	226651	137488	3887EP	A725
Voss™	T2692	UT4611	S6365	226651	AT2199	3988EP	A721
Dartmoor®	T2182	UT2031	6345	226651	AT2199	3667EP	A725
Glyde™	T2742EP	UT2721	6345	226651	137488	3887EP	A725
Brantford®	T2152	UT2021	6345	226651	AT2199	3667EP	A725
Eva®	T2132	UT2011	6345	226651	AT2199	3669EP	A725
Gibson™	T2902EP	UT2921	6345	226651	137488	3669EP	A725
Genta™ LX	T2472EP	UT2401	6345	226651	137488	3988EP	A721

Use Posi-Temp® three port valve
Use M-CORE transfer valve U361 or U231
Reference valve section for details

Posi-Temp® Valve	Flow Rate through shower port (GPM) @ 20 PSI	Flow Rate through shower port (GPM) @ 40 PSI	Flow Rate through shower port (GPM) @ 60 PSI	Used with M-CORE Transfer Valve
Posi-Temp® Three Port Valve	3.6	5.1	6.3	M-CORE 3 Function 6 Function (U361) or M-CORE 2 Function 3 Function (U231)

Posi-Temp® with M-CORE® Transfer Valve Showering Configuration

CUSTOM SHOWERING

POSI-TEMP® WITH M-CORE®: SHOWERHEAD, HANDSHOWER & NON-DIVERTING TUB SPOUT



3 Showering Devices:
 (3 Independent Functions Only, using U231 set for independent functionality)
 Doux™ suite shown.

Suite	Posi-Temp® Shower Only Trim	M-CORE Transfer Valve Trim	Handheld Shower with Slide Bar	Drop Ell	Non-Diverting Tub Spout
Weymouth®	TS32102	UTS32205	S12107EP	A725	S12105
Arris®	TS22002	UTS23005	3887EP	A725	S16900
Flara™	TS2912	UTS4911	3988EP	A725	S990
90°®	TS2712	UTS4172	S3880EP	A721	S3898
Doux™	TS2202	UTS9204	3887EP	A725	S3836
Greenfield™	T2222EP	UT6501	3887EP	A725	4326
Wynford®	T4502	UT4511	3667EP	A725	195386
Align®	T2192	UT4191	3887EP	A725	3892
Rizon®	T2812	UT2081	3988EP	A721	3829
Belfield™	T2312	UT4301	3667EP	A725	3858
Cia™	T2262EP	UT4620	3887EP	A725	3347
Voss™	T2692	UT4611	3988EP	A721	191956
Dartmoor®	T2182	UT2031	3667EP	A725	3858
Glyde™	T2742EP	UT2721	3887EP	A725	3829
Brantford®	T2152	UT2021	3667EP	A725	3858
Eva®	T2132	UT2011	3669EP	A725	3829
Gibson™	T2902EP	UT2921	3669EP	A725	3892
Genta™ LX	T2472EP	UT2401	3988EP	A721	3829

Use Posi-Temp® three port valve
 Use M-CORE transfer valve U231
 Reference valve section for details

Posi-Temp® Valve	Flow Rate through shower port (GPM) @ 20 PSI	Flow Rate through shower port (GPM) @ 40 PSI	Flow Rate through shower port (GPM) @ 60 PSI	Used with M-CORE Transfer Valve
Posi-Temp® Three Port Valve	3.6	5.1	6.3	M-CORE U231 set in three function independent functionality

Posi-Temp® with M-CORE® Transfer Valve Showering Configuration

POSI-TEMP® WITH M-CORE®: SHOWERHEAD & HANDSHOWER



2 Showering Devices:
(2 Independent Functions or
2 Independent and 1 Shared Function)
as determined by valve selection
Flara™ suite shown.

Suite	Posi-Temp® Shower Only Trim	M-CORE Transfer Valve Trim	Handheld Shower with Slide Bar	Drop Ell
Weymouth®	TS32102	UTS32205	S12107EP	A725
Arris®	TS22002	UTS23005	3887EP	A725
Flara™	TS2912	UTS4911	3988EP	A725
90°®	TS2712	UTS4172	S3880EP	A721
Doux™	TS2202	UTS9204	3887EP	A725
Greenfield™	T2222EP	UT6501	3887EP	A725
Wynford®	T4502	UT4511	3667EP	A725
Align®	T2192	UT4191	3887EP	A725
Rizon®	T2812	UT2081	3988EP	A721
Belfield™	T2312	UT4301	3667EP	A725
Cia™	T2262EP	UT4620	3887EP	A725
Voss™	T2692	UT4611	3988EP	A721
Dartmoor®	T2182	UT2031	3667EP	A725
Glyde™	T2742EP	UT2721	3887EP	A725
Brantford®	T2152	UT2021	3667EP	A725
Eva®	T2132	UT2011	3669EP	A725
Gibson™	T2902EP	UT2921	3669EP	A725
Genta™ LX	T2472EP	UT2401	3988EP	A721

Use Posi-Temp® three port valve

Use M-CORE transfer valve U361 or U231

Reference valve section for more options and details

Posi-Temp® Valve	Flow Rate through shower port (GPM) @ 20 PSI	Flow Rate through shower port (GPM) @ 40 PSI	Flow Rate through shower port (GPM) @ 60 PSI	Used with M-CORE Transfer Valve
Posi-Temp® Three Port Valve	3.6	5.1	6.3	M-CORE 3 Function 6 Function (U361) or M-CORE 2 Function 3 Function (U231)

When plumbing the U361 valve to flow three shared showering devices, 50 psi or higher is recommended for optimum performance.

Posi-Temp® with M-CORE® Transfer Valve Showering Configuration

CUSTOM SHOWERING

POSI-TEMP® WITH M-CORE®: SHOWERHEAD & BODY SPRAYS



2 Showering Devices:
 (2 Independent Functions or
 2 Independent and 1 Shared Function)
 as determined by valve selection
 Flara™ suite shown.

Suite	Posi-Temp® Shower Only Trim	M-CORE Transfer Valve Trim	Bodyspray and Quantity
Weymouth®	TS32102	UTS32205	A501 x 2
Arris®	TS22002	UTS23005	A501 x 2
Flara™	TS2912	UTS4911	A501 x 2
90°®	TS2712	UTS4172	A501 x 2
Doux™	TS2202	UTS9204	A501 x 2
Greenfield™	T2222EP	UT6501	A501 x 2
Wynford®	T4502	UT4511	A501 x 2
Align®	T2192	UT4191	A501 x 2
Rizon®	T2812	UT2081	A501 x 2
Belfield™	T2312	UT4301	A501 x 2
Cia™	T2262EP	UT4620	A501 x 2
Voss™	T2692	UT4611	A501 x 2
Dartmoor®	T2182	UT2031	A501 x 2
Glyde™	T2742EP	UT2721	A501 x 2
Brantford®	T2152	UT2021	A501 x 2
Eva®	T2132	UT2011	A501 x 2
Gibson™	T2902EP	UT2921	A501 x 2
Genta™ LX	T2472EP	UT2401	A501 x 2

Use Posi-Temp® three port valve
 Use M-CORE transfer valve U361 or U231
 Reference valve section for more options and details

Posi-Temp® Valve	Flow Rate through shower port (GPM) @ 20 PSI	Flow Rate through shower port (GPM) @ 40 PSI	Flow Rate through shower port (GPM) @ 60 PSI	Used with M-CORE Transfer Valve
Posi-Temp® Three Port Valve	3.6	5.1	6.3	M-CORE 3 Function 6 Function (U361) or M-CORE 2 Function 3 Function (U231)

When plumbing the U361 valve to flow three shared showering devices, 50 psi or higher is recommended for optimum performance.

Posi-Temp® with **M-CORE®** Transfer Valve Showering Configuration

POSI-TEMP® WITH M-CORE®: SHOWERHEAD & NON-DIVERTING TUB SPOUT

**2 Showering Devices:**

(2 Independent Functions; use U231 transfer valve set for 2 Function independent functionality)

Wynford® suite shown.

Suite	Posi-Temp® Shower Only Trim	M-CORE Transfer Valve Trim	Non-Diverting Tub Spout
Weymouth®	TS32102	UTS32205	S12105
Arris®	TS22002	UTS23005	S16900
Flara™	TS2912	UTS4911	S990
90°®	TS2712	UTS4172	S3898
Doux™	TS2202	UTS9204	S3869
Greenfield™	T2222EP	UT6501	4326
Wynford®	T4502	UT4511	195386
Align®	T2192	UT4191	3892
Rizon®	T2812	UT2081	3829
Belfield™	T2312	UT4301	3858
Cia™	T2262EP	UT4620	3347
Voss™	T2692	UT4611	191956
Dartmoor®	T2182	UT2031	3858
Glyde™	T2742EP	UT2721	3829
Brantford®	T2152	UT2021	3858
Eva®	T2132	UT2011	3829
Gibson™	T2902EP	UT2921	3892
Genta™ LX	T2472EP	UT2401	3829

Use Posi-Temp® three port valve

Use M-CORE transfer valve U361 or U231

Reference valve section for more options and details

Posi-Temp® Valve	Flow Rate through shower port (GPM) @ 20 PSI	Flow Rate through shower port (GPM) @ 40 PSI	Flow Rate through shower port (GPM) @ 60 PSI	Used with M-CORE Transfer Valve
Posi-Temp® Three Port Valve	3.6	5.1	6.3	M-CORE U231 set in three function independent functionality

M-CORE® Transfer Valve Showering Options







		MODEL	LIST	FINISH/CONNECT	CASE QTY
	M-CORE® TRANSFER VALVE TRIM - PREMIUM • use with the M-CORE® transfer valve • valve: sold separately  	UTS32205	469.15	Chrome	12
		UTS32205BN	536.10	Brushed Nickel	12
		UTS32205NL	536.10	Polished Nickel	12
		UTS32205BG	536.10	Brushed Gold	12
		UTS32205BL	570.70	Matte Black	12
		UTS32205ORB	570.70	Oil Rubbed Bronze	12
	M-CORE® TRANSFER VALVE TRIM - PREMIUM • use with the M-CORE® transfer valve • valve: sold separately  	UTS23005	442.90	Chrome	12
		UTS23005BL	568.85	Matte Black	12
	M-CORE® TRANSFER VALVE TRIM - PREMIUM • use with the M-CORE® transfer valve • valve: sold separately  	UTS4911	337.30	Chrome	12
		UTS4911BN	458.10	Brushed Nickel	12
		UTS4911NL	458.10	Polished Nickel	12
		UTS4911BG	458.10	Brushed Gold	12
	M-CORE® TRANSFER VALVE TRIM - PREMIUM • use with the M-CORE® transfer valve • valve: sold separately  	UTS9381	322.20	Chrome	12
		UTS9381BN	437.45	Brushed Nickel	12
		UTS9381BG	437.45	Brushed Gold	12
		UTS9381BL	481.20	Matte Black	12
	M-CORE® TRANSFER VALVE TRIM - PREMIUM • use with the M-CORE® transfer valve • valve: sold separately  	UTS4172	303.45	Chrome	12
		UTS4172BN	377.80	Brushed Nickel	12
		UTS4172BL	394.50	Matte Black	12
	M-CORE® TRANSFER VALVE TRIM - PREMIUM • use with the M-CORE® transfer valve • valve: sold separately  	UTS9204	320.40	Chrome	12
		UTS9204BN	421.40	Brushed Nickel	12
		UTS9204BL	454.00	Matte Black	12
	M-CORE® TRANSFER VALVE TRIM • use with the M-CORE® transfer valve • valve: sold separately  	UT6501	232.25	Chrome	12
		UT6501BN	285.90	Brushed Nickel	12
		UT6501BG	285.90	Brushed Gold	12
		UT6501BL	306.80	Matte Black	12
	M-CORE® TRANSFER VALVE TRIM • use with the M-CORE® transfer valve • valve: sold separately  	UT4511	232.25	Chrome	12
		UT4511BN	285.90	Brushed Nickel	12
		UT4511ORB	306.80	Oil Rubbed Bronze	12

CUSTOM SHOWERING

M-CORE® Transfer Valve Showering Options















		MODEL	LIST	FINISH/CONNECT	CASE QTY
ALIGN®	M-CORE® TRANSFER VALVE TRIM				
	<ul style="list-style-type: none"> • use with the M-CORE® transfer valve • valve: sold separately  	UT4191 UT4191BN UT4191BG UT4191BL	232.25 285.90 285.90 306.80	Chrome Brushed Nickel Brushed Gold Matte Black	12 12 12 12
RIZON®	M-CORE® TRANSFER VALVE TRIM				
	<ul style="list-style-type: none"> • use with the M-CORE® transfer valve • valve: sold separately  	UT2081 UT2081BL	232.25 306.85	Chrome Matte Black	12 12
BELFIELD™	M-CORE® TRANSFER VALVE TRIM				
	<ul style="list-style-type: none"> • use with the M-CORE® transfer valve • valve: sold separately  	UT4301 UT4301BN UT4301NL UT4301BL UT4301ORB	226.45 278.20 278.20 283.05 298.30	Chrome Brushed Nickel Polished Nickel Matte Black Oil Rubbed Bronze	12 12 12 12 12
CIA™	M-CORE® TRANSFER VALVE TRIM				
	<ul style="list-style-type: none"> • use with the M-CORE® transfer valve • valve: sold separately  	UT4620 UT4620BN UT4620BG UT4620BL	222.85 274.35 274.35 294.40	Chrome Brushed Nickel Brushed Gold Matte Black	12 12 12 12
VOSS™	M-CORE® TRANSFER VALVE TRIM				
	<ul style="list-style-type: none"> • use with the M-CORE® transfer valve • valve: sold separately  	UT4611 UT4611BN UT4611NL UT4611BG UT4611ORB	222.85 274.35 274.35 274.35 294.40	Chrome Brushed Nickel Polished Nickel Brushed Gold Oil Rubbed Bronze	12 12 12 12 12
DARTMOOR™	M-CORE® TRANSFER VALVE TRIM				
	<ul style="list-style-type: none"> • use with the M-CORE® transfer valve • valve: sold separately  	UT2031 UT2031BN UT2031BL UT2031ORB	192.35 233.65 249.70 249.70	Chrome Brushed Nickel Matte Black Oil Rubbed Bronze	12 12 12 12
GLYDE™	M-CORE® TRANSFER VALVE TRIM				
	<ul style="list-style-type: none"> • use with the M-CORE® transfer valve • valve: sold separately  	UT2721 UT2721BN UT2721BL	192.35 233.65 249.70	Chrome Brushed Nickel Matte Black	12 12 12
BRANTFORD®	M-CORE® TRANSFER VALVE TRIM				
	<ul style="list-style-type: none"> • use with the M-CORE® transfer valve • valve: sold separately  	UT2021 UT2021BN UT2021ORB	192.35 233.65 249.70	Chrome Brushed Nickel Oil Rubbed Bronze	12 12 12

M-CORE® Transfer Valve Showering Options



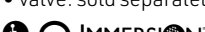

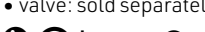

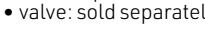



		MODEL	LIST	FINISH/CONNECT	CASE QTY
EVA® 	M-CORE® TRANSFER VALVE TRIM <ul style="list-style-type: none"> • use with the M-CORE® transfer valve • valve: sold separately 	UT2011	192.35	Chrome	12
		UT2011BN	233.65	Brushed Nickel	12
		UT2011ORB	249.70	Oil Rubbed Bronze	12
		GIBSON™			
	M-CORE® TRANSFER VALVE TRIM <ul style="list-style-type: none"> • use with the M-CORE® transfer valve • valve: sold separately 	UT2921	192.35	Chrome	12
		UT2921BN	234.00	Brushed Nickel	12
		UT2921BL	250.20	Matte Black	12
		GENTA™ LX			
	M-CORE® TRANSFER VALVE TRIM <ul style="list-style-type: none"> • use with the M-CORE® transfer valve • valve: sold separately 	UT2401	187.35	Chrome	12
		UT2401BN	233.65	Brushed Nickel	12
		UT2401BL	249.70	Matte Black	12

CUSTOM SHOWERING

M-CORE® 4-Series Shower Only Shower Options











		MODEL	LIST	FINISH/CONNECT	CASE QTY
WEYMOUTH®	M-CORE® 4-SERIES SHOWER ONLY TRIM - PREMIUM				
	<ul style="list-style-type: none"> • showerhead: two-function eco-performance rainshower • showerhead size: 9" diameter • includes: thermostatic cartridge with volume and temperature control • valve: sold separately 	1.75 GPM (6.65 L/min) max. UTS43102EP	1078.35	Chrome	3
		UTS43102EPBN	1444.15	Brushed Nickel	3
		UTS43102EPNL	1444.15	Polished Nickel	3
		UTS43102EPBG	1444.15	Brushed Gold	3
		UTS43102EPBL	1574.65	Matte Black	3
		UTS43102EPORB	1574.65	Oil Rubbed Bronze	3
					
ARRIS®	M-CORE® 4-SERIES SHOWER ONLY TRIM - PREMIUM				
	<ul style="list-style-type: none"> • showerhead: single-function eco-performance rainshower • showerhead size: 10" diameter • includes: thermostatic cartridge with volume and temperature control • valve: sold separately 	1.75 GPM (6.65 L/min) max. UTS42002EP	1044.15	Chrome	3
		UTS42002EPBL	1541.25	Matte Black	3
					
FLARA™	M-CORE® 4-SERIES SHOWER ONLY TRIM - PREMIUM				
	<ul style="list-style-type: none"> • showerhead: single-function eco-performance rainshower • showerhead size: 6" diameter • includes: thermostatic cartridge with volume and temperature control • valve: sold separately 	1.75 GPM (6.65 L/min) max. UTS4912EP	799.15	Chrome	4
		UTS4912EPBN	1052.85	Brushed Nickel	4
		UTS4912EPNL	1052.85	Polished Nickel	4
		UTS4912EPBG	1052.85	Brushed Gold	4
					
COLINET™	M-CORE® 4-SERIES SHOWER ONLY TRIM - PREMIUM				
	<ul style="list-style-type: none"> • showerhead: single-function eco-performance rainshower • showerhead size: 10" diameter • includes: thermostatic cartridge with volume and temperature control • valve: sold separately 	1.75 GPM (6.65 L/min) max. UTS444302EP	717.25	Chrome	3
		UTS444302EPBN	939.40	Brushed Nickel	3
		UTS444302EPBG	939.40	Brushed Gold	3
		UTS444302EPBL	1019.70	Matte Black	3
					
90°™	M-CORE® 4-SERIES SHOWER ONLY TRIM - PREMIUM				
	<ul style="list-style-type: none"> • showerhead: single-function eco-performance rainshower • showerhead size: 6" diameter • includes: thermostatic cartridge with volume and temperature control • valve: sold separately 	1.75 GPM (6.65 L/min) max. UTS4715EP	668.20	Chrome	4
		UTS4715EPBN	1159.75	Brushed Nickel	4
		UTS4715EPBL	1172.20	Matte Black	4
					
DOUX™	M-CORE® 4-SERIES SHOWER ONLY TRIM - PREMIUM				
	<ul style="list-style-type: none"> • showerhead: single-function eco-performance rainshower • showerhead size: 6-3/4" diameter • includes: thermostatic cartridge with volume and temperature control • valve: sold separately 	1.75 GPM (6.65 L/min) max. UTS4202EP	692.95	Chrome	4
		UTS4202EPBN	878.50	Brushed Nickel	4
		UTS4202EPBL	973.60	Matte Black	4
					
GREENFIELD™	M-CORE® 4-SERIES SHOWER ONLY TRIM				
	<ul style="list-style-type: none"> • showerhead: single-function eco-performance rainshower • showerhead size: 6-3/4" diameter • includes: thermostatic cartridge with volume and temperature control • valve: sold separately 	1.75 GPM (6.65 L/min) max. UT4322EP	560.15	Chrome	4
		UT4322EPBN	847.60	Brushed Nickel	4
		UT4322EPBG	847.60	Brushed Gold	4
		UT4322EPBL	918.60	Matte Black	4
					
WYNFORD®	M-CORE® 4-SERIES SHOWER ONLY TRIM				
	<ul style="list-style-type: none"> • showerhead: single-function eco-performance rainshower • showerhead size: 7" diameter • includes: thermostatic cartridge with volume and temperature control • valve: sold separately 	1.75 GPM (6.65 L/min) max. UT45502EP	530.65	Chrome	4
		UT45502EPBN	798.10	Brushed Nickel	4
		UT45502EPORB	903.25	Oil Rubbed Bronze	4
					

M-CORE® 4-Series Shower Only Shower Options













		MODEL	LIST	FINISH/CONNECT	CASE QTY
ALIGN®	M-CORE® 4-SERIES SHOWER ONLY TRIM				
 <ul style="list-style-type: none"> • showerhead: single-function eco-performance rainshower • showerhead size: 7" diameter • includes: thermostatic cartridge with volume and temperature control • valve: sold separately 		1.75 GPM (6.65 L/min) max.			
		UT4292EP	560.15	Chrome	4
		UT4292EPBN	847.60	Brushed Nickel	4
		UT4292EPBG	847.60	Brushed Gold	4
		UT4292EPBL	918.60	Matte Black	4
RIZON®	M-CORE® 4-SERIES SHOWER ONLY TRIM				
 <ul style="list-style-type: none"> • showerhead: single-function eco-performance rainshower • showerhead size: 6-3/4" diameter • includes: thermostatic cartridge with volume and temperature control • valve: sold separately 		1.75 GPM (6.65 L/min) max.			
		UT4812EP	560.15	Chrome	4
		UT4812EPBL	903.25	Matte Black	4
BELFIELD™	M-CORE® 4-SERIES SHOWER ONLY TRIM				
 <ul style="list-style-type: none"> • showerhead: single-function eco-performance rainshower • showerhead size: 7" diameter • includes: thermostatic cartridge with volume and temperature control • valve: sold separately 		1.75 GPM (6.65 L/min) max.			
		UT4312EP	535.35	Chrome	4
		UT4312EPBN	794.70	Brushed Nickel	4
		UT4312EPNL	794.70	Polished Nickel	4
		UT4312EPBL	813.70	Matte Black	4
UT4312EPORB	883.25	Oil Rubbed Bronze	4		
CIA™	M-CORE® 4-SERIES SHOWER ONLY TRIM				
 <ul style="list-style-type: none"> • showerhead: single-function eco-performance rainshower • showerhead size: 10" diameter • includes: thermostatic cartridge with volume and temperature control • valve: sold separately 		1.75 GPM (6.65 L/min) max.			
		UT4362EP	543.15	Chrome	3
		UT4362EPBN	819.00	Brushed Nickel	3
		UT4362EPBG	819.00	Brushed Gold	3
		UT4362EPBL	887.15	Matte Black	3
VOSS™	M-CORE® 4-SERIES SHOWER ONLY TRIM				
 <ul style="list-style-type: none"> • showerhead: single-function eco-performance rainshower • showerhead size: 6" diameter • includes: thermostatic cartridge with volume and temperature control • valve: sold separately 		1.75 GPM (6.65 L/min) max.			
		UT4692EP	543.15	Chrome	4
		UT4692EPBN	819.00	Brushed Nickel	4
		UT4692EPNL	819.00	Polished Nickel	4
		UT4692EPBG	819.00	Brushed Gold	4
		UT4692EPBL	826.90	Matte Black	4
UT4692EPORB	872.45	Oil Rubbed Bronze	4		

CUSTOM SHOWERING

M-CORE® 3-Series Shower Only Shower Options







		MODEL	LIST	FINISH/CONNECT	CASE QTY
WEYMOUTH®	M-CORE® 3-SERIES SHOWER ONLY TRIM - PREMIUM				
 <ul style="list-style-type: none"> • showerhead: two-function rainshower • showerhead size: 9" diameter • includes: pressure balanced cartridge with volume and temperature control • valve: sold separately 		2.5 GPM (9.5 L/min) max.			
		UTS33102	940.65	Chrome	3
		UTS33102BN	1306.45	Brushed Nickel	3
		UTS33102NL	1306.45	Polished Nickel	3
		UTS33102BG	1306.45	Brushed Gold	3
		UTS33102BL	1436.90	Matte Black	3
		UTS33102ORB	1436.90	Oil Rubbed Bronze	3
		1.75 GPM (6.65 L/min) max.			
		UTS33102EP	940.65	Chrome	3
		UTS33102EPBN	1306.45	Brushed Nickel	3
		UTS33102EPNL	1306.45	Polished Nickel	3
		UTS33102EPBG	1306.45	Brushed Gold	3
		UTS33102EPBL	1436.90	Matte Black	3
		UTS33102EPORB	1436.90	Oil Rubbed Bronze	3
ARRIS®	M-CORE® 3-SERIES SHOWER ONLY TRIM - PREMIUM				
 <ul style="list-style-type: none"> • showerhead: single-function rainshower • showerhead size: 10" diameter • includes: pressure balanced cartridge with volume and temperature control • valve: sold separately 		2.5 GPM (9.5 L/min) max.			
		UTS32002	906.45	Chrome	3
		UTS32002BL	1403.55	Matte Black	3
		1.75 GPM (6.65 L/min) max.			
		UTS32002EP	906.45	Chrome	3
		UTS32002EPBL	1403.55	Matte Black	3
FLARATM™	M-CORE® 3-SERIES SHOWER ONLY TRIM - PREMIUM				
 <ul style="list-style-type: none"> • showerhead: single-function rainshower • showerhead size: 6" diameter • includes: pressure balanced cartridge with volume and temperature control • valve: sold separately 		2.5 GPM (9.5 L/min) max.			
		UTS3912	661.45	Chrome	4
		UTS3912BN	915.15	Brushed Nickel	4
		UTS3912NL	915.15	Polished Nickel	4
		UTS3912BG	915.15	Brushed Gold	4
		1.75 GPM (6.65 L/min) max.			
		UTS3912EP	661.45	Chrome	4
		UTS3912EPBN	915.15	Brushed Nickel	4
		UTS3912EPNL	915.15	Polished Nickel	4
		UTS3912EPBG	915.15	Brushed Gold	4
COLINET™	M-CORE® 3-SERIES SHOWER ONLY TRIM - PREMIUM				
 <ul style="list-style-type: none"> • showerhead: single-function rainshower • showerhead size: 10" diameter • includes: pressure balanced cartridge with volume and temperature control • valve: sold separately 		2.5 GPM (9.5 L/min) max.			
		UTS344302	631.75	Chrome	3
		UTS344302BN	873.90	Brushed Nickel	3
		UTS344302BG	873.90	Brushed Gold	3
		UTS344302BL	961.35	Matte Black	3
		1.75 GPM (6.65 L/min) max.			
		UTS344302EP	631.75	Chrome	3
		UTS344302EPBN	873.90	Brushed Nickel	3
		UTS344302EPBG	873.90	Brushed Gold	3
		UTS344302EPBL	961.35	Matte Black	3
90°™	M-CORE® 3-SERIES SHOWER ONLY TRIM - PREMIUM				
 <ul style="list-style-type: none"> • showerhead: single-function rainshower • showerhead size: 6" diameter • includes: pressure balanced cartridge with volume and temperature control • valve: sold separately 		2.5 GPM (9.5 L/min) max.			
		UTS3715	530.50	Chrome	4
		UTS3715BN	1022.05	Brushed Nickel	4
		UTS3715BL	1034.50	Matte Black	4
		1.75 GPM (6.65 L/min) max.			
		UTS3715EP	530.50	Chrome	4
		UTS3715EPBN	1022.05	Brushed Nickel	4
	UTS3715EPBL	1034.50	Matte Black	4	

M-CORE® 3-Series Shower Only Shower Options

		MODEL	LIST	FINISH/CONNECT	CASE QTY		
	M-CORE® 3-SERIES SHOWER ONLY TRIM - PREMIUM <ul style="list-style-type: none"> • showerhead: single-function rainshower • showerhead size: 6-3/4" diameter • includes: pressure balanced cartridge with volume and temperature control • valve: sold separately 	2.5 GPM (9.5 L/min) max.					
		UTS3202	555.25	Chrome	4		
		UTS3202BN	740.75	Brushed Nickel	4		
		UTS3202BL	835.90	Matte Black	4		
		1.75 GPM (6.65 L/min) max.					
		UTS3202EP	555.25	Chrome	4		
		UTS3202EPBN	740.75	Brushed Nickel	4		
		UTS3202EPBL	835.90	Matte Black	4		
			M-CORE® 3-SERIES SHOWER ONLY TRIM <ul style="list-style-type: none"> • showerhead: single-function rainshower • showerhead size: 6-3/4" diameter • includes: pressure balanced cartridge with volume and temperature control • valve: sold separately 	2.5 GPM (9.5 L/min) max.			
				UT33322	422.45	Chrome	3
UT33322BN	709.90			Brushed Nickel	3		
UT33322BG	709.90			Brushed Gold	3		
UT33322BL	780.90			Matte Black	3		
1.75 GPM (6.65 L/min) max.							
UT33322EP	422.45			Chrome	3		
UT33322EPBN	709.90			Brushed Nickel	3		
UT33322EPBG	709.90			Brushed Gold	3		
UT33322EPBL	780.90			Matte Black	3		
	M-CORE® 3-SERIES SHOWER ONLY TRIM <ul style="list-style-type: none"> • showerhead: single-function rainshower • showerhead size: 7" diameter • includes: pressure balanced cartridge with volume and temperature control • valve: sold separately 	2.5 GPM (9.5 L/min) max.					
		UT35502	422.45	Chrome	4		
		UT35502BN	709.90	Brushed Nickel	4		
		UT35502ORB	765.55	Oil Rubbed Bronze	4		
		1.75 GPM (6.65 L/min) max.					
		UT35502EP	422.45	Chrome	4		
		UT35502EPBN	709.90	Brushed Nickel	4		
		UT35502EPORB	765.55	Oil Rubbed Bronze	4		
			M-CORE® 3-SERIES SHOWER ONLY TRIM <ul style="list-style-type: none"> • showerhead: single-function rainshower • showerhead size: 6-3/4" diameter • includes: pressure balanced cartridge with volume and temperature control • valve: sold separately 	2.5 GPM (9.5 L/min) max.			
				UT3292	422.45	Chrome	4
UT3292BN	709.90			Brushed Nickel	4		
UT3292BG	709.90			Brushed Gold	4		
UT3292BL	780.90			Matte Black	4		
1.75 GPM (6.65 L/min) max.							
UT3292EP	422.45			Chrome	4		
UT3292EPBN	709.90			Brushed Nickel	4		
UT3292EPBG	709.90			Brushed Gold	4		
UT3292EPBL	780.90			Matte Black	4		
	M-CORE® 3-SERIES SHOWER ONLY TRIM <ul style="list-style-type: none"> • showerhead: single-function eco-performance rainshower • showerhead size: 6-3/4" diameter • includes: pressure balanced cartridge with volume and temperature control • valve: sold separately 	1.75 GPM (6.65 L/min) max.					
		UT3812EP	422.45	Chrome	4		
		UT3812EPBL	765.55	Matte Black	4		
			M-CORE® 3-SERIES SHOWER ONLY TRIM <ul style="list-style-type: none"> • showerhead: single-function rainshower • showerhead size: 7" diameter • includes: pressure balanced cartridge with volume and temperature control • valve: sold separately 	2.5 GPM (9.5 L/min) max.			
UT3312	397.65			Chrome	4		
UT3312BN	657.00			Brushed Nickel	4		
UT3312NL	657.00			Polished Nickel	4		
UT3312BL	676.00			Matte Black	4		
UT3312ORB	745.55			Oil Rubbed Bronze	4		
1.75 GPM (6.65 L/min) max.							
UT3312EP	397.65			Chrome	4		
UT3312EPBN	657.00			Brushed Nickel	4		
UT3312EPNL	657.00			Polished Nickel	4		
UT3312EPBL	676.00			Matte Black	4		
UT3312EPORB	745.55			Oil Rubbed Bronze	4		

CUSTOM SHOWERING

M-CORE® 3-Series Shower Only Shower Options











































		MODEL	LIST	FINISH/CONNECT	CASE QTY	
CIA™ 	M-CORE® 3-SERIES SHOWER ONLY TRIM					
	<ul style="list-style-type: none"> • showerhead: single-function rainshower • showerhead size: 10" diameter • includes: pressure balanced cartridge with volume and temperature control • valve: sold separately 					
	  IMMERISON					
			2.5 GPM (9.5 L/min) max.			
			UT3362	405.45	Chrome	3
			UT3362BN	681.30	Brushed Nickel	3
			UT3362BG	681.30	Brushed Gold	3
			UT3362BL	749.45	Matte Black	3
			1.75 GPM (6.65 L/min) max.			
			UT3362EP	405.45	Chrome	3
			UT3362EPBN	681.30	Brushed Nickel	3
			UT3362EPBG	681.30	Brushed Gold	3
			UT3362EPBL	749.45	Matte Black	3
	VOSS™ 	M-CORE® 3-SERIES SHOWER ONLY TRIM				
<ul style="list-style-type: none"> • showerhead: single-function rainshower • showerhead size: 6" diameter • includes: pressure balanced cartridge with volume and temperature control • valve: sold separately 						
  IMMERISON						
		2.5 GPM (9.5 L/min) max.				
		UT3692	405.45	Chrome	4	
		UT3692BN	681.30	Brushed Nickel	4	
		UT3692NL	681.30	Polished Nickel	4	
		UT3692BG	681.30	Brushed Gold	4	
		UT3692BL	689.20	Matte Black	4	
		UT3692ORB	734.75	Oil Rubbed Bronze	4	
		1.75 GPM (6.65 L/min) max.				
		UT3692EP	405.45	Chrome	4	
		UT3692EPBN	681.30	Brushed Nickel	4	
		UT3692EPNL	681.30	Polished Nickel	4	
		UT3692EPBG	681.30	Brushed Gold	4	
		UT3692EPBL	689.20	Matte Black	4	
		UT3692EPORB	734.75	Oil Rubbed Bronze	4	

M-CORE® 2-Series Shower Only Shower Options

		MODEL	LIST	FINISH/CONNECT	CASE QTY
WEYMOUTH® M-CORE® 2-SERIES SHOWER ONLY TRIM - PREMIUM					
	<ul style="list-style-type: none"> • showerhead: two-function eco-performance rainshower • showerhead size: 9" diameter • includes: pressure balanced cartridge with temperature control • valve: sold separately 	1.75 GPM (6.65 L/min) max.			
		UTS232102EP	897.25	Chrome	3
		UTS232102EPBN	1256.80	Brushed Nickel	3
		UTS232102EPNL	1256.80	Polished Nickel	3
		UTS232102EPBG	1256.80	Brushed Gold	3
		UTS232102EPBL	1346.60	Matte Black	3
		UTS232102EPORB	1346.60	Oil Rubbed Bronze	3
ARRIS® M-CORE® 2-SERIES SHOWER ONLY TRIM - PREMIUM					
	<ul style="list-style-type: none"> • showerhead: single-function eco-performance rainshower • showerhead size: 10" diameter • includes: pressure balanced cartridge with temperature control • valve: sold separately 	1.75 GPM (6.65 L/min) max.			
		UTS22002EP	857.85	Chrome	3
		UTS22002EPBL	1308.40	Matte Black	3
FLARA™ M-CORE® 2-SERIES SHOWER ONLY TRIM - PREMIUM					
	<ul style="list-style-type: none"> • showerhead: single-function eco-performance rainshower • showerhead size: 6" diameter • includes: pressure balanced cartridge with temperature control • valve: sold separately 	1.75 GPM (6.65 L/min) max.			
		UTS2912EP	596.85	Chrome	4
		UTS2912EPBN	818.30	Brushed Nickel	4
		UTS2912EPNL	818.30	Polished Nickel	4
		UTS2912EPBG	818.30	Brushed Gold	4
COLINET™ M-CORE® 2-SERIES SHOWER ONLY TRIM - PREMIUM					
	<ul style="list-style-type: none"> • showerhead: single-function eco-performance rainshower • showerhead size: 10" diameter • includes: pressure balanced cartridge with temperature control • valve: sold separately 	1.75 GPM (6.65 L/min) max.			
		UTS244202EP	577.65	Chrome	3
		UTS244202EPBN	789.40	Brushed Nickel	3
		UTS244202EPBG	789.40	Brushed Gold	3
		UTS244202EPBL	852.85	Matte Black	3
90°™ M-CORE® 2-SERIES SHOWER ONLY TRIM - PREMIUM					
	<ul style="list-style-type: none"> • showerhead: single-function eco-performance rainshower • showerhead size: 6" diameter • includes: pressure balanced cartridge with temperature control • valve: sold separately 	1.75 GPM (6.65 L/min) max.			
		UTS2712EP	468.25	Chrome	4
		UTS2712EPBN	742.25	Brushed Nickel	4
		UTS2712EPBL	772.60	Matte Black	4
DOUX™ M-CORE® 2-SERIES SHOWER ONLY TRIM - PREMIUM					
	<ul style="list-style-type: none"> • showerhead: single-function eco-performance rainshower • showerhead size: 6-3/4" diameter • includes: pressure balanced cartridge with temperature control • valve: sold separately 	1.75 GPM (6.65 L/min) max.			
		UTS2202EP	494.30	Chrome	4
		UTS2202EPBN	647.30	Brushed Nickel	4
		UTS2202EPBL	696.70	Matte Black	4
GREENFIELD™ M-CORE® 2-SERIES SHOWER ONLY TRIM					
	<ul style="list-style-type: none"> • showerhead: single-function eco-performance rainshower • showerhead size: 3-5/8" diameter • includes: pressure balanced cartridge with temperature control • valve: sold separately 	1.75 GPM (6.65 L/min) max.			
		UT2322EP	355.45	Chrome	3
		UT2322EPBN	541.25	Brushed Nickel	3
		UT2322EPBG	541.25	Brushed Gold	3
		UT2322EPBL	582.55	Matte Black	3
WYNFORD® M-CORE® 2-SERIES SHOWER ONLY TRIM					
	<ul style="list-style-type: none"> • showerhead: single-function eco-performance rainshower • showerhead size: 5-7/8" diameter • includes: pressure balanced cartridge with temperature control • valve: sold separately 	1.75 GPM (6.65 L/min) max.			
		UT24502EP	355.45	Chrome	3
		UT24502EPBN	541.25	Brushed Nickel	3
		UT24502EPORB	582.45	Oil Rubbed Bronze	3

CUSTOM SHOWERING

M-CORE® 2-Series Shower Only Shower Options

















		MODEL	LIST	FINISH/CONNECT	CASE QTY	
CUSTOM SHOWERING	ALIGN®	M-CORE® 2-SERIES SHOWER ONLY TRIM				
		<ul style="list-style-type: none"> • showerhead: single-function eco-performance • showerhead size: 3-5/8" diameter • red/blue markings: included • includes: pressure balanced cartridge with temperature control • valve: sold separately 	1.75 GPM (6.65 L/min) max.			
			UT2192EP	355.45	Chrome	12
			UT2192EPBN	541.25	Brushed Nickel	12
			UT2192EPBG	541.25	Brushed Gold	12
			UT2192EPBL	582.55	Matte Black	12
			UT2192NH	309.05	Chrome	3
			UT2192NHBN	456.40	Brushed Nickel	3
			UT2192NHBG	456.40	Brushed Gold	3
			UT2192NHBL	489.25	Matte Black	3
RIZON®	M-CORE® 2-SERIES SHOWER ONLY TRIM					
	<ul style="list-style-type: none"> • showerhead: single-function eco-performance • showerhead size: 3.75" diameter • red/blue markings: included • includes: pressure balanced cartridge with temperature control • valve: sold separately 	1.75 GPM (6.65 L/min) max.				
		UT2812EP	355.45	Chrome	12	
		UT2812EPBL	582.50	Matte Black	12	
		UT2812NH	309.05	Chrome	3	
		UT2812NHBL	489.25	Matte Black	3	
BELFIELD™	M-CORE® 2-SERIES SHOWER ONLY TRIM					
	<ul style="list-style-type: none"> • showerhead: single-function eco-performance rainshower • showerhead size: 7" diameter • includes: pressure balanced cartridge with temperature control • valve: sold separately 	1.75 GPM (6.65 L/min) max.				
		UT2312EP	347.25	Chrome	4	
		UT2312EPBN	526.25	Brushed Nickel	4	
		UT2312EPNL	526.25	Polished Nickel	4	
		UT2312EPBL	538.25	Matte Black	4	
		UT2312EPORB	565.85	Oil Rubbed Bronze	4	
CIA™	M-CORE® 2-SERIES SHOWER ONLY TRIM					
	<ul style="list-style-type: none"> • showerhead: single-function eco-performance rainshower • showerhead size: 6-3/4" diameter • red/blue markings: included • includes: pressure balanced cartridge with temperature control • valve: sold separately 	1.75 GPM (6.65 L/min) max.				
		UT2262EP	341.20	Chrome	4	
		UT2262EPBN	519.50	Brushed Nickel	4	
		UT2262EPBG	519.50	Brushed Gold	4	
		UT2262EPBL	559.10	Matte Black	4	
VOSS™	M-CORE® 2-SERIES SHOWER ONLY TRIM					
	<ul style="list-style-type: none"> • showerhead: single-function eco-performance • showerhead size: 4-1/16" diameter • includes: pressure balanced cartridge with temperature control • valve: sold separately 	1.75 GPM (6.65 L/min) max.				
		UT2692EP	341.20	Chrome	12	
		UT2692EPBN	519.50	Brushed Nickel	12	
		UT2692EPNL	519.50	Polished Nickel	12	
		UT2692EPBG	519.50	Brushed Gold	12	
		UT2692EPBL	528.80	Matte Black	12	
		UT2692EPORB	559.00	Oil Rubbed Bronze	12	
DARTMOOR™	M-CORE® 2-SERIES SHOWER ONLY TRIM					
	<ul style="list-style-type: none"> • showerhead: single-function eco-performance rainshower • showerhead size: 8" diameter • includes: pressure balanced cartridge with temperature control • valve: sold separately 	1.75 GPM (6.65 L/min) max.				
		UT2282EP	270.75	Chrome	4	
		UT2282EPBN	378.00	Brushed Nickel	4	
		UT2282EPBL	397.90	Matte Black	4	
		UT2282EPORB	397.90	Oil Rubbed Bronze	4	
	<ul style="list-style-type: none"> • showerhead: single-function eco-performance • showerhead size: 4" diameter • includes: pressure balanced cartridge with temperature control • valve: sold separately 	1.75 GPM (6.65 L/min) max.				
		UT2182EP	190.30	Chrome	12	
		UT2182EPBN	327.40	Brushed Nickel	12	
		UT2182EPBL	347.80	Matte Black	12	
		UT2182EPORB	347.80	Oil Rubbed Bronze	12	

See Custom Showering Product Icon Key, page 374.

◆ BULK PACK AVAILABLE

◆◆ BULK PACK ONLY



















M-CORE® 2-Series Shower Only Shower Options

		MODEL	LIST	FINISH/CONNECT	CASE QTY
GLYDE™ M-CORE® 2-SERIES SHOWER ONLY TRIM					
	<ul style="list-style-type: none"> • showerhead: single-function eco-performance rainshower • showerhead size: 8" diameter • includes: pressure balanced cartridge with temperature control • valve: sold separately 	1.75 GPM (6.65 L/min) max.			
		UT2842EP	270.75	Chrome	4
		UT2842EPBN	378.00	Brushed Nickel	4
		UT2842EPBL	397.90	Matte Black	4
					
	<ul style="list-style-type: none"> • showerhead: single-function eco-performance • showerhead size: 3-3/4" diameter • includes: pressure balanced cartridge with temperature control • valve: sold separately 	1.75 GPM (6.65 L/min) max.			
		UT2742EP	190.30	Chrome	12
		UT2742EPBN	327.40	Brushed Nickel	12
		UT2742EPBL	347.80	Matte Black	12
					
BRANTFORD® M-CORE® 2-SERIES SHOWER ONLY TRIM					
	<ul style="list-style-type: none"> • showerhead: single-function eco-performance rainshower • showerhead size: 8" diameter • includes: pressure balanced cartridge with temperature control • valve: sold separately 	1.75 GPM (6.65 L/min) max.			
		UT2252EP	270.75	Chrome	4
		UT2252EPBN	378.00	Brushed Nickel	4
		UT2252EPORB	397.90	Oil Rubbed Bronze	4
					
	<ul style="list-style-type: none"> • showerhead: single-function eco-performance • showerhead size: 3-1/2" diameter • includes: pressure balanced cartridge with temperature control • valve: sold separately 	1.75 GPM (6.65 L/min) max.			
		UT2152EP	190.30	Chrome	12
		UT2152EPBN	327.40	Brushed Nickel	12
		UT2152EPORB	347.80	Oil Rubbed Bronze	12
					
	<ul style="list-style-type: none"> • showerhead sold separately • includes: pressure balanced cartridge with temperature control • valve: sold separately 	UT2152NH	186.25	Chrome	3
		UT2152NHBN	298.25	Brushed Nickel	3
		UT2152NHORB	315.80	Oil Rubbed Bronze	3
					
EVA® M-CORE® 2-SERIES SHOWER ONLY TRIM					
	<ul style="list-style-type: none"> • showerhead: single-function eco-performance rainshower • showerhead size: 8" diameter • includes: pressure balanced cartridge with temperature control • valve: sold separately 	1.75 GPM (6.65 L/min) max.			
		UT2232EP	270.75	Chrome	4
		UT2232EPBN	378.00	Brushed Nickel	4
		UT2232EPORB	397.90	Oil Rubbed Bronze	4
					
	<ul style="list-style-type: none"> • showerhead: single-function eco-performance • showerhead size: 3-1/2" diameter • includes: pressure balanced cartridge with temperature control • valve: sold separately 	1.75 GPM (6.65 L/min) max.			
		UT2132EP	190.30	Chrome	12
		UT2132EPBN	327.40	Brushed Nickel	12
		UT2132EPORB	347.80	Oil Rubbed Bronze	12
					
	<ul style="list-style-type: none"> • showerhead sold separately • includes: pressure balanced cartridge with temperature control • valve: sold separately 	UT2132NH	186.25	Chrome	3
		UT2132NHBN	298.25	Brushed Nickel	3
		UT2132NHORB	315.80	Oil Rubbed Bronze	3
					













CUSTOM SHOWERING

M-CORE® 2-Series Shower Only Shower Options

CUSTOM SHOWERING







		MODEL	LIST	FINISH/CONNECT	CASE QTY
VICHY™ M-CORE® 2-SERIES SHOWER ONLY TRIM					
	<ul style="list-style-type: none"> • showerhead: single-function eco-performance • showerhead size: 3.75" diameter • red/blue markings: included • includes: pressure balanced cartridge with temperature control • valve: sold separately 	 1.75 GPM (6.65 L/min) max. UT2662EP	199.85	Chrome	1
		UT2662NH	196.05	Chrome	3
GIBSON™ M-CORE® 2-SERIES SHOWER ONLY TRIM					
	<ul style="list-style-type: none"> • showerhead: single-function eco-performance rainshower • showerhead size: 8" diameter • red/blue markings: included • includes: pressure balanced cartridge with temperature control • valve: sold separately 	 1.75 GPM (6.65 L/min) max. UT3002EP	254.80	Chrome	4
		UT3002EPBN	357.60	Brushed Nickel	4
		UT3002EPBL	381.00	Matte Black	4
	<ul style="list-style-type: none"> • showerhead: single-function eco-performance • showerhead size: 3.6" diameter • red/blue markings: included • includes: pressure balanced cartridge with temperature control • valve: sold separately 	 1.75 GPM (6.65 L/min) max. UT2902EP	199.85	Chrome	12
		UT2902EPBN	281.35	Brushed Nickel	12
		UT2902EPBL	297.30	Matte Black	12
	<ul style="list-style-type: none"> • showerhead sold separately • red/blue markings: included • includes: pressure balanced cartridge with temperature control • valve: sold separately 	UT2902NH	196.05	Chrome	3
		UT2902NHBN	273.60	Brushed Nickel	3
		UT2902NHBL	288.75	Matte Black	3
GENTA™ LX M-CORE® 2-SERIES SHOWER ONLY TRIM					
	<ul style="list-style-type: none"> • showerhead: six-function eco-performance • showerhead size: 4.5" diameter • red/blue markings: included • includes: pressure balanced cartridge with temperature control • valve: sold separately 	 1.75 GPM (6.65 L/min) max. UT2472EP	196.65	Chrome	12
		UT2472EPBN	274.40	Brushed Nickel	12
		UT2472EPBL	289.60	Matte Black	12
	<ul style="list-style-type: none"> • showerhead sold separately • red/blue markings: included • includes: pressure balanced cartridge with temperature control • valve: sold separately 	UT2472NH	193.00	Chrome	3
		UT2472NHBN	266.95	Brushed Nickel	3
		UT2472NHBL	281.30	Matte Black	3
CHATEAU® M-CORE® 2-SERIES SHOWER ONLY TRIM					
	<ul style="list-style-type: none"> • showerhead: single-function eco-performance • showerhead size: 2-1/2" diameter • red/blue markings: included • includes: pressure balanced cartridge with temperature control • valve: sold separately 	 1.75 GPM (6.65 L/min) max. UTL182EP	160.90	Chrome	12
		UTL182NH	158.25	Chrome	12

Posi-Temp® Shower Only Shower Options















		MODEL	LIST	FINISH/CONNECT	CASE QTY
	WEYMOUTH® POSI-TEMP® SHOWER ONLY TRIM - PREMIUM <ul style="list-style-type: none"> • showerhead: two-function rainshower • showerhead size: 9" diameter • valve: sold separately 	2.5 GPM (9.5 L/min) max.			
		TS32102	782.20	Chrome	3
		TS32102BN	1141.70	Brushed Nickel	3
		TS32102NL	1141.70	Polished Nickel	3
		TS32102BG	1141.70	Brushed Gold	3
		TS32102BL	1231.60	Matte Black	3
		TS32102ORB	1231.60	Oil Rubbed Bronze	3
		1.75 GPM (6.65 L/min) max.			
		TS32102EP	782.20	Chrome	3
		TS32102EPBN	1141.70	Brushed Nickel	3
		TS32102EPNL	1141.70	Polished Nickel	3
		TS32102EPBG	1141.70	Brushed Gold	3
		TS32102EPBL	1231.60	Matte Black	3
		TS32102EPORB	1231.60	Oil Rubbed Bronze	3
			ARRIS® POSI-TEMP® SHOWER ONLY TRIM - PREMIUM <ul style="list-style-type: none"> • showerhead: single-function rainshower • showerhead size: 10" diameter • valve: sold separately 	2.5 GPM (9.5 L/min) max.	
TS22002	742.85			Chrome	3
TS22002BL	1193.40			Matte Black	3
1.75 GPM (6.65 L/min) max.					
TS22002EP	742.85			Chrome	3
TS22002EPBL	1193.40	Matte Black	3		
	FLARA™ POSI-TEMP® SHOWER ONLY TRIM - PREMIUM <ul style="list-style-type: none"> • showerhead: single-function rainshower • showerhead size: 6" diameter • valve: sold separately 	2.5 GPM (9.5 L/min) max.			
		TS2912	442.85	Chrome	4
		TS2912BN	664.15	Brushed Nickel	4
		TS2912NL	664.15	Polished Nickel	4
		TS2912BG	664.15	Brushed Gold	4
		1.75 GPM (6.65 L/min) max.			
		TS2912EP	442.85	Chrome	4
TS2912EPBN	664.15	Brushed Nickel	4		
TS2912EPNL	664.15	Polished Nickel	4		
TS2912EPBG	664.15	Brushed Gold	4		
	90°™ POSI-TEMP® SHOWER ONLY TRIM - PREMIUM <ul style="list-style-type: none"> • showerhead: single-function rainshower • showerhead size: 6" diameter • valve: sold separately 	2.5 GPM (9.5 L/min) max.			
		TS2712	321.55	Chrome	3
		TS2712BN	595.55	Brushed Nickel	3
		TS2712BL	610.95	Matte Black	3
		1.75 GPM (6.65 L/min) max.			
TS2712EP	321.55	Chrome	3		
TS2712EPBN	595.55	Brushed Nickel	3		
TS2712EPBL	610.95	Matte Black	3		
	DOUX™ POSI-TEMP® SHOWER ONLY TRIM - PREMIUM <ul style="list-style-type: none"> • showerhead: single-function rainshower • showerhead size: 6-3/4" diameter • valve: sold separately 	2.5 GPM (9.5 L/min) max.			
		TS2202	340.20	Chrome	4
		TS2202BN	493.25	Brushed Nickel	4
		TS2202BL	542.70	Matte Black	4
		1.75 GPM (6.65 L/min) max.			
TS2202EP	340.20	Chrome	4		
TS2202EPBN	493.25	Brushed Nickel	4		
TS2202EPBL	542.70	Matte Black	4		
	GREENFIELD™ POSI-TEMP® SHOWER ONLY TRIM <ul style="list-style-type: none"> • showerhead: single-function eco-performance rainshower • showerhead size: 3-5/8" diameter • valve: sold separately 	1.75 GPM (6.65 L/min) max.			
		T2222EP	226.85	Chrome	12
		T2222EPBN	412.60	Brushed Nickel	12
		T2222EPBG	412.60	Brushed Gold	12
		T2222EPBL	453.95	Matte Black	12

CUSTOM SHOWERING

Posi-Temp® Shower Only Shower Options















		MODEL	LIST	FINISH/CONNECT	CASE QTY		
WYNFORD®	POSI-TEMP® SHOWER ONLY TRIM	<ul style="list-style-type: none"> • showerhead: single-function standard • showerhead size: 5-7/8" diameter • valve: sold separately 	2.5 GPM (9.5 L/min) max.				
			T4502	226.85	Chrome	3	
			T4502BN	412.60	Brushed Nickel	3	
			T4502ORB	453.80	Oil Rubbed Bronze	3	
			1.75 GPM (6.65 L/min) max.				
			T4502EP	226.85	Chrome	3	
		T4502EPBN	412.60	Brushed Nickel	3		
		T4502EPORB	453.80	Oil Rubbed Bronze	3		
		ALIGN®	POSI-TEMP® SHOWER ONLY TRIM	<ul style="list-style-type: none"> • showerhead: single-function standard • showerhead size: 3-5/8" diameter • red/blue markings: included • valve: sold separately 	2.5 GPM (9.5 L/min) max.		
					T2192	226.85	Chrome
T2192BN	412.60				Brushed Nickel	3	
T2192BG	412.60				Brushed Gold	3	
T2192BL	453.95				Matte Black	3	
1.75 GPM (6.65 L/min) max.							
T2192EP	226.85			Chrome	3		
T2192EPBN	412.60			Brushed Nickel	3		
T2192EPBG	412.60			Brushed Gold	3		
T2192EPBL	453.95			Matte Black	3		
	<ul style="list-style-type: none"> • showerhead sold separately • red/blue markings: included • valve: sold separately 	T2192NH	180.50	Chrome	3		
		T2192NHBN	327.80	Brushed Nickel	3		
		T2192NHBG	327.80	Brushed Gold	3		
		T2192NHBL	360.55	Matte Black	3		
RIZON®	POSI-TEMP® SHOWER ONLY TRIM	<ul style="list-style-type: none"> • showerhead: single-function standard • showerhead size: 3.75" diameter • red/blue markings: included • valve: sold separately 	2.5 GPM (9.5 L/min) max.				
			T2812	226.85	Chrome	3	
			T2812BL	453.90	Matte Black	3	
			1.75 GPM (6.65 L/min) max.				
			T2812EP	226.85	Chrome	3	
			T2812EPBL	453.90	Matte Black	3	
			<ul style="list-style-type: none"> • showerhead sold separately • red/blue markings: included • valve: sold separately 	T2812NH	180.50	Chrome	3
				T2812NHBL	360.55	Matte Black	3
BELFIELD™	POSI-TEMP® SHOWER ONLY TRIM	<ul style="list-style-type: none"> • showerhead: single-function rainshower • showerhead size: 7" diameter • valve: sold separately 	2.5 GPM (9.5 L/min) max.				
			T2312	218.60	Chrome	4	
			T2312BN	397.60	Brushed Nickel	4	
			T2312NL	397.60	Polished Nickel	4	
			T2312BL	404.40	Matte Black	4	
			T2312ORB	437.15	Oil Rubbed Bronze	4	
		1.75 GPM (6.65 L/min) max.					
		T2312EP	218.60	Chrome	4		
		T2312EPBN	397.60	Brushed Nickel	4		
		T2312EPNL	397.60	Polished Nickel	4		
T2312EPBL	404.40	Matte Black	4				
T2312EPORB	437.15	Oil Rubbed Bronze	4				

Posi-Temp® Shower Only Shower Options















		MODEL	LIST	FINISH/CONNECT	CASE QTY
CIA™	POSI-TEMP® SHOWER ONLY TRIM				
 <ul style="list-style-type: none"> • showerhead: single-function eco-performance rainshower • showerhead size: 6-3/4" diameter • red/blue markings: included • valve: sold separately 		1.75 GPM (6.65 L/min) max.			
		T2262EP	217.70	Chrome	4
		T2262EPBN	396.00	Brushed Nickel	4
		T2262EPBG	396.00	Brushed Gold	4
		T2262EPBL	435.65	Matte Black	4
VOSS™	POSI-TEMP® SHOWER ONLY TRIM				
 <ul style="list-style-type: none"> • showerhead: single-function standard • showerhead size: 4-1/16" diameter • valve: sold separately 		2.5 GPM (9.5 L/min) max.			
		T2692	217.70	Chrome	3
		T2692BN	396.00	Brushed Nickel	3
		T2692NL	396.00	Polished Nickel	3
		T2692BG	396.00	Brushed Gold	3
		T2692BL	402.75	Matte Black	3
		T2692ORB	435.55	Oil Rubbed Bronze	3
		1.75 GPM (6.65 L/min) max.			
		T2692EP	217.70	Chrome	3
		T2692EPBN	396.00	Brushed Nickel	3
		T2692EPNL	396.00	Polished Nickel	3
		T2692EPBG	396.00	Brushed Gold	3
		T2692EPBL	402.75	Matte Black	3
		T2692EPORB	435.55	Oil Rubbed Bronze	3
 <ul style="list-style-type: none"> • showerhead sold separately • valve: sold separately 		T2692NH	173.20	Chrome	3
		T2692NHBN	314.55	Brushed Nickel	3
DARTMOOR™	POSI-TEMP® SHOWER ONLY TRIM				
 <ul style="list-style-type: none"> • showerhead: single-function eco-performance rainshower • showerhead size: 8" diameter • valve: sold separately 		1.75 GPM (6.65 L/min) max.			
		T2282EP	148.15	Chrome	4
		T2282EPBN	255.45	Brushed Nickel	4
		T2282EPBL	275.40	Matte Black	4
		T2282EPORB	275.40	Oil Rubbed Bronze	4
 <ul style="list-style-type: none"> • showerhead: single-function standard • showerhead size: 4" diameter • valve: sold separately 		2.5 GPM (9.5 L/min) max.			
		T2182	95.20	Chrome	3
		T2182BN	204.85	Brushed Nickel	3
		T2182BL	225.25	Matte Black	3
		T2182ORB	225.25	Oil Rubbed Bronze	3
		1.75 GPM (6.65 L/min) max.			
		T2182EP	78.95	Chrome	3
		T2182EPBN	204.85	Brushed Nickel	3
		T2182EPBL	225.25	Matte Black	3
		T2182EPORB	225.25	Oil Rubbed Bronze	3
GLYDE™	POSI-TEMP® SHOWER ONLY TRIM				
 <ul style="list-style-type: none"> • showerhead: single-function eco-performance rainshower • showerhead size: 8" diameter • valve: sold separately 		1.75 GPM (6.65 L/min) max.			
		T2842EP	148.15	Chrome	4
		T2842EPBN	255.45	Brushed Nickel	4
 <ul style="list-style-type: none"> • showerhead: single-function standard • showerhead size: 3-3/4" diameter • valve: sold separately 		2.5 GPM (9.5 L/min) max.			
		T2742	95.20	Chrome	3
		T2742BN	204.85	Brushed Nickel	3
		T2742BL	225.25	Matte Black	3
		1.75 GPM (6.65 L/min) max.			
		T2742EP	78.95	Chrome	3
		T2742EPBN	204.85	Brushed Nickel	3
		T2742EPBL	225.25	Matte Black	3

CUSTOM SHOWERING

Posi-Temp® Shower Only Shower Options

		MODEL	LIST	FINISH/CONNECT	CASE QTY	
CUSTOM SHOWERING	BRANTFORD®	POSI-TEMP® SHOWER ONLY TRIM				
		<ul style="list-style-type: none"> showerhead: single-function eco-performance rainshower showerhead size: 8" diameter valve: sold separately 	1.75 GPM (6.65 L/min) max.			
			T2252EP	148.15	Chrome	4
			T2252EPBN	255.45	Brushed Nickel	4
			T2252EPORB	275.40	Oil Rubbed Bronze	4
		<ul style="list-style-type: none"> showerhead: single-function standard showerhead size: 3-1/2" diameter valve: sold separately 	2.5 GPM (9.5 L/min) max.			
			T2152	95.20	Chrome	3
			T2152BN	204.85	Brushed Nickel	3
			T2152ORB	225.25	Oil Rubbed Bronze	3
		<ul style="list-style-type: none"> showerhead: single-function eco-performance showerhead size: 3-1/2" diameter chrome sold in case qty only: no single pack valve: sold separately 	1.75 GPM (6.65 L/min) max.			
			T62152EP◆◆	78.95	Chrome	12
			T2152EPBN	204.85	Brushed Nickel	3
		T2152EPORB	225.25	Oil Rubbed Bronze	3	
EVA®	POSI-TEMP® SHOWER ONLY TRIM					
	<ul style="list-style-type: none"> showerhead: single-function eco-performance rainshower showerhead size: 8" diameter valve: sold separately 	1.75 GPM (6.65 L/min) max.				
		T2232EP	148.15	Chrome	4	
		T2232EPBN	255.45	Brushed Nickel	4	
		T2232EPORB	275.40	Oil Rubbed Bronze	4	
	<ul style="list-style-type: none"> showerhead: single-function standard showerhead size: 3-1/2" diameter valve: sold separately 	2.5 GPM (9.5 L/min) max.				
		T2132	95.20	Chrome	3	
		T2132BN	204.85	Brushed Nickel	3	
		T2132ORB	225.25	Oil Rubbed Bronze	3	
	<ul style="list-style-type: none"> showerhead: single-function eco-performance showerhead size: 3-1/2" diameter chrome sold in case qty only: no single pack valve: sold separately 	1.75 GPM (6.65 L/min) max.				
		T62132EP◆◆	78.95	Chrome	12	
		T2132EPBN	204.85	Brushed Nickel	3	
		T2132EPORB	225.25	Oil Rubbed Bronze	3	
VICHY™	POSI-TEMP® SHOWER ONLY TRIM					
	<ul style="list-style-type: none"> showerhead: single-function eco-performance showerhead size: 3.75" diameter red/blue markings: included valve: sold separately 	1.75 GPM (6.65 L/min) max.				
		T2662EP	77.25	Chrome	3	

Posi-Temp® Shower Only Shower Options

		MODEL	LIST	FINISH/CONNECT	CASE QTY
GIBSON™ POSI-TEMP® SHOWER ONLY TRIM					
 <ul style="list-style-type: none"> • showerhead: single-function eco-performance rainshower • showerhead size: 8" diameter • red/blue markings: included • valve: sold separately 		1.75 GPM (6.65 L/min) max.			
		T3002EP	132.35	Chrome	4
		T3002EPBN	235.00	Brushed Nickel	4
		T3002EPBL	258.50	Matte Black	4
					
 <ul style="list-style-type: none"> • showerhead: single-function eco-performance • showerhead size: 3.6" diameter • red/blue markings: included • valve: sold separately 		1.75 GPM (6.65 L/min) max.			
		T2902EP	77.25	Chrome	3
		T2902EPBN	158.85	Brushed Nickel	3
		T2902EPBL	174.80	Matte Black	3
					
 <ul style="list-style-type: none"> • showerhead sold separately • red/blue markings: included • valve: sold separately 		T2902NH	73.50	Chrome	3
		T2902NHBN	151.05	Brushed Nickel	3
		T2902NHBL	166.15	Matte Black	3
					
GENTA™ LX POSI-TEMP® SHOWER ONLY TRIM					
 <ul style="list-style-type: none"> • showerhead: six-function eco-performance • showerhead size: 4.5" diameter • red/blue markings: included • valve: sold separately 		1.75 GPM (6.65 L/min) max.			
		T2472EP	74.10	Chrome	3
		T2472EPBN	151.85	Brushed Nickel	3
		T2472EPBL	167.10	Matte Black	3
					
 <ul style="list-style-type: none"> • showerhead sold separately • red/blue markings: included • valve: sold separately 		T2472NH	70.40	Chrome	3
		T2472NHBN	144.35	Brushed Nickel	3
		T2472NHBL	158.75	Matte Black	3
					
CHATEAU® POSI-TEMP® SHOWER ONLY TRIM					
 <ul style="list-style-type: none"> • showerhead: single-function standard • showerhead size: 2-1/2" diameter • red/blue markings: included • valve: sold separately 		2.5 GPM (9.5 L/min) max.			
		TL182◆	50.05	Chrome	12
		1.75 GPM (6.65 L/min) max.			
					
 <ul style="list-style-type: none"> • showerhead: single-function eco-performance • showerhead size: 2-1/2" diameter • used to replace: 2 or 3 hole shower valve • valve: sold separately 		1.75 GPM (6.65 L/min) max.			
		TL2368EP	105.45	Chrome	6
					

CUSTOM SHOWERING

M-CORE® 4-Series, 3-Series and 2-Series Shower Spa with Annex™ Shower Rail Showering Configurations

Moen has all the components necessary for you to build a custom shower spa. And, we're making it easy for you to pull together the sku numbers you need. Charts of common shower spa configurations are included so that all the components can be ordered. The charts below illustrate one layout and option of showering components. Refer to pages 437 - 466 in the Custom Showering section to choose from our wide array of showering products, styles and finishes to meet your preference. For additional assistance, call your Moen Sales Representative.



M-CORE® 4-SERIES, 3-SERIES OR 2-SERIES WITH ANNEX™ SHOWER RAIL & HANDSHOWER



2 discrete functions
Annex™ & Flara™ suite shown.

*mixing valve shows M-CORE 3-Series trim

Suite	M-CORE Valve Only Trim PICK YOUR MIXING VALVE TRIM			Showerhead	Shower Arm Optional	Annex™ Shower Rail	Handshower
	4-Series	3-Series	2-Series				
Weymouth®	UTS43101	UTS33101	UTS232102EP	S1311	S113	TS3661NH	154305
Arris®	UTS42001	UTS32001	UTS22001	S112	S110	TS3661NH	155891
Flara™	UTS4910	UTS3911	UTS2911	S6365		TS3661NH	S3880EP
Colinet™	UTS444301	UTS344301	UTS244201	S112		TS3661NH	3887EP
90°®	UTS4711	UTS3711	UTS2711	S6340		TS3661NH	189575
Doux™	UTS4201	UTS3201	UTS2201	S176		TS3661NH	155891
Greenfield™	UT4321	UT33321	UT2321	S178		TS3661NH	155891
Wynford®	UT45501	UT35501	UT24501	S6310		TS3661NH	164927
Align®	UT4291	UT3291	UT2191	S176	161951	TS3661NH	155891
Rizon®			UT2811	6345		TS3661NH	189318
Belfield™	UT4311	UT3311	UT2311	S6310		TS3661NH	164927
Cia™	UT4361	UT3362	UT2261	S112		TS3661NH	189575
Voss™	UT4691	UT3691	UT2691	S6365	161951	TS3661NH	189318
Dartmoor®			UT2181	6345		TS3661NH	164927
Glyde™			UT2741	6345		TS3661NH	155891
Brantford®			UT2151	6345		TS3661NH	164927
Eva®			UT2131	6345		TS3661NH	164929
Gibson™			UT2901	6345		TS3661NH	164929
Genta™ LX			UT2471	6345		TS3661NH	189318

Use M-CORE valve U130, sold separately
Reference valve section for details

M-CORE Mixing Valve	Flow Rate through shower port (GPM) @ 20 PSI	Flow Rate through shower port (GPM) @ 40 PSI	Flow Rate through shower port (GPM) @ 60 PSI
M-CORE U130	3.1	4.6	5.8

Posi-Temp® Shower Spa with Annex™ Shower Rail Showering Configurations

Moen has all the components necessary for you to build a custom shower spa. And, we're making it easy for you to pull together the sku numbers you need. Charts of common shower spa configurations are included so that all the components can be ordered. The charts below illustrate one layout and option of showering components. Refer to pages 437 - 466 in the Custom Showering section to choose from our wide array of showering products, styles and finishes to meet your preference. For additional assistance, call your Moen Sales Representative.



POSI-TEMP® SHOWER SPA WITH ANNEX™ SHOWER RAIL



2 discrete functions
Annex™ & Flara™ suite shown.

*mixing valve shows Posi-Temp trim















Suite	Posi-Temp® Valve Only Trim	Showerhead	Shower Arm Optional	Annex™ Shower Rail	Handshower
Weymouth®	TS32102	S1311	S113	TS3661NH	154305
Arris®	TS22001	S112	S110	TS3661NH	155891
Flara™	TS2911	S6365		TS3661NH	S3880EP
Colinet™	TS44201	S112	151380	TS3661NH	3887EP
90°®	TS2711	S6340		TS3661NH	189575
Doux™	TS2201	S176		TS3661NH	155891
Greenfield™	T2221	S178		TS3661NH	155891
Wynford®	T4501	S6310		TS3661NH	164927
Align®	T2191	S176	161951	TS3661NH	155891
Rizon®	T2811	6345		TS3661NH	189318
Belfield™	T2311	S6310		TS3661NH	164927
Cia™	T2261	S112		TS3661NH	189575
Voss™	T2691	S6365	161951	TS3661NH	189318
Dartmoor®	T2181	6345		TS3661NH	164927
Glyde™	T2741	6345		TS3661NH	155891
Brantford®	T2151	6345		TS3661NH	164927
Eva®	T2131	6345		TS3661NH	164929
Gibson™	T2901	6345		TS3661NH	164929
Genta™ LX	T2471	6345		TS3661NH	189318
Chateau®	TL181	6345		TS3661NH	164929

Use Posi-Temp® valve 2520, sold separately
Reference valve section for details

M-CORE® 4-Series Valve Only Shower Options

		MODEL	LIST	FINISH/CONNECT	CASE QTY
	WEYMOUTH®	M-CORE® 4-SERIES VALVE ONLY TRIM - PREMIUM			
	<ul style="list-style-type: none"> • includes: thermostatic cartridge with volume and temperature control • valve: sold separately 	UTS43101	765.75	Chrome	3
		UTS43101BN	943.90	Brushed Nickel	3
		UTS43101NL	943.90	Polished Nickel	3
		UTS43101BG	943.90	Brushed Gold	3
		UTS43101BL	992.95	Matte Black	3
UTS43101ORB	992.95	Oil Rubbed Bronze	3		
	ARRIS®	M-CORE® 4-SERIES VALVE ONLY TRIM - PREMIUM			
	<ul style="list-style-type: none"> • includes: thermostatic cartridge with volume and temperature control • valve: sold separately 	UTS42001	716.65	Chrome	3
UTS42001BL		963.05	Matte Black	3	
	FLARA™	M-CORE® 4-SERIES VALVE ONLY TRIM - PREMIUM			
	<ul style="list-style-type: none"> • includes: thermostatic cartridge with volume and temperature control • valve: sold separately 	UTS4910	693.80	Chrome	3
		UTS4910BN	875.20	Brushed Nickel	3
		UTS4910NL	875.20	Polished Nickel	3
UTS4910BG		875.20	Brushed Gold	3	
	COLINET™	M-CORE® 4-SERIES VALVE ONLY TRIM - PREMIUM			
	<ul style="list-style-type: none"> • includes: thermostatic cartridge with volume and temperature control • valve: sold separately 	UTS444301	624.90	Chrome	3
		UTS444301BN	783.85	Brushed Nickel	3
		UTS444301BG	783.85	Brushed Gold	3
UTS444301BL		848.45	Matte Black	3	
	90™	M-CORE® 4-SERIES VALVE ONLY TRIM - PREMIUM			
	<ul style="list-style-type: none"> • includes: thermostatic cartridge with volume and temperature control • valve: sold separately 	UTS4711	581.60	Chrome	3
		UTS4711BN	968.30	Brushed Nickel	3
UTS4711BL		981.10	Matte Black	3	
	DOUX™	M-CORE® 4-SERIES VALVE ONLY TRIM - PREMIUM			
	<ul style="list-style-type: none"> • includes: thermostatic cartridge with volume and temperature control • valve: sold separately 	UTS4201	598.25	Chrome	3
		UTS4201BN	718.40	Brushed Nickel	3
UTS4201BL		757.15	Matte Black	3	
	GREENFIELD™	M-CORE® 4-SERIES VALVE ONLY TRIM			
	<ul style="list-style-type: none"> • includes: thermostatic cartridge with volume and temperature control • valve: sold separately 	UT4321	492.70	Chrome	3
		UT4321BN	720.45	Brushed Nickel	3
		UT4321BG	720.45	Brushed Gold	3
UT4321BL		778.65	Matte Black	3	
	WYNFORD®	M-CORE® 4-SERIES VALVE ONLY TRIM			
	<ul style="list-style-type: none"> • includes: thermostatic cartridge with volume and temperature control • valve: sold separately 	UT45501	467.95	Chrome	3
		UT45501BN	679.80	Brushed Nickel	3
UT45501ORB		763.45	Oil Rubbed Bronze	3	

M-CORE® 4-Series Valve Only Shower Options















		MODEL	LIST	FINISH/CONNECT	CASE QTY
	M-CORE® 4-SERIES VALVE ONLY TRIM • includes: thermostatic cartridge with volume and temperature control • valve: sold separately  	UT4291	492.70	Chrome	3
		UT4291BN	720.45	Brushed Nickel	3
		UT4291BG	720.45	Brushed Gold	3
		UT4291BL	778.65	Matte Black	3
		RIZON® M-CORE® 4-SERIES VALVE ONLY TRIM			
	• includes: thermostatic cartridge with volume and temperature control • valve: sold separately  	UT4811	492.70	Chrome	3
		UT4811BL	763.45	Matte Black	3
BELFIELD™ M-CORE® 4-SERIES VALVE ONLY TRIM					
	• includes: thermostatic cartridge with volume and temperature control • valve: sold separately  	UT4311	464.85	Chrome	3
		UT4311BN	696.45	Brushed Nickel	3
		UT4311NL	696.45	Polished Nickel	3
		UT4311BL	709.15	Matte Black	3
		UT4311ORB	736.90	Oil Rubbed Bronze	3
CIA™ M-CORE® 4-SERIES VALVE ONLY TRIM					
	• includes: thermostatic cartridge with volume and temperature control • valve: sold separately  	UT4361	478.40	Chrome	3
		UT4361BN	696.90	Brushed Nickel	3
		UT4361BG	696.90	Brushed Gold	3
		UT4361BL	752.80	Matte Black	3
VOSS™ M-CORE® 4-SERIES VALVE ONLY TRIM					
	• includes: thermostatic cartridge with volume and temperature control • valve: sold separately  	UT4691	478.40	Chrome	3
		UT4691BN	696.90	Brushed Nickel	3
		UT4691NL	696.90	Polished Nickel	3
		UT4691BG	696.90	Brushed Gold	3
		UT4691BL	696.40	Matte Black	3
		UT4691ORB	738.35	Oil Rubbed Bronze	3

CUSTOM SHOWERING

M-CORE® 3-Series Valve Only Shower Options

		MODEL	LIST	FINISH/CONNECT	CASE QTY
	WEYMOUTH®	M-CORE® 3-SERIES VALVE ONLY TRIM - PREMIUM			
	<ul style="list-style-type: none"> • includes: pressure balanced cartridge with volume and temperature control • valve: sold separately 	UTS33101	628.05	Chrome	3
		UTS33101BN	806.20	Brushed Nickel	3
		UTS33101NL	806.20	Polished Nickel	3
		UTS33101BG	806.20	Brushed Gold	3
		UTS33101BL	855.25	Matte Black	3
UTS33101ORB	855.25	Oil Rubbed Bronze	3		
	ARRIS®	M-CORE® 3-SERIES VALVE ONLY TRIM - PREMIUM			
	<ul style="list-style-type: none"> • includes: pressure balanced cartridge with volume and temperature control • valve: sold separately 	UTS32001	578.95	Chrome	3
UTS32001BL		825.35	Matte Black	3	
	FLARA™	M-CORE® 3-SERIES VALVE ONLY TRIM - PREMIUM			
	<ul style="list-style-type: none"> • includes: pressure balanced cartridge with volume and temperature control • valve: sold separately 	UTS3911	556.10	Chrome	3
		UTS3911BN	737.50	Brushed Nickel	3
		UTS3911NL	737.50	Polished Nickel	3
UTS3911BG		737.50	Brushed Gold	3	
	COLINET™	M-CORE® 3-SERIES VALVE ONLY TRIM - PREMIUM			
	<ul style="list-style-type: none"> • includes: pressure balanced cartridge with volume and temperature control • valve: sold separately 	UTS344301	531.05	Chrome	3
		UTS344301BN	704.30	Brushed Nickel	3
		UTS344301BG	704.30	Brushed Gold	3
UTS344301BL		774.70	Matte Black	3	
	90°™	M-CORE® 3-SERIES VALVE ONLY TRIM - PREMIUM			
	<ul style="list-style-type: none"> • includes: pressure balanced cartridge with volume and temperature control • valve: sold separately 	UTS3711	443.90	Chrome	3
		UTS3711BN	830.60	Brushed Nickel	3
UTS3711BL		843.40	Matte Black	3	
	DOUX™	M-CORE® 3-SERIES VALVE ONLY TRIM - PREMIUM			
	<ul style="list-style-type: none"> • includes: pressure balanced cartridge with volume and temperature control • valve: sold separately 	UTS3201	460.55	Chrome	3
		UTS3201BN	580.70	Brushed Nickel	3
UTS3201BL		619.45	Matte Black	3	
	GREENFIELD™	M-CORE® 3-SERIES VALVE ONLY TRIM			
	<ul style="list-style-type: none"> • includes: pressure balanced cartridge with volume and temperature control • valve: sold separately 	UT33321	355.00	Chrome	3
		UT33321BN	582.75	Brushed Nickel	3
		UT33321BG	582.75	Brushed Gold	3
UT33321BL		640.95	Matte Black	3	
	WYNFORD®	M-CORE® 3-SERIES VALVE ONLY TRIM			
	<ul style="list-style-type: none"> • includes: pressure balanced cartridge with volume and temperature control • valve: sold separately 	UT35501	355.00	Chrome	3
		UT35501BN	582.75	Brushed Nickel	3
UT35501ORB		625.75	Oil Rubbed Bronze	3	

M-CORE® 3-Series Valve Only Shower Options

		MODEL	LIST	FINISH/CONNECT	CASE QTY
ALIGN®	M-CORE® 3-SERIES VALVE ONLY TRIM				
	<ul style="list-style-type: none"> includes: pressure balanced cartridge with volume and temperature control valve: sold separately  	UT3291	355.00	Chrome	3
		UT3291BN	582.75	Brushed Nickel	3
		UT3291BG	582.75	Brushed Gold	3
		UT3291BL	640.95	Matte Black	3
RIZON®	M-CORE® 3-SERIES VALVE ONLY TRIM				
	<ul style="list-style-type: none"> includes: pressure balanced cartridge with volume and temperature control valve: sold separately  	UT3811	355.00	Chrome	3
		UT3811BL	625.75	Matte Black	3
BELFIELD™	M-CORE® 3-SERIES VALVE ONLY TRIM				
	<ul style="list-style-type: none"> includes: pressure balanced cartridge with volume and temperature control valve: sold separately  	UT3311	327.15	Chrome	3
		UT3311BN	558.75	Brushed Nickel	3
		UT3311NL	558.75	Polished Nickel	3
		UT3311BL	572.50	Matte Black	3
		UT3311ORB	599.20	Oil Rubbed Bronze	3
CIA™	M-CORE® 3-SERIES VALVE ONLY TRIM				
	<ul style="list-style-type: none"> includes: pressure balanced cartridge with volume and temperature control valve: sold separately  	UT3361	340.70	Chrome	3
		UT3361BN	559.20	Brushed Nickel	3
		UT3361BG	559.20	Brushed Gold	3
		UT3361BL	615.10	Matte Black	3
VOSS™	M-CORE® 3-SERIES VALVE ONLY TRIM				
	<ul style="list-style-type: none"> includes: pressure balanced cartridge with volume and temperature control valve: sold separately  	UT3691	340.70	Chrome	3
		UT3691BN	559.20	Brushed Nickel	3
		UT3691NL	559.20	Polished Nickel	3
		UT3691BG	559.20	Brushed Gold	3
		UT3691BL	562.10	Matte Black	3
		UT3691ORB	600.65	Oil Rubbed Bronze	3

CUSTOM SHOWERING

M-CORE® 2-Series Valve Only Shower Options















		MODEL	LIST	FINISH/CONNECT	CASE QTY
WEYMOUTH®	M-CORE® 2-SERIES VALVE ONLY TRIM - PREMIUM				
	<ul style="list-style-type: none"> • includes: pressure balanced cartridge with temperature control • valve: sold separately  	UTS23210	525.10	Chrome	3
		UTS23210BN	695.15	Brushed Nickel	3
		UTS23210NL	695.15	Polished Nickel	3
		UTS23210BG	695.15	Brushed Gold	3
		UTS23210BL	741.05	Matte Black	3
		UTS23210ORB	741.05	Oil Rubbed Bronze	3
ARRIS®	M-CORE® 2-SERIES VALVE ONLY TRIM - PREMIUM				
	<ul style="list-style-type: none"> • includes: pressure balanced cartridge with temperature control • valve: sold separately  	UTS22001	496.20	Chrome	3
		UTS22001BL	738.55	Matte Black	3
FLARA™	M-CORE® 2-SERIES VALVE ONLY TRIM - PREMIUM				
	<ul style="list-style-type: none"> • includes: pressure balanced cartridge with temperature control • valve: sold separately  	UTS2911	446.60	Chrome	3
		UTS2911BN	592.95	Brushed Nickel	3
		UTS2911NL	592.95	Polished Nickel	3
		UTS2911BG	592.95	Brushed Gold	3
COLINET™	M-CORE® 2-SERIES VALVE ONLY TRIM - PREMIUM				
	<ul style="list-style-type: none"> • includes: pressure balanced cartridge with temperature control • valve: sold separately  	UTS244201	433.85	Chrome	3
		UTS244201BN	573.85	Brushed Nickel	3
		UTS244201BG	573.85	Brushed Gold	3
		UTS244201BL	615.85	Matte Black	3
90™	M-CORE® 2-SERIES VALVE ONLY TRIM - PREMIUM				
	<ul style="list-style-type: none"> • includes: pressure balanced cartridge with temperature control • valve: sold separately  	UTS2711	387.75	Chrome	3
		UTS2711BN	593.05	Brushed Nickel	3
		UTS2711BL	598.50	Matte Black	3
DOUX™	M-CORE® 2-SERIES VALVE ONLY TRIM - PREMIUM				
	<ul style="list-style-type: none"> • includes: pressure balanced cartridge with temperature control • valve: sold separately  	UTS2201	409.15	Chrome	3
		UTS2201BN	524.15	Brushed Nickel	3
		UTS2201BL	561.05	Matte Black	3
GREENFIELD™	M-CORE® 2-SERIES VALVE ONLY TRIM				
	<ul style="list-style-type: none"> • includes: pressure balanced cartridge with temperature control • valve: sold separately  	UT2321	298.90	Chrome	3
		UT2321BN	437.75	Brushed Nickel	3
		UT2321BG	437.75	Brushed Gold	3
		UT2321BL	468.75	Matte Black	3
WYNFORD®	M-CORE® 2-SERIES VALVE ONLY TRIM				
	<ul style="list-style-type: none"> • includes: pressure balanced cartridge with temperature control • valve: sold separately  	UT24501	298.90	Chrome	3
		UT24501BN	437.75	Brushed Nickel	3
		UT24501ORB	468.75	Oil Rubbed Bronze	3

M-CORE® 2-Series Valve Only Shower Options

		MODEL	LIST	FINISH/CONNECT	CASE QTY
	M-CORE® 2-SERIES VALVE ONLY TRIM <ul style="list-style-type: none"> • red/blue markings: included • includes: pressure balanced cartridge with temperature control • valve: sold separately 	UT2191	298.90	Chrome	3
		UT2191BN	437.75	Brushed Nickel	3
		UT2191BG	437.75	Brushed Gold	3
		UT2191BL	468.75	Matte Black	3
		ALIGN®			
	M-CORE® 2-SERIES VALVE ONLY TRIM <ul style="list-style-type: none"> • red/blue markings: included • includes: pressure balanced cartridge with temperature control • valve: sold separately 	UT2811	298.90	Chrome	3
		UT2811BL	468.70	Matte Black	3
RIZON®					
	M-CORE® 2-SERIES VALVE ONLY TRIM <ul style="list-style-type: none"> • includes: pressure balanced cartridge with temperature control • valve: sold separately 	UT2311	292.70	Chrome	3
		UT2311BN	426.45	Brushed Nickel	1
		UT2311NL	426.45	Polished Nickel	3
		UT2311BL	439.05	Matte Black	3
		UT2311ORB	456.30	Oil Rubbed Bronze	3
BELFIELD™					
	M-CORE® 2-SERIES VALVE ONLY TRIM <ul style="list-style-type: none"> • includes: pressure balanced cartridge with temperature control • valve: sold separately 	UT2261	286.80	Chrome	3
		UT2261BN	420.15	Brushed Nickel	3
		UT2261BG	420.15	Brushed Gold	3
		UT2261BL	449.85	Matte Black	3
CIA™					
	M-CORE® 2-SERIES VALVE ONLY TRIM <ul style="list-style-type: none"> • includes: pressure balanced cartridge with temperature control • valve: sold separately 	UT2691	286.80	Chrome	3
		UT2691BN	420.15	Brushed Nickel	3
		UT2691NL	420.15	Polished Nickel	3
		UT2691BG	420.15	Brushed Gold	3
		UT2691BL	418.50	Matte Black	3
		UT2691ORB	449.85	Oil Rubbed Bronze	3
VOSS™					
	M-CORE® 2-SERIES VALVE ONLY TRIM <ul style="list-style-type: none"> • includes: pressure balanced cartridge with temperature control • valve: sold separately 	UT2181	181.30	Chrome	3
		UT2181BN	288.35	Brushed Nickel	3
		UT2181BL	304.85	Matte Black	3
		UT2181ORB	304.85	Oil Rubbed Bronze	3
DARTMOOR™					
	M-CORE® 2-SERIES VALVE ONLY TRIM <ul style="list-style-type: none"> • includes: pressure balanced cartridge with temperature control • valve: sold separately 	UT2741	181.30	Chrome	3
		UT2741BN	288.35	Brushed Nickel	1
		UT2741BL	304.85	Matte Black	3
GLYDE™					
	M-CORE® 2-SERIES VALVE ONLY TRIM <ul style="list-style-type: none"> • includes: pressure balanced cartridge with temperature control • valve: sold separately 	UT2151	181.30	Chrome	3
		UT2151BN	288.35	Brushed Nickel	3
		UT2151ORB	304.85	Oil Rubbed Bronze	3
BRANTFORD®					

CUSTOM SHOWERING

M-CORE® 2-Series Valve Only Shower Options

		MODEL	LIST	FINISH/CONNECT	CASE QTY	
EVA®		M-CORE® 2-SERIES VALVE ONLY TRIM				
		• includes: pressure balanced cartridge with temperature control	UT2131	181.30	Chrome	3
		• valve: sold separately	UT2131BN	288.35	Brushed Nickel	3
		 	UT2131ORB	304.85	Oil Rubbed Bronze	3
VICHY™		M-CORE® 2-SERIES VALVE ONLY TRIM				
		• red/blue markings: included	UT2661	193.65	Chrome	3
		• includes: pressure balanced cartridge with temperature control				
		• valve: sold separately				
		 				
GIBSON™		M-CORE® 2-SERIES VALVE ONLY TRIM				
		• red/blue markings: included	UT2901	193.65	Chrome	3
		• includes: pressure balanced cartridge with temperature control	UT2901BN	268.60	Brushed Nickel	3
		• valve: sold separately	UT2901BL	283.25	Matte Black	3
		 				
GENTA™ LX		M-CORE® 2-SERIES VALVE ONLY TRIM				
		• red/blue markings: included	UT2471	190.65	Chrome	3
		• includes: pressure balanced cartridge with temperature control	UT2471BN	262.15	Brushed Nickel	3
		• valve: sold separately	UT2471BL	276.15	Matte Black	3
		 				
CHATEAU®		M-CORE® 2-SERIES VALVE ONLY TRIM				
		• red/blue markings: included	UTL181	156.35	Chrome	3
		• includes: pressure balanced cartridge with temperature control				
		• valve: sold separately				
		 				

Posi-Temp® Valve Only Shower Options











		MODEL	LIST	FINISH/CONNECT	CASE QTY
	POSI-TEMP® VALVE ONLY TRIM - PREMIUM • valve: sold separately  	TS3210	410.15	Chrome	3
		TS3210BN	580.15	Brushed Nickel	3
		TS3210NL	580.15	Polished Nickel	3
		TS3210BG	580.15	Brushed Gold	3
		TS3210BL	626.10	Matte Black	3
		TS3210ORB	626.10	Oil Rubbed Bronze	3
	POSI-TEMP® VALVE ONLY TRIM - PREMIUM • valve: sold separately  	TS22001	381.15	Chrome	3
		TS22001BL	623.60	Matte Black	3
	POSI-TEMP® VALVE ONLY TRIM - PREMIUM • valve: sold separately  	TS2911	292.60	Chrome	3
		TS2911BN	438.80	Brushed Nickel	3
		TS2911NL	438.80	Polished Nickel	3
		TS2911BG	438.80	Brushed Gold	3
	POSI-TEMP® VALVE ONLY TRIM - PREMIUM • valve: sold separately  	TS44201	279.85	Chrome	3
		TS44201BN	419.85	Brushed Nickel	3
		TS44201BG	419.85	Brushed Gold	3
		TS44201BL	461.80	Matte Black	3
	POSI-TEMP® VALVE ONLY TRIM - PREMIUM • valve: sold separately  	TS2711	241.05	Chrome	3
		TS2711BN	446.35	Brushed Nickel	3
		TS2711BL	450.45	Matte Black	3
	POSI-TEMP® VALVE ONLY TRIM - PREMIUM • valve: sold separately  	TS2201	255.15	Chrome	3
		TS2201BN	370.05	Brushed Nickel	3
		TS2201BL	407.05	Matte Black	3
	POSI-TEMP® VALVE ONLY TRIM • valve: sold separately  	T2221	170.25	Chrome	3
		T2221BN	309.05	Brushed Nickel	3
		T2221BG	309.05	Brushed Gold	3
		T2221BL	340.05	Matte Black	3
	POSI-TEMP® VALVE ONLY TRIM • valve: sold separately  	T4501	170.25	Chrome	3
		T4501BN	309.05	Brushed Nickel	3
		T4501ORB	340.05	Oil Rubbed Bronze	3
	POSI-TEMP® VALVE ONLY TRIM • red/blue markings: included • valve: sold separately  	T2191	170.25	Chrome	3
		T2191BN	309.05	Brushed Nickel	3
		T2191BG	309.05	Brushed Gold	3
		T2191BL	340.05	Matte Black	3

CUSTOM SHOWERING

Posi-Temp® Valve Only Shower Options

		MODEL	LIST	FINISH/CONNECT	CASE QTY
RIZON®	POSI-TEMP® VALVE ONLY TRIM • red/blue markings: included • valve: sold separately 	T2811	170.25	Chrome	3
		T2811BL	340.00	Matte Black	3
					
BELFIELD™	POSI-TEMP® VALVE ONLY TRIM • valve: sold separately 	T2311	164.05	Chrome	3
		T2311BN	297.85	Brushed Nickel	3
		T2311NL	297.85	Polished Nickel	3
		T2311BL	303.55	Matte Black	3
		T2311ORB	327.60	Oil Rubbed Bronze	3
					
CIA™	POSI-TEMP® VALVE ONLY TRIM • red/blue markings: included • valve: sold separately 	T2261	163.35	Chrome	3
		T2261BN	296.65	Brushed Nickel	3
		T2261BG	296.65	Brushed Gold	3
		T2261BL	326.45	Matte Black	3
					
VOSS™	POSI-TEMP® VALVE ONLY TRIM • valve: sold separately 	T2691	163.35	Chrome	3
		T2691BN	296.65	Brushed Nickel	3
		T2691NL	296.65	Polished Nickel	3
		T2691BG	296.65	Brushed Gold	3
		T2691BL	303.65	Matte Black	3
		T2691ORB	326.45	Oil Rubbed Bronze	3
					
DARTMOOR™	POSI-TEMP® VALVE ONLY TRIM • valve: sold separately 	T2181	72.55	Chrome	3
		T2181BN	165.80	Brushed Nickel	3
		T2181BL	182.25	Matte Black	3
		T2181ORB	182.25	Oil Rubbed Bronze	3
					
GLYDE™	POSI-TEMP® VALVE ONLY TRIM • valve: sold separately 	T2741	72.55	Chrome	3
		T2741BN	165.80	Brushed Nickel	3
		T2741BL	182.25	Matte Black	3
					
BRANTFORD®	POSI-TEMP® VALVE ONLY TRIM • valve: sold separately 	T2151	72.55	Chrome	3
		T2151BN	165.80	Brushed Nickel	3
		T2151ORB	182.25	Oil Rubbed Bronze	3
					
EVA®	POSI-TEMP® VALVE ONLY TRIM • valve: sold separately 	T2131	72.55	Chrome	3
		T2131BN	165.80	Brushed Nickel	3
		T2131ORB	182.25	Oil Rubbed Bronze	3
					

Posi-Temp® Valve Only Shower Options

		MODEL	LIST	FINISH/CONNECT	CASE QTY
GIBSON™ POSI-TEMP® VALVE ONLY TRIM					
 <ul style="list-style-type: none"> • red/blue markings: included • valve: sold separately 	 	T2901	71.15	Chrome	3
		T2901BN	146.05	Brushed Nickel	3
		T2901BL	160.70	Matte Black	3
GENTA™ LX POSI-TEMP® VALVE ONLY TRIM					
 <ul style="list-style-type: none"> • red/blue markings: included • valve: sold separately 	 	T2471	68.15	Chrome	3
		T2471BN	139.60	Brushed Nickel	3
		T2471BL	153.60	Matte Black	3
CHATEAU® POSI-TEMP® VALVE ONLY TRIM					
 <ul style="list-style-type: none"> • red/blue markings: included • valve: sold separately 		T181	45.45	Chrome	12
		 <ul style="list-style-type: none"> • red/blue markings: included • valve: sold separately 	 	TL181	45.45

CUSTOM SHOWERING

POSI-TEMP®**Multi-Function Showering Options**

Moen has all the components necessary for you to build a custom shower spa. And, we're making it easy for you to pull together the sku numbers you need. Charts of common shower spa configurations are included so that all the components can be ordered. The charts below illustrate one layout and option of showering components. Refer to pages 437 - 466 in the Custom Showering section to choose from our wide array of showering products, styles and finishes to meet your preference. For additional assistance, call your Moen Sales Representative.

**Shower Spa Options****POSI-TEMP® SHOWER HEAD & HANDSHOWER**

3 function (2 discrete/1 shared)

or

2 function (2 discrete)

Belfield™ suite shown.

Suite	Posi-Temp 2 Function [2 discrete] -or- 3 Function [2 discrete / 1 shared] Transfer Valve with W=Volume Control Valve Trim	Showerhead	Shower Arm	Shower Arm Flange	Handheld Shower with Slide Bar	Drop Ell
Weymouth®	TS32100	S1311	S113		S12107EP	A725
Arris®	TS22000	S112	S110		3887EP	A725
90°®	TS2710	S6340	123815	147572	S3880EP	A721
Doux™	TS22000	S176	123815	137488	3887EP	A725
Wynford®	T4500	S6310	123815	AT2199	3667EP	A725
Align®	T2190	S176	123815	137488	3887EP	A725
Rizon®	T2810	6345	123815	AT2199	3988EP	A721
Belfield™	T2310	S6310	123815	AT2199	3667EP	A725
Voss™	T2690	S6365	123815	AT2199	3988EP	A721
Gibson™	T2900	6345	123815	137488	3669EP	A725
Genta™ LX	T2470	6345	123815	137488	3988EP	A721

* 2551 / 2581 - 2 independent + 1 shared function.

* 2521 / 2571 - 2 independent functions.

Valve	Flow Rate through shower port (GPM) @ 20 PSI	Flow Rate through shower port (GPM) @ 40 PSI	Flow Rate through shower port (GPM) @ 60 PSI	Used with 2- or 3-Function Transfer
Posi-Temp® valves 2521, 2571, 2551, 2581	*3.0	*4.0	*5.0	No

Posi-Temp® Multi-Function Showering Configuration

CUSTOM SHOWERING

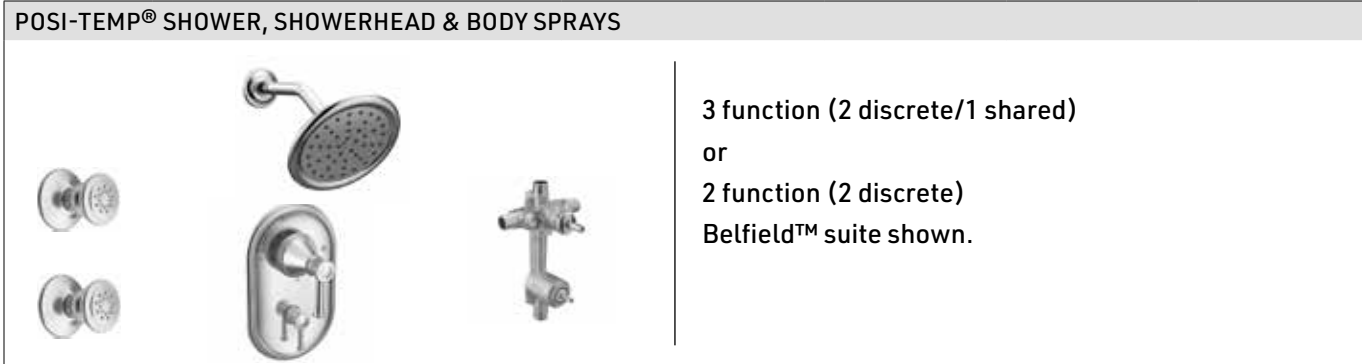

Suite	Posi-Temp® 2 Function (2 discrete) -or- 3 Function (2 discrete / 1 shared) Transfer Valve with Volume Control Valve Trim	Showerhead	Shower Arm	Shower Arm Flange	Bodyspray and Quantity
Weymouth®	TS32100	S1311	S113		A501 x 2
Arris®	TS22000	S112	S110		A501 x 2
90°®	TS2710	S6340	123815	147572	A501 x 2
Doux™	TS22000	S176	123815	137488	A501 x 2
Wynford®	T4500	S6310	123815	AT2199	A501 x 2
Align®	T2190	S176	123815	137488	A501 x 2
Rizon®	T2810	6345	123815	AT2199	A501 x 2
Belfield™	T2310	S6310	123815	AT2199	A501 x 2
Voss™	T2690	S6365	123815	AT2199	A501 x 2
Gibson™	T2900	6345	123815	137488	A501 x 2
Genta™ LX	T2470	6345	123815	137488	A501 x 2

* 2551 / 2581 - 2 independent + 1 shared function.

* 2521 / 2571 - 2 independent functions.

Valve	Flow Rate through shower port (GPM) @ 20 PSI	Flow Rate through shower port (GPM) @ 40 PSI	Flow Rate through shower port (GPM) @ 60 PSI	Used with 2- or 3-Function Transfer
Posi-Temp® valves 2521, 2571, 2551, 2581	*3.0	*4.0	*5.0	No

Posi-Temp® Multi-Function Showering Configuration

POSI-TEMP® SHOWER, SHOWERHEAD & TUB SPOUT



3 function (2 discrete/1 shared)
or
2 function (2 discrete)
Belfield™ suite shown.

















Suite	Posi-Temp 2 Function [2 discrete] -or- 3 Function [2 discrete / 1 shared] Transfer Valve with W=Volume Control Valve Trim	Showerhead	Shower Arm	Shower Arm Flange	Non-diverter Tub Spout
Weymouth®	TS32100	S1311	S113		S12105
Arris®	TS22000	S112	S110		S16900
90°®	TS2710	S6340	123815	147572	S3898
Doux™	TS22000	S176	123815	137488	S3836
Wynford®	T4500	S6310	123815	AT2199	S195386
Align®	T2190	S176	123815	137488	3892
Rizon®	T2810	6345	123815	AT2199	3829
Belfield™	T2310	S6310	123815	AT2199	3858
Voss™	T2690	S6365	123815	AT2199	191956
Gibson™	T2900	6345	123815	137488	3892
Genta™ LX	T2470	6345	123815	137488	3829

* 2551 / 2581 - 2 independent + 1 shared function.

* 2521 / 2571 - 2 independent functions.









Valve	Flow Rate through shower port (GPM) @ 20 PSI	Flow Rate through shower port (GPM) @ 40 PSI	Flow Rate through shower port (GPM) @ 60 PSI	Used with 2- or 3-Function Transfer
Posi-Temp® valves 2521, 2571, 2551, 2581	*3.0	*4.0	*5.0	No

Posi-Temp® Multi-Function Showering Options



		MODEL	LIST	FINISH/CONNECT	CASE QTY
WEYMOUTH® 	POSI-TEMP® WITH INTEGRATED TRANSFER VALVE TRIM - PREMIUM • valve: sold separately ♿️ 	TS32100	879.40	Chrome	4
		TS32100BN	1243.55	Brushed Nickel	4
		TS32100NL	1243.55	Polished Nickel	4
		TS32100BG	1243.55	Brushed Gold	4
		TS32100BL	1342.00	Matte Black	4
		TS32100ORB	1342.00	Oil Rubbed Bronze	4
ARRIS® 	POSI-TEMP® WITH INTEGRATED TRANSFER VALVE TRIM - PREMIUM • valve: sold separately ♿️ 	TS22000	817.40	Chrome	4
		TS22000BL	1336.80	Matte Black	4
90°™ 	POSI-TEMP® WITH INTEGRATED TRANSFER VALVE TRIM - PREMIUM • valve: sold separately ♿️ 	TS2710	495.85	Chrome	4
		TS2710BN	918.05	Brushed Nickel	4
		TS2710BL	942.10	Matte Black	4
DOUX™ 	POSI-TEMP® WITH INTEGRATED TRANSFER VALVE TRIM - PREMIUM • valve: sold separately ♿️ 	TS2200	533.50	Chrome	4
		TS2200BN	773.55	Brushed Nickel	4
		TS2200BL	851.00	Matte Black	4
WYNFORD® 	POSI-TEMP® WITH INTEGRATED TRANSFER VALVE TRIM • valve: sold separately ♿️ 	T4500	307.35	Chrome	4
		T4500BN	558.00	Brushed Nickel	4
		T4500ORB	613.95	Oil Rubbed Bronze	4
ALIGN® 	POSI-TEMP® WITH INTEGRATED TRANSFER VALVE TRIM • red/blue markings: included • valve: sold separately ♿️ 	T2190	307.35	Chrome	4
		T2190BN	558.00	Brushed Nickel	4
		T2190BG	558.00	Brushed Gold	4
		T2190BL	613.95	Matte Black	4
RIZON® 	POSI-TEMP® WITH INTEGRATED TRANSFER VALVE TRIM • red/blue markings: included • valve: sold separately ♿️ 	T2810	307.35	Chrome	4
		T2810BL	613.95	Matte Black	4
BELFIELD™ 	POSI-TEMP® WITH INTEGRATED TRANSFER VALVE TRIM • valve: sold separately ♿️ 	T2310	296.15	Chrome	4
		T2310BN	537.75	Brushed Nickel	4
		T2310NL	537.75	Polished Nickel	4
		T2310BL	547.90	Matte Black	4
		T2310ORB	591.55	Oil Rubbed Bronze	4

CUSTOM SHOWERING







Posi-Temp® Multi-Function Showering Options

		MODEL	LIST	FINISH/CONNECT	CASE QTY
	POSI-TEMP® WITH INTEGRATED TRANSFER VALVE TRIM • valve: sold separately  	T2690	295.00	Chrome	4
		T2690BN	535.60	Brushed Nickel	4
		T2690NL	535.60	Polished Nickel	4
		T2690BG	535.60	Brushed Gold	4
		T2690BL	545.65	Matte Black	4
		T2690ORB	589.15	Oil Rubbed Bronze	4
			POSI-TEMP® WITH INTEGRATED TRANSFER VALVE TRIM • red/blue markings: included • valve: sold separately  	T2900	105.55
T2900BN	153.10			Brushed Nickel	4
T2900BL	168.45			Matte Black	4
	POSI-TEMP® WITH INTEGRATED TRANSFER VALVE TRIM • red/blue markings: included • valve: sold separately  			T2470	101.15
		T2470BN	146.65	Brushed Nickel	4
		T2470BL	157.95	Matte Black	4

1.5 GPM SHOWERING OPTIONS				
MODEL NUMBER	DESCRIPTION	LIST PRICE	FINISH	CASE QTY.
S176EP15	Rainshower	254.10	Chrome	3
S176EP15BN	Rainshower	349.35	Brushed Nickel	3
S176EP15BG	Rainshower	349.35	Brushed Gold	3
S176EP15BL	Rainshower	366.80	Matte Black	3
S6340EP15	Rainshower	259.20	Chrome	3
S6340EP15BN	Rainshower	356.35	Brushed Nickel	3
6512EP15	Rainshower	134.65	Chrome	12
6512EP15BN	Rainshower	216.35	Brushed Nickel	12
6512EP15BL	Rainshower	238.10	Matte Black	12
S6335EP15	Showerhead	203.25	Chrome	6
6302EP15	Showerhead	117.05	Chrome	12
6399EP15	Showerhead	124.80	Chrome	12
6399EP15BN	Showerhead	181.20	Brushed Nickel	12
6399EP15BG	Showerhead	194.75	Brushed Gold	12
6399EP15BL	Showerhead	214.35	Matte Black	12
6313	Showerhead	64.70	Chrome	12
6313BN	Showerhead	99.15	Brushed Nickel	12
6313ORB	Showerhead	109.05	Oil Rubbed Bronze	12
6300EP15	Showerhead	45.40	Chrome	12
157276EP15	Handheld Shower	84.65	Chrome	6

	MODEL	LIST	FINISH/CONNECT	CASE QTY		
RAINSHOWER - PREMIUM						
<ul style="list-style-type: none"> • connection: 1/2" IPS • showerhead: two-function rainshower • showerhead size: 9" diameter • type of function: full spray; concentrated rinse  <p>IMMERSION</p>	2.5 GPM (9.5 L/min) max.					
		S1311	622.85	Chrome	3	
		S1311BN	850.10	Brushed Nickel	3	
		S1311NL	850.10	Polished Nickel	3	
		S1311BG	850.10	Brushed Gold	3	
		S1311BL	935.05	Matte Black	3	
		S1311ORB	935.05	Oil Rubbed Bronze	3	
	<ul style="list-style-type: none"> • connection: 1/2" IPS • showerhead: single-function rainshower • showerhead size: 12" diameter • type of function: full rainshower • metal construction • recommended for over-head mount application only 	1.75 GPM (6.65 L/min) max.				
			S1311EP	622.85	Chrome	3
			S1311EPBN	850.10	Brushed Nickel	3
			S1311EPNL	850.10	Polished Nickel	3
			S1311EPBG	850.10	Brushed Gold	3
			S1311EPBL	935.05	Matte Black	3
		S1311EPORB	935.05	Oil Rubbed Bronze	3	
<ul style="list-style-type: none"> • connection: 1/2" IPS • showerhead: single-function rainshower • showerhead size: 12" diameter • type of function: full rainshower • metal construction • recommended for over-head mount application only 	2.5 GPM (9.5 L/min) max.					
		S1002	592.30	Chrome	3	
		S1002EP	592.30	Chrome	3	
1.75 GPM (6.65 L/min) max.						
	S1004	592.30	Chrome	3		
	S1004EP	592.30	Chrome	3		

Showerheads

		MODEL	LIST	FINISH/CONNECT	CASE QTY
RAINSHOWER - PREMIUM					
	<ul style="list-style-type: none"> • connection: 1/2" IPS • showerhead: single-function rainshower • showerhead size: 10" diameter • type of function: full rainshower • metal construction • recommended for over-head mount application only 	2.5 GPM (9.5 L/min) max.			
		S1001	555.30	Chrome	3
	<ul style="list-style-type: none"> • connection: 1/2" IPS • showerhead: single-function rainshower • showerhead size: 10" diameter • type of function: full rainshower • metal construction • recommended for over-head mount application only 	2.5 GPM (9.5 L/min) max.			
		S1003	555.30	Chrome	3
	<ul style="list-style-type: none"> • connection: 1/2" IPS • showerhead: single-function rainshower • showerhead size: 10" diameter • type of function: full spray IMMERSON	2.5 GPM (9.5 L/min) max.			
		S112	583.85	Chrome	3
	<ul style="list-style-type: none"> • connection: 1/2" IPS • showerhead: two-function rainshower • showerhead size: 8" diameter • type of function: full spray; concentrated rinse IMMERSON	S112BN	790.55	Brushed Nickel	3
		S112NL	790.55	Polished Nickel	3
		S112BG	790.55	Brushed Gold	3
		S112WR	869.55	Wrought Iron	3
		S112ORB	869.55	Oil Rubbed Bronze	3
		1.75 GPM (6.65 L/min) max.			
		S112EP	583.85	Chrome	3
		S112EPBN	790.55	Brushed Nickel	3
		S112EPNL	869.55	Polished Nickel	3
		S112EPBG	790.55	Brushed Gold	3
		S112EPWR	869.55	Wrought Iron	3
		S112EPORB	869.55	Oil Rubbed Bronze	3
		2.5 GPM (9.5 L/min) max.			
		S6320	394.80	Chrome	3
S6320BN	620.45	Brushed Nickel	3		
S6320BG	620.45	Brushed Gold	3		
S6320BL	682.40	Matte Black	3		
S6320ORB	682.40	Oil Rubbed Bronze	3		
1.75 GPM (6.65 L/min) max.					
S6320EP	394.80	Chrome	3		
S6320EPBN	620.45	Brushed Nickel	3		
S6320EPBG	620.45	Brushed Gold	3		
S6320EPBL	682.40	Matte Black	3		
S6320EPORB	682.40	Oil Rubbed Bronze	3		
	<ul style="list-style-type: none"> • connection: 1/2" IPS • showerhead: two-function rainshower • showerhead size: 8-1/2" diameter • type of function: full rainshower; concentrated rinse; combination IMMERSON	2.5 GPM (9.5 L/min) max.			
		S6345	405.95	Chrome	3
	<ul style="list-style-type: none"> • connection: 1/2" IPS • showerhead: single-function rainshower • showerhead size: 8" diameter • type of function: full spray IMMERSON	S6345BN	638.00	Brushed Nickel	3
		S6345BG	638.00	Brushed Gold	3
		S6345BL	701.70	Matte Black	3
		1.75 GPM (6.65 L/min) max.			
		S6345EP	405.95	Chrome	3
		S6345EPBN	638.00	Brushed Nickel	3
		S6345EPBG	638.00	Brushed Gold	3
		S6345EPBL	701.70	Matte Black	3
		2.5 GPM (9.5 L/min) max.			
		S6360	377.30	Chrome	3
		S6360BN	565.95	Brushed Nickel	3
		S6360ORB	623.50	Oil Rubbed Bronze	3
		1.75 GPM (6.65 L/min) max.			
		S6360EP	377.30	Chrome	3
S6360EPBN	565.95	Brushed Nickel	3		
S6360EPORB	623.50	Oil Rubbed Bronze	3		

Showerheads

CUSTOM SHOWERING

RAINSHOWER - PREMIUM

- connection: 1/2" IPS
- showerhead: single-function rainshower
- showerhead size: 6-3/4" diameter
- type of function: full spray

IMMERSION



MODEL LIST FINISH/CONNECT CASE QTY

2.5 GPM (9.5 L/min) max.

S176	259.20	Chrome	3
S176BN	356.35	Brushed Nickel	3
S176BG	356.35	Brushed Gold	3
S176BL	374.15	Matte Black	3

1.75 GPM (6.65 L/min) max.

S176EP	259.20	Chrome	3
S176EPBN	356.35	Brushed Nickel	3
S176EPBG	356.35	Brushed Gold	3
S176EPBL	374.15	Matte Black	3

1.5 GPM (5.7 L/min) max.

NEW! S176EP15	254.10	Chrome	3
NEW! S176EP15BN	349.35	Brushed Nickel	3
NEW! S176EP15BG	349.35	Brushed Gold	3
NEW! S176EP15BL	366.80	Matte Black	3

- connection: 1/2" IPS
- showerhead: single-function rainshower
- showerhead size: 7" diameter
- type of function: full spray

IMMERSION



2.5 GPM (9.5 L/min) max.

S6310	259.20	Chrome	3
S6310BN	356.35	Brushed Nickel	3
S6310NL	339.30	Polished Nickel	3
S6310WR	374.15	Wrought Iron	3
S6310ORB	374.15	Oil Rubbed Bronze	3

1.75 GPM (6.65 L/min) max.

S6310EP	259.20	Chrome	3
S6310EPBN	356.35	Brushed Nickel	3
S6310EPNL	339.30	Polished Nickel	3
S6310EPWR	374.15	Wrought Iron	3
S6310EPORB	374.15	Oil Rubbed Bronze	3

- connection: 1/2" IPS
- showerhead: single-function rainshower
- showerhead size: 6" diameter
- type of function: full spray

IMMERSION



2.5 GPM (9.5 L/min) max.

S6340	259.20	Chrome	3
S6340BN	356.35	Brushed Nickel	3

1.75 GPM (6.65 L/min) max.

S6340EP	259.20	Chrome	3
S6340EPBN	356.35	Brushed Nickel	3

1.5 GPM (5.7 L/min) max.

NEW! S6340EP15	259.20	Chrome	3
NEW! S6340EP15BN	356.35	Brushed Nickel	3

- connection: 1/2" IPS
- showerhead: single-function rainshower
- showerhead size: 6" diameter
- type of function: full spray

IMMERSION



2.5 GPM (9.5 L/min) max.

S6365	259.20	Chrome	3
S6365BN	356.35	Brushed Nickel	3
S6365NL	356.35	Polished Nickel	3
S6365BG	356.35	Brushed Gold	3
S6365BL	374.15	Matte Black	3
S6365ORB	374.15	Oil Rubbed Bronze	3

1.75 GPM (6.65 L/min) max.

S6365EP	259.20	Chrome	3
S6365EPBN	356.35	Brushed Nickel	3
S6365EPNL	356.35	Polished Nickel	3
S6365EPBG	356.35	Brushed Gold	3
S6365EPBL	374.15	Matte Black	3
S6365EPORB	374.15	Oil Rubbed Bronze	3

- connection: 1/2" IPS
- showerhead: single-function rainshower
- showerhead size: 6-3/4" diameter
- type of function: full spray

IMMERSION







2.5 GPM (9.5 L/min) max.

S178	256.10	Chrome	3
S178BN	356.35	Brushed Nickel	3
S178BG	356.35	Brushed Gold	3
S178BL	374.15	Matte Black	3

1.75 GPM (6.65 L/min) max.







S178EP	256.10	Chrome	3
S178EPBN	356.35	Brushed Nickel	3
S178EPBG	356.35	Brushed Gold	3
S178EPBL	374.15	Matte Black	3

Showerheads

		MODEL	LIST	FINISH/CONNECT	CASE QTY			
RAINSHOWER								
 <p>NEW!</p> <ul style="list-style-type: none"> • Infiniti™ dial allows user to precisely adjust to preferred balance of force and coverage • connection: 1/2" IPS • showerhead size: 7" diameter 	2.5 GPM (9.5 L/min) max. 220R5 275.40 Chrome 2 220R5BN 358.00 Brushed Nickel 2 220R5BL 358.00 Matte Black 2 220R5BG 393.80 Brushed Gold 2							
	1.75 GPM (6.65 L/min) max. 220R5EP 275.40 Chrome 2 220R5EPBN 358.00 Brushed Nickel 2 220R5EPBL 358.00 Matte Black 2 220R5EPBG 393.80 Brushed Gold 2							
	 <p>NEW!</p> <ul style="list-style-type: none"> • Infiniti™ dial allows user to precisely adjust to preferred balance of force and coverage • connection: 1/2" IPS • showerhead size: 7" diameter 	2.5 GPM (9.5 L/min) max. 220R7 275.40 Chrome 2 220R7BN 358.00 Brushed Nickel 2 220R7BG 393.80 Brushed Gold 2 220R7BL 358.00 Matte Black 2						
		1.75 GPM (6.65 L/min) max. 220R7EP 275.40 Chrome 2 220R7EPBN 358.00 Brushed Nickel 2 220R7EPBG 393.80 Brushed Gold 2 220R7EPBL 358.00 Matte Black 2						
		 <ul style="list-style-type: none"> • Infiniti™ dial allows user to precisely adjust to preferred balance of force and coverage • Magnetix technology: showerhead easily detaches from showerarm for cleaning and easily snaps back in place • connection: 1/2" IPS • showerhead size: 9" diameter 	2.5 GPM (9.5 L/min) max. 220R3 282.80 Chrome 2 220R3BN 367.65 Brushed Nickel 2 220R3BG 367.65 Brushed Gold 2 220R3BL 422.80 Matte Black 2					
			1.75 GPM (6.65 L/min) max. 220R3EP 282.80 Chrome 2 220R3EPBN 367.65 Brushed Nickel 2 220R3EPBG 367.65 Brushed Gold 2 220R3EPBL 422.80 Matte Black 2					
			 <ul style="list-style-type: none"> • connection: 1/2" IPS • showerhead: single-function standard • showerhead size: 8" diameter • type of function: full spray 	2.5 GPM (9.5 L/min) max. 6345 111.95 Chrome 3 6345BN 126.10 Brushed Nickel 3 6345BG 126.10 Brushed Gold 3 6345BL 140.25 Matte Black 3 6345ORB 140.25 Oil Rubbed Bronze 3				
				1.75 GPM (6.65 L/min) max. 6345EP 111.95 Chrome 3 6345EPBN 126.10 Brushed Nickel 3 6345EPBG 126.10 Brushed Gold 3 6345EPBL 140.25 Matte Black 3 6345EPORB 140.25 Oil Rubbed Bronze 3				

Showerheads

CUSTOM SHOWERING

	MODEL	LIST	FINISH/CONNECT	CASE QTY
FIXED SHOWER HEAD - PREMIUM				
 <ul style="list-style-type: none"> • connection: 1/2" IPS • showerhead: single-function standard • showerhead size: 6-1/2" diameter • type of function: full spray 	2.5 GPM (9.5 L/min) max.			
	S6335	203.25	Chrome	6
	S6335BN	276.70	Brushed Nickel	6
	1.75 GPM (6.65 L/min) max.			
	S6335EP	203.25	Chrome	6
	S6335EPBN	276.70	Brushed Nickel	6
 <ul style="list-style-type: none"> • connection: 1/2" IPS • showerhead: single-function standard • showerhead size: 5-7/8" diameter • type of function: full spray 	1.5 GPM (5.7 L/min) max.			
	S6335EP15	203.25	Chrome	6
	2.5 GPM (9.5 L/min) max.			
	S6312	168.60	Chrome	12
	S6312BN	200.40	Brushed Nickel	12
	S6312NL	200.40	Polished Nickel	12
	S6312ORB	220.35	Oil Rubbed Bronze	12
	1.75 GPM (6.65 L/min) max.			
	S6312EP	168.60	Chrome	12
	S6312EPBN	200.40	Brushed Nickel	12
S6312EPNL	200.40	Polished Nickel	6	
S6312EPORB	220.35	Oil Rubbed Bronze	12	
FIXED SHOWER HEAD				
 <ul style="list-style-type: none"> • connection: 1/2" IPS • showerhead: four-function standard • showerhead size: 4-3/8" diameter • type of function: full spray; invigorating spray; combination; targeted massage 	2.5 GPM (9.5 L/min) max.			
	3638	135.30	Chrome	12
	3638BN	229.65	Brushed Nickel	12
	3638BG	229.65	Brushed Gold	12
	3638BL	231.85	Matte Black	12
	3638ORB	252.70	Oil Rubbed Bronze	12
	1.75 GPM (6.65 L/min) max.			
	3638EP	135.30	Chrome	12
3638EPBN	229.65	Brushed Nickel	12	
3638EPBG	210.70	Brushed Gold	12	
3638EPBL	223.50	Matte Black	12	
 <ul style="list-style-type: none"> • connection: 1/2" IPS • showerhead: six-function eco-performance • showerhead size: 4-1/2" diameter • type of function: wide coverage; downpour; massage; relaxing spray; rinse; full spray 	1.75 GPM (6.65 L/min) max.			
	6512EP	137.35	Chrome	12
	6512EPBN	220.70	Brushed Nickel	12
	6512EPBL	242.85	Matte Black	12
	1.5 GPM (5.7 L/min) max.			
	NEW! 6512EP15	134.65	Chrome	12
	NEW! 6512EP15BN	216.35	Brushed Nickel	12
NEW! 6512EP15BL	238.10	Matte Black	12	
 <ul style="list-style-type: none"> • connection: 1/2" IPS • showerhead: single-function standard • showerhead size: 4-3/8" diameter • type of function: full spray 	2.5 GPM (9.5 L/min) max.			
	6302	117.05	Chrome	12
	6302BN	182.70	Brushed Nickel	12
	6302WR	201.00	Wrought Iron	12
	6302ORB	201.00	Oil Rubbed Bronze	12
	1.75 GPM (6.65 L/min) max.			
	6302EP	117.05	Chrome	12
	6302EPBN	182.70	Brushed Nickel	12
	6302EPORB	201.00	Oil Rubbed Bronze	12
	1.5 GPM (5.7 L/min) max.			
6302EP15	117.05	Chrome	12	
 <ul style="list-style-type: none"> • connection: 1/2" IPS • showerhead: single-function standard • showerhead size: 4-3/8" diameter • type of function: full spray • carded packaging: yes 	2.5 GPM (9.5 L/min) max.			
	CL6302	117.05	Chrome	12
	CL6302BN	182.70	Brushed Nickel	12
	1.75 GPM (6.65 L/min) max.			
	CL6302EP	117.05	Chrome	12
	CL6302EPBN	182.70	Brushed Nickel	12

Showerheads

		MODEL	LIST	FINISH/CONNECT	CASE QTY		
FIXED SHOWER HEAD							
	<ul style="list-style-type: none"> • connection: 1/2" IPS • showerhead: single-function standard • showerhead size: 3-3/4" diameter • type of function: full spray 	2.5 GPM (9.5 L/min) max.					
		6322	115.60	Chrome	12		
		6322BN	190.70	Brushed Nickel	12		
		6322BL	190.95	Matte Black	12		
		1.75 GPM (6.65 L/min) max.					
		6322EP	115.60	Chrome	12		
		6322EPBN	190.70	Brushed Nickel	12		
		6322EPBL	190.95	Matte Black	12		
			<ul style="list-style-type: none"> • connection: 1/2" IPS • showerhead: single-function standard • showerhead size: 4-1/16" diameter • type of function: full spray 	2.5 GPM (9.5 L/min) max.			
				6325	115.60	Chrome	12
6325BN	180.55			Brushed Nickel	12		
6325NL	180.55			Polished Nickel	12		
6325BG	180.55			Brushed Gold	12		
6325ORB	198.75			Oil Rubbed Bronze	12		
1.75 GPM (6.65 L/min) max.							
6325EP	115.60			Chrome	12		
6325EPBN	180.55			Brushed Nickel	12		
6325EPNL	180.55			Polished Nickel	12		
6325EPBG	180.55	Brushed Gold	12				
6325EPORB	198.75	Oil Rubbed Bronze	12				
	<ul style="list-style-type: none"> • connection: 1/2" IPS • showerhead: single-function standard • showerhead size: 3-5/8" diameter • type of function: full spray 	2.5 GPM (9.5 L/min) max.					
		6399	124.80	Chrome	12		
		6399BN	194.75	Brushed Nickel	12		
		6399BG	194.75	Brushed Gold	12		
		6399BL	214.35	Matte Black	12		
		1.75 GPM (6.65 L/min) max.					
		6399EP	124.80	Chrome	12		
		6399EPBN	194.75	Brushed Nickel	12		
		6399EPBG	194.75	Brushed Gold	12		
		6399EPBL	214.35	Matte Black	12		
1.5 GPM (5.7 L/min) max.							
6399EP15	124.80	Chrome	12				
NEW! 6399EP15BN	181.20	Brushed Nickel	12				
NEW! 6399EP15BG	194.75	Brushed Gold	12				
6399EP15BL	214.35	Matte Black	12				
	<ul style="list-style-type: none"> • connection: 1/2" IPS • showerhead: single-function standard • showerhead size: 3-3/4" diameter • type of function: full spray 	2.5 GPM (9.5 L/min) max.					
		6370	73.35	Chrome	12		
		6370BN	112.25	Brushed Nickel	12		
		6370BL	123.60	Matte Black	12		
		1.75 GPM (6.65 L/min) max.					
		6370EP	69.85	Chrome	12		
		6370EPBN	106.95	Brushed Nickel	3		
		6370EPBL	117.70	Matte Black	12		
			<ul style="list-style-type: none"> • connection: 1/2" IPS • showerhead: single-function standard • showerhead size: 4" diameter • type of function: full spray 	2.5 GPM (9.5 L/min) max.			
				6371	73.35	Chrome	12
6371BN	112.25			Brushed Nickel	12		
6371BL	123.60			Matte Black	12		
6371ORB	123.60			Oil Rubbed Bronze	12		
1.75 GPM (6.65 L/min) max.							
6371EP	69.85			Chrome	12		
6371EPBN	106.95			Brushed Nickel	12		
6371EPBL	117.70			Matte Black	12		
6371EPORB	117.70			Oil Rubbed Bronze	12		
	<ul style="list-style-type: none"> • connection: 1/2" IPS • showerhead: five-function standard • showerhead size: 4" diameter • type of function: refreshing spray; energizing spray; relaxing spray; targeted massage; invigorating spray • carded packaging: yes 	2.5 GPM (9.5 L/min) max.					
		CL26500	68.95	Chrome	12		
		CL26500BN	112.50	Brushed Nickel	12		
		1.75 GPM (6.65 L/min) max.					
		CL26500EP	68.95	Chrome	12		
CL26500EPBN	112.50	Brushed Nickel	12				











Showerheads

FIXED SHOWER HEAD

		MODEL	LIST	FINISH/CONNECT	CASE QTY
 <ul style="list-style-type: none"> • connection: 1/2" IPS • showerhead: single-function standard • showerhead size: 3-1/2" diameter • type of function: full spray 		2.5 GPM (9.5 L/min) max.			
		6303	64.70	Chrome	12
		6303BN	99.15	Brushed Nickel	12
		6303ORB	109.05	Oil Rubbed Bronze	12
		1.75 GPM (6.65 L/min) max.			
		6303EP	64.70	Chrome	12
		6303EPBN	99.15	Brushed Nickel	12
		6303EPORB	109.05	Oil Rubbed Bronze	12
		1.5 GPM (5.7 L/min) max.			
		6313	64.70	Chrome	12
	6313BN	99.15	Brushed Nickel	12	
	6313ORB	109.05	Oil Rubbed Bronze	12	
 <ul style="list-style-type: none"> • connection: 1/2" IPS • showerhead: single-function standard • showerhead size: 3-1/2" diameter • type of function: full spray • carded packaging: yes 		2.5 GPM (9.5 L/min) max.			
		CL6303	64.70	Chrome	12
		CL6303BN	99.15	Brushed Nickel	12
		1.75 GPM (6.65 L/min) max.			
		CL6303EP	64.70	Chrome	12
	CL6303EPBN	99.15	Brushed Nickel	12	
 <ul style="list-style-type: none"> • connection: 1/2" IPS • showerhead: four-function standard • showerhead size: 3-1/2" diameter • type of function: energizing massage; full spray; refreshing spray; invigorating spray 		2.5 GPM (9.5 L/min) max.			
		23026	44.10	Chrome	4
 <ul style="list-style-type: none"> • connection: 1/2" IPS • showerhead: three-function eco-performance • showerhead size: 3-3/4" diameter • type of function: full spray; refreshing spray; targeted massage 		1.75 GPM (6.65 L/min) max.			
		20001	38.55	Chrome	3
 <ul style="list-style-type: none"> • connection: 1/2" IPS • showerhead: single-function standard • showerhead size: 2-1/2" diameter • type of function: full spray 		2.5 GPM (9.5 L/min) max.			
		6300	45.40	Chrome	12
		6300BN	69.25	Brushed Nickel	12
		1.75 GPM (6.65 L/min) max.			
		6300EP	45.40	Chrome	12
		6300EPBN	69.25	Brushed Nickel	12
		1.5 GPM (5.7 L/min) max.			
	6300EP15	45.40	Chrome	12	











CUSTOM SHOWERING

Shower Arms and Flanges





		MODEL	LIST	FINISH/CONNECT	CASE QTY
SHOWER ARM ONLY					
	<ul style="list-style-type: none"> • connection: 1/2" IPS • length: 18" 	336651	86.15	Chrome	6
		336651BN	167.50	Brushed Nickel	6
		336651NL	167.50	Polished Nickel	6
		336651BG	167.50	Brushed Gold	6
		336651BL	184.05	Matte Black	6
		336651ORB	184.05	Oil Rubbed Bronze	6
	<ul style="list-style-type: none"> • connection: 1/2" IPS • length: 12" 	226651	57.60	Chrome	6
		226651BN	111.65	Brushed Nickel	6
		226651NL	111.65	Polished Nickel	6
		226651BG	111.65	Brushed Gold	6
		226651WR	122.75	Wrought Iron	6
		226651ORB	122.75	Oil Rubbed Bronze	6
	<ul style="list-style-type: none"> • connection: 1/2" IPS • length: 6" 	116651	18.60	Chrome	6
		116651BN	31.50	Brushed Nickel	6
		116651NL	31.50	Polished Nickel	6
		116651BG	31.50	Brushed Gold	6
		116651WR	40.95	Wrought Iron	6
		116651ORB	40.95	Oil Rubbed Bronze	6
	<ul style="list-style-type: none"> • connection: 1/2" IPS • length: 16" 	151380	95.35	Chrome	6
		151380BN	162.10	Brushed Nickel	6
		151380BG	162.10	Brushed Gold	6
		151380BL	178.20	Matte Black	6
		151380ORB	178.20	Oil Rubbed Bronze	6
			<ul style="list-style-type: none"> • connection: 1/2" IPS • length: 8" 	123815	36.65
123815BN	61.10			Brushed Nickel	12
123815NL	61.10			Polished Nickel	12
123815BG	61.10			Brushed Gold	12
123815BL	67.20			Matte Black	12
123815ORB	67.20			Oil Rubbed Bronze	12
	<ul style="list-style-type: none"> • connection: 1/2" IPS • length: 6" 	10154	27.00	Chrome	50
		10154BN	48.45	Brushed Nickel	50
		10154NL	48.45	Polished Nickel	1
		10154BG	48.45	Brushed Gold	30
		10154BRB	37.05	Mediterranean Bronze	20
		10154BL	45.75	Matte Black	30
10154ORB	53.30	Oil Rubbed Bronze	50		
SHOWER ARM AND FLANGE - PREMIUM					
	<ul style="list-style-type: none"> • connection: 1/2" IPS • adjustable locking pivot points allow for increased range of articulating showerhead positions • short or long inlet arm can be installed to plumbed connection • length: 16" 	S116	185.45	Chrome	6
		S116BN	222.35	Brushed Nickel	6
		S116BG	222.35	Brushed Gold	6
		S116BL	244.60	Matte Black	6
		S116ORB	244.60	Oil Rubbed Bronze	6
			<ul style="list-style-type: none"> • connection: 1/2" IPS • length: 14" 	S110	170.75
S110BN	206.80			Brushed Nickel	6
S110BG	206.80			Brushed Gold	6
S110BL	227.30			Matte Black	6
S110ORB	227.30			Oil Rubbed Bronze	6
	<ul style="list-style-type: none"> • connection: 1/2" IPS • length: 14" 			S113	170.75
		S113BN	206.80	Brushed Nickel	6
		S113NL	206.80	Polished Nickel	3
		S113BG	206.80	Brushed Gold	6
		S113WR	227.30	Wrought Iron	3
		S113ORB	227.30	Oil Rubbed Bronze	6
	<ul style="list-style-type: none"> • connection: 1/2" IPS • length: 8" 	S122	62.75	Chrome	6
		S122BN	129.60	Brushed Nickel	6
		S122NL	129.60	Polished Nickel	6
		S122BG	129.60	Brushed Gold	6
		S122BL	142.70	Matte Black	6
		S122ORB	142.70	Oil Rubbed Bronze	6

Shower Arms and Flanges

CUSTOM SHOWERING





		MODEL	LIST	FINISH/CONNECT	CASE QTY
SHOWER ARM AND FLANGE - PREMIUM					
	<ul style="list-style-type: none"> • connection: 1/2" IPS • length: 8" 	S134	62.75	Chrome	6
		S134BN	129.60	Brushed Nickel	6
		S134BG	129.60	Brushed Gold	6
		S134BL	142.70	Matte Black	6
	<ul style="list-style-type: none"> • connection: 1/2" IPS • length: 8" 	S133	62.75	Chrome	6
		S133BN	129.60	Brushed Nickel	6
		S133BG	129.60	Brushed Gold	6
		S133BL	142.70	Matte Black	6
	<ul style="list-style-type: none"> • connection: 1/2" IPS • length: 6" 	S177	62.60	Chrome	6
		S177BN	129.60	Brushed Nickel	6
SHOWER ARM AND FLANGE					
	<ul style="list-style-type: none"> • connection: 1/2" IPS • length: 8" 	161951	124.95	Chrome	12
		161951BN	169.00	Brushed Nickel	12
		161951NL	169.00	Polished Nickel	12
		161951BG	169.00	Brushed Gold	12
		161951BL	185.90	Matte Black	12
		161951ORB	185.90	Oil Rubbed Bronze	12
	<ul style="list-style-type: none"> • connection: 1/2" IPS • length: 8-3/4" 	177171	119.60	Chrome	12
		177171BN	161.70	Brushed Nickel	12
		177171NL	161.70	Polished Nickel	12
		177171ORB	177.95	Oil Rubbed Bronze	12
	<ul style="list-style-type: none"> • connection: 1/2" IPS • length: 6" 	A705	57.75	Chrome	12
		A705CBN	86.55	Classic Brushed Nickel	12
	<ul style="list-style-type: none"> • connection: 1/2" IPS • length: 8" 	CL123815	46.95	Chrome	12
		CL123815BN	88.65	Brushed Nickel	12
	<ul style="list-style-type: none"> • connection: 1/2" IPS • length: 6" 	CL10154	37.55	Chrome	12
		CL10154BN	75.85	Brushed Nickel	12
	<ul style="list-style-type: none"> • tub and shower accent kit 	AT2099	22.00	Chrome	12
		AT2099BN	55.90	Brushed Nickel	12
		AT2099ORB	61.40	Oil Rubbed Bronze	12
	<ul style="list-style-type: none"> • shower arm flange 	179834	18.20	Chrome	20
		179834BL	24.00	Matte Black	20

Shower Arms and Flanges

		MODEL	LIST	FINISH/CONNECT	CASE QTY
	• shower arm flange	147572	15.90	Chrome	12
		147572BN	23.20	Brushed Nickel	12
		147572BG	23.20	Brushed Gold	12
		147572BL	27.65	Matte Black	12
	• shower arm flange	164745	14.95	Chrome	20
		164745BN	21.85	Brushed Nickel	20
		164745NL	21.85	Polished Nickel	20
		164745BG	21.85	Brushed Gold	20
		164745ORB	28.35	Oil Rubbed Bronze	20
	• shower arm flange	137488	11.05	Chrome	200
		137488BN	28.75	Brushed Nickel	200
		137488NL	28.75	Polished Nickel	48
		137488BG	28.75	Brushed Gold	12
		137488BL	30.35	Matte Black	24
	• shower arm flange	AT2199	10.45	Chrome	200
		AT2199BN	27.55	Brushed Nickel	200
		AT2199NL	27.55	Polished Nickel	48
		AT2199BG	29.10	Brushed Gold	48
		AT2199WR	30.25	Wrought Iron	24
		AT2199ORB	30.25	Oil Rubbed Bronze	200





Handheld Showers

CUSTOM SHOWERING

		MODEL	LIST	FINISH/CONNECT	CASE QTY		
ANNEX™ SHOWER RAIL - PREMIUM							
	<ul style="list-style-type: none"> • connection: 1/2" IPS • showerhead: sold separately • handshower: sold separately • type of function: two independent functions • hose length: 59" 	TS3661NH	714.40	Chrome	3		
		TS3661NHBN	1128.60	Brushed Nickel	3		
		TS3661NHBG	1128.60	Brushed Gold	3		
		TS3661NHORB	1190.85	Oil Rubbed Bronze	3		
		TS3661NHBL	1190.85	Matte Black	3		
HANDHELD WITH SLIDEBAR - PREMIUM							
	<ul style="list-style-type: none"> • handshower: single-function eco-performance • showerhead size: 3-3/8" diameter • type of function: full spray • slide bar length: 30" • hose length: 69" • double check valve: included • slide bar: not to be used as a grab bar • drop ell: sold separately • use secure mount anchor to meet hand grip requirements 	1.75 GPM (6.65 L/min) max.					
		S12107EP	726.05	Chrome	6		
		S12107EPBN	1026.75	Brushed Nickel	6		
		S12107EPNL	1026.75	Polished Nickel	6		
		S12107EPBG	1026.75	Brushed Gold	6		
		S12107EPBL	1140.05	Matte Black	6		
		S12107EPORB	1129.30	Oil Rubbed Bronze	6		
		DROP ELLS SOLD SEPARATELY					
		A725	67.40	Chrome	12		
		A725BN	95.45	Brushed Nickel	12		
A725NL	95.45	Polished Nickel	12				
A725BG	100.85	Brushed Gold	12				
A725WR	104.95	Wrought Iron	12				
A725ORB	104.95	Oil Rubbed Bronze	12				
SECUREMOUNT™ ANCHORS SOLD SEPARATELY							
A750	42.50	N/A or Unfinished	24				
	<ul style="list-style-type: none"> • handshower: four-function eco-performance • showerhead size: 3-3/4" diameter • type of function: soothe; drench; shine; immerse • slide bar length: 30" • hose length: 69" • double check valve: included • slide bar: not to be used as a grab bar • drop ell: sold separately • use secure mount anchor to meet hand grip requirements 	1.75 GPM (6.65 L/min) max.					
		S3870EPBN	1002.20	Brushed Nickel	6		
		DROP ELLS SOLD SEPARATELY					
		A725BN	95.45	Brushed Nickel	12		
		SECUREMOUNT™ ANCHORS SOLD SEPARATELY					
		A750	42.50	N/A or Unfinished	24		
			<ul style="list-style-type: none"> • handshower: single-function eco-performance • showerhead size: 3" diameter • type of function: full spray • slide bar length: 30" • hose length: 69" • double check valve: included • slide bar: not to be used as a grab bar • drop ell: sold separately • use secure mount anchor to meet hand grip requirements 	1.75 GPM (6.65 L/min) max.			
				S3879EP	441.10	Chrome	6
				S3879EPBN	885.05	Brushed Nickel	6
				DROP ELLS SOLD SEPARATELY			
A721	86.25			Chrome	12		
A721BN	121.65			Brushed Nickel	12		
SECUREMOUNT™ ANCHORS SOLD SEPARATELY							
A750	42.50			N/A or Unfinished	24		
	<ul style="list-style-type: none"> • handshower: single-function eco-performance • showerhead size: 1" diameter • type of function: full spray • slide bar length: 30" • hose length: 69" • double check valve: included • slide bar: not to be used as a grab bar • metal construction • drop ell: sold separately • use secure mount anchor to meet hand grip requirements 			1.75 GPM (6.65 L/min) max.			
				S3880EP	441.10	Chrome	6
		S3880EPBN	885.05	Brushed Nickel	6		
		S3880EPNL	885.05	Polished Nickel	6		
		S3880EPBG	885.05	Brushed Gold	6		
		DROP ELLS SOLD SEPARATELY					
		A721	86.25	Chrome	12		
		A721BN	121.65	Brushed Nickel	12		
		A721NL	121.65	Polished Nickel	12		
		A721BG	121.65	Brushed Gold	12		
SECUREMOUNT™ ANCHORS SOLD SEPARATELY							
A750	42.50	N/A or Unfinished	24				

Handheld Showers





CUSTOM SHOWERING

	MODEL	LIST	FINISH/CONNECT	CASE QTY			
HANDBELED WITH SLIDEBAR							
 <ul style="list-style-type: none"> • handshower: five-function eco-performance • showerhead size: 4-1/2" diameter • type of function: pause; wide coverage; downpour; massage; rinse; full spray • slide bar length: 30" • hose length: 69" • double check valve: included • slide bar: not to be used as a grab bar • drop ell: sold separately • ADA compliant: yes 	1.75 GPM (6.65 L/min) max. 3670EP 401.70 Chrome 6 3670EPBN 582.45 Brushed Nickel 6 3670EPBL 640.60 Matte Black 6 DROP ELLS SOLD SEPARATELY A725 67.40 Chrome 12 A725BN 95.45 Brushed Nickel 12 A725WR 104.95 Wrought Iron 12 SECUREMOUNT™ ANCHORS SOLD SEPARATELY A750 42.50 N/A or Unfinished 24						
	 <ul style="list-style-type: none"> • handshower: five-function eco-performance • showerhead size: 4-1/2" diameter • type of function: pause; wide coverage; downpour; massage; rinse; full spray • slide bar length: 30" • hose length: 69" • double check valve: included • slide bar: not to be used as a grab bar • drop ell: sold separately • ADA compliant: yes 	1.75 GPM (6.65 L/min) max. 3671EP 401.70 Chrome 6 3671EPBN 582.45 Brushed Nickel 6 3671EPBL 640.60 Matte Black 6 DROP ELLS SOLD SEPARATELY A725 67.40 Chrome 12 A725BN 95.45 Brushed Nickel 12 A725WR 104.95 Wrought Iron 12 SECUREMOUNT™ ANCHORS SOLD SEPARATELY A750 42.50 N/A or Unfinished 24					
		 <ul style="list-style-type: none"> • handshower: four-function eco-performance • showerhead size: 4-3/8" diameter • type of function: full spray; invigorating spray; combination; targeted massage • slide bar length: 30" • hose length: 69" • double check valve: included • slide bar: not to be used as a grab bar • drop ell: sold separately • use secure mount anchor: to meet hand grip requirements 	1.75 GPM (6.65 L/min) max. 3667EP 358.60 Chrome 6 3667EPBN 708.95 Brushed Nickel 6 3667EPNL 708.95 Polished Nickel 6 3667EPBG 708.95 Brushed Gold 6 3667EPBL 779.85 Matte Black 6 3667EPORB 779.85 Oil Rubbed Bronze 6 DROP ELLS SOLD SEPARATELY A725 67.40 Chrome 12 A725BN 95.45 Brushed Nickel 12 A725NL 95.45 Polished Nickel 12 A725BG 100.85 Brushed Gold 12 A725WR 104.95 Wrought Iron 12 A725ORB 104.95 Oil Rubbed Bronze 12 SECUREMOUNT™ ANCHORS SOLD SEPARATELY A750 42.50 N/A or Unfinished 24				
			 <ul style="list-style-type: none"> • handshower: four-function eco-performance • showerhead size: 4" diameter • type of function: full spray; invigorating spray; combination; targeted massage • slide bar length: 30" • hose length: 69" • double check valve: included • slide bar: not to be used as a grab bar • drop ell: sold separately • use secure mount anchor to meet hand grip requirements 	1.75 GPM (6.65 L/min) max. 3669EP 358.60 Chrome 6 3669EPBN 708.95 Brushed Nickel 6 3669EPBL 779.85 Matte Black 6 3669EPORB 779.85 Oil Rubbed Bronze 6 DROP ELLS SOLD SEPARATELY A725 67.40 Chrome 12 A725BN 95.45 Brushed Nickel 12 A725WR 104.95 Wrought Iron 12 A725ORB 104.95 Oil Rubbed Bronze 12 SECUREMOUNT™ ANCHORS SOLD SEPARATELY A750 42.50 N/A or Unfinished 24			





Handheld Showers



CUSTOM SHOWERING

HANDHELD WITH SLIDEBAR











	MODEL	LIST	FINISH/CONNECT	CASE QTY	
 <ul style="list-style-type: none"> • handshower: single-function eco-performance • showerhead size: 1-1/8" diameter • type of function: full spray • slide bar length: 30" • hose length: 69" • double check valve: included • slide bar: not to be used as a grab bar • drop ell: sold separately • use secure mount anchor to meet hand grip requirements 	1.75 GPM (6.65 L/min) max.				
	3887EP	366.35	Chrome	6	
	3887EPBN	727.95	Brushed Nickel	6	
	3887EPBG	727.95	Brushed Gold	6	
	3887EPBL	771.40	Matte Black	6	
	DROP ELLS SOLD SEPARATELY				
	A725	67.40	Chrome	12	
	A725BN	95.45	Brushed Nickel	12	
	A725BG	100.85	Brushed Gold	12	
	A725WR	104.95	Wrought Iron	12	
SECUREMOUNT™ ANCHORS SOLD SEPARATELY					
A750	42.50	N/A or Unfinished	24		
 <ul style="list-style-type: none"> • soft square handshower: single-function • showerhead size: 1-1/8" diameter • type of function: full spray • hose length: 69" • double check valve: included • slide bar: not to be used as a grab bar • drop ell: sold separately • use secure mount anchor to meet hand grip requirements 	1.75 GPM (6.65 L/min) max.				
	3988EP	333.05	Chrome	6	
	3988EPSRN	661.75	Spot Resist Brushed Nickel	6	
	3988EPBN	661.75	Brushed Nickel	6	
	DROP ELLS SOLD SEPARATELY				
	A721	86.25	Chrome	12	
	A721SRN	121.65	Spot Resist Brushed Nickel	12	
	A721BN	121.65	Brushed Nickel	12	
	SECUREMOUNT™ ANCHORS SOLD SEPARATELY				
	A750	42.50	N/A or Unfinished	24	
 <ul style="list-style-type: none"> • handshower: three-function eco-performance • showerhead size: 4" diameter • type of function: full spray; concentrated rinse; combination • slide bar length: 30" • hose length: 69" • double check valve: included • slide bar: not to be used as a grab bar • drop ell: sold separately • securemount anchor to meet hand grip requirements 	1.75 GPM (6.65 L/min) max.				
	3863EP	327.00	Chrome	6	
	3863EPBN	683.00	Brushed Nickel	6	
	DROP ELLS SOLD SEPARATELY				
	A725	67.40	Chrome	12	
	A725BN	95.45	Brushed Nickel	12	
	SECUREMOUNT™ ANCHORS SOLD SEPARATELY				
	A750	42.50	N/A or Unfinished	24	
	 <ul style="list-style-type: none"> • handshower: single-function eco-performance • showerhead size: 4-1/4" diameter • type of function: full spray • slide bar length: 24" • hose length: 59" • double check valve: included • slide bar: not to be used as a grab bar • drop ell: sold separately • use secure mount anchor to meet hand grip requirements 	1.75 GPM (6.65 L/min) max.			
		3668EP	300.20	Chrome	6
3668EPBN		434.45	Brushed Nickel	6	
3668EPORB		477.45	Oil Rubbed Bronze	6	
DROP ELLS SOLD SEPARATELY					
A725		67.40	Chrome	12	
A725BN		95.45	Brushed Nickel	12	
A725ORB		104.95	Oil Rubbed Bronze	12	
SECUREMOUNT™ ANCHORS SOLD SEPARATELY					
A750		42.50	N/A or Unfinished	24	
 <ul style="list-style-type: none"> • showerhead: single-function eco-performance • showerhead size: 4" diameter • type of function: full spray • slide bar length: 24" • hose length: 59" • double check valve: included • slide bar: not to be used as a grab bar • drop ell: sold separately • use secure mount anchor: to meet hand grip requirements 	1.75 GPM (6.65 L/min) max.				
	3868EP	300.20	Chrome	6	
	3868EPBN	434.45	Brushed Nickel	6	
	3868EPBG	434.45	Brushed Gold	6	
	3868EPORB	477.45	Oil Rubbed Bronze	6	
	DROP ELLS SOLD SEPARATELY				
	A725	67.40	Chrome	12	
	A725BN	95.45	Brushed Nickel	12	
	A725BG	100.85	Brushed Gold	12	
	A725ORB	104.95	Oil Rubbed Bronze	12	
SECUREMOUNT™ ANCHORS SOLD SEPARATELY					
A750	42.50	N/A or Unfinished	24		

Handheld Showers









		MODEL	LIST	FINISH/CONNECT	CASE QTY	
HANDHELD WITH SLIDEBAR						
	<ul style="list-style-type: none"> • handshower: five-function eco-performance • showerhead size: 4-3/8" diameter • type of function: full spray; downpour; relaxing massage; massage; rinse • slide bar length: 30" • hose length: 69" • double check valve: included • slide bar: not to be used as a grab bar • drop ell: sold separately • use secure mount anchor to meet hand grip requirements 	1.75 GPM (6.65 L/min) max.				
		3558EP	282.25	Chrome	6	
		3558EPBN	381.00	Brushed Nickel	6	
		3558EPBL	419.10	Matte Black	6	
		3558EPORB	419.10	Oil Rubbed Bronze	6	
		DROP ELLS SOLD SEPARATELY				
		A725	67.40	Chrome	12	
		A725BN	95.45	Brushed Nickel	12	
		A725WR	104.95	Wrought Iron	12	
		A725ORB	104.95	Oil Rubbed Bronze	12	
SECUREMOUNT™ ANCHORS SOLD SEPARATELY						
A750	42.50	N/A or Unfinished	24			
HANDHELD WITH WALL BRACKET						
	<ul style="list-style-type: none"> • handshower: single-function eco-performance • showerhead size: 1-1/8" diameter • type of function: full spray • hose length: 69" • wall bracket: included • double check valve: included • drop ell: sold separately 	1.75 GPM (6.65 L/min) max.				
		S11705EP	359.45	Chrome	6	
		S11705EPBN	520.95	Brushed Nickel	6	
		DROP ELLS SOLD SEPARATELY				
		A725	67.40	Chrome	12	
A725BN	95.45	Brushed Nickel	12			
HANDHELD WITH WALL BRACKET						
	<ul style="list-style-type: none"> • handshower: four-function eco-performance • showerhead size: 4-3/8" diameter • type of function: full spray; invigorating spray; combination; targeted massage • hose length: 69" • double check valve: included • drop ell: sold separately 	1.75 GPM (6.65 L/min) max.				
		3636EP	346.90	Chrome	6	
		3636EPBN	660.10	Brushed Nickel	6	
		3636EPBG	660.10	Brushed Gold	6	
		3636EPBL	726.15	Matte Black	6	
		3636EPORB	726.15	Oil Rubbed Bronze	6	
		DROP ELLS SOLD SEPARATELY				
		A725	67.40	Chrome	12	
		A725BN	95.45	Brushed Nickel	12	
		A725BG	100.85	Brushed Gold	12	
A725WR	104.95	Wrought Iron	12			
A725ORB	104.95	Oil Rubbed Bronze	12			
	<ul style="list-style-type: none"> • handshower: single-function eco-performance • showerhead size: 4" diameter • type of function: full spray • hose length: 59" • wall bracket: included • double check valve: included • drop ell: sold separately 	1.75 GPM (6.65 L/min) max.				
		3865EP	249.55	Chrome	6	
		3865EPBN	362.30	Brushed Nickel	6	
		3865EPORB	398.75	Oil Rubbed Bronze	6	
		DROP ELLS SOLD SEPARATELY				
		A725	67.40	Chrome	12	
		A725BN	95.45	Brushed Nickel	12	
A725ORB	104.95	Oil Rubbed Bronze	12			

		MODEL	LIST	FINISH/CONNECT	CASE QTY	
MAGNETIX® VERSO COMBINATION SHOWER						
 <p>NEW!</p> <ul style="list-style-type: none"> • Infiniti™ dial allows user to precisely adjust to preferred balance of force and coverage • three-way diverter provides ability to flow each shower head separately or combined for more coverage • pivoting rainshower tilts 20 degrees forward and 20 degrees backwards • includes: Magnetix® docking system • connection: 1/2" IPS • showerhead size: 7" diameter • includes: 72" metal hose <p></p>	<ul style="list-style-type: none"> • 2.5 GPM (9.5 L/min) max. 	220C5	280.90	Chrome	2	
			220C5BN	365.15	Brushed Nickel	2
			220C5BG	401.70	Brushed Gold	2
			220C5BL	365.15	Matte Black	2
		<ul style="list-style-type: none"> • 1.75 GPM (6.65 L/min) max. 	220C5EP	280.90	Chrome	2
			220C5EPBN	365.15	Brushed Nickel	2
			220C5EPBG	401.70	Brushed Gold	2
			220C5EPBL	365.15	Matte Black	2
	 <p>NEW!</p> <ul style="list-style-type: none"> • Infiniti™ dial allows user to precisely adjust to preferred balance of force and coverage • three-way diverter provides ability to flow each shower head separately or combined for more coverage • pivoting rainshower tilts 20 degrees forward and 20 degrees backwards • includes: Magnetix® docking system • connection: 1/2" IPS • showerhead size: 7" diameter • includes: 72" metal hose <p></p>	<ul style="list-style-type: none"> • 2.5 GPM (9.5 L/min) max. 	220C3	280.90	Chrome	2
				220C3BN	365.15	Brushed Nickel
			220C3BG	401.70	Brushed Gold	2
			220C3BL	365.15	Matte Black	2
		<ul style="list-style-type: none"> • 1.75 GPM (6.65 L/min) max. 	220C3EP	280.90	Chrome	2
			220C3EPBN	365.15	Brushed Nickel	2
			220C3EPBG	401.70	Brushed Gold	2
			220C3EPBL	365.15	Matte Black	2
MAGNETIX® HANDHELDS						
 <ul style="list-style-type: none"> • handshower: six-function eco-performance • showerhead size: 5-1/2" diameter • type of function: wide coverage; downpour; relaxing massage; massage; invigorating spray; rinse • hose length: 59" • double check valve: included • includes: Magnetix® docking system 		<ul style="list-style-type: none"> • 1.75 GPM (6.65 L/min) max. 	3662EP	228.85	Chrome	6
			3662EPBN	310.25	Brushed Nickel	6
			3662EPBG	310.25	Brushed Gold	6
			3662EPBL	378.35	Matte Black	6
			3662EPORB	390.35	Oil Rubbed Bronze	6
 <ul style="list-style-type: none"> • handshower: six-function eco-performance • showerhead size: 3-1/2" diameter • type of function: wide coverage; downpour; relaxing massage; massage; soothing massage; rinse • hose length: 60" • includes: Magnetix® docking system • double check valve: included • arm and flange: sold separately 	<ul style="list-style-type: none"> • 1.75 GPM (6.65 L/min) max. 	26100EP	69.80	Chrome	2	
			26100EPSRN	85.35	Spot Resist Brushed Nickel	2
			26100EPBL	91.95	Matte Black	2
 <p>NEW!</p> <ul style="list-style-type: none"> • Infiniti Dial offers limitless spray pressure and coverage options and allows you to seamlessly switch between spray modes with no pause in experience • includes four pre-set spray settings –silk, massage, downpour and wide coverage –for additional choices • features Magnetix technology: includes a powerful magnetic dock that allows for easy release of handshower and a securely snap back into place—even when eyes are closed • spray can be paused to a trickle • diameter: 5" spray face diameter • includes 72" metal hose • connection: 1/2" IPS 	<ul style="list-style-type: none"> • 2.5 GPM (9.5 L/min) max. 	220H5	250.50	Chrome	6	
			220H5BN	324.65	Brushed Nickel	6
			220H5BG	361.90	Brushed Gold	6
			220H5BL	318.30	Matte Black	6
		<ul style="list-style-type: none"> • 1.75 GPM (6.65 L/min) max. 	220H5EP	250.50	Chrome	6
			220H5EPBN	324.65	Brushed Nickel	6
			220H5EPBG	369.15	Brushed Gold	6
			220H5EPBL	324.65	Matte Black	6
	 <ul style="list-style-type: none"> • handshower: six-function eco-performance • showerhead size: 5-1/2" diameter • type of function: wide coverage; downpour; relaxing massage; massage; soothing massage; rinse • double check valve: included • includes: Magnetix® docking system • handshower only • magnetic dock and hose sold separately 	<ul style="list-style-type: none"> • 1.75 GPM (6.65 L/min) max. 	187054	164.60	Chrome	6
				187054BN	205.15	Brushed Nickel
			187054BG	196.90	Brushed Gold	6
			187054BL	227.35	Matte Black	6
			187054ORB	227.35	Oil Rubbed Bronze	6
MAGNETIX® HANDHELD DOCKS						
 <ul style="list-style-type: none"> • includes: Magnetix® docking system • compatible with the following Magnetix SKUs only: 3662EP, 187054, 26100EP and 220H5 • includes two installation options: permanent waterproof adhesive or wall bracket with screws 		186117	25.75	Chrome	6	
			186117SRN	31.30	Spot Resist Brushed Nickel	6
			186117BN	39.45	Brushed Nickel	6
			186117BL	41.55	Matte Black	6
			186117ORB	43.45	Oil Rubbed Bronze	6

Handheld Showers

		MODEL	LIST	FINISH/CONNECT	CASE QTY
HANDHELD					
	<ul style="list-style-type: none"> • handshower: single-function eco-performance • showerhead size: 3-3/8" diameter • type of function: full spray • double check valve: included 	1.75 GPM (6.65 L/min) max.			
		154305	182.55	Chrome	6
		154305BN	264.70	Brushed Nickel	6
		154305NL	281.05	Polished Nickel	6
		154305BG	250.50	Brushed Gold	6
		154305BL	281.05	Matte Black	6
		154305ORB	281.05	Oil Rubbed Bronze	6
	<ul style="list-style-type: none"> • handshower: three-function eco-performance • showerhead size: 4" diameter • type of function: full spray; concentrated rinse; combination • double check valve: included 	1.75 GPM (6.65 L/min) max.			
		147913	179.10	Chrome	6
		147913BN	265.20	Brushed Nickel	6
	<ul style="list-style-type: none"> • handshower: four-function eco-performance • showerhead size: 3-3/4" diameter • type of function: full spray; invigorating spray; combination; targeted massage • double check valve: included 	1.75 GPM (6.65 L/min) max.			
		160042	130.20	Chrome	6
		160042BN	188.95	Brushed Nickel	6
		160042ORB	207.85	Oil Rubbed Bronze	6
	<ul style="list-style-type: none"> • handshower: single-function eco-performance • showerhead size: 3" diameter • type of function: full spray • double check valve: included 	1.75 GPM (6.65 L/min) max.			
		176257	122.50	Chrome	6
		176257BN	179.60	Brushed Nickel	6
	<ul style="list-style-type: none"> • handshower: single-function square • showerhead size: 1" diameter • type of function: full spray • double check valve: included • metal construction 	1.75 GPM (6.65 L/min) max.			
		189575	115.85	Chrome	6
		189575BN	170.00	Brushed Nickel	6
		189575NL	170.00	Polished Nickel	6
		189575BL	187.05	Matte Black	6
		189575BG	170.00	Brushed Gold	6
	<ul style="list-style-type: none"> • handshower: five-function eco-performance • showerhead size: 4-1/2" diameter • type of function: pause; wide coverage; downpour; massage; rinse; full spray • double check valve: included • valve: sold separately 	1.75 GPM (6.65 L/min) max.			
		198020	111.25	Chrome	6
		198020BN	161.25	Brushed Nickel	6
		198020BL	177.45	Matte Black	6
	<ul style="list-style-type: none"> • handshower: five-function eco-performance • showerhead size: 4-1/2" diameter • type of function: pause; wide coverage; downpour; massage; rinse; full spray • double check valve: included • valve: sold separately 	1.75 GPM (6.65 L/min) max.			
		198021	111.25	Chrome	6
		198021BN	161.25	Brushed Nickel	6
		198021BL	177.45	Matte Black	6
	<ul style="list-style-type: none"> • handshower: four-function eco-performance • showerhead size: 4" diameter • type of function: full spray; invigorating spray; combination; targeted massage • double check valve: included 	1.75 GPM (6.65 L/min) max.			
		164928	101.10	Chrome	6
		164928BN	146.50	Brushed Nickel	6
		164928BL	161.20	Matte Black	6
		164928ORB	161.20	Oil Rubbed Bronze	6
	<ul style="list-style-type: none"> • handshower: four-function eco-performance • showerhead size: 4" diameter • type of function: full spray; invigorating spray; combination; targeted massage • double check valve: included • carded packaging: yes 	1.75 GPM (6.65 L/min) max.			
		CL164928	95.70	Chrome	6
		CL164928BN	138.75	Brushed Nickel	6
	<ul style="list-style-type: none"> • handshower: four-function eco-performance • showerhead size: 4-3/8" diameter • type of function: full spray; invigorating spray; combination; targeted massage • double check valve: included 	1.75 GPM (6.65 L/min) max.			
		164927	98.65	Chrome	6
		164927BN	142.90	Brushed Nickel	6
		164927NL	135.15	Polished Nickel	6
		164927BG	120.35	Brushed Gold	6
		164927BL	144.60	Matte Black	6
		164927ORB	161.20	Oil Rubbed Bronze	6

Handheld Showers





		MODEL	LIST	FINISH/CONNECT	CASE QTY
	<ul style="list-style-type: none"> • handshower: single-function eco-performance • showerhead size: 1" diameter • type of function: full spray • double check valve: included 	1.75 GPM (6.65 L/min) max.			
		195957	75.70	Chrome	6
		195957BN	109.80	Brushed Nickel	6
		195957NL	109.80	Polished Nickel	6
		195957ORB	120.90	Oil Rubbed Bronze	6
	<ul style="list-style-type: none"> • handshower: single-function eco-performance • showerhead size: 1" diameter • type of function: full spray • double check valve: included 	1.75 GPM (6.65 L/min) max.			
		195958	80.10	Chrome	6
		195958BN	116.20	Brushed Nickel	6
		195958NL	116.20	Polished Nickel	6
		195958ORB	127.55	Oil Rubbed Bronze	6
	<ul style="list-style-type: none"> • handshower: single-function eco-performance • showerhead size: 4" diameter • type of function: full spray • double check valve: included 	1.75 GPM (6.65 L/min) max.			
		155747	84.65	Chrome	6
		155747BN	122.80	Brushed Nickel	6
		155747NL	156.80	Polished Nickel	6
		155747BG	111.30	Brushed Gold	6
		155747ORB	135.15	Oil Rubbed Bronze	6
	<ul style="list-style-type: none"> • handshower: single-function eco-performance round • showerhead size: 1-1/8" diameter • type of function: full spray • double check valve: included 	1.75 GPM (6.65 L/min) max.			
		155891	84.65	Chrome	24
		155891BN	117.65	Brushed Nickel	24
		155891BG	117.65	Brushed Gold	6
		155891BL	135.15	Matte Black	24
	<ul style="list-style-type: none"> • handshower: single-function eco-performance • showerhead size: 4" diameter • type of function: full spray • double check valve: included 	1.5 GPM (5.7 L/min) max.			
		157276EP15	84.65	Chrome	6
	<ul style="list-style-type: none"> • handshower: single-function eco-performance • showerhead size: 4" diameter • type of function: full spray • double check valve: included 	1.75 GPM (6.65 L/min) max.			
		164929	84.65	Chrome	6
		164929BN	122.80	Brushed Nickel	6
		164929NL	122.50	Polished Nickel	6
		164929ORB	135.15	Oil Rubbed Bronze	6
	<ul style="list-style-type: none"> • handshower: single-function eco-performance • showerhead size: 4" diameter • type of function: full spray • double check valve: included • carded packaging: yes 	1.75 GPM (6.65 L/min) max.			
		CL155747	80.10	Chrome	6
		CL155747BN	116.20	Brushed Nickel	6
	<ul style="list-style-type: none"> • handshower: single-function eco-performance soft square • showerhead size: 1-1/8" diameter • type of function: full spray • double check valve: included 	1.75 GPM (6.65 L/min) max.			
		189318	80.10	Chrome	6
		189318SRN	116.20	Spot Resist Brushed Nickel	6
		189318BN	116.20	Brushed Nickel	6
		189318BRB	127.95	Mediterranean Bronze	6
		189318ORB	127.95	Oil Rubbed Bronze	6
	<ul style="list-style-type: none"> • handshower: five-function eco-performance • showerhead size: 4-3/8" diameter • type of function: full spray; downpour; relaxing massage; massage; rinse • double check valve: included 	1.75 GPM (6.65 L/min) max.			
		189315	71.95	Chrome	6
		189315BN	97.15	Brushed Nickel	6
		189315BL	106.95	Matte Black	6
		189315ORB	106.95	Oil Rubbed Bronze	6

CUSTOM SHOWERING

Body Sprays





		MODEL	LIST	FINISH/CONNECT	CASE QTY
PIVOTING BODY SPRAYS - PREMIUM					
	<ul style="list-style-type: none"> • spray functions: two-function • showerhead type: standard • showerhead size: 3-1/4" diameter • type of function: full spray, target massage • 1" extension kit available: 155656 • valve: sold separately 	2.0 GPM (7.6 L/min) max.			
		TS1420	308.10	Chrome	6
		TS1420BN	417.50	Brushed Nickel	6
		TS1420NL	417.50	Polished Nickel	6
		TS1420ORB	459.35	Oil Rubbed Bronze	6
					
	<ul style="list-style-type: none"> • spray functions: two-function • showerhead type: standard • showerhead size: 3-1/4" diameter • type of function: full spray, target massage • 1" extension kit available: 155656 • valve: sold separately 	2.0 GPM (7.6 L/min) max.			
		TS1422	308.10	Chrome	6
		TS1422BN	417.50	Brushed Nickel	6
		TS1422NL	417.50	Polished Nickel	6
		TS1422BG	417.50	Brushed Gold	6
		TS1422BL	459.35	Matte Black	6
TS1422ORB	459.35	Oil Rubbed Bronze	6		
					
	<ul style="list-style-type: none"> • spray functions: one-function • showerhead type: standard • showerhead size: 3-1/4" diameter • 1" extension kit available: 155656 • valve: sold separately 	2.0 GPM (7.6 L/min) max.			
		TS1320	199.05	Chrome	6
		TS1320BN	280.65	Brushed Nickel	6
		TS1320NL	280.65	Polished Nickel	6
		TS1320ORB	316.80	Oil Rubbed Bronze	6
					
	<ul style="list-style-type: none"> • spray functions: one-function • showerhead type: standard • showerhead size: 3-1/4" diameter • 1" extension kit available: 155656 • valve: sold separately 	2.0 GPM (7.6 L/min) max.			
		TS1322	199.05	Chrome	6
		TS1322BN	280.65	Brushed Nickel	6
		TS1322NL	280.65	Polished Nickel	6
		TS1322BG	280.65	Brushed Gold	6
		TS1322BL	316.80	Matte Black	6
TS1322ORB	316.80	Oil Rubbed Bronze	6		
					
FLUSHMOUNT BODY SPRAY VALVE - PREMIUM					
	<ul style="list-style-type: none"> • description: flushmount body spray valve • installation: fits standard 2x4 wall 	S1300	126.50	N/A or Unfinished	6
					
BODY SPRAYS					
	<ul style="list-style-type: none"> • connection: 1/2" IPS • spray functions: one-function • showerhead size: 2" diameter 	1.75 GPM (6.65 L/min) max.			
		A501	125.15	Chrome	12
		A501BN	156.50	Brushed Nickel	12
		A501NL	156.50	Polished Nickel	12
		A501WR	172.15	Wrought Iron	12
		A501ORB	172.15	Oil Rubbed Bronze	12
					





Slidebars

SLIDEBAR	MODEL	LIST	FINISH/CONNECT	CASE QTY	
 <ul style="list-style-type: none"> length: 30" slide bar: not to be used as a grab bar use SecureMount® anchors to meet handgrip requirement 	154296	371.80	Chrome	6	
	154296BN	408.80	Brushed Nickel	6	
	154296NL	449.70	Polished Nickel	6	
	154296BG	387.00	Brushed Gold	6	
	154296BL	449.70	Matte Black	6	
	154296ORB	449.70	Oil Rubbed Bronze	6	
	SECUREMOUNT™ ANCHORS SOLD SEPARATELY				
A750	42.50	N/A or Unfinished	24		
 <ul style="list-style-type: none"> length: 24" slide bar: not to be used as a grab bar use SecureMount® anchors to meet handgrip requirement 	155746	264.00	Chrome	6	
	155746BN	382.65	Brushed Nickel	6	
	155746BG	364.40	Brushed Gold	6	
	155746ORB	420.95	Oil Rubbed Bronze	6	
	SECUREMOUNT™ ANCHORS SOLD SEPARATELY				
	A750	42.50	N/A or Unfinished	24	
	 <ul style="list-style-type: none"> length: 30" slide bar: not to be used as a grab bar use SecureMount® anchors to meet handgrip requirement 	A742	230.15	Chrome	6
A742BN		333.90	Brushed Nickel	6	
A742NL		315.80	Polished Nickel	6	
A742BG		295.90	Brushed Gold	6	
A742BRB		367.30	Mediterranean Bronze	6	
A742BL		367.30	Matte Black	6	
A742ORB		367.30	Oil Rubbed Bronze	6	
SECUREMOUNT™ ANCHORS SOLD SEPARATELY					
A750	42.50	N/A or Unfinished	24		
 <ul style="list-style-type: none"> length: 30" slide bar: not to be used as a grab bar use SecureMount® anchors to meet handgrip requirement 	A735	212.85	Chrome	6	
	A735BN	308.65	Brushed Nickel	6	
	A735NL	302.80	Polished Nickel	6	
	A735BG	276.25	Brushed Gold	6	
	A735WR	327.55	Wrought Iron	6	
	A735ORB	327.55	Oil Rubbed Bronze	6	
	SECUREMOUNT™ ANCHORS SOLD SEPARATELY				
A750	42.50	N/A or Unfinished	24		
 <ul style="list-style-type: none"> length: 30" slide bar: not to be used as a grab bar use SecureMount® anchors to meet handgrip requirement 	198017	101.05	Chrome	6	
	198017BN	146.45	Brushed Nickel	6	
	198017BL	155.55	Matte Black	6	
	SECUREMOUNT™ ANCHORS SOLD SEPARATELY				
	A750	42.50	N/A or Unfinished	24	

CUSTOM SHOWERING

Shower Hoses

		MODEL	LIST	FINISH/CONNECT	CASE QTY
HANDHELD SHOWER HOSE					
	<ul style="list-style-type: none"> • connection: 1/2" IPS • hose length: 59" • metal construction: yes • use brown (BR) for oil rubbed bronze (ORB) and mediterranean bronze (BRB) 	155748	50.60	Chrome	8
		155748BN	73.35	Brushed Nickel	8
		155748NL	49.60	Polished Nickel	8
		155748BG	49.60	Brushed Gold	8
		155748BR	108.10	Brown	8
		155748BL	108.10	Matte Black	8
	<ul style="list-style-type: none"> • connection: 1/2" IPS • hose length: 59" • metal construction: yes 	CL155748	47.85	Chrome	12
		CL155748BN	69.40	Brushed Nickel	12
	<ul style="list-style-type: none"> • connection: 1/2" IPS • hose length: 69" • metal construction: yes • use brown (BR) for oil rubbed bronze (ORB) and mediterranean bronze (BRB) • use satine (ST) for brushed nickel (BN) 	A726	136.95	Chrome	12
		A726SRN	244.60	Spot Resist Brushed Nickel	12
		A726NL	244.60	Polished Nickel	24
		A726BG	244.60	Brushed Gold	12
		A726BR	253.45	Brown	12
		A726WR	156.00	Wrought Iron	6
	<ul style="list-style-type: none"> • connection: 1/2" IPS • hose length: 72" • metal construction: yes 	210007	60.85	Chrome	12
		210007SRN	84.70	Spot Resist Brushed Nickel	12
		210007BN	84.70	Brushed Nickel	12
		210007BG	124.90	Brushed Gold	12
		210007BL	124.90	Matte Black	12
		210007ORB	124.90	Oil Rubbed Bronze	12
	<ul style="list-style-type: none"> • connection: 1/2" IPS • hose length: 80" • metal construction: yes 	A780	161.50	Chrome	20

		MODEL	LIST	FINISH/CONNECT	CASE QTY
TWIN ELL					
	<ul style="list-style-type: none"> • connection size: 1/2" x 1/2" x 3/4" • connection type: IPS • description: twin ell • usage: with tub/shower installations where needed 	128284	37.00	N/A or Unfinished	12
DROP ELL					
	<ul style="list-style-type: none"> • connection: 1/2" IPS • integral handshower cradle: included 	A755	172.40	Chrome	12
		A755BN	250.05	Brushed Nickel	12
		A755BG	250.05	Brushed Gold	12
		A755BL	275.10	Matte Black	12
		A755ORB	275.10	Oil Rubbed Bronze	12
	<ul style="list-style-type: none"> • description: drop ell • connection: 1/2" IPS 	A721	86.25	Chrome	12
		A721SRN	121.65	Spot Resist Brushed Nickel	12
		A721BN	121.65	Brushed Nickel	12
		A721NL	121.65	Polished Nickel	12
		A721BG	121.65	Brushed Gold	12
		A721BL	133.75	Matte Black	12
	<ul style="list-style-type: none"> • description: drop ell • connection: 1/2" IPS 	A721ORB	133.75	Oil Rubbed Bronze	12
		A725	67.40	Chrome	12
		A725BN	95.45	Brushed Nickel	12
		A725NL	95.45	Polished Nickel	12
		A725BG	100.85	Brushed Gold	12
		A725ORB	104.95	Oil Rubbed Bronze	12
		A725WR	104.95	Wrought Iron	12
SECUREMOUNT™ FOR GRAB BARS AND SLIDEBARS					
	<ul style="list-style-type: none"> • description: SecureMount® anchors • use SecureMount® anchors to meet handgrip requirement 	A750	42.50	N/A or Unfinished	24

Showering Accessories

		MODEL	LIST	FINISH/CONNECT	CASE QTY
WALL BRACKET					
	<ul style="list-style-type: none"> • integral handshower cradle: included • metal construction: yes 	114348	117.65	Chrome	12
		114348BN	170.60	Brushed Nickel	12
		114348NL	136.85	Polished Nickel	12
		114348BG	170.60	Brushed Gold	12
		114348WR	187.55	Wrought Iron	12
		114348ORB	187.55	Oil Rubbed Bronze	12
	<ul style="list-style-type: none"> • integral handshower cradle: included 	155694	32.70	Chrome	12
		155694BN	47.30	Brushed Nickel	12
		155694BG	47.30	Brushed Gold	12
		155694BL	52.00	Matte Black	12
		155694ORB	52.00	Oil Rubbed Bronze	12
	<ul style="list-style-type: none"> • integral handshower cradle: included 	CL155694	30.95	Chrome	12
		CL155694BN	44.75	Brushed Nickel	12
VACUUM BREAKER					
	<ul style="list-style-type: none"> • connection: 1/2" IPS 	A714	57.25	Chrome	24
		A714ORB	91.30	Oil Rubbed Bronze	12
		A714WR	91.30	Wrought Iron	12
SHOWER ARM DIVERTER					
	<ul style="list-style-type: none"> • connection: 1/2" IPS • type of function: two independent 1 shared • integral handshower cradle: included • metal construction • carded packaging: yes 	CL707	145.35	Chrome	12
		CL707BN	210.70	Brushed Nickel	12
		CL707BL	231.80	Matte Black	12
		CL707ORB	231.80	Oil Rubbed Bronze	12
	<ul style="list-style-type: none"> • connection: 1/2" IPS • type of function: two independent 1 shared • metal construction • carded packaging: yes 	CL703	107.05	Chrome	12
		CL703BN	155.15	Brushed Nickel	12
		CL703BL	170.75	Matte Black	12
		CL703ORB	170.75	Oil Rubbed Bronze	12
	<ul style="list-style-type: none"> • connection: 1/2" IPS • type of function: two discrete • metal construction 	A720	96.20	Chrome	12
		A720BN	130.70	Brushed Nickel	12
		A720BL	143.75	Matte Black	12
		A720ORB	143.75	Oil Rubbed Bronze	12
SHOWER ARM CRADLE					
	<ul style="list-style-type: none"> • connection: 1/2" IPS • integral handshower cradle: included • metal construction: yes 	A701	62.85	Chrome	12
		A701BN	90.90	Brushed Nickel	12
		A701BG	90.90	Brushed Gold	12
		A701BL	100.00	Matte Black	12
		A701ORB	100.00	Oil Rubbed Bronze	12
	<ul style="list-style-type: none"> • connection: 1/2" IPS • integral handshower cradle: included • metal construction: yes 	CLA701	62.85	Chrome	12
		CLA701BN	90.90	Brushed Nickel	12







Diverter Tub Spouts

		MODEL	LIST	FINISH/CONNECT	CASE QTY
DIVERGING TUB SPOUT - PREMIUM					
	<ul style="list-style-type: none"> • matches Weymouth® collection • connection: 1/2" slip fit • tub spout length: 6-3/4" • tub spout type: diverter 	S12104	223.70	Chrome	6
		S12104BN	354.30	Brushed Nickel	6
		S12104NL	357.85	Polished Nickel	6
		S12104BG	354.30	Brushed Gold	6
		S12104BL	389.75	Matte Black	6
		S12104ORB	389.75	Oil Rubbed Bronze	6
	<ul style="list-style-type: none"> • matches Flara™ collection • connection: 1/2" slip fit • tub spout length: 8-1/8" • tub spout type: diverter 	S989	285.30	Chrome	6
		S989BN	428.00	Brushed Nickel	6
		S989NL	428.00	Polished Nickel	6
		S989BG	428.00	Brushed Gold	6
	<ul style="list-style-type: none"> • matches Colinet™ collection • connection: 1/2" slip fit • tub spout length: 9" • tub spout type: diverter 	S5000	266.75	Chrome	6
		S5000BN	400.05	Brushed Nickel	6
		S5000BG	400.05	Brushed Gold	6
		S5000BL	440.00	Matte Black	6
	<ul style="list-style-type: none"> • matches 90 Degree™ collection • connection: 1/2" slip fit • tub spout length: 7-1/4" • tub spout type: diverter 	S3896	141.15	Chrome	6
		S3896BN	204.70	Brushed Nickel	6
		S3896BL	206.60	Matte Black	6
	<ul style="list-style-type: none"> • matches 90 Degree™ collection • connection: 1/2" IPS • tub spout length: 7-1/4" • tub spout type: diverter 	S3894	147.50	Chrome	6
	<ul style="list-style-type: none"> • matches Doux™ collection • connection: 1/2" slip fit • tub spout length: 7-3/4" • tub spout type: diverter 	S3835	172.55	Chrome	6
		S3835BN	250.15	Brushed Nickel	6
		S3835BL	275.25	Matte Black	6
DIVERGING TUB SPOUT					
	<ul style="list-style-type: none"> • matches Greenfield™ collection • connection: 1/2" slip fit • tub spout length: 7-3/8" • tub spout type: diverter 	4325	98.95	Chrome	6
		4325BN	156.75	Brushed Nickel	6
		4325BG	150.30	Brushed Gold	6
		4325BL	176.30	Matte Black	6
	<ul style="list-style-type: none"> • matches Cia™ collection • connection: 1/2" slip fit • tub spout length: 7-1/4" • tub spout type: diverter 	3346	91.70	Chrome	6
		3346BN	145.30	Brushed Nickel	6
		3346BG	145.30	Brushed Gold	6
		3346BL	169.15	Matte Black	6
	<ul style="list-style-type: none"> • matches Arris® collection • connection: 1/2" slip fit • tub spout length: 7-1/8" • tub spout type: diverter 	165914	196.85	Chrome	6
		165914BN	333.75	Brushed Nickel	6
		165914BL	367.15	Matte Black	6
	<ul style="list-style-type: none"> • matches Belfield® collection • connection: 1/2" slip fit • tub spout length: 7-3/4" • tub spout type: diverter 	185820	121.85	Chrome	6
		185820BN	145.40	Brushed Nickel	6
		185820NL	145.40	Polished Nickel	6
		185820BL	152.30	Matte Black	6
		185820ORB	154.80	Oil Rubbed Bronze	6

CUSTOM SHOWERING

Diverter Tub Spouts

		MODEL	LIST	FINISH/CONNECT	CASE QTY
	<ul style="list-style-type: none"> • matches Glyde™ collection • connection: 1/2" slip fit • tub spout length: 6" • tub spout type: diverter 	179791	124.20	Chrome	6
		179791BN	158.00	Brushed Nickel	6
		179791BL	173.80	Matte Black	6
	<ul style="list-style-type: none"> • matches Brantford® collection • connection: 1/2" IPS • tub spout length: 7-1/4" • tub spout type: diverter 	3814	107.05	Chrome	6
		3814BN	155.35	Brushed Nickel	6
		3814ORB	170.95	Oil Rubbed Bronze	6
	<ul style="list-style-type: none"> • matches Brantford® collection • connection: 1/2" slip fit • tub spout length: 7-1/4" • tub spout type: diverter 	3857	105.10	Chrome	6
		3857BN	152.55	Brushed Nickel	6
		3857ORB	167.80	Oil Rubbed Bronze	6
	<ul style="list-style-type: none"> • connection: 1/2" IPS • tub spout length: 5" • tub spout type: diverter 	3806	108.00	Chrome	12
	<ul style="list-style-type: none"> • matches Dartmoor® collection • connection: 1/2" slip fit • tub spout length: 7-3/8" • tub spout type: diverter 	3737	104.35	Chrome	6
		3737BN	151.45	Brushed Nickel	6
		3737BL	166.60	Matte Black	6
		3737ORB	166.60	Oil Rubbed Bronze	6
	<ul style="list-style-type: none"> • matches Voss™ collection • connection: 1/2" slip fit • tub spout length: 7-3/4" • tub spout type: diverter 	161955	103.45	Chrome	6
		161955BN	160.30	Brushed Nickel	6
		161955NL	160.30	Polished Nickel	6
		161955BG	160.30	Brushed Gold	6
		161955BL	165.60	Matte Black	6
161955ORB	176.35	Oil Rubbed Bronze	6		
	<ul style="list-style-type: none"> • matches Wynford® collection • connection: 1/2" slip fit • tub spout length: 8" • tub spout type: diverter 	175385	102.75	Chrome	6
		175385BN	159.55	Brushed Nickel	6
		175385NL	159.55	Polished Nickel	6
		175385ORB	175.40	Oil Rubbed Bronze	6
	<ul style="list-style-type: none"> • matches Align® collection • connection: 1/2" slip fit • tub spout length: 7-1/8" • tub spout type: diverter 	172656	98.00	Chrome	6
		172656BN	155.35	Brushed Nickel	6
		172656BG	148.85	Brushed Gold	6
		172656BL	176.30	Matte Black	6
	<ul style="list-style-type: none"> • matches Align® collection • connection: 1/2" IPS • tub spout length: 7-1/8" • tub spout type: diverter 	172657	98.00	Chrome	6
		172657BN	155.35	Brushed Nickel	6
		172657BG	132.15	Brushed Gold	6
		172657BL	192.25	Matte Black	6
	<ul style="list-style-type: none"> • matches Gibson™ collection • connection: 1/2" CC • tub spout length: 6-1/2" • tub spout type: diverter 	3890	99.10	Chrome	12
		3890BN	143.85	Brushed Nickel	12
		3890BL	151.35	Matte Black	12

DIVERTING TUB SPOUT		MODEL	LIST	FINISH/CONNECT	CASE QTY
	<ul style="list-style-type: none"> • connection: 1/2" IPS • tub spout length: 5-1/2" • tub spout type: diverter 	3800	86.60	Chrome	12
	<ul style="list-style-type: none"> • connection: 1/2" slip fit • tub spout length: 5-1/2" • tub spout type: diverter 	3801	86.60	Chrome	12
	<ul style="list-style-type: none"> • connection: 1/2" IPS • tub spout length: 5-1/2" • tub spout type: diverter 	3911	74.40	Chrome	12
	<ul style="list-style-type: none"> • connection: 1/2" slip fit • tub spout length: 5-1/2" • tub spout type: diverter 	3960	74.40	Chrome	12
	<ul style="list-style-type: none"> • matches Eva® collection • connection: 1/2" slip fit • tub spout length: 7" • tub spout type: diverter 	3853	76.30	Chrome	12
		3853BN	158.30	Brushed Nickel	12
		3853BRB	117.45	Mediterranean Bronze	12
		3853ORB	174.10	Oil Rubbed Bronze	12
	<ul style="list-style-type: none"> • matched Genta™ LX collection • connection: 1/2" slip fit • tub spout length: 7" • tub spout type: diverter • drain size: 3-1/2" 	3839	74.60	Chrome	12
		3839BN	108.25	Brushed Nickel	1
		3839BL	119.00	Matte Black	12
	<ul style="list-style-type: none"> • connection: 1/2" IPS • tub spout length: 5-1/2" • tub spout type: diverter 	3926	72.35	Chrome	12
	<ul style="list-style-type: none"> • connection: 1/2" slip fit • tub spout length: 5-1/2" • tub spout type: diverter 	3931	72.35	Chrome	12

Non-Diverting Tub Spouts

		MODEL	LIST	FINISH/CONNECT	CASE QTY
NON-DIVERTING TUB SPOUT - PREMIUM					
	<ul style="list-style-type: none"> • matches Weymouth® collection • connection: 1/2" slip fit • tub spout length: 6-3/4" • tub spout type: non diverter 	S12105	201.40	Chrome	6
		S12105BN	292.05	Brushed Nickel	6
		S12105NL	292.05	Polished Nickel	6
		S12105BG	292.05	Brushed Gold	6
		S12105BL	321.25	Matte Black	6
		S12105ORB	321.25	Oil Rubbed Bronze	6
	<ul style="list-style-type: none"> • matches Flara™ collection • connection: 1/2" slip fit • tub spout length: 8-1/8" • tub spout type: non diverter 	S990	280.65	Chrome	6
		S990BN	421.00	Brushed Nickel	6
		S990NL	421.00	Polished Nickel	6
		S990BG	421.00	Brushed Gold	6
	<ul style="list-style-type: none"> • matched Colinet™ collection • connection: 1/2" slip fit • tub spout length: 9" • tub spout type: non diverter 	S5001	249.55	Chrome	6
		S5001BN	374.30	Brushed Nickel	6
		S5001BG	374.30	Brushed Gold	6
		S5001BL	411.70	Matte Black	6
	<ul style="list-style-type: none"> • matches Arris® collection • connection: 1/2" slip fit • tub spout length: 7-1/8" • tub spout type: non diverter 	S16900	189.10	Chrome	6
		S16900BN	320.70	Brushed Nickel	6
		S16900BL	352.85	Matte Black	6
	<ul style="list-style-type: none"> • matches Doux™ collection • connection: 1/2" slip fit • tub spout length: 7-3/4" • tub spout type: non diverter 	S3836	155.40	Chrome	6
		S3836BN	225.30	Brushed Nickel	6
		S3836BL	247.75	Matte Black	6
	<ul style="list-style-type: none"> • matches 90 Degree™ collection • connection: 1/2" slip fit • tub spout length: 7-1/4" • tub spout type: non diverter 	S3898	138.85	Chrome	6
		S3898BN	201.45	Brushed Nickel	6
		S3898BL	203.30	Matte Black	6
NON-DIVERTING TUB SPOUT					
	<ul style="list-style-type: none"> • matches Greenfield™ collection • connection: 1/2" slip fit • tub spout length: 7-3/8" • tub spout type: non diverter 	4326	79.90	Chrome	6
		4326BN	123.45	Brushed Nickel	6
		4326BG	123.45	Brushed Gold	6
		4326BL	135.85	Matte Black	6
	<ul style="list-style-type: none"> • matches Cia™ collection • connection: 1/2" slip fit • tub spout length: 7-1/4" • tub spout type: non diverter 	3347	76.75	Chrome	6
		3347BN	118.45	Brushed Nickel	6
		3347BG	118.45	Brushed Gold	6
		3347BL	130.30	Matte Black	6
	<ul style="list-style-type: none"> • matches Dartmoor® collection • connection: 1/2" slip fit • tub spout length: 7-1/4" • tub spout type: non diverter 	3858	94.30	Chrome	6
		3858BN	136.95	Brushed Nickel	6
		3858BL	150.65	Matte Black	6
		3858ORB	150.65	Oil Rubbed Bronze	6
	<ul style="list-style-type: none"> • matches Voss™ collection • connection: 1/2" slip fit • tub spout length: 7-3/4" • tub spout type: non diverter 	191956	96.05	Chrome	6
		191956BN	139.20	Brushed Nickel	6
		191956NL	139.20	Polished Nickel	6
		191956BG	139.20	Brushed Gold	6
		191956BL	142.35	Matte Black	6
		191956ORB	153.00	Oil Rubbed Bronze	6

Non-Diverting Tub Spouts



NON-DIVERTING TUB SPOUT		MODEL	LIST	FINISH/CONNECT	CASE QTY
 <ul style="list-style-type: none"> • matches Wynford® collection • connection: 1/2" slip fit • tub spout length: 8" • tub spout type: non diverter 		195386	95.35	Chrome	6
		195386BN	138.35	Brushed Nickel	6
		195386NL	138.35	Polished Nickel	6
		195386ORB	152.25	Oil Rubbed Bronze	6
 <ul style="list-style-type: none"> • matches Belfield® collection • connection: 1/2" slip fit • tub spout length: 7-3/4" • tub spout type: non diverter 		193371	79.90	Chrome	6
		193371BN	123.45	Brushed Nickel	6
		193371BL	127.90	Matte Black	6
		193371ORB	135.85	Oil Rubbed Bronze	6
 <ul style="list-style-type: none"> • matches Gibson™ collection • connection: 1/2" slip fit • tub spout length: 6-1/2" • tub spout type: non diverter 		3892	80.95	Chrome	12
		3892BN	124.95	Brushed Nickel	12
		3892BG	124.95	Brushed Gold	6
		3892BL	133.30	Matte Black	6
 <ul style="list-style-type: none"> • matches Align® collection • connection: 1/2" slip fit • tub spout length: 7-1/8" • tub spout type: non diverter 		195827	79.90	Chrome	6
		195827BN	123.45	Brushed Nickel	6
		195827BG	123.45	Brushed Gold	6
		195827BL	135.85	Matte Black	6
 <ul style="list-style-type: none"> • connection: 1/2" slip fit • tub spout length: 5-1/2" • tub spout type: non diverter 		3959	66.70	Chrome	12
 <ul style="list-style-type: none"> • connection: 1/2" IPS • tub spout length: 7" • tub spout type: non diverter 		3828	64.15	Chrome	12
 <ul style="list-style-type: none"> • connection: 1/2" slip fit • tub spout length: 7" • tub spout type: non diverter 		3829	64.15	Chrome	12
		3829BN	147.15	Brushed Nickel	12
		3829BL	153.55	Matte Black	12
		3829ORB	161.85	Oil Rubbed Bronze	12

CUSTOM SHOWERING

One-Handle Wallmount Tub Spouts

		MODEL	LIST	FINISH/CONNECT	CASE QTY		
ONE-HANDLE WALLMOUNT TUB SPOUTS - PREMIUM							
	<ul style="list-style-type: none"> • matches Flara™ collection • tub spout length: 10" • tub spout type: non-diverting • spout manifold required: sold separately 	TFS990	372.30	Chrome	6		
		TFS990BN	502.60	Brushed Nickel	6		
		TFS990NL	502.60	Polished Nickel	6		
		TFS990BG	502.60	Brushed Gold	6		
	<ul style="list-style-type: none"> • matches Colinet™ collection • tub spout length: 10" • tub spout type: non-diverting • spout manifold required: sold separately 	TFS5001	383.55	Chrome	6		
		TFS5001BN	517.80	Brushed Nickel	6		
		TFS5001BG	517.80	Brushed Gold	6		
		TFS5001BL	569.60	Matte Black	6		
	<ul style="list-style-type: none"> • matches 90 Degree™ collection • tub spout length: 10" • tub spout type: non-diverting • spout manifold required: sold separately 	TFS3898	355.80	Chrome	6		
		TFS3898BN	480.30	Brushed Nickel	6		
		TFS3898BL	498.05	Matte Black	6		
	<ul style="list-style-type: none"> • matches Doux™ collection • tub spout length: 10" • tub spout type: non-diverting • spout manifold required: sold separately 	TFS3836	355.80	Chrome	6		
		TFS3836BN	498.05	Brushed Nickel	6		
		TFS3836BL	547.90	Matte Black	6		
ONE-HANDLE WALLMOUNT TUB SPOUTS							
	<ul style="list-style-type: none"> • matches Greenfield™ collection • tub spout length: 10" • tub spout type: non-diverting • spout manifold required: sold separately 	TF4326	367.35	Chrome	6		
		TF4326BN	470.15	Brushed Nickel	6		
		TF4326BG	470.15	Brushed Gold	6		
		TF4326BL	517.25	Matte Black	6		
	<ul style="list-style-type: none"> • matches Align® collection • tub spout length: 10" • tub spout type: non-diverting • spout manifold required: sold separately 	TF195827	367.35	Chrome	6		
		TF195827BN	470.15	Brushed Nickel	6		
		TF195827BG	470.15	Brushed Gold	6		
		TF195827BL	517.25	Matte Black	6		
	<ul style="list-style-type: none"> • matches Belfield® collection • tub spout length: 10" • tub spout type: non-diverting • spout manifold required: sold separately 	TF193371	306.00	Chrome	6		
		TF193371BN	391.70	Brushed Nickel	6		
		TF193371NL	391.70	Polished Nickel	6		
		TF193371BL	411.20	Matte Black	6		
		TF193371ORB	430.85	Oil Rubbed Bronze	6		
	<ul style="list-style-type: none"> • modern style • tub spout length: 10" • tub spout type: non-diverting • spout manifold required: sold separately 	TF3347	328.95	Chrome	6		
		TF3347BN	421.05	Brushed Nickel	6		
		TF3347BG	421.05	Brushed Gold	6		
		TF3347BL	463.20	Matte Black	6		
	<ul style="list-style-type: none"> • matches Voss™ collection • tub spout length: 10" • tub spout type: non-diverting • spout manifold required: sold separately 	TF191956	341.70	Chrome	6		
		TF191956BN	437.40	Brushed Nickel	6		
		TF191956NL	437.40	Polished Nickel	6		
		TF191956BG	437.40	Brushed Gold	6		
		TF191956BL	459.15	Matte Black	6		
		TF191956ORB	481.15	Oil Rubbed Bronze	6		
			<ul style="list-style-type: none"> • matches Dartmoor® collection • tub spout length: 10" • tub spout type: non-diverting • spout manifold required: sold separately 	TF3858	229.50	Chrome	6
				TF3858BN	309.80	Brushed Nickel	6
TF3858BL	340.85			Matte Black	6		
TF3858ORB	340.85			Oil Rubbed Bronze	6		

One-Handle Wallmount Tub Spouts

		MODEL	LIST	FINISH/CONNECT	CASE QTY
ONE-HANDLE WALLMOUNT TUB SPOUTS					
 <ul style="list-style-type: none"> • matches Glyde™ collection • tub spout length: 10" • tub spout type: non-diverting • spout manifold required: sold separately 		TF195386	229.50	Chrome	6
		TF195386BN	309.80	Brushed Nickel	6
		TF195386BL	340.85	Matte Black	6
<hr/>					
 <ul style="list-style-type: none"> • matches Genta™ LX collection • tub spout length: 10" • tub spout type: non-diverting • spout manifold required: sold separately 		TF3901	239.15	Chrome	6
		TF3901BN	322.85	Brushed Nickel	6
		TF3901BL	355.15	Matte Black	6
<hr/>					
ONE-HANDLE WALLMOUNT TUB FILLER MANIFOLD					
 <ul style="list-style-type: none"> • spout manifold for wallmount tub filler • required for 10" tub filler spout installation 		MANCIS	59.70	N/A or Unfinished	12
		MANXS	59.70	N/A or Unfinished	12
		MANCXS	59.70	N/A or Unfinished	12

CUSTOM SHOWERING

HOW TO ORDER ONE HANDLE WALLMOUNT TUB SPOUTS

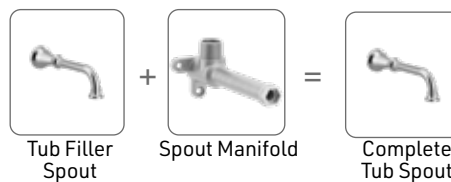









See Custom Showering Product Icon Key, page 374.

◆ BULK PACK AVAILABLE

◆◆ BULK PACK ONLY

Bath Tub and Shower Drains

		MODEL	LIST	FINISH/CONNECT	CASE QTY
TUB DRAINS					
	<ul style="list-style-type: none"> • top & bottom ells: schedule 40 abs • thread size: 1-1/2" 	140680	18.40	N/A or Unfinished	12
	<ul style="list-style-type: none"> • top & bottom ells: schedule 40 pvc • thread size: 1-1/2" 	140690	20.75	N/A or Unfinished	12
	<ul style="list-style-type: none"> • conversion bar kit • converts 2-hole top ell to accommodate 1-hole face plate 	142538	7.30	N/A or Unfinished	180
	<ul style="list-style-type: none"> • connection: 1-1/2" threaded shoe • tubing type: white pvc • fits tubs: 14 - 16" 	90530	68.45	Chrome	10
	<ul style="list-style-type: none"> • connection: 1-1/2" threaded shoe; male IPS 	T90331	46.55	Chrome	12
		T90331BN	146.85	Brushed Nickel	12
		T90331NL	146.85	Polished Nickel	12
		T90331BG	146.85	Brushed Gold	12
		T90331WR	161.50	Wrought Iron	12
		T90331ORB	161.50	Oil Rubbed Bronze	12
SHOWER DRAINS					
	<ul style="list-style-type: none"> • drain size: mounts on 2-5/8" centers 	101664BN	51.25	Brushed Nickel	12
		101664BG	51.25	Brushed Gold	12
		101664WR	56.50	Wrought Iron	12
		101664ORB	58.25	Oil Rubbed Bronze	12
	<ul style="list-style-type: none"> • drain size: mounts on 3-3/8" centers 	102763BN	51.25	Brushed Nickel	12
		102763BG	51.25	Brushed Gold	12
		102763WR	56.50	Wrought Iron	12
		102763ORB	58.25	Oil Rubbed Bronze	12
	<ul style="list-style-type: none"> • drain size: fits in 3" diameter drains 	101663BN	41.25	Brushed Nickel	12
		101663BG	41.25	Brushed Gold	12
		101663WR	45.45	Wrought Iron	12
		101663ORB	46.95	Oil Rubbed Bronze	12

Valves



Whether you're designing a simple shower or an extravagant spa experience, Moen's valve portfolio allows you to create a space perfectly personalized to you. Designed with feedback from professional installers, our M-CORE universal valve system gives you the freedom to create the exact shower you want with nearly unlimited ways to combine preferred functionality with desired trim style - all while simplifying installation.

Valves

COLLECTIONS

- 469 Widespread Valve
- 469 Wallmount Lavatory Valve
- 469 Freestanding Tub Filler Valves
- 469 Wallmount Tub Filler Valve
- 470 Roman Tub Valve
- 471 Smart Shower Thermostatic Valve
- 471 ExactTemp® Valve
- 471 M-CORE® Valve
- 473 Posi-Temp® Valve
- 477 Non-Pressure Balanced Valve
- 477 Flushmount Body Spray Valve
- 477 Bidet Valve

ICON KEY



Moen® M•PACT® Common Valve System

With M•PACT, you can change your faucet style without replacing any plumbing. It's as easy as changing a light bulb.

DURALOCK®

Push button connector makes installing faucets quick, secure, and hassle-free – no tools required. A telltale 'click' audibly signals connection.

DURALAST®

Provides the smooth feel and reliable operation of a new faucet from the first time you use it to the last.













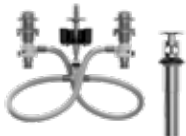



Also available in bulk pack.
See page 597.















Available in bulk pack only.











VALVES

		MODEL	LIST	FINISH/CONNECT	CASE QTY
WIDESPREAD FAUCET VALVE					
	<ul style="list-style-type: none"> • application: three hole • center dimensions: 8" - 16" center • drain assembly: metal with lift rod  DURALOCK® DURALAST®	9000◆	165.40	1/2" IPS	6
WALLMOUNT FAUCET VALVE					
	<ul style="list-style-type: none"> • application: three hole • center dimensions: 8" center • drain assembly: 140780 sold separately • includes: mounting brackets  DURALAST®	9700	233.95	1/2" CC	3
FREESTANDING TUB FILLER VALVE AND MOUNTING KIT - PREMIUM					
	<ul style="list-style-type: none"> • description: double riser floor joist mounting kit • application: two hole • center dimensions: 8" center • quarter turn stops: included 	TS50200	613.50	1/2" CC, NPT	2
	<ul style="list-style-type: none"> • description: double riser concrete mounting kit • application: two hole • center dimensions: 8" center • quarter turn stops: included 	TS50210	498.70	1/2" CC, NPT	2
FREESTANDING TUB FILLER VALVE AND MOUNTING KIT - PREMIUM					
	<ul style="list-style-type: none"> • description: single riser floor joist mounting kit • application: one hole • quarter turn stops: included 	TS50100	408.90	1/2" CC, NPT	2
	<ul style="list-style-type: none"> • description: single riser concrete mounting kit • application: one hole • quarter turn stops: included 	TS50110	332.45	1/2" CC, NPT	2
ONE-HANDLE WALLMOUNT TUB FILLER VALVE KIT					
	<ul style="list-style-type: none"> • application: two hole • center dimensions: adjustable • ports: three • quarter turn stops: included • includes: test plug • includes: spout manifold 	WMV130CIS	154.05	1/2" CC/IPS	6
		WMV130XS	154.05	1/2" Crimp Ring PEX	6
		WMV130CXS	154.05	1/2" Cold Expansion PEX	6

VALVES









		MODEL	LIST	FINISH/CONNECT	CASE QTY
TWO-HANDLE ROMAN TUB VALVE					
	<ul style="list-style-type: none"> • application: three hole • deck thickness: 1/8" to 3-3/8" rough-in deck • center dimensions: adjustable • adjustable spout shank: included • test plug: included 	4792	192.30	1/2" CC	6
	 DURALAST®				
	<ul style="list-style-type: none"> • application: three hole • deck thickness: 1/8" to 2-3/4" rough-in deck • center dimensions: 10" - 24" center • adjustable spout shank: included • test plug: included 	4793	217.80	1/2" CPVC, Crimp Ring PEX	6
	 DURALOCK® DURALAST®	4794	207.65	1/2" Crimp Ring PEX, Cold Expansion PEX	6
	<ul style="list-style-type: none"> • application: three hole • deck thickness: 1/8" to 1-3/16" rough-in deck • center dimensions: 10" center • non-adjustable spout shank: included • test plug: included 	4796	181.20	1/2" CC	6
	 DURALAST®	4797	184.70	1/2" CPVC, Crimp Ring PEX	6
		4798	184.70	1/2" Crimp Ring PEX, Cold Expansion PEX	6
TWO-HANDLE ROMAN TUB VALVE WITH HANDSHOWER					
	<ul style="list-style-type: none"> • application: four hole • deck thickness: 1/8" to 2-5/8" rough-in deck • center dimensions: adjustable • non-adjustable spout shank: included • test plug: included 	9792	433.35	1/2" CC	6
	 DURALAST®				
	<ul style="list-style-type: none"> • application: four hole • deck thickness: 1/8" to 2-5/8" rough-in deck • center dimensions: 10" - 24" center • adjustable spout shank: included • test plug: included 	9793	443.50	1/2" CPVC, Crimp Ring PEX	6
	 DURALOCK® DURALAST®				
ROMAN TUB OPTIONS					
	<ul style="list-style-type: none"> • description: high flow thermostatic mixing valve for roman tubs • ports: three • ASSE standard 1070: yes • flow rate: 12.0 gpm (45.4 L/min) max 	104465	185.95	1/2" CC	12
		104466	185.95	1/2" IPS	12
		104464	185.95	1/2" Crimp Ring PEX	12
		104463	185.95	1/2" Cold Expansion PEX	12
	<ul style="list-style-type: none"> • description: PEX transition fittings (2) and clips • connections: adapts standard 1/2" PEX barb to 1/2" PEX cold expansion 	140715	12.95	PEX	200

VALVES





















		MODEL	LIST	FINISH/CONNECT	CASE QTY
SMART SHOWER 4 OUTLET THERMOSTATIC SHOWER VALVE - PREMIUM					
 <ul style="list-style-type: none"> description: digital thermostatic shower valve ports: four outlets features: precise temperature control connection: 3/4" CC inlets & 1/2" outlets installation: fits standard 2x4 wall includes: 30 foot data cable 		S3104	1836.30	3/4" CC	3
				BATTERY BACKUP SOLD SEPARATELY	
		179573	78.30	N/A or Unfinished	6
SMART SHOWER 2 OUTLET THERMOSTATIC SHOWER VALVE - PREMIUM					
 <ul style="list-style-type: none"> description: digital thermostatic shower valve ports: two outlets features: precise temperature control connection: 1/2" CC inlets & 1/2" outlets installation: fits standard 2x4 wall includes: 30 foot data cable 		S3102	859.30	1/2" CC	3
				BATTERY BACKUP SOLD SEPARATELY	
		179573	78.30	N/A or Unfinished	6
EXACTTEMP® THERMOSTATIC MIXING SHOWER VALVE - PREMIUM					
 <ul style="list-style-type: none"> description: thermostatic rough-in valve ports: four adjustable temp limit stop: included check stops: included 		S3371	728.95	3/4" IPS	6
EXACTTEMP® VOLUME CONTROL SHOWER VALVE - PREMIUM					
 <ul style="list-style-type: none"> description: volume control rough-in valve includes: volume control 		S3600	185.35	3/4" IPS	12
M-CORE® MIXING SHOWER VALVE					
 <ul style="list-style-type: none"> ports: three test plug: included cross flow plug: included 		U130CI	72.60	1/2" CC/IPS	6
		U130X	72.60	1/2" Crimp Ring PEX	6
		U130CX	72.60	1/2" Cold Expansion PEX	6
 <ul style="list-style-type: none"> ports: three adjustable temp limit stops: included quarter turn stops: included test plug: included 		U130CIS	104.50	1/2" CC/IPS	6
		U130XS	104.50	1/2" Crimp Ring PEX	6
		U130CXS	104.50	1/2" Cold Expansion PEX	6
 <ul style="list-style-type: none"> ports: four adjustable temp limit stop: included test plug: included cross flow plug: included 		U140CI	72.60	1/2" CC/IPS	6
		U140X	72.60	1/2" Crimp Ring PEX with CC/IPS Tub Outlet	6
		U140CX	72.60	1/2" Cold Exp PEX with CC/IPS Tub Outlet	6
		U140V	88.95	1/2" CPVC with CC/IPS Tub Outlet	6
 <ul style="list-style-type: none"> ports: four adjustable temp limit stop: included quarter turn stops: included test plug: included 		U140CIS	104.50	1/2" CC/IPS	6
		U140XS	104.50	1/2" Crimp Ring PEX with CC/IPS Tub Outlet	6
		U140CXS	104.50	1/2" Cold Exp PEX with CC/IPS Tub Outlet	6
		U140VS	120.85	1/2" CPVC with CC/IPS Tub Outlet	6























VALVES

		MODEL	LIST	FINISH/CONNECT	CASE QTY
M-CORE® WITH INTEGRATED TRANSFER VALVE - 3 OR 6 FUNCTIONS					
	<ul style="list-style-type: none"> • ports: four, three outlets • adjustable temp limit stop: included • quarter turn stops: included • type of function: 2 independent/1 shared or 3 independent/3 shared • includes: volume control • test plug: included 	U362CIS	270.70	1/2" CC/IPS	6
		U362CXS	270.70	1/2" Cold Expansion PEX	6
		U362XS	270.70	1/2" Crimp Ring PEX	6
M-CORE® WITH INTEGRATED TRANSFER VALVE - 2 OR 3 FUNCTIONS					
	<ul style="list-style-type: none"> • ports: four, three outlets • adjustable temp limit stop: included • quarter turn stops: included • type of function: 2 independent or 3 independent • includes: volume control • test plug: included 	U232CIS	270.70	1/2" CC/IPS	6
		U232CXS	270.70	1/2" Cold Expansion PEX	6
		U232XS	270.70	1/2" Crimp Ring PEX	6
M-CORE® TRANSFER VALVE - 3 OR 6 FUNCTIONS					
	<ul style="list-style-type: none"> • description: transfer valve • ports: four, three outlets • type of function: 2 independent/1 shared or 3 independent/3 shared 	U361CI	152.70	1/2" CC/IPS	6
		U361CX	152.70	1/2" Cold Expansion PEX	6
		U361X	152.70	1/2" Crimp Ring PEX	6
M-CORE® TRANSFER VALVE - 2 OR 3 FUNCTIONS					
	<ul style="list-style-type: none"> • description: transfer valve • ports: four, three outlets • type of function: 2 independent or 3 independent 	U231CI	152.70	1/2" CC/IPS	6
		U231CX	152.70	1/2" Cold Expansion PEX	6
		U231X	152.70	1/2" Crimp Ring PEX	6







VALVES













		MODEL	LIST	FINISH/CONNECT	CASE QTY
POSI-TEMP® MIXING SHOWER VALVE					
	<ul style="list-style-type: none"> • description: pressure balanced cycling valve • ports: four • adjustable temp limit stop: included 	2520	159.20	1/2" CC	6
	<ul style="list-style-type: none"> • description: pressure balanced cycling valve • ports: four • adjustable temp limit stop: included • bulk pack: yes 	62320◆	148.05	1/2" CC	12
	<ul style="list-style-type: none"> • description: pressure balanced cycling valve • ports: four • adjustable temp limit stop: included • test plug: included • bulk pack: yes 	FP62320◆	148.05	1/2" CC	12
	<ul style="list-style-type: none"> • description: pressure balanced cycling valve • ports: four • adjustable temp limit stop: included • quarter turn stops: included 	2570	193.35	1/2" CC	6
	<ul style="list-style-type: none"> • description: pressure balanced cycling valve • ports: four • adjustable temp limit stop: included • quarter turn stops: included • test plug: included • bulk pack: yes 	62370◆	180.00	1/2" CC	12
	<ul style="list-style-type: none"> • description: pressure balanced cycling valve • ports: four • adjustable temp limit stop: included • quarter turn stops: included • test plug: included • bulk pack: yes 	FP62370◆	180.00	1/2" CC	12
	<ul style="list-style-type: none"> • description: pressure balanced cycling valve • ports: four • adjustable temp limit stop: included 	2510	159.20	1/2" IPS	6
	<ul style="list-style-type: none"> • description: pressure balanced cycling valve • ports: four • adjustable temp limit stop: included • bulk pack: yes 	62300◆	148.05	1/2" IPS	12
	<ul style="list-style-type: none"> • description: pressure balanced cycling valve • ports: four • adjustable temp limit stop: included • test plug: included • bulk pack: yes 	FP62300◆	148.05	1/2" IPS	12
	<ul style="list-style-type: none"> • description: pressure balanced cycling valve • ports: four • adjustable temp limit stop: included • quarter turn stops: included 	2590	193.35	1/2" IPS	6

VALVES



















		MODEL	LIST	FINISH/CONNECT	CASE QTY
POSI-TEMP® MIXING SHOWER VALVE (CONTINUED)					
	<ul style="list-style-type: none"> • description: pressure balanced cycling valve • ports: four • adjustable temp limit stop: included • quarter turn stops: included • bulk pack: yes 	62390◆	180.00	1/2" IPS	12
	<ul style="list-style-type: none"> • description: pressure balanced cycling valve • ports: four • adjustable temp limit stop: included 	2580	159.20	1/2" Crimp PEX	6
	<ul style="list-style-type: none"> • description: pressure balanced cycling valve • ports: four • adjustable temp limit stop: included • bulk pack: yes 	62380◆	148.05	1/2" Crimp Ring PEX	12
	<ul style="list-style-type: none"> • description: pressure balanced cycling valve • ports: four • adjustable temp limit stop: included • test plug: included • bulk pack: yes 	FP62380◆	148.05	1/2" Crimp Ring PEX	12
	<ul style="list-style-type: none"> • description: pressure balanced cycling valve • ports: four • adjustable temp limit stop: included • quarter turn stops: included • test plug: included • bulk pack: yes 	62360◆	180.00	1/2" Crimp Ring PEX	12
	<ul style="list-style-type: none"> • description: pressure balanced cycling valve • ports: four • adjustable temp limit stop: included • bulk pack: yes 	62365◆	148.05	1/2" Cold Expansion PEX	12
	<ul style="list-style-type: none"> • description: pressure balanced cycling valve • ports: four • adjustable temp limit stop: included • test plug: included • bulk pack: yes 	FP62365◆	148.05	1/2" Cold Expansion PEX	12
	<ul style="list-style-type: none"> • description: pressure balanced cycling valve • ports: four • adjustable temp limit stop: included • quarter turn stops: included • bulk pack: yes 	62385◆	180.00	1/2" Cold Expansion PEX	12
	<ul style="list-style-type: none"> • description: pressure balanced cycling valve • ports: four • adjustable temp limit stop: included • quarter turn stops: included • test plug: included • bulk pack: yes 	FP62385◆	180.00	1/2" Cold Expansion PEX	12
	<ul style="list-style-type: none"> • description: pressure balanced cycling valve • ports: four • adjustable temp limit stop: included • bulk pack: yes 	62340◆	164.25	1/2" CPVC	12

VALVES

		MODEL	LIST	FINISH/CONNECT	CASE QTY
POSI-TEMP® MIXING SHOWER VALVE (CONTINUED)					
	<ul style="list-style-type: none"> • description: pressure balanced cycling valve • ports: four • adjustable temp limit stop: included • test plug: included • bulk pack: yes 	FP62340◆	164.25	1/2" CPVC	12
	<ul style="list-style-type: none"> • description: pressure balanced cycling valve • ports: four • adjustable temp limit stop: included • quarter turn stops: included • bulk pack: yes 	62330◆	196.25	1/2" CPVC	12
	<ul style="list-style-type: none"> • description: pressure balanced cycling valve • ports: three • adjustable temp limit stop: included • bulk pack: yes 	62345◆	148.05	1/2" IPS, CC	12





POSI-TEMP® PRE-FAB MIXING SHOWER VALVES					
	<ul style="list-style-type: none"> • description: pressure balanced cycling valve • ports: three • adjustable temp limit stop: included • test plug: included • bulk pack: yes 	FP62325PF◆	161.30	1/2" Crimp Ring PEX	12
	<ul style="list-style-type: none"> • description: pressure balanced cycling valve • ports: three • adjustable temp limit stop: included • quarter turn stops: included • test plug: included • bulk pack: yes 	FP62326PF◆	193.25	1/2" Crimp Ring PEX	12
	<ul style="list-style-type: none"> • description: pressure balanced cycling valve • ports: three • adjustable temp limit stop: included • quarter turn stops: included 	2326PF	205.20	1/2" Crimp Ring PEX	6
	<ul style="list-style-type: none"> • description: pressure balanced cycling valve • ports: three • adjustable temp limit stop: included • test plug: included • bulk pack: yes 	FP62327PF◆	161.30	1/2" Cold Expansion PEX	12
	<ul style="list-style-type: none"> • description: pressure balanced cycling valve • ports: three • adjustable temp limit stop: included • connection: 1/2" cold expansion PEX • quarter turn stops: included • test plug: included 	FP62328PF◆	193.25	1/2" Cold Expansion PEX	12
	<ul style="list-style-type: none"> • description: pressure balanced cycling valve • ports: three • adjustable temp limit stop: included • quarter turn stops: included • bulk pack: yes 	2328PF	205.20	1/2" Cold Expansion PEX	6





VALVES





		MODEL	LIST	FINISH/CONNECT	CASE QTY
POSI-TEMP® PRE-FAB MIXING SHOWER VALVES (CONTINUED)					
	<ul style="list-style-type: none"> • description: pressure balanced cycling valve • ports: four • adjustable temp limit stop: included • test plug: included • bulk pack: yes 	FP62380PF◆	168.65	1/2" Crimp Ring PEX	12
	<ul style="list-style-type: none"> • description: pressure balanced cycling valve • ports: four • adjustable temp limit stop: included • test plug: included 	62380PF◆	168.65	1/2" Crimp Ring PEX	12
	<ul style="list-style-type: none"> • description: pressure balanced cycling valve • ports: four • adjustable temp limit stop: included • quarter turn stops: included • test plug: included • bulk pack: yes 	FP62360PF◆	200.50	1/2" Crimp Ring PEX	12
	<ul style="list-style-type: none"> • description: pressure balanced cycling valve • ports: four • adjustable temp limit stop: included • quarter turn stops: included • bulk pack: yes 	62360PF◆	200.50	1/2" Crimp Ring PEX	12
	<ul style="list-style-type: none"> • description: pressure balanced cycling valve • ports: four • adjustable temp limit stop: included • quarter turn stops: included 	2360PF	212.60	1/2" Crimp Ring PEX	3
	<ul style="list-style-type: none"> • description: pressure balanced cycling valve • ports: four • adjustable temp limit stop: included • test plug: included • bulk pack: yes 	FP62365PF◆	168.65	1/2" Cold Expansion PEX	12
	<ul style="list-style-type: none"> • description: pressure balanced cycling valve • ports: four • adjustable temp limit stop: included • bulk pack: yes 	62365PF◆	168.65	1/2" Cold Expansion PEX	12
	<ul style="list-style-type: none"> • description: pressure balanced cycling valve • ports: four • adjustable temp limit stop: included • quarter turn stops: included • test plug: included • bulk pack: yes 	FP62385PF◆	200.50	1/2" Cold Expansion PEX	12
	<ul style="list-style-type: none"> • description: pressure balanced cycling valve • ports: four • adjustable temp limit stop: included • quarter turn stops: included • test plug: included • bulk pack: yes 	62385PF◆	200.50	1/2" Cold Expansion PEX	12



VALVES



VALVES

		MODEL	LIST	FINISH/CONNECT	CASE QTY
POSI-TEMP® WITH INTEGRATED TRANSFER VALVE - 3 FUNCTIONS					
	<ul style="list-style-type: none"> • description: pressure balanced cycling valve with transfer valve • ports: four • adjustable temp limit stop: included • type of function: two independent 1 shared 	2551	287.50	1/2" IPS	6
	<ul style="list-style-type: none"> • description: pressure balanced cycling valve with transfer valve • ports: four • adjustable temp limit stop: included • stops: included • type of function: two independent 1 shared 	2581	323.75	1/2" IPS	6

POSI-TEMP® WITH INTEGRATED TRANSFER VALVE - 2 FUNCTIONS					
	<ul style="list-style-type: none"> • description: pressure balanced cycling valve with transfer valve • ports: four • adjustable temp limit stop: included • type of function: two discrete 	2521	287.50	1/2" IPS	6
	<ul style="list-style-type: none"> • description: pressure balanced cycling valve with transfer valve • ports: four • adjustable temp limit stop: included • type of function: two discrete • stops: included 	2571	323.75	1/2" IPS	6

NON-PRESSURE BALANCED MIXING SHOWER VALVE					
	<ul style="list-style-type: none"> • description: non-pressure balanced valve • ports: four • bulk pack: yes 	62700◆	134.85	1/2" IPS	12
	<ul style="list-style-type: none"> • description: non-pressure balanced valve • ports: four • bulk pack: yes 	62720◆	134.85	1/2" CC	12

FLUSHMOUNT BODY SPRAY VALVE - PREMIUM					
	<ul style="list-style-type: none"> • description: flushmount body spray valve • installation: fits standard 2x4 wall 	S1300	126.50	1/2" IPS, CC	6

BIDET VALVE					
	<ul style="list-style-type: none"> • application: three hole • center dimensions: 8" - 16" center  DURALOCK® DURALAST®	9265	321.95	1/2" IPS	6

VALVES M-CORE® Transfer Valve Plumbing Configurations

Plumb as recommended below for proper diverting functionality of showering devices.

VALVES

TWO INDEPENDENT FUNCTIONS

Function 1: Independent

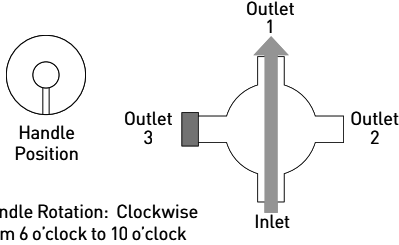

Function 2: Independent

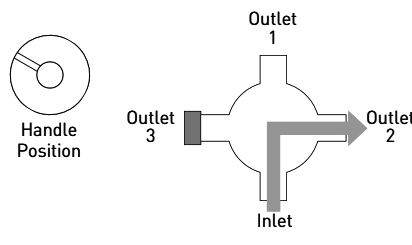

THREE INDEPENDENT FUNCTIONS

Function 1: Independent

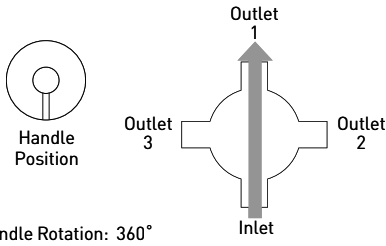

Function 2: Independent

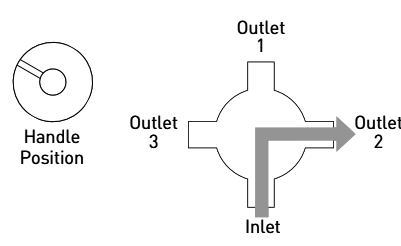

Function 3: Independent

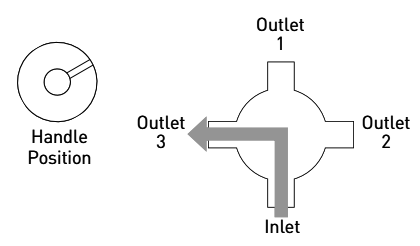

THREE FUNCTION - 2 INDEPENDENT AND 1 SHARED FUNCTION

Function 1: Independent

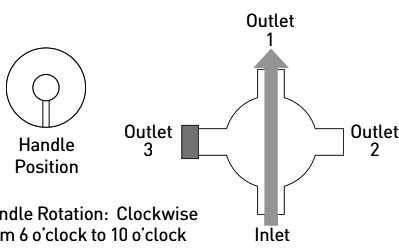

Function 2: Shared

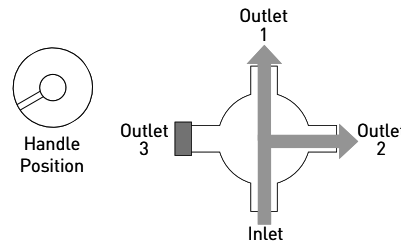

Function 3: Independent

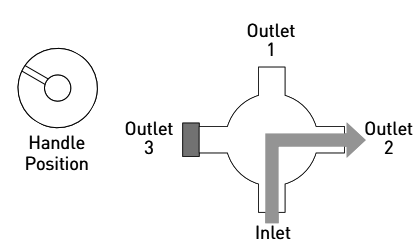

SIX FUNCTION - 3 INDEPENDENT AND 3 SHARED FUNCTIONS

Function 1: Independent

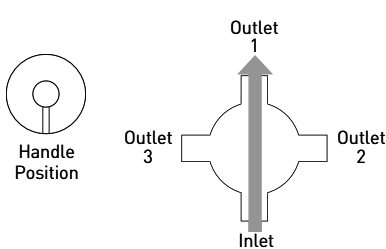

Function 2: Shared

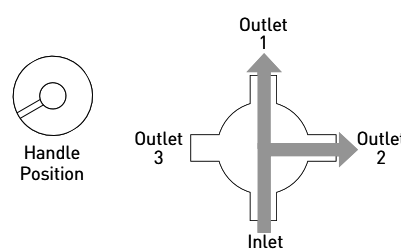

Function 3: Independent

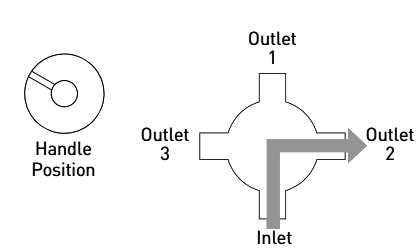

Function 4: Shared

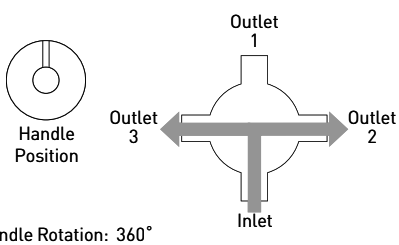

Function 5: Independent

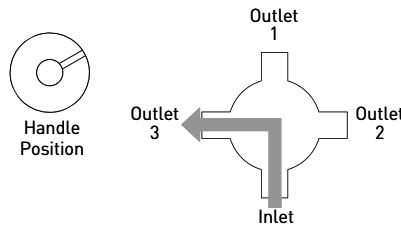

Function 6: Shared

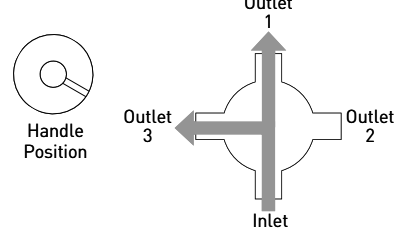

NOTES

- Outlet 1: to primary showering device
- Outlet 2: to second showering device
- Outlet 3: to third showering device

FLOW RATE VS. FLOWING INLET PRESSURE OF MOEN® SHOWERING VALVES (UNRESTRICTED)

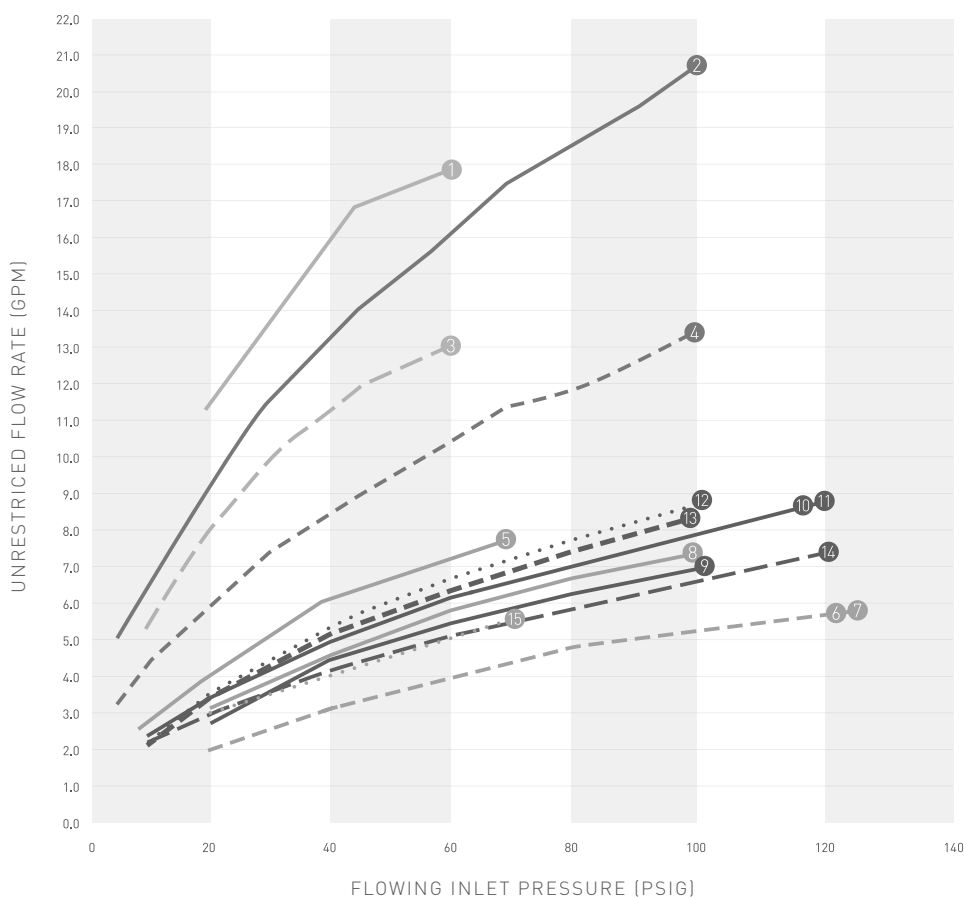

- 1 **ExactTemp® ¾" Thermostatic Showering**
S3371 ¾" ExactTemp: 18.0 GPM
- 2 **Smart Shower—4-Outlet**
S3104 4-Outlet: 16.0 GPM
- 3 **Volume Control**
S3600 Volume Control: 13+ GPM
- 4 **Smart Shower—2-Outlet**
S3102 2-Outlet: 10.0 GPM
- 5 **Posi-Temp® Tub Port**
4-Port Valve
Flow at Tub: 6.3 GPM
- 6 **Posi-Temp Shower Port**
4-Port Valve
Flow at Shower: 4.0 GPM
- 7 **Posi-Temp 3-Port**
3-Port Valve
Flow at Outlet: 6.3 GPM
- 8 **M-CORE™ 4-Series Tub Port**
Flow at Tub: 5.7 GPM
- 9 **M-CORE 4-Series Shower Port**
Flow at Shower: 5.3 GPM
- 10 **M-CORE 3-Series Tub Port**
Flow at Tub: 6.2 GPM
- 11 **M-CORE 3-Series Shower Port**
Flow at Shower: 5.8 GPM
- 12 **M-CORE 2-Series Tub Port**
Flow at Tub: 6.7 GPM
- 13 **M-CORE 2-Series Shower Port**
Flow at Shower: 6.4 GPM
- 14 **M-CORE with Transfer**
Two Outlets: 5.6 GPM
- 15 **Posi-Temp with Integrated Transfer**
Two Outlets: 5.0 GPM

SHOWER SPA INSTALLATION RECOMMENDATIONS

Graph Line	Valves	Flow Rate through Shower Port (GPM) at 20 PSI	Flow Rate through Shower Port (GPM) at 40 PSI	Flow Rate through Shower Port (GPM) at 60 PSI	Use with a Transfer Valve	Maximum Components
1	ExactTemp® ¾" Thermostatic S3371	11.4	15.7	18.0	No	4 Components: Any Combination of Showerheads, Handshowers and Body Sprays (4 max)
2	Smart Shower—4-Outlet S3104	9.0	13.0	16.0	No	4 Components: Any Combination of Showerheads, Handshowers and Body Sprays (4 max)
4	Smart Shower—2-Outlet S3102	6.0	8.5	10.0	No	Showerhead, Handshower or Showerhead, 2 Body Sprays
6	Posi-Temp 3-Port	3.6	5.1	6.3	Yes	Showerhead, Handshower or Showerhead, 2 Body Sprays*
7	M-CORE 4-Series Shower Port	2.9	4.3	5.3	Yes	Showerhead, Handshower or Showerhead, 2 Body Sprays*
9	M-CORE 3-Series Shower Port	3.1	4.6	5.8	Yes	Showerhead, Handshower or Showerhead, 2 Body Sprays*
11	M-CORE 2-Series Shower Port	3.5	5.1	6.4	Yes	Showerhead, Handshower or Showerhead, 2 Body Sprays*
13	M-CORE with Transfer	3.0	4.5	5.6	No	Showerhead, Handshower or Showerhead, 2 Body Sprays*
14	Posi-Temp Shower Port 4-Port	2.1	3.2	4.0	Yes	Showerhead, Handshower*
15	Posi-Temp with Integrated Transfer	3.0	4.0	5.0	No	Showerhead, Handshower

*Minimum 50 PSI recommended when plumbing a showerhead and 2 body sprays for shared flow.



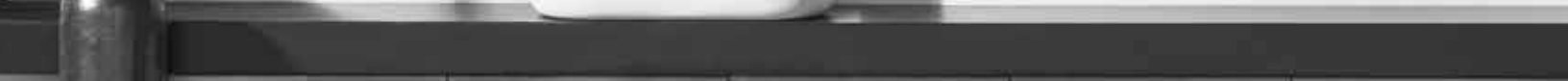

FOR A COHESIVE DESIGN

Coordinating Accessories

Perfectly suited styles for a cohesive look. From robe hooks to towel bars, lighting to knobs and pulls, Moen® offers a wide range of coordinating accessories to complete any room

Arllys® Collection



Coordinating Accessories

COLLECTIONS

- | | |
|----------------------------------|---------------------------|
| 484 Accessory Collections | 500 Kingsley® |
| 486 Pro-Fit® Installation System | 502 Gilcrest® |
| 487 Kitchen Compliments | 502 Glenshire® |
| 488 Mason® | 504 Donner™ |
| 489 Retreat® | 511 30" Towel Bars |
| 490 Arlys™ | 512 Shower Rods and Rings |
| 491 Triva™ | 518 Moen® Lighting |
| 492 Sage® | 523 Moen Knobs & Pulls |
| 493 Iso™ | 527 Grab Bar Guide |
| 495 Kyvos® | 528 SecureMount™ System |
| 496 Lounge™ | 529 Grab Bars |
| 497 Madison™ | 541 Bath Safety |
| 498 Preston™ | |
| 499 Aspen™ | |

FINISHES

- Chrome
 - Brushed Nickel
 - Brushed Gold
 - Polished Nickel
 - Oil Rubbed Bronze
 - Matte Black
 - Wrought Iron/Matte Black
 - Brushed Chrome
- Wrought Iron/Matte Black**
Wrought Iron and Matte Black are the same finish and interchangeable.





Accessory Collections

All of our bath accessory collections feature a towel ring, robe hook, 18" and 24" towel bars, and a paper holder. And there is so much more — hotel shelves, tank levers, mirrors and glass shelves are offered in many collections.



Pivoting Paper Holders

Now there's no excuse to leave the bath tissue roll empty! Many Moen® paper holders feature an innovative, spring-free design that makes changing the roll quick and easy. Simply lift the arm, insert the new roll and set the arm back into place. The pivoting arm remains attached so there's no spring to lose and no extra parts to drop.



Knobs and Pulls

With our distinctive collection of knobs and pulls, you can create a cohesive kitchen or bath, available in an array of styles and finishes.

Shower Rods

Add an elegant and luxurious look while also creating a more comfortable experience in the bath with a choice of shower rods and rings. Moen rods and rings are available in several of today's most popular finishes. These rods are featured in straight and curved styles giving you the room you need in the shower.





Grab Bars

Stylish grab bars like Iso™ bring safety and style to the bath in your choice of Chrome, Brushed Nickel, Oil Rubbed Bronze, Matte Black, and Brushed Gold finishes. Even better, SecureMount™ Anchors make installation possible anywhere on the wall, with or without studs.



Decorative Hotel Shelves

Eva®, Iso™ and Arlys™ decorative hotel shelves help create the high-end, coordinated styling of an upscale hotel while adding valuable storage space.



Bathroom Lighting

Lighting fixtures are available in several of our most popular Moen® bathroom collections. All of the styles can be mounted with globes facing either up or down.

In addition to high-end style, our lighting provides installation benefits. The Quick-Connect Wiring System lets you pre-wire the light fixture to the junction box, meaning there is no need to hold the fixture up to the wall during the wiring process. Glazed sockets help ensure the socket rings install with ease. Additionally, the UL®-listed fixtures are backed by the Moen warranty and our industry-leading customer service.

Pro-Fit® Installation System

The three-step Moen® Pro-Fit Installation System is the simple, most innovative way to mount bath hardware and accessories. Installation is as easy as 1-2-3.

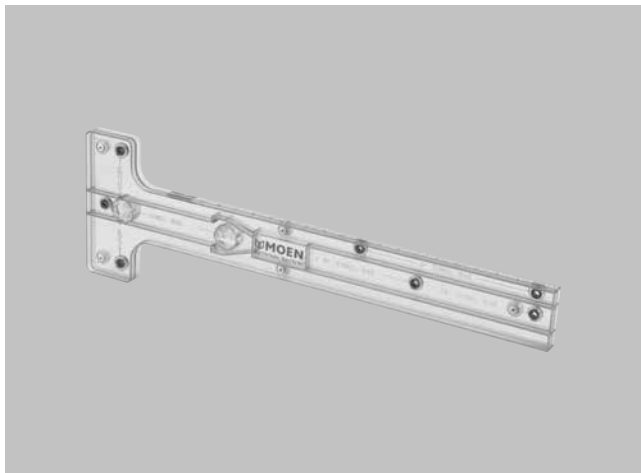

Pro-Fit Installation Template

The Pro-Fit Installation System eliminates set screws for faster, easier mounting. There's even a template with a built-in level.

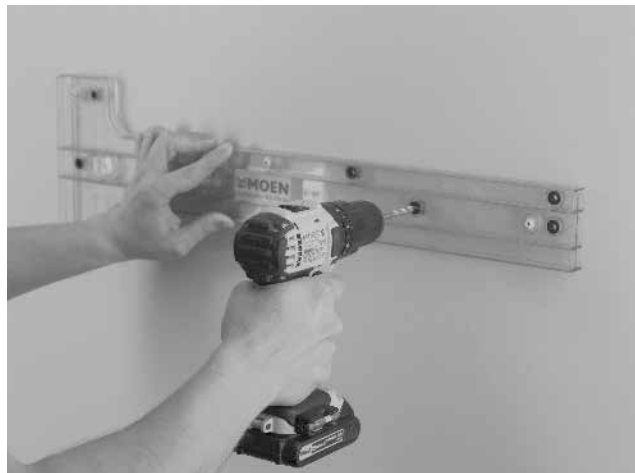

Step One: Drill It

The innovative template has a built-in level for accurate drilling of pilot holes for both 18" and 24" towel bars and paper holders.



Step Two: Screw It

The single-screw mounting system creates a fast and solid installation with minimal damage to walls.



Step Three: Click It

The locking tab clicks to hold the post firmly in place and eliminates the need for a set screw.

IT REALLY IS THAT SIMPLE

Plus, we've eliminated the set screw. Designed with input from professional installers, the Pro-Fit Installation System was made for faster installation and fewer callbacks. And of course, there's the extra assurance of quality that comes with the Moen brand. Visit moenpro.com to view online installation videos.

Pro-Fit Installation Template: YB8081

Moen® Kitchen Complements

EXCEPTIONAL FAUCETS ARE ONLY THE BEGINNING

Who says Moen® towel bars are just for the bathroom? With several faucet-matching collections featuring both kitchen and bath fixture options — such as Weymouth®, Align™, Belfield™ and more — we've made sure our accessories can also do double-duty in the kitchen.

Position a towel bar or towel ring beside the kitchen sink or on a kitchen island. Place a hook to hang potholders. Install a decorative shelf to house spices. And don't forget matching drawer knobs and pulls that help you carry the style throughout the workspace.

Kitchen complements is about creating a kitchen without compromise. Moen offers exceptional products that deliver all the style and functionality you need in a dream kitchen — with the convenience of getting it all from one trusted brand. That means a guaranteed style compatibility, quality and satisfaction.



MASON® Coordinating Bath Accessories

Moen® bath accessories CANNOT be combined with Moen faucet parts on a Purchase Order.

COORDINATING ACCESSORIES

Perfectly suited styles for a cohesive look. From robe hooks to towel bars, Moen offers a wide range of coordinating accessories to complete any room.

MODEL NUMBER	LIST EACH	DESCRIPTION	QTY
Chrome (CH)			
YB8000CH	6.10	Mounting Posts (Pair)	50
YB8003CH	5.35	Double Robe Hook	50
YB8086CH	10.10	Towel Ring	50
YB8094CH	5.10	24" Towel Bar (Bar Only)	50
YB8098CH	4.40	18" Towel Bar (Bar Only)	50
YB8099CH	2.15	Paper Holder (Roller Only)	50
Brushed Chrome (BC)			
YB8000BC	7.80	Mounting Posts (Pair)	50
YB8003BC	6.85	Double Robe Hook	50
YB8086BC	13.30	Towel Ring	50
YB8094BC	6.60	24" Towel Bar (Bar Only)	50
YB8098BC	5.55	18" Towel Bar (Bar Only)	50
YB8099BC	3.60	Paper Holder (Roller Only)	50
Satin Nickel (SN)			
YB8000SN	10.10	Mounting Posts (Pair)	50
YB8003SN	7.00	Double Robe Hook	50
YB8086SN	14.45	Towel Ring	50
YB8094SN	8.35	24" Towel Bar (Bar Only)	50
YB8098SN	6.75	18" Towel Bar (Bar Only)	50
YB8099SN	3.25	Paper Holder (Roller Only)	50
Old World Bronze (OWB)			
YB8000OWB	13.10	Mounting Posts (Pair)	50
YB8003OWB	8.00	Double Robe Hook	50
YB8086OWB	15.45	Towel Ring	50
YB8094OWB	10.35	24" Towel Bar (Bar Only)	50
YB8098OWB	7.80	18" Towel Bar (Bar Only)	50
YB8099OWB	2.75	Paper Holder (Roller Only)	50
N/A or Unfinished			
YB8081	15.20	Pro-Fit Installation Mounting Template	25

COORDINATING ACCESSORIES



Double Robe Hook
YB8003



Towel Ring
YB8086



Paper Holder (Roller only)
YB8099



Pro-Fit® Installation Mounting Template

YB8081
(See page 528 for more information about the Pro-Fit® Installation System.)

+
Mounting Posts (Pair)
YB8000



18" Towel Bar (bar only)
YB8098

24" Towel Bar (bar only)
YB8094

+
Mounting Posts (Pair)
YB8000

RETREAT® Coordinating Bath Accessories

Moen® bath accessories CANNOT be combined with Moen faucet parts on a Purchase Order.

COORDINATING ACCESSORIES

Perfectly suited styles for a cohesive look. From robe hooks to towel bars, Moen offers a wide range of coordinating accessories to complete any room.

MODEL NUMBER	LIST EACH	DESCRIPTION	QTY
Chrome (CH)			
DN8303CH	18.05	Single Robe Hook	24
Ⓟ DN8308CH	34.65	Pivoting Paper Holder	3
DN8318CH	35.40	18" Towel Bar	3
DN8322CH	58.50	24" Double Towel Bar	3
DN8324CH	38.40	24" Towel Bar	3
DN8386CH	25.00	Towel Ring	3
DN8390CH	65.35	Vanity Shelf	3
Brushed Nickel (BN)			
DN8303BN▲	20.25	Single Robe Hook	24
Ⓟ DN8308BN▲	38.60	Pivoting Paper Holder	3
DN8318BN▲	39.60	18" Towel Bar	3
DN8322BN▲	65.35	24" Double Towel Bar	3
DN8324BN▲	42.95	24" Towel Bar	3
DN8386BN▲	27.95	Towel Ring	3
DN8390BN▲	72.85	Vanity Shelf	3

Product Details

5/8" Round Bar

30" Towel Bar options also available in select finishes.

See page 511 for details.



Single Robe Hook
DN8303



Towel Ring
DN8386



Pivoting Paper Holder
DN8308 | Ⓟ



18" Towel Bar
DN8318

24" Towel Bar
DN8324



24" Double Towel Bar
DN8322



Vanity Shelf
DN8390

COORDINATING ACCESSORIES

▲ Retail Packaging

Ⓟ Denotes pivoting paper holder and mirror

List price is per each (unless otherwise noted).

Product can be ordered by case quantity or individually.

ARLYS™ Coordinating Bath Accessories

Moen® bath accessories CANNOT be combined with Moen faucet parts on a Purchase Order.

COORDINATING ACCESSORIES

Perfectly suited styles for a cohesive look. From robe hooks to towel bars, Moen offers a wide range of coordinating accessories to complete any room.

MODEL NUMBER	LIST EACH	DESCRIPTION	QTY
Chrome (CH)			
Y5703CH▲	18.00	Double Robe Hook	12
Y5708CH▲	24.00	Paper Holder	3
Y5709CH▲	28.65	Single-Post Paper Holder	3
Y5718CH▲	39.20	18" Towel Bar	3
Y5722CH▲	64.00	24" Double Towel Bar	3
Y5724CH▲	41.00	24" Towel Bar	3
Y5785CH▲	24.00	Towel Ring	3
Y5786CH▲	24.50	Hand Towel Bar	3
Y5788CH▲	42.45	Double Paper Holder	3
Y5794CH▲	193.10	Towel Shelf	2
Brushed Nickel (BN)			
Y5703BN▲	22.50	Double Robe Hook	12
Y5708BN▲	30.00	Paper Holder	3
Y5709BN▲	35.80	Single-Post Paper Holder	3
Y5718BN▲	49.00	18" Towel Bar	3
Y5722BN▲	80.00	24" Double Towel Bar	3
Y5724BN▲	51.25	24" Towel Bar	3
Y5785BN▲	29.10	Towel Ring	3
Y5786BN▲	29.65	Hand Towel Bar	3
Y5788BN▲	53.05	Double Paper Holder	3
Y5794BN▲	204.90	Towel Shelf	2
Matte Black (BL)			
Y5703BL▲	23.40	Double Robe Hook	12
Y5708BL▲	31.25	Paper Holder	3
Y5709BL▲	37.25	Single-Post Paper Holder	3
Y5718BL▲	51.00	18" Towel Bar	3
Y5722BL▲	83.30	24" Double Towel Bar	3
Y5724BL▲	53.45	24" Towel Bar	3
Y5785BL▲	31.25	Towel Ring	3
Y5786BL▲	31.85	Hand Towel Bar	3
Y5788BL▲	55.20	Double Paper Holder	3
Y5794BL▲	232.20	Towel Shelf	2

COORDINATING ACCESSORIES



Double Robe Hook
Y5703



Towel Ring
Y5785



Paper Holder
Y5708



Single-Post Paper Holder
Y5709



Double Paper Holder
Y5788



Hand Towel Bar
Y5786



18" Towel Bar
Y5718



24" Double Towel Bar
Y5722

24" Towel Bar
Y5724



Towel Shelf
Y5794

▲ **Retail Packaging**

List price is per each (unless otherwise noted).
Product can be ordered by case quantity or individually.

TRIVA™ Coordinating Bath Accessories

Moen® bath accessories CANNOT be combined with Moen faucet parts on a Purchase Order.

COORDINATING ACCESSORIES

Perfectly suited styles for a cohesive look. From robe hooks to towel bars, Moen offers a wide range of coordinating accessories to complete any room.

MODEL NUMBER	LIST EACH	DESCRIPTION	QTY
Chrome (CH)			
BP1803CH	18.00	Single Robe Hook	24
BP1808CH	28.65	Single-Post Paper Holder	6
BP1818CH	39.20	18" Towel Bar	6
BP1822CH	64.00	24" Double Towel Bar	6
BP1824CH	41.00	24" Towel Bar	6
BP1886CH	24.50	Hand Towel Bar	6
BP1888CH	42.45	Single-Post Double Paper Holder	6
BP1892CH	252.05	Mirror	1
Brushed Nickel (BN)			
BP1803BN	22.50	Single Robe Hook	24
BP1808BN	35.80	Single-Post Paper Holder	6
BP1818BN	49.00	18" Towel Bar	6
BP1822BN	80.00	24" Double Towel Bar	6
BP1824BN	51.25	24" Towel Bar	6
BP1886BN	29.65	Hand Towel Bar	6
BP1888BN	53.05	Single-Post Double Paper Holder	6
BP1892BN	308.35	Mirror	1
Matte Black (BL)			
BP1803BL	23.40	Single Robe Hook	24
BP1808BL	37.25	Single-Post Paper Holder	6
BP1818BL	51.00	18" Towel Bar	6
BP1822BL	83.30	24" Double Towel Bar	6
BP1824BL	53.45	24" Towel Bar	6
BP1886BL	31.85	Hand Towel Bar	6
BP1888BL	55.20	Single-Post Double Paper Holder	6
BP1892BL	327.40	Mirror	1

**Single Robe Hook**

BP1803

**Hand Towel Bar**

BP1886

**Paper Holder-Single Post**

BP1808

**Double Paper Holder-Single Post**

BP1888

**18" Towel Bar**

BP1818

**24" Double Towel Bar**

BP1822

24" Towel bar

BP1824

**Rectangular Mirror**

BP1892

COORDINATING
ACCESSORIES

List price is per each (unless otherwise noted).

Product can be ordered by case quantity or individually.

SAGE® Coordinating Bath Accessories

Moen® bath accessories CANNOT be combined with Moen faucet parts on a Purchase Order.

COORDINATING ACCESSORIES

Perfectly suited styles for a cohesive look. From robe hooks to towel bars, Moen offers a wide range of coordinating accessories to complete any room.

COORDINATING ACCESSORIES

MODEL NUMBER	LIST EACH	DESCRIPTION	QTY
--------------	-----------	-------------	-----

Chrome (CH)

DN6801CH	21.85	Tank Lever	3 ▲
DN6803CH	13.60	Single Robe Hook	3 ▲
Ⓟ DN6808CH	25.95	Pivoting Paper Holder	3 ▲
DN6818CH	30.35	18" Towel Bar	3 ▲
DN6824CH	32.95	24" Towel Bar	3 ▲
DN6886CH	21.45	Towel Ring	3 ▲

Brushed Nickel (BN)

DN6801BN	33.20	Tank Lever	12 ▲
DN6803BN	22.25	Single Robe Hook	12 ▲
Ⓟ DN6808BN	34.60	Pivoting Paper Holder	3 ▲
DN6818BN	40.90	18" Towel Bar	3 ▲
DN6822BN	67.50	24" Double Towel Bar	3 ▲
DN6824BN	44.40	24" Towel Bar	3 ▲
DN6850BN	66.00	Freestanding Paper Holder	2 ▲
DN6886BN	31.00	Towel Ring	3 ▲
DN6890BN	65.60	Vanity Shelf	3 ▲
Ⓟ DN6892BN	127.35	Pivoting Mirror	3 ▲

Oil Rubbed Bronze (ORB)

DN6801ORB	36.60	Tank Lever	12 ▲
DN6803ORB	22.50	Single Robe Hook	12 ▲
Ⓟ DN6808ORB	38.25	Pivoting Paper Holder	3 ▲
DN6818ORB	42.50	18" Towel Bar	3 ▲
DN6824ORB	46.20	24" Towel Bar	3 ▲
DN6886ORB	31.35	Towel Ring	3 ▲

Product Details

5/8" Round Bar

30" Towel Bar options also available in select finishes.

See page 511 for details.



Tank Lever

DN6801



Single Robe Hook

DN6803



Towel Ring

DN6886



Paper Holder

DN6808 | Ⓟ



Freestanding Paper Holder (BN Only)

DN6850



18" Towel Bar

DN6818

24" Towel Bar

DN6824



24" Double Towel Bar (BN Only)

DN6822



Vanity Shelf (BN Only)

DN6890



Pivoting Mirror (BN Only)

DN6892 | Ⓟ

▲ Retail Packaging

Ⓟ Denotes pivoting paper holder and mirror

List price is per each (unless otherwise noted).

Product can be ordered by case quantity or individually.

Moen® bath accessories CANNOT be combined with Moen faucet parts on a Purchase Order.

COORDINATING ACCESSORIES

Perfectly suited styles for a cohesive look. From robe hooks to towel bars, Moen offers a wide range of coordinating accessories to complete any room.

MODEL NUMBER	LIST EACH	DESCRIPTION	QTY
Chrome (CH)			
DN0703CH	25.90	Single Robe Hook	12
DN0705CH	11.15	Drawer Knob	48
DN0707CH	22.30	Drawer Pull	48
☞ DN0708CH	51.00	Pivoting Paper Holder	3
DN0709CH	46.85	Single-Post Paper Holder	3
DN0718CH	46.90	18" Towel Bar	3
DN0722CH	76.50	24" Double Towel Bar	3
DN0724CH	51.00	24" Towel Bar	3
DN0786CH	33.10	Towel Ring	3
DN0790CH	92.45	Vanity Shelf	3
☞ DN0792CH	123.75	Pivoting Mirror	3
DN0794CH	216.45	Towel Shelf	2
Brushed Nickel (BN)			
DN0703BN	29.10	Single Robe Hook	24
DN0705BN	13.05	Drawer Knob	48
DN0707BN	24.00	Drawer Pull	48
☞ DN0708BN	57.45	Pivoting Paper Holder	3
DN0709BN	52.45	Single-Post Paper Holder	3
DN0718BN	54.30	18" Towel Bar	3
DN0722BN	85.85	24" Double Towel Bar	3
DN0724BN	59.15	24" Towel Bar	3
DN0786BN	40.20	Towel Ring	3
DN0790BN	104.10	Vanity Shelf	3
☞ DN0792BN	139.25	Pivoting Mirror	3
DN0794BN	234.05	Towel Shelf	2
Brushed Gold (BG)			
DN0705BG	15.65	Drawer Knob	48
DN0707BG	28.75	Drawer Pull	48
Matte Black (BL)			
DN0703BL	32.10	Single Robe Hook	12 ▲
DN0705BL	13.55	Drawer Knob	48
DN0707BL	26.95	Drawer Pull	48
☞ DN0708BL	63.20	Pivoting Paper Holder	3 ▲
DN0709BL	57.70	Single-Post Paper Holder	3 ▲
DN0718BL	59.70	18" Towel Bar	3 ▲
DN0722BL	94.45	24" Double Towel Bar	3 ▲
DN0724BL	65.10	24" Towel Bar	3 ▲
DN0786BL	44.25	Towel Ring	3 ▲
DN0790BL	114.50	Vanity Shelf	3 ▲
☞ DN0792BL	153.15	Pivoting Mirror	3 ▲
DN0794BL	257.45	Towel Shelf	2 ▲

Product Details

1/2" Round Bar

▲ Retail Packaging

☞ Denotes pivoting paper holder and mirror

List price is per each (unless otherwise noted).
 Product can be ordered by case quantity or individually.



Single Robe Hook
DN0703



Towel Ring
DN0786



Pivoting Paper Holder
DN0708 | ☞



Single-Post Paper Holder
DN0709



18" Towel Bar
DN0718
24" Towel Bar
DN0724



24" Double Towel Bar
DN0722



Drawer Knob
DN0705



Drawer Pull
DN0707



Towel Shelf
DN0794



Vanity Shelf
DN0790



Pivoting Mirror
DN0792 | ☞

COORDINATING ACCESSORIES

ISO™ Coordinating Bath Accessories (continued)

Moen® bath accessories CANNOT be combined with Moen faucet parts on a Purchase Order.





COORDINATING ACCESSORIES

Perfectly suited styles for a cohesive look. From robe hooks to towel bars, Moen offers a wide range of coordinating accessories to complete any room.

MODEL NUMBER	LIST EACH	DESCRIPTION	QTY
1½" • Chrome (CH)			
YG0712CH	84.45	12" Designer Grab Bar	6
YG0718CH	89.05	18" Designer Grab Bar	6
YG0724CH	93.65	24" Designer Grab Bar	6
YG0736CH	106.65	36" Designer Grab Bar	6
YG0742CH	130.00	42" Designer Grab Bar	6
1½" • Brushed Nickel (BN)			
YG0712BN	99.00	12" Designer Grab Bar	6
YG0718BN	104.00	18" Designer Grab Bar	6
YG0724BN	109.50	24" Designer Grab Bar	6
YG0736BN	124.50	36" Designer Grab Bar	6
YG0742BN	162.50	42" Designer Grab Bar	6
1½" • Matte Black (BL)			
YG0712BL	106.10	12" Designer Grab Bar	6
YG0718BL	112.00	18" Designer Grab Bar	6
YG0724BL	117.80	24" Designer Grab Bar	6
YG0736BL	134.10	36" Designer Grab Bar	6
YG0742BL	169.00	42" Designer Grab Bar	6

Product Details

1/2" Round Bar

**12" Designer Grab Bar**YG0712 | **18" Designer Grab Bar**YG0718 | **24" Designer Grab Bar**YG0724 | **36" Designer Grab Bar**YG0736 | **42" Designer Grab Bar**YG0742 | COORDINATING
ACCESSORIES
 ADA-Compliant

List price is per each (unless otherwise noted).

Product can be ordered by case quantity or individually.

Moen® bath accessories CANNOT be combined with Moen faucet parts on a Purchase Order.

COORDINATING ACCESSORIES

Perfectly suited styles for a cohesive look. From robe hooks to towel bars, Moen offers a wide range of coordinating accessories to complete any room.

MODEL NUMBER	LIST EACH	DESCRIPTION	QTY
Chrome (CH)			
BP3703CH▲	30.45	Double Robe Hook	24
BP3708CH▲	44.20	Paper Holder	6
BP3718CH▲	58.00	18" Towel Bar	6
BP3724CH▲	60.65	24" Towel Bar	6
BP3786CH▲	46.95	Towel Ring	6
Brushed Nickel (BN)			
BP3703BN	34.30	Double Robe Hook	24
BP3708BN	49.75	Paper Holder	6
BP3718BN	65.20	18" Towel Bar	6
BP3724BN	70.95	24" Towel Bar	6
BP3786BN	52.80	Towel Ring	6



Double Robe Hook
BP3703



Towel Ring
BP3786



Paper Holder
BP3708



18" Towel Bar
BP3718

24" Towel Bar
BP3724

COORDINATING ACCESSORIES



▲ **Retail Packaging**

List price is per each (unless otherwise noted).
 Product can be ordered by case quantity or individually.

LOUNGE™ Coordinating Bath Accessories

Moen® bath accessories CANNOT be combined with Moen faucet parts on a Purchase Order.

COORDINATING ACCESSORIES

Perfectly suited styles for a cohesive look. From robe hooks to towel bars, Moen offers a wide range of coordinating accessories to complete any room.

MODEL NUMBER	LIST EACH	DESCRIPTION	QTY
Chrome (CH)			
DN7703CH	15.85	Double Robe Hook	24
DN7708CH▲	29.45	European Paper Holder	3
DN7718CH▲	31.00	18" Towel Bar	3
DN7722CH▲	48.90	24" Double Towel Bar	3
DN7724CH▲	33.65	24" Towel Bar	3
DN7786CH▲	22.05	Towel Ring	3
DN7790CH▲	53.05	Vanity Shelf	3
Brushed Nickel (BN)			
DN7703BN▲	18.40	Double Robe Hook	24
DN7708BN▲	33.75	European Paper Holder	3
DN7718BN▲	35.65	18" Towel Bar	3
DN7722BN▲	56.20	24" Double Towel Bar	3
DN7724BN▲	38.75	24" Towel Bar	3
DN7786BN▲	25.30	Towel Ring	3
DN7790BN▲	61.05	Vanity Shelf	3

Product Details

5/8" Round Bar

30" Towel Bar options also available in select finishes.

See page 511 for details.

**Double Robe Hook**

DN7703

**Towel Ring**

DN7786

**European Paper Holder**

DN7708

**18" Towel Bar**

DN7718

24" Towel Bar

DN7724

**Double Towel Bar**

DN7722

**Vanity Shelf**

DN7790

COORDINATING ACCESSORIES

▲ Retail Packaging

List price is per each (unless otherwise noted).

Product can be ordered by case quantity or individually.

MADISON® Coordinating Bath Accessories

Moen® bath accessories CANNOT be combined with Moen faucet parts on a Purchase Order.

COORDINATING ACCESSORIES

Perfectly suited styles for a cohesive look. From robe hooks to towel bars, Moen offers a wide range of coordinating accessories to complete any room.

MODEL NUMBER	LIST EACH	DESCRIPTION	QTY
Chrome (CH)			
BP6903CH▲	12.55	Double Robe Hook	24
BP6908CH▲	27.70	Paper Holder	6
BP6918CH▲	28.95	18" Towel Bar	6
BP6924CH▲	31.95	24" Towel Bar	6
BP6980CH▲	23.25	European Paper Holder	6
BP6986CH▲	20.85	Towel Ring	6
Brushed Nickel (BN)			
BP6903BN	18.85	Double Robe Hook	24 NEW!
BP6908BN	37.40	Paper Holder	6 NEW!
BP6918BN	35.20	18" Towel Bar	6 NEW!
BP6924BN	42.20	24" Towel Bar	6 NEW!
BP6986BN	26.05	Towel Ring	6 NEW!
Old World Bronze (OWB)			
BP6903OWB	19.00	Double Robe Hook	24
BP6908OWB	37.35	Paper Holder	6
BP6918OWB	36.20	18" Towel Bar	6
BP6924OWB	42.20	24" Towel Bar	6
BP6980OWB	28.15	European Paper Holder	6
BP6986OWB	26.10	Towel Ring	6

Product Details

3/4" Round Bar

**Double Robe Hook**

BP6903

**Towel Ring**

BP6986

**Paper Holder**

BP6908

**European Paper Holder**

BP6980

**18" Towel Bar**

BP6918

24" Towel Bar

BP6924

**COORDINATING
ACCESSORIES**

▲ Retail Packaging

List price is per each (unless otherwise noted).

Product can be ordered by case quantity or individually.

PRESTON™ Coordinating Bath Accessories

Moen® bath accessories CANNOT be combined with Moen faucet parts on a Purchase Order.

COORDINATING ACCESSORIES

Perfectly suited styles for a cohesive look. From robe hooks to towel bars, Moen offers a wide range of coordinating accessories to complete any room.

MODEL NUMBER	LIST EACH	DESCRIPTION	QTY
Chrome (CH)			
DN8403CH▲	9.05	Double Robe Hook	12
DN8408CH▲	19.30	European Paper Holder	3
DN8418CH▲	25.15	18" Towel Bar	3
DN8422CH▲	41.50	24" Double Towel Bar	3
DN8424CH▲	26.95	24" Towel Bar	1
DN8486CH▲	17.30	Towel Ring	3
DN8490CH▲	45.40	Vanity Shelf	3
Brushed Nickel (BN)			
DN8403BN▲	13.50	Double Robe Hook	12
DN8408BN▲	26.60	European Paper Holder	3
DN8418BN▲	31.15	18" Towel Bar	3
DN8424BN▲	33.20	24" Towel Bar	3
DN8486BN▲	22.35	Towel Ring	3
Matte Black (BL)			
DN8403BL▲	16.70	Double Robe Hook	12
DN8408BL▲	29.00	European Paper Holder	3
DN8418BL▲	33.95	18" Towel Bar	3
DN8424BL▲	36.20	24" Towel Bar	3
DN8486BL▲	24.35	Towel Ring	3

Product Details
3/4" Round Bar



Double Robe Hook
DN8403



Towel Ring
DN8486



European Paper Holder
DN8408



18" Towel Bar
DN8418



**24" Double Towel Bar
(CH Only)**
DN8422



**Vanity Shelf
(CH Only)**
DN8490

COORDINATING ACCESSORIES

▲ **Retail Packaging**

List price is per each (unless otherwise noted).
Product can be ordered by case quantity or individually.

ASPEN™ Coordinating Bath Accessories

Moen® bath accessories CANNOT be combined with Moen faucet parts on a Purchase Order.

COORDINATING ACCESSORIES

Perfectly suited styles for a cohesive look. From robe hooks to towel bars, Moen offers a wide range of coordinating accessories to complete any room.

MODEL NUMBER	LIST EACH	DESCRIPTION	QTY
Chrome (CH)			
5802CH	6.05	Single Robe Hook	24
5808CH	13.60	Spring Loaded Paper Holder	3
5818CH	15.95	18" Towel Bar	3
5824CH	18.30	24" Towel Bar	3
5886CH	10.70	Towel Ring	3



Single Robe Hook
5802



Towel Ring
5886

Product Details

3/4" Round Bar



Spring Loaded Paper Holder
5808



18" Towel Bar
5818

24" Towel Bar
5824

COORDINATING ACCESSORIES



List price is per each (unless otherwise noted).
Product can be ordered by case quantity or individually.

KINGSLEY® Coordinating Bath Accessories

Moen® bath accessories CANNOT be combined with Moen faucet parts on a Purchase Order.

COORDINATING ACCESSORIES

Perfectly suited styles for a cohesive look. From robe hooks to towel bars, Moen offers a wide range of coordinating accessories to complete any room.

MODEL NUMBER	LIST EACH	DESCRIPTION	QTY
--------------	-----------	-------------	-----

Chrome (CH)

YB5403CH	38.55	Double Robe Hook	24
Ⓟ YB5408CH	70.45	Pivoting Paper Holder	6
YB5418CH	75.65	18" Towel Bar	6
YB5422CH	101.35	24" Double Towel Bar	6
YB5424CH	78.15	24" Towel Bar	6
YB5486CH	53.10	Towel Ring	6
YB5490CH	100.55	Vanity Shelf	3
YB5494CH	273.80	Towel Shelf	2

Brushed Nickel (BN)

YB5403BN	42.50	Double Robe Hook	24
Ⓟ YB5408BN	77.95	Pivoting Paper Holder	6
YB5418BN	83.25	18" Towel Bar	6
YB5422BN	109.30	24" Double Towel Bar	6
YB5424BN	86.20	24" Towel Bar	6
YB5486BN	58.15	Towel Ring	6
YB5490BN	108.10	Vanity Shelf	3
YB5494BN	301.80	Towel Shelf	2

Oil Rubbed Bronze (ORB)

YB5403ORB	46.60	Double Robe Hook	24
Ⓟ YB5408ORB	85.70	Pivoting Paper Holder	6
YB5418ORB	91.50	18" Towel Bar	6
YB5422ORB	120.25	24" Double Towel Bar	6
YB5424ORB	94.85	24" Towel Bar	6
YB5486ORB	63.95	Towel Ring	6
YB5490ORB	119.10	Vanity Shelf	3
YB5494ORB	331.95	Towel Shelf	2

Wrought Iron (WR)

YB5403WR	46.60	Double Robe Hook	24
Ⓟ YB5408WR	85.70	Pivoting Paper Holder	6
YB5418WR	91.50	18" Towel Bar	6
YB5422WR	120.25	24" Double Towel Bar	6
YB5424WR	94.85	24" Towel Bar	6
YB5486WR	63.95	Towel Ring	6
YB5490WR	128.60	Vanity Shelf	3

**Double Robe Hook**

YB5403

**Towel Ring**

YB5486

**Pivoting Paper Holder**

YB5408 | Ⓟ

**18" Towel Bar**

YB5418

24" Towel Bar

YB5424

**24" Double Towel Bar**

YB5422

**Towel Shelf**

YB5494

**Vanity Shelf**

YB5490

COORDINATING
ACCESSORIES

 ADA-Compliant

List price is per each (unless otherwise noted).

Product can be ordered by case quantity or individually.





KINGSLEY® Coordinating Bath Accessories

Moen® bath accessories CANNOT be combined with Moen faucet parts on a Purchase Order.

COORDINATING ACCESSORIES

Perfectly suited styles for a cohesive look. From robe hooks to towel bars, Moen offers a wide range of coordinating accessories to complete any room.

MODEL NUMBER	LIST EACH	DESCRIPTION	QTY
1½" • Chrome (CH)			
YG5412CH	137.05	12" Designer Grab Bar	3
YG5418CH	143.20	18" Designer Grab Bar	3
YG5424CH	149.55	24" Designer Grab Bar	3
YG5430CH	160.00	30" Designer Grab Bar	3
YG5436CH	170.25	36" Designer Grab Bar	3
YG5442CH	249.85	42" Designer Grab Bar	3
1½" • Brushed Nickel (BN)			
YG5412BN	165.70	12" Designer Grab Bar	3
YG5418BN	173.60	18" Designer Grab Bar	3
YG5424BN	187.45	24" Designer Grab Bar	3
YG5430BN	195.25	30" Designer Grab Bar	3
YG5436BN	210.90	36" Designer Grab Bar	3
YG5442BN	312.40	42" Designer Grab Bar	3
1½" • Oil Rubbed Bronze (ORB)			
YG5412ORB	182.20	12" Designer Grab Bar	3
YG5418ORB	191.20	18" Designer Grab Bar	3
YG5424ORB	206.30	24" Designer Grab Bar	3

**12" Designer Grab Bar**YG5412 | **18" Designer Grab Bar**YG5418 | **24" Designer Grab Bar**YG5424 | **30" Designer Grab Bar**YG5430 | **36" Designer Grab Bar**YG5436 | **42" Designer Grab Bar**YG5442 | 

**COORDINATING
ACCESSORIES**

Product Details

1/2" Round Bar



ADA-Compliant

List price is per each (unless otherwise noted).

Product can be ordered by case quantity or individually.

GILCREST® Coordinating Bath Accessories**Moen® bath accessories CANNOT be combined with Moen faucet parts on a Purchase Order.****COORDINATING ACCESSORIES**

Perfectly suited styles for a cohesive look. From robe hooks to towel bars, Moen offers a wide range of coordinating accessories to complete any room.

MODEL NUMBER	LIST EACH	DESCRIPTION	QTY
Oil Rubbed Bronze (ORB)			
Ⓟ DN0892ORB	122.05	Pivoting Mirror	3

**Pivoting Mirror**

DN0892 | Ⓟ

COORDINATING
ACCESSORIES

Ⓟ Denotes pivoting paper holder and mirror

List price is per each (unless otherwise noted).

Product can be ordered by case quantity or individually.

For more information on ordering Gilcrest bath accessories or other Moen bath accessories, contact Moen Bath Accessory Customer Service at **800-882-0116**, contact your local Moen sales representative, or visit us at www.moen.com.**GLENSHIRE®** Coordinating Bath Accessories**Moen® bath accessories CANNOT be combined with Moen faucet parts on a Purchase Order.****COORDINATING ACCESSORIES**

Perfectly suited styles for a cohesive look. From robe hooks to towel bars, Moen offers a wide range of coordinating accessories to complete any room.

MODEL NUMBER	LIST EACH	DESCRIPTION	QTY
Chrome (CH)			
Ⓟ DN2692CH	104.10	Pivoting Mirror	3
Brushed Nickel (BN)			
Ⓟ DN2692BN▲	109.05	Pivoting Mirror	3

**Pivoting Mirror**

DN2692 | Ⓟ

▲ Retail Packaging

Ⓟ Denotes pivoting paper holder and mirror

List price is per each (unless otherwise noted).

Product can be ordered by case quantity or individually.



Donner™ Straight Shower Rod

ALUMINUM ROD WITH ADJUSTABLE FLANGES - 1" DIAMETER				
MODEL	LIST PRICE	DESCRIPTION	FINISH	QTY
52-5	12.15	5 ft. Shower Rod Set - Chrome Plated Flanges	Chrome	50
52-6	13.70	6 ft. Shower Rod Set - Chrome Plated Flanges	Chrome	50
54-5	8.65	5 ft. Shower Rod Set - Chrome Plated Poly Flanges	Chrome	50
54-6	10.30	6 ft. Shower Rod Set - Chrome Plated Poly Flanges	Chrome	50
52-5-OWB	28.00	5 ft. Shower Rod Set - Plated Flanges	Old World Bronze	10

ALUMINUM ROD WITH NON-ADJUSTABLE FLANGES - 1" DIAMETER				
MODEL	LIST PRICE	DESCRIPTION	FINISH	QTY
63-5	11.95	5 ft. Shower Rod Set - Exposed Screw Chrome Plated Flanges	Chrome	50

Product Details

- Corrosion resistant
- Fits 72" x 72" shower curtains

HEAVY-DUTY STAINLESS STEEL RODS WITH ADJUSTABLE FLANGES - 1" DIAMETER				
MODEL	LIST PRICE	DESCRIPTION	FINISH	QTY
52-5-SS	19.25	5 ft. Shower Rod Set - Chrome Plated Flanges	Stainless Steel	10
52-5-BN	41.90	5 ft. Shower Rod Set - Chrome Plated Flanges	Brushed Nickel	10

HEAVY-DUTY STAINLESS STEEL RODS WITH NON-ADJUSTABLE FLANGES - 1" DIAMETER				
MODEL	LIST PRICE	DESCRIPTION	FINISH	QTY
55-5	49.80	5 ft. Shower Rod Set - Concealed Screw Brushed Stainless Steel Flanges	Polished Stainless	50
58-5	48.05	5 ft. Shower Rod Set - Exposed Screw Brushed Stainless Steel Flanges	Polished Stainless	50
61-5-SS	16.00	5 ft. Shower Rod Set - Concealed Screw Chrome Flanges	Stainless Steel	50
63-5-HD	43.20	5 ft. Fluted Shower Rod Set - Exposed Screw Chrome Flanges	Satin	50
63-5-SS	19.05	5 ft. Shower Rod Set - Exposed Screw Chrome Flanges	Satin	50

Product Details

- Corrosion resistant
- Fits 72" x 72" shower curtains
- 52-5, 55-5 and 61-5-SS: Decorative cover to conceal mounting hardware

52-5 52-6
54-5 54-6

55-5



58-5



61-5



63-5

Donner™ Build-Your-Own Straight Shower Rod

COORDINATING ACCESSORIES

STEP #1 : PICK YOUR ROD - ALUMINUM OR STAINLESS - 1" DIAMETER

MODEL	LIST PRICE	DESCRIPTION	FINISH	QTY
2-100-5A	7.10	5 ft. Shower Rod Only - Smooth Aluminum	Chrome	50
2-100-6A	8.85	6 ft. Shower Rod Only - Smooth Aluminum	Chrome	50
2-100-5SS	38.40	5 ft. Shower Rod Only - Polished Stainless Steel 0.35 guage	Stainless Steel	25
2-10155SS	14.40	5 ft. Shower Rod Only - Polished Stainless Steel 0.15 guage	Stainless Steel	25
2-100-6SS	42.45	6 ft. Shower Rod Only - Polished Stainless Steel 0.35 guage	Stainless Steel	25 NEW!
2-10156SS	21.50	6 ft. Shower Rod Only - Polished Stainless Steel 0.15 guage	Stainless Steel	25 NEW!



Aluminum Rods



**Polished
Stainless Steel Rods**

STEP #2 : PICK YOUR FLANGE

MODEL	LIST PRICE	DESCRIPTION	FINISH	QTY
52-F	4.95	Chrome-Plated Adjustable Flange	Chrome	200
54-F	1.50	Chrome-Plated Poly Adjustable Flange	Chrome	200
61-F	1.80	Concealed Screw Flange	Chrome	200
63-F	4.80	Exposed Screw Flange	Chrome	200
55-F	11.45	Concealed Screw Flange	Stainless	50
58-F	9.65	Exposed Screw Flange	Stainless	50



52-F
Chrome-Plated
Adjustable Flange
Shower Rod Flanges Only



54-F
Chrome-Plated
Poly Adjustable Flange
Shower Rod Flanges Only



61-F
Chrome Concealed Flange
Shower Rod Flanges Only



63-F
Chrome Exposed Flange
Shower Rod Flanges Only



55-F
Brushed Stainless Steel
Concealed Flange
Shower Rod Flanges Only



58-F
Brushed Stainless Steel
Exposed Flange
Shower Rod Flanges Only

Donner™ Contemporary

DONNER CONTEMPORARY

MODEL	LIST PRICE	DESCRIPTION	FINISH	QTY
3CH	4.95	Chrome Finished Metal Roller Only	Chrome	200
3W	0.30	Chrome Finished Metal Roller Only	Glacier	250
23418A	1.85	18" Aluminum Towel Bar Only	Chrome	50
23424A	2.30	24" Aluminum Towel Bar Only	Chrome	50
23430A	2.95	24" Aluminum Towel Bar Only	Chrome	50
P5030	2.65	Double Robe Hook	Chrome	100
P5050	5.25	Paper Holder with Chrome Roller	Chrome	100
P5080	4.45	Paper Holder with White Roller	Chrome	100
P5100	4.40	3/4" Chrome Towel Bar Posts for Square Bars (Pair)	Chrome	100
P5118	5.95	18" Towel Bar with Aluminum Bar	Chrome	50
P5124	6.75	24" Towel Bar with Aluminum Bar	Chrome	50
P5340	3.30	Wallmount Toothbrush Holder	Chrome	100
P5360	3.95	Wallmount Soap Holder	Chrome	100
P5500	4.65	Towel Ring / Lucite Ring	Chrome	100
P5860	5.50	Towel Ring / Chrome Ring	Chrome	100
P5030BN	5.20	Double Robe Hook	Brushed Nickel	100
P5050BN	11.95	Paper Holder with Chrome Roller	Brushed Nickel	100
P5080BN	9.80	Paper Holder with White Roller	Brushed Nickel	100
P5118BN	12.95	18" Towel Bar	Brushed Nickel	36
P5124BN	14.35	24" Towel Bar	Brushed Nickel	36
P5130BN	15.45	30" Towel Bar	Brushed Nickel	36
P5860BN	10.35	Towel Ring / Metal Ring	Brushed Nickel	100

COORDINATING ACCESSORIES



23418A
18" Aluminum Towel Bar Only



P5100
3/4" Chrome Towel Bar Posts for Square Bars (Pair)



P5080
Paper Holder, White Roller



P5340
Wallmount Toothbrush Holder



P5360
Wallmount Soap Holder



23424A
24" Aluminum Towel Bar Only



P5118
18" Towel Bar Set with 3/4" Square Bar



3CH
Paper Holder Metal Roller, Chrome Finish



P5050
Paper Holder, Chrome Roller



P5500
Towel Ring/ Lucite Ring



23430A
30" Aluminum Towel Bar Only



P5124
24" Towel Bar Set with 3/4" Square Bar



3W
Paper Holder Plastic Roller, Glacier Finish



P5030
Double Robe Hook



P5860
Towel Ring/ Metal Ring



P5130BN
30" Towel Bar

Donner™ Stainless Steel

DONNER STAINLESS STEEL				
MODEL	LIST PRICE	DESCRIPTION	FINISH	QTY
23418SS	3.40	18" Towel Bar Only	Stainless	50
23424SS	4.55	24" Towel Bar Only	Stainless	50
23430SS	5.90	30" Towel Bar Only	Stainless	50
P1700	16.00	3/4" Towel Bar Posts (Pair)	Stainless	100
P1703	7.40	Double Robe Hook	Stainless	100
P1718	18.70	18" Towel Bar	Stainless	50
P1724	19.60	24" Towel Bar	Stainless	50
P1780	16.75	Paper Holder with Plastic Roller	Stainless	50
P1786	12.80	Towel Ring	Stainless	100



23418SS

18" Stainless Steel Bar Only



23424SS

24" Stainless Steel Bar Only



23430SS

30" Stainless Steel Bar Only

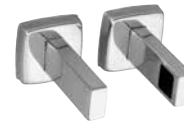

P1700

3/4" Stainless Steel Towel Bar Posts (Pair)



P1703

Double Robe Hook



P1718

18" Towel Bar Set



P1724

24" Towel Bar Set



P1780

Paper Holder, Plastic Roller



P1786

Towel Ring

COORDINATING ACCESSORIES

Donner™ Economy Metal

DONNER ECONOMY METAL				
MODEL	LIST PRICE	DESCRIPTION	FINISH	QTY
902	1.95	Single Robe Hook	Chrome	50
908	3.60	Paper Holder with White Roller	Chrome	100
910	3.35	5/8" Square Towel Bar Posts (Pairs)	Chrome	100
910A18	4.65	18" Towel Bar with Aluminum Bar	Chrome	24
910A24	5.20	24" Towel Bar with Aluminum Bar	Chrome	24
950	3.65	Towel Ring / Lucite Ring	Chrome	200

COORDINATING ACCESSORIES



902
Single Robe Hook



908
Paper Holder,
White Roller



910
5/8" Square
Towel Bar Posts
(Pair)



910A18
910A24
18" and 24" Towel Bar
Set with Aluminum Bar



950
Towel Ring/
Lucite Ring

DONNER HOTEL/MOTEL

MODEL	LIST PRICE	DESCRIPTION	FINISH	QTY
R5519	55.50	Stainless Steel 24" Towel Shelf with Extra Bar and Support Bracket (Towel Shelves have chrome-plated brackets with polished stainless steel rods)	Chrome	10
YB0275CH	81.70	Corner Shower Basket	Chrome	6
YB0275BN	89.90	Corner Shower Basket	Brushed Nickel	6
YB0275BL	99.40	Corner Shower Basket	Matte Black	6
RR5520SS	23.35	Recessed Facial Tissue Box, Chrome Finished Fits Wall Opening 10-1/2" x 5" x 2-1/4"	Stainless	24
5520NC	14.70	Recessed Coverless Facial Tissue Box, Fits Wall opening 10-1/2" x 5" x 2-1/4"	Chrome	24
5571	28.65	Recessed Paper Holder - Holds Extra Roll with White Roller, Overall Dimensions 6-1/4" x 6-1/4" - Wall Opening 5-1/4" x 5-1/4" x 4"	Chrome	20
5577	51.25	Recessed Double Paper Holder with Chrome Roller, Horizontal, Overall Dimensions 12-1/2" x 6-1/4" - Wall Opening 11-3/8" x 5-1/4" x 1-1/2"	Chrome	20
RR5506HD	28.00	Heavy Duty Retractable Clothesline, Length 7'6"	Polished Stainless Steel	60
RR5506HDBN	30.75	Heavy Duty Retractable Clothesline, Length 7'6"	Brushed Nickel	60 <small>NEW!</small>
RR5506HDOWB	33.30	Heavy Duty Retractable Clothesline, Length 7'6"	Old World Bronze	60
RR5506HDBL	32.95	Heavy Duty Retractable Clothesline, Length 7'6"	Matte Black	60 <small>NEW!</small>

COORDINATING ACCESSORIES



R5519
24" Towel Shelf with
Extra Bar & Support Bracket



YB0275
Corner Shower Basket



5571
Extra Roll Recessed
Paper Holder



5577
Double Recessed
Paper Holder, Horizontal



RR5520SS
Recessed Tissue Box



5520NC
Recessed Coverless
Tissue Box



RR5506HD
Heavy-Duty Retractable
Clothesline - Polished
Stainless Steel

Donner™ Recessed Fixtures

DONNER RECESSED FIXTURES				
MODEL	LIST PRICE	DESCRIPTION	FINISH	QTY
575	35.80	Paper Holder with Chrome Roller*	Chrome	20
2565CH	19.85	Soap Holder and Utility Bar*	Chrome	36
2575	19.60	Recessed Paper Holder with Matching Roller*	Chrome	36
DN5075	24.00	Recessed Paper Holder - Includes 588 Installation Clamp	Chrome	3
1576SS	12.65	Paper Holder with White Roller*	Stainless	40
DN5075W	24.00	Recessed Paper Holder - Included 588 Installation Clamp	Glacier	3

COORDINATING ACCESSORIES



575
Paper Holder,
Chrome Roller*



2565CH
Soap Holder
and Utility Bar*



2575
Recessed Paper
Holder,
Matching Roller*



DN5075
Recessed
Paper Holder



1576SS
Paper Holder,
White Roller,
Stainless Steel
Finish*



DN5075W
Recessed
Paper Holder

DONNER HARDWARE				
MODEL	LIST PRICE	DESCRIPTION	FINISH	QTY
588	4.25	C-Clamp (Boxed)	Chrome	80
BR587	5.00	Clamp with Retaining Spring (Box)	N/A	72



588
Installation
C-Clamp (Boxed)



BR587
Installation
Clamp with
Retaining
Spring (Boxed)

*Clamps must be ordered separately.

List price is per each (unless otherwise noted). Product can be ordered by case quantity or individually.

Moen® bath accessories CANNOT be combined with Moen faucet parts on a Purchase Order.

COORDINATING ACCESSORIES

30" TOWEL BAR ONLY - 5/8" DIAMETER			
MODEL NUMBER	LIST EACH	FINISH	QTY
DN9830CH	6.10	Chrome	50
DN9830SN	10.10	Satin Nickel	50
DN9830BN	10.75	Brushed Nickel	50
DN9830BL	9.20	Matte Black	50



30" Towel Bar Only

DN9830

Product Details

- To complete the 30" towel bar set, you must order both a 30" towel bar only and an 18" towel bar (or post only, if available)
- Constructed of aluminum

List price is per each (unless otherwise noted).
Product can be ordered by case quantity or individually.

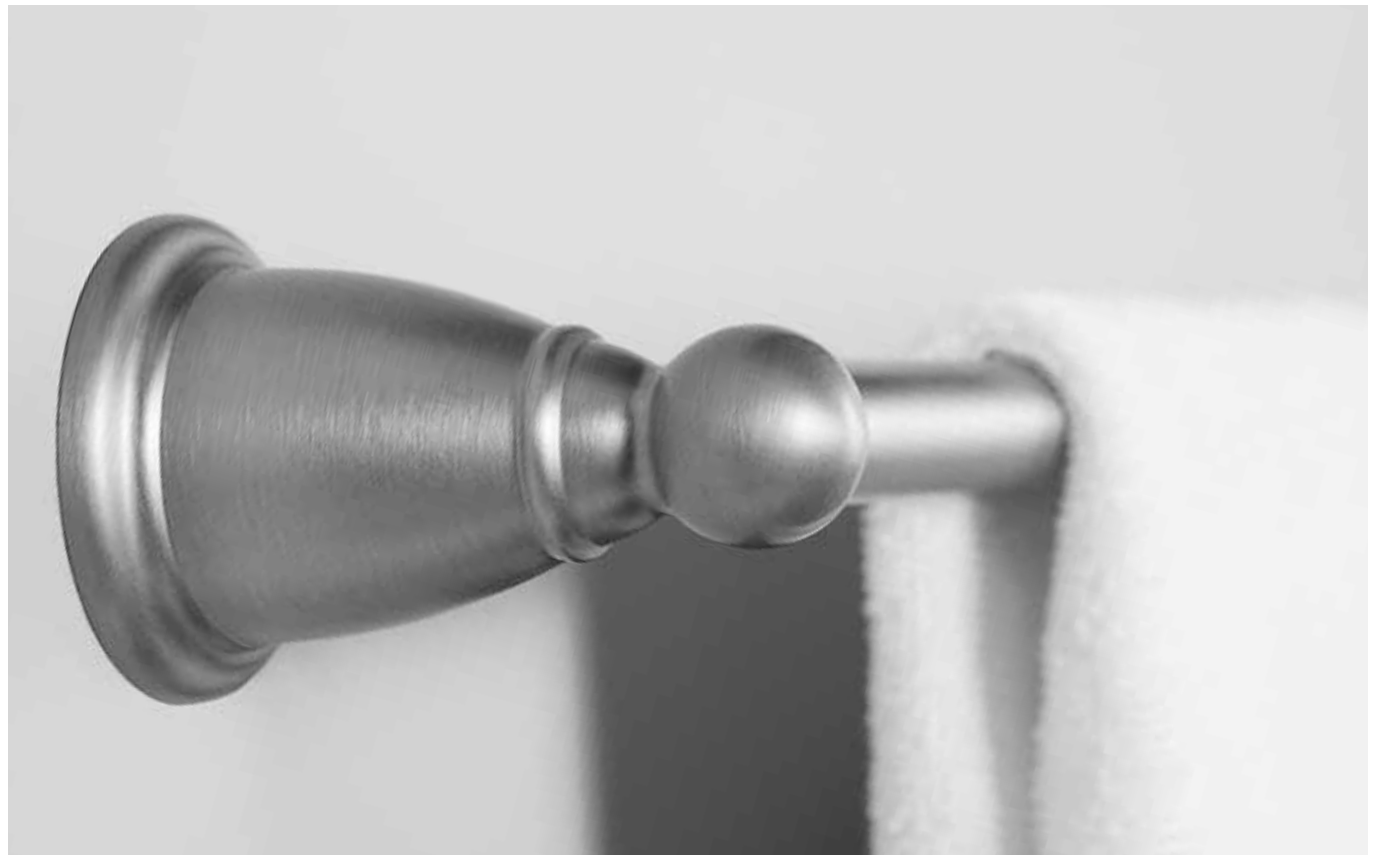

**COORDINATING
ACCESSORIES**

SHOWER RODS AND RINGS



Add an elegant and luxurious look while also creating a more comfortable experience in the bath with a choice of shower rods and rings. Moen rods and rings are available in several of today's most popular finishes. These rods are featured in straight and curved styles giving you the room you need in the shower.

COORDINATING ACCESSORIES

- Double Curved**
- Adjustable Curved**
- Fixed Length**
- Tension Curved**
- Decorative Tension**
- Shower Rings**



ADJUSTABLE DOUBLE CURVED SHOWER RODS			
MODEL	LIST PRICE	FINISH	QTY
DN2141CH▲	85.50	Chrome	2
DN2141BN▲	86.20	Brushed Nickel	2
DN2141OWB▲	108.45	Old World Bronze	2
DN2141BL	111.20	Matte Black	6



Double Curved Shower Rod
DN2141

Product Details

- 430 Stainless Steel
- Provides up to 5.5" more elbow room in the shower
- Adjusts from 57" to 60"
- Corrosion-resistant
- Drywall anchors included
- Works with standard 72" x 72" shower curtains

▲ Retail Packaging

Shower curtains and shower curtain rings are not included with shower curtain rods. Moen® shower curtain rings can be purchased separately. See page 517. List price is per each (unless otherwise noted). Product can be ordered by case quantity or individually.

Shower Rods and Rings

ADJUSTABLE CURVED SHOWER RODS

MODEL	LIST PRICE	FINISH	QTY
CSR2160CH	68.00	Chrome	10
CSR2160BN	69.25	Brushed Nickel	10
CSR2160BG	99.85	Brushed Gold	10
CSR2160NL	136.05	Polished Nickel	10
CSR2160OWB	85.55	Old World Bronze	10
CSR2160BL	102.05	Matte Black	10
CSR2164CH	69.50	Chrome	10
CSR2164BN	76.50	Brushed Nickel	10
CSR2164BG	107.00	Brushed Gold	10
CSR2164OWB	87.45	Old World Bronze	10
CSR2164BL	104.35	Matte Black	10



Adjustable Curved Shower Rod
CSR2160



Adjustable Curved Shower Rod
CSR2164

Product Details

- 304 Stainless Steel
- Adjusts between 54" to 72"
- Weight load capacity of 120 lbs. (based on independent lab testing)
- Mounting flange pivots 180 degrees for easy installation
- Corrosion-resistant
- Drywall anchors included
- No cutting required

ADJUSTABLE CURVED SHOWER RODS - LOW PROFILE

MODEL	LIST PRICE	FINISH	QTY
CSR2169CH	64.70	Chrome	10 NEW!
CSR2169BN	71.30	Brushed Nickel	10 NEW!
CSR2169BL	93.20	Matte Black	10 NEW!



Low-Profile Adjustable Curved Shower Rod
CSR2169

Product Details

- 304 Stainless Steel
- Adjusts between 40" to 72"
- Weight load capacity of 120 lbs. (based on independent lab testing)
- Mounting flange pivots 180 degrees for easy installation
- Corrosion-resistant
- Drywall anchors included
- No cutting required

COORDINATING ACCESSORIES

Shower Rods and Rings

FIXED-LENGTH DECORATIVE CURVED SHOWER ROD SET - PIVOTING

MODEL	LIST PRICE	DESCRIPTION	FINISH	QTY
CSR2165CH	53.75	5 ft. Shower Rod Set	Chrome	10
CSR2165BN	57.60	5 ft. Shower Rod Set	Brushed Nickel	10
CSR2165BL	67.20	5 ft. Shower Rod Set	Matte Black	10
CSR2165OWB	69.15	5 ft. Shower Rod Set	Old World Bronze	10
CSR2166CH	61.50	6 ft. Shower Rod Set	Chrome	10
CSR2166BN	66.15	6 ft. Shower Rod Set	Brushed Nickel	10



**Fixed-Length
Decorative Curved
Shower Rod -
Pivoting Flanges**
CSR2165 / CSR2166

FIXED-LENGTH DECORATIVE CURVED SHOWER ROD SET - NON-PIVOTING

MODEL	LIST PRICE	DESCRIPTION	FINISH	QTY
CSR2155CH	60.55	5 ft. Shower Rod Set	Chrome	10
CSR2155BN	64.60	5 ft. Shower Rod Set	Brushed Nickel	10
CSR2155OWB	76.35	5 ft. Shower Rod Set	Old World Bronze	10



**Fixed-Length
Decorative Curved
Shower Rod -
Non-Pivoting Flanges**
CSR2155

Product Details

- Provides extra elbow room in the shower
- Corrosion-resistant
- Drywall anchors included
- CSR2165 | CSR2166 : Mounting flange pivots 180 degrees for easy installation

FIXED-LENGTH DECORATIVE STRAIGHT SHOWER ROD SET

MODEL	LIST PRICE	DESCRIPTION	FINISH	QTY
SF2143CH	32.55	5 ft. Low-Profile Shower Rod Set	Chrome	10
SF2143BN	34.90	5 ft. Low-Profile Shower Rod Set	Brushed Nickel	10
SF2143BL	38.35	5 ft. Low-Profile Shower Rod Set	Matte Black	10



**Fixed-Length
Decorative Straight
Shower Rod**
SF2143

FIXED-LENGTH LOW PROFILE SHOWER ROD SET - PIVOTING

MODEL	LIST PRICE	DESCRIPTION	FINISH	QTY
CSR2167CH	52.85	5 ft. Low-Profile Shower Rod Set	Chrome	10
CSR2167BN	61.65	5 ft. Low-Profile Shower Rod Set	Brushed Nickel	10
CSR2167BL	76.15	5 ft. Low-Profile Shower Rod Set	Matte Black	10



**Fixed-Length
Low-Profile Curved
Shower Rod - Pivoting**
CSR2167

FIXED-LENGTH LOW PROFILE SHOWER ROD SET - NON-PIVOTING

MODEL	LIST PRICE	DESCRIPTION	FINISH	QTY
CSR2145CH	55.50	5 ft. Low-Profile Shower Rod Set	Chrome	10
CSR2145BN	64.75	5 ft. Low-Profile Shower Rod Set	Brushed Nickel	10
CSR2145BL	69.35	5 ft. Low-Profile Shower Rod Set	Matte Black	10



**Fixed-Length
Low-Profile Curved
Shower Rod - Non-Pivoting**
CSR2145

Product Details

- Provides extra elbow room in the shower
- Corrosion-resistant
- Drywall anchors included

Shower Rods and Rings

FIXED-LENGTH CURVED SHOWER ROD ONLY*

MODEL	LIST PRICE	DESCRIPTION	FINISH	QTY
2-102-5PS	28.35	5 ft. Rod Only	Polished Stainless	25
2-102-5BS	29.75	5 ft. Rod Only	Brushed Stainless	25
2-102-5BL	35.45	5 ft. Rod Only	Matte Black	25 NEW!

LOW-PROFILE FLANGE ONLY* - NON-PIVOTING

MODEL	LIST PRICE	DESCRIPTION	FINISH	QTY
65-F-BS	23.25	Flange Only	Brushed Stainless	25
65-F-PS	20.20	Flange Only	Polished Stainless	25
65-F-BL	25.25	Flange Only	Matte Black	25 NEW!

**Fixed-Length
Curved Shower Rod Only**

2-102-5*

**Low-Profile
Non-Pivoting Flange**

65-F

**Tension Curved
Shower Rod**

CSR2172

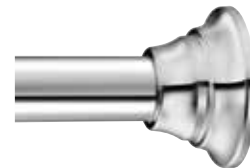
**Tension Rod**
TR1000**Tension Rod**
TR1032**Product Details**

- Shower rod provides extra elbow room in the shower
- Corrosion-resistant
- *For complete shower rod set, order both the curved shower rod and low profile flange kit.

TENSION CURVED SHOWER RODS

MODEL	LIST PRICE	DESCRIPTION	FINISH	QTY
CSR2172CH	62.95	Curved Shower Rod Set	Chrome	10
CSR2172BN	69.25	Curved Shower Rod Set	Brushed Nickel	10

Product Details

- Adjusts between 57" to 60"
- Corrosion-resistant
- Works with standard 72" x 72" shower curtains
- Easy installation: expand the bar to the correct size, apply tension and snap on the decorative covers

DECORATIVE TENSION STRAIGHT SHOWER RODS

MODEL	LIST PRICE	DESCRIPTION	FINISH	QTY
TR1000CH▲	39.65	Straight Shower Rod Set	Chrome	3
TR1000BN▲	39.65	Straight Shower Rod Set	Brushed Nickel	3
TR1000WB▲	39.65	Straight Shower Rod Set	Old World Bronze	3
TR1000BL▲	43.60	Straight Shower Rod Set	Matte Black	3
TR1032BN▲	55.75	Straight Shower Rod Set	Brushed Nickel	3
TR1000BG	71.40	Straight Shower Rod Set	Brushed Gold	3 NEW!

Product Details

- Adjusts between 44" to 72"
- Corrosion-resistant
- FastLock™ technology: no tools, no additional hardware, no long installation

▲ Retail Packaging

Showers curtains and shower curtain rings are not included with shower curtain rods.
Moen shower curtain rings can be purchased separately. See page 517.

List price is per each (unless otherwise noted). Product can be ordered by case quantity or individually.

Shower Rods and Rings

DOUBLE SHOWER CURTAIN SHOWER RINGS

MODEL	LIST PRICE	DESCRIPTION	FINISH	QTY
SR2201CH ▲	19.20	Double Shower Curtain Rings	Chrome	12
SR2201BN ▲	22.15	Double Shower Curtain Rings	Brushed Nickel	12
SR2201NL	31.10	Double Shower Curtain Rings	Polished Nickel	24
SR2201OWB ▲	22.45	Double Shower Curtain Rings	Old World Bronze	12
SR2201BL	31.10	Double Shower Curtain Rings	Matte Black	24

Product Details

- Smooth rolling ball bearings eliminates snagging, tugging and pulling
- Allows you to separate the shower curtain from the shower liner
- Corrosion resistant
- Fits most shower curtains and rod types



Double Shower Rings
SR2201

SINGLE SHOWER CURTAIN SHOWER RINGS

MODEL	LIST PRICE	DESCRIPTION	FINISH	QTY
SR2100CH	15.40	Single Shower Curtain Rings	Chrome	25
SR2100BN	17.65	Single Shower Curtain Rings	Brushed Nickel	25
SR2100WB	17.90	Single Shower Curtain Rings	Old World Bronze	25

Product Details

- Smooth rolling ball bearings eliminates snagging, tugging and pulling
- Corrosion resistant
- Fits most shower curtains and rod types



Single Shower Rings
SR2100

**COORDINATING
ACCESSORIES**

▲ Retail Packaging

List price is per each (unless otherwise noted). Product can be ordered by case quantity or individually.

Moen Lighting

Matching Accessories Moen Lighting

Our distinctive lighting options are designed to accent some of our leading faucets. Whether you want your lighting fixture and faucet to match or you want to mix it up with different collections, you'll get quality, durable and stylish lighting, built in the Moen tradition.



- Flara™
- Colinet™
- 90°°
- Greenfield™
- Belfield™
- Voss™
- Brantford®
- Eva®
- Iso™

COORDINATING ACCESSORIES

FLARA™			
MODEL	LIST PRICE	DESCRIPTION	QTY
PREMIUM			
Chrome (CH)			
YB0361CH	237.45	One Globe Bath Light	2
YB0362CH	332.15	Two Globe Bath Light	2
YB0363CH	412.60	Three Globe Bath Light	2
YB0364CH	515.70	Four Globe Bath Light	2
Brushed Nickel (BN)			
YB0361BN	308.65	One Globe Bath Light	2
YB0362BN	431.80	Two Globe Bath Light	2
YB0363BN	536.30	Three Globe Bath Light	2
YB0364BN	670.45	Four Globe Bath Light	2
Brushed Gold (BG)			
YB0361BG	370.35	One Globe Bath Light	2
YB0362BG	518.25	Two Globe Bath Light	2
YB0363BG	643.55	Three Globe Bath Light	2
YB0364BG	804.35	Four Globe Bath Light	2
Polished Nickel (NL)			
YB0361NL	339.50	One Globe Bath Light	2
YB0362NL	475.05	Two Globe Bath Light	2
YB0363NL	589.90	Three Globe Bath Light	2
YB0364NL	737.40	Four Globe Bath Light	2
Replacement Globe			
YB0369	40.90	Replacement Globe	3



One Globe Bath Light
YB0361



Two Globe Bath Light
YB0362



Three Globe Bath Light
YB0363



Four Globe Bath Light
YB0364



Replacement Globe
YB0369



Bulbs not included.

All Flara lighting fixtures can be mounted with globes either facing upward or downward.
List price is per each (unless otherwise noted). Product can be ordered by case quantity or individually.

Moen Lighting

COLINET™			
MODEL	LIST PRICE	DESCRIPTION	QTY
PREMIUM			
Chrome (CH)			
YB0561CH	237.55	One Globe Bath Light	2
YB0562CH	332.40	Two Globe Bath Light	2
YB0563CH	412.80	Three Globe Bath Light	2
YB0564CH	515.90	Four Globe Bath Light	2
Brushed Nickel (BN)			
YB0561BN	308.75	One Globe Bath Light	2
YB0562BN	432.10	Two Globe Bath Light	2
YB0563BN	536.55	Three Globe Bath Light	2
YB0564BN	670.70	Four Globe Bath Light	2
Brushed Gold (BG)			
YB0561BG	356.35	One Globe Bath Light	2
YB0562BG	498.70	Two Globe Bath Light	2
YB0563BG	619.15	Three Globe Bath Light	2
YB0564BG	773.95	Four Globe Bath Light	2
Matte Black (BL)			
YB0561BL	339.65	One Globe Bath Light	2
YB0562BL	475.30	Two Globe Bath Light	2
YB0563BL	590.20	Three Globe Bath Light	2
YB0564BL	737.75	Four Globe Bath Light	2
Replacement Globe			
YB0569	42.80	Replacement Globe	3



One Globe Bath Light
YB0561



Two Globe Bath Light
YB0562



Three Globe Bath Light
YB0563



Four Globe Bath Light
YB0564



Replacement Globe
YB0569

COORDINATING ACCESSORIES

90°			
MODEL	LIST PRICE	DESCRIPTION	QTY
PREMIUM			
Chrome (CH)			
YB8861CH	217.70	One Globe Bath Light	2
YB8862CH	304.55	Two Globe Bath Light	2
YB8863CH	378.25	Three Globe Bath Light	2
YB8864CH	484.55	Four Globe Bath Light	2
Brushed Nickel (BN)			
YB8861BN	272.05	One Globe Bath Light	2
YB8862BN	380.80	Two Globe Bath Light	2
YB8863BN	473.15	Three Globe Bath Light	2
YB8864BN	605.65	Four Globe Bath Light	2
Matte Black (BL)			
YB8861BL	296.50	One Globe Bath Light	2
YB8862BL	415.10	Two Globe Bath Light	2
YB8863BL	515.70	Three Globe Bath Light	2
YB8864BL	660.10	Four Globe Bath Light	2
Replacement Globe			
YB8869	40.00	Replacement Globe	3



One Globe Bath Light
YB8861



Two Globe Bath Light
YB8862



Three Globe Bath Light
YB8863



Four Globe Bath Light
YB8864



Replacement Globe
YB8869



Bulbs not included.

All Colinet and 90° lighting fixtures can be mounted with globes either facing upward or downward. List price is per each (unless otherwise noted). Product can be ordered by case quantity or individually.

Moen Lighting

GREENFIELD™

MODEL	LIST PRICE	DESCRIPTION	QTY
Chrome (CH)			
YB1761CH	180.65	One Globe Bath Light	1
YB1762CH	252.75	Two Globe Bath Light	1
YB1763CH	313.95	Three Globe Bath Light	1
YB1764CH	402.00	Four Globe Bath Light	1
Brushed Nickel (BN)			
YB1761BN	225.90	One Globe Bath Light	1
YB1762BN	315.95	Two Globe Bath Light	1
YB1763BN	392.40	Three Globe Bath Light	1
YB1764BN	502.50	Four Globe Bath Light	1
Brushed Gold (BG)			
YB1761BG	271.10	One Globe Bath Light	1
YB1762BG	379.15	Two Globe Bath Light	1
YB1763BG	470.95	Three Globe Bath Light	1
YB1764BG	602.95	Four Globe Bath Light	1
Matte Black (BL)			
YB1761BL	246.25	One Globe Bath Light	1
YB1762BL	344.35	Two Globe Bath Light	1
YB1763BL	427.70	Three Globe Bath Light	1
YB1764BL	547.75	Four Globe Bath Light	1
Replacement Globe			
YB1769	33.10	Replacement Globe	3



One Globe Bath Light
YB1761



Two Globe Bath Light
YB1762



Three Globe Bath Light
YB1763



Four Globe Bath Light
YB1764



Replacement Globe
YB1769

COORDINATING ACCESSORIES

BELFIELD™

MODEL	LIST PRICE	DESCRIPTION	QTY
Chrome (CH)			
YB6461CH	181.45	One Globe Bath Light	1
YB6462CH	253.85	Two Globe Bath Light	1
YB6463CH	315.10	Three Globe Bath Light	1
YB6464CH	403.55	Four Globe Bath Light	1
Brushed Nickel (BN)			
YB6461BN	226.75	One Globe Bath Light	1
YB6462BN	317.20	Two Globe Bath Light	1
YB6463BN	393.90	Three Globe Bath Light	1
YB6464BN	504.50	Four Globe Bath Light	1
Polished Nickel (NL)			
YB6461NL	219.65	One Globe Bath Light	1
YB6462NL	307.40	Two Globe Bath Light	1
YB6463NL	393.90	Three Globe Bath Light	1
YB6464NL	523.85	Four Globe Bath Light	1
Oil Rubbed Bronze (ORB)			
YB6461ORB	226.75	One Globe Bath Light	1
YB6462ORB	317.20	Two Globe Bath Light	1
YB6463ORB	393.90	Three Globe Bath Light	1
YB6464ORB	504.50	Four Globe Bath Light	1
Matte Black (BL)			
YB6461BL	219.65	One Globe Bath Light	1
YB6462BL	307.40	Two Globe Bath Light	1
YB6463BL	410.15	Three Globe Bath Light	1
YB6464BL	523.85	Four Globe Bath Light	1
Replacement Globe			
YB6469	33.30	Replacement Globe	3



One Globe Bath Light
YB6461



Two Globe Bath Light
YB6462



Three Globe Bath Light
YB6463



Four Globe Bath Light
YB6464



Replacement Globe
YB6469

All Greenfield and Belfield lighting fixtures can be mounted with globes either facing upward or downward. Greenfield two globe bath lighting can be mounted either facing vertically or horizontally without the need to remove the rings.

List price is per each (unless otherwise noted). Product can be ordered by case quantity or individually.



Bulbs not included.

Moen Lighting

VOSS™			
MODEL	LIST PRICE	DESCRIPTION	QTY
Chrome (CH)			
YB5161CH	180.65	One Globe Bath Light	2
YB5162CH	252.75	Two Globe Bath Light	2
YB5163CH	313.95	Three Globe Bath Light	2
YB5164CH	402.00	Four Globe Bath Light	2
Brushed Nickel (BN)			
YB5161BN	225.90	One Globe Bath Light	2
YB5162BN	315.95	Two Globe Bath Light	2
YB5163BN	392.40	Three Globe Bath Light	2
YB5164BN	502.50	Four Globe Bath Light	2
Brushed Gold (BG)			
YB5161BG	271.10	One Globe Bath Light	2
YB5162BG	379.15	Two Globe Bath Light	2
YB5163BG	470.95	Three Globe Bath Light	2
YB5164BG	602.95	Four Globe Bath Light	2
Polished Nickel (NL)			
YB5161NL	226.00	One Globe Bath Light	2
YB5162NL	329.00	Two Globe Bath Light	2
YB5163NL	424.20	Three Globe Bath Light	2
YB5164NL	543.30	Four Globe Bath Light	2
Oil Rubbed Bronze (ORB)			
YB5161ORB	225.90	One Globe Bath Light	2
YB5162ORB	315.95	Two Globe Bath Light	2
YB5163ORB	392.40	Three Globe Bath Light	2
YB5164ORB	502.50	Four Globe Bath Light	2
Matte Black (BL)			
YB5161BL	225.90	One Globe Bath Light	2
YB5162BL	315.95	Two Globe Bath Light	2
YB5163BL	392.40	Three Globe Bath Light	2
YB5164BL	502.50	Four Globe Bath Light	2
Replacement Globe			
YB5169	33.10	Replacement Globe	3



One Globe Bath Light
YB5161



Two Globe Bath Light
YB5162



Three Globe Bath Light
YB5163



Four Globe Bath Light
YB5164



Replacement Globe
YB5169

COORDINATING ACCESSORIES

BRANTFORD®			
MODEL	LIST PRICE	DESCRIPTION	QTY
Chrome (CH)			
YB2261CH	150.15	One Globe Bath Light	2
YB2262CH	210.20	Two Globe Bath Light	2
YB2263CH	261.00	Three Globe Bath Light	2
YB2264CH	334.35	Four Globe Bath Light	2
Brushed Nickel (BN)			
YB2261BN	187.80	One Globe Bath Light	2
YB2262BN	262.85	Two Globe Bath Light	2
YB2263BN	326.35	Three Globe Bath Light	2
YB2264BN	417.85	Four Globe Bath Light	2
Oil Rubbed Bronze (ORB)			
YB2261ORB	187.80	One Globe Bath Light	2
YB2262ORB	262.85	Two Globe Bath Light	2
YB2263ORB	326.35	Three Globe Bath Light	2
YB2264ORB	417.85	Four Globe Bath Light	2
Replacement Globe			
YB2269	28.15	Replacement Globe	3



One Globe Bath Light
YB2261



Two Globe Bath Light
YB2262



Three Globe Bath Light
YB2263



Four Globe Bath Light
YB2264



Replacement Globe
YB2269



Bulbs not included.

All Voss and Brantford lighting fixtures can be mounted with globes either facing upward or downward. List price is per each (unless otherwise noted). Product can be ordered by case quantity or individually.

Moen Lighting

COORDINATING
ACCESSORIES

EVA®			
MODEL	LIST PRICE	DESCRIPTION	QTY
Chrome (CH)			
YB2861CH	150.15	One Globe Bath Light	2
YB2862CH	210.20	Two Globe Bath Light	2
YB2863CH	261.00	Three Globe Bath Light	2
YB2864CH	334.35	Four Globe Bath Light	2
Brushed Nickel (BN)			
YB2861BN	187.80	One Globe Bath Light	2
YB2862BN	262.85	Two Globe Bath Light	2
YB2863BN	326.35	Three Globe Bath Light	2
YB2864BN	417.85	Four Globe Bath Light	2
Oil Rubbed Bronze (ORB)			
YB2861ORB	187.80	One Globe Bath Light	2
YB2862ORB	262.85	Two Globe Bath Light	2
YB2863ORB	326.35	Three Globe Bath Light	2
YB2864ORB	417.85	Four Globe Bath Light	2
Replacement Globe			
YB2869	28.15	Replacement Globe	3



One Globe Bath Light
YB2861



Two Globe Bath Light
YB2862



Three Globe Bath Light
YB2863



Four Globe Bath Light
YB2864



Replacement Globe
YB2869

ISO™			
MODEL	LIST PRICE	DESCRIPTION	QTY
Chrome (CH)			
DN0761CH	149.80	One Globe Bath Light	2
DN0762CH	213.70	Two Globe Bath Light	2
DN0763CH	262.25	Three Globe Bath Light	2
DN0764CH	335.95	Four Globe Bath Light	2
Brushed Nickel (BN)			
DN0761BN	188.60	One Globe Bath Light	2
DN0762BN	264.10	Two Globe Bath Light	2
DN0763BN	327.90	Three Globe Bath Light	2
DN0764BN	419.80	Four Globe Bath Light	2
Brushed Gold (BG)			
DN0761BG	226.30	One Globe Bath Light	2
DN0762BG	316.80	Two Globe Bath Light	2
DN0763BG	393.40	Three Globe Bath Light	2
DN0764BG	503.75	Four Globe Bath Light	2
Matte Black (BL)			
DN0761BL	181.45	One Globe Bath Light	2
DN0762BL	258.80	Two Globe Bath Light	2
DN0763BL	317.60	Three Globe Bath Light	2
DN0764BL	406.85	Four Globe Bath Light	2
Replacement Globe			
DN0769	27.65	Replacement Globe	3



One Globe Bath Light
DN0761



Two Globe Bath Light
DN0762



Three Globe Bath Light
DN0763



Four Globe Bath Light
DN0764



Replacement Globe
DN0769



Bulbs not included.

Weymouth®

Flara™

Colinet™

90°®

Iso™

Matching Accessories Knobs and Pulls

With our distinctive collection of knobs and pulls, you can complement your bath or kitchen faucet with matching collections or pair with coordinating collections to create a look unique to your style.



COORDINATING ACCESSORIES

WEYMOUTH®

MODEL	LIST PRICE	DESCRIPTION	QTY
-------	------------	-------------	-----

PREMIUM

Chrome (CH)

YB8405CH	22.80	Drawer Knob	48
----------	-------	-------------	----

YB8407CH	42.60	Drawer Pull	48
----------	-------	-------------	----

Brushed Nickel (BN)

YB8405BN	25.75	Drawer Knob	48
----------	-------	-------------	----

YB8407BN	45.50	Drawer Pull	48
----------	-------	-------------	----

Brushed Gold (BG)

YB8405BG	30.90	Drawer Knob	48
----------	-------	-------------	----

YB8407BG	54.60	Drawer Pull	48
----------	-------	-------------	----

Polished Nickel (NL)

YB8405NL	28.30	Drawer Knob	48
----------	-------	-------------	----

YB8407NL	50.05	Drawer Pull	48
----------	-------	-------------	----

Oil Rubbed Bronze (ORB)

YB8405ORB	28.30	Drawer Knob	48
-----------	-------	-------------	----

YB8407ORB	50.05	Drawer Pull	48
-----------	-------	-------------	----

Matte Black (BL)

YB8405BL	28.30	Drawer Knob	48
----------	-------	-------------	----

YB8407BL	49.85	Drawer Pull	48
----------	-------	-------------	----



Drawer Knob
YB8405



Drawer Pull
YB8407

FLARA™

MODEL	LIST PRICE	DESCRIPTION	QTY
-------	------------	-------------	-----

PREMIUM

Chrome (CH)

YB0305CH	18.60	Drawer Knob	48
----------	-------	-------------	----

YB0307CH	37.35	Drawer Pull	48
----------	-------	-------------	----

Brushed Nickel (BN)

YB0305BN	24.25	Drawer Knob	48
----------	-------	-------------	----

YB0307BN	48.60	Drawer Pull	48
----------	-------	-------------	----

Brushed Gold (BG)

YB0305BG	29.05	Drawer Knob	48
----------	-------	-------------	----

YB0307BG	58.35	Drawer Pull	48
----------	-------	-------------	----

Polished Nickel (NL)

YB0305NL	20.50	Drawer Knob	48
----------	-------	-------------	----

YB0307NL	53.45	Drawer Pull	48
----------	-------	-------------	----



Drawer Knob
YB0305



Drawer Pull
YB0307

Moen Knobs & Pulls

COORDINATING
ACCESSORIES**COLINET™**

MODEL	LIST PRICE	DESCRIPTION	QTY
PREMIUM			
Chrome (CH)			
YB0505CH	18.60	Drawer Knob	48
YB0507CH	37.40	Drawer Pull	48
Brushed Nickel (BN)			
YB0505BN	24.25	Drawer Knob	48
YB0507BN	48.65	Drawer Pull	48
Brushed Gold (BG)			
YB0505BG	28.00	Drawer Knob	48
YB0507BG	56.15	Drawer Pull	48
Matte Black (BL)			
YB0505BL	26.70	Drawer Knob	48
YB0507BL	53.45	Drawer Pull	48



Drawer Knob
YB0505



Drawer Pull
YB0507

90°®

MODEL	LIST PRICE	DESCRIPTION	QTY
PREMIUM			
Chrome (CH)			
YB8805CH	17.15	Drawer Knob	48
YB8807CH	34.30	Drawer Pull	48
Brushed Nickel (BN)			
YB8805BN	19.80	Drawer Knob	48
YB8807BN	37.10	Drawer Pull	48
Matte Black (BL)			
YB8805BL	21.55	Drawer Knob	48
YB8807BL	40.40	Drawer Pull	48



Drawer Knob
YB8805



Drawer Pull
YB8807

Moen Knobs & Pulls

ISO™			
MODEL	LIST PRICE	DESCRIPTION	QTY
Chrome (CH)			
DN0705CH	11.15	Drawer Knob	48
DN0707CH	22.30	Drawer Pull	48
Brushed Nickel (BN)			
DN0705BN	13.05	Drawer Knob	48
DN0707BN	24.00	Drawer Pull	48
Brushed Gold (BG)			
DN0705BG	15.65	Drawer Knob	48
DN0707BG	28.75	Drawer Pull	48
Matte Black (BL)			
DN0705BL	13.55	Drawer Knob	48
DN0707BL	26.95	Drawer Pull	48



Drawer Knob
DN0705



Drawer Pull
DN0707

COORDINATING
ACCESSORIES

BATH SAFETY



While bath safety is often only considered for older adults, it should be for all stages of life. From babies to boomers, Moen® offers a full range of products to make baths safe and stylish.

Grab Bar Guide

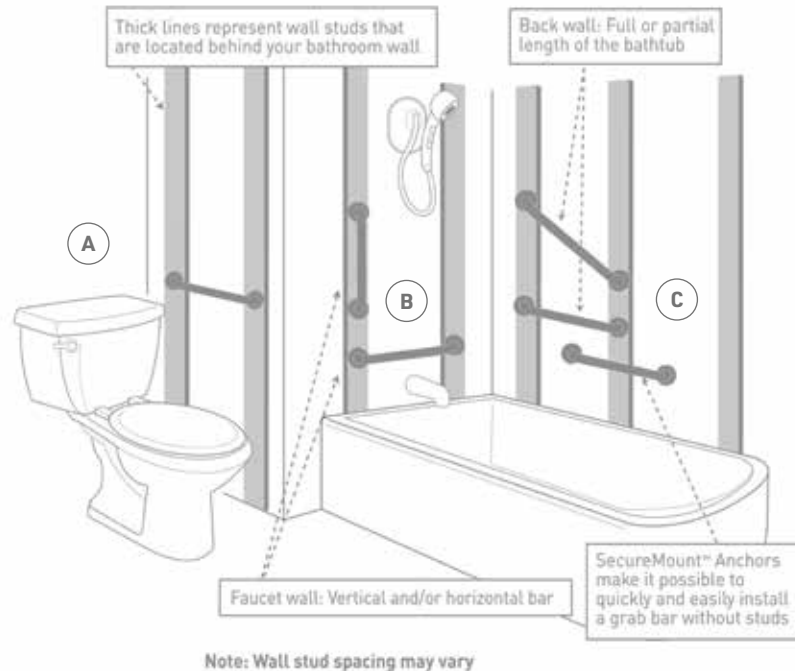

HOW MANY GRAB BARS DO I NEED AND WHERE SHOULD THEY BE INSTALLED?

Health professionals typically recommend three grab bars in a bathroom:

- A** At least one near the toilet
- B** At least one along the showerhead wall or whichever end of the tub/shower you use to enter/exit
- C** At least one along the back wall in the bathtub or shower

WHO SHOULD USE GRAB BARS?

Everyone! People of all ages and abilities can benefit from using grab bars.

WHAT CAN A GRAB BAR DO?

- Reduce risk of falling in the tub or shower
- Help steady yourself while getting into and out of the bathtub or shower
- Assist in safely lowering and raising from a seated position

THINGS TO CONSIDER WHEN SELECTING A GRAB BAR(S):

- **Length:** Select a grab bar that is the suitable length for your bath or shower area.
- **Weight Capacity:** Choose a grab bar that at least meets ADA requirements (250 lbs.); SecureMount™ Grab Bars have a 500-pound weight-pull capacity that exceeds ADA requirements (when securely installed into studs).
- **Installation:** Grab bars that feature SecureMount™ have a design that allows for secure installation into a stud or wood backing at any angle. When using SecureMount™ Anchors, there is no need for installation into a stud or wood backing.
- **Grip Surface:** Consider a grab bar with a textured surface or grip feature that provides a better hold in a wet bathroom environment.
- **Finish:** Consider a grab bar that matches your faucet and other fixtures.

SECUREMOUNT™ SYSTEM

COORDINATING ACCESSORIES



FINISH OPTIONS



Chrome (CH), Old World Bronze (OWB)

Product Details:

- 300 lb. weight capacity when securely installed per instructions. Limited Lifetime Warranty. Independently tested by CSA and NAHB laboratories to exceed ADA, ASTM, ANSI and CSA standards.
- Mount securely to a variety of substrates*:
 - 1/2" or 5/8" drywall
 - 1/2" or 5/8" drywall with tile
 - 1/2" or 5/8" drywall with marble
 - 1/8" or 1/4" fiberglass tub surround

Not all platforms available in all finishes.



SecureMount Anchors and Plates

1 Pair Pack

10 Pair Pack

SMA1000 | ♿

SMA1001 | ♿

SECUREMOUNT™

SecureMount System

The SecureMount System is the ultimate choice in easy, secure grab bar installation.

SecureMount Grab Bars

The unique flange makes it easy to connect to the stud at multiple points, at any angle.

SecureMount Anchors

Precision-engineered for optimal bracing behind the wall, SecureMount Anchors allow for easy grab bar installation—with no studs required—anywhere on the wall.

16" grab bars can typically mount directly into studs because the standard stud size is 16" on center. 18", 24", 36" and 42" grab bars will often need an anchoring system when mounted into drywall, as an alternative to stud or wood-block installation.

*Including multiple layers up to 1 1/2" thick

- Arris®
- Flara™
- 90°®
- Align®
- Voss™
- Belfield™
- Kingsley®
- Brantford®
- Eva®
- Genta™ LX
- Iso™

Grab Bars

With our broad collection of grab bar and bath safety products, there's no need to sacrifice style for safety. Choose from a variety of styles and finishes to match collections or pair different designs together for a distinctive look. Further enhance bath safety with a choice of products for the toilet, tub and shower.



COORDINATING ACCESSORIES

ARRIS® GRAB BARS - 1 1/4" DIAMETER CONCEALED SCREW

MODEL	LIST PRICE	DESCRIPTION	FINISH	QTY
PREMIUM				
1 1/4" • Chrome (CH)				
YG0812CH	206.25	12" Designer Grab Bar	Chrome	6
YG0818CH	215.50	18" Designer Grab Bar	Chrome	6
YG0824CH	225.15	24" Designer Grab Bar	Chrome	6
YG0836CH	256.25	36" Designer Grab Bar	Chrome	6
YG0842CH	358.70	42" Designer Grab Bar	Chrome	6
1 1/4" • Matte Black (BL)				
YG0812BL	249.10	12" Designer Grab Bar	Matte Black	6
YG0818BL	260.30	18" Designer Grab Bar	Matte Black	6
YG0824BL	272.00	24" Designer Grab Bar	Matte Black	6
YG0836BL	309.70	36" Designer Grab Bar	Matte Black	6
YG0842BL	433.35	42" Designer Grab Bar	Matte Black	6



24" Designer Grab Bar

YG0824 | 

 ADA-Compliant

SecureMount™ for non-stud installation sold separately. See page 528 for details.
List price is per each (unless otherwise noted). Product can be ordered by case quantity or individually.

Grab Bars

FLARA™ GRAB BARS - 1 1/4" DIAMETER CONCEALED SCREW

MODEL	LIST PRICE	DESCRIPTION	FINISH	QTY
PREMIUM				
1 1/4" • Chrome (CH)				
YG0312CH	214.20	12" Designer Grab Bar	Chrome	6
YG0318CH	223.85	18" Designer Grab Bar	Chrome	6
YG0324CH	233.90	24" Designer Grab Bar	Chrome	6
YG0336CH	266.20	36" Designer Grab Bar	Chrome	6
YG0342CH	391.75	42" Designer Grab Bar	Chrome	6
1 1/4" • Brushed Nickel (BN)				
YG0312BN	278.40	12" Designer Grab Bar	Brushed Nickel	6
YG0318BN	290.95	18" Designer Grab Bar	Brushed Nickel	6
YG0324BN	303.90	24" Designer Grab Bar	Brushed Nickel	6
YG0336BN	346.10	36" Designer Grab Bar	Brushed Nickel	6
YG0342BN	509.25	42" Designer Grab Bar	Brushed Nickel	6
1 1/4" • Brushed Gold (BG)				
YG0312BG	334.15	12" Designer Grab Bar	Brushed Gold	6
YG0318BG	349.10	18" Designer Grab Bar	Brushed Gold	6
YG0324BG	364.75	24" Designer Grab Bar	Brushed Gold	6
YG0336BG	415.30	36" Designer Grab Bar	Brushed Gold	6
YG0342BG	611.15	42" Designer Grab Bar	Brushed Gold	6
1 1/4" • Polished Nickel (NL)				
YG0312NL	306.25	12" Designer Grab Bar	Polished Nickel	6
YG0318NL	320.10	18" Designer Grab Bar	Polished Nickel	6
YG0324NL	334.40	24" Designer Grab Bar	Polished Nickel	6
YG0336NL	380.65	36" Designer Grab Bar	Polished Nickel	6
YG0342NL	560.20	42" Designer Grab Bar	Polished Nickel	6

**24" Designer Grab Bar**

YG0324 |

COORDINATING
ACCESSORIES**90° GRAB BARS - 1 1/4" DIAMETER CONCEALED SCREW**

MODEL	LIST PRICE	DESCRIPTION	FINISH	QTY
PREMIUM				
1 1/4" • Chrome (CH)				
YG8812CH	196.40	12" Designer Grab Bar	Chrome	6
YG8818CH	205.20	18" Designer Grab Bar	Chrome	6
YG8824CH	214.40	24" Designer Grab Bar	Chrome	6
YG8836CH	244.05	36" Designer Grab Bar	Chrome	6
YG8842CH	359.25	42" Designer Grab Bar	Chrome	6
1 1/4" • Brushed Nickel (BN)				
YG8812BN	212.25	12" Designer Grab Bar	Brushed Nickel	6
YG8818BN	222.45	18" Designer Grab Bar	Brushed Nickel	6
YG8824BN	240.10	24" Designer Grab Bar	Brushed Nickel	6
YG8836BN	270.35	36" Designer Grab Bar	Brushed Nickel	6
YG8842BN	397.15	42" Designer Grab Bar	Brushed Nickel	6
1 1/4" • Matte Black (BL)				
YG8812BL	231.40	12" Designer Grab Bar	Matte Black	66
YG8818BL	242.50	18" Designer Grab Bar	Matte Black	66
YG8824BL	261.70	24" Designer Grab Bar	Matte Black	66
YG8836BL	294.70	36" Designer Grab Bar	Matte Black	66
YG8842BL	432.90	42" Designer Grab Bar	Matte Black	66

**24" Designer Grab Bar**

YG8824 |

ADA-Compliant

SecureMount™ for non-stud installation sold separately. See page 528 for details.
List price is per each (unless otherwise noted). Product can be ordered by case quantity or individually.

ALIGN® GRAB BARS - 1 1/4" DIAMETER CONCEALED SCREW

MODEL	LIST PRICE	DESCRIPTION	FINISH	QTY
1 1/4" • Chrome (CH)				
YG0412CH	123.55	12" Designer Grab Bar	Chrome	6
YG0418CH	132.25	18" Designer Grab Bar	Chrome	6
YG0424CH	138.10	24" Designer Grab Bar	Chrome	6
YG0436CH	157.45	36" Designer Grab Bar	Chrome	6
YG0442CH	189.00	42" Designer Grab Bar	Chrome	6

1 1/4" • Brushed Nickel (BN)

YG0412BN	154.45	12" Designer Grab Bar	Brushed Nickel	6
YG0418BN	165.30	18" Designer Grab Bar	Brushed Nickel	6
YG0424BN	172.65	24" Designer Grab Bar	Brushed Nickel	6
YG0436BN	196.80	36" Designer Grab Bar	Brushed Nickel	6
YG0442BN	236.25	42" Designer Grab Bar	Brushed Nickel	6

1 1/4" • Matte Black (BL)

YG0412BL	155.65	12" Designer Grab Bar	Matte Black	6	NEW!
YG0418BL	166.65	18" Designer Grab Bar	Matte Black	6	NEW!
YG0424BL	174.00	24" Designer Grab Bar	Matte Black	6	NEW!
YG0436BL	198.35	36" Designer Grab Bar	Matte Black	6	NEW!
YG0442BL	245.70	42" Designer Grab Bar	Matte Black	6	NEW!

1 1/4" • Brushed Gold (BG)

YG0412BG	159.35	12" Designer Grab Bar	Brushed Gold	6	NEW!
YG0418BG	191.80	18" Designer Grab Bar	Brushed Gold	6	
YG0424BG	200.25	24" Designer Grab Bar	Brushed Gold	6	
YG0436BG	203.10	36" Designer Grab Bar	Brushed Gold	6	NEW!
YG0442BG	274.05	42" Designer Grab Bar	Brushed Gold	6	NEW!

VOSS™ GRAB BARS - 1 1/4" DIAMETER CONCEALED SCREW

MODEL	LIST PRICE	DESCRIPTION	FINISH	QTY
1 1/4" • Chrome (CH)				
YG5112CH	123.55	12" Designer Grab Bar	Chrome	6
YG5118CH	129.10	18" Designer Grab Bar	Chrome	6
YG5124CH	134.90	24" Designer Grab Bar	Chrome	6

1 1/4" • Brushed Nickel (BN)

YG5112BN	152.00	12" Designer Grab Bar	Brushed Nickel	6
YG5118BN	158.80	18" Designer Grab Bar	Brushed Nickel	6
YG5124BN	168.65	24" Designer Grab Bar	Brushed Nickel	6

1 1/4" • Brushed Gold (BG)

YG5112BG	179.15	12" Designer Grab Bar	Brushed Gold	6
YG5118BG	187.20	18" Designer Grab Bar	Brushed Gold	6
YG5124BG	195.60	24" Designer Grab Bar	Brushed Gold	6

1 1/4" • Polished Nickel (NL)

YG5112NL	166.80	12" Designer Grab Bar	Polished Nickel	6
YG5118NL	174.30	18" Designer Grab Bar	Polished Nickel	6
YG5124NL	182.15	24" Designer Grab Bar	Polished Nickel	6

1 1/4" • Oil Rubbed Bronze (ORB)

YG5112ORB	169.25	12" Designer Grab Bar	Oil Rubbed Bronze	6
YG5118ORB	176.85	18" Designer Grab Bar	Oil Rubbed Bronze	6
YG5124ORB	186.15	24" Designer Grab Bar	Oil Rubbed Bronze	6

1 1/4" • Matte Black (BL)

YG5112BL	160.60	12" Designer Grab Bar	Matte Black	6
YG5118BL	167.85	18" Designer Grab Bar	Matte Black	6
YG5124BL	175.40	24" Designer Grab Bar	Matte Black	6

**24" Designer Grab Bar**

YG0424 |

**24" Designer Grab Bar**

YG5124 |



SecureMount™ for non-stud installation sold separately. See page 528 for details.
List price is per each (unless otherwise noted). Product can be ordered by case quantity or individually.



Grab Bars

BELFIELD™ GRAB BARS - 1 1/4" DIAMETER CONCEALED SCREW

MODEL	LIST PRICE	DESCRIPTION	FINISH	QTY
1 1/4" • Chrome (CH)				
YG6412CH	123.55	12" Designer Grab Bar	Chrome	6
YG6418CH	129.10	18" Designer Grab Bar	Chrome	6
YG6424CH	134.90	24" Designer Grab Bar	Chrome	6
1 1/4" • Brushed Nickel (BN)				
YG6412BN	150.75	12" Designer Grab Bar	Brushed Nickel	6
YG6418BN	157.50	18" Designer Grab Bar	Brushed Nickel	6
YG6424BN	168.65	24" Designer Grab Bar	Brushed Nickel	6
1 1/4" • Polished Nickel (NL)				
YG6412NL	155.65	12" Designer Grab Bar	Polished Nickel	6
YG6418NL	162.65	18" Designer Grab Bar	Polished Nickel	6
YG6424NL	169.95	24" Designer Grab Bar	Polished Nickel	6
1 1/4" • Oil Rubbed Bronze (ORB)				
YG6412ORB	166.80	12" Designer Grab Bar	Oil Rubbed Bronze	6
YG6418ORB	174.30	18" Designer Grab Bar	Oil Rubbed Bronze	6
YG6424ORB	188.85	24" Designer Grab Bar	Oil Rubbed Bronze	6
1 1/4" • Matte Black (BL)				
YG6412BL	153.20	12" Designer Grab Bar	Matte Black	6
YG6418BL	160.10	18" Designer Grab Bar	Matte Black	6
YG6424BL	167.30	24" Designer Grab Bar	Matte Black	6

**24" Designer Grab Bar**YG6424 | COORDINATING
ACCESSORIES**KINGSLEY® GRAB BARS - 1 1/4" DIAMETER CONCEALED SCREW**

MODEL	LIST PRICE	DESCRIPTION	FINISH	QTY
1 1/4" • Chrome (CH)				
YG5412CH	137.05	12" Designer Grab Bar	Chrome	3
YG5418CH	143.20	18" Designer Grab Bar	Chrome	3
YG5424CH	149.55	24" Designer Grab Bar	Chrome	3
YG5430CH	160.00	30" Designer Grab Bar	Chrome	3
YG5436CH	170.25	36" Designer Grab Bar	Chrome	3
YG5442CH	249.85	42" Designer Grab Bar	Chrome	3
1 1/4" • Brushed Nickel (BN)				
YG5412BN	165.70	12" Designer Grab Bar	Brushed Nickel	3
YG5418BN	173.60	18" Designer Grab Bar	Brushed Nickel	3
YG5424BN	187.45	24" Designer Grab Bar	Brushed Nickel	3
YG5430BN	195.25	30" Designer Grab Bar	Brushed Nickel	3
YG5436BN	210.90	36" Designer Grab Bar	Brushed Nickel	3
YG5442BN	312.40	42" Designer Grab Bar	Brushed Nickel	3
1 1/4" • Oil Rubbed Bronze (ORB)				
YG5412ORB	182.20	12" Designer Grab Bar	Oil Rubbed Bronze	3
YG5418ORB	191.20	18" Designer Grab Bar	Oil Rubbed Bronze	3
YG5424ORB	206.30	24" Designer Grab Bar	Oil Rubbed Bronze	3

**24" Designer Grab Bar**YG5424 |  ADA-CompliantSecureMount™ for non-stud installation sold separately. See page 528 for details.
List price is per each (unless otherwise noted). Product can be ordered by case quantity or individually.

BRANTFORD® GRAB BARS - 1 1/4" DIAMETER CONCEALED SCREW

MODEL	LIST PRICE	DESCRIPTION	FINISH	QTY
1 1/4" • Chrome (CH)				
YG2212CH	110.50	12" Designer Grab Bar	Chrome	6
YG2218CH	115.40	18" Designer Grab Bar	Chrome	6
YG2224CH	120.80	24" Designer Grab Bar	Chrome	6
1 1/4" • Brushed Nickel (BN)				
YG2212BN	136.45	12" Designer Grab Bar	Brushed Nickel	6
YG2218BN	142.50	18" Designer Grab Bar	Brushed Nickel	6
YG2224BN	148.60	24" Designer Grab Bar	Brushed Nickel	6
1 1/4" • Oil Rubbed Bronze (ORB)				
YG2212ORB	149.20	12" Designer Grab Bar	Oil Rubbed Bronze	6
YG2218ORB	155.60	18" Designer Grab Bar	Oil Rubbed Bronze	6
YG2224ORB	163.10	24" Designer Grab Bar	Oil Rubbed Bronze	6



24" Designer Grab Bar

YG2224 |

EVA® GRAB BARS - 1 1/4" DIAMETER CONCEALED SCREW

MODEL	LIST PRICE	DESCRIPTION	FINISH	QTY
1 1/4" • Chrome (CH)				
YG2812CH	110.50	12" Designer Grab Bar	Chrome	6
YG2818CH	115.40	18" Designer Grab Bar	Chrome	6
YG2824CH	120.80	24" Designer Grab Bar	Chrome	6
1 1/4" • Brushed Nickel (BN)				
YG2812BN	136.45	12" Designer Grab Bar	Brushed Nickel	6
YG2818BN	142.20	18" Designer Grab Bar	Brushed Nickel	6
YG2824BN	148.60	24" Designer Grab Bar	Brushed Nickel	6
1 1/4" • Oil Rubbed Bronze (ORB)				
YG2812ORB	149.20	12" Designer Grab Bar	Oil Rubbed Bronze	6
YG2818ORB	155.60	18" Designer Grab Bar	Oil Rubbed Bronze	6
YG2824ORB	163.10	24" Designer Grab Bar	Oil Rubbed Bronze	6



24" Designer Grab Bar

YG2824 |

COORDINATING ACCESSORIES

ADA-Compliant

SecureMount™ for non-stud installation sold separately. See page 528 for details.
List price is per each (unless otherwise noted). Product can be ordered by case quantity or individually.

Grab Bars

ISO™ GRAB BARS - 1 1/4" DIAMETER CONCEALED SCREW

MODEL	LIST PRICE	DESCRIPTION	FINISH	QTY
1 1/4" • Chrome (CH)				
YG0712CH	84.45	12" Designer Grab Bar	Chrome	6
YG0718CH	89.05	18" Designer Grab Bar	Chrome	6
YG0724CH	93.65	24" Designer Grab Bar	Chrome	6
YG0736CH	106.65	36" Designer Grab Bar	Chrome	6
YG0742CH	130.00	42" Designer Grab Bar	Chrome	6
1 1/4" • Brushed Nickel (BN)				
YG0712BN	99.00	12" Designer Grab Bar	Brushed Nickel	6
YG0718BN	104.00	18" Designer Grab Bar	Brushed Nickel	6
YG0724BN	109.50	24" Designer Grab Bar	Brushed Nickel	6
YG0736BN	124.50	36" Designer Grab Bar	Brushed Nickel	6
YG0742BN	162.50	42" Designer Grab Bar	Brushed Nickel	6
1 1/4" • Matte Black (BL)				
YG0712BL	106.10	12" Designer Grab Bar	Matte Black	6
YG0718BL	112.00	18" Designer Grab Bar	Matte Black	6
YG0724BL	117.80	24" Designer Grab Bar	Matte Black	6
YG0736BL	134.10	36" Designer Grab Bar	Matte Black	6
YG0742BL	169.00	42" Designer Grab Bar	Matte Black	6

**18" Designer Grab Bar**YG0718 | COORDINATING
ACCESSORIES**GENTA™ LX GRAB BARS - 1 1/4" DIAMETER CONCEALED SCREW**

MODEL	LIST PRICE	DESCRIPTION	FINISH	QTY
1 1/4" • Chrome (CH)				
MBHG3818CH	141.40	18" Designer Grab Bar	Chrome	3
1 1/4" • Brushed Nickel (BN)				
MBHG3818BN	147.15	18" Designer Grab Bar	Brushed Nickel	3

**18" Designer Grab Bar**MBHG3818CH |  ADA-CompliantSecureMount™ for non-stud installation sold separately. See page 528 for details.
List price is per each (unless otherwise noted). Product can be ordered by case quantity or individually.

COORDINATING ACCESSORIES

DESIGNER ELEGANCE WITH GRIP PADS - 1 1/4" DIAMETER CONCEALED SCREW

MODEL	LIST PRICE	DESCRIPTION	FINISH	QTY
1 1/4" • Chrome (CH)				
R8716D1GCH	65.70	16" Designer Grab Bar	Chrome	3
LR8724D1GCH▲	71.05	24" Designer Grab Bar	Chrome	3
1 1/4" • Brushed Nickel (BN)				
R8716D1GBN	71.05	16" Designer Grab Bar	Brushed Nickel	3
LR8724D1GBN▲	74.50	24" Designer Grab Bar	Brushed Nickel	3
RA8716D1GBN	81.20	16" Designer Grab Bar - ANGLED	Brushed Nickel	3
1 1/4" • Old World Bronze (OWB)				
LR8724D1GOWB▲	88.60	24" Designer Grab Bar	Old World Bronze	3



Designer Elegance Grab Bar with Grip Pads
R8716D1G |



Designer Elegance Angled Grab Bar with Grip Pads
RA8716D1G |

DESIGNER ULTIMA - 1 1/4" DIAMETER CONCEALED SCREW

MODEL	LIST PRICE	DESCRIPTION	FINISH	QTY
1 1/4" • Chrome (CH)				
LR8716D3CH▲	40.70	16" Designer Grab Bar	Chrome	3
LR8724D3CH▲	47.90	24" Designer Grab Bar	Chrome	3
1 1/4" • Brushed Nickel (BN)				
LR8716D3BN▲	45.65	16" Designer Grab Bar	Brushed Nickel	3
LR8724D3BN▲	53.20	24" Designer Grab Bar	Brushed Nickel	3



Designer Ultima Grab Bar
LR8716D3 |

DESIGNER ELITE - 1 1/4" DIAMETER CONCEALED SCREW

MODEL	LIST PRICE	DESCRIPTION	FINISH	QTY
1 1/4" • Chrome (CH)				
LR8724D2CH▲	47.85	24" Designer Grab Bar	Chrome	3
1 1/4" • Brushed Nickel (BN)				
LR8724D2BN▲	53.25	24" Designer Grab Bar	Brushed Nickel	3



Designer Elite Grab Bar
LR8724D2 |

▲ Retail Packaging

ADA-Compliant

SecureMount™ for non-stud installation sold separately. See page 528 for details.
List price is per each (unless otherwise noted). Product can be ordered by case quantity or individually.

Grab Bars

DESIGNER ULTIMA WITH CURL GRIP - 1 1/4" DIAMETER CONCEALED SCREW				
MODEL	LIST PRICE	DESCRIPTION	FINISH	QTY
1 1/4" • Chrome (CH)				
R8712D3GCH	58.40	12" Designer Grab Bar	Chrome	6
LR8716D3GCH▲	64.25	16" Designer Grab Bar	Chrome	3
R8718D3GCH	64.00	18" Designer Grab Bar	Chrome	6
LR8724D3GCH▲	70.40	24" Designer Grab Bar	Chrome	3
R8736D3GCH	106.65	36" Designer Grab Bar	Chrome	6
R8742D3GCH	129.25	42" Designer Grab Bar	Chrome	6
R8748D3GCH	147.30	48" Designer Grab Bar	Chrome	6
1 1/4" • Brushed Nickel (BN)				
R8712D3GBN	63.95	12" Designer Grab Bar	Brushed Nickel	6
LR8716D3GBN▲	65.70	16" Designer Grab Bar	Brushed Nickel	3
R8718D3GBN	72.65	18" Designer Grab Bar	Brushed Nickel	6
LR8724D3GBN▲	76.70	24" Designer Grab Bar	Brushed Nickel	3
R8736D3GBN	107.65	36" Designer Grab Bar	Brushed Nickel	6
R8742D3GBN	130.50	42" Designer Grab Bar	Brushed Nickel	6
R8748D3GBN	149.50	48" Designer Grab Bar	Brushed Nickel	6
1 1/4" • Old World Bronze (OWB)				
R8712D3GOWB	76.70	12" Designer Grab Bar	Old World Bronze	6
LR8716D3GOWB▲	77.70	16" Designer Grab Bar	Old World Bronze	3
R8718D3GOWB	85.65	18" Designer Grab Bar	Old World Bronze	6
LR8724D3GOWB▲	90.90	24" Designer Grab Bar	Old World Bronze	3
R8736D3GOWB	127.35	36" Designer Grab Bar	Old World Bronze	6
R8742D3GOWB	152.95	42" Designer Grab Bar	Old World Bronze	6
R8748D3GOWB	174.25	48" Designer Grab Bar	Old World Bronze	6



**Designer
Ultima Grab Bar
with Curl Grips**
R8718D3G | 

COORDINATING
ACCESSORIES

▲ Retail Packaging

 ADA-Compliant

SecureMount™ for non-stud installation sold separately. See page 528 for details.
List price is per each (unless otherwise noted). Product can be ordered by case quantity or individually.

1 1/4" DIAMETER CONCEALED SCREW

MODEL	LIST PRICE	DESCRIPTION	FINISH	QTY
1 1/4" • Stainless (SS)				
DN8712	30.20	12" Grab Bar	Stainless	6
8716	33.65	16" Grab Bar	Stainless	6
8718	34.90	18" Grab Bar	Stainless	6
8724	36.05	24" Grab Bar	Stainless	6
8730	40.70	30" Grab Bar	Stainless	6
8732	42.80	32" Grab Bar	Stainless	6
8736	47.65	36" Grab Bar	Stainless	6
8742	51.55	42" Grab Bar	Stainless	6
8748	56.65	48" Grab Bar	Stainless	6
1 1/4" • Polished Stainless (PS)				
R8718PS	43.30	18" Grab Bar	Polished Stainless	6
LR8724PS	51.85	24" Grab Bar	Polished Stainless	3
R8724PS	47.45	24" Grab Bar	Polished Stainless	6
R8736PS	55.95	36" Grab Bar	Polished Stainless	6
R8742PS	68.45	42" Grab Bar	Polished Stainless	6
1 1/4" • Polished Brass (PB)				
R8718PB	85.05	18" Grab Bar	Polished Brass	6
R8724PB	101.70	24" Grab Bar	Polished Brass	6
1 1/4" • Glacier (W)				
R8712W	39.90	12" Grab Bar	Glacier	6
R8716W	45.95	16" Grab Bar	Glacier	6
R8718W	48.20	18" Grab Bar	Glacier	6
R8724W	52.35	24" Grab Bar	Glacier	6
R8730W	57.60	30" Grab Bar	Glacier	6
R8732W	59.30	32" Grab Bar	Glacier	6
R8736W	64.20	36" Grab Bar	Glacier	6
R8742W	70.70	42" Grab Bar	Glacier	6
R8748W	72.15	48" Grab Bar	Glacier	6
1 1/4" • Peened (P)				
R8712P	28.50	12" Grab Bar	Peened	6
R8716P	31.80	16" Grab Bar	Peened	6
R8718P	33.60	18" Grab Bar	Peened	6
R8724P	38.30	24" Grab Bar	Peened	6
R8730P	45.35	30" Grab Bar	Peened	6
R8732P	43.30	32" Grab Bar	Peened	6
R8736P	51.35	36" Grab Bar	Peened	6
R8742P	55.20	42" Grab Bar	Peened	6
R8748P	65.25	48" Grab Bar	Peened	6
1 1/4" • Matte Black (BL)				
R8712BL	37.75	12" Grab Bar	Matte Black	6 NEW!
R8716BL	42.10	16" Grab Bar	Matte Black	6 NEW!
R8718BL	43.60	18" Grab Bar	Matte Black	6 NEW!
R8724BL	45.10	24" Grab Bar	Matte Black	6 NEW!
R8730BL	50.90	30" Grab Bar	Matte Black	6 NEW!
R8732BL	53.50	32" Grab Bar	Matte Black	6 NEW!
R8736BL	59.55	36" Grab Bar	Matte Black	6 NEW!
R8742BL	64.45	42" Grab Bar	Matte Black	6 NEW!
R8748BL	70.85	48" Grab Bar	Matte Black	6 NEW!



**1 1/4" Diameter
Concealed Screw
Grab Bar**

8716 | 



**1 1/4" Diameter
Concealed Screw
Peened Grab Bar**

R8724P | 

**COORDINATING
ACCESSORIES**



SecureMount™ for non-stud installation sold separately. See page 528 for details.
List price is per each (unless otherwise noted). Product can be ordered by case quantity or individually.

Grab Bars

1 1/2" DIAMETER CONCEALED SCREW

MODEL	LIST PRICE	DESCRIPTION	FINISH	QTY
1 1/2" • Stainless (SS)				
R8912	32.25	12" Grab Bar	Stainless	6
R8916	34.85	16" Grab Bar	Stainless	6
R8918	38.30	18" Grab Bar	Stainless	6
R8924	43.30	24" Grab Bar	Stainless	6
R8930	46.65	30" Grab Bar	Stainless	6
R8932	46.60	32" Grab Bar	Stainless	6
R8936	53.10	36" Grab Bar	Stainless	6
R8942	58.10	42" Grab Bar	Stainless	6
DN8948	65.80	48" Grab Bar	Stainless	6



**1 1/2" Diameter
Concealed Screw
Grab Bar**
R8916 |



**1 1/2" Diameter
Concealed Screw
Grab Bar - Glacier**
R8918W |



**1 1/2" Diameter
Concealed Screw
Grab Bar - Peened**
R8916P |



**24" x 36" L-Shaped
Grab Bar - Peened**
8994 |

1 1/2" • Glacier (W)

R8912W	49.75	12" Grab Bar	Glacier	6
R8918W	61.05	18" Grab Bar	Glacier	6
R8924W	66.15	24" Grab Bar	Glacier	6
R8930W	66.15	30" Grab Bar	Glacier	6
R8932W	71.45	32" Grab Bar	Glacier	6
R8936W	75.55	36" Grab Bar	Glacier	6
R8942W	88.05	42" Grab Bar	Glacier	6
R8948W	90.75	48" Grab Bar	Glacier	6

1 1/2" • Peened (P)

R8912P	33.15	12" Grab Bar	Peened	6
R8916P	33.60	16" Grab Bar	Peened	6
R8918P	40.00	18" Grab Bar	Peened	6
R8924P	45.35	24" Grab Bar	Peened	6
R8930P	49.10	30" Grab Bar	Peened	6
R8932P	49.15	32" Grab Bar	Peened	6
R8936P	56.40	36" Grab Bar	Peened	6
R8942P	60.75	42" Grab Bar	Peened	6
R8948P	62.60	48" Grab Bar	Peened	6
8994	113.50	24" x 36" L-shaped Grab Bar	Peened	3
8996	121.00	24" x 48" L-shaped Grab Bar	Peened	3

1 1/2" • Matte Black (BL)

R8912BL	40.30	12" Grab Bar	Matte Black	6	NEW!
R8916BL	43.55	16" Grab Bar	Matte Black	6	NEW!
R8918BL	47.90	18" Grab Bar	Matte Black	6	NEW!
R8924BL	54.10	24" Grab Bar	Matte Black	6	NEW!
R8930BL	58.35	30" Grab Bar	Matte Black	6	NEW!
R8932BL	62.95	32" Grab Bar	Matte Black	6	NEW!
R8936BL	66.35	36" Grab Bar	Matte Black	6	NEW!
R8942BL	72.60	42" Grab Bar	Matte Black	6	NEW!
R8948BL	82.25	48" Grab Bar	Matte Black	6	NEW!

COORDINATING
ACCESSORIES

COORDINATING ACCESSORIES

1 1/4" DIAMETER EXPOSED SCREW

MODEL	LIST PRICE	DESCRIPTION	FINISH	QTY
1 1/4" • Stainless (SS)				
7412	24.70	12" Grab Bar	Stainless	6
R7418	22.70	18" Grab Bar	Stainless	6
R7424	25.80	24" Grab Bar	Stainless	6
R7436	35.95	36" Grab Bar	Stainless	6
R7442	38.90	42" Grab Bar	Stainless	6



1 1/4" Diameter Exposed Screw Grab Bar - Stainless
7412 |

1 1/2" DIAMETER EXPOSED SCREW

MODEL	LIST PRICE	DESCRIPTION	FINISH	QTY
1 1/2" • Stainless (SS)				
LR7518▲	30.20	18" Grab Bar	Stainless	3
LR7524▲	34.40	24" Grab Bar	Stainless	3
LR7536▲	43.50	36" Grab Bar	Stainless	3
LR7542▲	48.40	42" Grab Bar	Stainless	3



1 1/2" Diameter Exposed Screw Grab Bar - Stainless
LR7518 |

FLIP UP GRAB BARS

MODEL	LIST PRICE	DESCRIPTION	FINISH	QTY
1 1/4" • Peened (P)				
R8960FD	180.90	30" Flip Up Grab Bar	Peened	2
R8962FD	207.00	30" Flip Up Grab Bar with Paper Holder	Peened	2
1 1/4" • Glacier (W)				
R8960FDW	177.40	30" Flip Up Grab Bar	Glacier	2
R8962FDW	196.55	30" Flip Up Grab Bar with Paper Holder	Glacier	2

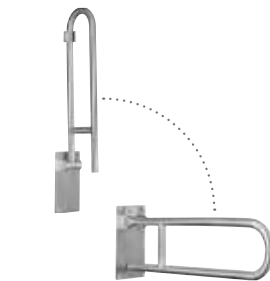

Flip-Up Grab Bar
R8960FD |

▲ Retail Packaging

ADA-Compliant

SecureMount™ for non-stud installation sold separately. See page 528 for details.
List price is per each (unless otherwise noted). Product can be ordered by case quantity or individually.

Grab Bars

GRAB BARS WITH ACCESSORIES

MODEL	LIST PRICE	DESCRIPTION	FINISH	QTY
1½" • Chrome (CH)				
LR2350DCH▲	73.40	24" Grab Bar With Towel Bar	Chrome	3
LR2352DCH▲	73.40	8" Grab Bar With Paper Holder	Chrome	3
LR2354DCH▲	73.40	9" Grab Bar With Corner Shelf	Chrome	3
LR2356DCH▲	73.40	16" Grab Bar With Shelf	Chrome	3
1½" • Brushed Nickel (BN)				
LR2350DBN	76.30	24" Grab Bar With Towel Bar	Brushed Nickel	3
LR2352DBN	70.60	8" Grab Bar With Paper Holder	Brushed Nickel	3
LR2354DBN	76.30	9" Grab Bar With Corner Shelf	Brushed Nickel	3
R2356DBN	78.60	16" Grab Bar With Shelf	Brushed Nickel	3

COORDINATING ACCESSORIES



24" Grab Bar with Towel Bar

LR2350D |



8" Grab Bar with Paper Holder

LR2352D |



8" Grab Bar with Corner Shelf

LR2354D |



16" Grab Bar with Shelf

LR2356D/R2356D |

SECUREMOUNT™ ANCHORS

MODEL	LIST PRICE	DESCRIPTION	FINISH	QTY
1½" • Chrome (CH)				
SMA1000CH	40.15	SecureMount™ Anchors and Plate - One Pair	Chrome	24
SMA1001CH	38.45	SecureMount™ Anchors and Plates - 10 Pairs	Chrome	10
1½" • Old World Bronze (OWB)				
SMA1000OWB	43.35	SecureMount™ Anchor and Plates - 1 Pair	Old World Bronze	24



SecureMount™ - One Pair
SMA1000CH



SecureMount™ - ProPak of 10 Pairs
SMA1001

HAND GRIPS

MODEL	LIST PRICE	DESCRIPTION	FINISH	QTY
1½" • Chrome (CH)				
LR2250DCH▲	27.25	9" Designer Hand Grip - Non-Exposed Screws	Chrome	3
R2250	19.20	9" Hand Grip	Chrome	6
R2260	23.10	16" Hand Grip	Chrome	6
R2270	27.40	24" Hand Grip	Chrome	6



Designer Hand Grip
LR2250DCH



Hand Grip
R2250

▲ Retail Packaging

ADA-Compliant

SecureMount™ for non-stud installation sold separately. See page 528 for details.
List price is per each (unless otherwise noted). Product can be ordered by case quantity or individually.

TUB/SHOWER CHAIRS, SEATS, TRANSFER BENCHES				
MODEL	LIST PRICE	DESCRIPTION	FINISH	QTY
DN7110	487.20	Fold-Down Teak Shower Seat	Wood/Stainless Steel	2
DN71100WB	565.25	Fold-Down Teak Shower Seat	Wood/Old World Bronze	2
DN7060▲	104.05	Adjustable Tool-Free Tub and Shower Chair	Glacier	2
DN7025▲	62.40	Adjustable Tub and Shower Seat	Glacier	2
DN7030▲	79.55	Adjustable Shower Seat	Glacier	2
DN7100▲	140.05	Mesh Shower Chair	Glacier	2
DN7105▲	180.10	Transfer Bench	Glacier	2



Teak Shower Seat*
DN7110 | ♿



Adjustable Tub and Shower Chair
DN7060 | ♿



Adjustable Tub and Shower Seat
DN7025 | ♿



Adjustable Shower Chair
DN7030 | ♿



Mesh Shower Chair
DN7100 | ♿



Transfer Bench
DN7105 | ♿

COORDINATING ACCESSORIES

*The natural properties of Teak allow for the wood to weather over time in the environment. If you desire to keep the current look of the wood, treat the teak with a certified Teak oil.

▲ Retail Packaging

♿ ADA-Compliant

SecureMount™ for non-stud installation sold separately. See page 528 for details. List price is per each (unless otherwise noted). Product can be ordered by case quantity or individually.

Bath Safety

TOILET, TUB AND SHOWER SAFETY

MODEL	LIST PRICE	DESCRIPTION	FINISH	QTY
DN7020▲	43.55	Elevated Toilet Seat	Glacier	2
DN7015▲	45.95	Toilet Safety Rails	Glacier	2
DN7175▲	73.60	SecureLock™ Tub Grip	Glacier	2
DN7075▲	104.35	Locking Dual Tub Grip	Glacier	2
DN7005▲	47.00	Multi-Grip Tub Safety Bar	Glacier	2
DN7010▲	38.05	Low-Profile Tub Safety Bar	Glacier	2
DN7050▲	19.85	Bath Mat	Glacier	24

COORDINATING ACCESSORIES



Elevated Toilet Seat
DN7020 |



Toilet Safety Rails
DN7015 |



Tub Grip
DN7175 |



Tub Grip
DN7075 |



Tub Safety Bar
DN7005 |



Tub Safety Bar
DN7010 |



Bath Mat
DN7050

HANDHELD SHOWERS

MODEL	LIST PRICE	DESCRIPTION	FINISH	QTY
DN8001CH▲	64.70	Pause Control Handheld Shower	Chrome	3
DN8001W▲	58.40	Pause Control Handheld Shower	Glacier	3



Handheld Shower
DN8001CH |



Handheld Shower
DN8001W |

▲ Retail Packaging

ADA-Compliant

SecureMount™ for non-stud installation sold separately. See page 528 for details.
List price is per each (unless otherwise noted). Product can be ordered by case quantity or individually.

Matching Accessories

PREMIUM / BEST

- Weymouth** — Traditional
- Arris** — Modern
- Flara** — Transitional
- Colinet** — Traditional
- 90°** — Modern
- Doux** — Modern

2ND UPGRADE / BETTER

- Greenfield** — Transitional
- Wynford** — Traditional
- Align** — Modern
- Belfield** — Traditional
- Voss** — Transitional

1ST UPGRADE / GOOD

- Dartmoor** — Traditional
- Glyde** — Transitional
- Brantford** — Traditional
- Eva** — Transitional
- Genta LX** — Modern

Coordinating Accessories

2ND UPGRADE / BETTER

- Kingsley**® — Traditional
- Kyvos**® — Modern
- Iso**™ — Modern

1ST UPGRADE / GOOD

- Arlys**™ — Modern
- Triva**™ — Modern

CORE

- Preston**™ — Traditional
- Madison**™ — Traditional
- Sage**® — Transitional
- Lounge**™ — Transitional
- Retreat**® — Traditional
- Mirror Only
- Gilcrest**® — Traditional
- Glenshire**® — Traditional

SPEC

- Aspen**™ — Modern
- Mason**® — Transitional
- Donner** — Transitional

COORDINATING ACCESSORIES













Moen® Genuine Replacement Parts



Please see [moen.com/customer-support/warranty](https://www.moen.com/customer-support/warranty) for complete product warranty information.









All Brushed Nickel, Brushed Gold and Polished Brass faucet components feature the LifeShine® Non-Tarnish Finish.

Merchandising Solutions

		MODEL	LIST	FINISH/CONNECT	CASE QTY
CARDED PARTS - SHOWERING					
	<ul style="list-style-type: none"> • 6" shower arm and flange • connection size: 1/2" • connection type: IPS 	CL10154	37.55	Chrome	12
		CL10154BN	75.85	Brushed Nickel	12
	<ul style="list-style-type: none"> • 8" shower arm and flange • connection size: 1/2" • connection type: IPS 	CL123815	46.95	Chrome	12
		CL123815BN	88.65	Brushed Nickel	12
	<ul style="list-style-type: none"> • handshower wall bracket • integral handshower cradle: included • pivots to adjust angle of handshower 	CL155694	30.95	Chrome	12
		CL155694BN	44.75	Brushed Nickel	12
	<ul style="list-style-type: none"> • handshower hose • connection size: 1/2" • connection type: IPS • hose length: 59" • metal construction: yes 	CL155748	47.85	Chrome	12
		CL155748BN	69.40	Brushed Nickel	12
	<ul style="list-style-type: none"> • replacement handshower • showerhead functions: one-function • showerhead type: eco-performance handshower • showerhead size: 4" diameter spray head • type of function: full spray • double check valve: included 	Flow Rate:	1.75 gpm (6.65 L/min) max		
		CL155747	80.10	Chrome	6
		CL155747BN	116.20	Brushed Nickel	6
	<ul style="list-style-type: none"> • replacement handshower • showerhead functions: four-function • showerhead type: eco-performance handshower • showerhead size: 4" diameter spray head • type of function: combination; full spray; invigorating spray; targeted massage • double check valve: included 	Flow Rate:	1.75 gpm (6.65 L/min) max		
		CL164928	95.70	Chrome	6
		CL164928BN	138.75	Brushed Nickel	6
	<ul style="list-style-type: none"> • showerhead functions: five-function • connection size: 1/2" • connection type: IPS • showerhead type: standard, eco-performance • showerhead size: 4" diameter spray head • type of function: energizing spray; invigorating spray; refreshing spray; relaxing spray; targeted massage 	Flow Rate:	2.5 gpm (9.5 L/min) max		
		CL26500	68.95	Chrome	12
		CL26500BN	112.50	Brushed Nickel	12
	<ul style="list-style-type: none"> • showerhead functions: five-function • connection size: 1/2" • connection type: IPS • showerhead type: standard, eco-performance • showerhead size: 4" diameter spray head • type of function: energizing spray; invigorating spray; refreshing spray; relaxing spray; targeted massage 	Flow Rate:	1.75 gpm (6.65 L/min) max		
		CL26500EP	68.95	Chrome	12
		CL26500EPBN	112.50	Brushed Nickel	12
	<ul style="list-style-type: none"> • showerhead functions: one-function • connection size: 1/2" • connection type: IPS • showerhead type: standard, eco-performance • showerhead size: 4-3/8" diameter spray head • type of function: full spray 	Flow Rate:	2.5 gpm (9.5 L/min) max		
		CL6302	117.05	Chrome	12
		CL6302BN	182.70	Brushed Nickel	12
	<ul style="list-style-type: none"> • showerhead functions: one-function • connection size: 1/2" • connection type: IPS • showerhead type: standard, eco-performance • showerhead size: 4-3/8" diameter spray head • type of function: full spray 	Flow Rate:	1.75 gpm (6.65 L/min) max		
		CL6302EP	117.05	Chrome	12
		CL6302EPBN	182.70	Brushed Nickel	12

GENUINE PARTS

Merchandising Solutions

		MODEL	LIST	FINISH/CONNECT	CASE QTY		
CARDER PARTS - SHOWERING (CONTINUED)							
	<ul style="list-style-type: none"> • showerhead functions: one-function • connection size: 1/2" • connection type: IPS • showerhead type: standard, eco-performance • showerhead size: 3-1/2" diameter spray head • type of function: full spray 	Flow Rate:	2.5 gpm (9.5 L/min) max				
		CL6303	64.70	Chrome	12		
		CL6303BN	99.15	Brushed Nickel	12		
		Flow Rate:	1.75 gpm (6.65 L/min) max				
		CL6303EP	64.70	Chrome	12		
		CL6303EPBN	99.15	Brushed Nickel	12		
	<ul style="list-style-type: none"> • shower arm diverter • connection size: 1/2" • connection type: IPS • type of function: two independent, one shared • metal construction: yes 	CL703	107.05	Chrome	12		
		CL703BN	155.15	Brushed Nickel	12		
		CL703ORB	170.75	Oil Rubbed Bronze	12		
		CL703BL	170.75	Matte Black	12		
		CL707	145.35	Chrome	12		
	<ul style="list-style-type: none"> • shower arm diverter • connection size: 1/2" • connection type: IPS • type of function: two independent, one shared • integral handshower cradle: included • metal construction: yes • pivots to adjust angle of handshower 	CL707BN	210.70	Brushed Nickel	12		
		CL707ORB	231.80	Oil Rubbed Bronze	12		
		CL707BL	231.80	Matte Black	12		
		CLA701	62.85	Chrome	12		
		CLA701BN	90.90	Brushed Nickel	12		
	<ul style="list-style-type: none"> • shower arm cradle • connection size: 1/2" • connection type: IPS • integral handshower cradle: included • metal construction: yes • pivots to adjust angle of handshower 	CL1200	52.90	Carded	36		
		CARDER PARTS - MOEN® GENUINE REPLACEMENT CARTRIDGES					
			<ul style="list-style-type: none"> • 1200® cartridge • single-handle replacement cartridge, brass 	1200	52.90	Carded	36
				CARDER PARTS - MOEN® GENUINE REPLACEMENT CARTRIDGES			
			<ul style="list-style-type: none"> • 1225® cartridge • single-handle replacement cartridge 	1225	33.35	Carded	36
CARDER PARTS - MOEN® GENUINE REPLACEMENT CARTRIDGES							
	<ul style="list-style-type: none"> • 1224® cartridge • two-handle replacement cartridge (hot or cold) 	1224	17.35	Carded	36		
		CARDER PARTS - MOEN® GENUINE REPLACEMENT CARTRIDGES					
	<ul style="list-style-type: none"> • 1215® cartridge • single-handle replacement cartridge for high-flow wallmount tub filler 	1215	110.00	Carded	12		
		CARDER PARTS - MOEN® GENUINE REPLACEMENT CARTRIDGES					
	<ul style="list-style-type: none"> • 1248® cartridge • two-handle replacement cartridge for high-flow roman tubs (hot or cold) 	1248	17.35	Carded	18		

Merchandising Solutions











		MODEL	LIST	FINISH/CONNECT	CASE QTY
CARDED PARTS - MOEN GENUINE REPLACEMENT CARTRIDGES (CONTINUED)					
	<ul style="list-style-type: none"> • 1234° cartridge • two-handle Duralast® cartridge for two-handle lavatory and kitchen faucets (hot or cold) 	1234	16.80	Carded	18
	<ul style="list-style-type: none"> • 1258° cartridge • two-handle Duralast® cartridge for two-handle roman tub faucets (hot or cold) 	1258	17.40	Carded	18
	<ul style="list-style-type: none"> • 1222° cartridge • single-handle replacement cartridge, Posi-Temp® 	1222	88.30	Carded	18
	<ul style="list-style-type: none"> • 1255° cartridge • single-handle Duralast® cartridge • includes plastic retaining nut 	1255	34.15	Carded	72
	<ul style="list-style-type: none"> • 1214° cartridge • thermostatic replacement cartridge for M-CORE® 4-Series 	1214	389.00	Carded	12
	<ul style="list-style-type: none"> • 1213° cartridge • single-handle replacement cartridge, M-CORE® 3-Series 	1213	110.00	Carded	12
	<ul style="list-style-type: none"> • 1212° cartridge • single-handle replacement cartridge, M-CORE® 2-Series 	1212	85.00	Carded	12
	<ul style="list-style-type: none"> • cartridge repair kit for 1222° /1222B° Posi-Temp® single-handle tub/shower 	98040	17.90	Carded	18
	<ul style="list-style-type: none"> • retainer clips for 1200° and 1225° single-handle cartridges 	96365	10.10	Carded	36
	<ul style="list-style-type: none"> • cartridge puller for 1200°, 1222° & 1225° single-handle cartridges 	104421	56.45	Carded	36
	<ul style="list-style-type: none"> • spout o-ring kit • order in multiples of 12 	96778 117	10.85 7.25	Carded Bulk (12 pcs)	36 72

Merchandising Solutions

		MODEL	LIST	FINISH/CONNECT	CASE QTY
CARDED PARTS - HANDLES					
	• handle kit with cap for Chateau® single-handle lav with 1225® cartridge	96782	33.70	Carded	18
	• handle kit, Chateau® single-handle lav, clear knob with cap	98039	33.70	Carded	18
	• handle cap, Chateau® single-handle lav and non-pressure-balancing shower	98032	13.25	Carded	18
	• handle kit, Posi-Temp® single-handle tub/shower with cap	100710	24.95	Carded	18
	• handle kit, Chateau® two-handle lav, kitchen, and tub/shower, clear handles with caps, quantity 2	98026	39.10	Carded	12
	• handle caps, Touch Control two-handle lav, kitchen, bar, and tub/shower	101205	12.95	Carded	18
	• handle insert for two-handle Monticello bath faucet	97557	68.85	Carded	36
CARDED PARTS - AERATORS					
	• aerator, 2.2 gpm, male thread	3919	16.95	Chrome (Carded)	18
	• aerator, 2.2 gpm, female thread	3924	16.95	Chrome (Carded)	18
	• aerator, Swing-n-Spray®, 2.2 gpm	20200	58.30	Chrome (Carded)	18

GENUINE PARTS

Merchandising Solutions





		MODEL	LIST	FINISH/CONNECT	CASE QTY
MOEN® GENUINE REPLACEMENT CARTRIDGES					
	<ul style="list-style-type: none"> • 1200® cartridge • single-handle replacement cartridge, brass, order in multiples of 12 	1200	52.90	Carded	36
		1200B	52.90	Bulk (12 pcs.)	144
	<ul style="list-style-type: none"> • 1225® cartridge • single-handle replacement cartridge, order in multiples of 12 	1225	33.35	Carded	36
		1225B	33.35	Bulk (12 pcs.)	144
	<ul style="list-style-type: none"> • 1224® cartridge • two-handle replacement cartridge (hot or cold), order in multiples of 12 • two-handle replacement cartridge, for 4997 valve prior to 6/00 	1224	17.35	Carded	36
		1224B	17.35	Bulk (12 pcs.)	144
		14891	21.15	-	60
	<ul style="list-style-type: none"> • 1215® cartridge • single-handle replacement cartridge for high-flow wallmount tub filler 	1215	110.00	Carded	12
	<ul style="list-style-type: none"> • 1248™ cartridge • two-handle replacement cartridge for high-flow roman tubs, order in multiples of 12 	1248	17.35	Carded	18
		1248B	17.35	Bulk (12 pcs.)	144
	<ul style="list-style-type: none"> • 1234® cartridge • two-handle Duralast® cartridge for two-handle lavatory and kitchen faucets (hot or cold) 	1234	16.80	Carded	18
	<ul style="list-style-type: none"> • 1258® cartridge • two-handle Duralast® cartridge for two-handle roman tub faucets (hot or cold) 	1258	17.40	Carded	18
	<ul style="list-style-type: none"> • 1222® cartridge • single-handle replacement cartridge, Posi-Temp®, order in multiples of 6 • repair kit 96988 	1222	88.30	Carded	18
		1222B	88.30	Bulk (6 pcs.)	72
	<ul style="list-style-type: none"> • brass Posi-Temp® cartridge • single-handle replacement cartridge • graphite composite pressure-balancing spool design 	1222HD	110.35	-	18
	<ul style="list-style-type: none"> • 1255® cartridge • single-handle Duralast® cartridge • includes plastic retaining nut 	1255	34.15	Carded	72

GENUINE PARTS

Merchandising Solutions









		MODEL	LIST	FINISH/CONNECT	CASE QTY
MOEN® GENUINE REPLACEMENT CARTRIDGES (CONTINUED)					
	<ul style="list-style-type: none"> • single-handle Duralast® cartridge • includes plastic retaining nut • brass nut • use with 90° kitchen faucets 	150257	46.95	Bulk	50
	<ul style="list-style-type: none"> • 1214® cartridge • thermostatic replacement cartridge for M-CORE® 4-Series 	1214	389.00	Carded	12
	<ul style="list-style-type: none"> • 1213® cartridge • single-handle replacement cartridge, M-CORE® 3-Series 	1213	110.00	Carded	18
	<ul style="list-style-type: none"> • 200759 cartridge • cartridge replacement for M-CORE® transfer valves U361CX, U361X, and U361CX • 3 function (2 independent/1 shared) or 6 function (3 independent/3 shared) cartridge 	200759	39.75	Carded	20
	<ul style="list-style-type: none"> • 200758 cartridge • cartridge replacement for M-CORE® transfer valves U231CX, U231X, and U231CX • 2 independent or 3 independent functions cartridge; no shared function 	200758	33.30	Carded	20
	<ul style="list-style-type: none"> • 1212® cartridge • single-handle replacement cartridge, M-CORE® 2-Series 	1212	85.00	Carded	12
CARTRIDGE REPAIR KIT					
	<ul style="list-style-type: none"> • cartridge repair kit for 1222/1222B Posi-Temp® single-handle tub/shower 	98040	17.90	Carded	18
		96988	20.80	-	100
	<ul style="list-style-type: none"> • Moen® silicone oil for Posi-Temp® balancing spools • Moen® silicone grease for cartridges and o-rings • order in multiples of 12 	140676	6.65	-	96
		99915	0.25	-	2500
CARTRIDGE RETAINER CLIPS					
	<ul style="list-style-type: none"> • retainer clips for 1200® and 1225® single-handle cartridges 	96365	10.10	Carded	36
	<ul style="list-style-type: none"> • retainer clips for Posi-Temp® single-handle tub/shower 	96914	6.90	-	500

Merchandising Solutions



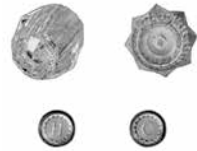







		MODEL	LIST	FINISH/CONNECT	CASE QTY
TOOLS					
	<ul style="list-style-type: none"> cartridge puller for 1200°, 1222° & 1225° single-handle cartridges 	104421	56.45	Carded	36
	<ul style="list-style-type: none"> cartridge retainer removal tool for 1224°, 1234°, 1248° & 1258° two-handle cartridge 	14272	7.70	-	150
	<ul style="list-style-type: none"> installation tool for roman tub valves (4792, 7493, 4992, 4993) with adjustable shank 	150313	10.80	-	12
	<ul style="list-style-type: none"> installation tool, non-metallic for widespreads, and single-mount lavs, and kitchen 	118305	15.00	-	100
O-RING KIT					
	<ul style="list-style-type: none"> spout o-ring kit order in multiples of 12 	96778	10.85	Carded	36
		117	7.25	Bulk (12 pcs)	72

GENUINE PARTS

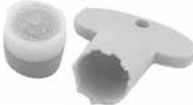
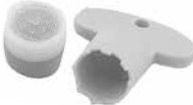
Merchandising Solutions









		MODEL	LIST	FINISH/CONNECT	CASE QTY
REPLACEMENT HANDLES AND CAPS					
	• handle kit with cap for Chateau® single handle-lav with 1225 cartridge	96782	33.70	Carded	18
		96791	33.70	-	150
	• handle kit, Chateau® single-handle tub/shower	98039	33.70	Carded	18
	• handle kit, Chateau® single-handle tub/shower	96797	34.95	-	150
	• handle kit with cap for Chateau® single-handle lav with 1255° Duralast™ cartridge	150627	34.95	-	50
	• handle cap kit, Chateau® single-handle lav and non-pressure-balancing shower	98032	13.25	Carded	18
	• handle cap kit, Chateau® single-handle pressure-balanced tub/shower	91751	13.25	-	1,000
	• handle kit, Posi-Temp® single-handle tub/shower with cap	100710	24.95	Carded	18
	• handle kit, less cap, Posi-Temp® single-handle tub/shower	94514	13.75	-	150
	• handle kit, Chateau® two-handle lav, kitchen, and tub/shower, clear handles with caps, quantity 2	98026	39.10	Carded	12
	• lever handle cap, Chateau® single-handle kitchen	96790	34.95	Chrome	250
	• handle caps, Chateau® two-handle lav, kitchen, bar, and tub/shower	13382	12.95	-	300
	• handle caps, Touch Control® two-handle lav, kitchen, bar, and tub/shower	101205	12.95	Carded	18
	• handle insert for two-handle Monticello bath faucet	97557	68.85	Carded	36





Merchandising Solutions











		MODEL	LIST	FINISH/CONNECT	CASE QTY
ECO-PERFORMANCE AERATOR INSERTS					
	<ul style="list-style-type: none"> aerator flow restrictor: 1.2 gpm aerated flow fits: Flara®, Colinet™, Voss™, Brantford®, Eva®, Belfield™, and Rothbury® 	180158	11.30	-	20
	<ul style="list-style-type: none"> aerator flow restrictor, 1.5 gpm aerated flow fits Chateau®, Castleby®, Villeta®, Eva®, Brantford®, Level™, Monticello®, Kingsley®, Waterhill® and Vestige® lavatory or kitchen faucets 	116711	8.35	-	500
	<ul style="list-style-type: none"> aerator flow restrictor, 1.0 gpm aerated flow fits Chateau®, Castleby®, Villeta®, Eva®, Brantford®, Level™, Monticello®, Kingsley®, Waterhill® and Vestige® lavatory or kitchen faucets 	216721	8.40	-	700
	<ul style="list-style-type: none"> aerator flow restrictor, 1.5 gpm laminar flow for use on all Icon™ and Divine™ lavatory faucets 	316711	8.40	-	350
	<ul style="list-style-type: none"> aerator flow restrictor, 1.2 gpm aerated flow for use on Arris®, Align®, Gibson™, Icon™ and Vichy® lavatory faucets 	181085	11.55	-	100
	<ul style="list-style-type: none"> aerator flow restrictor, 0.5 gpm laminar flow for use on Arris®, Align®, Gibson™ and Icon™ and Vichy® lavatory faucets 	175083	8.40	-	200
	<ul style="list-style-type: none"> aerator flow restrictor, 1.0 gpm laminar flow for use on Arris®, Align®, Gibson™, Icon™ and Vichy® lavatory faucets 	175084	8.40	-	350
	<ul style="list-style-type: none"> aerator flow restrictor, 1.0 gpm aerated flow for use on Arris®, Align®, Gibson™, Icon™ and Vichy® lavatory faucets 	184082	11.85	-	50
	<ul style="list-style-type: none"> aerator flow restrictor, 1.5 gpm laminar flow for use on Felicity™, Savvy™, Organic™, Waterhill® and Tres Chic™ lavatory faucets 	416711	8.40	-	200
	<ul style="list-style-type: none"> aerator flow restrictor, 0.5 gpm rosetta spray fits Chateau®, Castleby®, Villeta®, Eva®, Brantford®, Level™, Monticello®, Kingsley®, and Vestige® lavatory or kitchen faucets 	516711	8.40	-	500
	<ul style="list-style-type: none"> aerator flow restrictor, 0.5 gpm vandal proof fits Chateau® lavs removal tool included 	52016	23.10	-	24











GENUINE PARTS













Merchandising Solutions

		MODEL	LIST	FINISH/CONNECT	CASE QTY
ECO-PERFORMANCE AERATOR INSERTS (CONTINUED)					
	<ul style="list-style-type: none"> aerator flow restrictor, 1.0 gpm aerated flow fits Rothbury™ wallmount, Eva®, Brantford®, Danika™ and Zarina™ single-handle, and Method™ lavatory faucets 	163847	12.55	-	100
	<ul style="list-style-type: none"> aerator flow restrictor, 1.5 gpm aerated flow fits Rothbury™ wallmount, Eva® and Brantford® single-handle, and Method™ lavatory faucets 	143326	14.85	-	100
	<ul style="list-style-type: none"> aerator flow restrictor, 0.5 gpm aerated flow fits Rothbury™ single-handle, two-handle and widespreads, and Voss™ lavatory faucets 	165018	8.40	-	12
	<ul style="list-style-type: none"> aerator flow restrictor, 1.5 gpm aerated flow fits Rothbury™ single-handle, two-handle and widespreads, and Voss™ lavatory faucets 	137401	16.00	-	12
	<ul style="list-style-type: none"> aerator flow restrictor, 1.0 gpm aerated flow fits Rothbury™ single-handle, two-handle and widespreads, Rizon®, Glyde™, Dartmoor™ and Voss™ lavatory faucets 	316721	12.55	-	100
AERATORS					
	<ul style="list-style-type: none"> aerator, 2.2 gpm, male thread 	3919	16.95	Chrome (Carded)	18
	<ul style="list-style-type: none"> aerator, 2.2 gpm, female thread 	3924	16.95	Chrome (Carded)	18
SWIVEL-SPRAY AERATORS					
	<ul style="list-style-type: none"> aerator, Swing-n-Spray®, 2.2 gpm 	20200	58.30	Chrome (Carded)	18
PULLOUT/PULLDOWN HOSE MANAGEMENT SYSTEM					
	<ul style="list-style-type: none"> pullout/pulldown hose management system system helps prevent hose and weight from getting caught on under sink obstructions easy to install ships fully assembled sleeve can be cut to accommodate different cabinet sizes compatible with all Moen® kitchen pullout and pullout single-handle sidemount SKUs (excludes Aberdeen™) 	159060	22.65	Chrome	6













		MODEL	LIST	FINISH/CONNECT	CASE QTY
SIDE SPRAY SERVICE AND ADAPTER KITS					
	<ul style="list-style-type: none"> • side spray plug service kit • plug hose outlet to eliminate quick connect system kitchen side spray 	143530	10.80	-	144
	<ul style="list-style-type: none"> • side spray adapter kit • for faucets with external threads • converts side spray outlet to quick-connect 	168665	32.95	-	50
	<ul style="list-style-type: none"> • side spray adapter kit • for faucets with internal threads • converts side spray outlet to quick-connect 	168666	20.90	-	50
MOEN® AQUASUITE®					
	<ul style="list-style-type: none"> • use with: 77100 series 	9001	113.00	-	6
MOEN® CHOICEFLO™ CARBON WATER FILTRATION REPLACEMENT FILTERS					
	<ul style="list-style-type: none"> • use with: PureTouch™ classic series 	601	44.00	-	12

		MODEL	LIST	FINISH/CONNECT	CASE QTY
EXTENSION KITS					
	<ul style="list-style-type: none"> thick deck extension kit for widespread valve bodies, model 9000/69000 	175709	129.75	-	12
	<ul style="list-style-type: none"> thick deck extension kit for valves with 1/2" threaded mounting shanks 	100818 100817	40.70 38.00	-	20 100
	<ul style="list-style-type: none"> low profile mounting nut fits 1/2" threaded shanks 2 per kit 	145665	5.85	-	120
	<ul style="list-style-type: none"> deck extension kit, single-handle kitchen with quick connect system does not work with current pullout faucets that have hose through mounting shank 	137114	49.10	-	20
	<ul style="list-style-type: none"> 1/2" single-handle shower escutcheon extension fits all single-handle tub/shower with 7" escutcheon 	162	117.40	-	6
M-CORE® TRANSFER VALVE HANDLE EXTENSION KITS					
	<ul style="list-style-type: none"> 1" handle extension kit includes handle extension, set screw and 3/32" hex wrench 	200760	64.15	Chrome	12
M-CORE® HANDLE EXTENSION KITS					
	<ul style="list-style-type: none"> 1" handle extension kits for M-CORE® tub/shower valves round modern for use with Align™, Arris®, Doux®, Colinet®, Flara®, Greenfield™, Genta™ LX, Gibson™, Vichy®, Eva®, Brantford®, Glyde™, Dartmoor®, Cia™ 	200755	46.15	Chrome	15
		200755BN	75.15	Brushed Nickel	15
		200755BG	75.15	Brushed Gold	15
		200755NL	75.15	Polished Nickel	15
		200755ORB	82.50	Oil Rubbed Bronze	15
		200755BL	82.50	Matte Black	15
	<ul style="list-style-type: none"> 1" handle extension kits for M-CORE® tub/shower valves round traditional for use with Belfield®, Commercial®, Legend™, Rizon®, Weymouth®, Wynford®, Chateau®, Via® 	200779	46.15	Chrome	15
		200779BN	75.15	Brushed Nickel	15
		200779BG	75.15	Brushed Gold	15
		200779NL	75.15	Polished Nickel	15
		200779ORB	82.60	Oil Rubbed Bronze	15
		200779BL	82.60	Matte Black	15
	<ul style="list-style-type: none"> 1" handle extension kits for M-CORE® tub/shower valves square modern for use with 90 Degree® 	200780	46.15	Chrome	15
		200780BN	75.15	Brushed Nickel	15
		200780BL	82.60	Matte Black	15
	<ul style="list-style-type: none"> 1" handle extension kits for M-CORE® tub/shower valves soft square transitional for use with Voss™ 	200781	46.15	Chrome	15
		200781BN	75.15	Brushed Nickel	15
		200781BG	75.15	Brushed Gold	15
		200781NL	75.15	Polished Nickel	15
		200781ORB	82.60	Oil Rubbed Bronze	15
200781BL	82.60	Matte Black	15		











		MODEL	LIST	FINISH/CONNECT	CASE QTY
HANDLE EXTENSION KITS (CONTINUED)					
	<ul style="list-style-type: none"> • 1" handle extension kit, Posi-Temp® single-handle tub/shower • 2" handle extension kit, Posi-Temp® single-handle tub/shower • 2" handle extension kit to correct deep rough-in 	96945	43.80	Chrome	100
		96945BN	62.70	Brushed Nickel	9
		96945WR	68.90	Wrought Iron*	9
		96945BG	62.70	Brushed Gold	9
		96858	62.60	Polished Brass	1
		96955	53.25	Chrome	1
		96868	76.80	Polished Brass	1
	<ul style="list-style-type: none"> • 1" handle extension kit, Moentrol® single-handle tub/shower • *Wrought Iron can be used with Oil Rubbed Bronze 	137347	46.15	Chrome	9
		137347NL	54.85	Polished Nickel	9
		137347P	73.60	Polished Brass	9
		137347BN	75.15	Brushed Nickel	9
		137347BG	75.15	Brushed Gold	9
		137347WR	82.60	Wrought Iron*	9
	<ul style="list-style-type: none"> • 1" handle extension kit, Legend® & Chateau® single-handle tub/shower 	10399	43.30	Chrome	36
	<ul style="list-style-type: none"> • roman tub stem extension • adapts to all 3-hole roman tub valves 	106378	22.95	Chrome	250
	<ul style="list-style-type: none"> • body spray extension kit • fits TS1320, TS1322, TS1420 and TS1422 body sprays • 1" extensions 	155656	42.75	-	1
	<ul style="list-style-type: none"> • large volume control escutcheon ring • cover holes up to 2-1/2" diameter • to be used with volume control trim 	129102	43.35	Chrome	12
		129102BN	63.90	Brushed Nickel	12
		129102ORB	70.35	Oil Rubbed Bronze	12
		129102WR	70.35	Wrought Iron	12
		129102NL	63.90	Polished Nickel	12
		129102BG	63.90	Brushed Gold	12
	<ul style="list-style-type: none"> • handle extension kit for ExactTemp® shallow wall installation (thicker ring) • 3/4" extension • to be used with volume control trim 	130153	43.10	Chrome	12
		130153BN	66.15	Brushed Nickel	12
		130153NL	72.20	Polished Nickel	12
		130153ORB	72.75	Oil Rubbed Bronze	12
		130153WR	72.75	Wrought Iron	12
		130153BG	63.80	Brushed Gold	12
ONE HANDLE WALLMOUNT TUB FILLER MANIFOLD					
	<ul style="list-style-type: none"> • Spout manifold for wallmount tub filler • Required for 10" tub filler spout installation 	MANCIS	59.70	-	12
		MANCXS	59.70	-	12
		MANXS	59.70	-	12
HANDLE EXTENSION KIT - ONE HANDLE WALLMOUNT TUB FILLER					
	<ul style="list-style-type: none"> • 1" handle extension kit • one-handle wallmount tub filler • soft round modern • used with Genta, Glyde, Cia, Align, Gibson, Dartmoor, Flara, Colinet, Greenfield 	210492	56.50	Chrome	15
		210492BN	50.50	Brushed Nickel	15
		210492NL	50.50	Polished Nickel	15
		210492BL	72.75	Matte Black	15
		210492BG	63.05	Brushed Gold	15
		210492ORB	95.35	Oil Rubbed Bronze	15
	<ul style="list-style-type: none"> • 1" handle extension kit • one-handle wallmount tub filler • round traditional • used with Doux and Belfield 	210572	56.50	Chrome	15
		210572BN	60.80	Brushed Nickel	15
		210572NL	60.80	Polished Nickel	15
		210572BL	50.30	Matte Black	15
		210572ORB	64.35	Oil Rubbed Bronze	15





		MODEL	LIST	FINISH/CONNECT	CASE QTY
HANDLE EXTENSION KITS (CONTINUED)					
	<ul style="list-style-type: none"> • 1" handle extension kit • one-handle wallmount tub filler • square modern • used with 90 Degree 	210573	62.20	Chrome	15
		210573BN	87.10	Brushed Nickel	15
		210573BL	95.35	Matte Black	15
	<ul style="list-style-type: none"> • 1" handle extension kit • one-handle wallmount tub filler • soft square transitional • used with Voss 	210574	61.90	Chrome	15
		210574BN	86.70	Brushed Nickel	15
		210574NL	86.70	Polished Nickel	15
		210574BG	86.70	Brushed Gold	15
		210574ORB	95.35	Oil Rubbed Bronze	15
210574BL	95.35	Matte Black	15		
	<ul style="list-style-type: none"> • handle extension kits for models after July 2007 • 1" handle extension kit, 3-function transfer valve • <i>*Wrought Iron can be used with Oil Rubbed Bronze</i> 	135167	59.85	Chrome	9
		135167BN	109.20	Brushed Nickel	9
		135167WR	120.30	Wrought Iron*	9
	<ul style="list-style-type: none"> • thread adapter and extension • for S3371 after September 2009; 3/4" extension 	147206	110.20	-	12
	<ul style="list-style-type: none"> • 1" handle control extension kit • for use with volume control trim 	147212	41.40	-	12
	<ul style="list-style-type: none"> • 1" extension kit • for use with transfer valve trim (three-function transfer valve trim kit) • <i>*Wrought Iron can be used with Oil Rubbed Bronze</i> 	148479	33.15	Chrome	25
		148479BN	62.00	Brushed Nickel	25
		148479WR	62.40	Wrought Iron*	25
CROSS FLOW PLUG KIT					
	<ul style="list-style-type: none"> • cross flow plug and two rubber check valves • for M-CORE® mixing valve 	200763	5.85	-	12
ADJUSTABLE TEMPERATURE LIMIT STOPS					
	<ul style="list-style-type: none"> • Legend® or Chateau® • stop tube with adjustable temperature limit stop 	10510	29.70	Chrome	30
	<ul style="list-style-type: none"> • Moentrol® • stop tube with adjustable temperature limit stop • <i>*Wrought Iron can be used with Oil Rubbed Bronze</i> 	10066	29.70	Chrome	125
		10066BN	41.90	Brushed Nickel	20
		10066NL	42.60	Polished Nickel	20
		10066WR	46.30	Wrought Iron*	20
	<ul style="list-style-type: none"> • Posi-Temp® • adjustable temperature limit stop • <i>*Wrought Iron can be used with Oil Rubbed Bronze</i> 	96987	11.55	Chrome	20
		96987BN	15.95	Brushed Nickel	20
		96987NL	16.35	Polished Nickel	20
		96987BG	16.25	Brushed Gold	20
		96987WR	17.85	Wrought Iron*	20
	<ul style="list-style-type: none"> • temperature limit stop kit, Posi-Temp® single-handle tub/shower 	106479	5.55	-	300
SHOWER VALVE PUSH-BUTTON DIVERTER PLUG					
	<ul style="list-style-type: none"> • push-button diverter plug 	101100	37.10	-	100

Moentrol® and Legacy Transfer Valve Trim







		MODEL	LIST	FINISH/CONNECT	CASE QTY
MOENTROL® VALVE ONLY TRIM - ALIGN					
 <ul style="list-style-type: none"> • valve sold separately 		T3291	201.50	Chrome	3
		T3291BN	429.20	Brushed Nickel	3
		T3291BG	429.20	Brushed Gold	3
MOENTROL® VALVE ONLY TRIM - VOSS					
 <ul style="list-style-type: none"> • valve sold separately 		T3691	193.40	Chrome	3
		T3691BN	411.90	Brushed Nickel	3
		T3691BG	411.90	Brushed Gold	3
		T3691NL	411.90	Polished Nickel	3
		T3691BL	421.65	Matte Black	3
		T3691ORB	453.30	Oil Rubbed Bronze	3
MOENTROL® VALVE ONLY TRIM - KINGSLEY					
 <ul style="list-style-type: none"> • valve sold separately 		T3111	188.10	Chrome	3
		T3111BN	438.90	Brushed Nickel	3
		T3111ORB	482.85	Oil Rubbed Bronze	3
MOENTROL® WITH INTEGRATED TRANSFER VALVE TRIM - ROTHBURY					
 <ul style="list-style-type: none"> • valve sold separately 		TS4211	369.60	Chrome	3
		TS4211BN	506.05	Brushed Nickel	3
		TS4211ORB	533.10	Oil Rubbed Bronze	3
MOENTROL® WITH INTEGRATED TRANSFER VALVE TRIM - ALIGN					
 <ul style="list-style-type: none"> • valve sold separately 		T3290	234.20	Chrome	3
		T3290BN	314.55	Brushed Nickel	3
		T3290BL	346.05	Matte Black	3
MOENTROL® WITH INTEGRATED TRANSFER VALVE TRIM - KINGSLEY					
 <ul style="list-style-type: none"> • valve sold separately 		T4111	243.90	Chrome	3
		T4111BN	327.55	Brushed Nickel	3
		T4111ORB	360.25	Oil Rubbed Bronze	3
MOENTROL® TRIM CONVERSION KIT					
 <ul style="list-style-type: none"> • adapter for standard single-handle tub/shower valves to use Moentrol® trim • attaches to standard valves to fit today's Moentrol® trim 		145058	21.45	-	50

Moentrol® Trim

		MODEL	LIST	FINISH/CONNECT	CASE QTY
3 INDEPENDENT FUNCTION TRANSFER VALVE ONLY TRIM - ALIGN					
 <ul style="list-style-type: none"> • use with 3362 transfer valve • valve sold separately 		T4192	154.80	Chrome	12
		T4192BN	209.75	Brushed Nickel	12
		T4192BG	209.75	Brushed Gold	12
		T4192BL	230.70	Matte Black	12
2/3 FUNCTION TRANSFER VALVE ONLY TRIM - ALIGN					
 <ul style="list-style-type: none"> • use with 3372 or 3375 transfer valve • valve sold separately 		T4191	156.10	Chrome	12
		T4191BN	209.75	Brushed Nickel	12
		T4191BG	209.75	Brushed Gold	12
		T4191BL	230.70	Matte Black	12
3 INDEPENDENT FUNCTION TRANSFER VALVE ONLY TRIM - VOSS					
 <ul style="list-style-type: none"> • use with 3362 transfer valve • valve sold separately 		T4612	149.85	Chrome	12
		T4612BN	201.30	Brushed Nickel	12
		T4612BG	201.30	Brushed Gold	12
		T4612NL	201.30	Polished Nickel	12
		T4612BL	205.95	Matte Black	12
		T4612ORB	221.40	Oil Rubbed Bronze	12
2/3 FUNCTION TRANSFER VALVE ONLY TRIM - VOSS					
 <ul style="list-style-type: none"> • use with 3372 or 3375 transfer valve • valve sold separately 		T4611	149.85	Chrome	12
		T4611BN	201.30	Brushed Nickel	12
		T4611BG	201.30	Brushed Gold	12
		T4611NL	201.30	Polished Nickel	12
		T4611BL	205.95	Matte Black	12
		T4611ORB	221.40	Oil Rubbed Bronze	12
2/3 FUNCTION TRANSFER VALVE ONLY TRIM - KINGSLEY					
 <ul style="list-style-type: none"> • use with 3372 or 3375 transfer valve • valve sold separately 		T4311	162.90	Chrome	6
		T4311BN	219.00	Brushed Nickel	6
		T4311ORB	240.75	Oil Rubbed Bronze	6

		MODEL	LIST	FINISH/CONNECT	CASE QTY
COVER PLATES FOR THE BATH					
	<ul style="list-style-type: none"> remodel cover plate, for two- and three-handle tub/showers fits all single-handle tub/showers with 7" escutcheon 	1920	74.60	Chrome	6
		1920BN	108.30	Brushed Nickel	6
		NEW 1920BL	120.35	Matte Black	6
		1920ORB	132.95	Oil Rubbed Bronze	6
	<ul style="list-style-type: none"> remodel cover plate, for two and three-handle tub/showers fits Posi-Temp® valves 	178755	83.30	Chrome	8
		178755BN	120.75	Brushed Nickel	8
		NEW 178755BL	125.15	Matte Black	8
		178755ORB	128.20	Oil Rubbed Bronze	8
	<ul style="list-style-type: none"> Moenique® service kit, single-handle tub/shower with 3960 tub spout handle not included 	14292	256.00	Chrome	1
LAVATORY CONVERSION KIT - KNOB TO LEVER HANDLE					
	<ul style="list-style-type: none"> handle conversion kit, knob to lever, Chateau® single-handle lav - Models prior to April 2003 	100679	70.05	Chrome	12
TUB/SHOWER CONVERSION KITS - KNOB TO LEVER HANDLE					
	<ul style="list-style-type: none"> lever handle kit, Moentrol® single-handle tub/shower 	100224	23.70	Chrome	45

GENUINE PARTS

	MODEL	LIST	FINISH/CONNECT	CASE QTY
LAVATORY WASTE ASSEMBLIES				
	<ul style="list-style-type: none"> • lavatory drain assembly • all metal 	10790	136.80 Chrome	12
	<ul style="list-style-type: none"> • lavatory drain assembly • spring loaded push button • with overflow 	131553 131553BN 131553BG 131553NL 131553ORB 131553B	88.20 Chrome 120.30 Brushed Nickel 132.15 Brushed Gold 120.30 Polished Nickel 130.75 Oil Rubbed Bronze 135.35 Matte Black	12 12 12 12 12 12
	<ul style="list-style-type: none"> • lavatory drain assembly • ideal for vessel sinks • spring loaded push button • without overflow 	140780 140780BN 140780BG 140780NL 140780ORB 140780BL	78.35 Chrome 109.20 Brushed Nickel 109.20 Brushed Gold 109.20 Polished Nickel 131.30 Oil Rubbed Bronze 123.30 Matte Black	12 12 12 12 12 12
	<ul style="list-style-type: none"> • grid drain without overflow 	123816 123816BN 123816ORB 123816BL	62.00 Chrome 86.85 Brushed Nickel 95.90 Oil Rubbed Bronze 95.90 Matte Black	12 12 12 12
	<ul style="list-style-type: none"> • lavatory drain assembly, non-metallic • lavatory drain assembly, non-metallic plug, metal seat • lavatory drain assembly, non-metallic plug, metal seat 	14526 96497 96107	15.25 Chrome 26.25 Chrome 19.55 Chrome (Carded)	1 12 18
	<ul style="list-style-type: none"> • pivot rod extension linkage • designed to bridge gap between faucet lift rod and sink drain assembly • adjustable • wing nuts to allow for simple setting of desired range • pivot rod and perforated strap are not included 	98085	7.25	225
DRAIN PLUG & SEAT				
	<ul style="list-style-type: none"> • lavatory drain plug and threaded seat assembly • non-metallic • works with metal drain body 10790 only 	10709 10709BC 10709BN 10709BG 10709NL 10709ORB 10709BL 10709WR 99596	15.15 Chrome 21.15 Brushed Chrome 47.30 Brushed Nickel 47.30 Brushed Gold 51.95 Polished Nickel 52.05 Oil Rubbed Bronze 52.05 Matte Black 52.05 Wrought Iron 44.20 Polished Brass	84 20 20 20 20 20 20 1
SMART WATER SECURITY				
930-011	AC Adapter Mounting Bracket (attaches AC adapter to a wall)			7.65
935-001	3/4" Tailpiece Kit - NPT			22.80
935-002	3/4" Tailpiece Kit - Solder			8.10
935-003	3/4" O-Rings x2			1.95
935-004	1" Tailpiece Kit - NPT			55.80
935-005	1" Tailpiece Kit - Solder			15.00
935-006	1-1/4" Tailpiece Kit - NPT			23.30
935-007	1-1/4" Tailpiece Kit - Solder			15.45
935-008	1-1/4" O-Rings x2			1.95
935-009	3/4" Plastic Union Nuts			8.55
935-011	1-1/4" Brass Union Nuts			75.30
935-014	Plastic Waterway Cover - 3/4" & 1"			21.25
935-015	Plastic Waterway Cover - 1-1/4"			27.00
935-016	3/4" & 1" Flo Rate Turbine Replacement Kit			9.25
935-017	1-1/4" Flo Rate Turbine Replacement Kit			11.15
920-002	AC Power Adapter			8.10
179573	Optional Battery back up for Moen Smart Shower			78.30
169031	Optional AC Adapter and Power Splitter for Smart Faucets, Smart Faucets with Motion Control, and Motionsense Wave Kitchen Faucets			159.60
199785	Optional Wall Mount & Hose Extension Kit for Smart Faucets and Smart Faucets with Motion Control			59.75

For a complete listing of replacement parts, see pages 564-596.

Moen Genuine Parts

Listed in numerical order

Part Number	List	Finish	Description	Part Number	List	Finish	Description
221	65.20	Chrome	escr cht/cntx/lgd ts 1h chr	13678	10.55	N/A	hdw mn kd/lav/bar 2h
441	68.55	Chrome	escr mnt 1h ts chr	13769	39.20	Chrome	escr cht/mnii/tc ts 2&3h/ws rnd chr 1
739	140.25	Chrome	spt 9 cht kd 7500 sr & 67503	13774	15.05	Chrome	wall tube 2h ts chr 1
785	23.15	N/A	hdw lgd/cht lav 1h	13797	18.25	N/A	crtrge,nut mn 2h ts
883	4.55	N/A	rtnr clp knb hdl lav&ts	13805	22.35	N/A	hdw lgd kd 7300 sr
1039	44.90	N/A	universal mount sink flange kit	13903	5.40	N/A	atd scrw 10-24 unc 1.00 hexst bg
1041	459.05	N/A	disp unjam wrench - 100 unit bulk pack	14187	21.80	N/A	grtr spring only kd riser
1185	12.90	N/A	waste seat lav chr	14289	13.55	N/A	hdw pack chal 2h knb
1198	58.15	N/A	pbd mn mnt shr standard	14290	81.90	Chrome	hdlassy only #7345
1207	8.70	Chrome	st tube lgd,cht&btq 1h lav chr	14291	8.95	N/A	nsrt hdl cvr or spt lgd kd riser
1306	28.70	Chrome	hdl cvr mn kd lr lav	14349	25.80	Chrome	escr cht/sani bdt/lav/ts ws chr
1371	118.65	N/A	atd mtcl vlv ws lav hot	14369	12.50	N/A	hdl knb mnii 2h chr can 1
1373	124.40	N/A	atd mtcl vlv ws lav cold	14373	20.15	N/A	hose cht ws lav
1380	383.00	Chrome	rdmtf cht 12 sf chr	14582	40.25	Chrome	escr btq ts ws rdmtf chr
1381	331.90	Chrome	rdmtf cht 7 sf chr	14666	120.60	Chrome	hdl hub trad lr h chr 1
1394	57.70	Chrome	pbd ext 1.000 2400 & 3250 sr	14671	120.60	Chrome	hdl hub trad lr c chr 1
1411	25.65	Chrome	escr universal hhh dkmt chr	14699	8.85	N/A	rtnr pvt nut lh sgl hdl kd
1417	61.25	Chrome	intl shr elbow hhh dkmt chr	14705	63.60	Chrome	hdl trad lr nsrt chr crd 2
1423	120.70	N/A	bal spl mnt ts	14725	43.35	Chrome	hdl trad lr nsrt (1) chr
1512	10.45	Chrome	plug button ws rdmtf chr	14732	32.35	Chrome	lr mtl kit cht posi ts chr
1694	75.30	Chrome	p-os collar & nut kit chr	14855	12.90	N/A	hose,kd riser
1883	19.70	N/A	rtnr clp kd lr (6 per pack)	14913	16.65	Chrome	strm-fassy trad male chr
1931	110.70	Chrome	spt rcptr lgd/tc kd p-os chr	14960	20.10	N/A	d srvc kit cht/tc 2h kd
1935	32.85	Chrome	escr lgd/tc p-os vb chr	14986	8.35	N/A	crtrge,nut cht 2h
2011	20.70	Chrome	lift rod lav wa chr	15528	12.70	Chrome	escr scrw lgd/mnt/cht ts chr 2
2021	124.95	Chrome	hdlassy lgd kd 7300 sr	16015	7.35	N/A	pivot seat lav waste
2060	142.70	N/A	crtrge 5f xfer vlv	16090	41.55	Chrome	escr cht ts 1h chr
2186	17.20	Chrome	strm-fassy mtcl male chr (1)	16331	52.90	N/A	hdw mtg mtcl mws spt
2187	24.80	Chrome	escr mtcl rdmtf chr	22175	5.05	N/A	f-set scrw 3" u-channel
2197	218.20	Chrome	rdmtf mtcl 10sf chr	22526	19.80	N/A	template/inst sht umt sink g18252
2198	17.15	Chrome	escr mtcl bdt/lav/kd/ts 2h&ws hdl chr	22650	14.55	N/A	hdw mtg undermount sink brkt pack 10 pcs
4000	13.00	N/A	kerox vlv cartridge kit	22681	5.50	N/A	f-set u-channel clamp 10
10048	20.75	N/A	liquid dispenser bottle	22682	6.55	N/A	f-set u-channel clamp 12
10089	12.20	Chrome	stop tube shwr stnl stl dgrsd	22684	4.55	N/A	f-set u-channel clamp 8
10099	4.95	N/A	d cht/mtcl/trad 2h ws ts	54035	38.80	Chrome	4" lever smooth
10116	5.05	Chrome	escr plug lav chr	90274	17.10	N/A	adpt ws wh srvc kit - 2
10644	19.45	N/A	repair kit abs tub spt	90276	4.65	N/A	adpt for mn ws rdmtf
10927	48.75	Chrome	hdl lr lgd/sani kd 1h chr	90462	34.85	Chrome	tw face plate trip lever w/ screws chr
11854	13.00	N/A	hdw mtg trad hub	90467	17.50	Chrome	tw cover grid w/screw chr
11926	43.90	N/A	hdw mtg cht lav mws	90471	27.65	Chrome	tw face plate 1 hole w/screw chr
11977	5.40	Chrome	plug button trad posi/m&ws chr	90478	11.75	Chrome	tw mtg screw face plate 2 chr
11985	7.70	N/A	pivot rod assy,bidet nm wa (sk	90481	17.25	N/A	tw gasket all models
11997	5.60	N/A	hdw mtg 50/50 wa	90483	29.05	N/A	tw lift assy brass tp-lr
12314	24.55	Chrome	waste plug assy non-met'lic wa	91110	69.50	Chrome	hdl ext 1.000 cht ts wing handle
12318	51.25	N/A	ck st mnt ts	91192	34.40	N/A	d srvc kit lr kd
12343	10.55	Chrome	stm ext cht ws rdmtf (1)	91194	100.35	Chrome	spt 9 lgd kd 7300sr & 67300
12536	4.65	N/A	scrw,10-32 unf .38 cap hd ss bag	91244	33.55	N/A	hdl knb kit 3179 special
12539	11.40	N/A	nut escr 2hbar/kd/lav/ldry dom	91888	67.60	Chrome	acc pul shr hh volume control vlv
12550	17.75	N/A	hdw mtg rmdlg cvr pltt chr	91992	73.75	Chrome	spt cht 2h ldry chr
12570	19.45	N/A	hdw mtg rdmtf hi-f	92309	25.30	N/A	rtnr pvt nut sgl hdl kd
12573	8.95	N/A	atd ld bushing ring (1)	92451	8.60	N/A	h-p cart serv kit
12574	11.55	N/A	atd plstr grnd posi all vlv(1)	92455	9.60	N/A	ext & screw assy drain rod
12639	13.55	N/A	hdw srvc kit posi stop vlv	93944	37.55	Chrome	hdl hub mnii chr 2
12648	4.30	N/A	hdw pack 2h knob screws (2)	93959	16.15	N/A	hdw mtg cht/mn/mnr/mtcl kd 1h
12689	18.60	N/A	pr&clp assy brass lav wa	93960	18.45	N/A	value rtnr pvt nut kd 1h
12694	10.00	Chrome	lift rod lav mws/ws/1h/2h chr	93964	27.50	N/A	hdw pack value plt&gskt
12715	43.90	N/A	hdw mtg cht/cntx/trad ws lav	93970	10.40	Chrome	hdl cap mn/mnr 1h kd chr
13291	63.30	Chrome	hdl ezg rplcmnt mnt ts	93971	82.10	Chrome	hdl assy value 1h kd chr
13393	62.70	Chrome	hdl ezg rplcmnt cht lav	93973	89.55	Chrome	spt 9 value kd 1h chr
13401	13.55	N/A	crtrge,nut cht ws lav/rtdm-2	93980	35.45	N/A	hdl hdw good kd 1h
13462	10.50	N/A	adpt hdl cht ws rdmtf hi-f	93988	105.35	Chrome	spt 9 soft-d kd 1h chr
13463	13.65	N/A	stm ext cht ws rdmtf hi-f	93989	84.05	Chrome	lr good kd 1h chr
13499	45.95	Chrome	hdl ezg rplcmnt mn cht ts				

Moen Genuine Parts

Listed in numerical order

Part Number	List	Finish	Description	Part Number	List	Finish	Description
93990	16.25	Chrome	hdl dome sm kd 1h chr	100009	193.85	Chrome	spt 10 mtcl cath kd 1h chr
93995	61.20	Chrome	escr cht/tc kd 1h rd chr	100011	32.25	Chrome	escr rng kd 1h sglmt chr
94146	11.80	N/A	crtgrge,nut cht 2h ts	100012	45.40	Chrome	hdl mn/mtcl/pt kd 1h solid chr
94435	43.80	Chrome	escr rng cht/mn/mtcl 1h kd chr	100014	24.05	Chrome	hdl dome lrg kd 1h chr
94543	32.25	N/A	tm ext cht 3v ts ctr (1)	100016	99.75	Chrome	spt 10 mtcl kd 1h chr
94740	38.55	Chrome	hdlassy cht/mt/posi lr chr	100021	19.75	Chrome	hdl cap cht mn kd 1h chr
94746	12.05	N/A	adpt hdl mnt/cht 1h lvr t/s	100023	39.10	Chrome/Glacier	dl cap cht/mn kd 1h porcelain chr/glc
94750	16.65	Chrome	hdl collar cht/tc 1h lr lav chr	100024	11.90	N/A	tl mnt ts 3f chr
94770	6.85	Chrome	plug button & set screw	100112	19.20	Chrome	fra male thrd mtcl lg 2.2 gpm chr crd
94773	28.55	N/A	stm ext mnt 1h lr hdl ts	100113	23.35	Chrome	fra male thd mtcl sm 2.0gpm chr
94786	5.05	N/A	hdw mtg scrw&wshr mnt 1h lr	100119	53.90	N/A	hose supply spt cath 1h kd
94791	5.50	N/A	hdl adpt scrw 1h t/s	100131	19.20	Chrome	lift rod vil mws/ws chr
94794	47.90	N/A	hdwr mntg deckpost,dvrtr vlv	100138	43.30	N/A	knb adpt kit xfer 5f
94831	84.55	N/A	d srvc kit bdt	100140	23.15	N/A	hdl grip ring xfer 5f
94854	56.55	N/A	crtgrge dvrtr vlv	100150	54.45	Chrome	hdl lr nova loop chr
94873	22.90	N/A	check valve p-os	100151	32.00	Chrome	escr nova kd 1h sglmt chr
94996	5.05	N/A	o-ring bagged (3)	100154	55.95	Chrome	hdl nova trad 1h kd chr
94998	61.85	N/A	hose,leader,rt dvrtr	100155	20.80	Chrome	hdl cap nova kd 1h p-os chr
95606	30.35	Chrome	hdl hub mtcl posi kit chr 1	100202	13.55	N/A	knb adpt kit xfer 3f mtcl mnt
95612	43.90	Chrome	one pc hub mtcl mnt kit chr	100205	9.95	N/A	set screw kit 8-32 x .370
95626	43.90	Chrome	one pc hdl hub mtcl posi kit chr	100214	20.65	N/A	hdl adpt/brake lr vil mnt 1h ts
96217	56.15	Chrome	wall tube cht 3v ts chr (1)	100216	16.90	N/A	crtgrge cap&nut kit metering chr
96469	87.70	Chrome	ld pump & nozzle assy chr	100223	9.20	N/A	hdl adpt&brake kit lr cht/mt
96798	34.75	N/A	hdl knb cht ts 1h cl w/g	100226	45.35	Chrome	hdl assy kd 1h chr
96804	11.00	N/A	hdw knb lav 1h all models	100227	91.05	Chrome	spt assy kd 1h chr
96806	11.00	N/A	hdw knb ts 1h all models	100230	66.65	Chrome	spt assy harc kd 2h
96884	35.00	N/A	hdl knb kit hotel 1h posi cl	100232	47.30	Chrome	hdl hub lvr c chr
96885	55.00	Chrome	escr cht/tc ts 1h posi chr	100233	48.60	Chrome	hdl hub lvr h chr
97274	5.70	N/A	nsrt kit mtcl red&blue lr hdl	100242	7.75	N/A	hdl lvr kit chr
97344	14.85	N/A	stm ext mtcl 2h ts (2)	100250	16.90	Chrome	cap,spout kd 2h chr
97361	11.00	Chrome	escr mtcl 2h ts chr (1)	100251	3.35	N/A	wshr,bearing kd 2h
97371	7.90	N/A	hdl adpt kit mtcl 2hts ws lav 1	100254	78.60	Chrome	spout assy kd 2h chr
97372	66.65	Chrome	hdl mtcl lr nsrt lrg chr crd 2	100255	23.05	N/A	d srvc kit 2h kd
97373	76.80	Polished Brass	hdl mtcl lr nsrt lrg pb crd 2	100263	12.75	N/A	knb insrt kd 2h
97376	90.25	Porcelain/Chrome	hdl mtcl lr nsrt lrg por/c crd 2	100265	22.95	N/A	hdl knb 2h sml cl
97434	142.95	Porcelain/Chrome	hdl mtcl cx nsrt lrg por/c 2	100270	6.45	N/A	hdl conn 1h lr lav/ts
97446	134.00	Chrome	hdl mtcl cx nsrt lrg chr 2	100283	2.10	N/A	gasket, deck 2h
97462	45.60	Chrome	hdl mtcl lr nsrt lrg chr crd 1	100429	7.75	N/A	adpt/conn hdl pt/shark
97463	52.45	Polished Brass	hdl mtcl lr nsrt lrg pb bgd	100439	16.65	Chrome	dome clnd/exta/pt/salora 1h kd lr chr
97466	52.45	Porcelain/Chrome	hdl mtcl lr nsrt lrg por/c crd 1	100440	35.10	N/A	hdw mtg pt hdl kd 1h
97479	23.85	N/A	stem ext mtcl ws lav hot & cold	100538	9.55	N/A	brass test plug rt
97491	66.45	Chrome	escr mtcl 1h posi ts chr	100539	15.65	N/A	mounting washers
97535	5.40	N/A	crtgrge,nut mtcl mws lav (2)	100552	100.75	Chrome	hdl, mtcl mws 2h lvr cold chr
97547	45.40	Chrome	escr mtcl mws hdl chr (1)	100553	100.75	Chrome	hdl, mtcl mws 2h lvr hot chr
97556	27.35	N/A	hdl adpt mtcl mws/2h h & c	100556	41.00	Chrome	hdl, mtcl ws 2h lvr lav & bdt chr
97559	78.70	Porcelain/Chrome	hdl mtcl lr nsrt sm por/c crd 2	100557	47.40	Chrome	hdl, mtcl ws 2h cx lav & bdt chr
97564	5.45	N/A	gskt deck mtcl 2h lav	100558	47.05	Chrome	hdl, mtcl ws 2h lvr ts & kd chr
97565	66.45	N/A	mtg hdw mtcl ws lav	100559	53.40	Chrome	hdl, mtcl ws 2h cx ts & kd chr
97577	64.20	Chrome	escr mtcl 1h ts chr	100561	13.90	N/A	hdl adptr kit mtcl mws 2h hot & cold
97800	8.70	N/A	plaster ground cht 1h ts bag	100562	5.45	N/A	hdl adptr kit mtcl ws 2h lav & bdt
97996	10.80	N/A	posi ts decal (1 package of 10)	100563	5.40	N/A	hdl adptr kit mtcl ws 2h ts & kd
98035	32.65	N/A	hdl knb tc lav 1h cl w/c crd	100566	15.05	N/A	small chassis, mtcl
98036	13.75	N/A	nsrt knb tc lav/ts 1h w/c crd	100593	141.55	N/A	hose & vac brkr conversion kit
98037	32.65	N/A	hdl knb tc ts 1h cl w/c crd	100602	132.45	N/A	vacuum breaker conversion kit
98079	30.25	N/A	hdw mtg cht bdt lift rod escr	100615	38.40	Chrome	esc, kd, chr
98082	50.10	N/A	pr assy bdt wa	100616	64.55	Chrome	spt kit, kd, chr
98213	6.45	N/A	gskt deck kd 1h cht/lgd	100617	22.30	Chrome	hdl, insrt, h&c, sk
98430	15.20	N/A	gskt,escr lgd/tc kd p-os	100621	68.70	Chrome	lever hdl kit, chr, cold
98576	26.70	Chrome	escr mtcl tub spt chr	100624	68.70	Chrome	lever hdl kit, chr, hot
99479	23.05	N/A	hdw mtg cht bdt dvrtr	100625	32.65	Chrome	escr, bar, chr, sk
99712	13.65	Chrome	hdl cap cht kd 1h chr 1	100626	47.20	Chrome	spt, assy, bar, chr, sk
99892	8.35	N/A	scrw,5/16-18 unc hex set bag	100649	150.65	Chrome	spt, ws, chr, sk
100000	12.45	N/A	spt o-ring kit cath 1h kd				
100008	22.30	N/A	dw mtg mtcl vlv kd 1h cath				

Moen Genuine Parts

Listed in numerical order

Part Number	List	Finish	Description	Part Number	List	Finish	Description
100650	15.30	Chrome	esc, ws, chr, sk	103454	84.15	Chrome	hdl knb mtcl bdt dvtr chr
100652	172.55	Chrome	spt, rt, chr, sk	103455	86.10	Chrome	spry nzzl shrhd & aer mtcl bdt chr
100655	40.00	Chrome	lift rod, dvtr, chr, sk	103456	30.00	N/A	hdw pack hdl adpt mtcl ts mws
100656	146.55	Chrome	pt, gt, chr, sk	103460	10.85	N/A	mpact drain plug o-ring
100657	30.35	Chrome	hdl tc posi 1h ts lr chr	103462	12.55	N/A	mtcl mws & ws install tool
100665	42.10	Polished Brass	spt, ldry, assy	103463	43.15	Chrome	mtcl spt esct ws lav chr
100667	150.65	Chrome	spt, ws, assy, w/o lr	103464	23.70	Chrome	lift rod & knb ws chr
100675	165.25	Polished Brass	spt, assy, gt, w/endform	103465	8.70	N/A	set scrw lift rod
100676	46.35	N/A	cht itt ws valve body	103466	6.65	N/A	mtcl spt o-ring ws lav chr
100683	7.00	N/A	gskt deck cht/sani 2h lav	103468	170.40	Chrome	mtcl spt ws lav chr
100695	44.85	N/A	knob kit, h & c	103469	62.20	N/A	mtcl sply hose ws lav
100702	37.90	N/A	widespread spout shank for hydrolock	103674	300.15	N/A	thrmstc crtrge xtmp
100742	50.80	N/A	widespread valve for hydrolock, hot	103675	42.45	Chrome	thrmstc lower shell chr
100743	50.80	N/A	widespread valve for hydrolock, cold	103678	23.65	Chrome	esct rng mtcl chr
100746	26.15	Chrome	sip transitional handle kit chr	103685	38.95	N/A	temp rtng nut xtmp
100816	29.75	N/A	side spray extension kit	103686	23.05	N/A	check-stops xtmp
100820	85.20	Chrome	sip modern spout kit chr	103687	73.80	N/A	check stop assy xtmp
100895	29.70	Chrome	sip modern handle kit chr	103688	32.45	N/A	thrmstc crtrge parts xtmp
100896	90.25	Chrome	sip traditional spout kit chr	103689	35.80	N/A	temp stop xtmp
100928	30.35	Chrome	sip traditional handle kit chr	103690	19.50	N/A	spindle xtmp
100957	28.10	Chrome	sip escutcheon w/led indicator chr	103691	5.00	N/A	spindle scrw xtmp
100961	150.75	Chrome	sip transitional spout kit chr	103745	73.70	Chrome	esct mws hdl bgd chr
100998	16.10	Chrome	esc, t/s kit	103759	12.20	N/A	clp esct & mtg wshr ws hdl
101010	17.50	Chrome	male thread 1.5gpm aerator	104212	13.80	N/A	tool, aerator driver ascw ws lav
101029	18.85	Chrome	female thread 1.5gpm aerator	104215	29.80	Chrome	lift rod ascw mws chr
101039	15.65	N/A	hdw mtg roughin hi-f/t/s	104217	11.20	Chrome	fra male ascw mws chr
101048	22.85	Chrome	5gpm aerator, male thread chr	104225	12.30	N/A	lift rod guide ascw lav
101076	6.30	Chrome	fra female thrd 1.5 gpm chr crd	104228	17.65	Chrome	fra male thrd 2.2gpm ascw hanc chr
101077	15.75	Chrome	fra female thrd 1.5 gpm chr	104233	8.25	N/A	hdl adpt ascw ws lav
101099	7.70	N/A	hdl conn 1h kd lgd	104235	19.90	Chrome	esct protege w/hose guide chr
101140	38.25	Chrome	1h lav handle kit, lever chr	104247	8.35	N/A	shr esct rtnr scrws ascw
101146	17.50	Chrome	male thread 1.0gpm aerator	104409	5.65	N/A	vlv stem cplg ascw posi
101199	8.25	N/A	screen wshr kd p-os 0 x 60 mesh	104411	4.95	N/A	set scrw ascw posi hdl
101209	41.85	Chrome	hdl lr cht/mnt chr mrkd	104419	8.35	N/A	plug btn & set scrw rmn ts ascw
101237	9.60	N/A	cup seal/dvtr gate 3800 spout	104635	170.30	N/A	0.125gpf sensor and bracket
101246	99.90	Chrome	spt rcptr lgd/tc kd p-os chr	104636	170.30	N/A	0.5gpf sensor and bracket
101249	19.45	Chrome	hdl collar&nut p-os 1h kd chr	104637	170.30	N/A	1.0gpf sensor and bracket
101257	17.50	Chrome	aerator body p-os male thrd chr	104638	170.30	N/A	1.0/1.6gpf sensor and bracket
101310	24.80	Chrome	hdw hdl cht lav 1h lr	104639	170.30	N/A	1.28gpf sensor and bracket
101412	33.90	Chrome	hdl ws chr	104640	170.30	N/A	1.6gpf sensor and bracket
101484	110.70	Chrome	spt rcptr lgd/tc kd p-os chr	104641	170.30	N/A	3.5gpf sensor and bracket
101652	38.55	Chrome	tw drain touch drain 1.50 chr	106322	12.85	N/A	wst mntg, metal
101653	37.90	Chrome	tw drain lift-n-drain 1.50 chr	106324	33.15	N/A	t-conncr mtcl cath kitchens
101707	21.80	N/A	exta vb hub assy	106376	25.85	Chrome	shr brkt 4-8 fnctn chr
101708	84.35	N/A	hose assy 59 spiral kd p-os bag chr	110307	5.85	N/A	auqa crtrge nut
101869	29.20	N/A	hdw mtg hdl lv w/atls	110317	111.90	Chrome	hdl ext 1.000 3f xfer vlv chr
101879	8.10	N/A	hdw pack spout retainers	111881	29.80	Chrome	lv hdl chr
101951	22.20	N/A	dvtr rd rdm tub chr	113173	11.80	N/A	mounting hardware service kit
101952	27.95	N/A	hdr dvtr kit roman tub	113957	6.65	Chrome	plug btn
101964	26.65	Chrome	fra female thrd 2.2gpm chr	113958	7.05	N/A	gasket, deck lav 1h cht&tc bk 50
101965	7.75	N/A	deck gskt	113959	8.95	Chrome	dome cht 1h lav lr chr
101975	5.55	N/A	posi flushing plug kit	113973	25.80	Chrome	mini blade hndls hot & cold
102562	14.25	Chrome	2t tube vil t/s chr	114295	20.75	N/A	hdw kit, 7590 series
102564	64.90	Chrome	hdl lr vil 1h ts chr	114299	40.65	N/A	hose kit, 7592 series chr
102565	47.05	Chrome	hdl lr vil 1h lav chr	114303	8.60	N/A	crtrge, nut 7592 series
102567	5.55	Chrome	hdl stop vil lr 1h lav chr	114304	45.65	Chrome	hdl kit 7590 series chr
102568	20.20	N/A	vil lav lr st	114306	21.80	N/A	hdw kit adpt hose quick connect
102570	40.90	Chrome	lift rod vil 1h lav chr	114307	25.25	N/A	duralock kitchen/bar quick conn hose kit
103432	6.65	N/A	hdw pack spt 2h kd trad	114308	15.40	N/A	stem ext kit, 7592 series
103433	114.15	Chrome	spt 2h kd chr	114311	9.45	N/A	screen wshr 7590 & 7592 series
103437	6.85	N/A	conn 1h kd	114324	22.65	Chrome	hdl caps, hot & cold chr
				114331	21.30	Chrome	hdl hub kgsy 2h lav chr 1
				114332	16.40	Chrome	fra male thrd kgsy 2.2 gpm chr

Moen Genuine Parts

Listed in numerical order

Part Number	List	Finish	Description	Part Number	List	Finish	Description
114334	18.45	Chrome	lift rod kit chr	116953	49.40	Chrome	hdl kit, hot
114336	11.85	Chrome	lge hdl nsrt chr	116954	49.40	Chrome	hdl kit, cold chr
114337	78.55	Chrome	hdl assy kgsy lrws chr	117000	5.05	N/A	hdl h/c chr
114343	18.15	N/A	hdl caps & scrw chr	117658	63.75	Chrome	spt kit chr
114344	29.15	Chrome	hdl hub, chr	117659	13.15	Chrome	fra female thrd 2.2gpm trad mork chr
114346	32.00	Chrome	hdl assy kgsyt 1h ts posi chr	117660	44.80	Chrome	hdl kit, 87440 & 87444
114384	8.10	N/A	rt rtnr clips	117947	33.40	Chrome	hdwr pack hndl lav 1h lvr adler chr
114385	20.75	N/A	bottle, 16 oz	117948	44.05	Chrome	shr lvr
115000	34.30	N/A	hdl kit 1h t/s cl	118230	11.95	Chrome	hdl sleeve service kit
115010	72.35	N/A	spt base kit mtcl 1h cath kd	118231	33.10	Chrome	hot hdlc service kit
115012	283.70	N/A	cable assy sensor eye 8' wall mnt kit	118239	20.80	Chrome	fra male thrd 2.2gpm mtcl chr
115023	8.00	Chrome	hdl cap & temperature ind 1h lav chr	118240	10.80	Chrome	hdl cap, 6102 chr
115026	16.45	N/A	hdl stop kit	118241	10.85	Chrome	hdl cap w/ h & c 6102 chr
115029	22.20	Chrome	hdl hub 2h lav & kd	118244	20.30	Chrome	lift rod 6102 chr
115030	28.60	Chrome	lvr hdl hot 2h lav & kd	118245	12.00	N/A	hdwr kit 6102
115033	21.75	N/A	ceramic hdl trim 2h lav & kd (1 only)	118297	13.80	N/A	hndl hdwr kit
115034	13.65	Chrome	hdl cap kit 2h lav & kd	118303	25.90	N/A	hdwr kit, abdn
115035	8.75	Chrome	hdl hub 2h lav & kd	118305	15.00	N/A	install kit, abdn
115036	28.80	Chrome	lvr hdl hot 2h lav & kd	118306	4.75	N/A	indicators, hot & cold
115037	12.45	Chrome	spt cap 2h kd	122556	6.85	N/A	o-ring kit
115039	64.80	Chrome	spt kit 2h kd	122560	22.85	Chrome	strm-f male thrd 2.2gpm ws lav chr
115043	59.75	Chrome	spt 2h kd	122566	16.95	N/A	handle adapter, posi-temp
115045	10.50	Chrome	fra female thrd 2.2gpm bnby 2h kd chr	122569	17.75	N/A	handle screw kit, moentrol
115046	45.95	Chrome	hdl, 1h kd	123244	46.60	Chrome	deck plate kit chr
115047	66.10	Chrome	spt, 1h kd	123245	55.75	Chrome	deck kit with hose guide
115051	32.95	Chrome	hdl hub chr	123247	106.30	Chrome	spt trad bar 2h chr
115055	13.55	Chrome	hdl cap, scrw chr	123249	35.60	Chrome	handle kit, 1 handle kitchen
115056	28.25	Chrome	lvr hdl, cold, 2h lav & kd	123250	13.50	Chrome	dome, 1 handle kitchen
115057	6.05	Chrome	deck gskt, 2h lav	123342	8.55	N/A	deck gasket, 2h kitchen
115060	29.90	Chrome	hdl csby kd/lav 2h lvr cold box	123663	8.85	N/A	deck gasket, 2h lav
115061	8.95	N/A	bearing wshr kit, 1h kd	123799	14.25	Chrome	handle cap & screws kit
115062	5.55	N/A	gasket, deck kd 2h csby bk 20	123804	29.75	Chrome	lift rod kit, widespread
115063	48.95	Chrome	lvr hdl, h & c chr	123807	19.90	Chrome	stream straightener kit
115066	8.75	Chrome	hdl accent chr	124660	44.30	Chrome	spout hub, chr
115073	13.80	N/A	backing plate kit -2708 thin wall	124662	82.75	N/A	hose kit
115077	89.90	Chrome	vacuum breaker kit chr	124664	107.10	Chrome	wand kit, 7545, chr
116379	34.60	N/A	one touch retrofit brass spout nut kit	124665	10.05	N/A	bearing washer, 7545
116618	18.85	Chrome	fra female thrd 2.2gpm chr	124737	41.80	Chrome	handle kit 1h kitchen
116620	27.80	Chrome	spt hub, 1h lav chr	124738	93.90	Chrome	wand kit chrome
116623	21.15	N/A	locking ring, roman tub spout	124823	73.00	Chrome	spout receptor chr
116626	75.50	Chrome	spt kit, ws lav chr	124854	35.80	Chrome	handle kit 1h kitchen chr
116628	17.20	Chrome	lvr hdl, ws lav chr	125752	40.85	Chrome	grid drain cover, chr
116629	59.30	Chrome	hdl hub, ws lav chr	125754	47.60	Chrome	handle kit, posi-temp
116630	141.10	Chrome	spt cap, rt chr	125756	99.95	Chrome	handle kit, widespread lav
116632	50.00	Chrome	body aerator female thrd rmn tub chr bk	125795	30.35	Chrome	cht lever handle red/blue indicators
116641	75.95	Chrome	spt kit, 1h kd chr	125796	12.05	N/A	vestige ws hex wrench
116648	22.20	Chrome	lift rod kit	125857	108.05	Chrome	spt rcprtlgd/tc kd p-os chr
116649	33.05	Chrome	spt cap, 2h lav chr	125979	42.45	N/A	red/blue indicators (qty 42)
116653	8.25	N/A	hdl adpt posi temp t/s	125989	18.20	N/A	metal hose weight
116664	174.75	Chrome	spt kit, t6125 chr	125999	7.10	N/A	hot/cold indicator vstg shower
116665	295.80	Chrome	rt spt kit t920 series chr	126956	20.60	Chrome	hose guide kit chr
116673	96.50	Chrome	side spray esc.	126964	13.15	Chrome	dome service kit - chr
116696	64.25	Chrome	hose assy 7ft	126970	96.40	Chrome	spt cht kd 2h chr
116698	30.10	N/A	roman tub hardware kit	126971	39.75	Chrome	handle service kit - chr
116712	9.90	N/A	shwr hdl flw rstctr 1.75 gpm (25)	127683	48.50	N/A	filter manifold kit
116713	54.85	Chrome	hdl kit chr	127685	55.95	N/A	filter mounting bracket kit
116716	24.65	Chrome	hndl kit, h & c, chr	127686	8.50	N/A	bracket mounting screw kit
116719	38.95	N/A	cartridge 3f dvtr	127689	15.85	N/A	spout o-ring kit
116728	44.35	Chrome	handle kit, 87780, 87790	127690	8.10	N/A	filter aerator kit
116730	53.90	N/A	hardware kit	127691	16.35	N/A	diverter kit
116731	8.40	N/A	bearing washer kit	128865	25.35	Chrome	lift rod kit chr
				128866	60.80	Chrome	hndl assy h/c chr

Moen Genuine Parts

Listed in numerical order

Part Number	List	Finish	Description
128867	62.20	Chrome	hndl assy, hot chr
128868	62.20	Chrome	hndl assy, cold chr
128869	8.50	N/A	deck gskt chr
128870	57.95	Chrome	escct chr
128871	56.50	Chrome	hndl kit chr
128873	37.10	Chrome	lift rod kit chr
128878	20.80	Chrome	aerator chr
128879	135.30	Chrome	spout kit chr
128880	76.60	Chrome	hndl assy chr
128883	192.80	Chrome	spt kit chr
128884	22.90	Chrome	stream straightener chr
128885	19.85	Chrome	lift rod kit chr
128886	256.20	Chrome	spout kit chr
129666	25.20	N/A	cold only service kit
129706	30.05	N/A	temp ring kit eva ws
129707	28.80	N/A	temp ring kit eva cset
129709	43.30	Chrome	loop handle kit
129830	408.10	Chrome	spout kit chr
129831	6.90	N/A	bearing washer kit chr
129908	46.90	Chrome	wand 1h kd p-os chr bag
130142	24.55	N/A	spline adapter & screw kit
130143	81.70	N/A	thread adapter & extension
130146	22.20	N/A	spline adapter & screw kit
130147	9.45	Chrome	temperature override kit chr
130148	56.40	Chrome	escut assy t/s 1h dnpr brs chr
130149	123.30	Chrome	handle kit - volume control
130150	26.70	Chrome	handle cap chr
130151	124.65	Chrome	handle kit - thermostatic valve
130152	29.35	Chrome	hdl esct, short chr
130153	43.10	Chrome	hdl esct, tall chr
130155	28.00	Chrome	volume control handle extension kit
130156	264.10	N/A	thermostatic cartridge replacement kit
130157	60.95	N/A	volume control cartridge replacement kit
130158	20.60	N/A	check stop replacement kit
130525	91.60	Chrome	hdl, mtcl mws 2h lvr cold
130526	91.60	Chrome	hdl, mtcl mws 2h lvr hot
130965	56.40	Chrome	handle hub chr
130966	13.80	Chrome	hinge pin cap chr
130967	28.25	Chrome	hinge pin assembly
130968	46.40	Chrome	wall escutcheon chr
130969	32.75	Chrome	mounting bracket
130970	25.75	Chrome	aerator assembly chr
130976	9.40	Chrome	hndl cap kit chr, 1h kd p-os
130998	148.20	Chrome	low arc spout kit chr
131097	74.35	Chrome	hdl kit - hot chr
131098	74.35	Chrome	hdl kit - cold chr
131099	7.05	Chrome	hdl cap chr
131100	19.85	Chrome	lift rod chr
131101	85.85	Chrome	hdl kit - hot or cold chr
131104	219.00	Chrome	spt kit chr
131107	24.60	Chrome	lift rod kit chr
131109	66.65	Chrome	shr hdl kit chr
131191	147.75	Chrome	volume cntrl hdl kit wthl chr
131195	149.10	Chrome	thermostatic hdl kit wthl chr
131380	45.00	Chrome	pulldown wand chr
131381	56.85	Chrome	pulldown hose
131384	20.75	Chrome	dome chr
132152	9.00	N/A	kit spout o-ring
132320	25.25	Chrome	tstat hdl cap, service kit, chr
132596	45.00	N/A	filtration connection hose kit
132597	25.30	N/A	hardware kit
134122	554.85	Chrome	infrared sensor control box chr

Part Number	List	Finish	Description
134402	86.65	Chrome	handle kit chr
134404	31.50	Chrome	bidet lift rod chr
134742	107.80	Chrome	wand kit chr
135149	100.45	Chrome	3f escutcheon, neutral
135150	34.40	Chrome	3f diverter lever kit, neutral chr
135151	11.00	Chrome	top tube w/o screw kit 135152
135152	5.75	N/A	diverter handle spacer kit
136101	29.90	N/A	hose adapter
136102	14.75	N/A	hose spray kit
136103	46.00	Black	hs kd, female blk
136104	89.40	Chrome	side spray, hose & hose guide chr
136106	92.10	Chrome	hose & spray chr
136109	49.35	Chrome	side spray replacement chr
136123	30.05	N/A	hdw srvc kit posi stop ovrrld
136196	44.05	Chrome	icon moentrol handle and adapter kit chr
136197	7.70	Chrome	3f plug button and screw kit chr
136304	9.50	N/A	dvtrtr kit, 2h shwr
136331	10.50	N/A	service kit, rt spt plug seal
136640	56.30	Chrome	hdl kgsy 3f kit, chr
136829	66.20	Chrome	wand exta 1h kd p-os, chr
137001	12.55	N/A	spout docking collar - aberdeen
137028	52.90	N/A	hose kit
137034	24.70	Chrome	slider for slidebar
137035	11.70	N/A	slidebar mounting hardware kit
137388	80.75	Chrome	ws handle kit, hot or cold, chr
137390	177.00	Chrome	ws spt kit, chr
137391	240.20	Chrome	rt spt kit, chr
137392	248.25	Chrome	roman tub diverter spout, chr
137393	26.30	Chrome	roman tub lift rod, chr
137394	75.50	Chrome	escct posi 1h ts, chr
137395	81.45	Chrome	escct mnt 1h ts, chr
137396	56.85	Chrome	hdl lr 1h ts, chr
137402	20.45	N/A	strm-fassy
137403	5.70	N/A	plug button kit
137511	5.75	Chrome	handle, lvr service kit
137512	8.20	N/A	handle dome sk
137513	5.05	Chrome	crtgr nut chr
137514	13.65	Chrome	aerator chr
137515	1.45	Chrome	o-ring chr
137516	11.85	Chrome	escct, chr (6100)
137520	8.75	Chrome	aerator chr
137522	1.60	Chrome	spt rng chr
137526	4.75	Chrome	aerator chr
137532	12.95	Chrome	escct (t914) chr
137533	18.10	Chrome	lift rod chr
137536	24.15	Chrome	hdl assy chr
137538	1.60	Chrome	plug btn chr
137540	52.90	Chrome	escct (t2701) chr
138765	19.70	N/A	hdwr kit, abdn
139260	3.45	N/A	io mounting screws
139769	41.40	Chrome	handle adapter
139885	89.35	Chrome	hdl srvc kit, thrmstc dvtrtr chr
139968	65.85	N/A	hardware kit
140028	27.30	Chrome	side spray service kit
140251	16.50	Chrome	deck gasket & o-ring kit
140325	40.65	N/A	shank & diverter kit 9992/9993
140379	92.50	Chrome	wand cndd kd 1h p-os chr
140392	91.90	Chrome	wand strd kd 1h p-os chr
140706	10.35	N/A	mounting hardware
140708	12.45	N/A	mounting washers
140709	6.90	N/A	hot/cold handle adapters
140710	5.90	N/A	cartridge nut kit (2)
140712	24.85	N/A	shank kit

Moen Genuine Parts

Listed in numerical order

Part Number	List	Finish	Description	Part Number	List	Finish	Description
140713	28.25	N/A	quick connect hose kit - 4993	146789	7.70	N/A	o-ring kit, 1h kitchen
140714	19.90	N/A	cpvc transition fittings (2) & clips	146790	16.45	N/A	mounting hardware 1h kitchen
140716	6.55	N/A	o-ring kit (4)	146851	41.40	Chrome	handle kit, chrome
140718	6.20	N/A	shank o-ring kit	146926	6.65	N/A	o-ring kit, 1h kitchen
140719	39.70	N/A	quick connect hose kit - 9993	146927	11.90	N/A	mounting hardware 1h pullouts
140720	29.00	N/A	hardware kit 9992/9993	146928	34.55	Chrome	handle kit 1h kitchen chr
140721	9.50	N/A	quick connect clips (5)	146936	6.05	N/A	thin deck spacer kit
140777	8.35	N/A	1.50 showering restrictor	147207	33.15	N/A	spline adapter & screw kit
140779	8.35	N/A	2.0 showering restrictor	147208	173.55	N/A	thermostatic cartridge replacement kit
140899	8.20	N/A	siding wedge	147209	49.60	N/A	check stop replacement kit
140900	11.75	N/A	vacuum breaker kit	147210	40.60	N/A	volume control cartridge replacement kit
140901	7.50	N/A	temperature indicator	147211	24.80	N/A	spline adapter & screw kit
140902	7.80	N/A	sillcock temperature limit stop	147213	13.25	N/A	volume control mounting plate
140903	18.85	N/A	sillcock handle kit	147539	38.50	Chrome	kitchen escutcheon chr
140904	15.05	N/A	sillcock retaining nut	147540	12.25	Chrome	spout screw chr
140995	73.35	Chrome	wand kit chr	147541	39.05	Chrome	handle hub chr
140997	13.90	Chrome	dome kit chr	147542	25.20	Chrome	handle lever chr
140998	13.40	Chrome	cartridge nut chr	147543	243.70	Chrome	spout chr
140999	7.00	Chrome	gasket kit	147544	13.85	N/A	spout o-ring chr
141003	16.80	N/A	installation tool kit	147548	25.60	N/A	filter screen fitting 3/8"
141006	42.45	Chrome	side spry & hose assy chr	147549	18.45	Chrome	lav escutcheon chr
141007	14.95	Chrome	hose guide chr	147550	19.70	Chrome	lift rod chr
141008	24.25	Chrome	aerator and retainer kit, chr	147552	39.05	Chrome	handle hub chr
141025	13.85	N/A	wand screen & o-ring kit	147554	11.55	Chrome	slot plug chr
141044	119.30	Chrome	wand & hose kit chr	147555	47.20	Chrome	vessel ext 5" chr
141797	39.70	Chrome	dome kit, chr	147557	40.85	Chrome	handle assy chr
141798	61.25	Chrome	roman tub elbow, chr	147558	9.50	N/A	hdwr pack
141941	8.35	N/A	1.75 shower flow restrictor (25 qty)	147559	30.50	N/A	handle mpact assy chr
142980	13.25	N/A	chateau rt stem ext kit	147562	12.55	Chrome	spout esct chr
142981	6.85	N/A	escutcheon adjuster kit	147563	13.45	Chrome	handle esct chr
143002	12.00	N/A	handle adapter	147564	29.70	Chrome	lift rod chr
143200	8.20	N/A	deck gasket & o-ring kit	147565	389.95	Chrome	roman tub spout chr
143321	33.10	Chrome	handle kit ch brntfrd	147566	37.00	Chrome	spout esct chr
143322	30.10	Chrome	handle kit ch eva	147567	69.05	Chrome	handheld esct chr
143323	29.70	Chrome	3h esc ch brntfrd	147568	430.15	Chrome	roman tub spout chr
143324	31.45	Chrome	3h esc ch eva	147569	50.80	Chrome	lift rod chr
143325	7.25	N/A	gasket for 3h esct	147570	6.75	N/A	lift rod bearing chr
143327	7.70	N/A	mounting shank	147571	30.35	N/A	vessel ext. stud chr
144266	6.45	N/A	cartridge nut service kit	147573	36.70	Chrome	handle kit chr
144450	17.40	Chrome	lever handle kit,cold,chr	147574	72.45	Chrome	esct chr
144451	17.40	Chrome	lever handle kit,hot,chr	147575	6.60	N/A	hh esct set screw & plug btn chr
144454	21.40	Chrome	escutcheon kit,chrome	147576	76.00	Chrome	esct chr
144455	2.50	Chrome	gasket chr	148282	8.35	Chrome	1.75 flow restrictor
146190	7.45	N/A	mounting hardware	148478	6.65	Chrome	3f dvtr vlv plaster ground
146194	4.45	N/A	cartridge nut	148479	33.15	Chrome	3f dvtr vlv 1" ext kit
146210	36.45	Chrome	handle kit chr	148480	33.15	Chrome	3f dvtr vlv escut
146211	15.05	Chrome	dome chr	148521	13.25	N/A	support plate
146213	6.45	N/A	o-ring	148606	12.45	N/A	posi cpvc adpt service kit
146214	38.25	Chrome	handle kit chr	148820	33.15	Chrome	handle kit kd pulldown chr
146217	15.45	Chrome	dome chr	148821	6.60	N/A	gasket kit kd
146220	41.90	Chrome	handle kit chr	148974	3.65	Chrome	deck gasket, solidad
146221	85.35	Chrome	receptor chr	149088	9.50	N/A	dvtr kit
146670	6.95	Chrome	slidebar esc cap chr	149111	36.70	Chrome	1h lav handle kit chr
146778	36.00	Chrome	esct 1h chateau kd chr	149112	22.35	Chrome	1 handle lav lift rod chr
146779	35.25	Chrome	esct 1h chateau spray in deck chr	149113	56.80	Chrome	2h lav handle kit chr
146780	47.20	Chrome	hdl 1h castleby kd chr	149114	260.45	Chrome	spt, ws chr
146781	32.45	Chrome	hdl 1h chateau kd chr	149115	18.80	Chrome	lift rod, ws chr
146782	33.10	Chrome	hdl 1h loop chateau kd chr	149116	340.10	Chrome	3hole rt spt chr
146783	12.25	Chrome	1h kitchen dome chr	149117	16.00	N/A	rt aerator
146784	201.65	Chrome	1h kitchen spout camerist chr	149118	368.55	Chrome	4h rt spt chr
146786	68.25	Chrome	1h kitchen spout chateau chr	149119	26.15	Chrome	lift rod, rt chr
146787	7.85	N/A	bearing washer camerist 1h kitchen	149121	6.25	N/A	red/blue handle indicator rings
146788	39.70	Chrome	sgl mt esc chateau kitchen chr	149122	41.40	Chrome	posi shr hdl chr

Moen Genuine Parts

Listed in numerical order

Part Number	List	Finish	Description
149123	68.20	Chrome	esct, posi chr
149381	10.00	N/A	moentrol plaster ground for 3f kit
149509	45.20	Chrome	wand kit, chr
149570	40.85	Chrome	handle lever kit, chrome
149571	46.40	Chrome	escutcheon, chrome
149748	16.30	Chrome	plug button kit chr
150036	26.50	Chrome	screw and cap kit chr
150259	42.15	N/A	hose kit
150288	239.90	Chrome	spout 1h kit chr
150313	10.80	N/A	installation tool, 3/8" square
150625	29.80	Chrome	lvr hdl chr
150626	30.35	Chrome	lvr hdl chr
150628	8.95	Chrome	dome chr
150662	32.85	Chrome	handle kit chr
150663	61.20	Chrome	esct bar/kd 1 hndl ring chr
150665	46.35	Chrome	handle kit, 1 handle bar chr
150666	12.45	Chrome	dome, 1 handle kitchen chr
150667	46.35	Chrome	esct bar/kd 1 hndl ring chr
150671	34.55	Chrome	handle kit, 1 handle bar chr
150672	133.55	Chrome	spout kit 1h bar
150883	4.60	N/A	color indicators
151189	36.75	Chrome	wand kit bar/prep chr
151644	1.70	N/A	red/blue 1h plug button mod
151813	26.90	Chrome	3 hole lav esct chr
152859	6.00	Chrome	1255 plug button chr
153206	9.45	Chrome	handle dome chr
153641	61.20	Chrome	hndl dome wthl 1h kd/bar chr
153977	54.85	Chrome	pulldown wand chr
153978	35.80	Chrome	handle kit kd pulldown chr
153983	5.50	N/A	gasket kit kd
154285	70.75	Chrome	hdl caps, english & french
154286	208.30	Chrome	weymouth ws lav spt kit
154287	24.65	Chrome	weymouth ws lift rod kit
154288	27.35	Chrome	weymouth lav aer shell & insert
154290	262.75	Chrome	weymouth 3h rt spt
154291	285.80	Chrome	weymouth 4h rt spt
154292	17.20	Chrome	weymouth 4h rt lift rod kit
154293	455.10	Chrome	weymouth wlmt lav spt kit
154294	29.90	Chrome	weymouth 1h lav hdl kit
154295	40.65	Chrome	weymouth rt aer shell & insrt
154297	10.55	Chrome	trad slide bar end cap chr
154298	19.20	Chrome	weymouth extmp hdl insrt chr
154299	69.70	Chrome	weymouth extmp esct kit chr
154302	57.50	Chrome	weymouth posi hdl kit chr
154306	17.20	Chrome	diverter plug kit chr
155023	6.00	N/A	single handle set screw
155649	51.00	Chrome	square escutcheon ring w/ gasket chr
155650	45.45	Chrome	round escutcheon ring w/ gasket chr
155651	20.45	N/A	housing nut
155652	7.85	N/A	set screw kit
155654	5.40	N/A	o-ring kit
155655	1.65	N/A	screen filter
155658	18.20	N/A	set screw, test plug & cap kit
155759	9.95	N/A	bracket screws
156723	19.20	Chrome	chateau knob handle kit, chr
156724	55.25	Chrome	chateau lever handle kit, chr
157131	34.85	Chrome	esct posi-temp chr
157328	51.70	Chrome	escutcheon & gasket kit chr
158080	17.65	Chrome	90 degree wlmt spt esct chr
158376	41.45	Chrome	shower arm & flange kit chr
158378	66.10	Chrome	tub spout kit
158380	44.15	Chrome	handle kit chr
158494	35.70	Chrome	icon 1h hc handle chr

Part Number	List	Finish	Description
158495	40.90	Chrome	brantford 1h hc handle chr
158550	5.70	N/A	1.5gpm kitchen screen kit
159014	48.15	Chrome	escutcheon kit icon chr
159018	86.65	Chrome	thermostatic hdl kit rothbury chr
159019	86.50	Chrome	thermostatic hdl kit 90 degree chr
159020	87.05	Chrome	volume hdl kit icon chr
159023	72.60	Chrome	esct kit 90 degree chr
159024	86.20	Chrome	thermostatic hdl kit icon chr
159028	87.40	Chrome	volume hdl kit 90 degree chr
159029	87.45	Chrome	volume hdl kit rothbury chr
159107	42.25	Chrome	hdl, mtcls ws 2h hdl lav & bdt chr
159264	41.40	Chrome	3f dvtr vlv escut, chr
159266	43.00	Chrome	3f dvtr lever kit, chr
159299	0.50	N/A	0-ring kit
159465	0.30	N/A	plunger kit
159466	0.05	N/A	cartridge nut kit
159467	1.40	N/A	2h duralast cartrdge kit
159559	16.15	N/A	pullout kitchen weight
159560	40.90	N/A	pullout kitchen hose
159561	65.10	Chrome	wand kit chr
159582	20.65	N/A	transfer hose kit tc/sae
160657	28.25	N/A	duralast & nut kit
160660	8.80	Chrome	handle dome kit, chr
161143	66.20	Chrome	wand exta 1h kd p-os, chr 1.5gpm
161148	73.35	Chrome	wand kit chr 1.5gpm
161149	107.80	Chrome	wand kit chr 1.5gpm
161150	98.95	Chrome	pulldown wand chr 1.5gpm
161153	44.50	Chrome	wand kit 1.5gpm
161156	63.95	Chrome	wand kit bar/prep chr 1.5gpm
161157	54.85	Chrome	pulldown wand chr 1.5gpm
161756	29.65	N/A	mounting hardware kit
161757	8.75	N/A	cartridge nuts (2)
161758	31.45	N/A	hot/cold stem extensions
161759	6.45	N/A	mud caps (2)
161760	7.80	N/A	spout shank clip
161761	44.90	N/A	adjustable spout shank
161762	28.95	N/A	mounting brackets kit
161771	11.20	N/A	mounting hardware kit
161772	41.70	N/A	roman tub diverter kit
161773	24.00	N/A	diverter nut removal tool
161774	11.80	N/A	handle adapter (2)
161909	34.00	Chrome	1h 1h handle kit chr
161917	18.15	Chrome	1h 1h lift rod chr
161942	71.40	Chrome	widespread handle kit chr
161944	166.55	Chrome	widespread spout kit chr
161945	47.90	Chrome	centerset handle kit chr
161947	354.20	Chrome	non diverting rt spout chr
161949	387.00	Chrome	diverting rt spout chr
161950	19.20	Chrome	roman tub lift rod chr
161952	55.35	Chrome	posi showering escutcheon chr
161953	41.40	Chrome	moentrol showering escutcheon chr
161954	50.80	Chrome	showering handle chr
161956	7.70	Chrome	temp ind rings chr
162105	13.25	N/A	nsrt knb cht lav
162154	32.65	N/A	2f diverter cartridge
162378	11.95	N/A	1.5 gpm kitchen check valve
162379	11.95	N/A	1.5 gpm kitchen check valve
163053	224.05	Chrome	wallmount spout kit, chr
163138	47.90	Chrome	handle kit cold chr
163153	34.15	Chrome	transfer valve escutcheon ch
163244	71.35	Chrome	1.5 gpm wand kit chr
163245	206.10	Chrome	spout kit chr
163247	67.60	Chrome	receptor kit chr

Suggested List Prices / 571
Moen Genuine Parts
 Listed in numerical order

Part Number	List	Finish	Description
163248	71.40	Chrome	1.5gpm wand kit chr
163710	7.60	N/A	hose guide
163711	14.55	N/A	battery pack
163714	241.40	N/A	electronics box
163716	15.30	N/A	filter screen hose
163717	15.40	N/A	filter screen control box
163718	30.45	N/A	outlet hose
163792	4.40	Chrome	cap, chr
163793	5.25	N/A	hardware kit
163949	4.85	Chrome	rubber lift rod plug button grey
164486	14.65	Chrome	sidespray chr
164487	30.50	Chrome	weymouth kitchen handle kit chr
164488	48.65	Chrome	aerator shell and insert chr
165010	44.10	Chrome	handle kit chr
165011	14.15	Chrome	handle esct kit chr
165193	45.00	Chrome	widespread handle kit chr
165572	3.75	N/A	lift rod guide kit
165903	28.00	Chrome	1h1h handle kit chr
165904	31.45	Chrome	1h1h handle dome kit chr
165905	60.35	Chrome	lavatory handle kit chr
165906	307.45	Chrome	widespread spout kit chr
165907	6.55	N/A	temp indicator rings
165908	275.90	Chrome	roman tub non-diverting tub spout chr
165909	472.20	Chrome	roman tub diverting tub spout chr
165910	62.80	Chrome	roman tub lift rod chr
165913	41.40	Chrome	posi-temp shower handle kit chr
165916	81.70	Chrome	thermostatic handle kit chr
165917	81.20	Chrome	volume control handle kit chr
165922	24.90	Porcelain	porcelain diverter handle cap kit chr
165998	32.45	Chrome	weymouth kitchen spout finial
166471	2.70	N/A	s-spout o-ring kit
168492	108.10	Chrome	wand kit chrome
168494	28.25	Chrome	handle chr
168495	174.00	Chrome	kitchen spout chr
168496	38.20	Chrome	sidespray kit chr
168497	112.10	Chrome	bar spout chr
168498	6.60	N/A	gasket
168499	9.70	Chrome	aerator kit
168500	108.05	N/A	wand kit
168501	187.05	Chrome	spout kit chr
168502	33.05	Chrome	handle kit chr
168503	167.85	Chrome	spout kit chr
168504	6.60	N/A	gasket
168682	287.30	Chrome	wall mount spout kit
168683	84.10	Chrome	3/4 thermostatic shower escutcheon o-ring kit
168994	7.20	N/A	escutcheon & gasket kit, chr
169252	40.45	Chrome	aerator extension kit
169507	18.60	Chrome	vestige spout kit chr
170145	404.60	Chrome	diverter tub spout kit,chr
170190	54.50	Chrome	duralast upper bearing (ca) kit
170206	7.35	N/A	shroud cover kit
171325	9.90	N/A	shower handle kit
172654	43.50	Chrome	transfer trim escutcheon
172655	40.60	Chrome	roman tub lift rod
172658	48.50	Chrome	4h roman tub spout
172659	295.75	Chrome	3h roman tub spout tub kit
172660	290.70	Chrome	widespread lift rod
172661	43.30	Chrome	widespread spout kit
172662	24.70	Chrome	handle kit
172663	57.00	Chrome	single hole handle kit with red/blue

Part Number	List	Finish	Description
172667	12.75	Chrome	single handle low profile lav lift rod k
172668	14.25	Chrome	single handle single hole escutcheon kit
172669	60.65	Chrome	moentrol shower escutcheon kit
173717	36.30	N/A	filter plug
173720	3.75	N/A	wand screen & o-ring kit (1.5gpm)
173816	40.50	Chrome	wand kit chr
173988	93.75	Chrome	wand kit chr
174290	23.40	N/A	2h duralast stem ext. kit
174291	46.95	N/A	duralast valve body kit cold
174292	46.95	N/A	duralast valve body kit hot
174329	10.55	N/A	handle adapter kit
174333	52.90	Chrome	posi escutcheon red/blue
174836	5.50	N/A	diverter retainer clip
175376	42.70	Chrome	handle kit chr
175377	56.25	Chrome	escutcheon kit chr
175378	38.70	Chrome	lift rod chr
175379	55.50	Chrome	lever handle kit chr
175380	70.60	Chrome	cross handle kit chr
175381	182.05	Chrome	widespread spout kit chr
175382	350.15	Chrome	3h roman tub spout chr
175383	56.25	Chrome	escutcheon chr
175394	79.60	N/A	piston, bulk kit
175983	181.15	Chrome	kitchen spout kit chr
175985	30.95	Chrome	kitchen handle kit chr
175991	5.15	N/A	deck gasket
176077	95.90	Chrome	flangeless spout kit 173888 ch
176078	106.45	Chrome	flangeless spout kit 173890 ch
176079	102.90	Chrome	flangeless spout kit 173892 ch
176081	109.50	Chrome	flangeless spout kit 173895 ch
176086	110.80	Chrome	flangeless spout kit 172905 ch
176101	29.60	Chrome	1h lav hdl kit, h/c ind, chr
176261	76.20	Chrome	spout kit, bar chr
176633	39.05	Chrome	diverter ring chr
177049	25.90	N/A	o-ring kit 4.5 x 1.78mm
177054	0.10	N/A	o-ring kit 9.19 x 2.62mm
177056	0.15	N/A	o-ring kit 18.72 x 2.62mm
177057	167.50	N/A	washer kit (2000 per box)
177138	44.85	Chrome	handle kit hot/cold chr
177167	44.05	Chrome	1h lav escutcheon plate chr
177567	18.15	N/A	battery holder & hardware pack
177568	129.40	N/A	electronics box only
177569	245.65	N/A	control box only
177570	12.75	N/A	mounting hardware
177572	29.80	N/A	supply hose assembly
177573	468.25	Chrome	spout kit, ch
177574	493.90	Chrome	spout kit, ch
177575	447.40	Chrome	spout kit, ch
177576	514.10	Chrome	spout kit, ch
177701	44.90	Chrome	knob, bdt dvtr chr
177702	39.90	Chrome	escut, bdt dvtr chr
177703	308.20	N/A	dvtr valve, vcm brkr
177705	70.00	N/A	spray nozzle chr
177706	16.50	N/A	cartridge nut
178216	37.20	Chrome	1h kitchen handle and set screw kit chr
178217	14.55	Chrome	1h kitchen handle dome kit chr
178218	97.60	Chrome	1h kitchen spout kit chr
178219	41.35	Chrome	1h kitchen spout hub kit chr
178231	20.60	Chrome	2h kitchen spout cap chr
178232	44.00	Chrome	2h kitchen hot handle kit chr
178233	88.55	Chrome	2h kitchen spout hub kit chr
178234	40.20	Chrome	escutcheon chr
178294	40.45	N/A	black stem extension

GENUINE PARTS

Moen Genuine Parts

Listed in numerical order

Part Number	List	Finish	Description
178462	41.05	Chrome	lever handle kit chr
178466	50.90	Chrome	3f transfer valve handle chr
178467	84.25	Chrome	3f transfer valve escutcheon kit chr
178888	213.60	Chrome	spout kit, chr
178890	209.45	Chrome	spout kit, chr
178892	230.45	Chrome	spout kit, chr
178894	281.50	Chrome	spout kit, chr
178896	296.35	Chrome	spout kit, chr
179084	44.00	Chrome	2h kitchen cold handle kit chr
179085	102.55	Chrome	2h kitchen spout kit chr
179086	56.95	Chrome	traditional side spray w/poi chr
179100	34.25	Chrome	posi handle chr
179354	226.40	Chrome	lift rod kit chr
179572	100.20	N/A	data cable
179574	49.60	Chrome	wand kit chr
179639	15.90	N/A	filter & o-ring kit
179655	37.10	Chrome	handle kit, chr
179656	54.70	Chrome	wand kit, chr
179657	166.95	Chrome	receptor kit, chr
179675	20.05	Chrome	handle kit hot, chr
179781	18.20	Chrome	cs lift rod kit chr
179782	53.90	Chrome	centerset handle kit chr
179783	25.60	N/A	gasket
179784	68.85	Chrome	widespread handle kit chr
179785	267.65	Chrome	non diverting rt spout chr
179786	44.20	Chrome	widespread lift rod kit chr
179787	159.65	Chrome	widespread spout kit chr
179790	35.60	Chrome	escutcheon chr
179792	59.75	Chrome	handle kit chr
179793	24.85	Chrome	sidespray hose guide chr
179827	31.25	Chrome	handle kit 1h chr
179828	8.45	Chrome	lift rod chr
179830	40.05	Chrome	handle kit chr
179831	255.15	Chrome	spout kit chr
179832	13.70	Chrome	handle adapter chr
179833	14.90	Chrome	handle escutcheon chr
179836	47.80	Chrome	shower escutcheon chr
179837	37.90	Chrome	shower handle kit chr
179877	9.80	N/A	bearing washer & o-ring kit
179878	6.10	N/A	deck gasket
179879	21.35	N/A	waterway & o-ring kit
180059	100.95	N/A	wand kit
180073	46.35	Chrome	diverter lift rod chr
180157	9.25	N/A	aerator
180823	6.40	N/A	washer kit
181007	14.05	N/A	aerator .5gpm
181066	7.60	Chrome	male thread 1.2gpm aerator
181085	11.55	N/A	insrt aerator flow restricter 1.2 gpm
181089	44.50	Chrome	aerator asm kit
181106	68.70	Chrome	handle kit cold, chr
181107	68.70	Chrome	handle kit hot, chr
181250	69.50	N/A	quickmount sink installation kit
181502	32.70	Chrome	3f dvtr vlv escut, chr
181600	91.20	Chrome	3f dvtr lever kit, chr
181603	103.85	Chrome	3f dvtr lever kit, chr
181929	179.60	Chrome	swing arm and collar kit
181930	94.10	Chrome	spring and bearing kit
182074	450.90	Chrome	4h roman tub spout chr
182191	7.10	N/A	insrt aerator flow restricter 1.2 gpm
182212	142.40	Chrome	brantford ws spout kit
182213	138.15	Chrome	eva ws spout kit ch
182244	43.20	Chrome	handle kit hot/cold, chr
182496	40.75	Chrome	handle kit hot/cold, chr

GENUINE PARTS

Part Number	List	Finish	Description
182500	13.90	N/A	duralast hot/cold stem ext
182624	32.65	N/A	elbow adapter w/o-rings
182843	18.85	Chrome	lift rod kit, widespread ch
182862	68.20	Chrome	posi escutcheon red/blue
183245	14.55	N/A	aerator
183296	69.60	Chrome	handle kit chr
183297	106.75	Chrome	wand kit chr
183298	37.65	Chrome	receptor kit chr
183570	37.55	Chrome	slider kit for annex
183598	24.80	Chrome	handle kit chr
183599	5.95	N/A	weymouth tub filler screw kit
183732	14.85	N/A	aerator 1.2 gpm kit
183810	55.45	Chrome	genta posi handle kit chr
183961	40.10	N/A	3/4" inlet nipple, nut & o-ring kit
183962	34.75	N/A	filter screen, filter cap & o-ring kit
183963	17.25	N/A	controller mounting hardware kit
183964	37.90	N/A	1/2" inlet nipple, nut & o-ring kit
183965	39.65	N/A	1/2" outlet nipple, nut & o-ring kit
183966	132.95	N/A	data cable adapters kit
183969	19.60	N/A	controller mtg bracket & hardware kit
183972	50.10	N/A	ac adapter
184081	43.50	Chrome	1h handle kit
184082	11.85	N/A	1.0 gpm aerator kit
184083	12.55	N/A	.5 gpm aerator kit
184084	6.75	N/A	temp indicator ring kit
184085	148.95	Chrome	widespread spout kit
184086	173.35	Chrome	roman tub spout kit chr
184450	40.45	Chrome	hndl assy kit chr
184597	57.50	Chrome	handle kit, chr
184611	18.45	Chrome	handle kit, chr
184613	18.10	Chrome	lift rod kit, chr
185807	47.35	Chrome	1h handle kit chr
185808	18.50	Chrome	1h lift rod kit chr
185809	9.25	N/A	o-ring
185810	47.40	Chrome	1h escutcheon chr
185811	44.65	Chrome	cs lever handle kit chr
185812	19.75	Chrome	cs lift rod kit chr
185813	19.65	Chrome	ws spout cap chr
185814	20.80	Chrome	lift rod kit chr
185815	52.30	Chrome	handle kit chr
185816	166.65	Chrome	ws spout kit chr
185817	279.60	Chrome	3h rt spout kit chr
185818	259.75	Chrome	4h rt spout kit chr
185819	24.35	Chrome	rt diverter lift rod kit chr
185821	36.90	Chrome	shower handle kit chr
185823	32.55	Chrome	t valve escutcheon chr
185834	34.10	Chrome	moentrol escutcheon chr
185910	38.15	N/A	aerator kit 1.0gpm
186948	12.55	N/A	anchor service kit
187053	52.30	Chrome	magnetix docking cradle, chr
187073	55.75	Chrome	integrated deck plate chr
187728	44.95	Chrome	wand kit chr
187729	31.25	Chrome	handle kit chr
188029	28.95	Chrome	wand kit chr
188030	30.05	Chrome	handle kit chr
188612	70.60	Chrome	cnout hub kit, chr
188613	104.20	Chrome	handle kit, hot, chr
188614	104.20	Chrome	handle kit, cold, chr
190102	49.05	Chrome	handle kit chr
190112	40.90	Chrome	lift rod chr
190202	57.75	Chrome	lever handle kit chr
190322	317.85	Chrome	rt spout kit chr

Moen Genuine Parts

Listed in numerical order

Part Number	List	Finish	Description	Part Number	List	Finish	Description
190330	36.05	Chrome	deck plate kit	193245	74.70	Chrome	thermostatic hdl kit align chr
190444	31.75	Chrome	posi escutcheon chr	193246	75.55	Chrome	volume hdl kit align chr
190503	63.00	Chrome	shower handle kit chr	193247	73.30	Chrome	extmp escutcheon kit belfield chr
190843	10.05	N/A	aerator kit	193248	72.90	Chrome	thermostatic hdl kit belfield chr
190844	21.85	Chrome	lift rod kit chr	193249	73.70	Chrome	volume hdl kit belfield chr
190845	42.95	Chrome	handle lever kit chr	193250	139.85	Chrome	extmp escutcheon kit wynford chr
190846	60.05	Chrome	handle kit hot chr	193251	75.65	Chrome	thermostatic hdl kit wynford chr
190847	60.05	Chrome	handle kit cold chr	193252	76.45	Chrome	volume hdl kit wynford chr
190848	281.85	Chrome	ws spout kit chr	193253	94.45	Chrome	extmp escutcheon kit voss chr
190850	312.55	Chrome	3h rt spout kit chr	193254	73.70	Chrome	thermostatic hdl kit voss chr
190851	37.65	Chrome	diverter lift rod chr	193255	74.50	Chrome	volume hdl kit voss chr
190852	502.50	Chrome	4h rt spout kit chr	193256	137.55	Chrome	extmp escutcheon kit via chr
190853	46.75	Chrome	escutcheon chr	193257	80.00	Chrome	thermostatic hdl kit via chr
190854	49.45	Chrome	posi/moentrol escutcheon chr	193258	80.90	Chrome	volume hdl kit via chr
190856	60.30	Chrome	2f tv escutcheon chr	193499	295.40	Chrome	brantford wave kit chr
190857	66.10	Chrome	3f tv excutcheon chr	193753	49.35	N/A	seamless posi shallow wall kit
190858	64.35	Chrome	handle escutcheon kit chr	193800	10.00	N/A	moen disposal snap ring and simple snap
190859	75.50	Chrome	posi handle kit chr	193900	19.75	N/A	moen disposal unfinished flange kit
190860	77.20	Chrome	moentrol handle kit chr	194149	32.45	N/A	2 function diverter
190861	74.25	Chrome	2f tv handle kit chr	194993	24.05	Chrome	via protruded aerator shell kit, ch
190862	69.70	Chrome	3f tv handle kit chr	194994	24.05	Chrome	rizon protruded aerator shell kit, ch
191000	193.45	Chrome	arbor wave faucet assembly kit chr	194995	24.05	Chrome	protruded aerator shell kit, ch
191001	201.50	Chrome	sleek wave faucet assembly kit chr	195173	212.00	Chrome	spout kit chrome
191002	271.45	Chrome	align spring wave faucet assembly kit ch	195345	69.85	Chrome	et escutcheon kit chr
191004	50.35	Chrome	arbor power boost wand kit chr	195346	96.00	Chrome	thermostatic handle kit chr
191005	48.90	Chrome	brantford power boost wand kit chr	195347	52.50	Chrome	et short ring esc kit chr
192155	9.75	N/A	mounting hardware kit	195349	95.10	Chrome	volume handle kit chr
192555	8.35	N/A	1.75 showering restrictor	195356	28.60	Chrome	lever handle - chr
192731	39.25	N/A	tool, rt duralast cartridge	195357	68.55	Chrome	metal wand kit - chr
192799	17.50	N/A	1" extension kit	195358	40.75	Chrome	wheel handle kit - chr
192842	20.65	N/A	hdwr pack, mtg thin wall, posi	195359	79.75	Chrome	spout kit bar
192995	14.95	N/A	1" extension kit	195360	59.65	Chrome	metal bar wand kit - chr
193089	75.70	Chrome	2f tv escutcheon kit, ch	195361	31.00	N/A	large pulldown hose weight
193090	81.60	Chrome	posi handle kit, chr	195362	4.80	Chrome	deck gasket chr
193091	81.60	Chrome	moentrol handle kit,	195363	65.45	Chrome	kitchen pulldown spout kit chr
193092	82.00	Chrome	2f transfer valve handle kit, chr	195365	16.00	Chrome	bar pulldown spout kit chr
193093	76.85	Chrome	3f transfer valve handle kit, chr	195366	7.00	Glacier	decorative handle cap
193094	101.30	Chrome	shower escutcheon kit, ch	195367	33.70	Chrome	finished handle cap chr
193095	71.35	Chrome	2f tv escutcheon kit, ch	195369	32.20	Chrome	lever handle kit chr
193096	72.50	Chrome	3f tv escutcheon kit, ch	195370	19.50	Chrome	kitchen pulldown metal wand kit chr
193097	60.45	Chrome	handle hub escutcheon kit, ch	195383	15.50	Chrome	bar pulldown metal wand kit chr
193098	64.70	Chrome	posi handle kit, chr	195709	56.50	Chrome	hand shower cradle chr
193099	67.20	Chrome	moentrol handle kit, chr	195710	82.65	Chrome	handle kit chr
193100	65.15	Chrome	2f transfer valve handle kit, chr	195711	45.00	Chrome	diverter knob kit chr
193101	60.30	Chrome	3f transfer valve handle kit, chr	195712	150.05	Chrome	diverter kit chr
193102	7.15	N/A	handle hub screw kit	195809	18.55	N/A	cartridge nut
193103	29.80	N/A	mounting hardware kit, posi	196252	66.30	Chrome	lever handle kit chr
193104	39.70	N/A	mounting hardware kit, moentrol	196253	81.75	Chrome	cross handle kit chr
193105	40.70	N/A	mounting hardware kit, 2f	196267	47.40	Chrome	handle kit chr
193112	21.10	N/A	handle extension kit, moentrol	196268	185.60	Chrome	spout kit chr
193113	21.25	N/A	handle extension kit, 2f	196270	394.25	Chrome	spout kit chr
193114	21.55	N/A	handle extension kit, posi/3f	196271	331.35	Chrome	spout kit chr
193115	12.00	N/A	standoff screw kit, moentrol	196445	53.20	Chrome	handshower cradle kit, chr
193116	12.90	N/A	standoff screw kit, 2f	196446	48.65	Chrome	handshower cradle kit, chr
193117	16.50	N/A	standoff screw kit, posi & 3f	196447	56.55	Oil Rubbed Bronze	handshower cradle kit, ch
193163	30.60	N/A	mounting hardware kit, 3f	196448	47.45	Oil Rubbed Bronze	handshower cradle kit, ch
193193	120.55	Chrome	diverter kit chr	196449	73.10	Chrome	handle kit, chr
193194	45.70	Chrome	diverter knob kit chr	196450	75.10	Chrome	handle kit, chr
193195	46.60	Chrome	handshower cradle kit chr	196451	83.60	Chrome	handle kit, chr
193196	86.00	Chrome	handle kit chr	196452	36.60	Chrome	diverter knob kit, chr
193197	13.90	N/A	cartridge nut	196453	149.10	Chrome	diverter kit, chr
193244	85.05	Chrome	extmp escutcheon kit align chr	196454	38.40	Chrome	diverter knob kit, chr

Moen Genuine Parts

Listed in numerical order

Part Number	List	Finish	Description
196455	150.05	Chrome	diverter kit, chr
196456	35.00	Chrome	diverter knob kit, chr
196457	162.20	Chrome	diverter kit, ch
196458	37.60	Chrome	diverter knob kit, chr
196459	163.80	Chrome	diverter kit, ch
197000	4.90	N/A	wlmt vlv mounting screws (3)
197001	37.75	N/A	adjustable wlmt lav shank kit
197002	22.75	N/A	wlmt lav handle stem extension kits
197003	23.75	N/A	adjustable wlmt lav handle adaptors
197004	18.35	N/A	cutable wlmt valve stem extenders
197171	17.10	N/A	filter kit
197584	22.90	Chrome	ws lift rod kit ch
197585	263.05	Chrome	ws spout kit
197586	62.60	Chrome	lever handle kit ch
197587	81.75	Chrome	cross handle kit ch
197588	317.05	Chrome	rt spout kit ch
197590	325.25	Chrome	4h rt spout kit ch
197591	75.75	Chrome	shower escutcheon kit ch
197592	79.55	Chrome	posi handle kit ch
197593	80.95	Chrome	moentrol handle kit ch
197594	96.25	Chrome	thermostatic handle kit ch
197595	95.35	Chrome	volume handle kit ch
197596	53.45	Chrome	2/3ft tv escutcheon ch
197597	78.55	Chrome	2/3ft tv handle ch
197598	53.75	Chrome	3ft tv escutcheon ch
197599	73.85	Chrome	3ft tv handle assembly ch
197600	64.10	Chrome	handshower cradle kit ch
197601	81.00	Chrome	tubfiller handle kit ch
197857	12.45	N/A	hardware kit
197869	338.05	Chrome	spout kit chr
197870	349.50	Chrome	spout kit
197872	36.30	Chrome	handle kit, chr
197883	161.55	Chrome	swing arm and docking collar kit
197884	77.25	Chrome	spring & docking collar chr
197930	32.45	N/A	3 function diverter
197931	113.80	Chrome	escutcheon chr
197932	92.45	Chrome	escutcheon chr
197933	116.70	Chrome	escutcheon chr
197934	80.70	Chrome	escutcheon chr
197935	87.45	Chrome	escutcheon chr
197936	92.15	Chrome	escutcheon chr
197937	111.40	Chrome	escutcheon chr
197938	115.00	Chrome	escutcheon chr
197939	114.90	Chrome	escutcheon chr
197940	114.90	Chrome	escutcheon chr
197941	82.70	Chrome	escutcheon chr
197942	30.00	Chrome	handle chr
197943	26.35	Chrome	handle chr
197944	29.05	Chrome	handle chr
197945	28.60	Chrome	handle chr
197946	29.65	Chrome	handle ch
197947	32.55	Chrome	handle chr
197948	35.50	Chrome	handle chr
197949	32.85	Chrome	handle chr
197950	35.25	Chrome	handle hub chr
197951	30.75	Chrome	handle chr
197952	28.05	Chrome	handle chr
197953	18.80	Chrome	handle adapter kit
197954	16.25	Chrome	handle adapter kit
198018	36.45	Chrome	slider chr
198019	8.80	Chrome	plug button chr
198027	33.00	Chrome	diverter valve escut, chr
198028	45.35	Chrome	diverter valve escut, chr

Part Number	List	Finish	Description
198029	51.70	Chrome	diverter valve escut, chr
198030	42.20	Chrome	diverter valve escut, chr
198031	48.95	Chrome	diverter valve escut, chr
198032	41.80	Chrome	diverter valve escut, chr
198033	43.10	Chrome	diverter valve escut, chr
198036	73.75	N/A	3ft tv escutcheon kit, ch
198038	97.20	Chrome	shower escutcheon kit, ch
198040	53.55	Chrome	handle hub escutcheon kit, ch
198107	21.35	Chrome	two piece lift rod kit, ch
198279	108.30	Chrome	wand kit chr
198280	110.25	Chrome	wand kit chr
198288	79.05	Chrome	spout kit chr
198289	23.90	Chrome	handle kit chr
198490	242.50	Chrome	roman tub spout chr
198880	48.55	Chrome	2h kitchen h/c handle chr
198881	44.10	Chrome	esc kit chr
198921	92.65	Chrome	wand kit, chr
198922	130.15	Chrome	spout kit, chr
198923	63.90	Chrome	handle kit, chr
198925	15.75	Chrome	receptor assy kit, chr
198951	44.90	Chrome	posi handle kit chr
199097	86.45	Chrome	spring & bearing kit ch
199098	92.40	Chrome	swing arm & collar kit ch
199477	215.40	Chrome	non diverting rt spout kit chr
199490	287.75	Chrome	roman tub spout ch
199754	5.55	N/A	brake and t/s - posi
200001	464.10	Chrome	arris spout chr
200007	13.50	N/A	manifold mounting hardware
200008	86.90	N/A	single riser manifold mounting plate
200009	70.85	N/A	double riser manifold mounting plate
200010	127.30	N/A	single riser bracket extension arm
200011	103.15	N/A	double riser bracket extension arm
200012	31.55	N/A	single riser mud cover
200013	27.65	N/A	double riser mud cover
200014	64.70	Chrome	wand kit chr
200101	0.20	Chrome	plug button kit, chr
200711	20.55	Chrome	M-CORE diverter backing plate kit
200712	8.60	Chrome	M-CORE diverter screw kit
200713	8.45	Chrome	M-CORE diverter handle adaptor kit
200714	28.35	Chrome	handle kit, chr
200715	32.05	Chrome	M-CORE diverter escutcheon kit, chr
200716	29.90	Chrome	handle kit, chr
200717	34.10	Chrome	M-CORE diverter escutcheon kit, chr
200718	31.20	Chrome	handle kit, chr
200719	34.10	Chrome	M-CORE diverter escutcheon kit, chr
200720	36.00	Chrome	handle kit, chr
200721	66.35	Chrome	M-CORE diverter escutcheon kit, chr
200722	28.25	Chrome	handle kit, chr
200723	31.05	Chrome	M-CORE diverter escutcheon kit, chr
200724	28.50	Chrome	handle kit, chr
200726	29.15	Chrome	handle kit, chr
200727	29.60	Chrome	M-CORE diverter escutcheon kit kit, chr
200728	28.05	Chrome	handle kit, chr
200729	29.15	Chrome	M-CORE diverter escutcheon kit kit, chr
200730	21.70	Chrome	handle kit, chr
200731	24.95	Chrome	M-CORE diverter escutcheon kit kit, chr
200732	34.00	Chrome	handle kit, chr

Moen Genuine Parts

Listed in numerical order

Part Number	List	Finish	Description
200733	34.10	Chrome	M-CORE diverter escutcheon kit kit, chr
200734	31.05	Chrome	handle kit, chr
200735	35.00	Chrome	M-CORE diverter escutcheon kit kit, chr
200736	35.10	Chrome	handle kit, chr
200737	36.50	Chrome	M-CORE diverter escutcheon kit kit, chr
200738	30.95	Chrome	handle kit, chr
200739	30.15	Chrome	M-CORE diverter escutcheon kit kit, chr
200740	29.60	Chrome	handle kit, chr
200741	45.55	Chrome	M-CORE diverter escutcheon kit kit, chr
200742	32.15	Chrome	handle kit, chr
200743	30.70	Chrome	M-CORE diverter escutcheon kit kit, chr
200744	28.05	Chrome	handle kit, chr
200745	30.15	Chrome	M-CORE diverter escutcheon kit, chr
200746	33.55	Chrome	handle kit, chr
200747	28.95	Chrome	M-CORE diverter escutcheon kit kit, chr
200748	27.80	Chrome	handle kit, chr
200749	29.90	Chrome	M-CORE diverter escutcheon kit, chr
200750	29.60	Chrome	handle kit, chr
200751	3.50	N/A	M-CORE flush plug with nut kit
200752	7.40	N/A	M-CORE control plaster ground kit
200753	9.90	N/A	M-CORE stacked plaster ground kit
200754	7.50	N/A	M-CORE diverter plaster ground kit
200757	9.90	N/A	M-CORE diverter cartridge nut kit
200758	33.30	N/A	M-CORE discrete diverter cartridge kit
200759	39.75	N/A	M-CORE shared diverter cartridge kit
200761	4.10	Chrome	M-CORE diverter limit and clip
200762	17.50	N/A	M-CORE cartridge nut kit
200764	9.55	Chrome	M-CORE control valve hardware kit
200765	14.75	Chrome	M-CORE stacked valve hardware kit
200766	22.75	Chrome	M-CORE control backing plate kit, round
200767	22.75	Chrome	M-CORE control backing plate kit, square
200768	22.75	Chrome	M-CORE control backing plate kit, voss
200769	33.90	Chrome	M-CORE stacked backing plate kit, round
200770	33.90	Chrome	M-CORE stacked backing plate kit, square
200771	33.90	Chrome	M-CORE stacked backing plate kit, voss
200772	7.80	Chrome	M-CORE round snap ring kit
200773	15.85	Chrome	M-CORE square snap ring kit
200774	15.75	Chrome	M-CORE voss snap ring kit
200775	14.15	Chrome	M-CORE sleeve kit, round modern, chr
200776	12.95	Chrome	M-CORE sleeve kit, round traditional, chr
200777	14.85	Chrome	M-CORE sleeve kit, square, chr
200778	14.85	Chrome	M-CORE sleeve kit, voss, chr
200782	26.35	Chrome	M-CORE handle kit, chr
200783	51.90	Chrome	M-CORE escutcheon kit, chr
200784	41.80	Chrome	M-CORE handle kit, chr
200785	51.15	Chrome	M-CORE escutcheon kit, chr
200786	29.70	Chrome	M-CORE handle kit, chr
200787	34.65	Chrome	M-CORE escutcheon kit, chr
200788	31.05	Chrome	M-CORE handle kit, chr
200789	46.75	Chrome	M-CORE escutcheon kit, chr

Part Number	List	Finish	Description
200790	42.25	Chrome	M-CORE handle kit, chr
200791	29.15	Chrome	M-CORE handle kit, chr
200792	31.65	Chrome	M-CORE handle kit, chr
200793	63.35	Chrome	M-CORE escutcheon kit, chr
200794	29.05	Chrome	M-CORE handle kit, chr
200795	46.75	Chrome	M-CORE escutcheon kit, chr
200796	42.85	Chrome	M-CORE handle kit, chr
200797	63.25	Chrome	M-CORE escutcheon kit, chr
200798	27.65	Chrome	M-CORE handle kit, chr
200799	40.50	Chrome	M-CORE escutcheon kit, chr
200800	28.15	Chrome	M-CORE handle kit, chr
200801	58.95	Chrome	M-CORE escutcheon kit, chr
200802	31.20	Chrome	M-CORE handle kit, chr
200803	63.25	Chrome	M-CORE escutcheon kit, chr
200804	36.85	Chrome	M-CORE handle kit, chr
200805	82.40	Chrome	M-CORE escutcheon kit, chr
200806	34.30	Chrome	M-CORE handle kit, chr
200807	71.30	Chrome	M-CORE escutcheon kit, chr
200808	32.50	Chrome	M-CORE escutcheon kit, chr
200809	72.75	Chrome	M-CORE escutcheon kit, chr
200810	85.00	Chrome	M-CORE escutcheon kit, chr
200811	44.20	Chrome	M-CORE escutcheon kit, chr
200812	88.90	Chrome	M-CORE escutcheon kit, chr
200813	115.90	Chrome	M-CORE escutcheon kit, chr
200814	94.60	Chrome	M-CORE escutcheon kit, chr
200815	138.90	Chrome	M-CORE escutcheon kit, chr
200816	74.35	Chrome	M-CORE escutcheon kit, chr
200817	111.80	Chrome	M-CORE escutcheon kit, chr
200818	42.50	Chrome	M-CORE escutcheon kit, chr
200819	70.20	Chrome	M-CORE escutcheon kit, chr
200820	34.30	Chrome	M-CORE handle hub kit, chr
200821	34.75	Chrome	M-CORE handle hub kit, chr
201203	68.20	Chrome	colinet tvr hdl kit chr
201204	68.60	Chrome	colinet cross hdl kit chr
201205	224.65	Chrome	colinet wmt lav spst kit chr
201206	49.05	Chrome	ws lift rod kit chr
201207	173.05	Chrome	ws spout kit chr
201208	428.55	Chrome	rt spout kit chr
201209	464.75	Chrome	4h rt spout kit chr
201211	99.70	Chrome	shower escutcheon kit chr
201212	57.50	Chrome	posi handle kit chr
201213	101.10	Chrome	thermostatic handle kit chr
201214	100.00	Chrome	volume handle kit chr
201215	90.35	Chrome	handshower cradle kit chr
201216	85.40	Chrome	tubfiller handle kit chr
201217	45.15	Chrome	diverter knob kit, chr
201218	168.45	Chrome	diverter kit, chr
201309	40.05	N/A	smart faucet - battery pack/ mounting kit
201310	8.00	N/A	u by moen smart faucet mounting hrdw
201311	686.95	N/A	u by moen smart faucet control box
201899	38.70	Chrome	escutcheon kit chrome
201900	32.90	Chrome	1h lav handle kit chrome
201901	148.50	Chrome	2h ws spout kit chrome
201902	50.30	Chrome	2h ws handle kit chrome
201903	229.15	Chrome	3h rt spout kit chrome
201905	71.00	Chrome	1f handle kit chrome
201906	50.30	Chrome	1f hand shower cradle kit chrome
201907	25.60	Chrome	transfer valve handle kit chrome
201908	28.75	Chrome	control handle kit chrome
201909	71.55	Chrome	thermostatic hdl kit chrome
201910	71.40	Chrome	volume hdl kit chrome
201911	117.70	Chrome	tub spout kit chrome
201912	44.00	Chrome	shower handle kit chrome

Moen Genuine Parts

Listed in numerical order

Part Number	List	Finish	Description
201913	10.90	Chrome	2hws hdl esct kit chrome
201914	12.40	Chrome	2hws spout esct kit chrome
201915	12.40	Chrome	3h rt hdl esct kit chrome
201916	16.00	Chrome	3h rt spout esct kit chrome
201991	129.50	Chrome	spout kit
201992	330.15	Chrome	spout kit
201993	44.35	Matte Black	wand kit
201994	48.30	Chrome	wand kit
204687	25.30	Chrome	handle kit ch
204688	26.65	Chrome	handle hub
204772	155.75	Chrome	spout, pulldown
204773	180.60	Chrome	spout, bar
204774	722.30	Chrome	u by moen spout
204775	75.35	Chrome	powerboost wand kit
204776	72.35	Chrome	wand kit
204777	70.45	Chrome	wand kit, bar
204778	29.90	Chrome	handle kit, sip
204779	5.45	N/A	gasket kit
205040	2.95	N/A	nozzle-et1100 et2200
205497	11.25	Polished Stainless	splashguard, 360 clean rinse
205845	39.60	Chrome	handle kit chr
205846	80.00	Chrome	wand kit chr
205847	51.90	Chrome	power boost wand kit chr
205848	475.20	Chrome	faucet assembly kit chr
205850	49.75	Chrome	handle kit chr
205883	17.30	N/A	deck gasket kit
206288	26.15	Chrome	finished h/c indicators, ch
206289	73.70	Chrome	escutcheon, ch
206290	25.45	Porcelain/Chrome	porcelain h/c handle cap
206291	78.25	Chrome	escutcheon, ch
206292	32.55	Chrome	handle, ch
206293	44.35	Chrome	escutcheon, ch
206294	24.10	Chrome	handle, ch
206295	49.80	Chrome	escutcheon, ch
206296	49.25	Chrome	escutcheon, ch
206297	35.40	Chrome	handle, ch
206301	41.30	Chrome	escutcheon, ch
206302	24.30	Chrome	handle, ch
206303	55.05	Chrome	escutcheon, ch
206305	27.85	Chrome	handle, ch
206306	60.40	Chrome	escutcheon, ch
206307	50.40	Chrome	escutcheon, ch
206308	29.50	Chrome	handle, ch
206309	68.35	Chrome	escutcheon, ch
206320	43.00	Chrome	escutcheon, ch
206321	25.60	Chrome	handle, ch
206322	52.90	Chrome	escutcheon, ch
206323	28.65	Chrome	handle, ch
206324	63.95	Chrome	escutcheon, ch
206325	83.40	Chrome	escutcheon, ch
206327	28.65	Chrome	handle, ch
206328	68.35	Chrome	escutcheon, ch
206329	28.65	Chrome	handle, ch
206330	68.35	Chrome	escutcheon, ch
207527	9.20	N/A	sensor extension cable
207669	14.30	N/A	M-CORE cartridge nut kit, brass
209475	165.75	Satin Stainless	grid kit, 209378 grid
209476	174.05	Satin Stainless	grid kit, 209379 grid
210492	56.50	N/A	wmtf ext kit, round modern, ch
210563	11.85	N/A	cartridge nut kit, rnd
210564	15.60	N/A	cartridge nut kit, sq
210565	20.60	N/A	control backing plate kit, rnd
210566	20.60	N/A	control backing plate kit, sq

Part Number	List	Finish	Description
210567	20.60	N/A	control backing plate kit, soft sq
210568	13.55	N/A	snap ring kit, rd
210569	13.55	N/A	snap ring kit, sq
210570	13.55	N/A	snap ring kit, soft sq
210571	1.10	N/A	test plug, wmtf
210573	62.20	Chrome	wmtf ext kit, sq, ch
210574	61.90	Chrome	wmtf ext kit, soft sq, ch
210575	33.65	Chrome	90 deg wmtf escutcheon kit, chr
210576	32.75	Chrome	align wmtf escutcheon kit, chr
210577	32.25	Chrome	traditional wmtf escutcheon kit, chr
210578	32.55	Chrome	cia wmtf escutcheon kit, chr
210579	63.15	Chrome	colinet wmtf escutcheon kit, chr
210580	35.40	Chrome	doux wmtf escutcheon kit, chr
210581	61.80	Chrome	flara wmtf escutcheon kit, chr
210582	34.15	Chrome	genta wmtf escutcheon kit, chr
210583	29.15	Chrome	gibson wmtf escutcheon kit, chr
210584	33.75	Chrome	glyde wmtf escutcheon kit, chr
210585	35.80	Chrome	voss wmtf escutcheon kit, chr
210586	6.95	N/A	wmtf plaster ground kit
210843	25.55	Chrome	M-CORE handle kit, chr
211113	33.80	Chrome	handle kit
211114	18.30	Chrome	lift rod kit
211115	31.40	Chrome	handle kit
211116	26.00	Chrome	lift rod kit
212144	288.35	Chrome	riley wave faucet assy kit, chr
212241	112.30	Stainless	colander service kit
215667	19.10	Chrome	deck plate kit
215995	46.95	N/A	ws vlv body kit (cold)
215996	46.95	N/A	ws vlv body kit (hot)
215997	43.05	N/A	ws hdwr pack kit
215998	39.85	N/A	ws hose kit
216711	8.40	N/A	nsrt aerator flow restricter 1.5 gpm
217810	23.40	N/A	adapter nut
221641	87.70	Chrome	weymouth lvr hdl kit chr
221642	87.70	Chrome	weymouth cross hdl kit chr
222220	35.30	N/A	ac adapter kit
252001	38.05	Chrome	handle kit, chr
252002	37.30	Chrome	handshower cradle kit, chr
252005	27.15	N/A	cartridge kit, 1h
252006	51.30	N/A	cartridge sleeve
252007	54.45	N/A	cartridge nut
252008	186.35	N/A	single post mounting bracket
252009	242.20	N/A	manifold w/stops, single riser
252010	149.45	Chrome	diverter kit chr
259416	154.65	Chrome	riser elbow kit, ch
259417	62.70	N/A	mounting screw kit
259418	48.80	N/A	leveling screw kit
259420	10.20	N/A	concrete rough in screws
259421	200.85	N/A	single manifold mounting bracket
259422	202.70	N/A	double manifold mounting bracket
259423	283.85	Chrome	riser kit, ch
259424	6.20	N/A	o-ring kit
262000	129.45	Chrome	handle kit cross, chr
262001	39.95	Chrome	handle kit lever, chr
262002	59.75	Chrome	handle hub, chr
262003	91.80	N/A	handle adaptor kit
262004	64.60	Chrome	wall escutcheon, chr
262005	328.90	Chrome	handshower cradle, chr
262006	36.10	Chrome	escutcheon floor, chr
262007	174.90	N/A	manifold w/ stops, double riser
262008	154.80	N/A	double post mounting bracket
262955	114.15	N/A	wall mount shanks

Moen Genuine Parts

Listed in numerical order

Part Number	List	Finish	Description	Part Number	List	Finish	Description
262956	1.55	N/A	handle brake kit (bulk)	100957SRS	32.35	Spot Resist Stainless	spout escutcheon w/led indicator srs
344111	21.45	Chrome	under deck parts (3942)	100961BG	187.60	Brushed Gold	spout kit bg
344112	90.95	Chrome	head and spout kit (3942) chr	100961BL	47.00	Matte Black	sip transitional spout kit, bl
344113	21.45	Chrome	under deck parts (3944)	100961BLS	275.30	Black/Stainless Steel	spout kit bls
344114	90.95	Chrome	head and spout kit (3944) chr	100961ORB	224.15	Oil Rubbed Bronze	sip transitional spout kit orb
716711	8.35	N/A	aerator flow restrictor 1.5gpm	100961SRS	187.60	Spot Resist Stainless	sip transitional spout kit srs
100005SLP	24.05	Brushed Platinum	esct ptcl kd 1h hose guide slp	101010ORB	27.30	Oil Rubbed Bronze	male thread 1.5gpm aerator
100009SL	280.95	Stainless	spt x cath kd 1h slt	101029ORB	31.15	Oil Rubbed Bronze	female thread 1.5gpm aerator
100011SL	44.70	Stainless	esct rng kd 1h sglmt sl	101029SRS	26.55	Spot Resist Stainless	aerator srs 1.5gpm
100012SL	65.85	Stainless	hdl mn/mtcl/pt kd 1h solid sl	101029WR	31.15	Wrought Iron	female thread 1.5gpm aerator
100021SLP	22.15	Brushed Platinum	hdl cap cht/mn kd 1h slp	101077SRS	18.65	Spot Resist Stainless	aerator srs 1.5gpm
100021W	22.55	Glacier	hdl cap cht/mn kd 1h glc	101120ORB	36.55	Oil Rubbed Bronze	aerator kit 1.5 gpm orb
100024BN	20.15	Brushed Nickel	tl mnt ts 3f bn	101120SRS	33.25	Spot Resist Stainless	aerator kit 1.5gpm srs
100080BG	83.75	Brushed Gold	mounting sleeve bg	101140BN	53.55	Brushed Nickel	1h lav handle kit, lever bn
100080BL	92.10	Black	mounting sleeve bl	101140NL	53.55	Polished Nickel	1h lav handle kit, lever nl
100080BN	83.75	Brushed Nickel	mounting sleeve bn	101140ORB	58.90	Oil Rubbed Bronze	1h lav handle kit, lever orb
100080NL	83.75	Polished Nickel	mounting sleeve nl	10116CBN	5.55	Classic Brushed Nickel	esct plug lav cbn
100109WBL	15.05	N/A	hdw pack kd 1h solid/loop	101246SL	109.85	Stainless	spt rcptr lgd/tc kd p-os sl
100112P	46.50	Polished Brass	fra male thrd mtcl lg 2.2 gpm pb crd	101249S	29.80	Sand/Almond/Bone	hdl collar&nut p-os 1h kd snd
100150BL	79.00	Matte Black	hdl lr nova loop bl	101249SL	28.10	Stainless	hdl collar&nut p-os 1h kd sl
100150CSL	162.20	Classic Stainless	hdl lr nova loop csl	101249V	29.80	Ivory	hdl collar&nut p-os 1h kd ivy
100150SL	79.00	Stainless	hdl lr nova loop sl	101249W	29.80	Glacier	dl collar&nut p-os 1h kd glc
100154SL	81.25	Stainless	hdl kit, nova 1h kd, sl	101964BN	38.70	Brushed Nickel	fra female thrd 2.2gpm bn
100155SL	30.20	Stainless	hdl cap, nova 1h kd, sl	101964ORB	42.60	Oil Rubbed Bronze	fra female thrd 2.2gpm orb
100439W	18.15	Glacier	dome cind/exta/pt/salora 1h kd lr glc	101964SRS	16.60	Spot Resist Stainless	fra female thrd 2.2gpm srs
100556BN	59.40	Brushed Nickel	handle hub & elbow bn	102562WR	25.25	Wrought Iron	st tube vlt/s wr
100558SL	68.25	Stainless	hdl, mtcl ws 2h lvr ts & kd sl	103455BN	120.25	Brushed Nickel	spry nzzl shrd & aer mtcl bdt bn
100621BC	82.45	Brushed Chrome	lever hdl kit, bc, cold	103455ORB	127.60	Oil Rubbed Bronze	spry nzzl shrd & aer mtcl bdt orb
100621CBN	60.50	Classic Brushed Nickel	lever hdl kit, cbn, cold	104235ORB	31.35	Oil Rubbed Bronze	hose guide
100624BC	82.45	Brushed Chrome	lever hdl kit, bc, hot	1047AMC	9.85	N/A	3 bolt hush cushion
100624CBN	60.50	Classic Brushed Nickel	lever hdl kit, cbn, hot	1055AMC	11.75	N/A	quick and hot tube kit
100649CBN	178.70	Classic Brushed Nickel	spt, ws, cbn, sk	114304CSL	66.25	Classic Stainless	hdl kit 7590 series csl
100650CBN	22.40	Classic Brushed Nickel	esc, ws, cbn, sk	114304ORB	94.45	Oil Rubbed Bronze	hdl kit 7590 series orb
100657BC	36.30	Brushed Chrome	hdl tc posi 1h ts lr bc	114304SL	66.25	Stainless	hdl kit 7590 series sl
100746BG	32.45	Brushed Gold	handle kit bg	114305CSL	25.85	Classic Stainless	hdl hub 7590 series csl
100746BL	89.00	Matte Black	sip transitional handle kit	114305ORB	46.10	Oil Rubbed Bronze	hdl hub 7590 series, orb
100746BLS	96.05	Black/Stainless Steel	handle bls	114324BN	32.70	Brushed Nickel	two handle lav
100746ORB	38.55	Oil Rubbed Bronze	sip transitional handle kit orb	114324ORB	35.80	Oil Rubbed Bronze	hdl caps, hot & cold orb
100746SRS	32.45	Spot Resist Stainless	sip transitional handle kit srs	114324W	5.25	Glacier/Chrome	hdl caps, hot & cold white
100820BG	107.10	Brushed Gold	spout kit bg	114324WR	35.80	Wrought Iron	hdl caps, hot & cold wr
100820BL	85.20	Matte Black	sip modern spout kit bl	114331BN	30.15	Brushed Nickel	hdl hub kgsy 2h lav bn 1
100820BLS	117.75	Black/Stainless Steel	spout kit bls	114331ORB	33.15	Oil Rubbed Bronze	hdl hub kgsy 2h lav orb 1
100820SRS	107.10	Spot Resist Stainless	sip modern spout kit srs	114331WR	33.15	Wrought Iron	hdl hub kgsy 2h lav wr 1
100895BG	37.20	Brushed Gold	handle kit bg	114332ORB	25.90	Oil Rubbed Bronze	fra male thrd kgsy 2.2 gpm orb
100895BL	162.75	Matte Black	sip modern handle kit, bl	114334BN	26.90	Brushed Nickel	lift rod kit bn
100895BLS	104.50	Black/Stainless Steel	handle bls	114334ORB	28.60	Oil Rubbed Bronze	lift rod kit orb
100895SRS	37.20	Spot Resist Stainless	sip modern handle kit srs	114334WR	28.60	Wrought Iron	lift rod kit wr
100896BG	118.80	Brushed Gold	spout kit bg	114336BG	24.65	Brushed Gold	handle lever bg
100896BL	57.20	Matte Black	sip traditional spout kit, bl	114336NL	74.05	Polished Nickel	lever handle
100896NL	187.85	Polished Nickel	sip traditional spout kit	114336ORB	23.35	Oil Rubbed Bronze	lever handle orb
100896ORB	145.95	Oil Rubbed Bronze	sip traditional spout kit orb	114336SRS	24.65	Spot Resist Stainless	lever handle srs
100896SRS	118.80	Spot Resist Stainless	sip traditional spout kit srs	114337BN	114.05	Brushed Nickel	hdl assy kgsy lr ws bn
100928BG	38.15	Brushed Gold	handle kit bg	114337ORB	125.40	Oil Rubbed Bronze	hdl assy kgsy lr ws orb
100928BL	151.00	Matte Black	sip traditional handle kit, bl	114337WR	125.40	Wrought Iron	hdl assy kgsy lr ws wr
100928NL	59.85	Polished Nickel	sip traditional handle kit	114343BN	26.30	Brushed Nickel	hdl caps & scrw bn
100928ORB	46.15	Oil Rubbed Bronze	sip traditional handle kit orb	114343ORB	28.95	Oil Rubbed Bronze	hdl caps & scrw orb
100928SRS	38.15	Spot Resist Stainless	sip traditional handle kit srs	114343WR	28.95	Wrought Iron	hdl caps & scrw wr
100957BG	32.35	Brushed Gold	spout escutcheon bg	114344BN	42.35	Brushed Nickel	hdl hub, t3111, t3112, t3113 bn
100957BL	74.55	Matte Black	sip escutcheon w/led indicator, bl	114344ORB	46.60	Oil Rubbed Bronze	hdl hub, t3111, t3112, t3113 orb
100957BLS	44.30	Black/Stainless Steel	spout escut bls	114346BN	46.55	Brushed Nickel	hdl assy kgsy t 1h ts posi bn
100957NL	42.25	Polished Nickel	sip escutcheon w/led indicator	114346NL	49.60	Polished Nickel	hdl assy kgsy t 1h ts posi nl
100957ORB	36.60	Oil Rubbed Bronze	spout escutcheon w/led indicator orb	114346ORB	51.10	Oil Rubbed Bronze	hdl assy kgsy t 1h ts posi orb
				114346WR	51.10	Wrought Iron	hdl assy kgsy t 1h ts posi wr

Moen Genuine Parts

Listed in numerical order

Part Number	List	Finish	Description
115030SLP	31.30	Brushed Platinum	lvr hdl hot 2h lav & kd slp
115034BC	16.40	Brushed Chrome	hdl cap kit 2h lav & kd
115034BL	6.85	Matte Black	hdl cap kit 2h lav & kd bl
115034BN	19.75	Brushed Nickel	hdl cap kit 2h lav & kd bn
115045SL	16.40	Stainless	fra female thrd 2.2gpm bnby 2h kd sl
115055BN	18.85	Brushed Nickel	hdl cap, scrw bn
115055CBN	9.80	Classic Brushed Nickel	hdl cap, scrw cbn
115060SLP	32.65	Brushed Platinum	hdl csby kd/lav 2h lvr cold box slp
115063BN	75.95	Brushed Nickel	lvr hdl, h & c bn
116606ORB	72.00	Oil Rubbed Bronze	esct, posi shr orb
116618BN	28.25	Brushed Nickel	fra female thrd 2.2gpm bn
116618CSL	28.25	Classic Stainless	fra female thrd 2.2gpm csl
116618ORB	31.15	Oil Rubbed Bronze	fra female thrd 2.2gpm orb
116618SRS	27.35	Spot Resist Stainless	aerator srs
116620NL	40.45	Polished Nickel	spt hub, 1h lav nl
116620ORB	118.45	Oil Rubbed Bronze	spt kit, ws lav orb
116628BN	24.80	Brushed Nickel	lvr hdl, ws lav bn
116628ORB	27.40	Oil Rubbed Bronze	lvr hdl, ws lav orb
116628WR	27.40	Wrought Iron	lvr hdl, ws lav wr
116629BN	113.35	Brushed Nickel	hdl hub, ws lav bn
116629ORB	122.95	Oil Rubbed Bronze	hdl hub, ws lav orb
116629WR	122.95	Wrought Iron	hdl hub, ws lav wr
116630BN	204.65	Brushed Nickel	spt cap, rt bn
116632NL	79.80	Polished Nickel	body aerator female thrd rmn tub nl bk
116640WR	149.55	Wrought Iron	spt kit, 1h kd wr
116641ORB	135.50	Oil Rubbed Bronze	spt kit, 1h kd orb
116641WR	135.50	Wrought Iron	spt kit, 1h kd wr
116648ORB	47.85	Oil Rubbed Bronze	lift rod kit, 2h lav orb
116649ORB	51.85	Oil Rubbed Bronze	spt cap, 2h lav orb
116664BN	253.30	Brushed Nickel	spt kit, t6125 bn
116664ORB	269.10	Oil Rubbed Bronze	spt kit, t6125 orb
116664WR	269.10	Wrought Iron	spt kit, t6125 wr
116665BN	428.85	Brushed Nickel	rt spt kit t920 series bn
116665ORB	455.50	Oil Rubbed Bronze	rt spt kit t9
116667ORB	29.35	Oil Rubbed Bronze	upper dvtrr rod t922 series orb
116672ORB	47.85	Oil Rubbed Bronze	handle escutcheon, s713orb orb
116672SRS	40.10	Spot Resist Stainless	handle escutcheon, srs
116672WR	47.85	Wrought Iron	handle escutcheon, s713wr
116673ORB	153.90	Oil Rubbed Bronze	side spray esc orb
116673SRS	128.70	Spot Resist Stainless	side spray srs
116673WR	153.90	Wrought Iron	side spray esc
116713BRB	98.10	Mediterranean Bronze	hdl kit brb
116728ORB	70.55	Oil Rubbed Bronze	handle kit
116728SL	64.25	Stainless	handle kit, 87780sl, 87790sl
116953BN	76.00	Brushed Nickel	hdl kit, hot bn
116953ORB	83.60	Oil Rubbed Bronze	hdl kit, hot
116953WR	83.60	Wrought Iron	hdl kit, hot wr
116954BN	76.00	Brushed Nickel	hdl kit, cold bn
116954ORB	83.60	Oil Rubbed Bronze	hdl kit, cold orb
116954WR	83.60	Wrought Iron	hdl kit, cold wr
118239BN	30.15	Brushed Nickel	thrd 2.2gpm mtcl bn
118239WR	33.15	Wrought Iron	fra male thrd 2.2gpm mtcl wr
118243BN	13.85	Brushed Nickel	plug button 6102 bn
118243ORB	15.20	Oil Rubbed Bronze	plug button, 6102 orb
118244BN	29.65	Brushed Nickel	lift rod 6102 bn
118244ORB	32.45	Oil Rubbed Bronze	lift rod, 6102 orb
118244WR	32.45	Wrought Iron	lift rod 6102 wr
1193BN	74.00	Brushed Nickel	esct ascr/csby/kg sy/vil bdt base bn
1193NL	78.80	Polished Nickel	esct ascr/csby/kg sy/vil bdt base nl
1193WR	81.45	Wrought Iron	esct ascr/csby/kg sy/vil bdt base wr
1225M	35.25	N/A	crtgr magnum with c-clip bulk
123247CSL	154.20	Classic Stainless	spt trad bar 2h csl

GENUINE PARTS

Part Number	List	Finish	Description
123247ORB	169.65	Oil Rubbed Bronze	bar spout kit
123247SRS	154.20	Spot Resist Stainless	bar spout kit srs
123250W	18.65	Glacier	dome, 1 handle kitchen, glc
123804BG	41.65	Brushed Gold	lift rod kit, widespread bg
123804BL	34.85	Matte Black	lift rod kit, widespread bl
123804BN	45.70	Brushed Nickel	lift rod kit, widespread bn
123807BG	17.20	Brushed Gold	stream straightener bg
123807BL	138.50	Matte Black	stream straightener kit
123807BLS	19.25	Black/Stainless Steel	stream straightener kit
123807SRS	17.20	Spot Resist Stainless	stream straightener, srs
124660SRS	65.70	Spot Resist Stainless	spout hub kit srs
124664CSL	175.95	Classic Stainless	wand kit, 7545 csl
124664ORB	187.90	Oil Rubbed Bronze	pull-out wand, orb
124664SL	170.80	Stainless	wand kit, 7545, sl
124738CSL	60.50	Classic Stainless	wand kit csl
124738SL	144.30	Stainless	wand kit stainless
124738W	131.20	Glacier	wand kit glacier
124823SL	112.45	Stainless	spout receptor sl
124823W	102.30	Glacier	spout receptor glc
125752BN	62.25	Brushed Nickel	grid drain cover bn
125754ORB	83.00	Oil Rubbed Bronze	handle kit, posi-temp
125756BN	155.20	Brushed Nickel	handle kit, widespread lav
125756ORB	170.60	Oil Rubbed Bronze	handle kit, widespread lav
12694BC	15.05	Brushed Chrome	lift rod lav mws/ws/1h/2h bc
12694BN	23.90	Brushed Nickel	chateau 1h lift rod bn
126964W	50.45	Glacier	dome service kit - glc
128865BN	39.10	Brushed Nickel	lift rod kit bn
128865ORB	43.20	Oil Rubbed Bronze	lift rod kit orb
128866BN	93.30	Brushed Nickel	hdl assy h/c bn
128866ORB	102.65	Oil Rubbed Bronze	hdl assy h/c orb
128867BN	95.30	Brushed Nickel	hdl assy, hot bn
128867ORB	105.00	Oil Rubbed Bronze	hdl assy, hot orb
128868BN	95.30	Brushed Nickel	hdl assy, cold bn
128868ORB	105.00	Oil Rubbed Bronze	hdl assy, cold orb
128870BN	85.90	Brushed Nickel	esct bn
128870ORB	94.50	Oil Rubbed Bronze	esct orb
128871BN	87.15	Brushed Nickel	hdl kit bn
128871ORB	95.95	Oil Rubbed Bronze	hdl kit orb
128873BN	55.20	Brushed Nickel	lift rod kit bn
128873ORB	60.70	Oil Rubbed Bronze	lift rod kit orb
128879BN	216.00	Brushed Nickel	spout kit bn
128880BN	113.60	Brushed Nickel	hdl assy bn
128883BN	279.40	Brushed Nickel	spt kit bn
128885BN	29.20	Brushed Nickel	lift rod kit bn
128886BN	371.50	Brushed Nickel	spout kit bn
130147BG	15.20	Brushed Gold	override screw kit bg
130147BN	15.20	Brushed Nickel	temperature override kit bn
130147NL	15.70	Polished Nickel	temperature override kit nl
130147ORB	16.80	Oil Rubbed Bronze	temperature override kit orb
130147WR	16.80	Wrought Iron	temperature override kit wr
130148BN	121.15	Brushed Nickel	escut assy t/s 1h dnpr brs bn
130148ORB	133.15	Oil Rubbed Bronze	escut assy t/s 1h dnpr brs orb
130149BN	189.95	Brushed Nickel	handle kit - volume control
130149ORB	208.95	Oil Rubbed Bronze	handle kit - volume control
130150BG	39.45	Brushed Gold	volume handle cap kit bg
130150BN	39.45	Brushed Nickel	handle cap
130150NL	40.90	Polished Nickel	handle cap nl
130150ORB	43.55	Oil Rubbed Bronze	handle cap
130150WR	43.55	Wrought Iron	handle cap
130151BN	191.95	Brushed Nickel	handle kit - thermostatic valve
130151NL	94.50	Polished Nickel	3/4" thermostatic hdl kit nl
130151ORB	211.20	Oil Rubbed Bronze	handle kit - thermostatic valve
130152BG	58.95	Brushed Gold	short ring escutcheon kit bg
130152BN	58.95	Brushed Nickel	short handle escutcheon

Moen Genuine Parts

Listed in numerical order

Part Number	List	Finish	Description	Part Number	List	Finish	Description
130152NL	49.35	Polished Nickel	hdl esct, short nl	134404BN	75.85	Brushed Nickel	bidet lift rod bn
130152ORB	64.80	Oil Rubbed Bronze	short handle escutcheon	134404ORB	75.85	Oil Rubbed Bronze	bidet lift rod orb
130152WR	64.80	Wrought Iron	short handle escutcheon	134413CSL	62.35	Classic Stainless	hdl esct kit csl
130965BG	67.90	Brushed Gold	handle kit bg	134413SL	63.20	Stainless	hdl esct kit sl
130965BL	23.55	Matte Black	handle hub bl	134418CSL	70.40	Classic Stainless	spt esct csl
130965NL	67.90	Polished Nickel	handle hub	134418SL	70.40	Stainless	spt esct sl
130965ORB	109.95	Oil Rubbed Bronze	handle hub orb	134742CSL	133.55	Classic Stainless	wand kit csl
130965SRS	67.90	Spot Resist Stainless	handle hub srs	134742ORB	140.25	Oil Rubbed Bronze	wand kit orb
130966BG	15.05	Brushed Gold	hinge cap bg	134742SL	133.55	Stainless	wand kit sl
130966BL	53.20	Matte Black	hinge pin cap bl	134742SRS	129.15	Spot Resist Stainless	wand kit srs 2.2gpm
130966BLS	39.35	Black/Stainless Steel	hinge pin cap bls	134938ORB	98.70	Oil Rubbed Bronze	vestige lever handle kit, orb
130966NL	62.35	Polished Nickel	hinge pin cap	135149BN	141.00	Brushed Nickel	3f escutcheon kit, neutral, bn
130966ORB	13.85	Oil Rubbed Bronze	hinge pin cap orb	135149NL	140.75	Polished Nickel	3f escutcheon kit, neutral, nl
130966SRS	15.05	Spot Resist Stainless	hinge pin cap srs	135149ORB	167.80	Oil Rubbed Bronze	3f escutcheon kit, neutral, orb
130968BG	61.80	Brushed Gold	escutcheon bg	135149WR	167.80	Wrought Iron	3f escutcheon kit, neutral, wr
130968BL	68.00	Matte Black	wall escutcheon bl	135150BN	55.95	Brushed Nickel	3f diverter lever kit, neutral, bn
130968NL	94.05	Polished Nickel	wall escutcheon	135150ORB	61.65	Oil Rubbed Bronze	3f diverter lever kit, neutral, orb
130968ORB	50.50	Oil Rubbed Bronze	wall escutcheon orb	135150WR	61.65	Wrought Iron	3f diverter lever kit, neutral, wr
130968SRS	61.80	Spot Resist Stainless	wall escutcheon srs	135151BG	16.15	Brushed Gold	stop tube kit w/o screw bg
130970BG	25.65	Brushed Gold	stream straightner bg	135151BL	17.60	Matte Black	stop tube w/o screw kit, bl
130970BL	140.80	Matte Black	aerator assembly bl	135151BN	16.15	Brushed Nickel	stop tube w/o screw kit, bn
130970NL	53.25	Polished Nickel	aerator assembly	135151WR	17.60	Wrought Iron	stop tube w/o screw kit, wr
130970ORB	28.05	Oil Rubbed Bronze	stream straightener orb	136103C	46.00	Chrome	spray head & hose assy chr
130970SRS	25.65	Spot Resist Stainless	stream straightener srs	136103ORB	106.65	Oil Rubbed Bronze	hs kd, female orb
130976CSL	26.85	Classic Stainless	hndl cap kit chr, 1h kd csl	136103SL	63.65	Stainless	spray head & hose assy sl
130976SL	26.85	Stainless	hndl cap kit sl, 1h kd p-os	136103SLP	63.65	Brushed Platinum	spray head & hose assy slp
130998BN	228.10	Brushed Nickel	low arc spout kit bn	136103V	46.00	Ivory	spray head & hose assy ivy
131097BN	108.10	Brushed Nickel	hdl kit - hot bn	136103W	46.00	Glacier	spray head & hose assy glc
131097ORB	118.90	Oil Rubbed Bronze	hdl kit - hot orb	136104CSL	152.75	Classic Stainless	wthl ss hd, hose & hose guide csl
131098BN	108.10	Brushed Nickel	hdl kit - cold bn	136104ORB	168.00	Oil Rubbed Bronze	wthl ss hd, hose & hose guide orb
131098ORB	118.90	Oil Rubbed Bronze	hdl kit - cold orb	136104SRS	259.05	Spot Resist Stainless	sidespray and hose srs
131099BN	10.30	Brushed Nickel	hdl cap bn	136104WR	168.00	Wrought Iron	side spray, hose & hose guide wr
131099ORB	11.40	Oil Rubbed Bronze	hdl cap orb	136106CSL	92.10	Classic Stainless	hose & spray csl
131100BN	28.60	Brushed Nickel	lift rod bn	136106ORB	111.35	Oil Rubbed Bronze	hose & spray orb
131100NL	63.65	Polished Nickel	lift rod kit nl	136106SL	92.10	Stainless	hose & spray sl
131100ORB	31.45	Oil Rubbed Bronze	lift rod orb	136106SRS	92.10	Spot Resist Stainless	side spray srs
131101BN	124.60	Brushed Nickel	hdl kit - hot or cold bn	136197BN	19.50	Brushed Nickel	3f plug button and screw kit, bn
131101ORB	136.95	Oil Rubbed Bronze	hdl kit - hot or cold orb	136197NL	11.25	Polished Nickel	3f plug button and screw kit nl
131107BN	35.60	Brushed Nickel	lift rod kit bn	136197ORB	21.25	Oil Rubbed Bronze	3f plug button and screw kit, orb
131107ORB	39.05	Oil Rubbed Bronze	lift rod kit orb	136197WR	21.25	Wrought Iron	3f plug button and screw kit wr
131109BN	96.75	Brushed Nickel	shr hdl kit bn	136640BN	75.65	Brushed Nickel	hdl kgsy 3f kit, bn
131109ORB	106.35	Oil Rubbed Bronze	shr hdl kit orb	136640ORB	83.30	Oil Rubbed Bronze	hdl kgsy 3f kit, orb
131191BG	227.45	Brushed Gold	volume handle kit bg	136829BL	63.40	Matte Black	wand exta 1h kd p-os, bl
131191BN	227.45	Brushed Nickel	volume cntrl hdl kit wthl bn	136829SL	79.80	Stainless	wand exta 1h kd p-os, sl
131191NL	227.45	Polished Nickel	volume cntrl hdl kit wthl nl	136829V	63.40	Ivory	wand exta 1h kd p-os, v
131191ORB	250.10	Oil Rubbed Bronze	volume cntrl hdl kit wthl orb	136829WG	63.40	Glacier	wand exta 1h kd p-os, wg
131191WR	250.10	Wrought Iron	volume cntrl hdl kit wthl wr	137034BG	35.15	Brushed Gold	slider for slidebar bg
131195BG	229.30	Brushed Gold	thermostatic handle kit bg	137034BN	66.15	Brushed Nickel	slider for slidebar, bn
131195BN	229.30	Brushed Nickel	thermostatic hdl kit wthl bn	137034BRB	38.00	Mediterranean Bronze	slider for slidebar brb
131195NL	229.30	Polished Nickel	thermostatic hdl kit wthl nl	137034NL	66.15	Polished Nickel	slider for slidebar nl
131195ORB	252.25	Oil Rubbed Bronze	thermostatic hdl kit wthl orb	137034ORB	72.75	Oil Rubbed Bronze	slider for slidebar, orb
131195WR	252.25	Wrought Iron	thermostatic hdl kit wthl wr	137034SRN	35.15	Spot Resist Brushed Nickel	slider for slidebar srn
131380BL	34.30	Matte Black	pulldown wand bl	137034WR	72.75	Wrought Iron	slider for slidebar, wr
131380CSL	44.35	Classic Stainless	pulldown wand csl	137388BN	117.10	Brushed Nickel	ws handle kit, hot or cold, bn
131380ORB	70.75	Oil Rubbed Bronze	pulldown wand orb	137388ORB	128.80	Oil Rubbed Bronze	ws handle kit, hot or cold, orb
131380SL	64.15	Stainless	pulldown wand sl	137390BN	262.50	Brushed Nickel	ws spt kit, bn
131380SRS	44.50	Spot Resist Stainless	pulldown wand srs	137391BN	348.30	Brushed Nickel	rt spt kit, bn
132320BG	42.65	Brushed Gold	thermostatic handle cap bg	137392BN	359.80	Brushed Nickel	roman tub diverter spout, bn
132320BN	42.65	Brushed Nickel	tstat hdl cap, service kit, bn	137393BN	38.25	Brushed Nickel	roman tub lift rod, bn
132320ORB	46.95	Oil Rubbed Bronze	tstat hdl cap, service kit, orb	137394BN	109.20	Brushed Nickel	esct posi 1h ts, bn
132448BG	22.65	Brushed Gold	adjustable temperature limit stop bg	137395BN	118.05	Brushed Nickel	esct mnt 1h ts, bn
133022BN	20.90	Brushed Nickel	ws lift rod assy kit bn	137395ORB	129.85	Oil Rubbed Bronze	esct mnt 1h ts, orb
133025BN	69.10	Brushed Nickel	tub spout assy kit bn	137396BN	82.45	Brushed Nickel	hdl lr 1h ts, bn
134402BN	141.85	Brushed Nickel	handle kit bn				

Moen Genuine Parts

Listed in numerical order

Part Number	List	Finish	Description
137396ORB	90.70	Oil Rubbed Bronze	hdlr 1hts, orb
137511BN	24.85	Brushed Nickel	hdl service kit bn
137516BN	25.85	Brushed Nickel	esct service kit(6100bn) bn
137532BG	30.70	Brushed Gold	escutcheon bg
137532BL	33.75	Matte Black	escutcheon kit, bl
137532BN	30.70	Brushed Nickel	esct (t914bn) bn
137534BN	32.05	Brushed Nickel	spt cap assy bn
137537BN	25.20	Brushed Nickel	hdl service kit bn
140028CSL	35.95	Classic Stainless	hose & spray csl
140028ORB	46.10	Oil Rubbed Bronze	hose & spray orb
140245SRS	67.20	Spot Resist Stainless	wand kit srs
140379CSL	125.90	Classic Stainless	wand clnd kd 1h p-os csl
140392BL	82.10	Matte Black	wand slra kd 1h p-os bl
140392CSL	82.10	Classic Stainless	wand slra kd 1h p-os csl
140392S	82.10	Sand/Almond/Bone	wand slra kd 1h p-os snd
140392SL	103.80	Stainless	wand slra kd 1h p-os sl
140392V	82.10	Ivory	wand slra kd 1h p-os ivy
140392W	82.10	Glacier	wand slra kd 1h p-os glc
140995CSL	84.10	Classic Stainless	wand kit csl
140996CSL	43.90	Classic Stainless	lever handle kit csl
140997CSL	19.85	Classic Stainless	dome kit csl
140997ORB	28.65	Oil Rubbed Bronze	dome kit orb
141002CSL	71.70	Classic Stainless	esct kit csl
141007BL	20.75	Matte Black	hose guide kit, bl
141007SRS	21.75	Spot Resist Stainless	hose guide
141008CSL	27.35	Classic Stainless	aerator and retainer kit csl
141044ORB	183.80	Oil Rubbed Bronze	wand & hose kit orb
141044SL	173.00	Stainless	wand & hose kit sl
141044W	183.80	Glacier/Chrome	wand & hose kit glc
1411BG	29.65	Brushed Gold	escutcheon bg
1411BN	29.65	Brushed Nickel	esct universal hhh dkmt bn
1411NL	39.40	Polished Nickel	esct universal hhh dkmt nl
1411ORB	39.40	Oil Rubbed Bronze	esct universal hhh dkmt orb
1411WR	39.40	Wrought Iron	esct universal hhh dkmt wr
141797CSL	66.20	Classic Stainless	dome kit, csl
141797SRS	27.65	Spot Resist Stainless	dome kit srs
141798BL	95.90	Matte Black	roman tub elbow, bl
141798BN	87.15	Brushed Nickel	roman tub elbow, bn
1417BG	87.15	Brushed Gold	shr elbow hhh dkmt bg
1417BN	87.15	Brushed Nickel	intl shr elbow hhh dkmt bn
1417NL	126.15	Polished Nickel	intl shr elbow hhh dkmt nl
1417ORB	95.95	Oil Rubbed Bronze	intl shr elbow hhh dkmt orb
1417WR	95.95	Wrought Iron	intl shr elbow hhh dkmt wr
143321BN	41.15	Brushed Nickel	handle kit bn brntfrd
143321ORB	51.75	Oil Rubbed Bronze	handle kit orb brntfrd
143322BN	41.35	Brushed Nickel	handle kit bn eva
143322ORB	46.55	Oil Rubbed Bronze	handle kit orb eva
143323BN	45.60	Brushed Nickel	3h esc bn brntfrd
143323ORB	50.10	Oil Rubbed Bronze	3h esc orb brntfrd
143324BN	42.65	Brushed Nickel	3h esc bn eva
143324ORB	46.95	Oil Rubbed Bronze	3h esc orb eva
144450BL	6.85	Matte Black	lever handle kit, cold, bl
144451BL	28.95	Matte Black	lever handle kit, hot, bl
144454BL	40.65	Matte Black	escutcheon kit, bl
145130BL	27.85	Matte Black	aerator kit, bl
146211BL	21.10	Matte Black	dome bl
146211W	21.10	Glacier	dome glc
146214ORB	61.00	Oil Rubbed Bronze	handle kit orb
146214SRS	55.55	Spot Resist Stainless	handle kit srs
146217W	21.75	Glacier	dome glc
146220CSL	61.00	Classic Stainless	handle kit csl
146220SRS	61.00	Spot Resist Stainless	handle kit srs
146221SRS	123.60	Spot Resist Stainless	receptor kit srs
146670BG	14.90	Brushed Gold	plug button bg

Part Number	List	Finish	Description
146670BN	15.20	Brushed Nickel	slidebar esc cap bn
146670NL	31.45	Polished Nickel	slidebar esc cap, nl
146670ORB	16.75	Oil Rubbed Bronze	slidebar esc cap orb
146670WR	17.80	Wrought Iron	slidebar esc cap wr
146781SRS	41.25	Spot Resist Stainless	1h handle kit srs
146783SRS	15.00	Spot Resist Stainless	1h handle dome kit srs
146784SRS	292.35	Spot Resist Stainless	spout kit srs
146786BC	88.90	Brushed Chrome	1h kitchen spout chateau bc
146786SRS	86.20	Spot Resist Stainless	1h spout kit srs
146851SRS	63.95	Spot Resist Stainless	handle kit srs
14732CBN	34.90	Classic Brushed Nickel	lr mtl kit cht posi ts cbn
147539SRS	57.30	Spot Resist Stainless	escutcheon kit srs
147540SRS	18.80	Spot Resist Stainless	set screw kit srs
147541CSL	60.00	Classic Stainless	handle hub csl
147541SRS	58.05	Spot Resist Stainless	handle hub srs
147542BN	37.10	Brushed Nickel	handle lever bn
147542SRS	37.45	Spot Resist Stainless	handle kit srs
147543SRS	362.35	Spot Resist Stainless	spout kit srs
147546CSL	107.25	Classic Stainless	wand csl
147549BN	27.30	Brushed Nickel	lav esct bn
147550BN	28.65	Brushed Nickel	lift rod bn
147552BN	57.40	Brushed Nickel	hdl hub bn
147554BN	16.80	Brushed Nickel	slot plug bn
147555BN	69.25	Brushed Nickel	vessel ext 5" bn
147557BN	59.85	Brushed Nickel	hdl assy bn
147558BL	15.65	Matte Black	hardware pack, matte black
147562BN	17.75	Brushed Nickel	spt esct bn
147563BN	19.70	Brushed Nickel	hdl esct bn
147564BN	43.45	Brushed Nickel	lift rod bn
147565BN	571.75	Brushed Nickel	rt spt bn
147566BN	54.20	Brushed Nickel	spt esct bn
147567BN	101.00	Brushed Nickel	hh esct bn
147568BN	630.35	Brushed Nickel	rt spt bn
147569BN	74.25	Brushed Nickel	lift rod bn
147573BN	53.95	Brushed Nickel	hdl kit bn
147574BN	106.25	Brushed Nickel	esct bn
147576BN	111.40	Brushed Nickel	esct bn
148479BG	62.00	Brushed Gold	1" handle extension kit bg
148479BL	62.40	Matte Black	3f dvtr vlv 1" ext kit bl
148479BN	62.00	Brushed Nickel	3f dvtr vlv 1" ext kit bn
148479WR	62.40	Wrought Iron	3f dvtr vlv 1" ext kit wr
148480BN	41.40	Chrome	3f dvtr vlv escut bn
148480ORB	45.60	Oil Rubbed Bronze	3f dvtr vlv escut orb
148820BL	48.65	Matte Black	hdl kit bl
148820CSL	43.30	Classic Stainless	handle kit kd pulldown, csl
148820ORB	47.90	Oil Rubbed Bronze	handle kit kd pulldown orb
148820SRS	43.30	Spot Resist Stainless	handle kit kd pulldown srs
149111BN	49.30	Brushed Nickel	1h lav handle kit bn
149112BN	27.50	Brushed Nickel	1 handle lav lift rod bn
149113BN	78.30	Brushed Nickel	2h lav handle kit bn
149114BN	353.60	Brushed Nickel	spt, ws bn
149115BN	24.05	Brushed Nickel	lift rod, ws bn
149116BN	456.80	Brushed Nickel	3hole rt spt bn
149118BN	486.55	Brushed Nickel	4h rt spt bn
149119BN	32.65	Brushed Nickel	lift rod, rt bn
149122BN	54.45	Brushed Nickel	posi shr hdl bn
14913BN	23.40	Brushed Nickel	strm-f assy male bn
14913BRB	16.45	Mediterranean Bronze	strm-f assy trad male orb
14913ORB	25.85	Oil Rubbed Bronze	strm-f assy trad male orb
149570BG	84.10	Brushed Gold	handle lever & o-ring bg
149570BL	227.10	Matte Black	handle lever kit, bl
149570BLS	55.30	Black/Stainless Steel	handle lever kit, bls
149570SRS	84.10	Spot Resist Stainless	handle lever kit srs
149571BG	81.30	Brushed Gold	escutcheon bg

Part Number	List	Finish	Description
149571BL	33.45	Matte Black	escutcheon,bl
149571BLS	62.75	Black/Stainless Steel	escutcheon,bls
149571SRS	81.30	Spot Resist Stainless	escutcheon srs
149748BG	31.60	Brushed Gold	plug button kit bg
149748BN	23.60	Brushed Nickel	plug btn kit bn
149748BRB	34.85	Mediterranean Bronze	plug button kit brb
149748NL	34.40	Polished Nickel	plug button kit, nl
149748ORB	34.85	Oil Rubbed Bronze	plug button kit orb
149748SRN	31.60	Spot Resist Brushed Nickel	plug button kit srn
150288SRS	297.60	Spot Resist Stainless	spout kit srs
150568BL	33.15	Matte Black	escutcheon bl
150568BN	30.15	Brushed Nickel	escutcheon bn
150625BC	35.75	Brushed Chrome	lvr hdl bc
150628BC	10.85	Brushed Chrome	dome bc
150662ORB	52.30	Oil Rubbed Bronze	handle kit orb
150662SRS	43.80	Spot Resist Stainless	handle kit, srs
150663ORB	97.55	Oil Rubbed Bronze	esc bar/kd 1 hndl ring orb
150663SRS	81.65	Spot Resist Stainless	esc bar/kd 1 hndl ring srs
150664CSL	55.85	Classic Stainless	hdl kit, 1h kd csl
150664ORB	61.45	Oil Rubbed Bronze	hdl kit, 1h kd orb
150665ORB	73.80	Oil Rubbed Bronze	handle kit, 1 handle bar orb
150665SRS	67.10	Spot Resist Stainless	handle kit srs
150666ORB	28.20	Oil Rubbed Bronze	dome, 1 handle kitchen orb
150666SRS	15.65	Spot Resist Stainless	dome srs
150667ORB	73.80	Oil Rubbed Bronze	esc bar/kd 1 hndl ring orb
150667SRS	67.10	Spot Resist Stainless	handle escutcheon srs
151018CSL	36.00	Classic Stainless	waste assembly kit
151189BL	64.25	Matte Black	pulldown bar wand bl
151189ORB	53.70	Oil Rubbed Bronze	wand kit bar/prep orb
1512BC	12.25	Brushed Chrome	plug button ws rdmtf bc
1512BG	14.75	Brushed Gold	plug button bg
1512BN	14.75	Brushed Nickel	plug btn ws rdmtf bn
1512NL	16.25	Polished Nickel	plug btn ws rdmtf nl
1512ORB	16.25	Oil Rubbed Bronze	plug button ws rdmtf orb
1512WR	16.25	Wrought Iron	plug btn ws rdmtf wr
151813BN	36.00	Brushed Nickel	3 hole lav esc bn
152027SRN	93.60	Spot Resist Brushed Nickel	tub spout kit srn
152859BG	6.55	Brushed Gold	plug button kit bg
152859BL	7.05	Black	1255 plug button bl
152859BLS	7.85	Black/Stainless Steel	plug button bls
152859CSL	7.05	Classic Stainless	1255 plug button csl
152859NL	7.05	Polished Nickel	1255 plug button nl
152859ORB	7.05	Oil Rubbed Bronze	1255 plug button orb
152859W	5.75	Glacier	1255 plug button glc
153641ORB	97.55	Oil Rubbed Bronze	hndl dome wthl 1h kd/bar orb
153641SRS	81.65	Spot Resist Stainless	hndl dome wthl 1h kd/barsrs
153977CSL	66.65	Classic Stainless	pulldown wand csl
153977ORB	103.05	Oil Rubbed Bronze	pulldown wand orb
153978ORB	58.15	Oil Rubbed Bronze	handle kit kd pulldown orb
153978SRS	44.35	Spot Resist Stainless	handle kit, srs
154286BG	311.20	Brushed Gold	spout kit bg
154286BL	391.95	Matte Black	ws lav spout kit, bl
154286BN	311.20	Brushed Nickel	weymouth ws lav spt kit
154286NL	342.45	Polished Nickel	ws lav spt kit nl
154286ORB	342.45	Oil Rubbed Bronze	weymouth ws lav spt kit
154287BG	31.50	Brushed Gold	lift rod kit bg
154287BL	86.55	Matte Black	ws lift rod kit, bl
154287BN	31.50	Brushed Nickel	weymouth ws lift rod kit
154287NL	34.75	Polished Nickel	ws lift rod kit nl
154287ORB	34.75	Oil Rubbed Bronze	weymouth ws lift rod kit
154288BG	39.35	Brushed Gold	aerator kit bg
154288BL	28.45	Matte Black	aerator shell and insert bl
154288ORB	42.10	Oil Rubbed Bronze	weymouth lav aer shell & insert
154288SRS	39.35	Spot Resist Stainless	aerator shell and insert srs

Part Number	List	Finish	Description
154290BG	381.10	Brushed Gold	spout kit bg
154290BL	404.70	Matte Black	weymouth 3h rt spout kit, bl
154290BN	381.10	Brushed Nickel	weymouth 3h rt spt
154290NL	404.70	Polished Nickel	3h rt spt nl
154290ORB	404.70	Oil Rubbed Bronze	weymouth 3h rt spt
154291BG	414.40	Brushed Gold	spout kit bg
154291BL	430.85	Matte Black	4h roman tub spout kit, bl
154291BN	414.40	Brushed Nickel	weymouth 4h rt spt
154291NL	430.85	Polished Nickel	4h rt spt nl
154291ORB	430.85	Oil Rubbed Bronze	weymouth 4h rt spt
154292BG	25.60	Brushed Gold	lift rod bg
154292BL	64.40	Matte Black	4h roman tub lift rod kit, bl
154292BN	25.60	Brushed Nickel	weymouth 4h rt lift rod kit
154292NL	28.15	Polished Nickel	4h rt lift rod kit nl
154292ORB	28.15	Oil Rubbed Bronze	weymouth 4h rt lift rod kit
154293BG	662.00	Brushed Gold	spout kit bg
154293BL	700.85	Matte Black	wallmount spout kit, bl
154293BN	662.00	Brushed Nickel	weymouth wlmnt lav spt kit
154293NL	700.85	Polished Nickel	wlmnt lav spt nl
154293ORB	700.85	Oil Rubbed Bronze	weymouth wlmnt lav spt kit
154294BG	43.30	Brushed Gold	handle lever, screw & plug button bg
154294BL	45.95	Matte Black	weymouth 1h hdl kit, bl
154294BN	43.30	Brushed Nickel	weymouth 1h lav hdl kit
154294NL	45.95	Polished Nickel	1h lav hdl kit nl
154294ORB	45.95	Oil Rubbed Bronze	weymouth 1h lav hdl kit
154294SRS	43.30	Spot Resist Stainless	weymouth 1h hdl kit
154295BG	61.00	Brushed Gold	stream straightener bg
154295BL	67.10	Matte Black	weymouth rt aer shell, bl
154295BN	61.00	Brushed Nickel	weymouth rt aer shell & insrt
154295NL	67.10	Polished Nickel	rt aer shell & insert nl
154295ORB	67.10	Oil Rubbed Bronze	weymouth rt aer shell & insrt
154297BG	16.35	Brushed Gold	trad slide bar end cap bg
154297BN	16.70	Brushed Nickel	trad slide bar end cap bn
154297NL	18.35	Polished Nickel	trad slide bar end cap nl
154297ORB	18.35	Oil Rubbed Bronze	trad slide bar end cap orb
154298BG	27.60	Brushed Gold	handle insert kit bg
154298BL	30.35	Matte Black	weymouth extmp hdl, bl
154298BN	27.60	Brushed Nickel	weymouth extmp hdl insrt bn
154298NL	27.60	Polished Nickel	ex-tmp hdl insrt nl
154298ORB	30.35	Oil Rubbed Bronze	weymouth extmp hdl insrt orb
154299BG	107.45	Brushed Gold	escutcheon kit bg
154299BL	207.05	Matte Black	escutcheon kit, bl
154299BN	107.45	Brushed Nickel	weymouth extmp escrt kit bn
154299NL	118.20	Polished Nickel	ex-tmp escrt kit nl
154299ORB	118.20	Oil Rubbed Bronze	weymouth extmp escrt kit orb
154302BG	67.60	Brushed Gold	handle hub & screw kit bg
154302BN	67.60	Brushed Nickel	weymouth posi hdl kit bn
154302ORB	70.25	Oil Rubbed Bronze	weymouth posi hdl kit orb
154306BG	24.80	Brushed Gold	diverter plug kit bg
154306BL	45.40	Matte Black	diverter plug kit, bl
154306BN	24.80	Brushed Nickel	diverter plug kit bn
154306NL	27.40	Polished Nickel	diverter plug kit nl
154306ORB	27.40	Oil Rubbed Bronze	diverter plug kit orb
155649BN	73.90	Brushed Nickel	square escutcheon ring w/ gasket bn
155649NL	73.90	Polished Nickel	square escutcheon ring w/ gasket nl
155649ORB	81.30	Oil Rubbed Bronze	square escutcheon ring w/ gasket orb
155650BG	65.95	Brushed Gold	round escutcheon ring w/ gasket bg
155650BL	179.90	Matte Black	round escutcheon ring, bl
155650BN	65.95	Brushed Nickel	round escutcheon ring w/ gasket bn
155650NL	65.95	Polished Nickel	round escutcheon ring w/ gasket nl

GENUINE PARTS

Moen Genuine Parts

Listed in numerical order

Part Number	List	Finish	Description
155650ORB	72.55	Oil Rubbed Bronze	round escutcheon ring w/ gasket orb
155748BG	49.60	Chrome	59" handshower hose bg
156270SRS	75.85	Spot Resist Stainless	1h spout kit srs
157131BC	60.70	Brushed Chrome	escr posi-temp bc
157276BG	70.70	Brushed Gold	hand shower (1.75 gpm) bg
157328BL	65.40	Matte Black	escutcheon kit bl
157328ORB	65.40	Oil Rubbed Bronze	kitchen deck plate orb
157328SRS	59.40	Spot Resist Stainless	escutcheon & gasket kit srs
158080BN	20.75	Brushed Nickel	90 degree wlmnt spt escr bn
158198SRS	89.65	Spot Resist Stainless	reflex spout srvc kt, srs
158493BN	34.00	Brushed Nickel	fina 1h hc handle bn
158532ORB	14.45	Oil Rubbed Bronze	handle dome kit orb
159014BN	63.60	Brushed Nickel	escutcheon kit icon bn
159018BN	117.10	Brushed Nickel	thermostatic hdl kit rothbury bn
159019BN	113.15	Brushed Nickel	thermostatic hdl kit 90 degree bn
159020BN	118.65	Brushed Nickel	volume hdl kit icon bn
159023BN	98.70	Brushed Nickel	escr kit 90 degree bn
159024BN	116.50	Brushed Nickel	thermostatic hdl kit icon bn
159028BN	115.15	Brushed Nickel	volume hdl kit 90 degree bn
159029BN	119.15	Brushed Nickel	volume hdl kit rothbury bn
159029ORB	127.55	Oil Rubbed Bronze	volume hdl kit rothbury orb
159107BN	61.85	Brushed Nickel	hdl, mtlc ws 2h hdl lav & bdt bn
159264BN	51.85	Brushed Nickel	3f dvtr vlv escut, bn
159266BN	62.80	Brushed Nickel	3f dvtr lever kit, bn
159561BL	64.10	Matte Black	wand kit bl
159561SRS	75.95	Spot Resist Stainless	wand kit srs
160660BG	15.20	Brushed Gold	handle dome kit, bg
160660BL	17.75	Matte Black	handle dome kit bl
160660BLS	18.50	Black/Stainless Steel	dome bls
160660BN	9.40	Brushed Nickel	handle dome, kit, bn
160660BRB	34.70	N/A	dome kit
160660NL	15.50	Polished Nickel	handle dome kit nl
160660ORB	10.20	Oil Rubbed Bronze	handle dome, kit, orb
160660SRS	18.30	Spot Resist Stainless	dome srs
160997SRS	35.00	Spot Resist Stainless	aerator kit 2.0 gpm
160998SRS	62.10	Spot Resist Stainless	wand kit 1.5 gpm
161143SRS	68.75	Spot Resist Stainless	wand exta 1h kd p-os, bl 1.5gpm
161143V	48.40	Ivory	wand exta 1h kd p-os, chr 1.5gpm ivy
161143WG	63.40	Glacier	wand exta 1h kd p-os, wg 1.5gpm
161144SRS	87.15	Spot Resist Stainless	wand kit 1.5gpm srs
161147ORB	187.90	Oil Rubbed Bronze	wand kit, 7545, orb 1.5gpm
161148CSL	84.10	Classic Stainless	wand kit csl 1.5gpm
161149CSL	115.85	Classic Stainless	wand kit csl 1.5gpm
161149ORB	140.25	Oil Rubbed Bronze	wand kit orb 1.5gpm
161149SRS	129.15	Spot Resist Stainless	wand kit srs 1.5gpm
161150BL	97.50	Black	pulldown wand 1.5gpm bl
161150CSL	119.65	Chrome	pulldown wand csl 1.5gpm
161150ORB	122.95	Chrome	pulldown wand orb 1.5gpm
161152SRS	135.85	Spot Resist Stainless	wand kit srs 1.5gpm
161154SRS	143.90	Spot Resist Stainless	wand kit srs 1.5gpm
161156ORB	79.40	Oil Rubbed Bronze	wand kit bar/prep orb 1.5gpm
161156SRS	76.00	Spot Resist Stainless	wand kit 1.5gpm srs
161157ORB	103.05	Oil Rubbed Bronze	pulldown wand orb 1.5gpm
161157SRS	66.65	Spot Resist Stainless	wand kit 1.5gpm srs
161909BG	46.45	Brushed Gold	handle kit bg
161909BN	46.45	Brushed Nickel	1h 1h handle kit bn
161909NL	72.35	Polished Nickel	1h 1h handle kit, nl
161909ORB	52.40	Oil Rubbed Bronze	1h 1h handle kit orb
161917BG	22.10	Brushed Gold	lift rod bg
161917BN	22.10	Brushed Nickel	1h 1h lift rod bn
161917NL	22.45	Polished Nickel	1h lav lift rod nl
161917ORB	22.45	Oil Rubbed Bronze	1h 1h lift rod orb
161919BL	148.55	Matte Black	deck plate kit 1hcs bl

Part Number	List	Finish	Description
161919ORB	47.80	Oil Rubbed Bronze	1h 1h deck plate orb
161942BG	97.55	Brushed Gold	widespread handle kit bg
161942BN	97.55	Brushed Nickel	widespread handle kit bn
161942NL	97.55	Polished Nickel	widespread handle kit, nl
161942ORB	111.30	Oil Rubbed Bronze	widespread handle kit orb
161944BG	220.65	Brushed Gold	widespread spout kit bg
161944BN	220.65	Brushed Nickel	widespread spout kit bn
161944NL	220.65	Polished Nickel	widespread spout kit, nl
161944ORB	252.85	Oil Rubbed Bronze	widespread spout kit orb
161945BN	59.05	Brushed Nickel	centerset handle kit bn
161945ORB	78.90	Oil Rubbed Bronze	centerset handle kit orb
161947BG	480.75	Brushed Gold	spout kit bg
161947BN	480.75	Brushed Nickel	non diverting rt spout bn
161947NL	480.75	Polished Nickel	non-diverting rt spout, nl
161947ORB	454.45	Oil Rubbed Bronze	non diverting rt spout orb
161949BG	508.35	Brushed Gold	roman tub spout bg
161949BN	508.35	Brushed Nickel	diverting rt spout bn
161949NL	508.35	Polished Nickel	diverting rt spout, nl
161949ORB	489.90	Oil Rubbed Bronze	diverting rt spout orb
161950BG	23.45	Brushed Gold	diverter lift rod bg
161950BN	23.45	Brushed Nickel	roman tub lift rod bn
161950NL	23.45	Polished Nickel	roman tub lift rod, nl
161950ORB	24.30	Oil Rubbed Bronze	roman tub lift rod orb
161952BG	101.35	Brushed Gold	escutcheon bg
161952BN	101.35	Brushed Nickel	posi showering escutcheon bn
161952NL	101.35	Polished Nickel	posi showering escr, nl
161952ORB	79.45	Oil Rubbed Bronze	posi showering escutcheon orb
161953BG	87.10	Brushed Gold	escutcheon bg
161953BN	87.10	Brushed Nickel	moentrol showering escutcheon bn
161953NL	87.10	Polished Nickel	moentrol escr, nl
161953ORB	60.30	Oil Rubbed Bronze	moentrol showering escutcheon orb
161954BG	59.05	Brushed Gold	handle kit bg
161954BN	67.85	Brushed Nickel	showering handle bn
161954NL	67.85	Polished Nickel	showering handle, nl
161954ORB	73.40	Oil Rubbed Bronze	showering handle orb
162BN	163.00	Brushed Nickel	escutcheon extension bn
162ORB	179.35	Oil Rubbed Bronze	escutcheon extension orb
163053BG	287.20	Brushed Gold	wallmount spout kit bg
163053BN	287.20	Brushed Nickel	wallmount spout kit, bn
163053NL	287.20	Polished Nickel	wallmount spout kit, nl
163053ORB	333.60	Oil Rubbed Bronze	wallmount spout kit, orb
163138BN	59.05	Brushed Nickel	handle kit cold bn
163153BG	41.45	Brushed Gold	escutcheon bg
163153BN	41.45	Brushed Nickel	transfer valve escutcheon bn
163153NL	41.45	Polished Nickel	transfer valve escr, nl
163153ORB	50.10	Oil Rubbed Bronze	transfer valve escutcheon orb
163153SRN	49.60	Spot Resist Brushed Nickel	diverter valve escutcheon srn
163244SRS	81.95	Spot Resist Stainless	wand kit srs 1.5gpm
163245SRS	249.60	Spot Resist Stainless	spout kit srs
163246CSL	82.20	Classic Stainless	1.5 gpm wand kkit csl
163248CSL	82.70	Classic Stainless	1.5 gpm wand kit csl
163248ORB	146.50	Oil Rubbed Bronze	1.5 gpm wand kit orb
163248SRS	82.70	Spot Resist Stainless	pull out wand 1.5gpm srs
163248W	63.40	Glacier	1.5 gpm wand kit glc
163249ORB	126.90	Oil Rubbed Bronze	receptor kit orb
163792BG	7.10	Brushed Gold	cap
163792BL	7.10	Matte Black	cap
163792BN	7.10	Brushed Nickel	cap, bn
163792ORB	7.95	Oil Rubbed Bronze	cap, orb
163866BRB	28.35	Mediterranean Bronze	lift rod kit brb
163949BN	4.95	Brushed Nickel	rubber lift rod plug button warm grey
163949ORB	5.25	Oil Rubbed Bronze	rubber lift rod plug button brown
163BG	18.10	Brushed Gold	escutcheon screws (2) bg

Moen Genuine Parts

Listed in numerical order

Part Number	List	Finish	Description
163BL	19.90	Matte Black	escut screw lgd/mnt/cht ts bl
163BN	18.10	Brushed Nickel	escut screw lgd/mnt/cht ts bn
163WR	19.90	Wrought Iron	escr scrw lgd/mnt/cht ts wr
164486BG	19.70	Brushed Gold	side spray bg
164486BL	111.65	Matte Black	sidespray bl
164486NL	33.20	Polished Nickel	sidespray nl
164486ORB	69.15	Oil Rubbed Bronze	sidespray orb
164486SRS	19.70	Spot Resist Stainless	sidespray srs
164487BG	40.85	Brushed Gold	handle kit bg
164487BL	33.65	Matte Black	weymouth kitchen handle kit bl
164487NL	40.40	Polished Nickel	weymouth kitchen handle kit nl
164487ORB	47.55	Oil Rubbed Bronze	weymouth kitchen handle kit orb
164487SRS	40.85	Spot Resist Stainless	weymouth kitchen handle kit srs
164488BG	51.75	Brushed Gold	aerator kit bg
164488NL	51.75	Polished Nickel	aerator shell and insert nl
164488ORB	58.95	Oil Rubbed Bronze	aerator shell and insert orb
164488SRS	51.75	Spot Resist Stainless	aerator shell and insert srs
164927BL	144.60	Matte Black	handshower kit
165003BG	34.00	Brushed Gold	lift rod bg
165003BL	46.90	Matte Black	1h lav lift rod kit bl
165193BL	106.65	Matte Black	widespread handle kit bl
165193BN	74.05	Brushed Nickel	widespread handle kit bn
165903BL	40.60	Matte Black	1h1h handle kit, bl
165903BN	36.90	Brushed Nickel	1h1h handle kit bn
165904BL	44.50	Matte Black	1h1h handle dome kit bl
165904BN	40.55	Brushed Nickel	1h1h handle dome kit bn
165905BL	91.15	Matte Black	arris lever handle kit bl
165905BN	82.75	Brushed Nickel	lavatory handle kit bn
165906BL	438.10	Matte Black	widespread spout kit bl
165906BN	398.20	Brushed Nickel	widespread spout kit bn
165908BL	420.35	Matte Black	roman tub non-diverting spout, bl
165908BN	382.10	Brushed Nickel	roman tub non-diverting tub spout bn
165909BL	591.75	Matte Black	roman tub diverting spout, bl
165909BN	537.95	Brushed Nickel	roman tub diverting tub spout bn
165910BL	95.55	Matte Black	roman tub lift rod, bl
165910BN	86.90	Brushed Nickel	roman tub lift rod bn
165913BN	56.65	Brushed Nickel	posi-temp shower handle kit bn
165916BL	124.70	Matte Black	thermostatic handle kit bl
165916BN	113.35	Brushed Nickel	thermostatic handle kit bn
165917BL	123.85	Matte Black	volume control handle kit bl
165917BN	112.60	Brushed Nickel	volume control handle kit bn
165998BG	40.70	Brushed Gold	spout cap bg
165998BL	33.55	Matte Black	weymouth kitchen spout cap bl
165998NL	25.60	Polished Nickel	weymouth kitchen spout finial
165998ORB	40.70	Oil Rubbed Bronze	weymouth kitchen spout finial
165998SRS	40.70	Spot Resist Stainless	weymouth kitchen spout finial
166614BL	64.45	Matte Black	spout kit, bl
168492BG	156.60	Brushed Gold	wand kit bg
168492BL	156.60	Matte Black	wand kit bl
168492BLS	172.25	Black/Stainless Steel	wand kit bls
168492SRS	156.60	Spot Resist Stainless	wand kit srs
168493BG	174.70	Brushed Gold	spout kit bg
168493BL	173.40	Matte Black	spout kit bl
168493BLS	192.15	Black/Stainless Steel	spout bls
168493MSRS	152.60	Spot Resist Stainless	flangless spout kit
168494BG	40.95	Brushed Gold	handle kit bg
168494BL	40.95	Matte Black	handle kit bl
168494BLS	45.05	Black/Stainless Steel	handle bls
168494SRS	40.95	Spot Resist Stainless	handle srs
168495BL	204.75	Matte Black	spout kit, bl
168495SRS	252.25	Spot Resist Stainless	kitchen spout srs
168496BL	95.10	Matte Black	side spray kit, bl
168496SRS	55.40	Spot Resist Stainless	sidespray kit srs

Part Number	List	Finish	Description
168497BG	162.40	Brushed Gold	spout kit bg
168497BL	139.35	Matte Black	bar spout bl
168497BLS	178.70	Black/Stainless Steel	spout bls
168497SRS	162.40	Spot Resist Stainless	bar spout srs
168501BG	271.25	Brushed Gold	spout kit bg
168501BL	261.95	Black	spout kit bl
168501SRS	271.25	Spot Resist Stainless	spout kit srs
168502BG	47.80	Brushed Gold	handle kit bg
168502BL	46.30	Black	handle kit bl
168502BLC	301.50	Matte Black/Chrome	handle kit blc
168502SRS	47.80	Spot Resist Stainless	handle srs
168503BG	243.60	Brushed Gold	spout kit bg
168503BL	235.05	Black	spout kit bl
168503SRS	243.60	Spot Resist Stainless	spout kit srs
168682BL	388.65	Matte Black	arris wallmount spout kit bl
168682BN	353.40	Brushed Nickel	wall mount spout kit bn
168683BL	126.55	Matte Black	3/4 thermostatic shower escutcheon
168683BN	126.55	Brushed Nickel	3/4 thermostatic shower escutcheon bn
169245ORB	14.05	Oil Rubbed Bronze	dome kit, orb
169250ORB	85.95	Oil Rubbed Bronze	wand kit orb
169252ORB	56.85	Oil Rubbed Bronze	escutcheon & gasket kit, orb
170145ORB	542.05	Oil Rubbed Bronze	vestige spout kit orb
170145SRS	506.25	Spot Resist Stainless	vestige spout kit srs
172654BG	53.85	Brushed Gold	shower handle kit bg
172654BL	53.80	Matte Black	shower handle kit bl
172654BN	53.85	Brushed Nickel	shower handle kit
172655BG	50.30	Brushed Gold	transfer trim escutcheon bg
172655BL	60.00	Matte Black	transfer trim escutcheon bl
172655BN	50.30	Brushed Nickel	transfer trim escutcheon
172658BG	69.05	Brushed Gold	diverter lift rod bg
172658BN	69.05	Brushed Nickel	roman tub lift rod
172659BG	399.75	Brushed Gold	roman tub spout bg
172659BN	399.75	Brushed Nickel	4h roman tub spout kit
172660BG	402.20	Brushed Gold	3h roman tub spout kit bg
172660BL	442.45	Matte Black	align roman tub spout kit bl
172660BN	402.20	Brushed Nickel	3h roman tub spout kit
172661BG	61.20	Brushed Gold	widespread lift rod kit bg
172661BL	52.85	Matte Black	widespread lift rod kit bl
172661BN	61.20	Brushed Nickel	widespread lift rod
172662BG	34.05	Brushed Gold	widespread spout kit bg
172662BL	194.00	Matte Black	widespread spout kit bl
172662BN	34.05	Brushed Nickel	widespread spout kit
172663BG	78.80	Brushed Gold	handle kit bg
172663BL	78.15	Matte Black	handle kit bl
172663BN	78.80	Brushed Nickel	handle kit
172665BG	38.90	Brushed Gold	handle kit with red/blue bg
172665BL	65.95	Matte Black	single hole handle kit with red/ blue bl
172665BN	41.15	Brushed Nickel	single hole handle kit with red/ blue
172666SRN	19.50	Chrome	3hole escutcheon kit srn
172667BG	16.40	Brushed Gold	lift rod bg
172667BL	25.05	Matte Black	single hndl low profile lav lift rod bl
172667BN	16.40	Brushed Nickel	single handle low profile lav lift rod k
172668BG	17.40	Brushed Gold	single handle single hole escutcheon bg
172668BL	25.30	Matte Black	single hndl single hole escutcheon bl
172668BN	17.40	Brushed Nickel	single handle single hole escutcheon kit
172669BG	80.00	Brushed Gold	escutcheon bg
172669BN	80.00	Brushed Nickel	moentrol shower escutcheon kit
173816BG	88.35	Brushed Gold	wand kit
173816BL	60.95	Matte Black	wand kit bl

Moen Genuine Parts

Listed in numerical order

Part Number	List	Finish	Description
173816BLS	61.10	Black/Stainless Steel	wand kit bls
173816SRS	46.10	Spot Resist Stainless	wand kit srs
173988SRS	114.15	Spot Resist Stainless	wand kit srs
174333BG	75.95	Brushed Gold	posi escutcheon red/blue bg
174333BL	58.05	Matte Black	posi escutcheon red/blue bl
174333BN	75.95	Brushed Nickel	posi escutcheon red/blue
174948MBRB	141.65	Mediterranean Bronze	flangeless spout kit 173889 mbrb
175376BN	59.75	Brushed Nickel	andle kit bn
175376NL	59.75	Polished Nickel	handle kit nl
175376ORB	65.80	Oil Rubbed Bronze	handle kit orb
175377BN	78.90	Brushed Nickel	escutcheon kit bn
175377NL	78.90	Polished Nickel	escutcheon kit nl
175377ORB	86.75	Oil Rubbed Bronze	escutcheon kit orb
175378BN	54.10	Brushed Nickel	lift rod bn
175378NL	54.10	Polished Nickel	lift rod nl
175378ORB	59.50	Oil Rubbed Bronze	lift rod orb
175379BN	77.60	Brushed Nickel	lever handle kit bn
175379NL	77.60	Polished Nickel	lever handle kit nl
175379ORB	85.35	Oil Rubbed Bronze	lever handle kit orb
175380BN	98.80	Brushed Nickel	cross handle kit bn
175380NL	98.80	Polished Nickel	cross handle kit nl
175380ORB	108.75	Oil Rubbed Bronze	cross handle kit orb
175381BN	254.85	Brushed Nickel	widespread spout kit bn
175381NL	254.85	Polished Nickel	widespread spout kit nl
175381ORB	280.35	Oil Rubbed Bronze	widespread spout kit orb
175382BN	490.35	Brushed Nickel	3h roman tub spout bn
175382NL	490.35	Polished Nickel	3h roman tub spout nl
175382ORB	539.45	Oil Rubbed Bronze	3h roman tub spout orb
175383BN	78.80	Brushed Nickel	escutcheon bn
175383NL	78.80	Polished Nickel	escutcheon nl
175383ORB	86.75	Oil Rubbed Bronze	escutcheon orb
175983ORB	272.60	Oil Rubbed Bronze	kitchen spout kit orb
175983SRS	223.45	Spot Resist Stainless	kitchen spout kit srs
175985ORB	44.80	Oil Rubbed Bronze	kitchen handle kit orb
175985SRS	38.75	Spot Resist Stainless	kitchen handle kit srs
176077BL	123.25	Black	flangeless spout kit 173888 bl
176077BRB	149.20	Mediterranean Bronze	flangeless spout kit 173888 brb
176077MSRS	121.65	Spot Resist Stainless	flangeless spout kit 173888 msrs
176077ORB	149.20	Oil Rubbed Bronze	flangeless spout kit
176078BL	80.90	Matte Black	flangeless spout kit bl
176078BRB	153.60	Mediterranean Bronze	flangeless spout kit 173890 brb
176078ORB	153.60	Oil Rubbed Bronze	flangeless spout kit
176078SRS	116.55	Spot Resist Stainless	flangeless spout kit 173890 srs
176079BL	128.80	Black	flangeless spout kit 173892 bl
176079ORB	156.30	Oil Rubbed Bronze	flangeless spout kit
176079SRS	138.35	Spot Resist Stainless	flangeless spout kit 173892 srs
176081SRS	154.65	Spot Resist Stainless	flangeless spout kit 173895 srs
176086SRS	149.55	Spot Resist Stainless	flangeless spout kit 172905 srs
176101BL	48.15	Matte Black	handle kit h/c bl
176101BN	43.80	Brushed Nickel	1h lav hdl kit bn
176261ORB	100.40	Oil Rubbed Bronze	flangeless spout kit 173893 orb
176633BG	54.75	Brushed Gold	diverter ring bg
176633BL	60.25	Matte Black	diverter ring, bl
176633BN	54.75	Brushed Nickel	diverter ring bn
176633NL	54.75	Polished Nickel	diverter ring nl
176633ORB	60.20	Oil Rubbed Bronze	diverter ring orb
177138BN	62.75	Brushed Nickel	handle kit hot/cold bn
177138ORB	69.10	Oil Rubbed Bronze	handle kit hot/cold orb
177167BN	61.80	Brushed Nickel	1h lav escutcheon plate bn
177167NL	61.80	Polished Nickel	1h lav escutcheon plate nl
177167ORB	67.85	Oil Rubbed Bronze	1h lav escutcheon plate orb
177573ORB	519.85	Oil Rubbed Bronze	spout kit, orb
177573SRS	494.70	Spot Resist Stainless	spout kit, srs

Part Number	List	Finish	Description
177574ORB	543.10	Oil Rubbed Bronze	spout kit, orb
177574SRS	521.75	Spot Resist Stainless	spout kit, srs
177575SRS	475.60	Spot Resist Stainless	spout kit, srs
177576SRS	570.05	Spot Resist Stainless	spout kit, srs
177701BN	62.90	Brushed Nickel	knob, bdt dvrtr bn
177701ORB	69.15	Oil Rubbed Bronze	knob, bdt dvrtr orb
177702BN	55.75	Brushed Nickel	escut, bdt dvrtr bn
177702ORB	61.25	Oil Rubbed Bronze	escut, bdt dvrtr orb
178216ORB	52.50	Oil Rubbed Bronze	1h kitchen handle and set screw kit orb
178216SRS	46.55	Spot Resist Stainless	1h kitchen handle and set screw kit srs
178217ORB	23.85	Oil Rubbed Bronze	1h kitchen handle dome kit orb
178217SRS	20.35	Spot Resist Stainless	1h kitchen handle dome kit srs
178218ORB	158.20	Oil Rubbed Bronze	1h kitchen spout kit orb
178218SRS	177.00	Spot Resist Stainless	1h kitchen spout kit srs
178219ORB	69.80	Oil Rubbed Bronze	1h kitchen spout hub kit orb
178219SRS	52.80	Spot Resist Stainless	1h kitchen spout hub kit srs
178231ORB	28.60	Oil Rubbed Bronze	2h kitchen spout cap orb
178231SRS	37.70	Spot Resist Stainless	2h kitchen spout cap srs
178232ORB	67.60	Oil Rubbed Bronze	2h kitchen hot handle kit orb
178232SRS	57.00	Spot Resist Stainless	2h kitchen hot handle kit srs
178233ORB	124.60	Oil Rubbed Bronze	2h kitchen spout hub kit orb
178233SRS	113.25	Spot Resist Stainless	2h kitchen spout hub kit srs
178234ORB	61.85	Oil Rubbed Bronze	escutcheon orb
178234SRS	50.50	Spot Resist Stainless	escutcheon srs
178462BN	57.50	Brushed Nickel	lever handle kit bn
178462NL	57.50	Polished Nickel	lever handle kit nl
178462ORB	63.30	Oil Rubbed Bronze	lever handle kit orb
178467BG	45.80	Brushed Gold	3f transfer valve escutcheon kit bg
178467BL	50.35	Matte Black	diverter valve escutcheonbl
178467BN	45.80	Brushed Nickel	diverter valve escutcheon bn
178888BN	309.70	Brushed Nickel	spout kit, bn
178888ORB	340.75	Oil Rubbed Bronze	spout kit, orb
178890BN	303.75	Brushed Nickel	spout kit, bn
178890ORB	334.05	Oil Rubbed Bronze	spout kit, orb
178892BN	334.15	Brushed Nickel	spout kit, bn
178892ORB	367.60	Oil Rubbed Bronze	spout kit, orb
178894BN	408.25	Brushed Nickel	spout kit, bn
178894ORB	448.95	Oil Rubbed Bronze	spout kit, orb
178896BN	429.80	Brushed Nickel	spout kit, bn
178896ORB	472.70	Oil Rubbed Bronze	spout kit, orb
179084ORB	67.60	Oil Rubbed Bronze	2h kitchen cold handle kit orb
179084SRS	57.00	Spot Resist Stainless	2h kitchen cold handle kit srs
179085ORB	168.05	Oil Rubbed Bronze	2h kitchen spout kit orb
179085SRS	193.15	Spot Resist Stainless	2h kitchen spout kit srs
179086ORB	77.60	Oil Rubbed Bronze	traditional side spray w/poi srs
179086SRS	65.85	Spot Resist Stainless	traditional side spray w/poi srs
179353SRS	21.45	Spot Resist Stainless	aerator kit 1.5gpm srs
179354BN	316.85	Brushed Nickel	lift rod kit bn
179354NL	316.85	Polished Nickel	lift rod kit nl
179354ORB	348.60	Oil Rubbed Bronze	lift rod kit orb
179655ORB	51.15	Oil Rubbed Bronze	handle kit, obr
179655SRS	48.35	Spot Resist Stainless	handle kit, srs
179656ORB	75.50	Oil Rubbed Bronze	wand kit, orb
179656SRS	71.05	Spot Resist Stainless	wand kit, srs
179657ORB	217.10	Oil Rubbed Bronze	receptor kit, obr
179657SRS	230.40	Spot Resist Stainless	receptor kit, srs
179675SRN	28.05	Spot Resist Brushed Nickel	handle kit hot, srs
179781BL	26.35	Matte Black	cs lift rod kit bl
179781BN	23.90	Brushed Nickel	cs lift rod kit bn
179782BL	68.30	Matte Black	centerset handle kit bl
179782BN	62.10	Brushed Nickel	centerset handle kit bn
179784BL	90.80	Matte Black	widespread handle kit bl
179784BN	82.50	Brushed Nickel	widespread handle kit bn

Moen Genuine Parts

Listed in numerical order

Part Number	List	Finish	Description
179785BN	316.55	Brushed Nickel	non diverting rt spout bn
179786BL	51.85	Matte Black	widespread lift rod kit bl
179786BN	47.10	Brushed Nickel	widespread lift rod kit bn
179787BL	233.25	Matte Black	widespread spout kit bl
179787BN	212.05	Brushed Nickel	widespread spout kit bn
179790BL	65.35	Matte Black	escutcheon bl
179790BN	59.35	Brushed Nickel	escutcheon bn
179792BL	77.20	Matte Black	handle kit bl
179792BN	70.25	Brushed Nickel	handle kit bn
179793ORB	29.10	Oil Rubbed Bronze	sidespray hose guide orb
179793SRS	34.30	Spot Resist Stainless	sidespray hose guide srs
179827BLC	362.45	Matte Black/Chrome	1h lav handle kit, blc
179828BL	46.00	Matte Black	lift rod kit, bl
179830BLC	346.10	Matte Black/Chrome	ws handle kit, blc
179831BLC	314.60	Matte Black/Chrome	1h lav spout kit, blc
180059BL	106.70	Matte Black	wand kit 1.0gpm bl
180059SRS	106.70	Spot Resist Stainless	wand kit 1.0gpm
180073BN	64.80	Brushed Nickel	diverter lift rod bn
180073NL	64.80	Polished Nickel	diverter lift rod nl
180073ORB	71.25	Oil Rubbed Bronze	diverter lift rod orb
181066BN	10.55	Brushed Nickel	male thread 1.2gpm aerator bn
181080BG	37.45	Brushed Gold	lav aer shell & insert bg
181087BN	19.65	Brushed Nickel	kit aer chr 1.2gpm
181106BC	82.45	Brushed Chrome	handle kit cold, bc
181107BC	82.45	Brushed Chrome	handle kit hot, bc
181502BN	44.10	Brushed Nickel	3f dvtr vlv escut, bn
181502ORB	48.65	Oil Rubbed Bronze	3f dvtr vlv escut, orb
181603BN	140.25	Brushed Nickel	3f dvtr lever kit, bn
181603ORB	154.30	Oil Rubbed Bronze	3f dvtr lever kit, orb
181929BG	294.25	Brushed Gold	swing arm kit
181929BL	224.45	Matte Black	swing arm bl
181929BLS	251.10	Black/Stainless Steel	swing arm & collar bls
181929SRS	228.35	Spot Resist Stainless	swing arm and collar kit
181930BG	180.40	Brushed Gold	spring and bearing kit
181930BL	117.60	Matte Black	spring spout and bearing bl
181930BLS	141.40	Black/Stainless Steel	spring & bearing kit bls
181930SRS	128.55	Spot Resist Stainless	spring and bearing kit
182074BN	631.15	Brushed Nickel	4h roman tub spout bn
182074ORB	694.25	Oil Rubbed Bronze	4h roman tub spout orb
182212BN	192.00	Brushed Nickel	brantford ws spout kit
182212ORB	210.70	Oil Rubbed Bronze	brantford ws spout kit
182213BN	171.00	Brushed Nickel	eva ws spout kit bn
182213ORB	207.90	Oil Rubbed Bronze	eva ws spout kit orb
182244BN	60.45	Brushed Nickel	handle kit hot/cold, bn
182244ORB	66.45	Oil Rubbed Bronze	handle kit hot/cold, orb
182496BN	57.00	Brushed Nickel	handle kit hot/cold, bn
182496NL	57.00	Polished Nickel	handle kit hot/cold, nl
182496ORB	62.75	Oil Rubbed Bronze	handle kit hot/cold, orb
182632BG	38.85	Brushed Gold	escutcheon brushed gold
182632BL	40.10	Matte Black	upper/lower escutcheon w/set screw bl
182632BN	38.85	Brushed Nickel	upper/lower escutcheon w/set screw bn
182632ORB	40.10	Oil Rubbed Bronze	upper/lower escutcheon w/set screw orb
182633BL	86.90	Matte Black	elbow w/check valve bl
182633BN	83.95	Brushed Nickel	elbow w/check valve bn
182633ORB	86.90	Oil Rubbed Bronze	elbow w/check valve orb
182636BL	8.75	Matte Black	diverter handle cap bl
182636BN	8.45	Brushed Nickel	diverter handle cap bn
182636ORB	8.75	Oil Rubbed Bronze	diverter handle cap orb
182637BL	42.40	Matte Black	diverter handle kit bl
182637BN	40.95	Brushed Nickel	diverter handle kit bn
182637ORB	42.40	Oil Rubbed Bronze	diverter handle kit orb
182843BL	24.75	Matte Black	lift rod kit, ws, bl

Part Number	List	Finish	Description
182843BN	22.45	Brushed Nickel	lift rod kit, widespread bn
182862BN	91.45	Brushed Nickel	posi escutcheon red/blue bn
183196ORB	41.35	Oil Rubbed Bronze	handle kit orb
183296SRS	86.40	Spot Resist Stainless	handle kit srs
183297SRS	130.20	Spot Resist Stainless	wand kit srs
183298SRS	47.30	Spot Resist Stainless	receptor kit srs
183570BG	47.10	Brushed Gold	slider brushed gold
183570BL	56.25	Matte Black	slider kit for annex bl
183570BN	54.35	Brushed Nickel	slider kit for annex bn
183570ORB	56.25	Oil Rubbed Bronze	slider kit for annex orb
183598BL	60.80	Matte Black	handle kit, bl
183598BN	34.70	Brushed Nickel	handle kit, bn
183810BN	57.15	Matte Black	genta posi handle kit bn
184081BL	80.10	Matte Black	1h handle kit bl
184081BN	43.05	Brushed Nickel	1h handle kit bn
184085BL	187.45	Matte Black	widespread spout kit bl
184085BN	103.75	Brushed Nickel	widespread spout kit bn
184086BL	261.65	Matte Black	roman tub spout kit bl
184086BN	235.45	Brushed Nickel	roman tub spout kit bn
184445BG	57.85	Brushed Gold	handle kit - hot or cold bg
184445BN	57.85	Brushed Nickel	centerset handle kit bn
184445NL	57.85	Polished Nickel	centerset handle kit, nl
184445ORB	63.65	Oil Rubbed Bronze	centerset handle kit orb
184450BN	56.50	Brushed Nickel	hndl assy kit bn
185794BRB	17.45	Mediterranean Bronze	spout hub kit, brb
185807BL	82.10	Matte Black	handle kit
185807BN	57.20	Brushed Nickel	1h handle kit bn
185807NL	57.20	Polished Nickel	1h handle kit, nl
185807ORB	61.10	Oil Rubbed Bronze	1h handle kit orb
185808BL	67.40	Matte Black	lift rod kit
185808BN	22.65	Brushed Nickel	1h lift rod kit bn
185808NL	22.65	Polished Nickel	1h lift rod kit, nl
185808ORB	23.35	Oil Rubbed Bronze	1h lift rod kit orb
185810BN	55.80	Brushed Nickel	1h escutcheon bn
185810NL	55.80	Polished Nickel	1h escutcheon, nl
185810ORB	58.15	Oil Rubbed Bronze	1h escutcheon orb
185811BN	54.25	Brushed Nickel	cs lever handle kit bn
185811NL	54.25	Polished Nickel	cs lever handle kit, nl
185811ORB	92.95	Oil Rubbed Bronze	cs lever handle kit orb
185812BL	53.00	Matte Black	lift rod kit
185812BN	23.35	Brushed Nickel	cs lift rod kit bn
185812NL	23.35	Polished Nickel	cs lift rod kit, nl
185812ORB	24.80	Oil Rubbed Bronze	cs lift rod kit orb
185813BL	72.80	Matte Black	spout cap kit
185813BN	45.15	Brushed Nickel	ws spout cap bn
185813NL	45.15	Polished Nickel	ws spout kit, nl
185813ORB	45.95	Oil Rubbed Bronze	ws spout cap orb
185814BL	40.80	Matte Black	lift rod kit
185814BN	26.00	Brushed Nickel	lift rod kit bn
185814NL	26.00	Polished Nickel	lift rod kit, nl
185814ORB	26.50	Oil Rubbed Bronze	lift rod kit orb
185815BN	63.20	Brushed Nickel	handle kit bn
185815NL	64.60	Polished Nickel	handle kit, nl
185815ORB	99.25	Oil Rubbed Bronze	handle kit orb
185816BN	210.00	Brushed Nickel	ws spout kit bn
185816NL	214.75	Polished Nickel	ws spout kit, nl
185816ORB	218.05	Oil Rubbed Bronze	ws spout kit orb
185817BN	364.75	Brushed Nickel	3h rt spout kit bn
185817NL	364.75	Polished Nickel	3h rt spout kit, nl
185817ORB	373.85	Oil Rubbed Bronze	3h rt spout kit orb
185818BN	338.15	Brushed Nickel	4h rt spout kit bn
185818NL	338.15	Polished Nickel	4h rt spout kit, nl
185818ORB	353.30	Oil Rubbed Bronze	4h rt spout kit orb
185819BL	123.20	Matte Black	diverter lift rod kit

Moen Genuine Parts

Listed in numerical order

Part Number	List	Finish	Description
185819BN	30.15	Brushed Nickel	rt diverter lift rod kit bn
185819NL	30.80	Polished Nickel	rt diverter lift rod kit, nl
185819ORB	31.00	Oil Rubbed Bronze	rt diverter lift rod kit orb
185821BL	75.40	Matte Black	handle and screw kit
185821BN	48.75	Brushed Nickel	shower handle kit bn
185821NL	49.90	Polished Nickel	shower handle kit, nl
185821ORB	52.50	Oil Rubbed Bronze	shower handle kit orb
185823BN	40.50	Brushed Nickel	t valve escutcheon bn
185823NL	40.50	Polished Nickel	transfer valve escutcheon, nl
185823ORB	42.55	Oil Rubbed Bronze	t valve escutcheon orb
185834BN	65.85	Brushed Nickel	moentrol escutcheon bn
185834NL	65.85	Polished Nickel	moentrol escutcheon, nl
185834ORB	94.25	Oil Rubbed Bronze	moentrol escutcheon orb
187053BG	76.85	Brushed Gold	magnetix docking kit bg
187053BN	75.85	Brushed Nickel	magnetix docking cradle, bn
187053ORB	83.10	Oil Rubbed Bronze	magnetix docking cradle, orb
187093BN	73.55	Brushed Nickel	ws handle kit bn
187728BLS	94.50	Black/Stainless Steel	wand kit bls
187728SRS	57.05	Spot Resist Stainless	wand kit srs
187729BG	41.15	Brushed Gold	handle kit, bg
187729BLS	45.15	Black/Stainless Steel	handle bls
187729SRS	39.80	Spot Resist Stainless	handle kit srs
188029BL	128.10	Matte Black	wand kit, bl
188029SRS	48.80	Spot Resist Stainless	wand kit srs
188030BL	126.10	Matte Black	handle kit, bl
188030SRS	38.75	Spot Resist Stainless	handle kit srs
190102BL	75.60	Matte Black	handle kit, bl
190102BN	68.70	Brushed Nickel	handle kit bn
190102ORB	75.65	Oil Rubbed Bronze	handle kit orb
190112BL	62.90	Matte Black	lift rod, bl
190112BN	57.20	Brushed Nickel	lift rod bn
190112ORB	62.90	Oil Rubbed Bronze	lift rod orb
190202BL	88.90	Matte Black	lever handle kit, bl
190202BN	80.90	Brushed Nickel	lever handle kit bn
190202ORB	88.90	Oil Rubbed Bronze	lever handle kit orb
190322BL	489.60	Matte Black	rt spout kit, bl
190322BN	435.25	Brushed Nickel	rt spout kit bn
190322ORB	489.60	Oil Rubbed Bronze	rt spout kit orb
190330SRS	46.60	Spot Resist Stainless	deck plate kit srs
190444BL	49.05	Matte Black	posi escutcheon, bl
190444BN	44.50	Brushed Nickel	posi escutcheon bn
190444NL	44.50	Polished Nickel	posi escutcheon, nl
190444ORB	49.05	Oil Rubbed Bronze	posi escutcheon orb
190503BL	97.20	Matte Black	shower handle kit, bl
190503BN	88.45	Brushed Nickel	shower handle kit bn
190503ORB	97.20	Oil Rubbed Bronze	shower handle kit orb
190844BL	32.90	N/A	lift rod kit bl
190844BN	30.55	Brushed Nickel	lift rod kit bn
190845BL	65.95	Matte Black	handle lever kit bl
190845BN	60.05	Brushed Nickel	handle lever kit bn
190846BL	92.40	Matte Black	handle kit hot bl
190846BN	84.00	Brushed Nickel	handle kit hot bn
190847BL	92.40	Matte Black	handle kit cold bl
190847BN	84.00	Brushed Nickel	handle kit cold bn
190848BL	434.00	Matte Black	ws spout kit bl
190848BN	394.55	Brushed Nickel	ws spout kit bn
190850BL	481.30	Matte Black	3h rt spout kit bl
190850BN	437.60	Brushed Nickel	3h rt spout kit bn
190851BL	57.90	Matte Black	diverter lift rod bl
190851BN	52.60	Brushed Nickel	diverter lift rod bn
190852BL	773.85	Matte Black	4h rt spout kit bl
190852BN	703.55	Brushed Nickel	4h rt spout kit bn
190853BG	65.40	Brushed Gold	escutcheon bg
190853BL	71.90	Matte Black	escutcheon bl

Part Number	List	Finish	Description
190853BN	65.40	Brushed Nickel	escutcheon bn
190853NL	65.40	Polished Nickel	escutcheon nl
190854BL	76.15	Matte Black	posi/moentrol escutcheon bl
190854BN	69.20	Brushed Nickel	posi/moentrol escutcheon bn
190856BL	92.75	Matte Black	2f tv escutcheon bl
190856BN	84.35	Brushed Nickel	2f tv escutcheon bn
190857BL	79.95	Matte Black	3f tv escutcheon bl
190857BN	72.65	Brushed Nickel	3f tv escutcheon bn
190858BG	90.10	Brushed Gold	handle escutcheon kit bg
190858BL	99.20	Matte Black	handle escutcheon kit bl
190858BN	90.10	Brushed Nickel	handle escutcheon kit bn
190858NL	87.05	Polished Nickel	handle escutcheon kit nl
190859BL	116.15	Matte Black	posi handle kit bl
190859BN	105.60	Brushed Nickel	posi handle kit bn
190860BL	118.90	Matte Black	moentrol handle kit bl
190860BN	108.10	Brushed Nickel	moentrol handle kit bn
190861BL	114.40	Matte Black	2f tv handle kit bl
190861BN	104.00	Brushed Nickel	2f tv handle kit bn
190862BL	107.35	Matte Black	3f tv handle kit bl
190862BN	97.55	Brushed Nickel	3f tv handle kit bn
190888BL	252.70	Matte Black	spout kit, bl
191000BL	255.70	Matte Black	arbor wave faucet assembly kit bl
191000ORB	258.95	Oil Rubbed Bronze	arbor wave faucet assembly kit orb
191000SRS	236.85	Spot Resist Stainless	arbor wave faucet assembly kit srs
191001BL	257.00	Matte Black	sleek wave faucet assembly kit bl
191001SRS	247.75	Spot Resist Stainless	sleek wave faucet assembly kit srs
191002BG	339.35	Brushed Gold	faucet assembly kit
191002BL	327.90	Matte Black	faucet assembly kit bl
191002BLS	347.10	Black/Stainless Steel	faucet assy kit bls
191002SRS	315.50	Spot Resist Stainless	align spring wave faucet assembly kit srs
191004BL	35.00	Matte Black	arbor power boost wand kit bl
191004ORB	66.45	Oil Rubbed Bronze	arbor power boost wand kit orb
191004SRS	57.65	Spot Resist Stainless	arbor power boost wand kit srs
191005ORB	66.30	Oil Rubbed Bronze	brantford power boost wand kit orb
191005SRS	39.60	Spot Resist Stainless	brantford power boost wand kit srs
191751BL	52.65	Matte Black	black pull-down hose kit
193089BG	105.95	Brushed Gold	2f tv escutcheon kit bg
193089BL	116.55	Matte Black	2f transfer valve escutcheon, bl
193089BN	105.95	Brushed Nickel	2f tv escutcheon kit, bn
193089NL	105.95	Polished Nickel	2f tv escutcheon kit, nl
193089ORB	116.55	Oil Rubbed Bronze	2f tv escutcheon kit, orb
193090BG	114.20	Brushed Gold	posi handle kit bg
193090BL	125.60	Matte Black	posi handle kit, bl
193090BN	114.20	Brushed Nickel	posi handle kit, bn
193090NL	114.20	Polished Nickel	posi handle kit, nl
193090ORB	125.60	Oil Rubbed Bronze	posi handle kit, orb
193091BG	114.20	Brushed Gold	handle assembly bg
193091BL	125.60	Matte Black	handle assembly, bl
193091BN	114.20	Brushed Nickel	moentrol handle kit, bn
193091NL	114.20	Polished Nickel	moentrol handle kit, nl
193091ORB	126.25	Oil Rubbed Bronze	moentrol handle kit, orb
193092BG	114.75	Brushed Gold	2f transfer valve handle kit bg
193092BL	126.30	Matte Black	2f transfer valve handle, bl
193092BN	114.75	Brushed Nickel	2f transfer valve handle kit, bn
193092NL	114.75	Polished Nickel	2f transfer valve handle kit, nl
193092ORB	126.30	Oil Rubbed Bronze	2f transfer valve handle kit, orb
193093BG	107.65	Brushed Gold	3f transfer valve handle kit bg
193093BL	118.35	Matte Black	3f transfer valve handle kit, bl
193093BN	107.65	Brushed Nickel	3f transfer valve handle kit, bn
193093NL	107.65	Polished Nickel	3f transfer valve handle kit, nl

Moen Genuine Parts

Listed in numerical order

Part Number	List	Finish	Description
193093ORB	118.35	Oil Rubbed Bronze	3f transfer valve handle kit, orb
193094BL	156.05	Matte Black	shower escutcheon kit, bl
193094BN	141.85	Brushed Nickel	shower escutcheon kit, bn
193095BL	109.90	Matte Black	2f tv esct kit, bl
193095BN	99.90	Brushed Nickel	2f tv escutcheon kit, bn
193096BL	111.65	Matte Black	3f escutcheon kit, bl
193096BN	101.45	Brushed Nickel	3f tv escutcheon kit, bn
193097BL	93.10	Matte Black	handle hub escutcheon, bl
193097BN	84.60	Brushed Nickel	handle hub escutcheon kit, bn
193098BL	99.70	Matte Black	posi handle kit, bl
193098BN	90.60	Brushed Nickel	posi handle kit, bn
193099BL	103.40	Matte Black	moontrol handle kit, bl
193099BN	94.05	Brushed Nickel	moontrol handle kit, bn
193100BL	100.20	Matte Black	2f transfer valve handle, bl
193100BN	91.10	Brushed Nickel	2f transfer valve handle kit, bn
193101BL	92.80	Matte Black	3f transfer valve handle kit, bl
193101BN	84.35	Brushed Nickel	3f transfer valve handle kit, bn
193193BG	168.70	Brushed Gold	diverter kit bg
193193BN	168.70	Brushed Nickel	diverter kit bn
193193NL	168.70	Polished Nickel	diverter kit nl
193193ORB	185.55	Oil Rubbed Bronze	diverter kit orb
193194BG	62.70	Brushed Gold	diverter knob kit bg
193194BN	63.95	Brushed Nickel	diverter knob kit bn
193194NL	63.95	Polished Nickel	diverter knob kit nl
193194ORB	70.40	Oil Rubbed Bronze	diverter knob kit orb
193195BG	61.45	Brushed Gold	handshower cradle kit bg
193195BN	67.50	Brushed Nickel	handshower cradle kit bn
193195ORB	71.70	Oil Rubbed Bronze	handshower cradle kit orb
193196BG	115.65	Brushed Gold	handle kit bg
193196BN	120.30	Brushed Nickel	handle kit bn
193196ORB	125.95	Oil Rubbed Bronze	handle kit orb
193244BG	119.10	Brushed Gold	extmp escutcheon kit align bg
193244BL	130.95	Matte Black	extmp escutcheon kit align bl
193244BN	119.10	Brushed Nickel	extmp escutcheon kit align bn
193245BG	104.70	Brushed Gold	thermostatic hdl kit align bg
193245BL	115.15	Matte Black	thermostatic hdl kit align bl
193245BN	104.70	Brushed Nickel	thermostatic hdl kit align bn
193246BG	105.70	Brushed Gold	volume hdl kit align bg
193246BL	116.30	Matte Black	volume hdl kit align bl
193246BN	105.70	Brushed Nickel	volume hdl kit align bn
193247BN	102.55	Brushed Nickel	extmp escutcheon kit belfield bn
193247NL	102.55	Polished Nickel	extmp escutcheon kit belfield nl
193247ORB	112.80	Oil Rubbed Bronze	extmp escutcheon kit belfield orb
193248BN	102.05	Brushed Nickel	thermostatic hdl kit belfield bn
193248NL	102.05	Polished Nickel	thermostatic hdl kit belfield nl
193248ORB	112.25	Oil Rubbed Bronze	thermostatic hdl kit belfield orb
193249BN	103.15	Brushed Nickel	volume hdl kit belfield bn
193249NL	103.15	Polished Nickel	volume hdl kit belfield nl
193249ORB	113.40	Oil Rubbed Bronze	volume hdl kit belfield orb
193250BN	195.75	Brushed Nickel	extmp escutcheon kit wynford bn
193250NL	195.75	Polished Nickel	extmp escutcheon kit wynford nl
193250ORB	215.25	Oil Rubbed Bronze	extmp escutcheon kit wynford orb
193251BN	105.85	Brushed Nickel	thermostatic hdl kit wynford bn
193251NL	105.85	Polished Nickel	thermostatic hdl kit wynford nl
193251ORB	116.40	Oil Rubbed Bronze	thermostatic hdl kit wynford orb
193252BN	107.10	Brushed Nickel	volume hdl kit wynford bn
193252NL	107.10	Polished Nickel	volume hdl kit wynford nl
193252ORB	117.75	Oil Rubbed Bronze	volume hdl kit wynford orb
193253BG	132.25	Brushed Gold	extmp escutcheon kit voss bg
193253BN	132.25	Brushed Nickel	extmp escutcheon kit voss bn
193253NL	132.25	Polished Nickel	extmp escutcheon kit voss nl
193253ORB	145.50	Oil Rubbed Bronze	extmp escutcheon kit voss orb

Part Number	List	Finish	Description
193254BG	103.15	Brushed Gold	thermostatic hdl kit voss bg
193254BN	103.15	Brushed Nickel	thermostatic hdl kit voss bn
193254NL	103.15	Polished Nickel	thermostatic hdl kit voss nl
193254ORB	113.40	Oil Rubbed Bronze	thermostatic hdl kit voss orb
193255BG	104.30	Brushed Gold	volume hdl kit voss bg
193255BN	104.30	Brushed Nickel	volume hdl kit voss bn
193255NL	104.30	Polished Nickel	volume hdl kit voss nl
193255ORB	114.70	Oil Rubbed Bronze	volume hdl kit voss orb
193499ORB	331.05	Oil Rubbed Bronze	brantford wave kit orb
193499SRS	346.65	Spot Resist Stainless	brantford wave kit srs
194993BL	36.10	Matte Black	via protruded aerator shell kit,bl
194994BL	36.10	Matte Black	rizon protruded aerator shell kit, bl
194994BN	33.70	Brushed Nickel	rizon protruded aerator shell kit, bn
194994ORB	36.10	Oil Rubbed Bronze	rizon/eva protruded aerator shell kit
194995BN	33.70	Brushed Nickel	protruded aerator shell kit, bn
194995SRN	33.70	Spot Resist Brushed Nickel	protruded aerator shell kit, srsn
195173BL	261.45	Matte Black	spout kit matte black
195173BN	249.35	Brushed Nickel	spout kit brushed nickel
195345BG	97.75	Brushed Gold	et escutcheon kit bg
195345BL	107.50	Matte Black	et escutcheon kit bl
195345BN	97.75	Brushed Nickel	et escutcheon kit bn
195345NL	97.75	Polished Nickel	et escutcheon kit nl
195346BL	147.85	Matte Black	thermostatic handle kit bl
195346BN	134.45	Brushed Nickel	thermostatic handle kit bn
195347BG	73.55	Brushed Gold	et short ring esc kit bg
195347BL	80.90	Matte Black	et short ring esc kit bl
195347BN	73.55	Brushed Nickel	et short ring esc kit bn
195347NL	73.55	Polished Nickel	et short ring esc kit nl
195349BL	146.35	Matte Black	volume handle kit bl
195349BN	133.05	Brushed Nickel	volume handle kit bn
195355BL	111.55	Oil Rubbed Bronze	kitchen spout bl
195355SRS	84.45	Spot Resist Stainless	kitchen spout srs
195356BL	46.10	Matte Black	lever handle - bl
195356SRS	34.05	Spot Resist Stainless	lever handle - srs
195357BL	119.10	Matte Black	metal wand kit - bl
195357SRS	78.30	Spot Resist Stainless	metal wand kit - srs
195358BL	104.45	Matte Black	wheel handle kit - bl
195358SRS	49.25	Spot Resist Stainless	wheel handle kit - srs
195359BL	109.35	Matte Black	spout kit bar
195359SRS	99.10	Spot Resist Stainless	spout kit bar
195360BL	99.05	Matte Black	metal bar wand kit - bl
195360SRS	65.15	Spot Resist Stainless	metal bar wand kit - srs
195362BL	5.55	Matte Black	deck gasket bl
195363BG	140.10	Brushed Gold	kitchen pulldown spout kit bg
195363NL	114.05	Polished Nickel	kitchen pulldown spout kit nl
195363ORB	85.10	Oil Rubbed Bronze	kitchen pulldown spout kit orb
195363SRS	80.05	Spot Resist Stainless	kitchen pulldown spout kit srs
195365BG	43.95	Brushed Gold	bar pulldown spout kit bg
195365BL	76.00	Matte Black	bar pulldown spout kit bl
195365NL	25.60	Polished Nickel	bar pulldown spout kit nl
195365ORB	21.35	Oil Rubbed Bronze	bar pulldown spout kit orb
195365SRS	19.85	Spot Resist Stainless	bar pulldown spout kit srs
195367BG	77.50	Brushed Gold	finished handle cap bg
195367BL	31.55	Matte Black	finished handle cap bl
195367NL	43.85	Polished Nickel	finished handle cap nl
195367ORB	38.75	Oil Rubbed Bronze	finished handle cap orb
195367SRS	35.45	Spot Resist Stainless	finished handle cap srs
195369BG	96.95	Brushed Gold	lever handle kit bg
195369BL	39.60	Matte Black	lever handle kit bl
195369NL	45.65	Polished Nickel	lever handle kit nl
195369ORB	44.15	Oil Rubbed Bronze	lever handle kit orb
195369SRS	38.55	Spot Resist Stainless	lever handle kit srs

Moen Genuine Parts

Listed in numerical order

Part Number	List	Finish	Description
195370BG	45.55	Brushed Gold	kitchen pulldown metal wand kit bg
195370BL	91.80	Matte Black	kitchen pulldown metal wand kit bl
195370NL	28.70	Polished Nickel	kitchen pulldown metal wand kit nl
195370ORB	25.10	Oil Rubbed Bronze	kitchen pulldown metal wand kit orb
195370SRS	22.10	Spot Resist Stainless	kitchen pulldown metal wand kit srs
195383BG	35.90	Brushed Gold	bar pulldown metal wand kit bg
195383BL	73.15	Matte Black	bar pulldown metal wand kit bl
195383NL	26.25	Polished Nickel	bar pulldown metal wand kit nl
195383ORB	21.20	Oil Rubbed Bronze	bar pulldown metal wand kit orb
195383SRS	18.10	Spot Resist Stainless	bar pulldown metal wand kit srs
195709BL	87.00	Matte Black	hand shower cradle bl
195709BN	79.05	Brushed Nickel	hand shower cradle bn
195710BL	127.40	Matte Black	handle kit bl
195710BN	115.80	Brushed Nickel	handle kit bn
195711BL	69.25	Matte Black	diverter knob kit bl
195711BN	63.00	Brushed Nickel	diverter knob kit bn
195712BL	231.05	Matte Black	diverter kit bl
195712BN	210.05	Brushed Nickel	diverter kit bn
196252BN	92.85	Brushed Nickel	lever handle kit bn
196252NL	92.85	Polished Nickel	lever handle kit nl
196252ORB	102.20	Oil Rubbed Bronze	lever handle kit orb
196253BN	114.40	Brushed Nickel	cross handle kit bn
196253NL	114.40	Polished Nickel	cross handle kit nl
196253ORB	125.90	Oil Rubbed Bronze	cross handle kit orb
196267BN	66.30	Brushed Nickel	handle kit bn
196268BN	259.95	Brushed Nickel	spout kit bn
196269BN	244.40	Brushed Nickel	spout kit bn
196270BN	551.90	Brushed Nickel	spout kit bn
196271BN	463.95	Brushed Nickel	spout kit bn
196445BG	74.35	Brushed Gold	handshower cradle kit, bg
196445BL	81.90	Matte Black	handshower cradle kit, bl
196445BN	74.35	Brushed Nickel	handshower cradle kit, bn
196446BN	68.10	Brushed Nickel	handshower cradle kit, bn
196447BN	79.15	Oil Rubbed Bronze	handshower cradle kit, bn
196447NL	79.15	Oil Rubbed Bronze	handshower cradle kit, nl
196447ORB	87.10	Oil Rubbed Bronze	handshower cradle kit, orb
196448BN	66.35	Oil Rubbed Bronze	handshower cradle kit, bn
196448NL	66.35	Oil Rubbed Bronze	handshower cradle kit, nl
196448ORB	73.05	Oil Rubbed Bronze	handshower cradle kit, orb
196449BG	102.35	Brushed Gold	handle kit, bg
196449BL	112.60	Matte Black	handle kit, bl
196449BN	102.35	Brushed Nickel	handle kit, bn
196450BN	105.15	Brushed Nickel	handle kit, bn
196451BN	116.90	Brushed Nickel	handle kit, bn
196451NL	116.90	Polished Nickel	handle kit, nl
196451ORB	128.35	Oil Rubbed Bronze	handle kit, orb
196452BG	51.25	Brushed Gold	diverter knob kit, bg
196452BL	56.40	Matte Black	diverter knob kit, bl
196452BN	51.25	Brushed Nickel	diverter knob kit, bn
196453BG	208.75	Brushed Gold	diverter kit, bg
196453BL	229.60	Matte Black	diverter kit, bl
196453BN	208.75	Brushed Nickel	diverter kit, bn
196454BN	53.75	Chrome	diverter knob kit, bn
196455BN	226.80	Brushed Nickel	diverter kit, bn
196456BN	48.90	Brushed Nickel	diverter knob kit, bn
196456NL	48.90	Polished Nickel	diverter knob kit, nl
196456ORB	53.80	Oil Rubbed Bronze	diverter knob kit, orb
196457BN	227.05	Brushed Nickel	diverter kit, bn
196457NL	227.05	Polished Nickel	diverter kit, nl
196457ORB	249.80	Oil Rubbed Bronze	diverter kit, orb
196458BG	62.65	Brushed Gold	diverter knob kit bg

Part Number	List	Finish	Description
196458BN	52.60	Brushed Nickel	diverter knob kit, bn
196458NL	52.60	Polished Nickel	diverter knob kit, nl
196458ORB	57.85	Oil Rubbed Bronze	diverter knob kit, orb
196459BG	228.80	Brushed Gold	diverter kit bg
196459BN	229.35	Brushed Nickel	diverter kit, bn
196459NL	229.35	Polished Nickel	diverter kit, nl
196459ORB	252.30	Oil Rubbed Bronze	diverter kit, orb
197583BG	41.35	Brushed Gold	handle lever, screw & plug bg
197583BN	41.35	Brushed Nickel	handle lever, screw & plug bn
197583NL	41.35	Polished Nickel	handle lever, screw & plug nl
197584BG	32.05	Brushed Gold	ws lift rod kit bg
197584BN	32.05	Brushed Nickel	ws lift rod kit bn
197584NL	32.05	Polished Nickel	ws lift rod kit nl
197586BG	87.55	Brushed Gold	lever handle kit bg
197586BN	87.55	Brushed Nickel	lever handle kit bn
197586NL	87.55	Polished Nickel	lever handle kit nl
197587BG	114.40	Brushed Gold	cross handle kit bg
197587BN	114.40	Brushed Nickel	cross handle kit bn
197587NL	114.40	Polished Nickel	cross handle kit nl
197588BG	443.85	Brushed Gold	rt spout kit bg
197588BN	443.85	Brushed Nickel	rt spout kit bn
197588NL	443.85	Polished Nickel	rt spout kit nl
197589BG	46.15	Brushed Gold	rt lift rod kit bg
197589BN	46.15	Brushed Nickel	rt lift rod kit bn
197589NL	46.15	Polished Nickel	rt lift rod kit nl
197590BG	455.40	Brushed Gold	4h rt spout kit bg
197590BN	455.40	Brushed Nickel	4h rt spout kit bn
197590NL	455.40	Polished Nickel	4h rt spout kit nl
197591BG	106.00	Brushed Gold	shower escutcheon kit bg
197591BN	106.00	Brushed Nickel	shower escutcheon kit bn
197591NL	106.00	Polished Nickel	shower escutcheon kit nl
197592BG	111.40	Brushed Gold	posi handle kit bg
197592BN	111.40	Brushed Nickel	posi handle kit bn
197592NL	111.40	Polished Nickel	posi handle kit nl
197593BG	113.25	Brushed Gold	moentrol handle kit bg
197593BN	113.25	Brushed Nickel	moentrol handle kit bn
197593NL	113.25	Polished Nickel	moentrol handle kit nl
197594BG	134.80	Brushed Gold	thermostatic handle kit bg
197594BN	134.80	Brushed Nickel	thermostatic handle kit bn
197594NL	134.80	Polished Nickel	thermostatic handle kit nl
197595BG	133.45	Brushed Gold	volume handle kit bg
197595BN	133.45	Brushed Nickel	volume handle kit bn
197595NL	133.45	Polished Nickel	volume handle kit nl
197596BG	74.75	Brushed Gold	2/3f tv escutcheon bg
197596BN	74.75	Brushed Nickel	2/3f tv escutcheon bn
197596NL	74.75	Polished Nickel	2/3f tv escutcheon nl
197597BG	109.90	Brushed Gold	2/3f tv handle assembly bg
197597NL	109.90	Polished Nickel	2/3f tv handle assembly nl
197598BN	75.30	Brushed Nickel	3f tv escutcheon bn
197599BG	103.40	Brushed Gold	3f tv handle assembly bg
197599BN	103.40	Brushed Nickel	3f tv handle assembly bn
197599NL	103.40	Polished Nickel	3f tv handle assembly nl
197600BG	89.65	Brushed Gold	handshower cradle kit bg
197600BN	89.65	Brushed Nickel	handshower cradle kit bn
197600NL	89.65	Polished Nickel	handshower cradle kit nl
197601BG	113.30	Brushed Gold	tubfiller handle kit bg
197601BN	113.30	Brushed Nickel	tubfiller handle kit bn
197601NL	113.30	Polished Nickel	tubfiller handle kit nl
197869BL	421.85	Matte Black	spout kit bl
197869SRS	440.00	Spot Resist Stainless	spout kit srs
197870BL	440.40	Black	spout kit bl
197870SRS	454.30	Spot Resist Stainless	spout kit srs
197872BL	36.30	Matte Black	handle kit bl
197872BLBG	142.45	Matte Black/Brushed Gold	handle kit, bl/bg

Moen Genuine Parts

Listed in numerical order

Part Number	List	Finish	Description	Part Number	List	Finish	Description
197872BLSRS	142.45	Matte Black/Spot Resist Stainless	handle kit, bl/srs	197950BN	51.05	Brushed Nickel	handle hub bn
197872CHBL	115.30	Chrome/Matte Black	handle kit, chr/bl	197950NL	51.05	Polished Nickel	handle hub nl
197872SRS	46.65	Spot Resist Stainless	handle kit srs	197950ORB	54.25	Oil Rubbed Bronze	handle hub orb
197872SRSBL	120.55	SpResist Stainless/Matte Black	handle kit, srs/bl	197951BG	44.65	Brushed Gold	handle bg
197883BG	291.90	Brushed Gold	swing arm assy bg	197951BL	47.40	Matte Black	handle bl
197883BL	239.50	Matte Black	swing arm and docking collar kit	197951BN	44.65	Brushed Nickel	handle bn
197883NL	359.00	Polished Nickel	swing arm assy nl	197951NL	44.65	Polished Nickel	handle nl
197883ORB	305.75	Oil Rubbed Bronze	swing arm assy orb	197951ORB	47.40	Oil Rubbed Bronze	handle orb
197883SRS	222.20	Spot Resist Stainless	swing arm and docking collar kit	197952BL	43.15	Matte Black	handle bl
197884BG	147.70	Brushed Gold	spring & docking collar bg	197952BN	40.60	Brushed Nickel	handle bn
197884BL	164.65	Matte Black	spring & docking collar bl	198018BL	56.05	Matte Black	slider bl
197884NL	147.70	Polished Nickel	spring & docking collar nl	198018BN	52.80	Brushed Nickel	slider bn
197884ORB	177.15	Oil Rubbed Bronze	spring & docking collar orb	198019BL	13.55	Matte Black	plug button bl
197884SRS	100.45	Spot Resist Stainless	spring & docking collar srs	198019BN	12.80	Brushed Nickel	plug button bn
197931BL	175.20	Matte Black	escutcheon bl	198027BL	45.90	Matte Black	diverter valve escut, bl
197931BN	165.00	Brushed Nickel	escutcheon bn	198027BN	41.70	Brushed Nickel	diverter valve escut, bn
197932BG	134.10	Brushed Gold	escutcheon bg	198027ORB	45.10	Oil Rubbed Bronze	diverter valve escut, orb
197932BL	142.40	Matte Black	escutcheon bl	198029BN	74.85	Brushed Nickel	diverter valve escut, bn
197932BN	134.10	Brushed Nickel	escutcheon bn	198031BL	74.00	Matte Black	diverter wall escutcheon, bl
197933BN	169.25	Brushed Nickel	escutcheon bn	198031BN	71.00	Brushed Nickel	diverter valve escut, bn
197934BL	201.60	Matte Black	escutcheon kit	198032BL	75.30	Matte Black	diverter wall escutcheon, bl
197934BN	117.00	Brushed Nickel	escutcheon bn	198032BN	60.55	Brushed Nickel	diverter valve escut, bn
197934NL	117.00	Polished Nickel	escutcheon nl	198033BG	62.40	Brushed Gold	diverter valve escut bg
197934ORB	128.65	Oil Rubbed Bronze	escutcheon orb	198033BN	62.40	Brushed Nickel	diverter valve escut, bn
197935BG	126.80	Brushed Gold	escutcheon bg	198033NL	62.40	Polished Nickel	diverter valve escut, nl
197935BN	126.80	Brushed Nickel	escutcheon bn	198033ORB	68.70	Oil Rubbed Bronze	diverter valve escut, orb
197935NL	126.80	Polished Nickel	escutcheon nl	198036BG	103.20	Brushed Gold	3f tv escutcheon kit bg
197935ORB	139.55	Oil Rubbed Bronze	escutcheon orb	198036BL	113.65	Matte Black	3f tv escutcheon kit, bl
197936BN	133.90	Brushed Nickel	escutcheon bn	198036BN	103.20	Brushed Nickel	3f tv escutcheon kit, bn
197936NL	133.90	Polished Nickel	escutcheon nl	198036NL	103.20	Polished Nickel	3f tv escutcheon kit, nl
197936ORB	147.25	Oil Rubbed Bronze	escutcheon orb	198036ORB	113.65	Oil Rubbed Bronze	3f tv escutcheon kit, orb
197937BN	161.55	Brushed Nickel	escutcheon bn	198038BG	136.00	Brushed Gold	escutcheon kit bg
197939BL	177.00	Matte Black	escutcheon bl	198038BL	149.65	Matte Black	moentrol escutcheon kit, bl
197939BN	166.65	Brushed Nickel	escutcheon bn	198038BN	136.00	Brushed Nickel	shower escutcheon kit, bn
197940BG	166.65	Brushed Gold	escutcheon bg	198038NL	136.00	Polished Nickel	shower escutcheon kit, nl
197940BL	1380.60	Matte Black	escutcheon bl	198038ORB	149.65	Oil Rubbed Bronze	shower escutcheon kit, orb
197940BN	166.65	Brushed Nickel	escutcheon bn	198040BG	75.00	Brushed Gold	handle escutcheon kit bg
197940NL	166.65	Polished Nickel	escutcheon nl	198040BL	82.45	Matte Black	handle hub escutcheon kit, bl
197940ORB	177.00	Oil Rubbed Bronze	escutcheon orb	198040BN	75.00	Brushed Nickel	handle hub escutcheon kit, bn
197941BL	127.50	Matte Black	escutcheon bl	198040NL	75.00	Polished Nickel	handle hub escutcheon kit, nl
197941BN	120.00	Brushed Nickel	escutcheon bn	198040ORB	82.45	Oil Rubbed Bronze	handle hub escutcheon kit, orb
197942BL	46.05	Matte Black	handle bl	198107BL	31.00	Matte Black	two piece lift rod kit, bl
197942BN	43.45	Brushed Nickel	handle bn	198107BN	34.10	Polished Nickel	two piece lift rod kit, bn
197943BG	38.25	Brushed Gold	handle bg	198279BG	71.40	Brushed Gold	wand kit, bg
197943BL	40.65	Matte Black	handle bl	198279BLS	184.30	Black Stainless	wand kit bls
197943BN	38.25	Brushed Nickel	handle bn	198279ORB	184.15	Oil Rubbed Bronze	wand kit, orb
197944BL	44.85	Matte Black	handle bl	198279SRS	123.60	Spot Resist Stainless	wand kit srs
197944BN	42.15	Brushed Nickel	handle bn	198280BL	154.80	Matte Black	wand kit bl
197945BN	41.50	Chrome	handle bn	198280SRS	126.50	Spot Resist Stainless	wand kit srs
197945NL	41.50	Polished Nickel	handle nl	198288BL	193.00	Matte Black	spout kit bl
197945ORB	44.05	Brushed Nickel	handle orb	198288SRS	98.55	Spot Resist Stainless	spout kit srs
197946BG	42.95	Brushed Gold	handle bg	198289BL	51.90	Matte Black	handle kit bl
197946BN	42.95	Brushed Nickel	handle bn	198289SRS	28.20	Spot Resist Stainless	handle kit srs
197946NL	42.95	Polished Nickel	handle nl	198880ORB	89.60	Oil Rubbed Bronze	2h kitchen h/c handle orb
197946ORB	45.55	Oil Rubbed Bronze	handle orb	198880SRS	59.80	Spot Resist Stainless	2h kitchen h/c handle srs
197947BN	47.10	Brushed Nickel	handle bn	198881ORB	97.20	Oil Rubbed Bronze	esc kit orb
197947NL	47.10	Polished Nickel	handle nl	198881SRS	55.30	Spot Resist Stainless	esc kit srs
197947ORB	50.10	Oil Rubbed Bronze	handle orb	198921BL	95.10	Matte Black	wand kit, bl
197948BN	51.45	Brushed Nickel	handle bn	198921BLS	136.00	Black/Stainless Steel	wand kit, bls
197949BL	50.50	Matte Black	handle bl	198921ORB	124.05	Oil Rubbed Bronze	wand kit, orb
197949BN	47.55	Brushed Nickel	handle bn	198921SRS	105.95	Spot Resist Stainless	wand kit, srs
197950BG	51.05	Brushed Gold	handle hub bg	198922BL	189.35	Matte Black	spout kit, bl
197950BL	54.25	Matte Black	handle hub bl	198922SRS	150.45	Spot Resist Stainless	spout kit, srs
				198923BL	104.00	Matte Black	handle kit, bl

Moen Genuine Parts

Listed in numerical order

Part Number	List	Finish	Description
198923BLS	155.40	Black/Stainless Steel	handle kit, bls
198923SRS	75.15	Spot Resist Stainless	handle kit, srs
198925BL	18.55	Matte Black	receptor assy kit, bl
198925SRS	18.10	Spot Resist Stainless	receptor assy kit, srs
199097BL	135.65	Matte Black	spring & bearing kit bl
199097BLS	206.75	Black/Stainless Steel	spring & bearing kit srs
199097SRS	103.15	Spot Resist Stainless	spring & bearing kit srs
199098BL	130.90	Matte Black	swing arm & collar kit bl
199098BLS	242.45	Black/Stainless Steel	swing arm & collar kit bls
199098SRS	111.20	Spot Resist Stainless	swing arm & collar kit srs
199106BL	51.50	Matte Black	reflex hose kit, bl
199477SRN	301.55	Spot Resist Brushed Nickel	non diverting rt spout kit srm
199490BL	358.95	Matte Black	roman tub spout bl
199490BN	423.85	Brushed Nickel	roman tub spout bn
200001BN	570.80	Brushed Nickel	arris spout bn
200014BG	100.00	Brushed Gold	wand kit
200014BL	76.50	Matte Black	wand kit bl
200014BLS	88.35	Black Stainless	wand kit bls
200014SRS	76.50	Spot Resist Stainless	wand kit srs
200101BN	0.40	Brushed Nickel	plug button kit, bn
200714BN	39.70	Brushed Nickel	handle kit, bn
200714ORB	43.65	Oil Rubbed Bronze	handle kit, orb
200715BN	56.15	Brushed Nickel	M-CORE diverter escutcheon kit, bn
200715ORB	68.40	Oil Rubbed Bronze	M-CORE diverter escutcheon kit, orb
200716BN	41.90	Brushed Nickel	handle kit, bn
200716ORB	46.10	Oil Rubbed Bronze	handle kit, orb
200717BN	60.95	Brushed Nickel	M-CORE diverter escutcheon kit, bn
200717ORB	73.80	Oil Rubbed Bronze	M-CORE diverter escutcheon kit, orb
200718BL	48.05	Matte Black	handle kit, bl
200718BN	43.65	Brushed Nickel	handle kit, bn
200718ORB	48.05	Oil Rubbed Bronze	handle kit, orb
200719BN	60.95	Brushed Nickel	M-CORE diverter escutcheon kit, bn
200720BRB	55.45	Mediterranean Bronze	handle kit, brb
200720SRN	50.40	Spot Resist Brushed Nickel	handle kit, srm
200721BRB	163.50	Mediterranean Bronze	M-CORE diverter escutcheon kit, brb
200721SRN	118.15	Spot Resist Brushed Nickel	M-CORE diverter escutcheon kit, srm
200722BL	43.55	Matte Black	handle kit, bl
200722BN	39.60	Brushed Nickel	handle kit, bn
200723BL	67.40	Matte Black	M-CORE diverter escutcheon kit, bl
200723BN	56.15	Brushed Nickel	M-CORE diverter escutcheon kit, bn
200724BL	43.90	Matte Black	handle kit, bl
200724BN	39.95	Brushed Nickel	handle kit, bn
200726BL	46.10	Matte Black	handle kit, bl
200726BN	40.85	Brushed Nickel	handle kit, bn
200727BL	53.90	Matte Black	M-CORE diverter escutcheon kit, bl
200727BN	53.45	Brushed Nickel	M-CORE diverter escutcheon kit kit, bn
200728BL	43.10	Matte Black	handle kit, bl
200728BN	39.15	Brushed Nickel	handle kit, bn
200729BL	59.05	Matte Black	M-CORE diverter escutcheon kit kit, bl
200729BN	52.85	Brushed Nickel	M-CORE diverter escutcheon kit kit, bn
200730BG	30.35	Brushed Gold	handle kit, bg
200730BL	33.45	Matte Black	handle kit, bl
200730BN	30.35	Brushed Nickel	handle kit, bn
200731BG	35.00	Brushed Gold	M-CORE diverter escutcheon kit kit, bg
200731BL	38.50	Matte Black	M-CORE diverter escutcheon kit kit, bl

Part Number	List	Finish	Description
200731BN	35.00	Brushed Nickel	M-CORE diverter escutcheon kit kit, bn
200732BN	47.65	Brushed Nickel	handle kit, bn
200732NL	47.65	Polished Nickel	handle kit, nl
200732ORB	52.50	Oil Rubbed Bronze	handle kit, orb
200733BL	53.90	Matte Black	M-CORE diverter escutcheon kit, bl
200733BN	47.80	Brushed Nickel	M-CORE diverter escutcheon kit kit, sl
200733NL	47.80	Polished Nickel	M-CORE diverter escutcheon kit kit, nl
200733ORB	53.90	Oil Rubbed Bronze	M-CORE diverter escutcheon kit kit, orb
200734BN	43.55	Brushed Nickel	handle kit, bn
200734NL	43.55	Polished Nickel	handle kit, nl
200734ORB	47.90	Oil Rubbed Bronze	handle kit, orb
200735BN	48.95	Brushed Nickel	M-CORE diverter escutcheon kit kit, sl
200735NL	48.95	Polished Nickel	M-CORE diverter escutcheon kit kit, nl
200735ORB	53.90	Oil Rubbed Bronze	M-CORE diverter escutcheon kit kit, orb
200736BG	49.05	Brushed Gold	handle kit, bg
200736BN	49.05	Brushed Nickel	handle kit, bn
200736NL	49.05	Polished Nickel	handle kit, nl
200736ORB	54.00	Oil Rubbed Bronze	handle kit, orb
200737BG	51.05	Brushed Gold	M-CORE diverter escutcheon kit kit, bg
200737BN	51.05	Brushed Nickel	M-CORE diverter escutcheon kit kit, sl
200737NL	51.05	Polished Nickel	M-CORE diverter escutcheon kit kit, nl
200737ORB	56.15	Oil Rubbed Bronze	M-CORE diverter escutcheon kit kit, orb
200740BL	45.45	Matte Black	handle kit, bl
200740BN	41.35	Brushed Nickel	handle kit, bn
200741BL	70.20	Matte Black	M-CORE diverter escutcheon kit kit, bl
200741BN	63.80	Brushed Nickel	M-CORE diverter escutcheon kit kit, bn
200742BG	45.00	Brushed Gold	handle kit, bg
200742BL	49.40	Matte Black	handle kit, bl
200742BN	45.00	Brushed Nickel	handle kit, bn
200742NL	45.00	Polished Nickel	handle kit, nl
200742ORB	49.40	Oil Rubbed Bronze	handle kit, orb
200743BG	43.00	Brushed Gold	M-CORE diverter escutcheon kit kit, bg
200743BL	47.35	Matte Black	M-CORE diverter escutcheon kit kit, bl
200743BN	43.00	Brushed Nickel	M-CORE diverter escutcheon kit kit, bn
200743NL	43.00	Polished Nickel	M-CORE diverter escutcheon kit kit, nl
200743ORB	47.35	Oil Rubbed Bronze	M-CORE diverter escutcheon kit kit, orb
200744BN	39.15	Brushed Nickel	handle kit, bn
200745BN	42.15	Brushed Nickel	M-CORE diverter escutcheon kit, bn
200746BG	46.95	Brushed Gold	handle kit, bg
200746BN	46.95	Brushed Nickel	handle kit, bn
200746NL	46.95	Polished Nickel	handle kit, nl
200747BG	40.50	Brushed Gold	M-CORE diverter escutcheon kit kit, bg
200747BN	40.50	Brushed Nickel	M-CORE diverter escutcheon kit kit, bn
200747NL	40.50	Polished Nickel	M-CORE diverter escutcheon kit kit, nl
200748BL	42.70	Matte Black	handle kit, bl
200748BN	38.85	Brushed Nickel	handle kit, bn
200749BL	46.10	Matte Black	M-CORE diverter escutcheon kit, bl
200749BN	41.90	Brushed Nickel	M-CORE diverter escutcheon kit, bn
200750BG	41.35	Brushed Gold	handle kit, bg
200750BL	45.45	Matte Black	handle kit, bl
200750BN	41.35	Brushed Nickel	handle kit, bn

Moen Genuine Parts

Listed in numerical order

Part Number	List	Finish	Description	Part Number	List	Finish	Description
200755ORB	82.50	Oil Rubbed Bronze	M-CORE ext kit, round modern, orb	200796BN	60.05	Brushed Nickel	M-CORE handle kit, bn
200775BG	19.80	Brushed Gold	M-CORE sleeve kit, round modern, bg	200796NL	60.05	Polished Nickel	M-CORE handle kit, nl
200775BL	21.80	Matte Black	M-CORE sleeve kit, round modern, bl	200796ORB	66.05	Oil Rubbed Bronze	M-CORE handle kit, orb
200775BN	19.80	Brushed Nickel	M-CORE sleeve kit, round modern, bn	200797BG	88.55	Brushed Gold	M-CORE escutcheon kit, bg
200775NL	19.80	Polished Nickel	M-CORE sleeve kit, round modern, nl	200797BL	97.35	Matte Black	M-CORE escutcheon kit, bl
200775ORB	21.05	Oil Rubbed Bronze	M-CORE sleeve kit, round modern, orb	200797BN	88.55	Brushed Nickel	M-CORE escutcheon kit, bn
200776BC	19.15	Brushed Chrome	M-CORE sleeve kit, round traditional, bc	200797NL	88.55	Polished Nickel	M-CORE escutcheon kit, nl
200776BG	18.15	Brushed Gold	M-CORE sleeve kit, round traditional, bg	200797ORB	97.35	Oil Rubbed Bronze	M-CORE escutcheon kit, orb
200776BL	19.90	Matte Black	M-CORE sleeve kit, round traditional, bl	200798BN	38.70	Brushed Nickel	M-CORE handle kit, bn
200776BN	18.15	Brushed Nickel	M-CORE sleeve kit, round traditional, bn	200799BN	56.75	Brushed Nickel	M-CORE escutcheon kit, bn
200776NL	18.15	Polished Nickel	M-CORE sleeve kit, round traditional, nl	200800BG	39.40	Brushed Gold	M-CORE handle kit, bg
200776ORB	19.90	Oil Rubbed Bronze	M-CORE sleeve kit, round traditional, orb	200800BL	43.45	Matte Black	M-CORE handle kit, bl
200777BN	20.70	Brushed Nickel	M-CORE sleeve kit, square, bn	200800BN	39.40	Brushed Nickel	M-CORE handle kit, bn
200778BG	20.70	Brushed Gold	M-CORE sleeve kit, voss, bg	200801BG	82.50	Brushed Gold	M-CORE escutcheon kit, bg
200778BN	20.70	Brushed Nickel	M-CORE sleeve kit, voss, bn	200801BL	90.80	Matte Black	M-CORE escutcheon kit, bl
200778NL	20.70	Polished Nickel	M-CORE sleeve kit, voss, nl	200801BN	82.50	Brushed Nickel	M-CORE escutcheon kit, bn
200778ORB	22.85	Oil Rubbed Bronze	M-CORE sleeve kit, voss, orb	200802BG	43.65	Brushed Gold	M-CORE handle kit, bg
200782BG	37.00	Brushed Gold	M-CORE handle kit, bg	200802BN	43.65	Brushed Nickel	M-CORE handle kit, bn
200782BL	40.60	Matte Black	M-CORE handle kit, bl	200802NL	43.65	Polished Nickel	M-CORE handle kit, nl
200782BN	37.00	Brushed Nickel	M-CORE handle kit, bn	200803BG	88.55	Brushed Gold	M-CORE escutcheon kit, bg
200783BG	72.60	Brushed Gold	M-CORE escutcheon kit, bg	200803BN	88.55	Brushed Nickel	M-CORE escutcheon kit, bn
200783BL	79.95	Matte Black	M-CORE escutcheon kit, bl	200803NL	88.55	Polished Nickel	M-CORE escutcheon kit, nl
200783BN	72.60	Brushed Nickel	M-CORE escutcheon kit, bn	200806BL	52.95	Matte Black	M-CORE handle kit, bl
200783CBN	72.65	Classic Brushed Nickel	M-CORE escutcheon kit, cbn	200806BN	48.15	Brushed Nickel	M-CORE handle kit, bn
200784BN	58.50	Brushed Nickel	M-CORE handle kit, bn	200807BL	109.80	Matte Black	M-CORE escutcheon kit, bl
200784NL	58.50	Polished Nickel	M-CORE handle kit, nl	200807BN	99.80	Brushed Nickel	M-CORE escutcheon kit, bn
200784ORB	64.35	Oil Rubbed Bronze	M-CORE handle kit, orb	200808BG	45.45	Brushed Gold	M-CORE escutcheon kit, bg
200785BN	71.70	Brushed Nickel	M-CORE escutcheon kit, bn	200808BL	50.05	Matte Black	M-CORE escutcheon kit, bl
200785NL	71.70	Polished Nickel	M-CORE escutcheon kit, nl	200808BN	45.45	Brushed Nickel	M-CORE escutcheon kit, bn
200785ORB	78.90	Oil Rubbed Bronze	M-CORE escutcheon kit, orb	200809BG	101.85	Brushed Gold	M-CORE escutcheon kit, bg
200786BG	41.55	Brushed Gold	M-CORE handle kit, bg	200809BL	112.10	Matte Black	M-CORE escutcheon kit, bl
200786BL	69.70	Matte Black	handle kit	200809BN	101.85	Brushed Nickel	M-CORE escutcheon kit, bn
200786BN	41.55	Brushed Nickel	M-CORE handle kit, bn	200810BN	119.05	Brushed Nickel	M-CORE escutcheon kit, bn
200786NL	41.55	Polished Nickel	M-CORE handle kit, nl	200810NL	119.05	Polished Nickel	M-CORE escutcheon kit, nl
200786ORB	45.65	Oil Rubbed Bronze	M-CORE handle kit, orb	200810ORB	130.90	Oil Rubbed Bronze	M-CORE escutcheon kit, orb
200787BG	48.50	Brushed Gold	M-CORE escutcheon kit, bg	200811BG	61.90	Brushed Gold	M-CORE escutcheon kit, bg
200787BL	102.30	Matte Black	escutcheon kit	200811BL	121.30	Matte Black	escutcheon kit
200787BN	48.50	Brushed Nickel	M-CORE escutcheon kit, bn	200811BN	61.90	Brushed Nickel	M-CORE escutcheon kit, bn
200787NL	48.50	Polished Nickel	M-CORE escutcheon kit, nl	200811NL	61.90	Polished Nickel	M-CORE escutcheon kit, nl
200787ORB	53.35	Oil Rubbed Bronze	M-CORE escutcheon kit, orb	200811ORB	68.20	Oil Rubbed Bronze	M-CORE escutcheon kit, orb
200788BN	43.55	Brushed Nickel	M-CORE handle kit, bn	200812BN	124.45	Brushed Nickel	M-CORE escutcheon kit, bn
200788NL	43.55	Polished Nickel	M-CORE handle kit, nl	200812NL	124.45	Polished Nickel	M-CORE escutcheon kit, nl
200788ORB	47.90	Oil Rubbed Bronze	M-CORE handle kit, orb	200812ORB	136.90	Oil Rubbed Bronze	M-CORE escutcheon kit, orb
200789BN	65.45	Brushed Nickel	M-CORE escutcheon kit, bn	200813BG	162.35	Brushed Gold	M-CORE escutcheon kit, bg
200789NL	65.45	Polished Nickel	M-CORE escutcheon kit, nl	200813BN	162.35	Brushed Nickel	M-CORE escutcheon kit, bn
200789ORB	72.05	Oil Rubbed Bronze	M-CORE escutcheon kit, orb	200813NL	162.35	Polished Nickel	M-CORE escutcheon kit, nl
200790CBN	59.20	Classic Brushed Nickel	M-CORE handle kit, cbn	200814BL	145.85	Matte Black	M-CORE escutcheon kit, bl
200791BC	43.65	Brushed Chrome	handle, bc	200814BN	132.55	Brushed Nickel	M-CORE escutcheon kit, bn
200792BL	48.85	Matte Black	M-CORE handle kit, bl	200816BL	114.65	Matte Black	M-CORE escutcheon kit, bl
200792BN	44.35	Brushed Nickel	M-CORE handle kit, bn	200816BN	104.20	Brushed Nickel	M-CORE escutcheon kit, bn
200793BL	97.45	Matte Black	M-CORE escutcheon kit, bl	200817BG	156.55	Brushed Gold	M-CORE escutcheon kit, bg
200793BN	88.65	Brushed Nickel	M-CORE escutcheon kit, bn	200817BL	172.20	Matte Black	M-CORE escutcheon kit, bl
200794BL	44.90	Matte Black	M-CORE handle kit, bl	200817BN	156.55	Brushed Nickel	M-CORE escutcheon kit, bn
200794BN	40.70	Brushed Nickel	M-CORE handle kit, bn	200817NL	156.55	Polished Nickel	M-CORE escutcheon kit, nl
200795BL	72.05	Matte Black	M-CORE escutcheon kit, bl	200817ORB	172.20	Oil Rubbed Bronze	M-CORE escutcheon kit, orb
200795BN	65.45	Brushed Nickel	M-CORE escutcheon kit, bn	200818BN	59.40	Brushed Nickel	M-CORE escutcheon kit, bn
200796BG	60.05	Brushed Gold	M-CORE handle kit, bg	200819BG	98.10	Brushed Gold	M-CORE escutcheon kit, bg
200796BL	66.05	Matte Black	M-CORE handle kit, bl	200819BL	107.90	Matte Black	M-CORE escutcheon kit, bl
				200819BN	98.10	Brushed Nickel	M-CORE escutcheon kit, bn
				200820BG	48.15	Brushed Gold	M-CORE handle hub kit, bg
				200820BN	48.15	Brushed Nickel	M-CORE handle hub kit, bn
				200820NL	48.15	Polished Nickel	M-CORE handle hub kit, nl
				200820ORB	52.95	Oil Rubbed Bronze	M-CORE handle hub kit, orb
				200821BN	48.60	Brushed Nickel	M-CORE handle hub kit, bn

Moen Genuine Parts

Listed in numerical order

Part Number	List	Finish	Description
201203BG	95.45	Brushed Gold	colinet lvr hdl kit bg
201203BL	104.95	Matte Black	colinet lvr hdl kit bl
201203BN	95.45	Brushed Nickel	colinet lvr hdl kit bn
201204BG	96.00	Brushed Gold	colinet cross hdl kit bg
201204BL	105.60	Matte Black	colinet cross hdl kit bl
201204BN	96.00	Brushed Nickel	colinet cross hdl kit bn
201205BG	314.50	Brushed Gold	colinet wlmnt lav spt kit bg
201205BL	346.05	Matte Black	colinet wlmnt lav spt kit bl
201205BN	314.50	Brushed Nickel	colinet wlmnt lav spt kit bn
201206BG	68.75	Brushed Gold	ws lift rod kit bg
201206BL	75.65	Matte Black	ws lift rod kit bl
201206BN	68.75	Brushed Nickel	ws lift rod kit bn
201208BG	599.90	Brushed Gold	rt spout kit bg
201208BL	659.95	Matte Black	rt spout kit bl
201208BN	599.90	Brushed Nickel	rt spout kit bn
201209BG	650.70	Brushed Gold	4h rt spout kit bg
201209BL	715.85	Matte Black	4h rt spout kit bl
201209BN	650.70	Brushed Nickel	4h rt spout kit bn
201211BG	139.55	Brushed Gold	shower escutcheon kit bg
201211BL	153.45	Matte Black	shower escutcheon kit bl
201211BN	139.55	Brushed Nickel	shower escutcheon kit bn
201212BG	80.55	Brushed Gold	posi handle kit bg
201212BL	88.60	Matte Black	posi handle kit bl
201212BN	80.55	Brushed Nickel	posi handle kit bn
201213BG	141.60	Brushed Gold	thermostatic handle kit bg
201213BL	155.80	Matte Black	thermostatic handle kit bl
201213BN	141.60	Brushed Nickel	thermostatic handle kit bn
201214BG	140.05	Brushed Gold	volume handle kit bg
201214BL	154.20	Matte Black	volume handle kit bl
201214BN	140.05	Brushed Nickel	volume handle kit bn
201215BG	126.50	Brushed Gold	handshower cradle kit bg
201215BL	139.15	Matte Black	handshower cradle kit bl
201215BN	126.50	Brushed Nickel	handshower cradle kit bn
201216BG	119.55	Brushed Gold	tubfiller handle kit bg
201216BL	131.50	Matte Black	tubfiller handle kit bl
201216BN	119.55	Brushed Nickel	tubfiller handle kit bn
201217BG	63.25	Brushed Gold	diverter knob kit, bg
201217BL	69.50	Matte Black	diverter knob kit, bl
201217BN	63.25	Brushed Nickel	diverter knob kit, bn
201218BG	235.80	Brushed Gold	diverter kit, bg
201218BL	259.45	Matte Black	diverter kit, bl
201218BN	235.80	Brushed Nickel	diverter kit, bn
201300BG	597.85	Brushed Gold	faucet assembly kit - align bg
201300BL	657.65	Matte Black	faucet assembly kit - align bl
201300BLS	657.65	Black Stainless	faucet assembly kit - align bls
201300C	427.05	Chrome	faucet assembly kit - align ch
201300SRS	597.85	Spot Resist Stainless	faucet assembly kit - align srs
201301BL	605.55	Matte Black	faucet assembly kit - arbor bl
201301C	393.25	Chrome	faucet assembly kit - arbor ch
201301ORB	770.70	Oil Rubbed Bronze	faucet assembly kit - arbor orb
201301SRS	550.55	Spot Resist Stainless	faucet assembly kit - arbor srs
201302C	411.95	Chrome	faucet assembly kit - brantford ch
201302ORB	634.45	Oil Rubbed Bronze	faucet assembly kit - brantford orb
201302SRS	576.75	Spot Resist Stainless	faucet assembly kit - brantford srs
201304BL	1296.95	Matte Black	faucet assembly kit - nio bl
201304BLS	1426.60	Black/Stainless Steel	faucet assembly kit - nio bls
201304C	842.15	Chrome	faucet assembly kit - nio ch
201304SRS	1179.00	Spot Resist Stainless	faucet assembly kit - nio srs
201305BL	731.90	Matte Black	faucet assembly kit - paterson bl
201305C	475.25	Chrome	faucet assembly kit - paterson ch
201305SRS	665.40	Spot Resist Stainless	faucet assembly kit - paterson srs
201306BL	612.60	Matte Black	faucet assembly kit - sleek bl

Part Number	List	Finish	Description
201306BLS	612.60	Black/Stainless Steel	faucet assembly kit - sleek bls
201306C	397.80	Chrome	faucet assembly kit - sleek ch
201306SRS	556.90	Spot Resist Stainless	faucet assembly kit - sleek srs
201307BG	790.85	Brushed Gold	faucet assembly kit - sto bg
201307BL	869.95	Matte Black	faucet assembly kit - sto bl
201307C	564.90	Chrome	faucet assembly kit - sto ch
201307SRS	790.85	Spot Resist Stainless	faucet assembly kit - sto srs
201308BG	642.95	Brushed Gold	faucet assembly kit - weymouth bg
201308BL	653.70	Matte Black	faucet assembly kit - weymouth bl
201308C	459.30	Chrome	faucet assembly kit - weymouth ch
201308NL	642.95	Polished Nickel	faucet assembly kit - weymouth nl
201308ORB	707.30	Oil Rubbed Bronze	faucet assembly kit - weymouth orb
201308SRS	642.95	Spot Resist Stainless	faucet assembly kit - weymouth srs
201899BG	54.20	Brushed Gold	escutcheon kit bg
201899BL	59.60	Matte Black	escutcheon kit bl
201899BN	54.20	Brushed Nickel	escutcheon kit bn
201900BG	52.45	Brushed Gold	1h lav handle kit bg
201900BL	57.70	Matte Black	1h lav handle kit bl
201900BN	52.45	Brushed Nickel	1h lav handle kit bn
201901BG	207.90	Brushed Gold	2h ws spout kit bg
201901BL	228.75	Matte Black	2h ws spout kit bl
201901BN	207.90	Brushed Nickel	2h ws spout kit bn
201902BG	70.40	Brushed Gold	2h ws handle kit bg
201902BL	77.45	Matte Black	2h ws handle kit bl
201902BN	70.40	Brushed Nickel	2h ws handle kit bn
201903BG	320.85	Brushed Gold	3h rt spout kit bg
201903BL	352.90	Matte Black	3h rt spout kit bl
201903BN	320.85	Brushed Nickel	3h rt spout kit bn
201905BG	99.40	Brushed Gold	tf handle kit bg
201905BL	109.30	Matte Black	tf handle kit bl
201905BN	99.40	Brushed Nickel	tf handle kit bn
201906BG	70.40	Brushed Gold	tf hand shower cradle kit bg
201906BL	77.45	Matte Black	tf hand shower cradle kit bl
201906BN	70.40	Brushed Nickel	tf hand shower cradle kit bn
201907BG	35.80	Brushed Gold	transfer valve handle kit bg
201907BL	39.45	Matte Black	transfer valve handle kit bl
201907BN	35.80	Brushed Nickel	transfer valve handle kit bn
201908BG	40.25	Brushed Gold	control handle kit bg
201908BL	44.20	Matte Black	control handle kit bl
201908BN	40.25	Brushed Nickel	control handle kit bn
201909BG	100.20	Brushed Gold	thermostatic hdl kit bg
201909BL	110.20	Matte Black	thermostatic hdl kit bl
201909BN	100.20	Brushed Nickel	thermostatic hdl kit bn
201910BG	99.95	Brushed Gold	volume hdl kit bg
201910BL	109.95	Matte Black	volume hdl kit bl
201910BN	99.95	Brushed Nickel	volume hdl kit bn
201911BG	164.80	Brushed Gold	tub spout kit bg
201911BL	181.30	Matte Black	tub spout kit bl
201911BN	164.80	Brushed Nickel	tub spout kit bn
201912BG	61.65	Brushed Gold	shower handle kit bg
201912BL	67.80	Matte Black	shower handle kit bl
201912BN	61.65	Brushed Nickel	shower handle kit bn
201913BG	15.25	Brushed Gold	2hws hdl esct kit bg
201913BL	16.75	Matte Black	2hws hdl esct kit bl
201913BN	15.25	Brushed Nickel	2hws hdl esct kit bn
201914BG	17.40	Brushed Gold	2hws spout esct kit bg
201914BL	19.15	Matte Black	2hws spout esct kit bl
201914BN	17.40	Brushed Nickel	2hws spout esct kit bn
201915BG	17.40	Brushed Gold	3h rt hdl esct kit bg
201915BL	19.15	Matte Black	3h rt hdl esct kit bl

Moen Genuine Parts

Listed in numerical order

Part Number	List	Finish	Description	Part Number	List	Finish	Description
201915BN	17.40	Brushed Nickel	3hr t hdl esct kit bn	206292BL	50.05	Matte Black	handle, bl
201916BG	22.40	Brushed Gold	3hr rt spout esct kit bg	206292BN	45.50	Brushed Nickel	handle, bn
201916BL	24.70	Matte Black	3hr rt spout esct kit bl	206293BN	62.10	Brushed Nickel	escutcheon, bn
201916BN	22.40	Brushed Nickel	3hr rt spout esct kit bn	206294BN	33.70	Brushed Nickel	handle, bn
201991BL	199.35	Matte Black	spout kit	206295BG	69.65	Brushed Gold	escutcheon, bg
201991SRS	181.25	Spot Resist Stainless	sto spout kit	206295BL	76.60	Matte Black	escutcheon, bl
201992BL	508.40	Matte Black	spout kit	206295BN	71.65	Brushed Nickel	escutcheon, bn
201992BLS	508.40	Black/Stainless Steel	spout kit	206296BL	116.90	Matte Black	escutcheon kit
201992SRS	462.05	Spot Resist Stainless	spout kit	206296BN	68.90	Brushed Nickel	escutcheon, bn
201994BG	84.70	Matte Black	wand kit	206296NL	68.90	Polished Nickel	escutcheon, nl
201994BL	47.65	Matte Black	wand kit	206296ORB	75.95	Oil Rubbed Bronze	escutcheon, orb
201994BLS	59.40	Black/Stainless Steel	wand kit	206297BL	87.90	Matte Black	handle kit
201994SRS	53.45	Spot Resist Stainless	wand kit	206297BN	49.45	Brushed Nickel	handle, bn
204687BL	35.70	Matte Black	handle kit bl	206297NL	49.45	Polished Nickel	handle, nl
204687NL	35.15	Polished Nickel	handle kit nl	206297ORB	54.40	Oil Rubbed Bronze	handle, orb
204687SRS	34.10	Spot Resist Stainless	handle kit srs	206298BC	45.50	Brushed Chrome	escutcheon, bc
204688BL	34.05	Matte Black	handle hub	206301BN	57.85	Brushed Nickel	escutcheon, bn
204688NL	33.20	Polished Nickel	handle hub	206301ORB	63.60	Oil Rubbed Bronze	escutcheon, orb
204688SRS	32.70	Spot Resist Stainless	handle hub	206302BN	33.95	Brushed Nickel	handle, bn
204772BL	216.10	Matte Black	spout, pulldown	206302ORB	37.40	Oil Rubbed Bronze	handle, orb
204772NL	221.05	Polished Nickel	spout, pulldown	206303BG	77.05	Brushed Gold	escutcheon, bg
204772SRS	195.20	Spot Resist Stainless	spout, pulldown	206303BL	84.75	Matte Black	escutcheon, bl
204773BL	236.55	Matte Black	spout, bar	206303BN	77.05	Brushed Nickel	escutcheon, bn
204773NL	234.35	Polished Nickel	spout, bar	206304BL	84.75	Matte Black	escutcheon, bl
204773SRS	225.60	Spot Resist Stainless	spout, bar	206305BL	42.90	Matte Black	handle, bl
204774BL	859.35	Matte Black	u by moen spout	206305BN	38.95	Brushed Nickel	handle, bn
204774NL	899.90	Polished Nickel	u by moen spout	206305ORB	42.90	Oil Rubbed Bronze	handle, orb
204774SRS	837.85	Spot Resist Stainless	u by moen spout	206306BL	92.90	Matte Black	escutcheon, bl
204775BL	108.75	Matte Black	powerboost wand kit	206306BN	84.50	Brushed Nickel	escutcheon, bn
204775NL	108.75	Polished Nickel	powerboost wand kit	206307BN	70.55	Brushed Nickel	escutcheon, bn
204775SRS	112.40	Spot Resist Stainless	powerboost wand kit	206307ORB	77.55	Oil Rubbed Bronze	escutcheon, orb
204776BL	115.50	Matte Black	wand kit	206308BN	41.25	Brushed Nickel	handle, bn
204776NL	115.50	Polished Nickel	wand kit	206308ORB	45.40	Oil Rubbed Bronze	handle, orb
204776SRS	109.90	Spot Resist Stainless	wand kit	206309BG	95.65	Brushed Gold	escutcheon, bg
204777BL	107.00	Matte Black	wand kit, bar	206309BN	95.65	Brushed Nickel	escutcheon, bn
204777NL	95.90	Polished Nickel	wand kit, bar	206309NL	95.65	Polished Nickel	escutcheon, nl
204777SRS	89.90	Spot Resist Stainless	wand kit, bar	206320BL	66.20	Matte Black	escutcheon, bl
204778BL	38.50	Matte Black	handle kit, sip	206320BN	60.20	Brushed Nickel	escutcheon, bn
204778NL	39.45	Polished Nickel	handle kit, sip	206321BL	39.40	Matte Black	handle, bl
204778SRS	35.40	Spot Resist Stainless	handle kit, sip	206321BN	35.80	Brushed Nickel	handle, bn
204779BL	5.45	N/A	gasket kit	206322BL	81.45	Matte Black	escutcheon, bl
205845SRS	46.65	Spot Resist Stainless	handle kit srs	206322BN	74.05	Brushed Nickel	escutcheon, bn
205846SRS	14.25	Spot Resist Stainless	wand kit srs	206323BL	44.10	Matte Black	handle, bl
205847SRS	62.35	Spot Resist Stainless	power boost wand kit srs	206323BN	40.15	Brushed Nickel	handle, bn
205848BL	553.85	Matte Black	faucet assembly kit bl	206324BL	98.55	Matte Black	escutcheon, bl
205848ORB	583.70	Oil Rubbed Bronze	faucet assembly kit orb	206324BN	89.60	Brushed Nickel	escutcheon, bn
205848SRS	534.10	Spot Resist Stainless	faucet assembly kit srs	206328BG	95.65	Brushed Gold	escutcheon, bg
205849BL	789.85	Black	spout kit bl	206328BL	130.60	Matte Black	escutcheon kit
205849C	682.05	Chrome	spout kit chr	206328BN	95.65	Brushed Nickel	escutcheon, bn
205849ORB	827.95	Oil Rubbed Bronze	spout kit orb	206328NL	95.65	Polished Nickel	escutcheon, nl
205849SRS	745.00	Spot Resist Stainless	spout kit srs	206328ORB	104.75	Oil Rubbed Bronze	escutcheon, orb
205850SRS	65.15	Spot Resist Stainless	handle kit srs	206329BG	40.15	Brushed Gold	handle, bg
206288BG	36.55	Brushed Gold	finished h/c indicators, bg	206329BL	64.40	Matte Black	handle kit
206288BL	40.25	Matte Black	finished h/c indicators, bl	206329BN	40.15	Brushed Nickel	handle, bn
206288BN	36.55	Brushed Nickel	finished h/c indicators, bn	206329NL	40.15	Polished Nickel	handle, nl
206288NL	36.55	Polished Nickel	finished h/c indicators, nl	206329ORB	44.10	Oil Rubbed Bronze	handle, orb
206288ORB	40.25	Oil Rubbed Bronze	finished h/c indicators, orb	206330BN	95.65	Brushed Nickel	escutcheon, bn
206289BG	103.15	Brushed Gold	escutcheon, bg	206330NL	95.65	Polished Nickel	escutcheon, nl
206289BL	113.55	Matte Black	escutcheon, bl	206330ORB	104.75	Oil Rubbed Bronze	escutcheon, orb
206289BN	103.15	Brushed Nickel	escutcheon, bn	210492BG	63.05	N/A	wmft ext kit, round modern, bg
206289NL	103.15	Polished Nickel	escutcheon, nl	210492BL	72.75	N/A	wmft ext kit, round modern, bl
206289ORB	113.55	Oil Rubbed Bronze	escutcheon, orb	210492BN	50.50	N/A	wmft ext kit, round modern, bn
206291BL	120.45	Matte Black	escutcheon, bl	210492NL	50.50	N/A	wmft ext kit, round modern, nl
206291BN	109.50	Brushed Nickel	escutcheon, bn	210573BN	87.10	Brushed Nickel	wmft ext kit, sq, bn
				210574BG	86.70	Brushed Gold	wmft ext kit, soft sq, bg

Moen Genuine Parts

Listed in numerical order

Part Number	List	Finish	Description
210574BN	86.70	Brushed Nickel	wmtf ext kit, soft sq, bn
210574NL	86.70	Polished Nickel	wmtf ext kit, soft sq, nl
210574ORB	95.35	Oil Rubbed Bronze	wmtf ext kit, soft sq, orb
210575BN	47.10	Brushed Nickel	90 deg wmtf escutcheon kit, bn
210576BG	45.80	Brushed Gold	align wmtf escutcheon kit, bg
210576BL	50.40	Matte Black	align wmtf escutcheon kit, bl
210576BN	45.80	Brushed Nickel	align wmtf escutcheon kit, bn
210577BL	49.55	Matte Black	traditional wmtf escutcheon kit, bl
210577BN	45.10	Brushed Nickel	traditional wmtf escutcheon kit, bn
210577NL	45.10	Polished Nickel	traditional wmtf escutcheon kit, nl
210577ORB	49.55	Oil Rubbed Bronze	traditional wmtf escutcheon kit, orb
210578BG	45.60	Brushed Gold	cia wmtf escutcheon kit, bg
210578BL	50.20	Matte Black	cia wmtf escutcheon kit, bl
210578BN	45.60	Brushed Nickel	cia wmtf escutcheon kit, bn
210579BG	88.45	Brushed Gold	colinet wmtf escutcheon kit, bg
210579BL	97.30	Matte Black	colinet wmtf escutcheon kit, bl
210579BN	88.45	Brushed Nickel	colinet wmtf escutcheon kit, bn
210580BL	54.55	Matte Black	doux wmtf escutcheon kit, bl
210580BN	49.55	Brushed Nickel	doux wmtf escutcheon kit, bn
210581BG	86.50	Brushed Gold	flara wmtf escutcheon kit, bg
210581BN	86.50	Brushed Nickel	flara wmtf escutcheon kit, bn
210581NL	86.50	Polished Nickel	flara wmtf escutcheon kit, nl
210582BL	52.65	Matte Black	genta wmtf escutcheon kit, bl
210582BN	47.85	Brushed Nickel	genta wmtf escutcheon kit, bn
210583BL	44.90	Matte Black	gibson wmtf escutcheon kit, bl
210583BN	40.80	Brushed Nickel	gibson wmtf escutcheon kit, bn
210584BL	51.90	Matte Black	glyde wmtf escutcheon kit, bl
210584BN	47.25	Brushed Nickel	glyde wmtf escutcheon kit, bn
210585BG	50.10	Brushed Gold	voss wmtf escutcheon kit, bg
210585BN	50.10	Brushed Nickel	voss wmtf escutcheon kit, bn
210585NL	50.10	Polished Nickel	voss wmtf escutcheon kit, nl
210585ORB	55.10	Oil Rubbed Bronze	voss wmtf escutcheon kit, orb
210843BL	61.25	Matte Black	M-CORE handle kit, bl
210843BN	67.35	Brushed Nickel	M-CORE handle kit, bn
211113BL	62.70	Matte Black	handle kit
211113BN	52.50	Brushed Nickel	handle kit
211114BL	33.20	Matte Black	lift rod kit
211114BN	30.80	Brushed Nickel	lift rod kit
211115BL	59.30	Matte Black	handle kit
211115BN	53.90	Brushed Nickel	handle kit
211115ORB	62.50	Oil Rubbed Bronze	handle kit
211116BL	45.40	Matte Black	lift rod kit
211116BN	43.50	Brushed Nickel	lift rod kit
211116ORB	52.00	Oil Rubbed Bronze	lift rod kit
211740BL	146.00	Matte Black	spout service kit - paterson bl
211740C	125.65	Chrome	spout service kit - paterson c - motionc
211740SRS	137.75	Spot Resist Stainless	spout service kit - pat srs - motionc
211741BL	153.85	Matte Black	spout service kit - sin bl - motionc
211741C	137.80	Chrome	spout service kit - sin ch - motionc
211741NL	156.70	Polished Nickel	spout service kit - sin nl - motionc
211741SRS	149.80	Spot Resist Stainless	spout service kit - sin srs - motionc
211742BG	157.80	Brushed Gold	spout service kit - weym bg - motionc
211742BL	147.45	Matte Black	spout service kit - weym bl - motionc
211742C	119.95	Chrome	spout service kit - weym c - motionc
211742NL	142.95	Polished Nickel	spout service kit - weym nl - motionc
211742ORB	150.20	Oil Rubbed Bronze	spout service kit - weym orb - motionc

Part Number	List	Finish	Description
211742SRS	134.50	Spot Resist Stainless	spout service kit - weym srs - motionc
211743BL	262.95	Matte Black	spout service kit - nio bl - motionc
211743BLS	447.20	Black/Stainless Steel	spout service kit - nio bls - motionc
211743C	218.10	Chrome	spout service kit - nio c - motionc
211743SRS	258.15	Spot Resist Stainless	spout service kit - nio srs - motionc
215591BG	23.00	Brushed Gold	lift rod kit
215591BL	23.10	Matte Black	lift rod kit
215591BN	23.00	Brushed Nickel	lift rod kit
215665BG	76.60	Brushed Gold	handle kit
215665BL	87.10	Matte Black	handle kit
215665BN	76.60	Brushed Nickel	handle kit
215667BG	23.70	Brushed Gold	deck plate kit
215667BL	33.35	Matte Black	deck plate kit
215667BN	23.70	Brushed Nickel	deck plate kit
215668BG	22.80	Brushed Gold	lift rod kit
215668BL	23.20	Matte Black	lift rod kit
215668BN	22.80	Brushed Nickel	lift rod kit
2186BN	24.80	Brushed Nickel	strm-fassy mtcl male bn
2186P	18.60	Polished Brass	strm-fassy mtcl male pb (1)
2197BN	381.75	Brushed Nickel	roman tub spout
2198SL	26.25	Stainless	1stct mtcl bdt/lav/kd/ts2h&ws hdl cg
221641BG	118.45	Chrome	lever handle kit bg
221641BL	134.90	Matte Black	lever handle kit, bl
221641BN	122.60	Brushed Nickel	weymouth lvr hdl kit bn
221641NL	134.90	Polished Nickel	lvr hdl kitnl
221641ORB	134.90	Oil Rubbed Bronze	weymouth lvr hdl kit orb
221642BG	127.25	Chrome	cross handle kit bg
221642BL	140.00	Matte Black	cross handle kit, bl
221642BN	127.25	Brushed Nickel	weymouth cross hdl kit bn
221642NL	135.15	Polished Nickel	cross hdl kit nl
221642ORB	135.15	Oil Rubbed Bronze	weymouth cross hdl kit orb
221772BG	24.75	Chrome	finished diverter handle cap kit bg
221772NL	24.75	Chrome	finished diverter handle cap kit nl
252001BN	49.25	Brushed Nickel	handle kit, bn
252002BN	50.25	Brushed Nickel	handshower cradle kit, bn
252006BN	63.35	Brushed Nickel	cartridge sleeve, bn
252010BN	184.00	Brushed Nickel	diverter kit bn
259416BN	195.20	Brushed Nickel	riser elbow kit, bn
259416ORB	203.80	Oil Rubbed Bronze	riser elbow kit orb
259423BN	358.65	Brushed Nickel	riser kit, bn
259423ORB	361.85	Oil Rubbed Bronze	riser kit orb
262000BN	156.80	Brushed Nickel	handle kit cross, bn
262000ORB	176.70	Oil Rubbed Bronze	handle kit cross orb
262001BN	61.75	Brushed Nickel	handle kit lever, bn
262001ORB	67.85	Oil Rubbed Bronze	handle kit lever orb
262002BN	74.05	Brushed Nickel	handle hub, bn
262004BN	77.45	Brushed Nickel	wall escutcheon, bn
262004ORB	85.20	Oil Rubbed Bronze	wall escutcheon orb
262005BN	410.55	Brushed Nickel	handshower cradle, bn
262005ORB	431.45	Oil Rubbed Bronze	handshower cradle orb
262006BN	50.60	Brushed Nickel	escutcheon floor, bn
262006ORB	36.10	Oil Rubbed Bronze	escutcheon floor orb
344112BL	100.20	Black	head and spt service kit (3942bl) bl
344112SRS	94.85	Spot Resist Stainless	head and spout kit srs
344114ORB	114.65	Oil Rubbed Bronze	head and spt service kit (3944orb) orb
344114SRS	112.60	Spot Resist Stainless	head and spout kit srs
3919BN	24.75	Brushed Nickel	fra male thrd 2.2 gpm bn crd
3919CSL	24.75	Classic Stainless	fra male thrd 2.2 gpm csl crd
3919ORB	27.30	Oil Rubbed Bronze	fra male thrd 2.2 gpm orb

Moen Genuine Parts

Listed in numerical order

Part Number	List	Finish	Description
3919WR	27.30	Wrought Iron	fra male thrd 2.2 gpm wr crd
90478BN	41.40	Brushed Nickel	tw mtg screw face plate 2 bn
90478NL	16.25	Polished Nickel	tw mtg screw face plate 2 nl
90478ORB	45.60	Oil Rubbed Bronze	tw mtg screw face plate 2 orb
920-002	8.10	N/A	flo by moen ac power adapter
920-003	18.75	N/A	flo smart monitor/shutoff 25' ext cable
930-001	62.40	N/A	flo shutoff install spacer kit, 0.75" npt
930-002	62.40	N/A	flo shutoff install spacer kit, 0.75" cc
930-003	72.05	N/A	flo shutoff install spacer kit, 1" npt
930-004	72.05	N/A	flo shutoff install spacer kit, 1" cc
930-005	104.85	N/A	flo shutoff install spacer kit, 1.25" npt
930-006	104.85	N/A	flo shutoff install spacer kit, 1.25" cc
930-011	7.65	N/A	flo by moen ac adapter wall mount
935-001	22.80	N/A	flo by moen 0.75" tailpieces, npt
935-002	8.10	N/A	flo by moen 0.75" tailpieces, cc/solder
935-003	1.95	N/A	flo by moen 0.75" & 1.00" oring kit
935-004	55.80	N/A	flo by moen 1.00" tailpieces, npt
935-005	15.00	N/A	flo by moen 1.00" tailpieces, cc/solder
935-006	23.30	N/A	flo by moen 1.25" tailpieces, npt
935-007	15.45	N/A	flo by moen 1.25" tailpieces, cc/solder
935-008	1.95	N/A	flo by moen 1.25" oring kit
935-009	8.55	N/A	flo by moen 0.75" plastic union nuts
935-011	75.30	N/A	flo by moen 1.25" brass union nuts
935-014	21.25	N/A	sws plastic waterway cover .75" & 1"
935-015	27.00	N/A	sws plastic waterway cover 1.25"
935-016	9.25	N/A	flo flow meter, 0.75" & 1.00"
935-017	11.15	N/A	flo flow meter, 1.25"
93990W	18.65	Glacier	hdl dome sm kd 1h glc
95626BN	63.70	Brushed Nickel	one pc hdl hub mtcl posi kit bn
95626ORB	67.60	Oil Rubbed Bronze	one pc hdl hub mtcl posi kit orb
96885CBN	65.65	Classic Brushed Nickel	esct cht/tc ts 1h posi cbn
97372BN	103.35	Brushed Nickel	handle insert
97462BN	70.45	Brushed Nickel	hdl mtcl lrnsrt lrg chr bn 1
97476SL	21.15	Stainless	fra male thd mtcl 2.0 gpm sl
97491BN	91.35	Brushed Nickel	sct, mtcl posi-temp 1h t/s bn
97491ORB	100.40	Oil Rubbed Bronze	esct mtcl 1h posi ts orb
97491WR	100.40	Wrought Iron	esct, mtcl posi-temp 1h t/s wr
97577BN	91.35	Brushed Nickel	esct mtcl 1h ts bn
97577ORB	100.40	Oil Rubbed Bronze	esct mtcl 1h ts orb
A2020	177.20	Chrome	vessel extension kit chr
A2020BN	254.00	Brushed Nickel	vessel extension kit bn
CA3919	17.10	Chrome	fra male thrd 1.5 gpm chr crd
CA3924	17.10	Chrome	fra female thrd 1.5 gpm chr crd
CL145058	21.45	N/A	moentrol trim adapter for standard vlv
SK10065	0.60	N/A	tool, hex wrench .109 hex
SK103205	2.60	N/A	wshr, wave .970od .870id .115fh ss
SK107267	1.45	N/A	adpt, hndl vil 2h/mws lav cold
SK107268	1.45	N/A	adpt, hndl vil 2h/mws lav hot
SK107656	0.70	N/A	scrw, 6-32 unc .61 cap hd hex coated ss
SK113537	0.80	N/A	scrw, 10-24 unc .51 trs hd patch ss
SK114318	3.00	N/A	pivot rtnr
SK12382	13.00	N/A	stop tube shwr 1h ext 1" stnl stl blk
SK123852	5.55	N/A	scrw, 8-32 unc 2.81 trs hd brs chr
SK126316	6.50	N/A	adpt, hndl 1h kd lvr

Part Number	List	Finish	Description
SK126717	11.15	N/A	adpt, hndl ext 1h t/s knob brs
SK137304	2.25	N/A	cartridge nut 1h plastic
SK1423	88.40	N/A	bal spl mnt ts, bulk (120 qty)
SK142368	0.55	N/A	set screw 10-32, w/ thread patch
SK142555	2.75	N/A	mounting nut, plstc, 1h kd
SK144211	12.40	N/A	mounting flange
SK150532	1.55	N/A	scrw, 10-24 unc 1.47 pan hd patch ss
SK150534	3.75	N/A	scrw, 10-24 unc 2.14 trs hd patch ss
SK152780	20.85	N/A	duralast 1255 high flow cartridge
SK156633	26.00	Chrome	escut, t/s 1h posi chr mrkd
SK1606	0.90	N/A	scrw, 8-32 s-t .36 pan hd ss waxed
SK1711	4.20	N/A	rtnr clp lr lav & #4901 bulk
SK92143	1.00	Chrome	scrw, 10-16 s-t .61 ovl hd stl chr
SK93609	2.35	N/A	pivot stop cht/mn/mtcl
SK93636	1.70	N/A	conn, hndl kd 1h lvr
SK93646	2.35	N/A	pivot stop best
SK95502	2.90	N/A	nut, cart mws mtcl lav plstc
SK95593	0.90	N/A	tool, hex wrench .094 hex
SK95733	1.60	N/A	wshr, brng 1.182od 1.088id w/ shldr plstc
SK97302	1.90	N/A	rtnr, cart 2h t/s
SK97307	2.55	N/A	sleeve, bearing 1.030id .255wid shldr
SK97311	3.00	N/A	wshr, wave .995od .895id .154fh ss
SK97353	1.45	N/A	adpt, hndl mtcl 2h hot side
SK97354	1.45	N/A	adpt, hndl mtcl 2h cold side
SK97876	4.50	N/A	stem extension, cold
SK97877	4.50	N/A	stem extension, hot
SK98285	0.80	N/A	scrw, 8-32 unc .36 pan hd ss
SK99195	0.80	N/A	scrw, 8-32 unc 1.22 rnd hd stl zinc

GENUINE PARTS

Bulk



Glyde™ Two-Handle Centerset Bathroom Faucet / 66172

Please see [moen.com/customer-support/warranty](https://www.moen.com/customer-support/warranty)
for complete product warranty information.

Table of Contents

- 600 Kitchen
- 601 Sinks
- 602 Bathroom
- 606 M-CORE® Showering
- 608 Posi-Temp® Showering Rough-in Valves and Trim
- 615 Non-Pressure Balancing Showering

MOEN® BULK-PACK

Bulk-Pack gives you everything you need for on-site installation: kitchen, lavatory, roman tub, tub/shower faucets and stainless steel sinks in case lots.

Each kitchen and lavatory faucet carton contains individually packaged faucets ready for installation.



Roman tub and tub/shower faucets come packaged in two cartons. The rough-in valves are in one carton, the finish trim in another carton. This helps you avoid losing or damaging the trim.

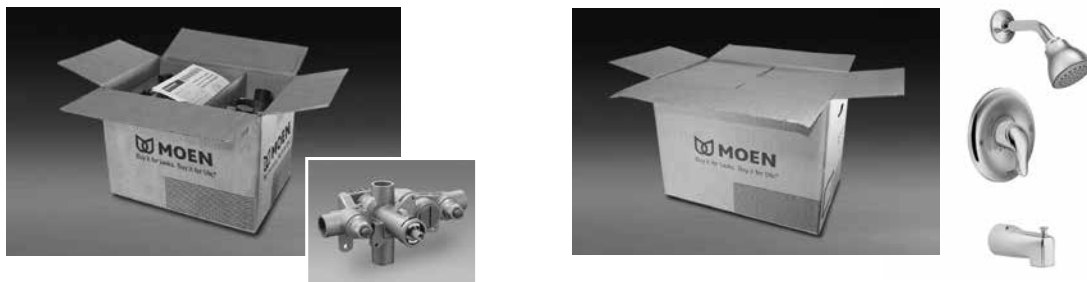

Each carton is labeled for easy identification.

CROSS-REFERENCE For Bulk Faucets and Valves

CROSS-REFERENCE TABLE

	Single Pack	Bulk Pack
Kitchen	7425	67425
Kitchen	7430	67430
Kitchen	7840	67840
Kitchen	67315C	67315C
Kitchen	67315SRS	67315SRS
Kitchen	7545C	67545C
Sink Sink	GS181210B GS18186B	BGS181210B BGS18186B
Valves	2510	62300
Valves	2520	62320
Valves	2570	62370
Valves	2580	62380
Valves	2590	62390
Valves	3570	63170
Valves	9000	69000
Tub/Shower	T2132	T62132
Tub/Shower	T2133	T62133
Tub/Shower	T2151	T62151
Tub/Shower	T2152	T62152
Tub/Shower	T2153	T62153
Tub/Shower	T2182	T62182
Tub/Shower	T2183	T62183
Tub/Shower	T2742	T62742
Tub/Shower	T2743	T62743
Tub/Shower	2352	T182 + 62320
Tub/Shower	L2352	TL182 + 62300
Tub/Shower	2353	T183 + 62320
Tub/Shower	L2353	TL183 + 62300
Tub/Shower	L2361	TL181 + 62370
Tub/Shower	L2362	TL182 + 62370
Tub/Shower	2363	T183 + 62370
Tub/Shower	L2363	TL183 + 62370
Bathroom Sink Faucet	L4601	L64601
Bathroom Sink Faucet	L4621	L64620
Bathroom Sink Faucet	L4625	L64625
Bathroom Sink Faucet	4925	64925
Bathroom Sink Faucet	6172	66172
Bathroom Sink Faucet	6410	66410
Bathroom Sink Faucet	6610	66610
Bathroom Sink Faucet	6802	66802

BULK Kitchen Faucets

Must order in Case Quantity.

MODEL LIST FINISH CASE QTY

CAMERIST® ONE-HANDLE PULLOUT KITCHEN FAUCET



- application: one or three hole
- spout height: 12.00"
- connection size: 3/8"
- connection type: compression
- number of functions: two-function
- spray type: aerated stream; powerful cleaning rinse
- hose length: 68"
- deckplate: included

1.5 GPM (5.7 L/min) max.			
67545C	418.45	Chrome	3

ADA COMPLIANT POWER CLEAN reflex DURALOCK® DURALAST®

INTEGRA® ONE-HANDLE PULLOUT KITCHEN FAUCET



- application: one or three hole
- overall height: 10.63"
- connection size: 3/8"
- connection type: compression
- number of functions: two-function
- spray type: aerated stream; powerful cleaning rinse
- hose length: 59"
- deckplate: included

1.5 GPM (5.7 L/min) max.			
67315C	319.25	Chrome	6
67315SRS●	399.05	Spot Resist Stainless	6

ADA COMPLIANT POWER CLEAN DURALOCK® DURALAST®

CAMERIST® ONE-HANDLE KITCHEN FAUCET



- application: two to four hole
- overall height: 8.13"
- connection size: 3/8"
- connection type: compression
- spray type: aerated stream
- deckplate: included
- side spray: included

1.5 GPM (5.7 L/min) max.			
67840	263.15	Chrome	6

ADA COMPLIANT DURALOCK® DURALAST®

BULK

ADA COMPLIANT
 ● Spot Resist™ Stainless Finish
 POWER CLEAN Power Clean™ Technology
 reflex Self-Retracting Spray Hose
 DURALOCK® Duralock® Quick Connections
 DURALAST® Duralast® Cartridge

BULK Kitchen Faucets and Sinks

Must order in Case Quantity.

		MODEL	LIST	FINISH	CASE QTY
--	--	-------	------	--------	----------

	CHATEAU® ONE-HANDLE KITCHEN FAUCET				
	<ul style="list-style-type: none"> • application: three hole • overall height: 8.50" • connection size: 3/8" • connection type: compression. 	1.5 GPM (5.7 L/min) max. 67425	173.60	Chrome	6



 DURALAST®

	<ul style="list-style-type: none"> • application: four hole • overall height: 8.50" • connection size: 3/8" • connection type: compression • side spray: included 	1.5 GPM (5.7 L/min) max. 67430	218.25	Chrome	6
---	--	---	--------	--------	---



 DURALOCK® DURALAST®

	<ul style="list-style-type: none"> • application: three hole • overall height: 8.50" • connection size: 3/8" • connection type: compression • side spray: included 	1.5 GPM (5.7 L/min) max. 67434	218.25	Chrome	6
--	---	---	--------	--------	---

 DURALOCK® DURALAST®

1800 SERIES 	SINGLE BOWL UNDERMOUNT SINK				
	<ul style="list-style-type: none"> • minimum cabinet size: 36" • depth size: 6" • drain location: rear center • ADA/FHA compliant: yes 	BGS181210B	462.95	Satin Stainless	36





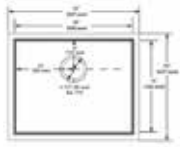







1800 SERIES 	SINGLE BOWL UNDERMOUNT SINK				
	<ul style="list-style-type: none"> • minimum cabinet size: 27" • depth size: 5.5" • drain location: rear • ADA/FHA compliant: yes 	BGS18186B	361.80	Satin Stainless	36



BULK

BULK Bathroom Faucets











Must order in Case Quantity.

		MODEL	LIST	FINISH	CASE QTY
CHATEAU®	ONE-HANDLE BATHROOM FAUCET				
	<ul style="list-style-type: none"> • application: three hole • center dimensions: 4" center • connection size: 1/2" • connection type: IPS • drain assembly: drain not included 	64601	154.85	Chrome	12
	 DURALAST®				
	<ul style="list-style-type: none"> • application: three hole • center dimensions: 4" center • connection size: 1/2" • connection type: IPS • drain assembly: 50% plastic/ 50% metal • drain assembly type: lift rod 	64621	190.30	Chrome	12
	 DURALAST®				
	<ul style="list-style-type: none"> • application: three hole • center dimensions: 4" center • supply line length: flexible • connection size: 3/8" • connection type: compression • drain assembly: drain not included 	L64600	154.85	Chrome	12
	  DURALAST®				
	<ul style="list-style-type: none"> • application: three hole • center dimensions: 4" center • connection size: 1/2" • connection type: IPS • drain assembly: drain not included 	L64601	154.85	Chrome	12
	  DURALAST®				

BULK

BULK Bathroom Faucets

















Must order in Case Quantity.

		MODEL	LIST	FINISH	CASE QTY
CHATEAU®	ONE-HANDLE BATHROOM FAUCET (CONTINUED)				
	<ul style="list-style-type: none"> • application: three hole • center dimensions: 4" center • connection size: 1/2" • connection type: IPS • drain assembly: metal • drain assembly type: lift rod  DURALAST®	L64620	201.95	Chrome	12
	<ul style="list-style-type: none"> • application: three hole • center dimensions: 4" center • connection size: 1/2" • connection type: IPS • drain assembly: 50% plastic/ 50% metal • drain assembly type: lift rod  DURALAST®	L64621	190.30	Chrome	12
	<ul style="list-style-type: none"> • application: three hole • center dimensions: 4" center • supply line length: flexible • connection size: 3/8" • connection type: compression • drain assembly: metal • drain assembly type: lift rod  DURALAST®	L64624	207.75	Chrome	12
	<ul style="list-style-type: none"> • application: three hole • center dimensions: 4" center • supply line length: flexible • connection size: 3/8" • connection type: compression • drain assembly: 50% plastic/ 50% metal • drain assembly type: lift rod  DURALAST®	L64625	192.20	Chrome	12
	<ul style="list-style-type: none"> • application: three hole • center dimensions: 4" center • connection size: 1/2" • connection type: IPS • drain assembly: metal • drain assembly type: lift rod • red/blue markings: included  DURALAST®	L64635	207.75	Chrome	12

BULK

BULK Bathroom Faucets

















Must order in Case Quantity.

		MODEL	LIST	FINISH	CASE QTY
	DARTMOOR® TWO-HANDLE CENTERSET BATHROOM FAUCET				
	<ul style="list-style-type: none"> • application: three hole • center dimensions: 4" center • connection size: 1/2" • connection type: IPS • drain assembly: 50% plastic/ 50% metal • drain assembly type: lift rod <p>  DURALAST®</p>	 1.2 GPM (4.5L/min) max. 66802	199.00	Chrome	6
	GLYDE™ TWO-HANDLE CENTERSET BATHROOM FAUCET				
	<ul style="list-style-type: none"> • application: three hole • center dimensions: 4" center • connection size: 1/2" • connection type: IPS • drain assembly: 50% plastic/ 50% metal • drain assembly type: lift rod <p>  DURALAST®</p>	 1.2 GPM (4.5L/min) max. 66172	199.00	Chrome	6
	BRANTFORD® TWO-HANDLE CENTERSET BATHROOM FAUCET				
	<ul style="list-style-type: none"> • application: three hole • center dimensions: 4" center • connection size: 1/2" • connection type: IPS • drain assembly: 50% plastic/ 50% metal • drain assembly type: lift rod <p>  DURALAST®</p>	 1.2 GPM (4.5L/min) max. 66610	199.00	Chrome	6
	EVA® TWO-HANDLE CENTERSET BATHROOM FAUCET				
	<ul style="list-style-type: none"> • application: three hole • center dimensions: 4" center • connection size: 1/2" • connection type: IPS • drain assembly: 50% plastic/ 50% metal • drain assembly type: lift rod <p>  DURALAST®</p>	 1.2 GPM (4.5L/min) max. 66410	199.00	Chrome	6

BULK

BULK Bathroom Faucets

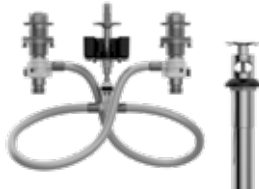
Must order in Case Quantity.

		MODEL	LIST	FINISH	CASE QTY
	CHATEAU® TWO-HANDLE CENTERSET BATHROOM FAUCET				
	<ul style="list-style-type: none"> • application: three hole • center dimensions: 4" center • connection size: 1/2" • connection type: IPS • drain assembly: drain not included <p> DURALAST®</p>	<p> 1.2 GPM (4.5L/min) max.</p> <p>64900 121.00 Chrome 12</p>			
	<ul style="list-style-type: none"> • application: three hole • center dimensions: 4" center • connection size: 1/2" • connection type: IPS • drain assembly: metal • drain assembly type: lift rod <p> DURALAST®</p>	<p> 1.2 GPM (4.5L/min) max.</p> <p>64919 167.85 Chrome 12</p>			
	<ul style="list-style-type: none"> • application: three hole • center dimensions: 4" center • connection size: 1/2" • connection type: IPS • drain assembly: 50% plastic/ 50% metal • drain assembly type: lift rod <p> DURALAST®</p>	<p> 1.2 GPM (4.5L/min) max.</p> <p>64920 167.85 Chrome 12</p>			
	<ul style="list-style-type: none"> • application: three hole • center dimensions: 4" center • connection size: 1/2" • connection type: IPS • drain assembly: drain not included <p>  DURALAST®</p>	<p> 1.2 GPM (4.5L/min) max.</p> <p>64922 121.00 Chrome 12</p>			
	<ul style="list-style-type: none"> • application: three hole • center dimensions: 4" center • connection size: 1/2" • connection type: IPS • drain assembly: 50% plastic/ 50% metal • drain assembly type: lift rod <p>  DURALAST®</p>	<p> 1.2 GPM (4.5L/min) max.</p> <p>64925 167.85 Chrome 12</p>			
	M-PACT® WIDESPREAD VALVE				
	<ul style="list-style-type: none"> • application: three hole • center dimensions: 8" - 16" center • connection size: 1/2" • connection type: IPS • drain assembly: metal • drain assembly type: lift rod <p> DURALOCK® DURALAST®</p>	<p>69000 146.80 1/2" IPS 6</p>			



BULK

 ADA Compliant
 WaterSense Certified
 Moen® **M•PACT®** Common Valve System
DURALOCK® Quick Connections
DURALAST® Duralast® Cartridge



M-CORE® Showering

Must order in Case Quantity.

LEGEND®	M-CORE® 3-SERIES TUB/SHOWER TRIM	MODEL	LIST	FINISH	CASE QTY
	<ul style="list-style-type: none"> • showerhead: one-function • showerhead size: 2-1/2" diameter spray head • spout length: 5 1/2" • spout connection type: slip fit • tub spout type: diverter • valve sold separately • includes: pressure balanced cartridge with volume and temperature control 	Flow Rate:	2.5 gpm (9.5 L/min) max		
		UTL172	256.50	Chrome	4
		Flow Rate:	1.75 gpm (6.65 L/min) max		
		UTL172EP	256.50	Chrome	4
	<ul style="list-style-type: none"> • showerhead: one-function • showerhead size: 2-1/2" diameter spray head • valve sold separately • includes: pressure balanced cartridge with volume and temperature control 	Flow Rate:	2.5 gpm (9.5 L/min) max		
		UTL171	213.40	Chrome	4
		Flow Rate:	1.75 gpm (6.65 L/min) max		
		UTL171EP	213.40	Chrome	4
	<ul style="list-style-type: none"> • valve sold separately • includes: pressure balanced cartridge with volume and temperature control 	UTL170	207.20	Chrome	4



BULK

VALVE:
PAGE 471

HOW TO ORDER TRIM PART NO.



+

VALVE PART NO.



=

COMPLETE FAUCET



Pair your M-CORE® showering product with one of these M-CORE® showering valves.















NOTE: The valves below are not offered in bulk options.

TUB/SHOWER OR SHOWER ONLY APPLICATION				
Description	Model	List	Connection	Case Qty
Four port	U140CI	72.60	1/2" CC/IPS	6
Four port	U140X	72.60	1/2" Crimp Ring PEX with CC/IPS Tub	6
Four port	U140CX	72.60	1/2" Cold Exp. Pex with CC/IPS Tub	6
Four port	U140V	88.95	1/2" CPVC with CC/IPS Tub	6
Four port with quarter turn stops	U140CIS	104.50	1/2" CC/IPS	6
Four port with quarter turn stops	U140XS	104.50	1/2" Crimp Ring PEX with CC/IPS Tub	6
Four port with quarter turn stops	U140CXS	104.50	1/2" Cold Exp. Pex with CC/IPS Tub	6
Four port with quarter turn stops	U140VS	120.85	1/2" CPVC with CC/IPS Tub	6

SHOWER ONLY APPLICATION				
Description	Model	List	Connection	Case Qty
Three port	U130CI	72.60	1/2" CC/IPS	6
Three port	U130X	72.60	1/2" Crimp Ring PEX	6
Three port	U130CX	72.60	1/2" Cold Exp. Pex	6
Three port with quarter turn stops	U130CIS	104.50	1/2" CC/IPS	6
Three port with quarter turn stops	U130XS	104.50	1/2" Crimp Ring PEX	6
Three port with quarter turn stops	U130CXS	104.50	1/2" Cold Exp. Pex	6

BULK Posi-Temp® Showering

Must order in Case Quantity.

		MODEL	LIST FINISH	CASE QTY
DARTMOOR®	POSI-TEMP® TUB/SHOWER TRIM			
  	<ul style="list-style-type: none"> • showerhead: one-function • showerhead size: 4" diameter spray head • spout length: 7" • spout connection type: slip fit • tub spout type: diverter • valve sold separately  	Flow Rate: 2.5 gpm (9.5 L/min) max		
		T62183	118.95 Chrome	12
GLYDE™	POSI-TEMP® TUB/SHOWER TRIM			
  	<ul style="list-style-type: none"> • showerhead: one-function • showerhead size: 3-3/4" diameter spray head • spout length: 7" • spout connection type: slip fit • tub spout type: diverter • valve sold separately  	Flow Rate: 2.5 gpm (9.5 L/min) max		
		T62743	118.95 Chrome	6
BRANTFORD®	POSI-TEMP® TUB/SHOWER TRIM			
  	<ul style="list-style-type: none"> • showerhead: one-function • showerhead size: 3-1/2" diameter spray head • spout length: 6 1/2" • spout connection type: slip fit • tub spout type: diverter • valve sold separately  	Flow Rate: 2.5 gpm (9.5 L/min) max		
		T62153	118.95 Chrome	12
		T62153EP	118.95 Chrome	12

VALVE:
PAGE 473

HOW TO ORDER

TRIM
PART NO.



+

VALVE
PART NO.



=

COMPLETE
FAUCET



BULK

BULK Posi-Temp® Showering

Must order in Case Quantity.

	MODEL	LIST	FINISH	CASE QTY	
EVA® 	POSI-TEMP® TUB/SHOWER TRIM				
		Flow Rate:	2.5 gpm (9.5 L/min) max		
		T62133	118.95	Chrome	12
		Flow Rate:	1.75 gpm (6.65 L/min) max		
	T62133EP	118.95	Chrome	12	

- showerhead functions: one-function
- showerhead size: 3-1/2" diameter spray head
- spout length: 7"
- spout connection type: slip fit
- tub spout type: diverter
- valve sold separately



CHATEAU® 	POSI-TEMP® TUB/SHOWER TRIM				
		Flow Rate:	2.5 gpm (9.5 L/min) max		
		T183	81.25	Chrome	12
		Flow Rate:	1.75 gpm (6.65 L/min) max		
	T183EP	81.25	Chrome	12	



- showerhead functions: one-function
- showerhead size: 2-1/2" diameter spray head
- spout length: 5 1/2"
- spout connection type: slip fit
- tub spout type: diverter
- red/blue markings: included
- valve sold separately



CHATEAU® 	POSI-TEMP® TUB/SHOWER TRIM				
		Flow Rate:	2.5 gpm (9.5 L/min) max		
		TL183	81.25	Chrome	12
		Flow Rate:	1.75 gpm (6.65 L/min) max		
	TL183EP	81.25	Chrome	12	

- showerhead: one-function
- showerhead size: 2-1/2" diameter spray head
- tub spout type: diverter
- red/blue markings: included
- valve: sold separately















	TL183NH	71.35	Chrome	12
	<ul style="list-style-type: none"> • showerhead: showerhead sold separately • spout length: 5 1/2" • spout connection type: slip fit • tub spout type: diverter • red/blue markings: included • valve sold separately 			
				



BULK

BULK Posi-Temp® Showering

Must order in Case Quantity.

		MODEL	LIST	FINISH	CASE QTY
	POSITEMP® SHOWER ONLY TRIM • showerhead: one-function • showerhead size: 4" diameter spray head • valve sold separately	Flow Rate:	2.5 gpm (9.5 L/min) max		
		T62182	78.95	Chrome	12
	 				
	POSITEMP® SHOWER ONLY TRIM • showerhead: one-function • showerhead size: 3-3/4" diameter spray head • valve sold separately	Flow Rate:	2.5 gpm (9.5 L/min) max		
		T62742	78.95	Chrome	12
	 				
	POSITEMP® SHOWER ONLY TRIM • showerhead: one-function • showerhead size: 3-3/8" diameter spray head • valve sold separately	Flow Rate:	2.5 gpm (9.5 L/min) max		
		T62152	78.95	Chrome	12
		Flow Rate:	1.75 gpm (6.65 L/min) max.		
	 	 T62152EP	78.95	Chrome	12

VALVE:
PAGE 473

HOW TO ORDER

TRIM
PART NO.



+

VALVE
PART NO.



=

COMPLETE
FAUCET









BULK



BULK Posi-Temp® Showering

Must order in Case Quantity.

		MODEL	LIST	FINISH	CASE QTY	
EVA®  	POSI-TEMP® SHOWER ONLY TRIM <ul style="list-style-type: none"> showerhead: one-function showerhead size: 3-1/2" diameter spray head valve sold separately 					
			Flow Rate:	2.5 gpm (9.5 L/min) max		
			T62132	78.95	Chrome	12
			Flow Rate:	1.75 gpm (6.65 L/min) max		
		T62132EP	78.95	Chrome	12	
	 					
CHATEAU®  	POSI-TEMP® SHOWER ONLY TRIM <ul style="list-style-type: none"> showerhead: one-function showerhead size: 2-1/2" diameter spray head red/blue markings: included valve sold separately 					
			Flow Rate:	2.5 gpm (9.5 L/min) max		
			T182	50.05	Chrome	12
						

VALVE:
PAGE 473

HOW TO ORDER

-
PART NO.



+

VALVE
PART NO.



=

COMPLETE
FAUCET













BULK



BULK Posi-Temp® Showering

Must order in Case Quantity.

CHATEAU®		MODEL	LIST FINISH	CASE QTY
POSI-TEMP® SHOWER ONLY TRIM				
	<ul style="list-style-type: none"> • showerhead: one-function eco performance • showerhead size: 2-1/2" diameter spray head • red/blue markings: included • valve: sold separately  	Flow Rate:	1.75 gpm (6.65 L/min) max.	
		TL182EP	50.05 Chrome	12
	<ul style="list-style-type: none"> • showerhead: one-function • showerhead size: 2-1/2" diameter spray head. • red/blue markings: included • valve: sold separately  	Flow Rate:	2.5 gpm (9.5 L/min) max	
		TL182	50.05 Chrome	12
		Flow Rate:	1.75 gpm (6.65 L/min) max.	
		 TL182EP	50.05 Chrome	12
	<ul style="list-style-type: none"> • showerhead: showerhead sold separately • red/blue markings: included • valve sold separately  	TL182NH	47.45 Chrome	12



BULK Posi-Temp® Showering

Must order in Case Quantity.

BRANTFORD® POSI-TEMP® VALVE ONLY TRIM



• valve sold separately **T62151** 58.75 Chrome 12



CHATEAU® POSI-TEMP® VALVE ONLY TRIM



• red/blue markings: included
• valve: sold separately **TL181** 45.45 Chrome 12



T187 45.45 Chrome 12



• red/blue markings: included
• valve: sold separately



T181 45.45 Chrome 12



• red/blue markings: included
• valve: sold separately



VALVE:
PAGE 473

HOW TO ORDER

TRIM
PART NO.



+

VALVE
PART NO.



=

COMPLETE
FAUCET



BULK

BULK Posi-Temp® Showering

Must order in Case Quantity.



Posi-Temp® Mixing Showering Rough-In Valves



(For product details and images, please reference page 467-469 in Valve section)

TUB/SHOWER OR SHOWER ONLY APPLICATION				
Description	Model	List	Connection	Case Qty
Four port; adjustable temperature limit stops	62320	148.05	1/2" CC	12
Four port; adjustable temperature limit stops; test plug included	FP62320	148.05	1/2" CC	12
Four port; adj. temp. limit stops; quarter turn stops included	62370	180.00	1/2" CC	12
Four port; adj. temp. limit stops; quarter turn stops and test plug included	FP62370	180.00	1/2" CC	12
Four port; adjustable temperature limit stops	62300	148.05	1/2" IPS	12
Four port; adjustable temperature limit stops; test plug included	FP62300	148.05	1/2" IPS	12
Four port; adj. temp. limit stops; quarter turn stops included	62390	180.00	1/2" IPS	12
Four port; adjustable temperature limit stops	62380	148.05	1/2" Crimp Ring PEX	12
Four port; adjustable temperature limit stops; test plug included	FP62380	148.05	1/2" Crimp Ring PEX	12
Four port; adj. temp. limit stops; quarter turn stops included	62360	180.00	1/2" Crimp Ring PEX	12
Four port; adjustable temperature limit stops	62365	148.05	1/2" Cold Exp. PEX	12
Four port; adjustable temperature limit stops; test plug included	FP62365	148.05	1/2" Cold Exp. PEX	12
Four port; adj. temp. limit stops; quarter turn stops included	62385	180.00	1/2" Cold Exp. PEX	12
Four port; adj. temp. limit stops; quarter turn stops and test plug included	FP62385	180.00	1/2" Cold Exp. PEX	12
Four port; adjustable temperature limit stops	62340	164.25	1/2" CPVC	12
Four port; adjustable temperature limit stops; test plug included	FP62340	164.25	1/2" CPVC	12
Four port; adj. temp. limit stops; quarter turn stops included	62330	196.25	1/2" CPVC	12
Four port; adjustable temperature limit stops; pre-fab	62380PF	168.65	1/2" Crimp Ring PEX	12
Four port; adjustable temperature limit stops; test plug included; pre-fab	FP62380PF	168.65	1/2" Crimp Ring PEX	12
Four port; adj. temp. limit stops; quarter turn stops included; pre-fab	62360PF	200.50	1/2" Crimp Ring PEX	12
Four port; adj. temp. limit stops; quarter turn stops and test plug included; pre-fab	FP62360PF	200.50	1/2" Crimp Ring PEX	12
Four port; adjustable temperature limit stops; pre-fab	62365PF	168.65	1/2" Cold Exp. PEX	12
Four port; adjustable temperature limit stops; test plug included; pre-fab	FP62365PF	168.65	1/2" Cold Exp. PEX	12
Four port; adj. temp. limit stops; quarter turn stops included; pre-fab	62385PF	200.50	1/2" Cold Exp. PEX	12
Four port; adj. temp. limit stops; quarter turn stops and test plug included; pre-fab	FP62385PF	200.50	1/2" Cold Exp. PEX	12
SHOWER ONLY APPLICATION				
Description	Model	List	Connection	Case Qty
Three port; adjustable temperature limit stops	62345	148.05	1/2" IPS, CC	12
Three port; adjustable temperature limit stops; test plug included	FP62325PF	161.30	1/2" Crimp Ring PEX	12
Three port; adjustable temperature limit stops; test plug included	FP62327PF	161.30	1/2" Cold Exp. PEX	12
Three port; adj. temp. limit stops; quarter turn stops and test plug included	FP62328PF	193.25	1/2" Cold Exp. PEX	12



BULK Non-Pressure Balancing Showering



Must order in Case Quantity.

	MODEL	LIST FINISH	CASE QTY	
CHATEAU® ONE-HANDLE NON-PRESSURE BALANCED TUB/SHOWER TRIM				
 <ul style="list-style-type: none"> • showerhead: one-function • showerhead size: 2-1/2" diameter spray head • spout length: 5 1/2" • spout connection type: slip fit • tub spout type: diverter • red/blue markings: included • valve sold separately 	Flow Rate:	2.5 gpm (9.5 L/min) max		
	T471	93.20	Chrome	12
	Flow Rate:	1.75 gpm (6.65 L/min) max		
	T471EP	93.20	Chrome	12

 <ul style="list-style-type: none"> • showerhead: one-function • showerhead size: 2-1/2" diameter spray head • spout length: 5 1/2" • spout connection type: slip fit • tub spout type: diverter • red/blue markings: included • valve sold separately 	Flow Rate:	2.5 gpm (9.5 L/min) max		
	TL471	93.20	Chrome	12
	Flow Rate:	1.75 gpm (6.65 L/min) max		
	TL471EP	93.20	Chrome	12



CHATEAU® ONE-HANDLE NON-PRESSURE BALANCED SHOWER ONLY TRIM				
 <ul style="list-style-type: none"> • showerhead: one-function • showerhead size: 2-1/2" diameter spray head • red/blue markings: included • valve sold separately 	Flow Rate:	2.5 gpm (9.5 L/min) max		
	T473	57.55	Chrome	12
	Flow Rate:	1.75 gpm (6.65 L/min) max		
	T473EP	57.55	Chrome	12

 <ul style="list-style-type: none"> • showerhead: one-function • showerhead size: 2-1/2" diameter spray head • red/blue markings: included • valve sold separately 	Flow Rate:	2.5 gpm (9.5 L/min) max		
	TL473	57.55	Chrome	12
	Flow Rate:	1.75 gpm (6.65 L/min) max		
	TL473EP	57.55	Chrome	12



BULK



BULK Non-Pressure Balancing Showering

Must order in Case Quantity.

		MODEL	LIST	FINISH	CASE QTY
CHATEAU®	ONE-HANDLE NON-PRESSURE BALANCED VALVE ONLY TRIM				
	• valve sold separately	T470	48.25	Chrome	12



	• valve sold separately	TL470	48.25	Chrome	12
--	-------------------------	--------------	-------	--------	----



VALVE:
PAGE 477

HOW TO ORDER

TRIM
PART NO.



+

VALVE
PART NO.



=

COMPLETE
FAUCET



Non-Pressure Balanced Mixing Showering Rough-In Valves

(For product details and images, please reference page 477 in Valve section)

TUB/SHOWER OR SHOWER ONLY APPLICATION

Description	Model	List	Connection	Case Qty
Four port; non-pressure balanced mixing valve	62700	134.85	1/2" IPS	12
Four port; non-pressure balanced mixing valve	62720	134.85	1/2" CC	12

BULK

Commercial Products





Products that Address Your Highest Priorities

From leaks and vandalism to normal wear and tear, worries never cease where commercial and institutional fixtures are concerned. That's why Moen® Commercial engineers and designers plan for every imaginable scenario—and plan for it in advance. The result is a full line of faucets and valves facilities managers can rely on from the number one faucet brand in North America.

Our products will help you:

- Reduce maintenance costs
- Resist vandalism
- Save water while maintaining performance
- Cut your total cost of ownership

On the pages ahead, we welcome you to discover all the many reasons you can count on Moen Commercial to provide the best solutions for your most challenging environments.

CONTENTS

620 | M•DURA™ Heavy-Duty Faucet

632 | M•PRESS™ Heavy-Duty Metering Faucets

634 | M•BITION™ Medium-Duty Faucets

641 | M•POWER™ Sensor-Operated Faucets

649 | M•POWER™ Sensor-Operated Flush Valves

653 | M•DURA™ Heavy-Duty Manual Flush Valves

656 | M•DURA™ Heavy-Duty Showering

673 | Service Kits Line List

WE'RE HERE TO HELP YOU MEET EVERY CHALLENGE

Anticipating every need, your Moen Commercial representative will help you find the right solutions that will serve you well for years. With our experienced guidance, you'll not only satisfy regulations and requirements, but also create aesthetically pleasing environments thanks to our trend-setting, residential-inspired styles. Your representative is committed to ensuring your fixtures' suitability for demanding uses, as indicated by the symbols below:

Icon Key



Moen 5-Year Limited Warranty

We are so confident in the high performance of our products that we back them with a 5-Year Limited Warranty. If they should drip, leak or prove to have a finish defect, we will send you the needed replacement parts, free of charge. Just call 1-800-BUY-MOEN or see your Moen dealer for complete details.



Eco-Friendly

With the growing demand for eco-friendly products, Moen Commercial offers many fixtures whose water savings exceed industry standards.



ADA Compliant

With very few exceptions, fixtures from Moen Commercial comply with the Americans with Disabilities Act (ADA).



BAA Compliant

A wide range of our products meet the current requirements of the Buy American Act (BAA).



Safe Drinking Water Act

Moen products comply with the Safe Drinking Water Act's stringent lead safety standards. Each product in this catalog has been identified by the following icons where applicable:



NSF 61/9 and 372 compliant



NSF 372 compliant



Non-drinking water faucet

To see our full line of faucets and valves, visit moencommercial.com.



Meets WaterSense® Criteria

We offer many products which meet WaterSense criteria to contribute toward meeting the LEED® standards and maximizing all LEED points.* While helping you achieve the ambitious environmental standards, Moen Commercial can also help you ensure essential function. For instance, installing extremely low-flow fixtures that save water could end up being costlier elsewhere. Without enough water pressure to clear your pipes of solids, the performance, maintenance and sanitation of pipes can quickly become serious issues. Exceedingly low-flow fixtures also provide consumers with a disappointing experience. Being LEED certified doesn't mean sacrificing performance to save water. With the highly knowledgeable guidance of a Moen Commercial representative, you can build beautifully efficient properties without increasing health risks and down grading the consumer experience.

*Projects pursuing LEED certification earn points across several areas that address sustainability issues, and based on the number of points achieved, a project receives one of four LEED rating levels: Certified, Silver, Gold or Platinum.



Moen M•PACT® Common Valve System

With M•PACT, you can change your faucet style without replacing any plumbing. It's as easy as changing a light bulb.

DURALAST® Duralast® Cartridge



Provides the smooth feel and reliable operation of a new faucet from the first time you use it to the last.

M•DURA™ Heavy-Duty Faucets





M•DURA Single-Mount Lavatory Faucet / 9417 & 9419 Series

M•DURA™ Heavy-Duty Faucets

	MODEL	LIST	FINISH/CONNECT	CASE QTY
ONE-HANDLE SINGLE-MOUNT LAVATORY FAUCET				
 <ul style="list-style-type: none"> • connection size: 3/8" compression • vandal resistant: yes • cartridge type: 1255° Duralast® • flow type: vandal resistant aerated • mount type: single mount • supply length: 22" • deckplate: sold separately • temp. limit stop: yes • drain assembly not included • no lift rod hole • lever handle • material: brass <p>♿ DURALAST® ♿ ▲</p>	<p>🔥 1.2 GPM (4.5 L/min) max.</p> <p>9417F12 283.00 Chrome 3</p>			
	<p>🔥 0.5 GPM (1.9 L/min) max.</p> <p>9417F05 283.00 Chrome 3</p>			
	<p>4" DECKPLATE SOLD SEPARATELY</p>			
	<p>99559 38.25 Chrome 20</p>			
 <ul style="list-style-type: none"> • connection size: 3/8" compression • vandal resistant: yes • cartridge type: 1255° Duralast® • flow type: vandal resistant aerated • mount type: single mount • supply length: 22" • deckplate: sold separately • temp. limit stop: yes • drain assembly: metal • lever handle • material: brass <p>♿ DURALAST® ♿ ▲</p>	<p>🔥 1.2 GPM (4.5 L/min) max.</p> <p>9419F12 314.45 Chrome 3</p>			
	<p>🔥 0.5 GPM (1.9 L/min) max.</p> <p>9419F05 314.45 Chrome 3</p>			
	<p>4" DECKPLATE SOLD SEPARATELY</p>			
	<p>99559 38.25 Chrome 20</p>			
 <ul style="list-style-type: none"> • connection size: 3/8" compression • cartridge type: ceramic disc • flow type: aerated • mount type: single mount • supply length: 22" • temp. limit stop: yes • drain assembly not included • no lift rod hole • lever handle • material: brass <p>♿ ▲</p>	<p>🔥 1.2 GPM (4.5 L/min) max.</p> <p>8417F12 255.75 Chrome 6</p>			
	<p>🔥 0.5 GPM (1.9 L/min) max.</p> <p>8417F05 255.75 Chrome 6</p>			
 <ul style="list-style-type: none"> • connection size: 3/8" compression • cartridge type: ceramic disc • flow type: aerated • mount type: single mount • supply length: 22" • temp. limit stop: yes • drain assembly: metal • lever handle • material: brass <p>♿ ▲</p>	<p>🔥 1.2 GPM (4.5 L/min) max.</p> <p>8419F12 290.50 Chrome 6</p>			
	<p>🔥 0.5 GPM (1.9 L/min) max.</p> <p>8419F05 290.50 Chrome 6</p>			

















COMMERCIAL

M•DURA™ Heavy-Duty Faucets

	MODEL	LIST	FINISH/CONNECT	CASE QTY
ONE-HANDLE CENTERSET LAVATORY FAUCET				
 <ul style="list-style-type: none"> • connection size: 1/2" IPS • cartridge type: ceramic disc • flow type: aerated • mount type: centerset • temp. limit stop: yes • drain assembly not included • no lift rod hole • lever handle • material: brass <p>♿ ▲</p>	<p>🔥 1.2 GPM (4.5 L/min) max.</p> <p>8413F12 185.15 Chrome 3</p> <p>🚰 0.5 GPM (1.9 L/min) max.</p> <p>8413F05 185.15 Chrome 3</p> <p>🚰 0.35 GPM (1.32 L/min) max.</p> <p>8413F03 185.15 Chrome 3</p>			
	 <ul style="list-style-type: none"> • connection size: 1/2" IPS • cartridge type: ceramic disc • flow type: aerated • mount type: centerset • temp. limit stop: yes • drain assembly: metal • lever handle • material: brass <p>♿ ▲</p>	<p>2.2 GPM (8.3 L/min) max.</p> <p>8414 220.95 Chrome 6</p> <p>🔥 1.2 GPM (4.5 L/min) max.</p> <p>8414F12 220.95 Chrome 3</p> <p>8414F12BN 287.20 Brushed Nickel 3</p>		
		 <ul style="list-style-type: none"> • connection size: 1/2" IPS • vandal resistant: yes • cartridge type: ceramic hot/cold • flow type: vandal resistant aerated • mount type: centerset • temp. limit stop: yes • drain assembly not included • no lift rod hole • lever handle • material: brass <p>♿ ▲</p>	<p>2.2 GPM (8.3 L/min) max.</p> <p>8416 198.85 Chrome 6</p> <p>🚰 0.5 GPM (1.9 L/min) max.</p> <p>8416F05 198.85 Chrome 3</p>	
WIDESPREAD LAVATORY FAUCET				
 <ul style="list-style-type: none"> • connection size: 1/2" IPS • vandal resistant: yes • cartridge type: ceramic hot/cold • flow type: vandal resistant aerated • mount type: widespread • drain assembly not included • no lift rod hole • lever handle • material: brass <p>♿ 🚰 ▲</p>	<p>🚰 0.5 GPM (1.9 L/min) max.</p> <p>8220F05 338.60 Chrome 3</p>			
	 <ul style="list-style-type: none"> • connection size: 1/2" IPS • vandal resistant: yes • cartridge type: ceramic hot/cold • flow type: vandal resistant aerated • mount type: widespread • drain assembly not included • no lift rod hole • wrist blade handle • material: brass <p>♿ 🚰 ▲</p>	<p>🔥 1.2 GPM (4.5 L/min) max.</p> <p>8228F12 360.00 Chrome 3</p> <p>🚰 0.5 GPM (1.9 L/min) max.</p> <p>8228F05 360.00 Chrome 3</p>		

COMMERCIAL













M•DURA™ Heavy-Duty Faucets

	MODEL	LIST	FINISH/CONNECT	CASE QTY	
TWO-HANDLE CENTERSET LAVATORY FAUCET					
 <ul style="list-style-type: none"> • connection size: 1/2" IPS • vandal resistant: yes • cartridge type: ceramic hot/cold • flow type: vandal resistant aerated • mount type: centerset • drain assembly not included • no lift rod hole • lever handle • material: brass <p>    </p>		▲ 1.2 GPM (4.5 L/min) max.			
	8210F12	216.20	Chrome	6	
			● 0.5 GPM (1.9 L/min) max.		
	8210F05	216.20	Chrome	6	
 <ul style="list-style-type: none"> • connection size: 1/2" IPS • vandal resistant: yes • cartridge type: ceramic hot/cold • flow type: vandal resistant aerated • mount type: centerset • drain assembly not included • no lift rod hole • smooth lever handle • material: brass <p>    </p>		▲ 1.2 GPM (4.5 L/min) max.			
	8210SMF12	216.20	Chrome	6	
			● 0.5 GPM (1.9 L/min) max.		
	8210SMF05	216.20	Chrome	6	
 <ul style="list-style-type: none"> • connection size: 1/2" IPS • vandal resistant: yes • cartridge type: ceramic hot/cold • flow type: vandal resistant aerated • mount type: centerset • drain assembly not included • no lift rod hole • wrist blade handle • material: brass <p>    </p>		▲ 1.2 GPM (4.5 L/min) max.			
	8215F12	239.75	Chrome	6	
			● 0.5 GPM (1.9 L/min) max.		
	8215F05	239.75	Chrome	6	
		● 0.35 GPM (1.32 L/min) max.			
8215F03	239.75	Chrome	6		
 <ul style="list-style-type: none"> • connection size: 1/2" IPS • vandal resistant: yes • cartridge type: ceramic hot/cold • flow type: vandal resistant aerated • mount type: centerset • drain assembly not included • no lift rod hole • smooth wrist blade handle • material: brass <p>    </p>		▲ 1.2 GPM (4.5 L/min) max.			
	8215SMF12	239.75	Chrome	6	
MANUAL-TO-METERING CONVERSION KIT					
 <ul style="list-style-type: none"> • excludes 8242, 8244 and modern lavs • includes hot/cold color indicator rings 	52120	180.85	Chrome	12	







COMMERCIAL

M•DURA™ Heavy-Duty Faucets

MODEL LIST FINISH/CONNECT CASE QTY

TWO-HANDLE CENTERSET GOOSENECK FAUCET				
 <ul style="list-style-type: none"> • connection size: 1/2" IPS • vandal resistant: yes • cartridge type: ceramic hot/cold • spout reach: 3.60" • flow type: vandal resistant laminar • mount type: centerset • drain assembly not included • no lift rod hole • lever handle • material: brass 	1.2 GPM (4.5 L/min) max. 8270	257.15	Chrome	6
 <ul style="list-style-type: none"> • connection size: 1/2" IPS • vandal resistant: yes • cartridge type: ceramic hot/cold • spout reach: 3.60" • flow type: vandal resistant laminar • mount type: centerset • drain assembly not included • wrist blade handle • material: brass 	1.2 GPM (4.5 L/min) max. 8278	270.95	Chrome	6
 <ul style="list-style-type: none"> • connection size: 1/2" IPS • vandal resistant: yes • cartridge type: ceramic hot/cold • spout reach: 3.60" • flow type: vandal resistant laminar • mount type: centerset • drain assembly not included • smooth wrist blade handle • material: brass 	2.2 GPM (8.3 L/min) max. 8278SM	270.95	Chrome	6
	Ø 1.2 GPM (4.5 L/min) max. 8278SMF12	270.95	Chrome	6
 <ul style="list-style-type: none"> • connection size: 1/2" IPS • vandal resistant: yes • cartridge type: ceramic hot/cold • spout reach: 5.25" • flow type: vandal resistant laminar • mount type: centerset • drain assembly not included • wrist blade handle • material: brass 	1.2 GPM (4.5 L/min) max. 8279	293.20	Chrome	6
 <ul style="list-style-type: none"> • includes optional 2.0 gpm laminar flow spout base conversion kit • connection size: 1/2" IPS • vandal resistant: yes • cartridge type: ceramic hot/cold • spout reach: 5.25" • flow type: vandal resistant laminar • mount type: centerset • drain assembly not included • smooth wrist blade handle • material: brass 	2.2 GPM (8.3 L/min) max. aerated / 2.0 GPM (7.6 L/min) max. laminar 8279SM	288.30	Chrome	6
	Ø 1.2 GPM (4.5 L/min) max. 8279SMF12	288.30	Chrome	6
 <ul style="list-style-type: none"> • connection size: 1/2" IPS • spout not included • vandal resistant: yes • cartridge type: ceramic hot/cold • mount type: centerset • drain assembly not included • wrist blade handle • material: brass 	8276	230.80	Chrome	6



M•DURA™ Heavy-Duty Faucets

	MODEL	LIST	FINISH/CONNECT	CASE QTY
WIDESPREAD GOOSENECK FAUCET				
 <ul style="list-style-type: none"> • connection size: 1/2" IPS • vandal resistant: yes • cartridge type: ceramic hot/cold • spout reach: 5.25" • flow type: aerated • mount type: widespread • drain assembly not included • wrist blade handle • material: brass 		1.2 GPM (4.5 L/min) max.		
	8248	344.35	Chrome	6
 <ul style="list-style-type: none"> • connection size: 1/2" IPS • vandal resistant: yes • cartridge type: ceramic hot/cold • spout reach: 5.25" • flow type: aerated • mount type: widespread • drain assembly not included • smooth wrist blade handle • material: brass 		1.2 GPM (4.5 L/min) max.		
	8248SMF12	344.35	Chrome	3
 <ul style="list-style-type: none"> • connection size: 1/2" IPS • vandal resistant: yes • cartridge type: ceramic hot/cold • spout reach: 8.00" • flow type: aerated • mount type: widespread • drain assembly not included • wrist blade handle • material: brass 		1.5 GPM (5.7 L/min) max.		
	8225	351.60	Chrome	6
 <ul style="list-style-type: none"> • includes optional 1.5 gpm laminar flow spout base conversion kit • connection size: 1/2" IPS • vandal resistant: yes • cartridge type: ceramic hot/cold • spout reach: 8.00" • flow type: vandal resistant aerated • mount type: widespread • drain assembly not included • smooth wrist blade handle • material: brass 		1.5 GPM (5.7 L/min) max. aerated / 1.5 GPM (5.7 L/min) max. laminar		
	8225SMF15	351.60	Chrome	3
 <ul style="list-style-type: none"> • connection size: 1/2" IPS • spout not included • vandal resistant: yes • cartridge type: ceramic hot/cold • mount type: widespread • drain assembly not included • wrist blade handle • material: brass 				
	8229	293.15	Chrome	6
 <ul style="list-style-type: none"> • connection size: 1/2" IPS • vandal resistant: yes • cartridge type: ceramic hot/cold • spout reach: 8.00" • flow type: vandal resistant aerated • mount type: widespread • drain assembly not included • lever handle • material: brass 		1.5 GPM (5.7 L/min) max.		
	8227	330.20	Chrome	6
 <ul style="list-style-type: none"> • connection size: 1/2" IPS • spout not included • vandal resistant: yes • cartridge type: ceramic hot/cold • mount type: widespread • drain assembly not included • lever handle • material: brass 				
	8226	271.65	Chrome	6

















COMMERCIAL

See Commercial Product Icon Key, page 618

M•DURA™ Heavy-Duty Kitchen Faucets

	MODEL	LIST	FINISH/CONNECT	CASE QTY
TWO-HANDLE KITCHEN FAUCET				
 <ul style="list-style-type: none"> • connection size: 1/2" IPS • vandal resistant: yes • cartridge type: ceramic hot/cold • spout reach: 8.00" • flow type: aerated • mount type: widespread • side spray included • drain assembly not included • lever handle • material: brass 	1.5 GPM (5.7 L/min) max.			
	8242	378.75	Chrome	6
 <ul style="list-style-type: none"> • connection size: 1/2" IPS • vandal resistant: yes • cartridge type: ceramic hot/cold • spout reach: 8.00" • flow type: aerated • mount type: widespread • side spray included • drain assembly not included • wrist blade handle • material: brass 	1.5 GPM (5.7 L/min) max.			
	8244	400.05	Chrome	6
 <ul style="list-style-type: none"> • connection size: 1/2" IPS • vandal resistant: yes • cartridge type: ceramic hot/cold • spout reach: 8.00" • flow type: aerated • drain assembly not included • lever handle • material: brass 	1.5 GPM (5.7 L/min) max.			
	8287	324.55	Chrome	6
 <ul style="list-style-type: none"> • connection size: 1/2" IPS • spout not included • vandal resistant: yes • cartridge type: ceramic hot/cold • drain assembly not included • lever handle • material: brass 				
	8280	260.40	Chrome	6
 <ul style="list-style-type: none"> • connection size: 1/2" IPS • vandal resistant: yes • cartridge type: ceramic hot/cold • spout reach: 8.00" • flow type: aerated • drain assembly not included • wrist blade handle • material: brass 	1.5 GPM (5.7 L/min) max.			
	8289	345.80	Chrome	6
 <ul style="list-style-type: none"> • connection size: 1/2" IPS • spout not included • vandal resistant: yes • cartridge type: ceramic hot/cold • drain assembly not included • wrist blade handle • material: brass 				
	8285	281.75	Chrome	6





M•DURA™ Heavy-Duty Kitchen Faucets

	MODEL	LIST	FINISH/CONNECT	CASE QTY
ONE-HANDLE KITCHEN FAUCET				
 <ul style="list-style-type: none"> • connection size: 3/8" compression • vandal resistant: yes • cartridge type: 1255® Duralast® • spout reach 9.00" • flow type: aerated • supply length: 22" • temp. limit stop: yes • side spray: yes • drain assembly not included • lever handle • material: brass <p>  DURALAST®   </p>	<p>1.5 GPM (5.7 L/min) max.</p> <p>8707 190.45 Chrome 6</p>			
	 <ul style="list-style-type: none"> • connection size: 3/8" compression • vandal resistant: yes • cartridge type: 1255® Duralast® • spout reach 12.00" • flow type: aerated • supply length: 22" • temp. limit stop: yes • side spray: yes • drain assembly not included • lever handle • material: brass <p>  DURALAST®   </p>	<p>1.5 GPM (5.7 L/min) max.</p> <p>8717 282.25 Chrome 6</p>		
 <ul style="list-style-type: none"> • connection size: 3/8" compression • vandal resistant: yes • cartridge type: 1255® Duralast® • spout reach 9.00" • flow type: aerated • supply length: 22" • temp. limit stop: yes • drain assembly not included • lever handle • material: brass <p>  DURALAST®   </p>		<p>1.5 GPM (5.7 L/min) max.</p> <p>8701 159.85 Chrome 12</p>		
	ONE-HANDLE WALLMOUNT KITCHEN FAUCET			
 <ul style="list-style-type: none"> • connection size: 1/2" eccentric; IPS • vandal resistant: yes • cartridge type: 1255® Duralast® • spout reach 9.00" • flow type: aerated • mount type: wallmount • temp. limit stop: yes • drain assembly not included • lever handle • material: brass <p>  DURALAST®   </p>	<p>1.5 GPM (5.7 L/min) max.</p> <p>8713 479.65 Chrome 12</p>			

COMMERCIAL





















M•DURA™ Heavy-Duty Multi-Purpose Faucets

MODEL LIST FINISH/CONNECT CASE QTY

ONE-HANDLE MULTI-PURPOSE FAUCET				
	<ul style="list-style-type: none"> • connection size: 3/8" compression • vandal resistant: yes • cartridge type: 1255° Duralast® • flow type: aerated • mount type: widespread • supply length: 22" • temp. limit stop: yes • side spray: yes • drain assembly not included • lever handle • material: brass 	1.5 GPM (5.7 L/min) max.		
		8138	314.55	Chrome
	<ul style="list-style-type: none"> • connection size: 3/8" compression • vandal resistant: yes • cartridge type: 1255° Duralast® • flow type: aerated • mount type: widespread • supply length: 22" • temp. limit stop: yes • drain assembly not included • lever handle • material: brass 	1.5 GPM (5.7 L/min) max.		
		8137	264.25	Chrome
TWO-HANDLE CENTERSET UTILITY FAUCET				
	<ul style="list-style-type: none"> • connection size: 1/2" IPS • 3/4" garden hose thread • vandal resistant: yes • cartridge type: ceramic hot/cold • spout reach: 6.50" • flow type: vandal resistant aerated • mount type: centerset • drain assembly not included • lever handle • material: brass 	Unrestricted		
		8277	233.90	Chrome
TWO-HANDLE WALLMOUNT UTILITY FAUCET				
	<ul style="list-style-type: none"> • connection size: 1/2" eccentric; IPS • vandal resistant: yes • cartridge type: ceramic hot/cold • spout reach 12.00" • flow type: aerated • mount type: wallmount • drain assembly not included • lever handle • material: brass 	1.5 GPM (5.7 L/min) max.		
		8119	327.30	Chrome
	<ul style="list-style-type: none"> • connection size: 1/2" eccentric; IPS • vandal resistant: yes • cartridge type: ceramic hot/cold • spout reach 8.00" • flow type: aerated • mount type: wallmount • drain assembly not included • wrist blade handle • material: brass 	1.5 GPM (5.7 L/min) max.		
		8126	328.15	Chrome

COMMERCIAL

M•DURA™ Heavy-Duty Laboratory Faucets

	MODEL	LIST	FINISH/CONNECT	CASE QTY
TWO-HANDLE WALLMOUNT SERVICE SINK FAUCET				
 <ul style="list-style-type: none"> • connection size: 1/2" eccentric IPS • 3/4" garden hose thread • vandal resistant: yes • cartridge type: ceramic hot/cold • spout reach: 9.38" • mount type: wallmount • wall bracket and vacuum breaker included • pail hook included • drain assembly not included • lever handle • material: brass <p>    </p>	Unrestricted			
	8230	225.00	Chrome	3
 <ul style="list-style-type: none"> • connection size: 1/2" eccentric IPS • 3/4" garden hose thread • vandal resistant: yes • cartridge type: ceramic hot/cold • spout reach: 10.25" • mount type: wallmount • wall bracket, vacuum breaker, and backflow preventers included • pail hook included • drain assembly not included • lever handle • material: brass <p>    </p>	Unrestricted			
	8124	277.40	Chrome	6
ONE-HANDLE LABORATORY FAUCET				
 <ul style="list-style-type: none"> • connection size: 3/8" compression • vandal resistant: yes • cartridge type: ceramic hot/cold • spout reach: 5.25" • flow type: aerated • mount type: single mount • supply length: 22" • cold only: yes • drain assembly not included • lever handle • material: brass <p>    </p>	2.2 GPM (8.3 L/min) max.			
	8103	188.45	Chrome	6
TWO-HANDLE LABORATORY FAUCET				
 <ul style="list-style-type: none"> • connection size: 3/8" compression • vandal resistant: yes • cartridge type: ceramic hot/cold • spout reach: 5.25" • flow type: aerated • mount type: single mount • supply length: 22" • drain assembly not included • lever handle • material: brass <p>    </p>	2.2 GPM (8.3 L/min) max.			
	8113	279.20	Chrome	6
 <ul style="list-style-type: none"> • connection size: 3/8" compression • serrated hose nozzle • vandal resistant: yes • cartridge type: ceramic hot/cold • spout reach: 6.00" • mount type: single mount • supply length: 22" • vacuum braker included • drain assembly not included • lever handle • material: brass <p>    </p>	Unrestricted			
	8116	345.15	Chrome	6

COMMERCIAL

M•DURA™ Heavy-Duty Spouts

DOUBLE-BEND SPOUTS



S0003



S0010

Model Number	Reach	Base to Aerator*	Overall Height	Weight Each Pounds	Case Quantity	List Price
S0000 ▲	6.00"	2.00"	4.325"	0.89	12	57.00
S0001 ▲	6.00"	3.75"	7.375"	1.20	12	68.55
S0002 ▲	6.00"	5.00"	9.125"	1.64	12	70.00
S0003 ▲	6.00"	5.75"	9.75"	1.60	12	68.55
S0004 ▲	6.00"	8.50"	12.75"	1.71	12	82.35
S0007 ▲	8.00"	6.00"	9.75"	1.90	12	70.00
S0009 ▲	10.00"	5.75"	9.75"	2.20	12	75.45
S0010 ▲	12.00"	0.50"	3.125"	1.40	12	82.35
S0011 ▲	12.00"	6.00"	9.75"	1.64	12	68.55

MULTI-BEND SPOUTS



Model Number	Reach	Base to Aerator*	Overall Height	Weight Each Pounds	Case Quantity	List Price
S0012 ▲	18.00"	3.75"	7.75"	2.40	12	149.65

VACUUM-BREAKER SPOUTS



SV003

Model Number	Reach	Base to Aerator*	Overall Height	Weight Each Pounds	Case Quantity	List Price
SV003 ■	6.00"	5.75"	10.50"	2.15	12	141.35
SV006 ■	8.00"	0.50"	4.00"	1.40	12	131.80
SV010 ■	12.00"	0.50"	4.00"	1.70	12	138.65

All spouts include 2.2 gpm [8.3 lpm] max. aerators (except as noted below). Spouts are designed for use only with 8100 and 8200 series aerators.

* Height from spout nut base plane to aerator

** Threaded-end gooseneck spouts – spout tip is threaded, no aerator included

*** Smooth-end gooseneck spouts – spout tip is smooth and will not take an aerator; flow is controlled by 1.5gpm laminar flow spout base insert.

M•DURA™ Heavy-Duty Spouts

GOOSENECK SPOUTS



Model Number	Reach	Base to Aerator*	Overall Height	Weight Each Pounds	Case Quantity	List Price
S0020 ▲	3.625"	6.25"	8.75"	1.47	12	70.00
S0030 ▲	5.25"	5.50"	10.00"	1.55	12	76.90
S0050 ▲	8.00"	6.125"	11.375"	1.65	12	85.10
S0060 ▲	8.00"	10.00"	12.00"	1.10	12	105.75
S0070 ▲	9.50"	6.50"	9.175"	1.81	12	92.00

THREADED-END GOOSENECK SPOUTS



S0050T

Model Number	Reach	Base to Aerator**	Overall Height	Weight Each Pounds	Case Quantity	List Price
S0030T ▲	5.25"	N/A	10.00"	1.55	12	59.30
S0050T ▲	8.00"	N/A	11.375"	1.85	12	67.45

SMOOTH-END GOOSENECK SPOUTS



Model Number	Reach	Base to Aerator***	Overall Height	Weight Each Pounds	Case Quantity	List Price
S0030NA ▲	5.25"	8.125"	10.00"	1.15	6	79.20

LAMINAR FLOW KITS



Model Number	Description	List Price
52655	laminar flow spout, flow control in base spout, 0.5 gpm (1.9 L/m)	33.00
52652	laminar flow spout, flow control in base spout, 1.5 gpm (5.7 L/m)	34.45
52653	laminar flow spout, flow control in base spout, 1.0 gpm (3.8 L/m)	20.75

All spouts include 2.2 gpm [8.3 lpm] max. aerators (except as noted below). Spouts are designed for use only with 8100 and 8200 series aerators.

- * Height from spout nut base plane to aerator
- ** Threaded-end gooseneck spouts - spout tip is threaded, no aerator included
- *** Smooth-end gooseneck spouts - spout tip is smooth and will not take an aerator; flow is controlled by 1.5gpm laminar flow spout base insert.









M•PRESS™ Heavy-Duty Metering Faucets



M•PRESS Single-Mount Metering Faucet / 8884

M•PRESS™ Heavy-Duty Metering Faucets

	MODEL	LIST	FINISH/CONNECT	CASE QTY
ECO-PERFORMANCE SINGLE-MOUNT METERING FAUCET				
 <ul style="list-style-type: none"> • connection size: 1/2" IPS • vandal resistant: yes • flow type: vandal resistant multi-laminar • mount type: single mount • timing preset: yes • drain assembly not included • material: brass 		Ø 0.5 GPM (1.9 L/min) max.		
	8884	194.70	Chrome	6
4" DECKPLATE SOLD SEPARATELY				
	99550	34.95	Chrome	12
ECO-PERFORMANCE SINGLE-MOUNT EXTENDED REACH METERING FAUCET				
 <ul style="list-style-type: none"> • connection size: 1/2" IPS • vandal resistant: yes • flow type: vandal resistant multi-laminar • mount type: single mount • timing preset: yes • drain assembly not included • material: brass 		Ø 0.5 GPM (1.9 L/min) max.		
	8894	221.10	Chrome	6
4" DECKPLATE SOLD SEPARATELY				
	99551	34.95	Chrome	12
ECO-PERFORMANCE CENTERSET METERING FAUCET				
 <ul style="list-style-type: none"> • connection size: 1/2" IPS • vandal resistant: yes • flow type: vandal resistant multi-laminar • mount type: centerset • timing preset: yes • drain assembly not included • material: brass 		Ø 0.5 GPM (1.9 L/min) max.		
	8886	358.90	Chrome	6
ECO-PERFORMANCE WIDESPREAD METERING FAUCET				
 <ul style="list-style-type: none"> • connection size: 1/2" IPS • vandal resistant: yes • flow type: vandal resistant multi-laminar • mount type: widespread • timing preset: yes • drain assembly not included • material: brass 		Ø 0.5 GPM (1.9 L/min) max.		
	8889	459.40	Chrome	6
DURAMETER METERING CARTRIDGE				
 <ul style="list-style-type: none"> • brass pressure-independent replacement cartridge 	52100	97.45	N/A or Unfinished	24
MANUAL-TO-METERING CONVERSION KIT				
 <ul style="list-style-type: none"> • excludes 8242, 8244 and modern lavs • includes hot/cold color indicator rings 	52120	180.85	Chrome	12











M•BITION™ Medium-Duty Faucets



M•BITION Single-Handle Lavatory Faucet / 8430 Series

M•BITION™ Medium-Duty Lavatory Faucets

















	MODEL	LIST	FINISH/CONNECT	CASE QTY
SINGLE-MOUNT LAVATORY FAUCET				
 <ul style="list-style-type: none"> • connection size: 3/8" compression • vandal resistant: yes • cartridge type: 1255® Duralast® • flow type: vandal resistant aerated • mount type: single mount • supply length: 24" • temp. limit stop: yes • drain assembly not included • no lift rod hole • lever handle <p> DURALAST®  </p>	▲ 1.2 GPM (4.5 L/min) max.			
	9480	175.15	Chrome	3
	4" DECKPLATE SOLD SEPARATELY			
	99559	38.25	Chrome	20
 <ul style="list-style-type: none"> • connection size: 3/8" compression • vandal resistant: yes • cartridge type: 1255® Duralast® • flow type: vandal resistant aerated • mount type: single mount • supply length: 24" • temp. limit stop: yes • drain assembly: metal • lever handle <p> DURALAST®  </p>	▲ 1.2 GPM (4.5 L/min) max.			
	9482	194.60	Chrome	3
	4" DECKPLATE SOLD SEPARATELY			
	99559	38.25	Chrome	20

COMMERCIAL

















M•BITION™ Medium-Duty Lavatory Faucets

	MODEL	LIST	FINISH/CONNECT	CASE QTY
ONE-HANDLE CENTERSET LAVATORY FAUCET				
 <ul style="list-style-type: none"> • connection size: 1/2" IPS • vandal resistant: yes • cartridge type: 1255® Duralast® • flow type: vandal resistant aerated • mount type: centerset • temp. limit stop: yes • drain assembly not included • removable plug button in lift rod hole • lever handle <p>  DURALAST®   </p>	🔥 1.2 GPM (4.5 L/min) max. 8400	193.85	Chrome	12
	 <ul style="list-style-type: none"> • connection size: 1/2" IPS • vandal resistant: yes • cartridge type: 1255® Duralast® • flow type: vandal resistant aerated • mount type: centerset • temp. limit stop: yes • drain assembly: metal • lever handle <p>  DURALAST®   </p>	🔥 1.2 GPM (4.5 L/min) max. 8420	224.95	Chrome
 <ul style="list-style-type: none"> • connection size: 1/2" IPS • vandal resistant: yes • cartridge type: 1255® Duralast® • flow type: vandal resistant aerated • mount type: centerset • temp. limit stop: yes • drain assembly: grid strainer waste • lever handle <p>  DURALAST®   </p>		🔥 1.2 GPM (4.5 L/min) max. 8425	219.05	Chrome
	 <ul style="list-style-type: none"> • connection size: 3/8" compression • vandal resistant: yes • cartridge type: 1255® Duralast® • flow type: vandal resistant aerated • mount type: centerset • supply length: 28" • temp. limit stop: yes • drain assembly not included • removable plug button in lift rod hole • lever handle <p>  DURALAST®   </p>	🔥 1.2 GPM (4.5 L/min) max. 8422	203.35	Chrome
🔥 0.5 GPM (1.9 L/min) max. 8422F05		203.35	Chrome	12
 <ul style="list-style-type: none"> • connection size: 1/2" IPS • vandal resistant: yes • cartridge type: 1255® Duralast® • flow type: vandal resistant aerated • mount type: centerset • temp. limit stop: yes • drain assembly not included • removable plug button in lift rod hole • lever handle <p>  DURALAST®   </p>		🔥 1.2 GPM (4.5 L/min) max. 8430	151.55	Chrome
	8430CBN	197.05	Classic Brushed Nickel	12
	🔥 0.5 GPM (1.9 L/min) max. 8430F05	151.55	Chrome	12
 <ul style="list-style-type: none"> • connection size: 1/2" IPS • vandal resistant: yes • cartridge type: 1255® Duralast® • flow type: vandal resistant aerated • mount type: centerset • temp. limit stop: yes • drain assembly: metal • lever handle <p>  DURALAST®   </p>	🔥 1.2 GPM (4.5 L/min) max. 8432	186.55	Chrome	12
	🔥 0.5 GPM (1.9 L/min) max. 8432F05	186.55	Chrome	12

M•BITION™ Medium-Duty Lavatory Faucets





		MODEL	LIST	FINISH/CONNECT	CASE QTY
ONE-HANDLE CENTERSET LAVATORY FAUCET (CONTINUED)					
 <ul style="list-style-type: none"> • connection size: 1/2" IPS • vandal resistant: yes • cartridge type: 1255° Duralast® • flow type: vandal resistant aerated • mount type: centerset • temp. limit stop: yes • drain assembly: grid strainer waste • removable plug button in lift rod hole • lever handle <p>  DURALAST®   </p>	<p>🔥 1.2 GPM (4.5 L/min) max.</p> <p>8434</p>	179.85	Chrome	12	
	 <ul style="list-style-type: none"> • connection size: 3/8" compression • vandal resistant: yes • cartridge type: 1255° Duralast® • flow type: vandal resistant aerated • mount type: centerset • supply length: 28" • temp. limit stop: yes • drain assembly not included • removable plug button in lift rod hole • lever handle <p>  DURALAST®   </p>	<p>🔥 1.2 GPM (4.5 L/min) max.</p> <p>8439</p>	161.35	Chrome	12
 <ul style="list-style-type: none"> • connection size: 3/8" compression • vandal resistant: yes • cartridge type: 1255° Duralast® • flow type: vandal resistant aerated • mount type: centerset • supply length: 28" • temp. limit stop: yes • drain assembly: metal • lever handle <p>  DURALAST®   </p>		<p>🔥 0.5 GPM (1.9 L/min) max.</p> <p>8439F05</p>	161.35	Chrome	12
	 <ul style="list-style-type: none"> • connection size: 3/8" compression • vandal resistant: yes • cartridge type: 1255° Duralast® • flow type: vandal resistant aerated • mount type: centerset • supply length: 28" • temp. limit stop: yes • drain assembly: metal • lever handle <p>  DURALAST®   </p>	<p>🔥 1.2 GPM (4.5 L/min) max.</p> <p>8437</p>	196.25	Chrome	12
		8437CBN	255.15	Classic Brushed Nickel	12

M•BITION™ Medium-Duty Lavatory Faucets













	MODEL	LIST	FINISH/CONNECT	CASE QTY
WIDESPREAD LAVATORY FAUCET				
 <ul style="list-style-type: none"> • connection size: 1/2" IPS • vandal resistant: yes • cartridge type: 1244 • flow type: aerated • mount type: widespread • drain type: lift rod • drain assembly: metal • lever handle 	1.2 GPM (4.5 L/min) max. 8922	278.75	Chrome	6
	 <ul style="list-style-type: none"> • connection size: 1/2" IPS • vandal resistant: yes • cartridge type: 1244 • flow type: aerated • mount type: widespread • drain assembly: grid strainer waste • lever handle 	1.2 GPM (4.5 L/min) max. 8924	298.30	Chrome
TWO-HANDLE CENTERSET LAVATORY FAUCET				
 <ul style="list-style-type: none"> • connection size: 1/2" IPS • vandal resistant: yes • cartridge type: 1244 • flow type: vandal resistant aerated • mount type: centerpiece • drain assembly not included • removable plug button in lift rod hole • wrist blade handle 	1.2 GPM (4.5 L/min) max. 8800	179.90	Chrome	6
	 <ul style="list-style-type: none"> • connection size: 1/2" IPS • vandal resistant: yes • cartridge type: 1244 • flow type: vandal resistant aerated • mount type: centerpiece • drain assembly: grid drain waste • removable plug button in lift rod hole • wrist blade handle 	0.5 GPM (1.9 L/min) max. 8800F05	179.90	Chrome
 <ul style="list-style-type: none"> • connection size: 1/2" IPS • vandal resistant: yes • cartridge type: 1244 • flow type: vandal resistant aerated • mount type: centerpiece • drain assembly: grid drain waste • removable plug button in lift rod hole • wrist blade handle 	1.2 GPM (4.5 L/min) max. 8810	206.25	Chrome	6
	 <ul style="list-style-type: none"> • connection size: 1/2" IPS • vandal resistant: yes • cartridge type: 1244 • flow type: vandal resistant aerated • mount type: centerpiece • drain assembly: metal • wrist blade handle 	1.2 GPM (4.5 L/min) max. 8820	212.50	Chrome
 <ul style="list-style-type: none"> • connection size: 1/2" IPS • vandal resistant: yes • cartridge type: 1244 • spout reach: 6.00" • flow type: aerated • mount type: centerpiece • drain assembly not included • removable plug button in lift rod hole • lever handle 	1.2 GPM (4.5 L/min) max. 8915	132.25	Chrome	12
	 <ul style="list-style-type: none"> • connection size: 1/2" IPS • vandal resistant: yes • cartridge type: 1244 • spout reach: 6.00" • flow type: aerated • mount type: centerpiece • drain assembly: metal • lever handle 	1.2 GPM (4.5 L/min) max. 8917	155.90	Chrome

COMMERCIAL

M•BITION™ Medium-Duty Kitchen Faucets

	MODEL	LIST	FINISH/CONNECT	CASE QTY
TWO-HANDLE KITCHEN FAUCET				
 <ul style="list-style-type: none"> • connection size: 1/2" IPS • vandal resistant: yes • cartridge type: 1244 • spout reach: 8.50" • flow type: aerated • side spray: yes • drain assembly not included • lever handle 	2.0 GPM (7.6 L/min) max.			
	8792	295.60	Chrome	6
 <ul style="list-style-type: none"> • connection size: 1/2" IPS • vandal resistant: yes • cartridge type: 1244 • spout reach: 9.00" • flow type: aerated • drain assembly not included • lever handle 	1.5 GPM (5.7 L/min) max.			
	8780	129.50	Chrome	6
 <ul style="list-style-type: none"> • connection size: 1/2" IPS • vandal resistant: yes • cartridge type: 1244 • spout reach: 9.00" • flow type: aerated • drain assembly not included • wrist blade handle 	1.5 GPM (5.7 L/min) max.			
	8798	207.60	Chrome	6
 <ul style="list-style-type: none"> • connection size: 1/2" IPS • vandal resistant: yes • cartridge type: 1244 • spout reach: 8.50" • flow type: aerated • drain assembly not included • wrist blade handle 	1.5 GPM (5.7 L/min) max.			
	8799	270.60	Chrome	6

M•BITION™ Medium-Duty Bar/Pantry Faucets

	MODEL	LIST	FINISH/CONNECT	CASE QTY
TWO-HANDLE BAR/PANTRY FAUCET				
 <ul style="list-style-type: none"> • connection size: 1/2" IPS • vandal resistant: yes • cartridge type: 1244 • spout reach: 4.56" • flow type: aerated • mount type: centerset • drain assembly not included • wrist blade handle   	1.2 GPM (4.5 L/min) max.			
	8938	179.35	Chrome	6
 <ul style="list-style-type: none"> • connection size: 1/2" IPS • vandal resistant: yes • cartridge type: 1244 • spout reach: 4.56" • flow type: aerated • mount type: centerset • drain assembly not included • lever handle   	1.2 GPM (4.5 L/min) max.			
	8957	138.15	Chrome	12
 <ul style="list-style-type: none"> • connection size: 1/2" IPS • vandal resistant: yes • cartridge type: 1244 • spout reach: 4.75" • flow type: aerated • mount type: centerset • drain assembly not included • wrist blade handle   	1.2 GPM (4.5 L/min) max.			
	8948	176.95	Chrome	6











M•POWER™ Below-Deck Sensor-Operated Faucets & Soap Dispensers



Align® Below-Deck Sensor-Operated Modern Faucet / 8559

Align® Below-Deck Sensor-Operated Modern Soap Dispenser / 8560

M•POWER™ Sensor-Operated Faucets



		MODEL	LIST	FINISH/CONNECT	CASE QTY			
ALIGN® BELOW-DECK SENSOR-OPERATED MODERN FAUCET								
 <ul style="list-style-type: none"> • connection size: 3/8" compression • vandal resistant: yes • power source: 4AA included with optional AC* • flow type: vandal resistant multi-laminar • mount type: single mount • supply length: 24" • non-mixing: yes • drain assembly not included • material: brass 	<p>Ø 0.5 GPM (1.9 L/min) max.</p> <p>8559 615.25 Chrome 6</p> <p>8559BN 769.05 Brushed Nickel 6</p> <p>8559BL 830.60 Matte Black 6</p> <p>4" DECKPLATE SOLD SEPARATELY</p> <p>182546 37.45 Chrome 12</p> <p>182546BN 46.80 Brushed Nickel 12</p> <p>182546BL 51.50 Matte Black 12</p> <p>8" DECKPLATE SOLD SEPARATELY</p> <p>99558 49.15 Chrome 20</p> <p>99558BN 61.45 Brushed Nickel 20</p> <p>99558BL 67.55 Matte Black 20</p>							
	ALIGN® BELOW-DECK SENSOR-OPERATED MODERN SOAP DISPENSER							
	 <ul style="list-style-type: none"> • easily refillable 1500ml foam soap reservoir included • material: brass 	<p>8560 539.15 Chrome 3</p> <p>8560BN 673.95 Brushed Nickel 3</p> <p>8560BL 727.85 Matte Black 3</p> <p>BRASS SPACER SOLD SEPARATELY</p> <p>181149 71.10 Chrome 12</p> <p>181149BN 88.90 Brushed Nickel 12</p> <p>181149BL 96.00 Matte Black 12</p>						
		BELOW-DECK SENSOR-OPERATED TRANSITIONAL CENTERSET FAUCET						
		 <ul style="list-style-type: none"> • connection size: 3/8" compression • vandal resistant: yes • power source: 4AA included with optional AC* • flow type: vandal resistant laminar • mount type: centerset • supply length: 24" • non-mixing: yes • drain assembly not included • material: brass 	<p>Ø 0.5 GPM (1.9 L/min) max.</p> <p>CA8301 623.50 Chrome 3</p> <p>CA8301BN 779.40 Brushed Nickel 3</p> <p>CA8301BL 841.75 Matte Black 3</p>					
			BELOW-DECK SENSOR-OPERATED TRANSITIONAL FAUCET					
			 <ul style="list-style-type: none"> • connection size: 3/8" compression • vandal resistant: yes • power source: 4AA included with optional AC* • flow type: vandal resistant laminar • mount type: singlemount • supply length: 24" • non-mixing: yes • drain assembly not included • material: brass 	<p>Ø 0.5 GPM (1.9 L/min) max.</p> <p>CA8302 615.25 Chrome 6</p> <p>CA8302BN 769.05 Brushed Nickel 6</p> <p>CA8302BL 830.60 Matte Black 6</p> <p>4" DECKPLATE SOLD SEPARATELY</p> <p>182546 37.45 Chrome 12</p> <p>182546BN 46.80 Brushed Nickel 12</p> <p>182546BL 51.50 Matte Black 12</p> <p>8" DECKPLATE SOLD SEPARATELY</p> <p>99558 49.15 Chrome 20</p> <p>99558BN 61.45 Brushed Nickel 20</p> <p>99558BL 67.55 Matte Black 20</p>				
	BELOW-DECK SENSOR-OPERATED TRANSITIONAL SOAP DISPENSER							
	 <ul style="list-style-type: none"> • easily refillable 1500ml foam soap reservoir included • material: brass 	<p>8558 539.15 Chrome 3</p> <p>8558BN 673.95 Brushed Nickel 3</p> <p>8558BL 727.85 Matte Black 3</p> <p>BRASS SPACER SOLD SEPARATELY</p> <p>181148 82.20 Chrome 12</p> <p>181148BN 102.75 Brushed Nickel 12</p> <p>181148BL 111.00 Matte Black 12</p>						



*Convert to AC power with the following accessories: for single- or multi-unit AC applications, order one (1) multi-unit transformer (104630) which powers up to (8) units, and one (1) faucet AC connector (182538) per unit. See Commercial Product Icon Key, page 618



COMMERCIAL

M•POWER™ Sensor-Operated Faucets

MODEL LIST FINISH/CONNECT CASE QTY

BELOW-DECK SENSOR-OPERATED GOOSENECK MIXING FAUCET				
 <ul style="list-style-type: none"> • connection size: 3/8" compression • power source: 4AA included with optional AC* • flow type: multi-stream laminar • mount type: singlemount • supply length: 24" • drain assembly not included • material: brass 	Ø 0.5 GPM (1.9 L/min) max.			
	8562	1117.10	Chrome	3
	4" DECKPLATE SOLD SEPARATELY			
	182546	37.45	Chrome	12
8" DECKPLATE SOLD SEPARATELY				
99558	49.15	Chrome	20	

BELOW-DECK SENSOR-OPERATED GOOSENECK FAUCET				
 <ul style="list-style-type: none"> • connection size: 3/8" compression • vandal resistant: yes • power source: 4AA included with optional AC* • flow type: vandal resistant multi-laminar • mount type: singlemount • supply length: 24" • non-mixing: yes • drain assembly not included • material: brass 	Ø 0.5 GPM (1.9 L/min) max.			
	CA8303	693.80	Chrome	3
	4" DECKPLATE SOLD SEPARATELY			
	182546	37.45	Chrome	12
8" DECKPLATE SOLD SEPARATELY				
99558	49.15	Chrome	20	

BELOW-DECK SENSOR-OPERATED FAUCET WITHOUT SPOUT				
 <ul style="list-style-type: none"> • connection size: 3/8" compression • vandal resistant: yes • power source: 4AA included with optional AC* • mount type: singlemount • supply length: 24" • non-mixing: yes • drain assembly not included • material: brass • spout not included 	8565	639.80	Chrome	3
	4" DECKPLATE SOLD SEPARATELY			
	182546	37.45	Chrome	12
	8" DECKPLATE SOLD SEPARATELY			
99558	49.15	Chrome	20	

GRID DRAIN WITH OVER-FLOW				
 <ul style="list-style-type: none"> • grid strainer • tail piece • drain body 	123816	31.50	Chrome	12

*Convert to AC power with the following accessories: for single- or multi-unit AC applications, order one (1) multi-unit transformer (104630) which powers up to (8) units, and one (1) faucet AC connector (182538) per unit.

M•POWER™ Above-Deck Sensor-Operated Faucets









M•POWER Above-Deck Sensor-Operated Lavatory Faucet / 8551 Series

M•POWER™ Sensor-Operated Faucets

		MODEL	LIST	FINISH/CONNECT	CASE QTY
ABOVE-DECK SENSOR-OPERATED MODERN FAUCET					
 <ul style="list-style-type: none"> • connection size: 3/8" compression • vandal resistant: yes • power source: battery powered 4AA included • flow type: vandal resistant multi-laminar • mount type: single mount • supply length: 24" • non-mixing: yes • drain assembly not included 		Ø 0.5 GPM (1.9 L/min) max.			
	8551	644.95	Chrome	6	
		4" DECKPLATE SOLD SEPARATELY			
	99556	38.25	Chrome	20	
	8" DECKPLATE SOLD SEPARATELY				
	99558	49.15	Chrome	20	
AC ABOVE-DECK SENSOR-OPERATED MODERN FAUCET					
 <ul style="list-style-type: none"> • connection size: 3/8" compression • vandal resistant: yes • power source: AC power • flow type: vandal resistant multi-laminar • mount type: single mount • supply length: 24" • non-mixing: yes • drain assembly not included 		Ø 0.5 GPM (1.9 L/min) max.			
	8551AC	663.95	Chrome	6	
		4" DECKPLATE SOLD SEPARATELY			
	99556	38.25	Chrome	20	
	8" DECKPLATE SOLD SEPARATELY				
	99558	49.15	Chrome	20	
ABOVE-DECK SENSOR-OPERATED MODERN MIXING FAUCET					
 <ul style="list-style-type: none"> • connection size: 3/8" compression • vandal resistant: yes • power source: battery powered 4AA included • flow type: vandal resistant multi-laminar • mount type: single mount • supply length: 24" • temperature & manual override: yes • drain assembly not included • handle type: lever 		Ø 0.5 GPM (1.9 L/min) max.			
	8552	719.95	Chrome	6	
		4" DECKPLATE SOLD SEPARATELY			
	99556	38.25	Chrome	20	
	8" DECKPLATE SOLD SEPARATELY				
	99558	49.15	Chrome	20	
AC ABOVE-DECK SENSOR-OPERATED MODERN MIXING FAUCET					
 <ul style="list-style-type: none"> • connection size: 3/8" compression • vandal resistant: yes • power source: AC powered • flow type: vandal resistant multi-laminar • mount type: single mount • supply length: 24" • temperature & manual override: yes • drain assembly not included • handle type: lever 		Ø 0.5 GPM (1.9 L/min) max.			
	8552AC	719.95	Chrome	6	
		4" DECKPLATE SOLD SEPARATELY			
	99556	38.25	Chrome	20	
	8" DECKPLATE SOLD SEPARATELY				
	99558	49.15	Chrome	20	
ABOVE-DECK SENSOR-OPERATED TRANSITIONAL FAUCET					
 <ul style="list-style-type: none"> • connection size: 3/8" compression • vandal resistant: yes • power source: battery powered 4AA included • flow type: vandal resistant multi-laminar • mount type: single mount • supply length: 24" • non-mixing: yes • drain assembly not included 		Ø 0.5 GPM (1.9 L/min) max.			
	8553	644.95	Chrome	6	
	8553BN	806.20	Brushed Nickel	6	
	8553BL	870.70	Matte Black	6	
		4" DECKPLATE SOLD SEPARATELY			
	99557	38.25	Chrome	20	
	99557BN	47.85	Brushed Nickel	20	
	99557BL	52.60	Matte Black	20	
	8" DECKPLATE SOLD SEPARATELY				
	99558	49.15	Chrome	20	
	99558BN	61.45	Brushed Nickel	20	
	99558BL	67.55	Matte Black	20	

COMMERCIAL

M•POWER™ Sensor-Operated Faucets

		MODEL	LIST	FINISH/CONNECT	CASE QTY	
AC ABOVE-DECK SENSOR-OPERATED TRANSITIONAL FAUCET						
 <ul style="list-style-type: none"> • connection size: 3/8" compression • vandal resistant: yes • power source: AC powered • flow type: vandal resistant multi-laminar • mount type: single mount • supply length: 24" • non-mixing: yes • drain assembly not included 	<ul style="list-style-type: none"> • connection size: 3/8" compression • vandal resistant: yes • power source: battery powered 4AA included • flow type: vandal resistant multi-laminar • mount type: single mount • supply length: 24" • temperature & manual override: yes • drain assembly not included • handle type: lever 	<ul style="list-style-type: none"> • connection size: 3/8" compression • vandal resistant: yes • power source: AC power • flow type: vandal resistant multi-laminar • mount type: single mount • supply length: 24" • temperature & manual override: yes • drain assembly not included • handle type: lever 				
	<p>Ø 0.5 GPM (1.9 L/min) max.</p>					
			8553AC	663.95	Chrome	6
			8553ACBN	829.95	Brushed Nickel	6
			8553ACBL	896.35	Matte Black	6
	4" DECKPLATE SOLD SEPARATELY					
			99557	38.25	Chrome	20
			99557BN	47.85	Brushed Nickel	20
			99557BL	52.60	Matte Black	20
	8" DECKPLATE SOLD SEPARATELY					
			99558	49.15	Chrome	20
			99558BN	61.45	Brushed Nickel	20
		99558BL	67.55	Matte Black	20	
ABOVE-DECK SENSOR-OPERATED TRANSITIONAL MIXING FAUCET						
	<p>Ø 0.5 GPM (1.9 L/min) max.</p>					
			8554	719.95	Chrome	6
			8554BN	899.95	Brushed Nickel	6
			8554BL	971.95	Matte Black	6
	4" DECKPLATE SOLD SEPARATELY					
			99557	38.25	Chrome	20
			99557BN	47.85	Brushed Nickel	20
			99557BL	52.60	Matte Black	20
	8" DECKPLATE SOLD SEPARATELY					
			99558	49.15	Chrome	20
			99558BN	61.45	Brushed Nickel	20
			99558BL	67.55	Matte Black	20
AC ABOVE-DECK SENSOR-OPERATED TRANSITIONAL MIXING FAUCET						
	<p>Ø 0.5 GPM (1.9 L/min) max.</p>					
			8554AC	719.95	Chrome	6
			8554ACBN	899.95	Brushed Nickel	6
			8554ACBL	971.95	Matte Black	6
	4" DECKPLATE SOLD SEPARATELY					
			99557	38.25	Chrome	20
			99557BN	47.85	Brushed Nickel	20
			99557BL	52.60	Matte Black	20
	8" DECKPLATE SOLD SEPARATELY					
			99558	49.15	Chrome	20
			99558BN	61.45	Brushed Nickel	20
			99558BL	67.55	Matte Black	20
LOW-FLOW THERMOSTATIC MIXING VALVE						
	<p>Ø 0.35 GPM (1.32 L/min) max.</p>					
			104451	185.95	Chrome	12

COMMERCIAL

M•POWER™ Sensor-Operated Faucets

THERMOSTATIC MIXING VALVE SERVICE KITS

Part No.	Description	List Price	Case Qty
175916	1/2" IPS Adapter Kit	17.55	12
175917	1/2" CC Adapter Kit	17.55	1
175918	1/2" Cold Expansion PEX Adapter Kit	17.55	12
181040	1/2" Crimp Ring PEX Adapter Kit	17.55	12
175921	3/8" Compression Adapter Kit	17.55	12
175925	Fitting Nut Kit	17.55	12
175926	Screen Washer and Seal Washer Kit	17.55	12

See 642 for sensor-operated faucet accessories.

	MODEL	LIST	FINISH/CONNECT	CASE QTY
GRID DRAIN WITH OVER-FLOW				
 <ul style="list-style-type: none"> • grid strainer • tail piece • drain body 	123816	62.00	Chrome	12
	123816BN	86.85	Brushed Nickel	12
	123816B L	95.90	Matte Black	12

LOW-FLOW THERMOSTATIC MIXING VALVE



- stainless steel box and cover with vandal resistant screws
- thermostatic mixing valve with adjustable temperature control cartridge
- 1/2" copper connection
- 1/4" turn stops
- hot/cold check valves prevent possible backflow on water supply inlets
- stainless steel internal strainer protects against line trash
- listed to ASSE standard 1070
- lavatory faucet application
- min. flow rate at 45 pso=0.35 gpm (1.32 lpm)

0.35 GPM (1.32 L/min) max.

15440	452.80	N/A or Unfinished	2
-------	--------	-------------------	---

MULTI-UNIT POWER AC TRANSFORMER



- 2 gang junction box
- powers up to 8 products
- input: 100/240V AC, 50-60 HZ
- output: +12V DC, 1.5A

104630	109.90	N/A or Unfinished	12
--------	--------	-------------------	----

COMMERCIAL

M•POWER™ Sensor-Operated Faucets

SENSOR-OPERATED FAUCET ACCESSORIES

Part No.	Description	List Price
174055	Battery Housing for Above and Below-Deck Models	35.05
174056	Solenoid Repair Kit for All Above-Deck SKUs 8551, 8552, 8553, 8554, 8551AC, 8552AC, 8553AC, 8554AC	111.40
174057	Strain Relief and Sensor Cable Extension for 8551-8554	30.95
174060	Mounting Hardware for All Above-Deck SKUs 8551, 8552, 8553, 8554, 8551AC, 8552AC, 8553AC, 8554AC	19.60
174061	Manual Temperature Control Handle Kit 8552, 8554, 8552AC, 8554AC	27.50
174061BN	Manual Temperature Control Handle Kit 8554, 8554CBN	34.40
174061BL	Manual Temperature Control Handle Kit 8554, 8554CBL	37.85
174062	T10 Torx Key and Screw for All Above-Deck SKUs 8551, 8552, 8553, 8554, 8551AC, 8552AC, 8553AC, 8554AC	10.15
174065	In-Line Filter with Check Valve for All Above-Deck SKUs 8551, 8552, 8553, 8554, 8551AC, 8552AC, 8553AC, 8554AC	55.60
174066	Filter Screen for Filter Housing for All Above-Deck SKUs 8551, 8552, 8553, 8554, 8551AC, 8552AC, 8553AC, 8554AC	6.45
174335	Sensor and Bracket for 8553, 8554, 8553AC, 8554AC	220.05
174336	Override Plug Button for 8552, 8552AC	21.85
174337	Override Plug Button for 8554, 8554AC	21.85
174337BN	Override Plug Button for 8554BN, 8554ACBN	27.30
174337BL	Override Plug Button for 8554BL, 8554ACBL	30.00
99556	4" Deckplate designed for 8551, 8551AC, 8552, 8552AC	38.25
99557	4" Deckplate designed for 8553, 8553AC, 8554, 8554AC	38.25
99557BN	4" Deckplate designed for 8553, 8553AC, 8554, 8554AC	47.85
99557BL	4" Deckplate designed for 8553, 8553AC, 8554, 8554AC	52.60
99558	8" Deckplate for 8559, CA8302, 8562, CA8303, 8565, 8551, 8551AC, 8552, 8552AC, 8553, 8553AC, 8554, 8554AC	49.15
99558BN	8" Deckplate for 8559, CA8302, 8562, CA8303, 8565, 8551, 8551AC, 8552, 8552AC, 8553, 8553AC, 8554, 8554AC	61.45
99558BL	8" Deckplate for 8559, CA8302, 8562, CA8303, 8565, 8551, 8551AC, 8552, 8552AC, 8553, 8553AC, 8554, 8554AC	67.55
52016F05	0.5 gpm Multi-Stream Laminar Flow Aerator	21.35
52016F10	1.0 gpm Aerator	21.35
S0030NA	Smooth-End Spout with 1.5 gpm Laminar Flow Base Insert	79.20
104630	Multi-Unit AC Transformer (powers up to 8 units)	113.20
182534	Control Box for Gooseneck and Above-Deck AC Models	57.45
182535	Control Box for CA83021, 8559, CA8302	154.80
182536	Control Box Wall Mounting Hardware	10.95
182537	IR Sensor Assembly and Bracket for Below-Deck Models	170.30
182538	AC Connector	24.10
182540	Cable Harness and Vandal Sleeve for Below-Deck Non-Mixing Models	58.30
182542	Centerset Deck Gasket for CA8301	18.70
182543	Transitional Deck Gasket for CA8302	18.60
182544	Modern Deck Gasket for 8559	18.60
182546	4" Deckplate for 8559, CA8302, 8562, CA8303, 8565	37.45
182546BN	4" Deckplate for 8559, CA8302, 8562, CA8303, 8565	46.80
182546BL	4" Deckplate for 8559, CA8302, 8562, CA8303, 8565	51.50
182547	Override Plug Button	27.05















SENSOR-OPERATED SOAP DISPENSER ACCESSORIES

Part No.	Description	List Price
182413	Non-Drip Foam Soap Pump	63.85
182414	1500mL Foam Soap Bottle	18.05
182415	Control Box for Sensor Soap	131.70
182416	Mounting Bracket, Vandal Shield and Mounting Hardware for Sensor Soap	108.95
182418	Soap Net	37.50
182420	Wire Vandal Sheathing for Sensor Soap	47.75
182421	D-Cell Battery Box for Sensor Soap	69.20
182422	Sensor, Bracket and Screw for Sensor Soap	170.30
181148	Transitional Deck Spacer for 8558	82.20
181148BN	Transitional Deck Spacer for 8558	102.75
181148BL	Transitional Deck Spacer for 8558	111.00
181149	Modern Deck Spacer for 8560	71.10
181149BN	Modern Deck Spacer for 8560	88.90
181149BL	Modern Deck Spacer for 8560	96.00

M•POWER™ Sensor-Operated Flush Valves





M•POWER™ Sensor-Operated Flush Valves

		MODEL	LIST	FINISH/CONNECT	CASE QTY	
1-1/2" DC SENSOR-OPERATED CLOSET FLUSH VALVE						
	<ul style="list-style-type: none"> flush valve type: water closet vandal resistant: yes battery-powered (4AA included) flush valve technology: accuset piston cast brass material easy front battery access mechanical override  	3.5 GPF (13.0 LPF)				
		8310S35	655.60	Chrome	3	
		1.6 GPF (6.0 LPF)				
		8310	655.60	Chrome	3	
		1.28 GPF (4.8 LPF)				
		8311	655.60	Chrome	3	
1-1/2" DC SENSOR-OPERATED CLOSET FLUSH VALVE - DUAL FLUSH						
	<ul style="list-style-type: none"> flush valve type: water closet dual flush vandal resistant: yes battery-powered (4AA included) flush valve technology: accuset piston cast brass material easy front battery access mechanical override  	1.0 GPF (3.8 LPF) and 1.6 GPF (6.0 LPF)				
		8310DF16	688.25	Chrome	3	
1-1/2" AC SENSOR-OPERATED CLOSET FLUSH VALVE						
	<ul style="list-style-type: none"> flush valve type: water closet vandal resistant: yes AC powered required 12V transformer: sold separately flush valve technology: accuset piston cast brass material easy front battery access mechanical override  	1.6 GPF (6.0 LPF)				
		8310AC16	655.60	Chrome	3	
		1.28 GPF (4.8 LPF)				
		8311AC12	655.60	Chrome	3	
1-1/2" AC SENSOR-OPERATED CLOSET FLUSH VALVE - DUAL FLUSH						
	<ul style="list-style-type: none"> flush valve type: water closet dual flush vandal resistant: yes AC powered required 12V transformer: sold separately flush valve technology: accuset piston cast brass material easy front battery access mechanical override  	1.0 GPF (3.8 LPF) and 1.6 GPF (6.0 LPF)				
		8310ACDF16	688.25	Chrome	3	
3/4" DC SENSOR-OPERATED URINAL FLUSH VALVE						
	<ul style="list-style-type: none"> flush valve type: urinal vandal resistant: yes battery-powered (4AA included) flush valve technology: accuset piston cast brass material easy front battery access mechanical override  	1.0 GPF (3.8 LPF)				
		8312	655.60	Chrome	3	
		0.5 GPF (1.9 LPF)				
		8315	655.60	Chrome	3	
		0.125 GPF (0.5 LPF)				
		8316	655.60	Chrome	3	

For one (1) or multi-unit AC applications, order one (1) multi-unit transformer [104630] which powers up to eight (8) units.

M•POWER™ Sensor-Operated Flush Valves

		MODEL	LIST	FINISH/CONNECT	CASE QTY
3/4" AC SENSOR-OPERATED URINAL FLUSH VALVE					
 <ul style="list-style-type: none"> • flush valve type: urinal • vandal resistant: yes • AC powered required 12V transformer: sold separately • flush valve technology: accuset piston • cast brass material • easy front battery access • mechanical override 		1.0 GPF (3.8 LPF)			
		8312AC10	655.60	Chrome	3
		0.5 GPF (1.9 LPF)			
		8315AC05	655.60	Chrome	3
		0.125 GPF (0.5 LPF)			
		8316AC	655.60	Chrome	3
DC SENSOR-OPERATED CLOSET FLUSH VALVE RETROFIT KIT					
 <ul style="list-style-type: none"> • flush valve type: water closet retrofit • vandal resistant: yes • battery-powered (4AA included) • flush valve technology: accuset piston • cast brass material • easy front battery access • mechanical override 		3.5 GPF (13.0 LPF)			
		8310SR35	548.60	Chrome	3
		1.6 GPF (6.0 LPF)			
		8310R16	548.60	Chrome	3
		1.28 GPF (4.8 LPF)			
		8310SR128	548.60	Chrome	3
DC SENSOR-OPERATED CLOSET FLUSH VALVE RETROFIT KIT - DUAL FLUSH					
 <ul style="list-style-type: none"> • flush valve type: water closet retrofit • dual flush • vandal resistant: yes • battery-powered (4AA included) • flush valve technology: accuset piston • cast brass material • easy front battery access • mechanical override 		1.0 GPF (3.8 LPF) and 1.6 GPF (6.0 LPF)			
		8310RDF16	575.90	Chrome	3
DC SENSOR-OPERATED URINAL FLUSH VALVE RETROFIT KIT					
 <ul style="list-style-type: none"> • flush valve type: urinal retrofit • vandal resistant: yes • battery-powered (4AA included) • flush valve technology: accuset piston • cast brass material • easy front battery access • mechanical override 		1.0 GPF (3.8 LPF)			
		8312R10	548.60	Chrome	3
		0.5 GPF (1.9 LPF)			
		8312SR05	548.60	Chrome	3
		0.125 GPF (0.5 LPF)			
		8312SR125	548.60	Chrome	3

COMMERCIAL

For one (1) or multi-unit AC applications, order one (1) multi-unit transformer (104630) which powers up to eight (8) units.

M•POWER™ Sensor-Operated Flush Valves**SENSOR-OPERATED FLUSH VALVE ACCESSORIES**









Part No.	Description	List Price
104585	1 ½" Flush Extension Tube-24"	141.75
104587	Flush Valve Trap Primer	172.75
104588	1" Sweat Kit, Flush Valve	32.50
104589	1" Sweat Kit, Flush Valve 6" Long	52.25
104555	1" Angle Stop Valve Flush Valve	132.20
104556	¾" Angle Stop Valve Flush Valve	132.20
104570	Vacuum Breaker Kit	21.65
104571	Brass Valve Body Nut Flush Valve	28.90
104578	1 ½" Brass Flush Valve Tube	55.20
104579	1 ¼" Brass Flush Tube	59.90
104580	¾" Brass Flush Tube	55.30
104581	1 ½" Top Spud Assembly	38.65
104582	1 ¼" Top Spud Assembly	35.15
104583	¾" Top Spud Assembly	30.30
104584	Urinal Tailpiece (24" x ¾")	89.95
104617	Flush Valve Battery Pack	35.00
104618	Front Shroud 1.6 gpf	82.80
104619	Front Shroud 1.28 gpf	82.80
104620	Front Shroud 3.5 gpf	82.80
104621	Front Shroud 1.0 gpf	82.80
104622	Front Shroud 0.5 gpf	82.80
104623	Front Shroud 1.0/1.6 gpf	82.80
104624	Front Shroud 0.125 gpf	82.80
104625	Rear Shroud DC	39.00
104626	Rear Shroud AC	40.05
104627	Flush Valve Override Assembly	37.30
104628	Piston and Manifold Tool	110.20
104630	Multi-Unit AC Transformer (powers up to 8 units)	113.20
104631	AC Cover Tube and Escutcheon	37.40
104633	Solenoid Manifold and Tool	133.35
104634	Flush Valve Override Cap	26.35

M•DURA™ Heavy-Duty Manual Flush Valves



M•DURA Heavy-Duty Manual Urinal Flush Valve / 8312M Series

M•DURA™ Heavy-Duty Manual Flush Valves

		MODEL	LIST	FINISH/CONNECT	CASE QTY	
1-1/2" MANUAL CLOSET FLUSH VALVE						
	<ul style="list-style-type: none"> flush valve type: water closet flush valve technology: accuset piston cast brass material  	3.5 GPF (13.0 LPF)				
		8310M35	204.25	Chrome	3	
		1.6 GPF (6.0 LPF)				
		8310M16	204.25	Chrome	3	
		1.28 GPF (4.8 LPF)				
		8310M128	204.25	Chrome	3	
3/4" MANUAL URINAL FLUSH VALVE						
	<ul style="list-style-type: none"> flush valve type: urinal flush valve technology: accuset piston cast brass material  	1.0 GPF (3.8 LPF)				
		8312M10	204.25	Chrome	3	
		0.5 GPF (1.9 LPF)				
		8312M05	204.25	Chrome	3	
		0.125 GPF (0.5 LPF)				
		8312M0125	204.25	Chrome	3	
MANUAL CLOSET FLUSH VALVE RETROFIT KIT						
	<ul style="list-style-type: none"> flush valve type: water closet retrofit flush valve technology: accuset piston cast brass material  	1.28 GPF (4.8 LPF)				
		8310MR128	164.35	Chrome	6	

M•DURA™ Heavy-Duty Manual Flush Valves**MANUAL FLUSH VALVE ACCESSORIES**

Part No.	Description	List Price
104540	M•DURA™ 2 1/4" Extension (standard) Nipple (compatible with Delany angle stops)	43.95
104541	M•DURA™ 1 3/4" Extension Nipple (compatible with Delany angle stops)	38.45
104542	M•DURA™ 2 3/4" Extension Nipple (compatible with Delany angle stops)	53.50
104543	M•DURA™ 3 1/4" Extension Nipple (compatible with Delany angle stops)	59.00
104544	M•DURA™ 3 3/4" Extension Nipple (compatible with Delany angle stops)	65.85
104545	M•DURA™ 4 1/4" Extension Nipple (compatible with Delany angle stops)	72.70
104546	M•DURA™ 2 1/8" Extension (standard) Nipple	38.45
104547	M•DURA™ 2 1/2" Extension Nipple	42.60
104548	M•DURA™ 3" Extension Nipple	45.30
104549	M•DURA™ 3 1/2" Extension Nipple	49.40
104550	M•DURA™ 4" Extension Nipple	54.95
104551	M•DURA™ 4 1/2" Extension Nipple	59.00
104552	M•DURA™ 5" Extension Nipple	65.85
104553	M•DURA™ 5 1/2" Extension Nipple	70.00
104554	M•DURA™ 6" Extension Nipple	75.45
104555	M•DURA™ 1" Angle Stop	132.20
104556	M•DURA™ 3/4" Angle Stop	132.20
104557	M•DURA™ Angle Stop Repair Kit	23.10
104560	M•DURA™ Offset Flush Tube 2 1/2" x 1 1/2"	51.35
104561	M•DURA™ Cap Assembly	72.45
104563	M•DURA™ 3.5 gpf (13.2 lpf) Piston	97.45
104564	M•DURA™ 1.6 gpf (6.0 lpf) Piston	97.45
104565	M•DURA™ 1.28 gpf (4.8 lpf) Piston	97.45
104566	M•DURA™ 1.0 gpf (3.8 lpf) Piston	97.45
104567	M•DURA™ 0.5 gpf (1.9 lpf) Piston	97.45
104568	M•DURA™ 0.125 gpf (0.5 lpf) Piston	97.45
104569	M•DURA™ Handle Assembly	29.30
104570	M•DURA™ Vacuum Breaker Assembly	21.65
104571	M•DURA™ Body Nut	28.90
104572	M•DURA™ Angle Stop Replacement Cap	7.50
104578	M•DURA™ Flush Tube 8 1/2" x 1 1/2"	55.20
104579	M•DURA™ Flush Tube 8" x 1 1/4"	59.90
104580	M•DURA™ Flush Tube 8" x 1 3/4"	55.30
104581	M•DURA™ 1 1/2" Top Spud Assembly	38.65
104582	M•DURA™ 1 1/4" Top Spud Assembly	35.15
104583	M•DURA™ 3/4" Top Spud Assembly	30.30
104584	M•DURA™ Flush Extension Tube 24" x 3/4"	89.95
104585	M•DURA™ Flush Extension Tube 24" x 1 1/2"	141.75
104588	M•DURA™ Sweat Kit (1" supply) 3" length	32.50
104589	M•DURA™ Sweat Kit (1" supply) 6" length	52.25
104590	M•DURA™ Cap Assembly with 3.5 gpf Marking	31.05
104591	M•DURA™ Cap Assembly with 1.6 gpf Marking	31.05
104592	M•DURA™ Cap Assembly with 1.28 gpf Marking	31.05
104593	M•DURA™ Cap Assembly with 1.0 gpf Marking	31.05
104594	M•DURA™ Cap Assembly with 0.5 gpf Marking	31.05
104595	M•DURA™ Cap Assembly with 0.125 gpf Marking	31.05
104597	M•DURA™ Tail Piece and Interior Cap Tool	20.75
104598	M•DURA™ Sweat Kit (3/4" supply) 3" length	30.60
104599	M•DURA™ Sweat Kit (3/4" supply) 6" length	54.95
104609	M•DURA™ Piston Gaskets	12.00

BEDPAN WASHER ACCESSORIES











Part No.	Description	List Price
104573	M•DURA™ Bedpan Washer Seal Kit	27.95
104574	M•DURA™ Bedpan Washer Seal Kit	61.10
104575	M•DURA™ Bedpan Washer Arm Assembly	54.80
104577	M•DURA™ Bedpan Washer Spray Face	13.15
104600	M•DURA™ Offset Flush Tube 8" x 1 1/2"	58.95

M•DURA™ Heavy-Duty Showering



M•DURA Modern Heavy-Duty Shower System / T9342 Series

M•DURA™ Heavy-Duty Showering

	MODEL	LIST	FINISH/CONNECT	CASE QTY
POSI-TEMP® PRESSURE-BALANCE TUB/SHOWER WITH HANDSHOWER ON SLIDEBAR				
 <ul style="list-style-type: none"> • connection: 1/2" • single-function standard showerhead • single-function handshower with non-positive pause • non-diverting tub spout length 5" • hose: 72" metal • Posi-Temp® and transfer valve included • cartridge: 1222HD • check stops: yes • valve meets ASSE performance requirements • 30" slide bar included† • drop ell included 	2.5 GPM (9.5 L/min) max.			
	8343	734.30	Chrome	1
POSI-TEMP® PRESSURE-BALANCE TUB/SHOWER TRIM WITH HANDSHOWER ON SLIDEBAR				
 <ul style="list-style-type: none"> • connection: 1/2" • single-function standard showerhead • single-function handshower with non-positive pause • non-diverting tub spout length 5" • hose: 72" metal • Posi-Temp® and transfer valves sold separately • 30" slide bar included† • drop ell included 	2.5 GPM (9.5 L/min) max.			
	T8343	392.85	Chrome	1
	T8343CBN	577.60	Classic Brushed Nickel	1
 <ul style="list-style-type: none"> • connection: 1/2" • single-function standard showerhead • single-function handshower with non-positive pause • non-diverting tub spout length 5" • hose: 72" metal • Posi-Temp® and transfer valves sold separately • 30" slide bar included† • drop ell included 	1.5 GPM (5.7 L/min) max.			
	T8343EP15	392.85	Chrome	1
	T8343EP15CBN	577.60	Classic Brushed Nickel	1
POSI-TEMP® MIXING SHOWER VALVE				
 <ul style="list-style-type: none"> • cartridge type: ceramic disc • valve type: transfer • no. of ports: four 	8370HD	143.85	1/2" CC without Integral stops	6
	8371HD	173.10	1/2" CC with Integral stops	6
	8372HD	173.10	1/2" IPS with Integral stops	6
	8373HD	173.10	1/2" PEX with Integral stops	6
	8374HD	186.60	1/2" CPVC with Integral stops	6
	8375HD	173.10	1/2" Cold Exp. PEX w/ Integral Stops	6
THREE-FUNCTION TRANSFER VALVE				
 <ul style="list-style-type: none"> • cartridge type: ceramic disc • valve type: transfer • no. of ports: four • functions: three independent 	3360	211.70	1/2" CC	6
HOW TO ORDER VALVES: PAGES 670-671				
				















COMMERCIAL

*The brass Posi-Temp® valves meet ASSE 1016 compliance requirements for controlling temperature fluctuations when paired with Moen Commercial showerheads and handshowers with flow rates as low as 1.5 gpm (5.7 lpm).

† Slide bar is not a grab bar. Not to be used as support.

See Commercial Product Icon Key, page 618

M•DURA™ Heavy-Duty Showering

		MODEL	LIST	FINISH/CONNECT	CASE QTY
POSI-TEMP® PRESSURE-BALANCE SHOWER ONLY TRIM WITH HANDSHOWER ON SLIDEBAR					
 <ul style="list-style-type: none"> • connection: 1/2" • single-function standard showerhead • single-function handshower with non-positive pause • hose: 72" metal • Posi-Temp® and transfer valves sold separately • 30" slide bar included† • drop ell included • marked with red/blue temperature indicators 		1.5 GPM (5.7 L/min) max. T9342EP15 508.35 Chrome 1			
	POSI-TEMP® MIXING SHOWER VALVE				
 <ul style="list-style-type: none"> • cartridge type: ceramic disc • valve type: transfer • no. of ports: four 		8370HD	143.85	1/2" CC without Integral stops	6
		8371HD	173.10	1/2" CC with Integral stops	6
		8372HD	173.10	1/2" IPS with Integral stops	6
		8373HD	173.10	1/2" PEX with Integral stops	6
		8374HD	186.60	1/2" CPVC with Integral stops	6
		8375HD	173.10	1/2" Cold Exp. PEX w/ Integral Stops	6
THREE-FUNCTION TRANSFER VALVE					
 <ul style="list-style-type: none"> • cartridge type: ceramic disc • valve type: transfer • no. of ports: four • functions: three independent 		3360	211.70	1/2" CC	6
HOW TO ORDER VALVES: PAGES 670-671					
					
POSI-TEMP® PRESSURE-BALANCE SHOWER ONLY TRIM WITH HANDSHOWER ON SLIDE BAR GRAB BAR					
 <ul style="list-style-type: none"> • connection: 1/2" • single-function standard showerhead • single-function handshower with non-positive pause • hose: 72" metal • Posi-Temp® and transfer valves sold separately • 24" slide bar / grab bar included • drop ell included • marked with red/blue temperature indicators 		1.5 GPM (5.7 L/min) max. T9342GBM15 559.15 Chrome 1			
	POSI-TEMP® MIXING SHOWER VALVE				
 <ul style="list-style-type: none"> • cartridge type: ceramic disc • valve type: transfer • no. of ports: four 		8370HD	143.85	1/2" CC without Integral stops	6
		8371HD	173.10	1/2" CC with Integral stops	6
		8372HD	173.10	1/2" IPS with Integral stops	6
		8373HD	173.10	1/2" PEX with Integral stops	6
		8374HD	186.60	1/2" CPVC with Integral stops	6
		8375HD	173.10	1/2" Cold Exp. PEX w/ Integral Stops	6
THREE-FUNCTION TRANSFER VALVE					
 <ul style="list-style-type: none"> • cartridge type: ceramic disc • valve type: transfer • no. of ports: four • functions: three independent 		3360	211.70	1/2" CC	6
HOW TO ORDER VALVES: PAGES 670-671					
					















*The brass Posi-Temp® valves meet ASSE 1016 compliance requirements for controlling temperature fluctuations when paired with Moen Commercial showerheads and handshowers with flow rates as low as 1.5 gpm (5.7 lpm).

† Slide bar is not a grab bar. Not to be used as support.

See Commercial Product Icon Key, page 618

COMMERCIAL

M•DURA™ Heavy-Duty Showering

	MODEL	LIST	FINISH/CONNECT	CASE QTY		
POSI-TEMP® PRESSURE-BALANCE SHOWER ONLY WITH HANDSHOWER ON SLIDEBAR						
 <ul style="list-style-type: none"> • connection: 1/2" • single-function standard showerhead • single-function handshower with non-positive pause • hose: 72" metal • Posi-Temp® and transfer valve included • cartridge: 1222HD • check stops: yes • valve meets ASSE performance requirements • 30" slide bar included† • drop ell included 	2.5 GPM (9.5 L/min) max.					
	8342	714.95	Chrome	1		
	1.5 GPM (5.7 L/min) max.					
	8342EP15	714.95	Chrome	1		
POSI-TEMP® PRESSURE-BALANCE SHOWER ONLY TRIM WITH HANDSHOWER ON SLIDEBAR						
 <ul style="list-style-type: none"> • connection: 1/2" • single-function standard showerhead • single-function handshower with non-positive pause • hose: 72" metal • Posi-Temp® and transfer valves sold separately • 30" slide bar included† • drop ell included 	2.5 GPM (9.5 L/min) max.					
	T8342	371.85	Chrome	1		
	T8342CBN	546.55	Classic Brushed Nickel	1		
	1.5 GPM (5.7 L/min) max.					
	T8342EP15	371.85	Chrome	1		
	T8342EP15CBN	546.55	Classic Brushed Nickel	1		
 <ul style="list-style-type: none"> • connection: 1/2" • single-function standard showerhead • single-function handshower with non-positive pause • hose: 72" metal • Posi-Temp® and transfer valves sold separately • 30" slide bar included† • drop ell included 	T8342NH	362.90	Chrome	1		
	T8342NHCBN	497.65	Classic Brushed Nickel	1		
POSI-TEMP® MIXING SHOWER VALVE						
 <ul style="list-style-type: none"> • cartridge type: ceramic disc • valve type: transfer • no. of ports: four 	8370HD	143.85	1/2" CC without Integral stops	6		
	8371HD	173.10	1/2" CC with Integral stops	6		
	8372HD	173.10	1/2" IPS with Integral stops	6		
	8373HD	173.10	1/2" PEX with Integral stops	6		
	8374HD	186.60	1/2" CPVC with Integral stops	6		
	8375HD	173.10	1/2" Cold Exp. PEX w/ Integral Stops	6		
THREE-FUNCTION TRANSFER VALVE						
 <ul style="list-style-type: none"> • cartridge type: ceramic disc • valve type: transfer • no. of ports: four • functions: three independent 	3360	211.70	1/2" CC	6		
HOW TO ORDER VALVES: PAGES 670-671						
 TRIM PART #	+	 VALVE PART #	+	 VALVE PART #	=	 COMPLETE FAUCET

*The brass Posi-Temp® valves meet ASSE 1016 compliance requirements for controlling temperature fluctuations when paired with Moen Commercial showerheads and handshowers with flow rates as low as 1.5 gpm (5.7 lpm).









† Slide bar is not a grab bar. Not to be used as support.

See Commercial Product Icon Key, page 618

COMMERCIAL

M•DURA™ Heavy-Duty Showering

MODEL LIST FINISH/CONNECT CASE QTY

POSI-TEMP® PRESSURE-BALANCE VALVE ONLY TRIM WITH HANDSHOWER ON SLIDE BAR GRAB BAR				
 <ul style="list-style-type: none"> • connection: 1/2" • single-function handshower with non-positive pause • hose: 72" metal • valve sold separately • 24" slide bar / grab bar included • drop ell included • marked with red/blue temperature indicators 	1.5 GPM (5.7 L/min) max.			
	T9346GBM15	492.60	Chrome/Stainless	1
POSI-TEMP® MIXING SHOWER VALVE				
 <ul style="list-style-type: none"> • cartridge type: ceramic disc • valve type: transfer • no. of ports: four 	8370HD	143.85	1/2" CC without Integral stops	6
	8371HD	173.10	1/2" CC with Integral stops	6
	8372HD	173.10	1/2" IPS with Integral stops	6
	8373HD	173.10	1/2" PEX with Integral stops	6
	8374HD	186.60	1/2" CPVC with Integral stops	6
	8375HD	173.10	1/2" Cold Exp. PEX w/ Integral Stops	6
HOW TO ORDER VALVES: PAGES 670-671				
 TRIM PART # +  VALVE PART # =  COMPLETE FAUCET				
POSI-TEMP® PRESSURE-BALANCE VALVE ONLY WITH HANDSHOWER ON SLIDE BAR				
 <ul style="list-style-type: none"> • connection: 1/2" • single-function handshower with non-positive pause • hose: 72" metal • Posi-Temp® valve included • cartridge: 1222HD • check stops: yes • valve meets ASSE performance requirements • 30" slide bar included † • drop ell included 	2.5 GPM (9.5 L/min) max.			
	8346	507.60	Chrome	4
	1.5 GPM (5.7 L/min) max.			
	8346EP15	507.60	Chrome	4





COMMERCIAL

*The brass Posi-Temp® valves meet ASSE 1016 compliance requirements for controlling temperature fluctuations when paired with Moen Commercial showerheads and handshowers with flow rates as low as 1.5 gpm (5.7 lpm).

† Slide bar is not a grab bar. Not to be used as support.

See **Commercial Product Icon Key**, page 618

M•DURA™ Heavy-Duty Showering

		MODEL	LIST	FINISH/CONNECT	CASE QTY
POSI-TEMP® PRESSURE-BALANCE VALVE ONLY TRIM WITH HANDSHOWER ON SLIDE BAR					
 <ul style="list-style-type: none"> • connection: 1/2" • single-function handshower with non-positive pause • hose: 72" metal • Posi-Temp® valve sold separately • 30" slide bar included† • drop ell included 		2.5 GPM (9.5 L/min) max.			
		T8346	343.15	Chrome	4
		T8346CBN	486.55	Classic Brushed Nickel	4
		1.5 GPM (5.7 L/min) max.			
		T8346EP15	343.15	Chrome	4
		T8346EP15CBN	486.55	Classic Brushed Nickel	4
POSI-TEMP® MIXING SHOWER VALVE					
 <ul style="list-style-type: none"> • cartridge type: ceramic disc • valve type: transfer • no. of ports: four 		8370HD	143.85	1/2" CC without Integral stops	6
		8371HD	173.10	1/2" CC with Integral stops	6
		8372HD	173.10	1/2" IPS with Integral stops	6
		8373HD	173.10	1/2" PEX with Integral stops	6
		8374HD	186.60	1/2" CPVC with Integral stops	6
		8375HD	173.10	1/2" Cold Exp. PEX w/ Integral Stops	6
<p>HOW TO ORDER VALVES: PAGES 670-671</p> 					











COMMERCIAL

*The brass Posi-Temp® valves meet ASSE 1016 compliance requirements for controlling temperature fluctuations when paired with Moen Commercial showerheads and handshowers with flow rates as low as 1.5 gpm (5.7 lpm).

† Slide bar is not a grab bar. Not to be used as support.

See **Commercial Product Icon Key**, page 618













M•DURA™ Heavy-Duty Showering

		MODEL	LIST	FINISH/CONNECT	CASE QTY
POSI-TEMP® PRESSURE-BALANCE TUB/SHOWER					
 <ul style="list-style-type: none"> • connection: 1/2" • single-function standard showerhead • tub spout length: 5.5" • Posi-Temp® valve included • cartridge: 1222HD • check stops: yes • valve meets ASSE performance requirements 		1.5 GPM (5.7 L/min) max.			
		8389EP15	262.55	Chrome	6
POSI-TEMP® PRESSURE-BALANCE TUB/SHOWER TRIM					
 <ul style="list-style-type: none"> • connection: 1/2" • single-function standard showerhead • tub spout length: 5.5" • Posi-Temp® valve sold separately 		2.5 GPM (9.5 L/min) max.			
		T8389	102.60	Chrome	3
		1.5 GPM (5.7 L/min) max.			
	T8389EP15	102.60	Chrome	3	
	T8389EP15CBN	160.25	Classic Brushed Nickel	3	
 <ul style="list-style-type: none"> • connection: 1/2" • single-function standard showerhead • tub spout length: 5.5" • Posi-Temp® valve sold separately 		1.5 GPM (5.7 L/min) max.			
		T9389EP15	170.65	Chrome	3
POSI-TEMP® MIXING SHOWER VALVE					
 <ul style="list-style-type: none"> • cartridge type: ceramic disc • valve type: transfer • no. of ports: four 					
		8370HD	143.85	1/2" CC without Integral stops	6
		8371HD	173.10	1/2" CC with Integral stops	6
		8372HD	173.10	1/2" IPS with Integral stops	6
		8373HD	173.10	1/2" PEX with Integral stops	6
		8374HD	186.60	1/2" CPVC with Integral stops	6
	8375HD	173.10	1/2" Cold Exp. PEX w/ Integral Stops	6	
HOW TO ORDER VALVES: PAGES 670-671	 TRIM PART #	+	 VALVE PART #	=	 COMPLETE FAUCET

COMMERCIAL











*The brass Posi-Temp® valves meet ASSE 1016 compliance requirements for controlling temperature fluctuations when paired with Moen Commercial showerheads and handshowers with flow rates as low as 1.5 gpm (5.7 lpm).

M•DURA™ Heavy-Duty Showering

		MODEL	LIST	FINISH/CONNECT	CASE QTY	
POSI-TEMP® PRESSURE-BALANCE SHOWER ONLY						
 <ul style="list-style-type: none"> • connection: 1/2" • single-function standard showerhead • Posi-Temp® valve included • cartridge: 1222HD • check stops: yes • valve meets ASSE performance requirements 		2.5 GPM (9.5 L/min) max.				
		8375	229.90	Chrome	12	
		1.5 GPM (5.7 L/min) max.				
		8375EP15	229.90	Chrome	12	
POSI-TEMP® PRESSURE-BALANCE SHOWER ONLY TRIM						
 <ul style="list-style-type: none"> • connection: 1/2" • single-function standard showerhead • Posi-Temp® valve sold separately 		2.5 GPM (9.5 L/min) max.				
		T8375	67.00	Chrome	3	
		1.5 GPM (5.7 L/min) max.				
		T8375EP15	67.00	Chrome	3	
 <ul style="list-style-type: none"> • connection: 1/2" • showerhead sold separately • Posi-Temp® valve sold separately 		T8375NH	47.50	Chrome	3	
		T8375NHCBN	79.35	Classic Brushed Nickel	3	
	 <ul style="list-style-type: none"> • connection: 1/2" • single-function standard showerhead • Posi-Temp® valve sold separately 		1.5 GPM (5.7 L/min) max.			
			T9375EP15	134.15	Chrome	3
POSI-TEMP® MIXING SHOWER VALVE						
 <ul style="list-style-type: none"> • cartridge type: ceramic disc • valve type: transfer • no. of ports: four 			8370HD	143.85	1/2" CC without Integral stops	6
		8371HD	173.10	1/2" CC with Integral stops	6	
		8372HD	173.10	1/2" IPS with Integral stops	6	
		8373HD	173.10	1/2" PEX with Integral stops	6	
		8374HD	186.60	1/2" CPVC with Integral stops	6	
		8375HD	173.10	1/2" Cold Exp. PEX w/ Integral Stops	6	
	HOW TO ORDER					
VALVES: PAGES 670-671		 TRIM PART #	+	 VALVE PART #	=	 COMPLETE FAUCET















*The brass Posi-Temp® valves meet ASSE 1016 compliance requirements for controlling temperature fluctuations when paired with Moen Commercial showerheads and handshowers with flow rates as low as 1.5 gpm (5.7 lpm).

M•DURA™ Heavy-Duty Showering















		MODEL	LIST	FINISH/CONNECT	CASE QTY
POSI-TEMP® PRESSURE-BALANCE VALVE ONLY					
 <ul style="list-style-type: none"> • connection: 1/2" • Posi-Temp® valve included • cartridge: 1222HD • check stops: yes • valve meets ASSE performance requirements 		8370	204.05	Chrome	12
	POSI-TEMP® PRESSURE-BALANCE VALVE ONLY TRIM				
 <ul style="list-style-type: none"> • connection: 1/2" • Posi-Temp® valve sold separately 		T8370	38.80	Chrome	3
		T8370CBN	70.80	Classic Brushed Nickel	3
 <ul style="list-style-type: none"> • connection: 1/2" • Posi-Temp® valve sold separately 		T9370	107.20	Chrome	3
POSI-TEMP® MIXING SHOWER VALVE					
 <ul style="list-style-type: none"> • cartridge type: ceramic disc • valve type: transfer • no. of ports: four 		8370HD	143.85	1/2" CC without Integral stops	6
		8371HD	173.10	1/2" CC with Integral stops	6
		8372HD	173.10	1/2" IPS with Integral stops	6
		8373HD	173.10	1/2" PEX with Integral stops	6
		8374HD	186.60	1/2" CPVC with Integral stops	6
		8375HD	173.10	1/2" Cold Exp. PEX w/ Integral Stops	6
<p>HOW TO ORDER</p> <p>VALVES: PAGES 670-671</p>	 <p>TRIM PART #</p>	+	 <p>VALVE PART #</p>	=	 <p>COMPLETE FAUCET</p>

*The brass Posi-Temp® valves meet ASSE 1016 compliance requirements for controlling temperature fluctuations when paired with Moen Commercial showerheads and handshowers with flow rates as low as 1.5 gpm (5.7 lpm).

M•DURA™ Heavy-Duty Showering

		MODEL	LIST	FINISH/CONNECT	CASE QTY
M-CORE® 3-SERIES VALVE ONLY					
 <ul style="list-style-type: none"> • connection: 1/2" • M-CORE® valve included • cartridge: M-CORE pressure balanced with volume and temperature control • check stops: yes • valve meets ASSE performance requirements 		U8350	262.95	Chrome	3
M-CORE® 3-SERIES VALVE ONLY TRIM					
 <ul style="list-style-type: none"> • connection: 1/2" • cartridge: M-CORE pressure balanced with volume and temperature control • valve sold separately 		UT8350	195.40	Chrome	3
		UT8350CBN	250.75	Classic Brushed Nickel	3
M-CORE® MIXING SHOWER VALVE					
 <ul style="list-style-type: none"> • tub/shower or shower only application • ports: four with adj. temp. limit stops • included: test plug and cross flow plug 		U140CI	72.60	1/2" CC/IPS	6
		U140X	72.60	1/2" Crimp Ring PEX + CC/IPS Tub	6
		U140CX	72.60	1/2" Cold Exp. PEX + CC/IPS Tub	6
		U140V	88.95	1/2" CPVC + CC/IPS Tub	6
 <ul style="list-style-type: none"> • tub/shower or shower only application • ports: four with adj. temp. limit stops • quarter turn stops: included 		U140CIS	104.50	1/2" CC/IPS	6
		U140XS	104.50	1/2" Crimp Ring PEX + CC/IPS Tub	6
		U140CXS	104.50	1/2" Cold Exp. PEX + CC/IPS Tub	6
		U140VS	120.85	1/2" CPVC + CC/IPS Tub	6
 <ul style="list-style-type: none"> • shower only application • ports: three 		U130CI	72.60	1/2" CC/IPS	6
		U130X	72.60	1/2" Crimp Ring PEX	6
		U130CX	72.60	1/2" Cold Exp. PEX	6
 <ul style="list-style-type: none"> • shower only application • ports: three • quarter turn stops: included 		U130CIS	104.50	1/2" CC/IPS	6
		U130XS	104.50	1/2" Crimp Ring PEX	6
		U130CXS	104.50	1/2" Cold Exp. PEX	6
<p>Four port valves can be used with either Tub/Shower or Shower Only applications. Three port valves can ONLY be used with Shower Only applications. For more product details, reference page 471 in valve section.</p>					
HOW TO ORDER VALVES: PAGE 471		 TRIM PART # +  VALVE PART # =  COMPLETE FAUCET			













M•DURA™ Heavy-Duty Showering

		MODEL	LIST	FINISH/CONNECT	CASE QTY			
THREE-FUNCTION TRANSFER VALVE ONLY								
	<ul style="list-style-type: none"> • connection: 1/2" • transfer valve included • cartridge type: transfer 	8360	251.00	Chrome	6			
THREE-FUNCTION TRANSFER VALVE ONLY TRIM								
	<ul style="list-style-type: none"> • connection: 1/2" • transfer valve sold separately 	T8360	49.60	Chrome	3			
		T8360CBN	90.60	Classic Brushed Nickel	3			
	<ul style="list-style-type: none"> • connection: 1/2" • transfer valve sold separately 	T9360	137.20	Chrome	3			
	<ul style="list-style-type: none"> • connection: 1/2" • transfer valve sold separately 	T4192	154.80	Chrome	12			
THREE-FUNCTION TRANSFER VALVE								
	<ul style="list-style-type: none"> • cartridge type: ceramic disc • valve type: transfer • no. of ports: four • functions: three independent 	3360	211.70	1/2" CC	6			
HOW TO ORDER VALVES: PAGE 671		TRIM PART #	+		VALVE PART #	=		COMPLETE FAUCET
24" X 1-1/4" SLIDE BAR GRAB BAR WITH HANDSHOWER WITHOUT VALVE								
	<ul style="list-style-type: none"> • connection: 1/2" • single-function handshower • handshower includes: non-positive pause • 72" metal hose • slidebar / grab bar and drop ell included 	2.5 GPM (9.5 L/min) max. 52124GBM25	259.00	Chrome/Stainless	3			

COMMERCIAL

M•DURA™ Heavy-Duty Showering









MODEL LIST FINISH/CONNECT CASEQTY

24" X 1-1/2" SLIDE BAR GRAB BAR WITH HANDSHOWER WITHOUT VALVE				
 <ul style="list-style-type: none"> • connection: 1/2" • single-function eco-performance handshower • handshower includes: non-positive pause • 72" metal hose • slidebar / grab bar and drop ell included 	<p>2.5 GPM (9.5 L/min) max.</p>			
	52224GBM25	264.90	Chrome/Stainless	3
	<p>1.75 GPM (6.65 L/min) max.</p>			
	52224GBM17	264.90	Chrome/Stainless	3
	<p>1.5 GPM (5.7 L/min) max.</p>			
52224GBM15	264.90	Chrome/Stainless	3	
52224GBM15CBN	542.95	Classic Brushed Nickel	3	
24" X 1-1/2" SLIDE BAR GRAB BAR WITH HANDSHOWER WITHOUT VALVE				
 <ul style="list-style-type: none"> • connection: 1/2" • single-function handshower • handshower includes: non-positive pause • 59" plastic hose • slidebar / grab bar and drop ell included 	<p>2.5 GPM (9.5 L/min) max.</p>			
	52224GBP25	229.70	Chrome/Stainless	3
	36" X 1-1/2" SLIDE BAR GRAB BAR WITH HANDSHOWER WITHOUT VALVE			
	 <ul style="list-style-type: none"> • connection: 1/2" • single-function eco-performance handshower • handshower includes: non-positive pause • 72" metal hose • slidebar / grab bar and drop ell included 	<p>2.5 GPM (9.5 L/min) max.</p>		
		52236GBM25	288.45	Chrome/Stainless
<p>1.75 GPM (6.65 L/min) max.</p>				
52236GBM17		288.45	Chrome/Stainless	3
<p>1.5 GPM (5.7 L/min) max.</p>				
52236GBM15	288.45	Chrome/Stainless	3	
52236GBM15CBN	590.10	Classic Brushed Nickel	3	
36" SLIDE BAR WITH HANDSHOWER WITHOUT VALVE				
 <ul style="list-style-type: none"> • connection: 1/2" • single-function handshower • handshower includes: non-positive pause • 72" metal hose • slidebar and drop ell included † 	<p>2.5 GPM (9.5 L/min) max.</p>			
	52710	300.65	Glacier/Chrome	6
	52710CBN	598.40	Classic Brushed Nickel	6
	<p>1.5 GPM (5.7 L/min) max.</p>			
	52710EP15	300.65	Chrome	6
52710EP15CBN	598.40	Classic Brushed Nickel	6	
 <ul style="list-style-type: none"> • connection: 1/2" • three-function eco-performance handshower • handshower includes: non-positive pause • 72" metal hose • slidebar and drop ell included † 	<p>1.75 GPM (6.65 L/min) max.</p>			
	52740EP17	300.05	Chrome	6
HANDSHOWER WITH WALL BRACKET WITHOUT VALVE				
 <ul style="list-style-type: none"> • connection: 1/2" • single-function eco-performance handshower • handshower includes: non-positive pause • 72" metal hose • drop ell included 	<p>1.5 GPM (5.7 L/min) max.</p>			
	52748EP15	219.35	Chrome	6

† Slide bar is not a grab bar. Not to be used as support.
See Commercial Product Icon Key, page 618



COMMERCIAL

M•DURA™ Heavy-Duty Showering

		MODEL	LIST	FINISH/CONNECT	CASE QTY
HANDSHOWER					
	<ul style="list-style-type: none"> • 1/2" connection • single-function handshower with non-positive pause • integral double check valve in handshower 	2.5 GPM (9.5 L/min) max.			
		8349	82.30	Chrome	6
		1.75 GPM (6.65 L/min) max.			
		8349EP17	82.30	Chrome	6
		8349EP17CBN	119.85	Classic Brushed Nickel	6
		1.5 GPM (5.7 L/min) max.			
8349EP15	82.30	Chrome	6		
8349EP15CBN	119.85	Classic Brushed Nickel	6		
HANDSHOWER					
	<ul style="list-style-type: none"> • 1/2" connection • single-function eco-performance handshower with non-positive pause • integral double check valve in handshower 	1.5 GPM (5.7 L/min) max.			
		9349EP15	116.80	Chrome	6
SHOWER ARM AND FLANGE					
	<ul style="list-style-type: none"> • connection: 1/2" IPS • length 6" • all metal 	A705	57.75	Chrome	12
		A705CBN	86.55	Classic Brushed Nickel	12
VANDAL-RESISTANT SHOWERHEAD					
	<ul style="list-style-type: none"> • 1/2" connection • single-function eco-performance showerhead • vandal resistant 	1.5 GPM (5.7 L/min) max.			
		9263EP15	79.35	Chrome	12
	<ul style="list-style-type: none"> • 1/2" connection • single-function eco-performance showerhead • vandal resistant 	1.5 GPM (5.7 L/min) max.			
		5263EP15	58.05	Chrome	12
		5263EP15CBN	105.95	Classic Brushed Nickel	12
		1.75 GPM (6.65 L/min) max.			
5263EP17	58.05	Chrome	12		
5263EP17CBN	105.95	Classic Brushed Nickel	12		
	<ul style="list-style-type: none"> • 1/2" connection • single-function eco-performance showerhead • vandal resistant 	1.5 GPM (5.7 L/min) max.			
		52716EP15	76.45	Chrome	20

M•DURA™ Heavy-Duty Showering













MODEL LIST FINISH/CONNECT CASE QTY

VANDAL-RESISTANT WALLMOUNT SHOWERHEAD				
	<ul style="list-style-type: none"> • 1/2" connection • single-function eco-performance showerhead • vandal resistant • wallmounted 	2.5 GPM (9.5 L/min) max.		
		8290	130.15 Chrome	12
	<ul style="list-style-type: none"> • 1/2" connection • single-function eco-performance showerhead • vandal resistant • wallmounted 	1.5 GPM (5.7 L/min) max.		
		8290EP15	125.10 Chrome	12
	<ul style="list-style-type: none"> • 1/2" connection • single-function eco-performance showerhead • vandal resistant • wallmounted • pivoting nozzle 	2.5 GPM (9.5 L/min) max.		
		8292	135.85 Chrome	12





TUB/SHOWER ACCESSORIES

Part No.	Finish	Description	List Price
15856	Chrome	Diverter tub spout, 1/2" slip fit, vandal-resistant	65.50
15856CBN	Classic Brushed Nickel	Diverter tub spout, 1/2" slip fit, vandal-resistant	95.40
100686	Chrome	Slide bar swivel bracket for handshower	54.65
100686CBN	Classic Brushed Nickel	Slide bar swivel bracket for handshower	78.55
104414	Chrome	Wall-mounted bracket for handshower	59.00
52711	---	Slide bar/Grab bar bracket - 1-1/2" diameter	54.50
52714	---	Slide bar/Grab bar bracket - 1-1/4" diameter	54.50
SMA1000CH**	Chrome	SecureMount™ anchors, 1 pair, for use with bedpan washer wallmount flange and grab bars	40.15
A725	Chrome	Drop ell	67.40
A725CBN	Classic Brushed Nickel	Drop ell	89.45
A726	Chrome	69" metal hose (vacuum breaker sold separately)	136.95
A723	Chrome	59" plastic hose (vacuum breaker sold separately)	33.65
A780	Chrome	80" metal hose (vacuum breaker sold separately)	161.50
52703	Chrome	Optional vacuum breaker for handshower, 1/2" IPS connections	72.65

M•DURA™ Heavy-Duty Tub/Shower Valves

		MODEL	LIST	FINISH/CONNECT	CASE QTY
M•CORE™ CARTRIDGE					
	<ul style="list-style-type: none"> • Single-handle replacement cartridge M-CORE® 3-Series • pressure balanced cartridge with volume and temperature control • includes temperature limit stops 	1213	110.00	N/A or Unfinished	12
BRASS POSI-TEMP® CARTRIDGE					
	<ul style="list-style-type: none"> • graphite composite pressure-balancing spool design • material: brass 	1222HD	110.35	N/A or Unfinished	18
M-CORE® MIXING SHOWER VALVE WITH STOPS					
	<ul style="list-style-type: none"> • ports: four • adjustable temp limit stop: included • quarter turn stops: included • test plug: included 	U140CIS	104.50	N/A or Unfinished	6
		U140X	104.50	N/A or Unfinished	6
		U140CXS	104.50	N/A or Unfinished	6
		U140VS	120.85	N/A or Unfinished	6
M-CORE® MIXING SHOWER VALVE					
	<ul style="list-style-type: none"> • ports: four • adjustable temp limit stop: included • test plug: included • cross flow plug: included 	U140CI	72.60	N/A or Unfinished	6
		U140X	72.60	N/A or Unfinished	6
		U140CX	72.60	N/A or Unfinished	6
		U140V	88.95	N/A or Unfinished	6
BRASS POSI-TEMP® ROUGH-IN VALVE					
	<ul style="list-style-type: none"> • ports: four • cartridge: 1222HD • valve type: pressure balancing cycling valve 	8370HD	143.85	1/2" CC	6
BRASS POSI-TEMP® ROUGH-IN VALVE					
	<ul style="list-style-type: none"> • ports: four • cartridge: 1222HD • valve type: pressure balancing cycling valve • stops included 	8371HD	173.10	1/2" CC	6

M•DURA™ Heavy-Duty Tub/Shower Valves

		MODEL	LIST	FINISH/CONNECT	CASE QTY
BRASS POSI-TEMP® ROUGH-IN VALVE					
	<ul style="list-style-type: none"> • ports: four • cartridge: 1222HD • pressure balancing cycling valve • stops included 	8372HD	173.10	1/2" IPS	6
BRASS POSI-TEMP® ROUGH-IN VALVE					
	<ul style="list-style-type: none"> • ports: four • cartridge: 1222HD • pressure balancing cycling valve • stops included 	8373HD	173.10	1/2" crimp ring PEX	6
BRASS POSI-TEMP® ROUGH-IN VALVE					
	<ul style="list-style-type: none"> • ports: four • cartridge: 1222HD • pressure balancing cycling valve • stops included 	8374HD	186.60	1/2" CPVC	6
BRASS POSI-TEMP® ROUGH-IN VALVE					
	<ul style="list-style-type: none"> • ports: four • cartridge: 1222HD • pressure balancing cycling valve • stops included 	8375HD	173.10	1/2" cold expansion PEX	6
THREE-FUNCTION TRANSFER VALVE					
	<ul style="list-style-type: none"> • ports: four • cartridge: ceramic disc • valve type: transfer • functions: three independent 	3360	211.70	1/2" CC	6

*The brass Posi-Temp® valves meet ASSE 1016 compliance requirements for controlling temperature fluctuations when paired with Moen Commercial showerheads and handshowers with flow rates as low as 1.5 gpm (5.7 lpm).



M•DURA™ Heavy-Duty Tub/Shower Valves

		MODEL	LIST	FINISH/CONNECT	CASE QTY
HIGH-FLOW THERMOSTATIC MIXING VALVE					
	• description: high flow thermostatic mixing valve for roman tubs	104465	185.95	1/2" CC	12
	• ports: three	104466	185.95	1/2" IPS	12
	• ASSE standard 1070: yes	104464	185.95	1/2" Crimp Ring PEX	12
	• flow rate: 12.0 gpm (45.4 L/min) max.	104463	185.95	1/2" Cold Expansion PEX	12

THERMOSTATIC MIXING VALVE SERVICE KITS				
Part No.	Finish	Description	List Price	Case Qty
175916	N/A or Unfinished	1/2" IPS Adapter Kit	17.55	12
175917	N/A or Unfinished	1/2" CC Adapter Kit	17.55	1
175918	N/A or Unfinished	1/2" Cold Expansion PEX Adapter Kit	17.55	12
181040	N/A or Unfinished	1/2" Crimp Ring PEX Adapter Kit	17.55	12
175921	N/A or Unfinished	3/8" Compression Adapter Kit	17.55	12
175925	N/A or Unfinished	Fitting Nut Kit	17.55	12

Model No.	UPC Code	Product Description	Case Qty	List Price
100040	N/A or Unfinished	ctrtrdge 3 fnct srvc kit	125.05	026508087527
100078	N/A or Unfinished	hdw mtg comm xfer 3F	23.35	026508096284
100078CBN	Brushed Nickel	hdw mtg comm xfer 3F	12.00	026508244821
100079	Chrome	hdl comm xfer 3F chr	39.40	026508096291
100079CBN	Brushed Nickel	hdl comm xfer 3F cbn	57.25	026508239797
100080	N/A or Unfinished	slv comm xfer 3F chr	54.70	026508096307
100080CBN	Brushed Nickel	slv comm xfer 3F cbn	79.65	026508244760
100087	N/A or Unfinished	comm xfer 3F	8.75	026508096321
101867	N/A or Unfinished	pivot retain & temp limit stop	14.40	026508068373
104020	Chrome	manual temp handle 8305 series	26.05	026508189337
104021	Chrome	solenoid vlv repair kit 8302 - 04	57.70	026508189344
104334	N/A or Unfinished	control module 8310 (closet)	186.55	026508155479
104400	Chrome	elec. faucet in-line filter w/check valv	63.35	026508167670
104401	N/A or Unfinished	acc sani AC power adpt multi unit	106.35	026508108192
104402	N/A or Unfinished	l cable 24 power lead	33.65	026508108208
104403	N/A or Unfinished	control module 8312, 8314 (urinal)	186.55	026508155486
104404	N/A or Unfinished	control module 8305, 8307 (DC)	199.75	026508155493
104405	N/A or Unfinished	control module 8306 (AC)	199.75	026508155509
104406	N/A or Unfinished	AC adapter for flush valves	35.80	026508182444
104424	N/A or Unfinished	sani mixing vlv w/integral check	65.80	026508084229
104425	N/A or Unfinished	sani mixing tee w/integral check	25.70	026508084212
104426	Chrome	gskt deck sani bar/lav elec sglmt	37.35	026508084205
104427	N/A or Unfinished	acc sani AC power adpt sgl unit	72.05	026508084199
104429	Chrome	spt 5.75" sani bar elec gooseneck chr	47.55	026508084588
104430	Chrome	spt 5.38" sani bar elec gooseneck chr	63.60	026508084595
104431	Chrome	spt 6 sani ber elec swing chr	50.30	026508084601
104432	Chrome	spt 8 sani ber elec swing chr	51.55	026508084618
104433	Chrome	spt 8.38" sani bar elec gooseneck chr	96.85	026508084625
104434	Chrome	pc board lav/bar	318.95	026508084632
104435	N/A or Unfinished	flush vlv solenoid rpr kit 8310, 8312, 8	159.85	026508155523
104437	N/A or Unfinished	flush vlv control disc vlv 8310,8312,831	46.70	026508155530
104438	Chrome	fltr screen lav/bar	9.75	026508084656
104439	Chrome	hdw solenoid/housing	349.60	026508084663
104440	N/A or Unfinished	flush vlv battery hldr 8310,8312,8314	7.40	026508155547
104441	N/A or Unfinished	elec. faucet in-line filter washer	2.75	026508167663
104443	Chrome	hdw supply rod wlmt	18.70	026508084687
104444	N/A or Unfinished	sppty line 8305, 8306,8307	34.70	026508081914
104446	N/A or Unfinished	plug in power adptr (w/cable) 8306	68.65	026508155554
104447	N/A or Unfinished	hex key wrench 8305, 8306, 8307	3.40	026508155561
104449	Chrome	vp screws & o-rings for flush valves	42.05	026508157725
104450	Chrome	solenoid coil kit e-faucets 8305-8307	145.30	026508157732
104452	N/A or Unfinished	control module 8310 (closet 1.28)	186.55	026508200629
104453	Chrome	AC tube and flange for flush valve	66.55	026508200636
104454	Chrome	AC flush valve cap	107.95	026508200643
104455	Chrome	DC flush valve cap	94.60	026508200650
104456	N/A or Unfinished	sensor eye casing	14.65	026508200667
104458	N/A or Unfinished	split washer for electronic spout	2.90	026508200681
104459	N/A or Unfinished	battery holder for electronic faucet	7.40	026508200698
104461	Chrome	manual override button	35.05	026508200728
104500	Chrome	2-1/4" delany (standard) nipple	42.65	026508176634
104501	Chrome	1-3/4" delany nipple	37.35	026508176641
104502	Chrome	2-3/4" delany nipple	51.95	026508176658
104503	Chrome	3-1/4" delany nipple	57.30	026508176665
104504	Chrome	3-3/4" delany nipple	63.95	026508176672
104505	Chrome	4-1/4" delaney nipple	70.60	026508176689
104506	Chrome	2-1/8" sloan (standard) nipple	37.35	026508176696
104507	Chrome	2-1/2" sloan nipple	41.35	026508176702
104508	Chrome	3" sloan nipple	44.00	026508176719
104509	Chrome	3-1/2" sloan nipple	47.95	026508176726
104510	Chrome	4" sloan nipple	53.35	026508176733
104511	Chrome	4-1/2" sloan nipple	57.30	026508176740
104512	Chrome	5" sloan nipple	63.95	026508176757
104513	Chrome	5-1/2" sloan nipple	67.95	026508176764
104514	Chrome	6" sloan nipple	73.25	026508176771
104520	N/A or Unfinished	sensor eye for flush valve	89.30	026508189191
104523	Chrome	angle stop repair kit	22.45	026508189221
104524	Chrome	manual override button	42.05	026508189238
104527	N/A or Unfinished	o-ring for flush valve seat	6.40	026508189269
104534	Chrome	1.5 gpm aerator for 83-5 series	20.75	026508200711
104536	Chrome	plastic flush valve cap mount [1 cap per	21.30	026508213179
104537	N/A or Unfinished	piston tip assembly service kit [10 tips	40.05	026508213186
104539	Chrome	security set screw e-faucets	5.40	026508213209
104770	Chrome	mcp metal drain round knob	23.70	026508210123
104775	Chrome	mcp metal drain fluted	26.05	026508210130

Model No.	Finish	Product Description	UPC Code	List Price
106321	N/A or Unfinished	hdl ext 1.000 5f xfer vlv chr	115.65	026508085158
109146	N/A or Unfinished	sani cable/sensor eye 6'	248.40	026508102398
116715	Chrome	spt assy 8948 bar	38.65	026508133453
121520	Chrome	hdl lr w/scw hd cmp chr	25.25	026508134757
121521	Chrome	hdl lr w/scw hd cmp chr	22.45	026508134740
121549	N/A or Unfinished	crtrge 1h 40mm hd cmp	26.05	026508134719
121550	N/A or Unfinished	crtrge 2h hot 28mm hd cmp	14.55	026508134726
121551	N/A or Unfinished	crtrge 2h cold hd 28mm cmp	14.55	026508134733
121620	N/A or Unfinished	crtrge 1h 40mm hd cmp	26.05	026508136683
12523	N/A or Unfinished	bshg stem support wrist blade handle bag	2.75	026508053959
129900	Chrome	lever handle 6" chrome kit	37.35	026508165072
129902	Brushed Nickel	lever handle 6" brushed nickel	33.35	026508165096
140860	N/A or Unfinished	deck gasket for 8210-8219 series, 8886	17.85	026508253274
14690	N/A or Unfinished	crtrge sani ceramic disc heavy comm	60.00	026508025550
14695	N/A or Unfinished	crtrge sani ceramic disc extd heavy comm	60.00	026508025567
14834	Chrome	hdl sani wbh h chr 1	65.35	026508035870
14834CBN	Classic Brushed Nickel	hdl sani wbh h cbn 1	95.15	026508239827
14838CBN	Classic Brushed Nickel	hdl sani wbh c cbn 1	95.15	026508239834
14838	Chrome	hdl sani wbh c chr 1	65.35	026508035863
16000	Chrome	hdl knb metering 1h/2h chr	72.20	026508167038
16264	Chrome	spt sani 2h h-fl kd&bar chr	130.60	026508036129
162649	N/A or Unfinished	extension service kit	118.60	026508234594
163127	N/A or Unfinished	cartridge kit	125.05	026508234563
163128	Chrome	escutcheon, chr	77.95	026508234570
163128CBN	Classic Brushed Nickel	escutcheon, cbn	116.95	026508239865
163215	N/A or Unfinished	c-clip for fixed spout	11.85	026508255360
16350	Chrome	fra sani male thrd 0.5 gpm slowclose chr	20.15	026508036662
16352	N/A or Unfinished	sani slowclose crtrdge lav	117.80	026508044896
16360	Chrome	aerator key chr	5.70	026508228944
52000	N/A or Unfinished	cer disc cart, hot	17.35	026508160503
52001	N/A or Unfinished	cer disc cart -cold	17.35	026508160510
52002	N/A or Unfinished	cart nut kit mcp	24.10	026508160527
52003	Chrome	widespread esc.	40.05	026508160534
52005	N/A or Unfinished	torx wrench	5.30	026508160541
52006	Chrome	vandal res aerator	12.00	026508160558
52008	Chrome	lvr hndl cold	26.70	026508160572
52009	Chrome	lvr hdle hot	26.70	026508160589
52010	Chrome	commercial hdl service kit chr	53.35	026508165041
52011	Chrome	commercial hdl service kit chr	53.35	026508165058
52012	N/A or Unfinished	vacuum breaker service kit	18.70	026508182451
52015	Chrome	lever handle kit	49.35	026508212554
52016F03	Chrome	aerator .35gpm vand-resistant chr	20.75	026508236277
52016F15	Chrome	aerator 1.5gpm vand-resistant chr	20.75	026508236291
52016F22	Chrome	aerator 2.2gpm vand-resistant chr	20.75	026508236307
52019	Chrome	wallmount connection for 8124 [1 per box]	70.60	026508212561
52020	Chrome	wallmount connection for 8230 [1 per box]	70.60	026508212578
52021	Chrome	hd widespread spout kit	122.60	026508212585
52022	N/A or Unfinished	set screw for widespread spout	2.05	026508212592
52023	N/A or Unfinished	widespread mounting kit	36.00	026508212608
52024	N/A or Unfinished	set screw metering	2.05	026508212615
52025	N/A or Unfinished	friction washer series spts (2 per bag)	3.40	026508212622
52028	Chrome	center spout hub	66.55	026508228340
52035	Chrome	lever handle (hot/cold) chr	26.70	026508229576
52110	Chrome	metering handle	72.20	026508207642
52122	Chrome	metering escut w/color rings	55.70	026508207215
52125	N/A or Unfinished	metering, cartridge nut	27.95	026508207222
52600	Chrome	fra sani male thrd 0.5 gpm rosetta chr	18.70	026508026205
52601	Chrome	fra sani female thrd 0.5 gpm rosetta chr	18.70	026508026229
52602	Chrome	fra sani male thrd 0.5 gpm vp chr	20.15	026508026250
52603	Chrome	fra sani female thrd 0.5 gpm vp chr	20.15	026508026281
52608	Chrome	fra sani male thrd 1.5 gpm laminar chr	18.70	026508030394
52609	Chrome	fra sani female thrd 1.5 gpm laminar chr	18.70	026508026502
52610	Chrome	fra sani male thrd 1.5 gpm vp chr	20.15	026508030400
52611	Chrome	fra sani female thrd 1.5 gpm vp chr	20.15	026508035856
52612	Chrome	fra sani male thrd 2.0 gpm laminar chr	18.70	026508035894
52613	Chrome	fra sani female thrd 2.0 gpm laminar chr	18.70	026508035900
52614	Chrome	fra sani male thrd 2.0 gpm vp chr	20.15	026508027851
52615	Chrome	fra sani female thrd 2.0 gpm vp chr	20.15	026508027868
52618	Chrome	aerator male thrd .35 gpm vp chr	15.00	026508035917
52620	Chrome	m-dura serrated laboratory hose nozzle	29.40	026508035979
54036	N/A or Unfinished	hot/cold indicators	12.30	026508241462
840013	N/A or Unfinished	nut, adj temp limit stop cart brs	24.05	026508239568
840014	N/A or Unfinished	nut, adj temp limit stop cart brs	50.35	026508239575
840015F03	N/A or Unfinished	aerator .35gpm recessed vand-resistant	15.00	026508236338

Model No.	Finish	Product Description	UPC Code	List Price
840015F15	N/A or Unfinished	aerator 1.5gpm recessed vand-resistant	15.00	026508236369
840015F12	N/A or Unfinished	aerator 1.2gpm recessed vand-resistant	33.10	026508269640
840015F22	N/A or Unfinished	aerator 2.2gpm recessed vand-resistant	15.00	026508236352
870112	Chrome	single-mount escutcheon chr	15.85	026508244142
870113	Chrome	deck plate	53.05	026508244067
870114	Chrome	9" spout assembly kit chr	136.40	026508244159
870115	Chrome	12" spout assembly kit chr	140.40	026508244166
870116	Chrome	hardware package	154.65	026508246375
881111	Chrome	handle kit, 8894	26.70	026508235201
881121	Chrome	ws metering spout kit, chr	122.60	026508235249
92191	Chrome	1dl sani dx bld chr 2	59.95	026508032923
93379	Chrome	hdl cvr sani kd/lav 1h lr chr	21.00	026508040089
93455CBN	Classic Brushed Nickel	escutcheon screws, cbn	13.95	026508244722
93455	Chrome	esct scrw sani ts chr [2]	12.00	026508040119
176415	Chrome	vacuum breaker kit for 8124 and 8232	27.95	026508276037
176787	N/A or Unfinished	rectangular bracket- commercial kitchen	16.05	026508276044
183073	N/A or Unfinished	cage spacer kit for 8138	14.20	026508271513
183082	N/A or Unfinished	mounting hardware kit for 8138	26.25	026508271520
187104	N/A or Unfinished	mod sensor/bracket 8551 (AC), 8552 (AC)	213.65	026508277911
191187	N/A or Unfinished	8894 mounting hardware	13.05	026508291207
52016SLC05	N/A or Unfinished	cAChe 0.5 gpm slc vr aerator	20.75	026508274293
52016SLC12	N/A or Unfinished	cAChe 1.2 gpm slc vr aerator	20.75	026508269121
52016SLC22	N/A or Unfinished	cAChe 2.2 gpm slc vr aerator	20.75	026508274309
52018F12	N/A or Unfinished	1.2gpm cache vandal-resistant laminar	20.75	026508270288
59001	Chrome	modern 1h M-dura handle kit	41.40	026508012376
59002	N/A or Unfinished	M-dura 1h cartridge & retaining nut	33.95	026508012383
59003	N/A or Unfinished	M-dura atls & o-ring	16.90	026508012390
59004	Chrome	modern 1h M-dura dome	27.00	026508012406
59005	N/A or Unfinished	M-dura cache pca jr vr aerator key	4.90	026508261613
59006	Chrome	M-dura waste assembly with lift rod chr	69.90	026508012413
59007	N/A or Unfinished	mod 1h M-dura mounting kit	27.45	026508007457
59008	Chrome	mod ws M-dura handle kit	42.55	026508261491
59009	N/A or Unfinished	mod ws M-dura red/blue rings	6.85	026508261620
59010	Chrome	mod ws M-dura handle hub kit	82.40	026508261507
59011	N/A or Unfinished	ws M-dura mounting kit	28.70	026508261514
59012	Chrome	mod ws M-dura diverting spout 0.5gpm	194.40	026508261637
59013	Chrome	mod ws M-dura diverting spout 1.5gpm	194.40	026508261644
59014	Chrome	mod ws M-dura nondiverting spout 0.5gpm	195.75	026508261651
59015	Chrome	mod ws M-dura nondiverting spout 1.5gpm	195.75	026508261668
59016	Chrome	mod M-dura shower posi escutcheon	34.85	026508261521
59017	Chrome	mod M-dura shower posi handle kit	53.30	026508261538
59018	Chrome	mod M-dura shower 3F escutcheon	59.15	026508261675
59019	Chrome	mod M-dura shower 3F handle kit	67.20	026508261682
59021	Chrome	mod M-dura diverting tub spout	101.45	026508261545
59022	Chrome	mod M-dura nondiverting tub spout	93.70	026508261699
59023	N/A or Unfinished	mod M-dura tub spout gate kit	18.40	026508261705
59024	Chrome	M-dura ws waste assy mod lift rod chr	87.65	026508261552
59025	N/A or Unfinished	ws M-dura mounting kit (lift rod version)	53.50	026508261569
59027	Chrome	modern 1h M-bition handle kit	42.25	026508264737
59029	Chrome	3/32 set screw with allen wrench	6.10	026508264744
59030	N/A or Unfinished	modern 1h lav valve body o-ring	6.10	026508264751
59031	Chrome	M-bition waste assembly	48.30	026508264768
59033	Chrome	ws M-bition lift rod	17.50	026508264775
59034	Chrome	ws M-bition spout 1.2 gpm with lift rod	168.90	026508264782
59035	Chrome	3s M-bition spout 1.2 gpm w/o lift rod	166.60	026508264799
59036	Chrome	ws M-bition handle trim kit	81.55	026508264805
59037	Chrome	ws M-bition handle set screw/plugbutton	5.30	026508264812
150628CBN	Classic Brushed Nickel	handle dome cbn	11.85	026508239841
183085	Chrome	fra sani female thrd 1.2 gpm vp chr	20.15	-
52016F12	Chrome	aerator 1.2gpm vand-resistant chr	11.25	026508269619
52018F22	N/A or Unfinished	aerator 2.2gpm laminar vand-resist	11.85	026508232934
840011	Chrome	3" handle M-bition 1h lav chr	98.60	026508237076
840011CBN	Classic Brushed Nickel	3" handle M-bition 1h lav cbn	147.95	026508243299
840012	Chrome	4" handle M-bition 1h lav chr	98.60	026508237083
870121	Chrome	spout assembly kit chr	124.20	026508271278

Model No.	UPC	Page Number	Case Qty.	List Price
3360	026508222768	671	6	211.70
5263EP15	026508237236	668	12	58.05
5263EP15CBN	026508237243	668	12	105.95
5263EP17	026508237250	668	12	58.05
5263EP17CBN	026508237267	668	12	105.95
8103	026508162309	629	6	188.45
8113	026508162279	629	6	279.20
8116	026508162316	629	6	345.15
8119	026508162330	628	6	327.30
8124	026508026168	629	6	277.40
8126	026508162347	628	6	328.15
8137	026508185476	628	6	264.25
8138	026508199046	628	6	314.55
8210F05	026508235430	623	6	216.20
8210F12	026508266847	623	6	216.20
8210SMF05	026508258866	623	6	216.20
8210SMF12	026508266854	623	6	216.20
8215F03	026508235447	623	6	239.75
8215F05	026508235454	623	6	239.75
8215F12	026508266946	623	6	239.75
8215SMF12	026508266830	623	6	239.75
8220F05	026508235508	622	3	338.60
8225	026508162439	625	3	351.60
8225SMF15	026508238684	625	3	351.60
8226	026508155431	625	6	271.65
8227	026508162255	625	3	330.20
8228F05	026508235522	622	3	360.00
8228F12	026508266823	622	3	360.00
8229	026508162262	625	6	293.15
8230	026508172179	629	3	225.00
8242	026508185483	626	3	378.75
8244	026508185490	626	3	400.05
8248	026508181089	625	3	344.35
8248SMF12	026508267073	625	3	344.35
8270	026508154618	624	6	257.15
8276	026508167717	624	6	230.80
8277	026508199060	628	6	233.90
8278	026508167809	624	6	270.95
8278SM	026508238714	624	6	270.95
8278SMF12	026508267080	624	6	270.95
8279	026508167816	624	6	293.20
8279SM	026508238738	624	6	288.30
8279SMF12	026508267097	624	6	288.30
8280	026508154632	626	6	260.40
8285	026508161203	626	6	281.75
8287	026508162231	626	6	324.55
8289	026508162248	626	6	345.80
8290	026508154069	669	12	130.15
8290EP15	026508213360	669	12	125.10
8292	026508172186	669	12	135.85
8310	026508006412	650	3	655.60
8310AC16	026508167649	650	3	655.60
8310ACDF16	026508205969	650	3	688.25
8310DF16	026508205976	650	3	688.25
8310S35	026508265123	650	3	655.60
8310R16	026508160329	651	3	548.60
8310RDF16	026508205983	651	3	575.90
8310SR128	026508265178	651	3	548.60
8310SR35	026508265192	651	3	548.60
8310M128	026508236529	654	3	204.25
8310M16	026508236536	654	3	204.25
8310M35	026508236543	654	3	204.25
8310MR128	026508236550	654	6	164.35
8311	026508199077	650	3	655.60
8311AC12	026508199091	650	3	655.60

Model No.	UPC	Page Number	Case Qty.	List Price
8312	026508152225	650	3	655.60
8312AC10	026508167656	651	3	655.60
8312R10	026508160305	651	3	548.60
8312SR05	026508265260	651	3	548.60
8312SR125	026508265284	651	3	548.60
8312M0125	026508236574	654	3	204.25
8312M05	026508236581	654	3	204.25
8312M10	026508236598	654	3	204.25
8315	026508199084	650	3	655.60
8315AC05	026508199107	651	3	655.60
8316	026508205990	650	3	655.60
8316AC	026508213223	651	3	655.60
8342	026508078266	659	1	714.95
8342EP15	026508213377	659	1	714.95
8343	026508083130	657	1	734.30
8346	026508063347	660	4	507.60
8346EP15	026508213384	660	4	507.60
8349	026508015094	668	6	82.30
8349EP15	026508213391	668	6	82.30
8349EP15CBN	026508237045	668	6	119.85
8349EP17	026508228647	668	6	82.30
8349EP17CBN	026508237052	668	6	119.85
8360	026508086810	666	6	251.00
8370HD	026508228470	670	6	143.85
8370	026508013960	664	12	204.05
8371HD	026508228487	670	6	173.10
8372HD	026508228494	670	6	173.10
8373HD	026508228500	670	6	173.10
8374HD	026508228517	670	6	186.60
8375HD	026508239803	670	6	173.10
8375	026508040423	663	12	229.90
8375EP15	026508213407	663	12	229.90
8389EP15	026508213414	662	6	262.55
8400	026508015063	636	12	193.85
8413F03	026508234440	622	3	185.15
8413F05	026508234457	622	3	185.15
8413F12	026508266564	622	3	185.15
8414	026508137123	622	3	220.95
8414F12	026508269954	622	3	220.95
8414F12BN	026508271773	622	3	287.20
8416	026508017272	622	3	198.85
8416F05	026508234471	622	3	198.85
8417F05	026508234495	621	6	255.75
8417F12	026508266571	621	6	255.75
8419F05	026508227848	621	6	290.50
8419F12	026508266588	621	6	290.50
8420	026508015070	636	12	224.95
8422	026508232125	636	12	203.35
8422F05	026508232149	636	12	203.35
8425	026508015087	636	12	219.05
8430	026508066454	636	12	151.55
8430CBN	026508235348	636	12	197.05
8430F05	026508232156	636	12	151.55
8432	026508066461	636	12	186.55
8432F05	026508264706	636	12	186.55
8434	026508066478	637	12	179.85
8437	026508232163	637	12	196.25
8437CBN	026508235355	637	12	255.15
8439	026508232170	637	12	161.35
8439F05	026508232675	637	12	161.35
8551	026508249901	645	6	644.95
8551AC	026508249918	645	6	663.95
8552	026508249925	645	6	719.95
8552AC	026508249932	645	6	719.95
8553	026508249949	645	6	644.95

Model No.	UPC	Page Number	Case Qty.	List Price	Model No.	UPC	Page Number	Case Qty.	List Price
8553BL	026508343715	645	6	870.70	52224GBM25	026508226995	667	3	264.90
8553BN	026508343722	645	6	806.20	52224GBP25	026508227008	667	3	229.70
8553AC	026508249956	646	6	663.95	52236GBM15	026508227015	667	3	288.45
8553ACBL	026508344590	646	6	896.35	52236GBM15CBN	026508237007	667	3	590.10
8553ACBN	026508344606	646	6	829.95	52236GBM17	026508227022	667	3	288.45
8554	026508249963	646	6	719.95	52236GBM25	026508227046	667	3	288.45
8554AC	026508249970	646	6	719.95	52652	026508036198	631	24	33.00
8554ACBL	026508344613	646	6	971.95	52653	026508029336	631	24	34.45
8554ACBN	026508344620	646	6	899.95	52655	026508029510	631	24	20.75
8554BL	026508343739	646	6	971.95	52703	026508026083	669	12	72.65
8554BN	026508343746	646	6	899.95	52710	026508063361	667	6	300.65
8558	026508271995	642	3	539.15	52710CBN	026508237106	667	6	598.40
8558BL	026508343753	642	3	727.85	52710EP15	026508213346	667	6	300.65
8558BN	026508343760	642	3	673.95	52710EP15CBN	026508237144	667	6	598.40
8559	026508271483	642	6	615.25	52711	026508228630	669	12	54.50
8559BL	026508341599	642	6	830.60	52714	026508249871	669	12	54.50
8559BN	026508343777	642	6	769.05	52716EP15	026508213353	668	20	76.45
8560BL	026508343784	642	1	727.85	52740EP17	026508228524	667	6	300.05
8560	026508272008	642	3	539.15	52748EP15	026508234754	667	6	219.35
8560BN	026508343791	642	3	673.95	99550	026508207659	633	12	34.95
8562	026508271490	643	3	1117.10	99551	026508220689	633	12	34.95
8565	026508271506	643	3	639.80	99556	026508252130	645	20	38.25
8701	026508129739	627	6	159.85	99557	026508252147	645	20	38.25
8707	026508206515	627	6	190.45	99557BL	026508343968	645	20	52.60
8713	026508020951	627	6	479.65	99557BN	026508343975	645	20	47.85
8717	026508237649	627	6	282.25	99558	026508252154	645	20	49.15
8780	026508021859	639	6	129.50	99558BL	026508343708	645	20	67.55
8792	026508125717	639	6	295.60	99558BN	026508343869	645	20	61.45
8798	026508003930	639	6	207.60	99559	026508258859	621	20	38.25
8799	026508013779	639	6	270.60	100686	026508057711	669	60	54.65
8800	026508007778	638	6	179.90	100686CBN	026508246436	669	60	78.55
8800F05	026508235317	638	6	179.90	104414	026508081525	669	-	59.00
8810	026508007785	638	6	206.25	104451	026508199282	646	12	185.95
8820	026508007792	638	6	212.50	104540	026508245293	655	20	43.95
8884	026508093238	633	6	194.70	104541	026508245309	655	20	38.45
8886	026508093245	633	6	358.90	104542	026508245316	655	20	53.50
8889	026508093252	633	6	459.40	104543	026508245323	655	20	59.00
8894	026508220672	633	6	221.10	104544	026508245330	655	20	65.85
8915	026508094143	638	12	132.25	104545	026508245347	655	20	72.70
8917	026508030325	638	12	155.90	104546	026508245354	655	20	38.45
8922	026508039175	638	6	278.75	104547	026508245361	655	20	42.60
8924	026508039205	638	6	298.30	104548	026508245378	655	20	45.30
8938	026508003954	640	6	179.35	104549	026508245385	655	20	49.40
8948	026508061695	640	6	176.95	104550	026508245392	655	20	54.95
8957	026508030264	640	12	138.15	104551	026508245408	655	20	59.00
9263EP15	026508255438	668	12	79.35	104552	026508245415	655	20	65.85
9349EP15	026508255452	668	6	116.80	104553	026508245422	655	20	70.00
9417F05	026508257296	621	3	283.00	104554	026508245439	655	20	75.45
9417F12	026508266977	621	3	283.00	104555	026508246535	655	20	132.20
9419F05	026508255483	621	3	314.45	104556	026508244074	655	20	132.20
9419F12	026508266984	621	3	314.45	104557	026508244081	655	20	23.10
9480	026508255490	635	3	175.15	104560	026508247891	655	12	51.35
9482	026508255506	635	3	194.60	104561	026508246559	655	20	72.45
15440	026508245699	647	2	452.80	104563	026508245446	655	20	97.45
15856	026508015186	669	12	65.50	104564	026508246573	655	20	97.45
15856CBN	026508239858	669	12	95.40	104565	026508245453	655	20	97.45
52016F10	026508228708	648	24	21.35	104566	026508245460	655	20	97.45
52016F05	026508236284	648	100	21.35	104567	026508245477	655	20	97.45
52100	026508207635	633	24	97.45	104568	026508245484	655	20	97.45
52120	026508207048	623	12	180.85	104569	026508245491	655	20	29.30
52120	026508207048	623	12	180.85	104570	026508245507	655	12	21.65
52124GBM25	026508234112	666	3	259.00	104571	026508246580	655	20	28.90
52224GBM15	026508226964	667	3	264.90	104572	026508246514	655	20	7.50
52224GBM15CBN	026508236970	667	3	542.95	104573	026508246801	655	30	27.95
52224GBM17	026508226971	667	3	264.90	104574	026508246818	655	15	61.10

Model No.	UPC	Page Number	Case Qty.	List Price
104575	026508248010	655	6	54.80
104577	026508246825	655	30	13.15
104578	026508244098	655	12	55.20
104579	026508244104	655	12	59.90
104580	026508244111	655	12	55.30
104581	026508244128	655	20	38.65
104582	026508246832	655	20	35.15
104583	026508246856	655	20	30.30
104584	026508247877	655	12	89.95
104585	026508247884	655	-	141.75
104587	026508248614	652	6	172.75
104588	026508246863	655	20	32.50
104589	026508246870	655	20	52.25
104590	026508247426	655	33	31.05
104591	026508247433	655	33	31.05
104592	026508247440	655	33	31.05
104593	026508247457	655	33	31.05
104594	026508247464	655	33	31.05
104595	026508247471	655	33	31.05
104597	026508246849	655	40	20.75
104598	026508251843	655	20	30.60
104599	026508251850	655	20	54.95
104600	026508252536	655	12	58.95
104609	026508251867	655	20	12.00
104617	026508273999	652	12	35.00
104618	026508274002	652	12	82.80
104619	026508274019	652	12	82.80
104620	026508274026	652	12	82.80
104621	026508274033	652	12	82.80
104622	026508274040	652	12	82.80
104623	026508274057	652	12	82.80
104624	026508274064	652	12	82.80
104625	026508274071	652	12	39.00
104626	026508274088	652	12	40.05
104627	026508274095	652	12	37.30
104628	026508274101	652	12	110.20
104630	026508273609	647	12	113.20
104631	026508274118	652	12	37.40
104633	026508274125	652	12	133.35
104634	026508274132	652	20	26.35
174055	026508235799	648	12	35.05
174056	026508235904	648	12	111.40
174057	026508235911	648	12	30.95
174060	026508235942	648	12	19.60
174061	026508235959	648	12	27.50
174061BL	026508346426	648	12	37.85
174061BN	026508346433	648	12	34.40
174062	026508252765	648	12	10.15
174065	026508252772	648	12	55.60
174066	026508252789	648	12	6.45
174335	026508254394	648	12	220.05
174336	026508254400	648	20	21.85
174337	026508254417	648	20	21.85
174337BL	026508343845	648	20	30.00
174337BN	026508343852	648	20	27.30
175916	026508261903	647	12	17.55
175917	026508261910	647	1	17.55
175918	026508261927	647	12	17.55
175921	026508266755	647	12	17.55
175925	026508266762	647	12	17.55
175926	026508266779	647	12	17.55
181040	026508266786	647	12	17.55
181148	026508274491	642	12	82.20
181148BL	026508343913	642	12	111.00
181148BN	026508343920	642	12	102.75

Model No.	UPC	Page Number	Case Qty.	List Price
181149	026508274507	642	12	71.10
181149BL	026508343937	642	12	96.00
181149BN	026508343944	642	12	88.90
182413	026508272305	648	64	63.85
182414	026508272312	648	12	18.05
182415	026508272329	648	24	131.70
182416	026508272336	648	12	108.95
182418	026508272350	648	12	37.50
182420	026508272374	648	12	47.75
182421	026508272381	648	12	69.20
182422	026508272398	648	12	170.30
182534	026508273708	648	6	57.45
182535	026508273715	648	6	154.80
182536	026508273722	648	20	10.95
182537	026508273739	648	12	170.30
182538	026508273746	648	20	24.10
182540	026508273760	648	12	58.30
182542	026508273777	648	20	18.70
182543	026508273784	648	20	18.60
182544	026508273791	648	20	18.60
182546	026508273807	642	12	37.45
182546BL	026508343692	642	12	51.50
182546BN	026508343951	642	12	46.80
182547	026508273814	648	20	27.05
A723	026508228654	669	20	33.65
A725CBN	026508191224	669	12	89.45
CA8301	026508211076	642	3	623.50
CA8301BL	026508343807	642	3	841.75
CA8301BN	026508343814	642	3	779.40
CA8302	026508211083	642	6	615.25
CA8302BL	026508343821	642	6	830.60
CA8302BN	026508343838	642	6	769.05
CA8303	026508211090	643	3	693.80
S0000	026508181461	630	12	57.00
S0001	026508025314	630	12	68.55
S0002	026508025321	630	12	70.00
S0003	026508025338	630	12	68.55
S0004	026508025345	630	12	82.35
S0007	026508025376	630	12	70.00
S0009	026508025390	630	12	75.45
S0010	026508025406	630	12	82.35
S0011	026508025413	630	12	68.55
S0012	026508025420	630	12	149.65
S0020	026508148112	631	12	70.00
S0030NA	026508273821	631	6	79.20
S0030	026508148129	631	12	76.90
S0030T	026508269848	631	12	59.30
S0050	026508160718	631	12	85.10
S0050T	026508269855	631	12	67.45
S0060	026508199275	631	12	105.75
S0070	026508181478	631	12	92.00
SV003	026508025444	630	12	141.35
SV006	026508025475	630	12	131.80
SV010	026508025512	630	12	138.65
T8342	026508228562	659	1	371.85
T8342CBN	026508237151	659	1	546.55
T8342EP15	026508228579	659	1	371.85
T8342EP15CBN	026508237168	659	1	546.55
T8342NH	026508237175	659	1	362.90
T8342NHCBN	026508237182	659	1	497.65
T8343	026508228586	657	1	392.85
T8343CBN	026508237199	657	1	577.60
T8343EP15	026508228593	657	1	392.85
T8343EP15CBN	026508237625	657	1	577.60
T8346	026508228609	661	4	343.15

Model No.	UPC	Page Number	Case Qty.	List Price
T8346CBN	026508235638	661	4	486.55
T8346EP15	026508228616	661	4	343.15
T8346EP15CBN	026508235645	661	4	486.55
T8360	026508222775	666	3	49.60
T8360CBN	026508235652	666	3	90.60
T8370	026508211885	664	3	38.80
T8370CBN	026508235669	664	3	70.80
T8375	026508211892	663	3	67.00
T8375EP15	026508222782	663	3	67.00
T8375NH	026508235690	663	3	47.50
T8375NHCBN	026508235706	663	3	79.35
T8389	026508212134	662	3	102.60
T8389EP15	026508222799	662	3	102.60
T8389EP15CBN	026508235720	662	3	160.25
T9342EP15	026508257340	658	1	508.35
T9342GBM15	026508257388	658	1	559.15
T9346GBM15	026508255568	660	1	492.60
T9360	026508255582	666	3	137.20
T9370	026508255599	664	3	107.20
T9375EP15	026508255612	663	3	134.15
T9389EP15	026508255636	662	3	170.65
U8350	026508319697	665	3	262.95
UT8350	026508321126	665	3	195.40
UT8350CBN	026508321133	665	3	250.75

PRICE BAND IDENTIFICATION

Kitchen Collections

PREMIUM / BEST
IMAP PROTECTED

Nio™ — Modern
Tenon™ — Modern
Weymouth® — Transitional
Sinema™ — Transitional
Paterson™ — Transitional

2ND UPGRADE / BETTER
IMAP PROTECTED

Smyth™ — Traditional
Cia™ — Modern
Align® — Modern
KURV™ — Transitional

1ST UPGRADE / GOOD
IMAP PROTECTED

Belfield™ — Traditional
Genta™ LX — Modern
Sleek® — Modern

1ST UPGRADE / GOOD
NOT IMAP PROTECTED

Brantford® — Traditional
Arbor® — Transitional
Camerist® — Transitional
Kitchen Compliments
— Core Soap Dispensers

SPEC
NOT IMAP PROTECTED

Integra® — Transitional
Method™ — Modern
Chateau® — Transitional

PREMIUM / BEST
IMAP PROTECTED

Kitchen Compliments
— Pot Fillers
— SIP™ Carbon Filtration Compatible Faucets
— Premium Soap Dispensers

1ST UPGRADE / GOOD
IMAP PROTECTED

**Reverse Osmosis, Advanced Carbon, and
Simple Carbon Under Sink Filtration systems**

Smart Water Security and Irrigation

PREMIUM / BEST
IMAP PROTECTED

Flo Smart Water Monitor and Shutoff
Smart Leak Detector
Smart Sump Pump Monitor
Smart Irrigation
— Smart Sprinkler Controller - 8 Zone
— Smart Sprinkler Controller - 16 Zone
— Smart Wireless Soil Sensor
— Smart Sprinkler Controller Outdoor Enclosure

Touchless Kitchen Collections

PREMIUM / BEST
IMAP PROTECTED

Touchless Smart Faucet with Motion Control
Nio — Modern
Tenon — Modern
Weymouth — Traditional
Sinema — Transitional
Paterson — Traditional
MotionSense Wave™
Weymouth — Traditional
Sinema — Transitional

2ND UPGRADE / BETTER
IMAP PROTECTED

Touchless Smart Faucet with Motion Control
Smyth — Traditional
Cia — Modern
KURV — Transitional

Smart Faucet
Cia — Modern
Align — Modern
KURV — Transitional

MotionSense Wave
Smyth — Traditional
Cia — Modern
Align — Modern
KURV — Transitional

1ST UPGRADE / GOOD
IMAP PROTECTED

Smart Faucet
Brantford — Traditional
Arbor — Transitional
Belfield — Traditional
Sleek — Modern

MotionSense Wave
Brantford — Traditional
Arbor — Transitional
Belfield — Traditional
Genta LX — Modern
Sleek — Modern

Kitchen Sinks and Disposals

IMAP PROTECTED

Kitchen Sinks
Luxe Chef™
— Workstation Systems
— Workstation
Host™
— Fireclay
— Granite
Prep™
— 16 Gauge Stainless Steel
— 18 Gauge Stainless Steel
— 20 Gauge Stainless Steel

Disposals
Luxe Chef™
Host™
Prep™
Lite™

Bath and Shower Collections

PREMIUM / BEST
IMAP PROTECTED

Weymouth — Traditional
Arris™ — Modern
Flara™ — Transitional
Colinet™ — Transitional
90® — Modern
Doux™ — Modern
MotionSense Wave
Flara™ — Transitional
Doux™ — Modern

Smart Shower
**Premium Rainshowers/Showerheads,
Handshowers and Annex™ Shower Rail**

2ND UPGRADE / BETTER
IMAP PROTECTED

Greenfield™ — Transitional
Wynford™ — Traditional
Align™ — Modern
Rizon® — Modern
Belfield™ — Traditional
Cia — Modern
Voss™ — Transitional
MotionSense Wave
Cia — Modern

1ST UPGRADE / GOOD
IMAP PROTECTED

Dartmoor™ — Traditional
Glyde™ — Transitional

1ST UPGRADE / GOOD
NOT IMAP PROTECTED

Brantford™ — Traditional
Eva™ — Transitional
Vichy™ — Transitional
Gibson™ — Modern
Genta LX™ — Modern

SPEC
NOT IMAP PROTECTED

Chateau — Transitional

Matching Accessories

PREMIUM / BEST

Weymouth — Traditional
Arris — Modern
Flara — Transitional
Colinet — Traditional
90° — Modern
Doux — Modern

2ND UPGRADE / BETTER

Greenfield — Transitional
Wynford — Traditional
Align — Modern
Belfield — Traditional
Voss — Transitional

1ST UPGRADE / GOOD

Dartmoor — Traditional
Glyde — Transitional
Brantford — Traditional
Eva — Transitional
Genta LX — Modern

Coordinating Accessories

2ND UPGRADE / BETTER

Kingsley® — Traditional
Kyvos™ — Modern
Iso™ — Modern

1ST UPGRADE / GOOD

Artlys™ — Modern
Triva™ — Modern

CORE

Preston™ — Traditional
Madison™ — Traditional
Sage® — Transitional
Lounge™ — Transitional
Retreat® — Traditional
Mirror Only
Gilcrest™ — Traditional
Glenshire® — Traditional

SPEC

Aspen™ — Modern
Mason® — Transitional
Donner — Transitional

eBidet and eToilets

PREMIUM / BEST IMAP PROTECTED

Electronic Bidet Seats
— 5-Series (EB2100-E)
— 3-Series (EB1500-E, EB1500-EBS)

Electronic Cleansing Toilets
— 5-Series (ET2200)
— 3-Series (ET1300)
— 2-Series (ET900)

CORE NOT IMAP PROTECTED

Electronic Bidet Seats
— 3-Series (EB1000)
— 2-Series (EB800-E)

Non-Electronic Bidet Seats
— 2-Series (EB500-E, EB500-R)





Look for the WaterSense® logo to identify water-efficient Moen® faucets and showerheads that meet WaterSense® criteria.

Moen® kitchen faucet SKUs* are manufactured with a 1.5 gpm aerator that is certified to meet WaterSense® criteria. As of July 1, 2016, lavatory faucets are manufactured with a 1.2 gpm aerator that is certified to meet WaterSense® criteria and the California Energy Commission (CEC) regulation. The packaging label clearly indicates the WaterSense® logo and product flow rate. If the product you receive does not have the qualifying label markings, a replacement aerator can be ordered by calling 1-800-BUY-MOEN.

Moen® flow-optimized rainshowers and showerheads use up to 30% less water (compared to traditional 2.5 gpm showerheads) without sacrificing performance. Products throughout our showering portfolio with a WaterSense logo — including wall-mount, handshower and rainshower showerheads - are certified to meet EPA WaterSense® labeling criteria. These also contribute towards maximizing LEED points.

*Excluding all bathtub spouts and some commercial faucets and showerheads.



Moen® Eco-Performance (EP) showerheads and handshowers are flow-optimized to use up to 30% less water (compared to traditional 2.5 gpm showerheads) without sacrificing performance, and contribute towards maximizing LEED points.



The U.S. Green Building Council® developed the Leadership in Energy and Environmental Design (LEED®) Green Building Rating System as a nationally accepted benchmark for measuring and documenting green building practices.



The Green UPC® symbol indicates that this product has been certified by the International Association of Plumbing and Mechanical Officials (IAPMO) to reduce water consumption by at least 20% when compared to standard flow rates.

All Moen® lavatory and kitchen faucets meet NSF 372 requirements.



ADA Compliant – Many Moen® faucets, sinks and shower valve controls meet requirements for the physically challenged.

Shower Valve Rates

FLOW RATE VS. FLOWING INLET PRESSURE OF MOEN® SHOWERING VALVES (UNRESTRICTED)

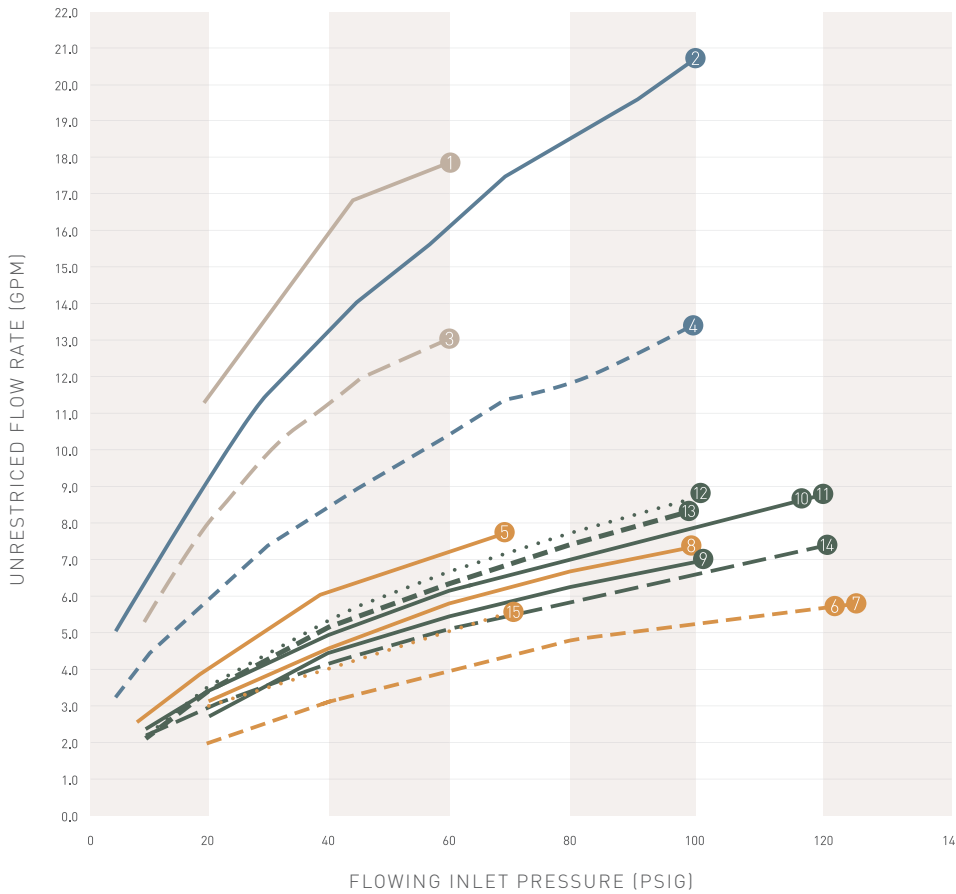

- 1 **ExactTemp® ¾" Thermostatic Showering**
S3371 ¾" ExactTemp: 18.0 GPM
- 2 **Smart Shower—4-Outlet**
S3104 4-Outlet: 16.0 GPM
- 3 **Volume Control**
S3600 Volume Control: 13+ GPM
- 4 **Smart Shower—2-Outlet**
S3102 2-Outlet: 10.0 GPM
- 5 **Posi-Temp® Tub Port**
4-Port Valve
Flow at Tub: 6.3 GPM
- 6 **Posi-Temp Shower Port**
4-Port Valve
Flow at Shower: 4.0 GPM
- 7 **Posi-Temp 3-Port**
3-Port Valve
Flow at Outlet: 6.3 GPM
- 8 **M-CORE® 4-Series Tub Port**
Flow at Tub: 5.7 GPM
- 9 **M-CORE 4-Series Shower Port**
Flow at Shower: 5.3 GPM
- 10 **M-CORE 3-Series Tub Port**
Flow at Tub: 6.2 GPM
- 11 **M-CORE 3-Series Shower Port**
Flow at Shower: 5.8 GPM
- 12 **M-CORE 2-Series Tub Port**
Flow at Tub: 6.7 GPM
- 13 **M-CORE 2-Series Shower Port**
Flow at Shower: 6.4 GPM
- 14 **M-CORE with Transfer**
Two Outlets: 5.6 GPM
- 15 **Posi-Temp with Integrated Transfer**
Two Outlets: 5.0 GPM

SHOWER SPA INSTALLATION RECOMMENDATIONS

Graph Line	Valves	Flow Rate through Shower Port (GPM) at 20 PSI	Flow Rate through Shower Port (GPM) at 40 PSI	Flow Rate through Shower Port (GPM) at 60 PSI	Use with a Transfer Valve	Maximum Components
1	ExactTemp® ¾" Thermostatic S3371	11.4	15.7	18.0	No	4 Components: Any Combination of Showerheads, Handshower and Body Sprays (4 max)
2	Smart Shower—4-Outlet S3104	9.0	13.0	16.0	No	4 Components: Any Combination of Showerheads, Handshower and Body Sprays (4 max)
4	Smart Shower—2-Outlet S3102	6.0	8.5	10.0	No	Showerhead, Handshower or Showerhead, 2 Body Sprays
6	Posi-Temp 3-Port	3.6	5.1	6.3	Yes	Showerhead, Handshower or Showerhead, 2 Body Sprays*
7	M-CORE 4-Series Shower Port	2.9	4.3	5.3	Yes	Showerhead, Handshower or Showerhead, 2 Body Sprays*
9	M-CORE 3-Series Shower Port	3.1	4.6	5.8	Yes	Showerhead, Handshower or Showerhead, 2 Body Sprays*
11	M-CORE 2-Series Shower Port	3.5	5.1	6.4	Yes	Showerhead, Handshower or Showerhead, 2 Body Sprays*
13	M-CORE with Transfer	3.0	4.5	5.6	No	Showerhead, Handshower or Showerhead, 2 Body Sprays*
14	Posi-Temp Shower Port 4-Port	2.1	3.2	4.0	Yes	Showerhead, Handshower*
15	Posi-Temp with Integrated Transfer	3.0	4.0	5.0	No	Showerhead, Handshower

*Minimum 50 PSI recommended when plumbing a showerhead and 2 body sprays for shared flow.



Customer Service

Moen, Commercial, CFG and Garbage Disposal

MOEN FAUCET PRODUCTS

Phone: 1-800-531-1600

Fax: 1-800-848-6636

Email orders and general inquiries to:

moencustomerservicewholesaleUS@moen.com

MOEN B2B CONNECT

Moen's best-in-class 24/7 online support for ordering, product availability, pricing inquiries and more.

Phone: 1-888-450-5829

Email: moencustomerservicewholesaleUS@moen.com

Website: B2BConnect.com

MOEN ACCESSORY PRODUCTS

Phone: 1-800-531-1606

Fax: 1-888-379-2720

Email orders and general inquiries to:

moencustomerserviceUS@moen.com

HELPFUL WEBSITES

moen.com

CFGonline.com

moen.com/professional

Pricing effective January 1, 2024. Although descriptions are believed correct at publication approval, accuracy cannot be guaranteed.

Moen reserves the right to make product specification changes from time to time, without notice or obligation, and to change or discontinue models.

Connect with us:
moen.com/social

U.S. Headquarters:
Moen Incorporated
25300 Al Moen Drive
North Olmsted, OH 44070-8022

Canada Headquarters:
Moen
2816 Bristol Circle
Oakville, Ontario L6H 5S7

Visit our website at moen.com

1-800-BUY-MOEN

1-800-465-0279