



2 0 2 4 C A B I N E T & A R C H I T E C T U R A L H A R D W A R E

OMNIA

MANUFACTURERS OF FINE LOCKSETS & ARCHITECTURAL HARDWARE

Suggested Retail Prices Effective May 1, 2024

Table of Contents

SECTION	PAGE
Finishes Chart	3
CABINET/APPLIANCE PULLS & KNOBS • SOLID BRASS & GLASS	
Elite	4-5
Ultima I	6-8
Ultima II	9-11
Ultima III	12-14
Ultima IV	15-20
Ultima Knobs	21
Traditions	22-23
Prodigy	23
CABINET/APPLIANCE PULLS & KNOBS • STAINLESS STEEL	
Cabinet Pulls	24-26
Cabinet Knobs	27
CABINET KNOBS & PULLS • SOLID BRASS	
Legacy	28
Ornate	29
ALL DOOR PULLS/APPLIANCE PULLS	
Stainless Steel	30
Elite	30
Traditions	31
Ultima I	31
Ultima II	32
Ultima III	32
Ultima IV	33
MISC. ARCHITECTURAL HARDWARE	
Flushcups • Solid Brass & Stainless Steel	34-35
Door Stops & Ball Catch • Solid Brass & Stainless Steel	36
Latch & Decorative Hooks • Solid Brass	37
Switchplates • Solid Brass	38-40
OMNIA TERMS & CONDITIONS	41

The story of OMNIA began over sixty years ago when our company's founder, Alberto R. Comini came to this country with a vision to introduce to the U.S. market beautifully designed and crafted Italian architectural hardware. To this day, OMNIA has steadfast ties to Italy and while now helmed by the next generation of Comini family members, we continue to stay true to our founding principle of forging our own path.

It is all the people behind the products that make up the OMNIA family including our fiercely loyal employees and our customers with whom we have fostered long-standing relationships. As our business grows, so does our family tree and new opportunities are greeted with Italian hospitality and warmth.

Over the course of our history, OMNIA has built a legacy upon developing products innovative in both design and technological advancement. Our focus is always on what lies ahead and we constantly challenge ourselves to stay in the forefront of our industry. This latest presentation showcases our current product offerings shown with suggested retail prices.

Our products are meticulously fabricated from the finest brass materials or premium-grade stainless steel in order to meet the exceptional standards of the finished project of your dreams. Choose the hardware that is expressly YOU and come to know the look and feel of OMNIA.



OMNIA Finishes

Always check each item number to make sure a finish is available for a particular design.

	Code	Description		Code	Description
	US3	POLISHED BRASS, LACQUERED		US14	POLISHED NICKEL PLATED, LACQUERED
	US3A	POLISHED BRASS, UNLACQUERED		US15	SATIN NICKEL PLATED, LACQUERED
	US4	SATIN BRASS, LACQUERED		US26	POLISHED CHROME PLATED
	US5	ANTIQUÉ BRASS, LACQUERED		US32D	SATIN STAINLESS STEEL
	US10B	BLACK, OIL-RUBBED, LACQUERED			

Additional Finishes

(Only available on certain items)

	US15A PEWTER, LACQUERED		US26D SATIN CHROME PLATED		SB SHADED BRONZE, LACQUERED		VB VINTAGE BRASS
	VC VINTAGE COPPER		VI VINTAGE IRON		PBL PVD BLACK		PDB PVD DARK BRONZE
	PSG PVD SATIN GOLD		PTT PVD TITANIUM				

ELITE

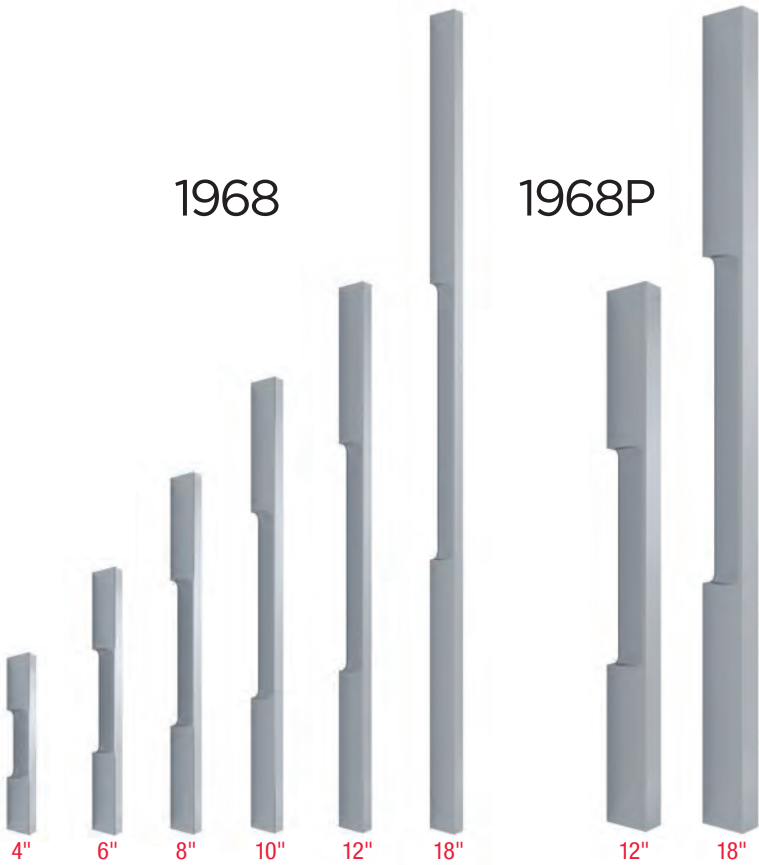

Item#	Center to Center	Overall Length	Proj.	FINISHES		
				US4 US14 US26	US5 US10B US15	
1968 Cabinet Pull 5/16" W	1968/102	4"	4 1/2"	1 1/16"	\$40	\$45
	1968/153	6"	6 1/2"		45	52
	1968/203	8"	8 1/2"		54	60
	1968/254	10"	10 1/2"		57	67
	1968/305	12"	12 1/2"		69	78
	1968/457	18"	18 1/2"		80	90
1968P Appliance Pull 19/32" W	1968P/305	12"	12 15/16"	1 3/16"	\$203	\$215
	1968P/305BB*	12"	12 15/16"		203	215
	1968P/457	18"	18 15/16"		261	272
	1968P/457BB*	18"	18 15/16"		261	272

*In order to achieve back-to-back, order one regular pull and one BB.

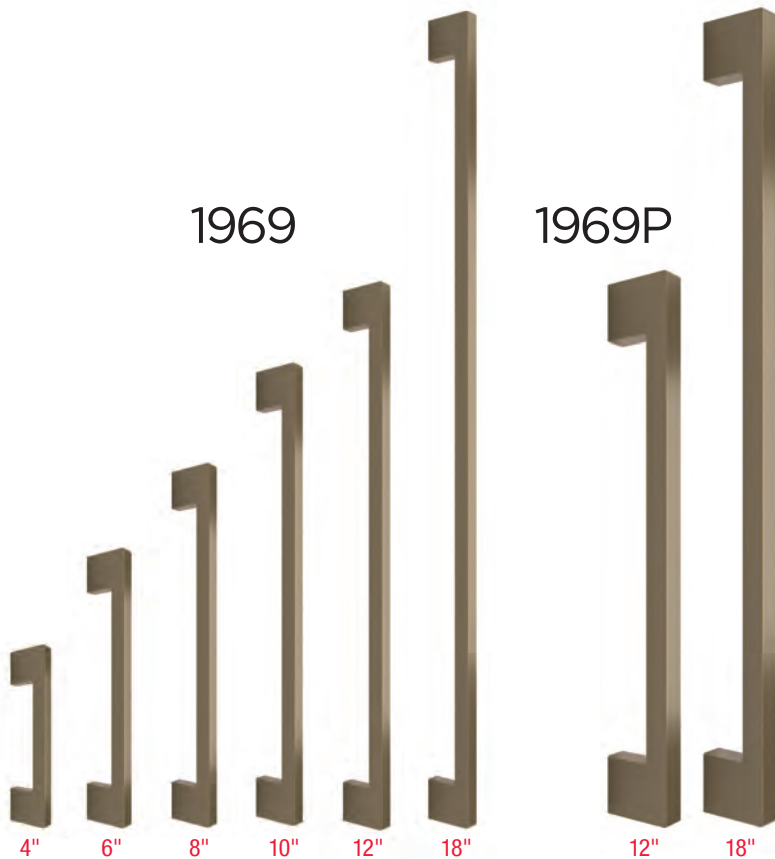

Item#	Center to Center	Overall Length	Proj.	FINISHES		
				US4 US14 US26	US5 US10B US15	
1969 Cabinet Pull 5/16" W	1969/102	4"	4 15/16"	1 3/16"	\$50	\$54
	1969/153	6"	6 15/16"		60	66
	1969/203	8"	8 15/16"		69	80
	1969/254	10"	10 15/16"		79	87
	1969/305	12"	12 15/16"		90	100
	1969/457	18"	18 15/16"		120	128
1969P Appliance Pull 19/32" W	1969P/305	12"	13 1/8"	1 3/4"	\$220	\$229
	1969P/305BB*	12"	13 1/8"		220	229
	1969P/457	18"	19 1/8"		272	278
	1969P/457BB*	18"	19 1/8"		272	278

*In order to achieve back-to-back, order one regular pull and one BB.

Suggested retail prices effective May 1, 2024.

ELITE

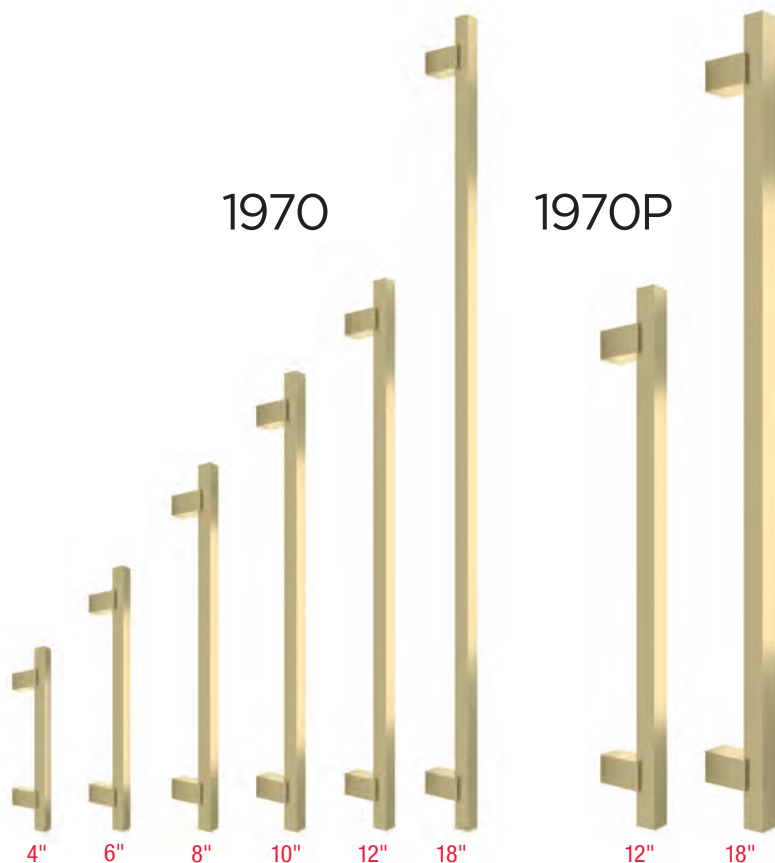

Item#	Center to Center	Overall Length	Proj.	FINISHES		
				US4 US14 US26	US5 US10B US15	US5 US10B US15
1970	1970/102	4"	5 ¹⁵ / ₁₆ "	1 ¹ / ₄ "	\$72	\$78
Cabinet Pull	1970/153	6"	7 ¹⁵ / ₁₆ "		76	88
	1970/203	8"	9 ¹⁵ / ₁₆ "		80	96
⁹ / ₁₆ " W	1970/254	10"	11 ¹⁵ / ₁₆ "		84	101
	1970/305	12"	13 ¹⁵ / ₁₆ "		90	110
	1970/457	18"	19 ¹⁵ / ₁₆ "		99	114
1970P	1970P/305	12"	14 ³ / ₄ "	1 ³ / ₄ "	\$220	\$229
Appliance Pull	1970P/305BB*	12"	14 ³ / ₄ "		220	229
	1970P/457	18"	20 ³ / ₄ "		272	278
¹³ / ₁₆ " W	1970P/457BB*	18"	20 ³ / ₄ "		272	278

*In order to achieve back-to-back, order one regular pull and one BB.

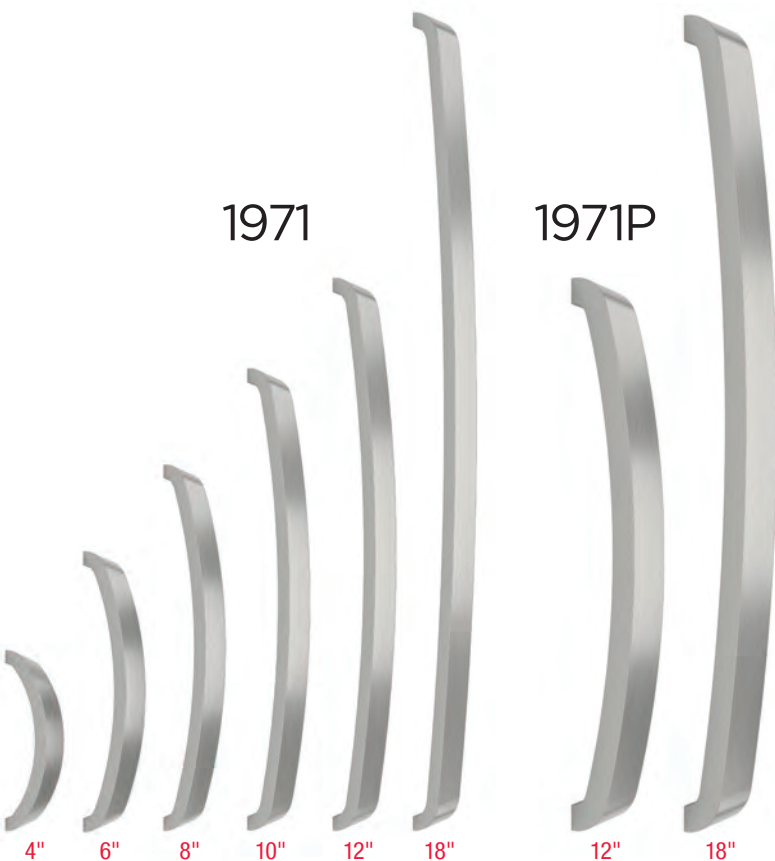

Item#	Center to Center	Overall Length	Proj.	FINISHES		
				US4 US14 US26	US5 US10B US15	US5 US10B US15
1971	1971/102	4"	4 ³ / ₈ "	1 ³ / ₁₆ "	\$40	\$45
Cabinet Pull	1971/153	6"	6 ³ / ₈ "		45	52
	1971/203	8"	8 ³ / ₈ "		54	60
³ / ₄ " W	1971/254	10"	10 ³ / ₈ "		57	67
	1971/305	12"	12 ³ / ₈ "		69	78
	1971/457	18"	18 ³ / ₈ "		80	91
1971P	1971P/305	12"	12 ¹¹ / ₁₆ "	1 ³ / ₄ "	\$203	\$215
Appliance Pull	1971P/305BB*	12"	12 ¹¹ / ₁₆ "		203	215
	1971P/457	18"	18 ⁹ / ₁₆ "		261	272
¹³ / ₁₆ " W	1971P/457BB*	18"	18 ⁹ / ₁₆ "		261	272

*In order to achieve back-to-back, order one regular pull and one BB.

Suggested retail prices effective May 1, 2024.

Ultima I

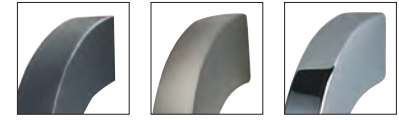

US10B US15 US26



9005

3 3/4" 5 3/4" 7 3/4"

Item#	Center to Center	Overall Length	Proj.	FINISHES			NON-STOCK*		
				US10B	US15	US26	US3	US3A	US4
9005 Cabinet Pull 5/8" W	9005/96	3 3/4"	4"	1 1/8"	\$16	\$20			
	9005/146	5 3/4"	6"		21	27			
	9005/197	7 3/4"	8"		30	38			

Use 9006P below as a coordinating Appliance Pull.

*Non-stock finishes require a 12-week lead time and a minimum order of \$1,000.00 list.

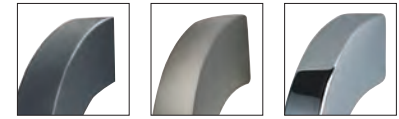

US10B US15 US26

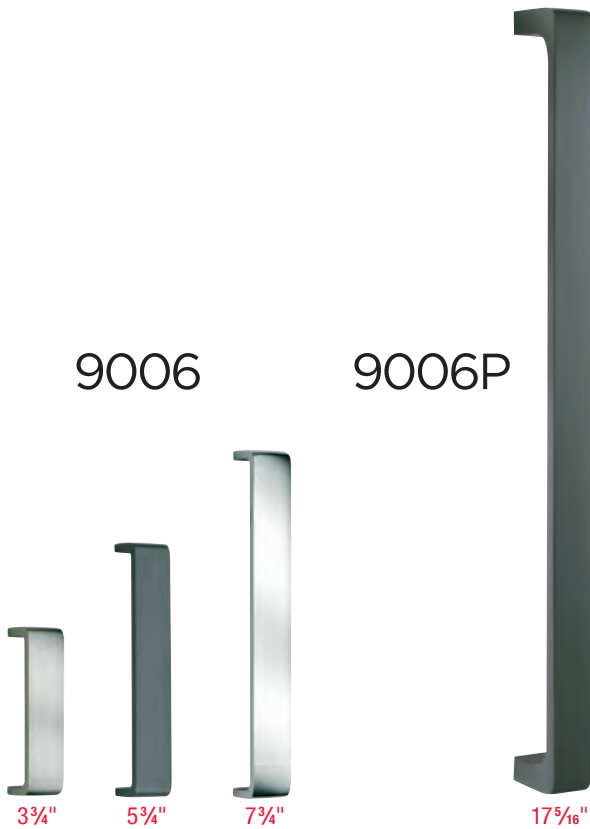

9006

9006P

3 3/4" 5 3/4" 7 3/4"

17 5/16"

Item#	Center to Center	Overall Length	Proj.	FINISHES			NON-STOCK*		
				US10B	US15	US26	US3	US3A	US4
9006 Cabinet Pull 15/16" W	9006/96	3 3/4"	4"	1 1/8"	\$24	\$30			
	9006/146	5 3/4"	6"		33	42			
	9006/197	7 3/4"	8"		44	55			
9006P Appliance Pull 1" W	9006P/440	17 5/16"	17 15/16"	2"	\$227	\$284			
	9006P/440B**	17 5/16"	17 15/16"		227	284			

*Non-stock finishes require a 12-week lead time and a minimum order of \$1,000.00 list.

**In order to achieve back-to-back, order one regular pull and one B.

Suggested retail prices effective May 1, 2024.

Ultima I

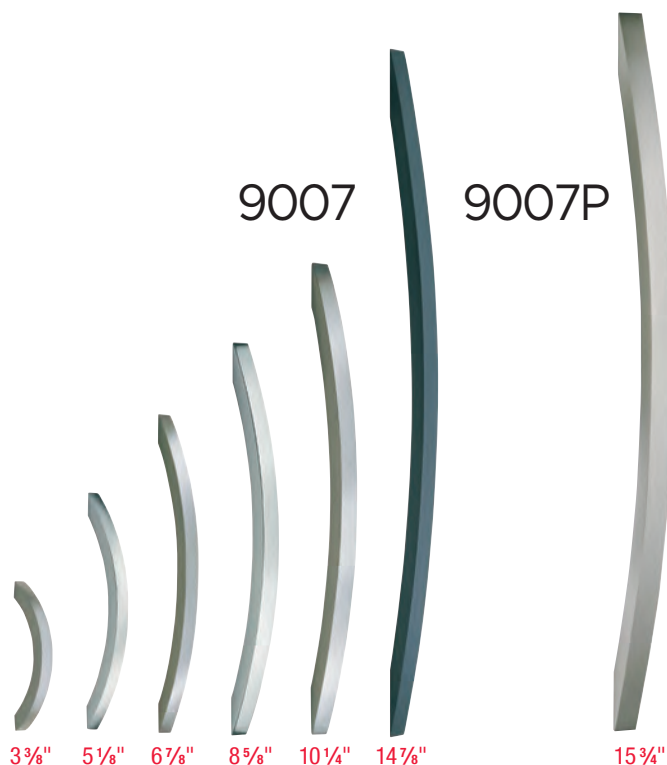

	Item#	Center to Center	Overall Length	Proj.	FINISHES			NON-STOCK*		
					US10B	US15	US26	US3	US3A	US4
9007 Cabinet Pull 3/8" w	9007/86	3 3/8"	4"	1 3/16"	\$15			\$19		
	9007/130	5 1/8"	6"		19			24		
	9007/175	6 7/8"	8"		24			30		
1/2" w	9007/220	8 5/8"	10"	1 5/16"	\$50			\$63		
	9007/260	10 1/4"	12"		58			73		
	9007/377	14 7/8"	18"	1 3/8"	87			109		

9007P Appliance Pull 5/8" w	9007P/400**	15 3/4"	17 15/16"	2"	\$170			\$213		
--	-------------	---------	-----------	----	--------------	--	--	--------------	--	--

**Non-stock finishes require a 12-week lead time and a minimum order of \$1,000.00 list.*
***Not available back-to-back.*

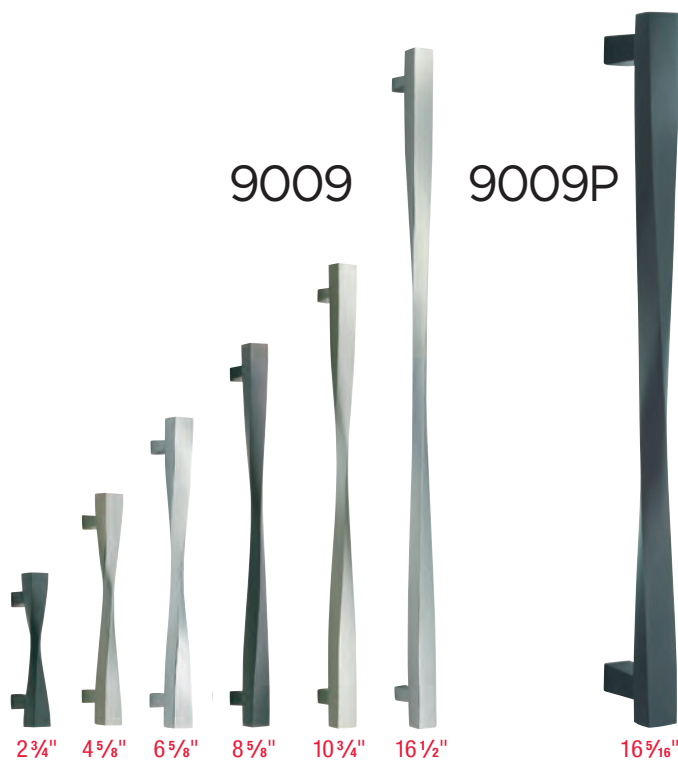

	Item#	Center to Center	Overall Length	Proj.	FINISHES			NON-STOCK*		
					US10B	US15	US26	US3	US3A	US4
9009 Cabinet Pull 9/16" w	9009/70	2 3/4"	4"	1 3/8"	\$21			\$27		
	9009/118	4 5/8"	6"		31			39		
	9009/170	6 5/8"	8"		42			53		
	9009/220	8 5/8"	10"		49			62		
	9009/273	10 3/4"	12 1/4"	1 1/2"	69			87		
	9009/420	16 1/2"	18"		101			127		

9009P Appliance Pull 7/8" w at widest point	9009P/415	16 5/16"	18"	2 5/8"	\$297			\$372		
	9009P/415B**	16 5/16"	18"		297			372		

**Non-stock finishes require a 12-week lead time and a minimum order of \$1,000.00 list.*
***In order to achieve back-to-back, order one regular pull and one B.*

Suggested retail prices effective May 1, 2024.

Ultima I

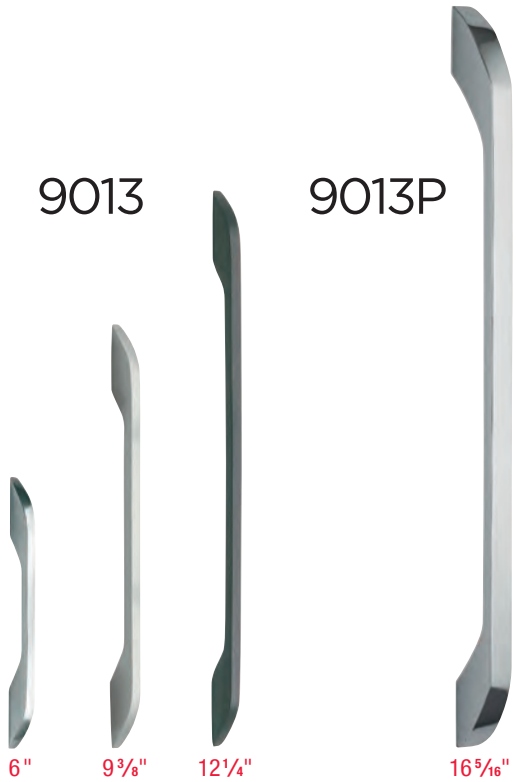

	Item#	Center to Center	Overall Length	Proj.	FINISHES			NON-STOCK*		
					US10B	US15	US26	US3	US3A	US4
9013 Cabinet Pull 3/8" W	9013/150	6"	8"	1 1/8"	\$35			\$44		
	9013/238	9 3/8"	11"		42			53		
	9013/311	12 1/4"	14"		49			62		
9013P Appliance Pull 3/4" W at widest point	9013P/415	16 5/16"	17 15/16"	1 7/8"	\$183			\$229		
	9013P/415B**	16 5/16"	17 15/16"		183			229		

*Non-stock finishes require a 12-week lead time and a minimum order of \$1,000.00 list.

**In order to achieve back-to-back, order one regular pull and one B.

Suggested retail prices effective May 1, 2024.

Ultima II

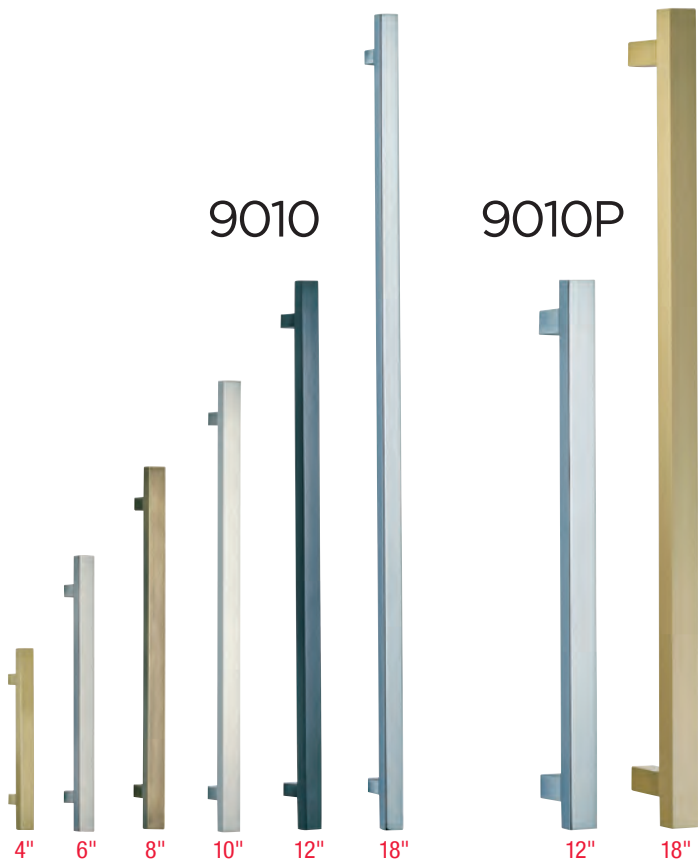

	Item#	Center to Center	Overall Length	Proj.	FINISHES	
					US4 US14 US15 US26	US5 US10B
9010 Cabinet Pull 1/2" w	9010/102	4"	6"	1 3/8"	\$34	\$40
	9010/153	6"	8"		44	51
	9010/203	8"	10"		54	62
	9010/254	10"	12"		63	73
	9010/305	12"	14"		73	84
	9010/457	18"	20"		102	118
9010P Appliance Pull 3/4" w	9010P/305	12"	14"	2 5/16"	\$177	203
	9010P/305B*	12"	14"		177	203
	9010P/457	18"	20"		248	285
	9010P/457B*	18"	20"		248	285

*In order to achieve back-to-back, order one regular pull and one B.



	Item#	Center to Center	Overall Length	Proj.	FINISHES	
					US4 US14 US15 US26	US5 US10B
9023 Cabinet Pull 5/16" w	9023/102	4"	4 1/2"	1 3/8"	\$18	\$20
	9023/153	6"	6 1/2"		24	28
	9023/203	8"	8 1/2"		30	34
	9023/254	10"	10 1/2"		38	42
	9023/305	12"	12 1/2"		42	50
	9023/457	18"	18 1/2"		62	72
9023P Appliance Pull 5/8" w	9023P/305	12"	12 3/4"	2 3/16"	\$172	\$197
	9023P/305B*	12"	12 3/4"		172	197
	9023P/457	18"	18 3/4"		238	273
	9023P/457B*	18"	18 3/4"		238	273

*In order to achieve back-to-back, order one regular pull and one B.

Suggested retail prices effective May 1, 2024.

Ultima II

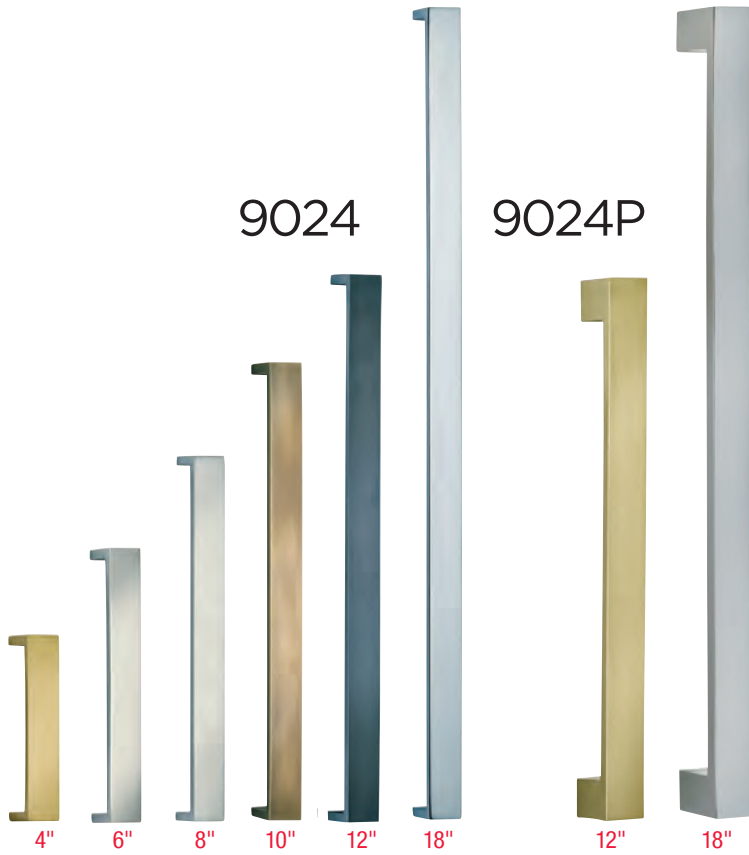

Item#	Center to Center	Overall Length	Proj.	FINISHES	
				US4 US14 US15 US26	US5 US10B
9024 Cabinet Pull 3/4" w	9024/102	4"	4 1/4"	1 3/16"	\$24 \$28
	9024/153	6"	6 1/4"		31 35
	9024/203	8"	8 1/4"		39 44
	9024/254	10"	10 1/4"		46 53
	9024/305	12"	12 1/4"		53 61
9024/457	18"	18 1/4"		75 87	
9024P Appliance Pull 1" w	9024P/305	12"	13"	2"	\$154 \$177
	9024P/305B*	12"	13"		154 177
	9024P/457	18"	19"		206 237
	9024P/457B*	18"	19"		206 237

*In order to achieve back-to-back, order one regular pull and one B.

Bases are larger than cabinet pull bases to accommodate appliance mounting screws.

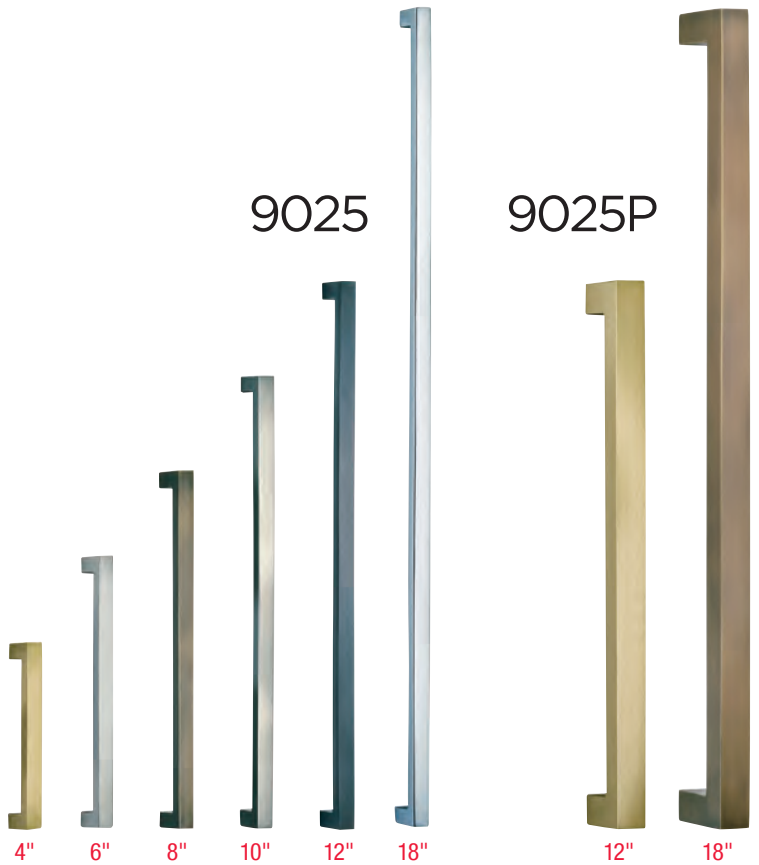

Item#	Center to Center	Overall Length	Proj.	FINISHES	
				US4 US14 US15 US26	US5 US10B
9025 Cabinet Pull 3/8" w	9025/102	4"	4 7/16"	1 3/16"	\$20 \$23
	9025/153	6"	6 7/16"		28 31
	9025/203	8"	8 7/16"		33 38
	9025/254	10"	10 7/16"		40 46
	9025/305	12"	12 7/16"		47 54
9025/457	18"	18 7/16"		66 75	
9025P Appliance Pull 3/4" w	9025P/305	12"	12 3/4"	2"	\$176 \$202
	9025P/305B*	12"	12 3/4"		176 202
	9025P/457	18"	18 3/4"		246 283
	9025P/457B*	18"	18 3/4"		246 283

*In order to achieve back-to-back, order one regular pull and one B.

Suggested retail prices effective May 1, 2024.

Ultima II

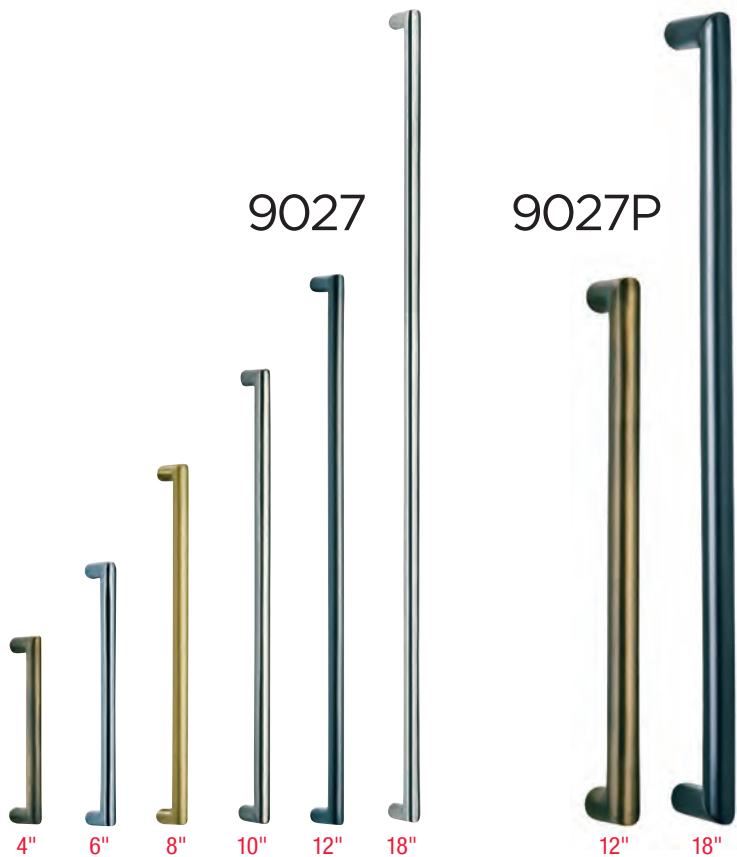

	Item#	Center to Center	Overall Length	Proj.	FINISHES	
					US4 US14 US15 US26	US5 US10B
9027 Cabinet Pull 3/8" w	9027/102	4"	4 7/16"	1 3/16"	\$15	\$17
	9027/153	6"	6 7/16"		19	23
	9027/203	8"	8 7/16"		24	28
	9027/254	10"	10 7/16"		30	34
	9027/305	12"	12 7/16"		34	40
	9027/457	18"	18 7/16"	49	55	
9027P Appliance Pull 3/4" w	9027P/305	12"	12 3/4"	2"	\$139	\$160
	9027P/305B*	12"	12 3/4"		139	160
	9027P/457	18"	18 3/4"		194	224
	9027P/457B*	18"	18 3/4"		194	224

*In order to achieve back-to-back, order one regular pull and one B.

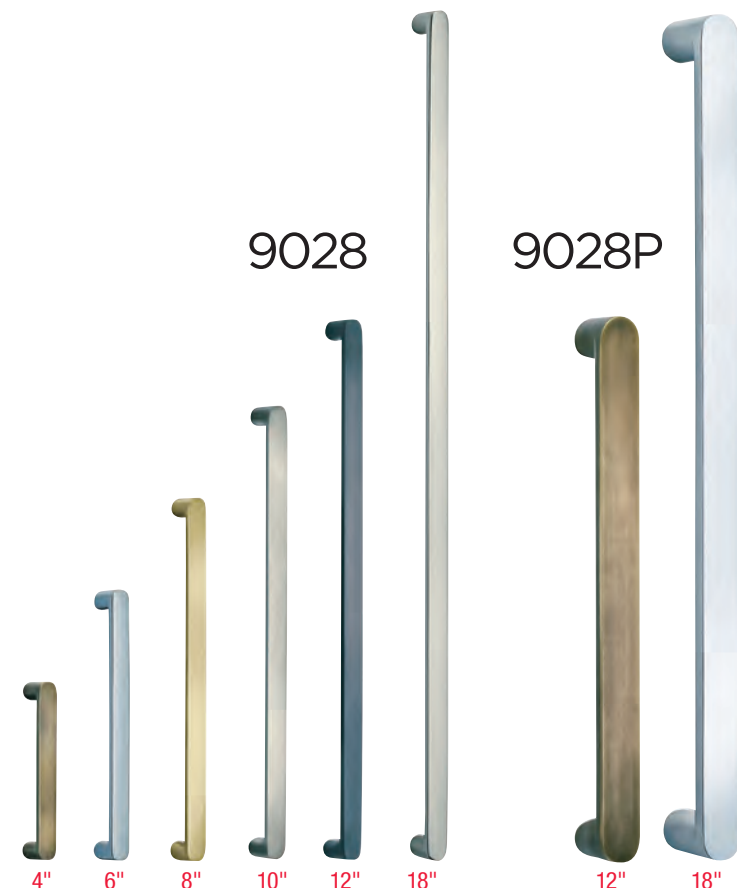

	Item#	Center to Center	Overall Length	Proj.	FINISHES	
					US4 US14 US15 US26	US5 US10B
9028 Cabinet Pull 7/16" w	9028/102	4"	4 1/2"	1 3/16"	\$17	\$19
	9028/153	6"	6 1/2"		20	24
	9028/203	8"	8 1/2"		26	29
	9028/254	10"	10 1/2"		30	33
	9028/305	12"	12 1/2"		33	39
	9028/457	18"	18 1/2"	49	55	
9028P Appliance Pull 1" w	9028P/305	12"	13"	2"	\$146	\$168
	9028P/305B*	12"	13"		146	168
	9028P/457	18"	19"		194	224
	9028P/457B*	18"	19"		194	224

*In order to achieve back-to-back, order one regular pull and one B.

Suggested retail prices effective May 1, 2024.

Ultima III

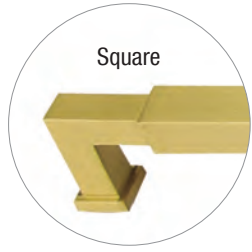

9029

9029P



Item#	Center to Center	Overall Length	Proj.	FINISHES					
				US3A	US4	US5	US10B	US14	US15
9029 Cabinet Pull 7/16" W	9029/102	4"	4 7/16"	1 3/16"	\$28				
	9029/153	6"	6 7/16"		\$38				
	9029/203	8"	8 7/16"		\$50				
	9029/254	10"	10 7/16"		\$60				
	9029/305	12"	12 7/16"		\$72				
9029/457	18"	18 7/16"		\$103					
9029P Appliance Pull 3/4" W	9029P/305	12"	12 3/4"	2 3/16"	\$234				
	9029P/305B*	12"	12 3/4"		\$234				
	9029P/457	18"	18 3/4"		\$345				
	9029P/457B*	18"	18 3/4"		\$345				

*In order to achieve back-to-back, order one regular pull and one B.

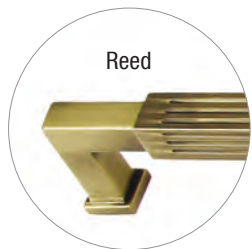

9031

9031P



Item#	Center to Center	Overall Length	Proj.	FINISHES					
				US3A	US4	US5	US10B	US14	US15
9031 Cabinet Pull 7/16" W	9031/102	4"	4 7/16"	1 3/16"	\$34				
	9031/153	6"	6 7/16"		\$46				
	9031/203	8"	8 7/16"		\$56				
	9031/254	10"	10 7/16"		\$67				
	9031/305	12"	12 7/16"		\$78				
9031/457	18"	18 7/16"		\$111					
9031P Appliance Pull 3/4" W	9031P/305	12"	12 3/4"	2 3/16"	\$249				
	9031P/305B*	12"	12 3/4"		\$249				
	9031P/457	18"	18 3/4"		\$370				
	9031P/457B*	18"	18 3/4"		\$370				

*In order to achieve back-to-back, order one regular pull and one B.

Suggested retail prices effective May 1, 2024.

Ultima III

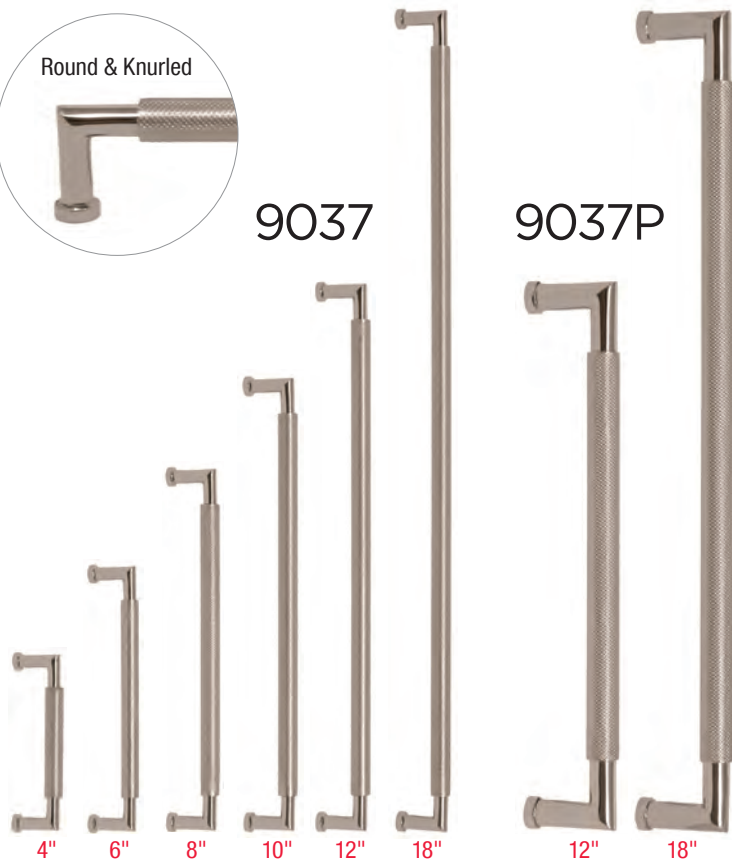

	Item#	Center to Center	Overall Length	Proj.	FINISHES					
					US3A	US4	US5	US10B	US14	US15
9037 Cabinet Pull	9037/102	4"	4 ⁷ / ₁₆ "	1 ¹ / ₈ "						\$28
	9037/153	6"	6 ⁷ / ₁₆ "							38
	9037/203	8"	8 ⁷ / ₁₆ "							50
	7 ¹ / ₁₆ " max. dia.	10"	10 ⁷ / ₁₆ "							60
		12"	12 ⁷ / ₁₆ "							72
	9037/457	18"	18 ⁷ / ₁₆ "							103
9037P Appliance Pull	9037P/305	12"	12 ³ / ₄ "	2 ¹ / ₈ "						\$234
	9037P/305B*	12"	12 ³ / ₄ "							234
	9037P/457	18"	18 ³ / ₄ "							345
	3 ³ / ₄ " max. dia.	9037P/457B*	18"	18 ³ / ₄ "						345

*In order to achieve back-to-back, order one regular pull and one B.

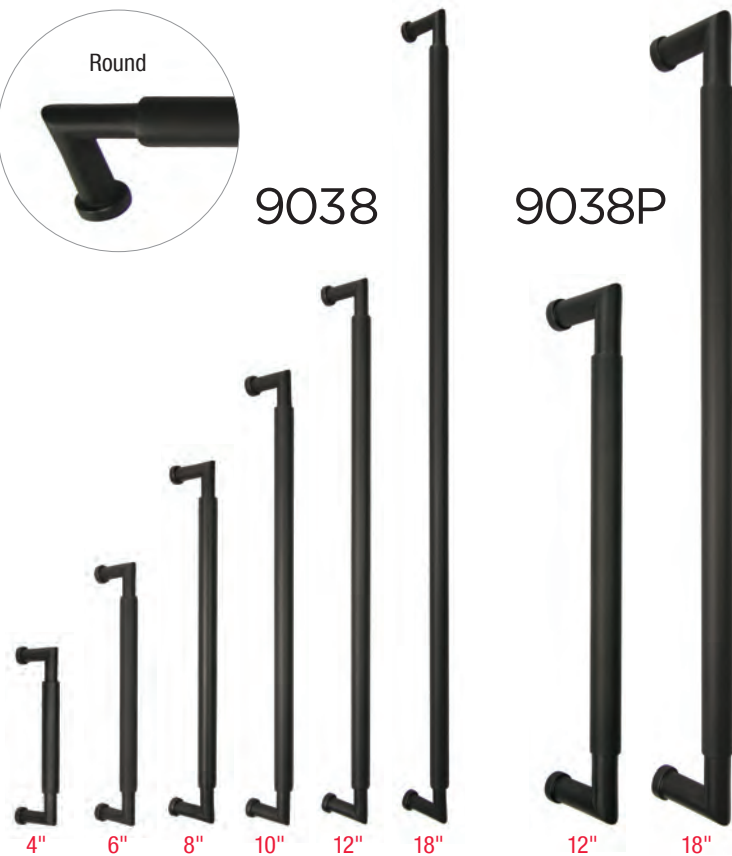

	Item#	Center to Center	Overall Length	Proj.	FINISHES					
					US3A	US4	US5	US10B	US14	US15
9038 Cabinet Pull	9038/102	4"	4 ⁷ / ₁₆ "	1 ¹ / ₈ "						\$28
	9038/153	6"	6 ⁷ / ₁₆ "							38
	9038/203	8"	8 ⁷ / ₁₆ "							50
	7 ¹ / ₁₆ " max. dia.	10"	10 ⁷ / ₁₆ "							60
		12"	12 ⁷ / ₁₆ "							72
	9038/457	18"	18 ⁷ / ₁₆ "							103
9038P Appliance Pull	9038P/305	12"	12 ³ / ₄ "	2 ¹ / ₈ "						\$234
	9038P/305B*	12"	12 ³ / ₄ "							234
	9038P/457	18"	18 ³ / ₄ "							345
	3 ³ / ₄ " max. dia.	9038P/457B*	18"	18 ³ / ₄ "						345

*In order to achieve back-to-back, order one regular pull and one B.

Suggested retail prices effective May 1, 2024.

Ultima III



9039



9039P



Item#	Center to Center	Overall Length	Proj.	FINISHES								
				US3A	US4	US5	US10B	US14	US15	US26		
9039 Cabinet Pull 1/2" w	9039/102	4"	4 7/16"	1 1/8"								
	9039/153	6"	6 7/16"									\$28
	9039/203	8"	8 7/16"									38
	9039/254	10"	10 7/16"									50
	9039/305	12"	12 7/16"									60
9039/457	18"	18 7/16"										72
9039/457	18"	18 7/16"										103
9039P Appliance Pull 1 3/16" w	9039P/305	12"	12 3/4"	2 1/8"								\$234
	9039P/305B*	12"	12 3/4"									234
	9039P/457	18"	18 3/4"									345
	9039P/457B*	18"	18 3/4"									345

*In order to achieve back-to-back, order one regular pull and one B.

Suggested retail prices effective May 1, 2024.

Ultima IV

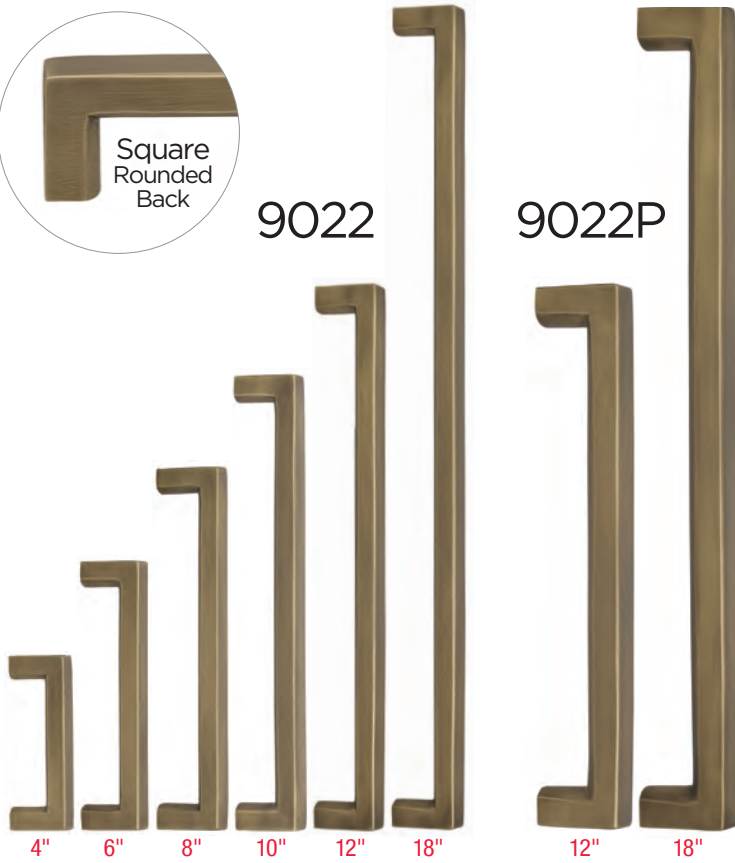

	Item#	Center to Center	Overall Length	Proj.	FINISHES		
					US3A US14 US26	US4 US15	US5 US10B
9022 Cabinet Pull 5/8" w	9022/102	4"	4 5/8"	1 1/16"	\$49	\$57	
	9022/153	6"	6 5/8"		64	73	
	9022/203	8"	8 5/8"		77	88	
	9022/254	10"	10 5/8"		97	111	
	9022/305	12"	12 5/8"		110	127	
	9022/457	18"	18 5/8"		165	189	
9022P Appliance Pull 1" w	9022P/305	12"	13"	2 1/16"	\$279	\$320	
	9022P/305B*	12"	13"		279	320	
	9022P/457	18"	19"		387	445	
	9022P/457B*	18"	19"		387	445	

*To achieve back-to-back, order one regular pull and one B.

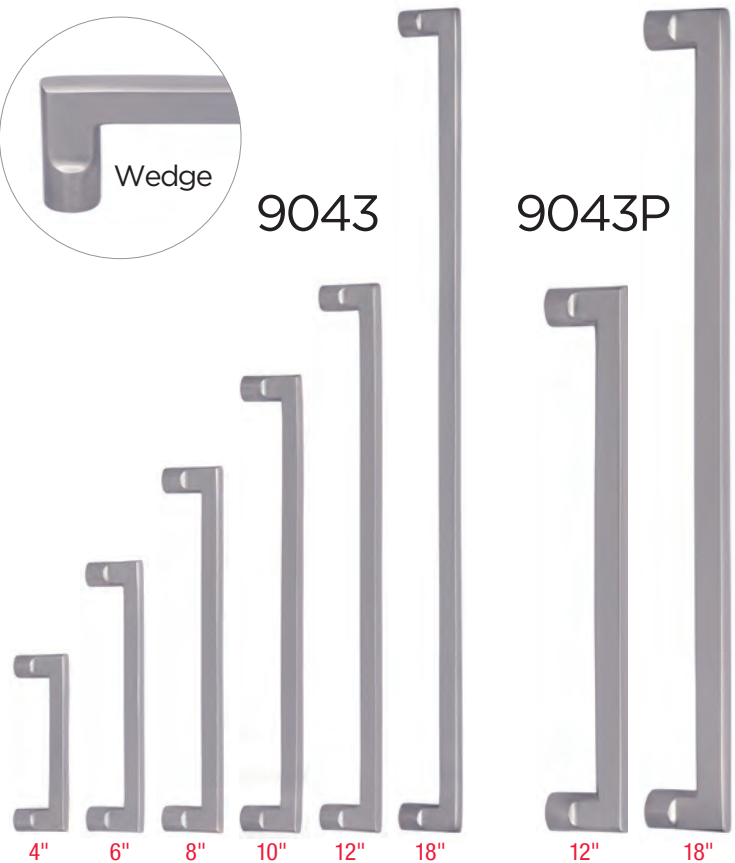

	Item#	Center to Center	Overall Length	Proj.	FINISHES		
					US3A US14 US26	US4 US15	US5 US10B
9043 Cabinet Pull 5/8" w	9043/102	4"	4 5/8"	1 3/8"	\$34	\$39	
	9043/153	6"	6 5/8"		43	49	
	9043/203	8"	8 5/8"		53	60	
	9043/254	10"	10 5/8"		61	70	
	9043/305	12"	12 5/8"		73	84	
	9043/457	18"	18 5/8"		103	119	
9043P Appliance Pull 1" w	9043P/305	12"	13"	2"	\$206	\$237	
	9043P/305B*	12"	13"		206	237	
	9043P/457	18"	19"		289	332	
	9043P/457B*	18"	19"		289	332	

*To achieve back-to-back, order one regular pull and one B.

Suggested retail prices effective May 1, 2024.

Ultima IV

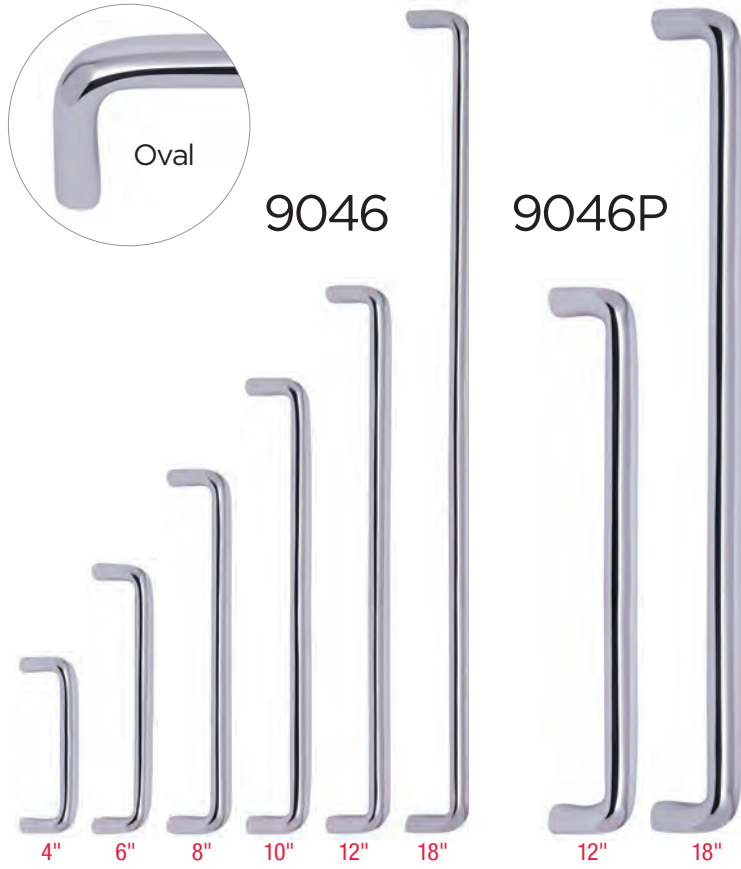

Item#	Center to Center	Overall Length	Proj.	FINISHES		
				US3A US14 US26	US4 US15	US5 US10B
9046 Cabinet Pull 5/8" w	9046/102	4"	4 1/2"	1 3/8"	\$27	\$31
	9046/153	6"	6 1/2"		36	41
	9046/203	8"	8 1/2"		46	52
	9046/254	10"	10 1/2"		57	65
	9046/305	12"	12 1/2"		64	74
	9046/457	18"	18 1/2"		97	111
9046P Appliance Pull 3/4" w	9046P/305	12"	12 3/4"	2"	\$175	\$201
	9046P/305B*	12"	12 3/4"		175	201
	9046P/457	18"	18 3/4"		243	280
	9046P/457B*	18"	18 3/4"		243	280

*To achieve back-to-back, order one regular pull and one B.

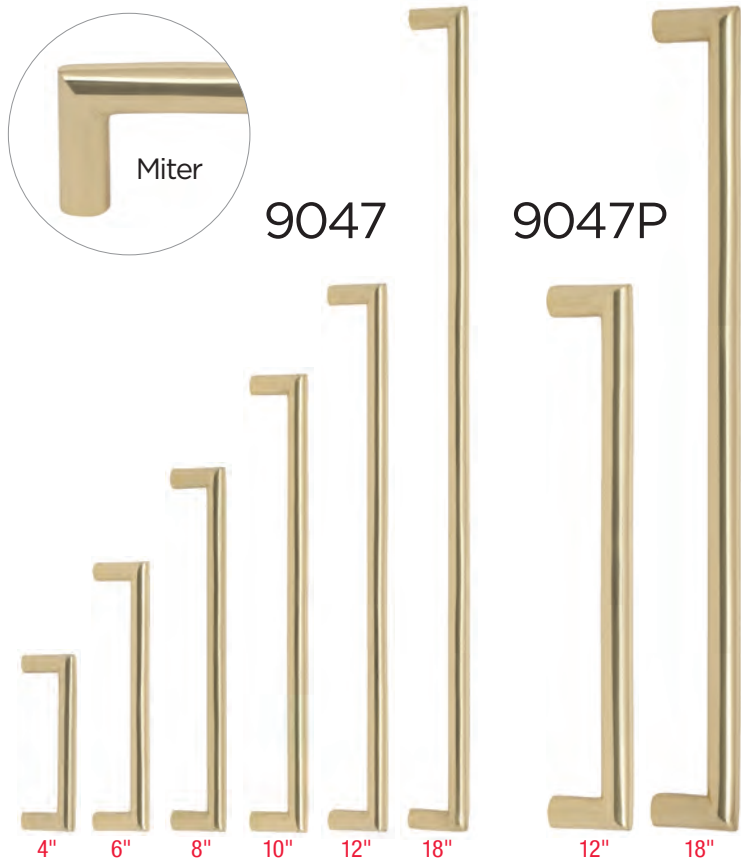

Item#	Center to Center	Overall Length	Proj.	FINISHES		
				US3A US14 US26	US4 US15	US5 US10B
9047 Cabinet Pull 1/2" w	9047/102	4"	4 1/2"	1 3/8"	\$22	\$25
	9047/153	6"	6 1/2"		30	34
	9047/203	8"	8 1/2"		37	42
	9047/254	10"	10 1/2"		44	50
	9047/305	12"	12 1/2"		51	59
	9047/457	18"	18 1/2"		74	84
9047P Appliance Pull 3/4" w	9047P/305	12"	12 3/4"	2"	\$139	\$160
	9047P/305B*	12"	12 3/4"		139	160
	9047P/457	18"	18 3/4"		194	224
	9047P/457B*	18"	18 3/4"		194	224

*To achieve back-to-back, order one regular pull and one B.

Suggested retail prices effective May 1, 2024.

Ultima IV

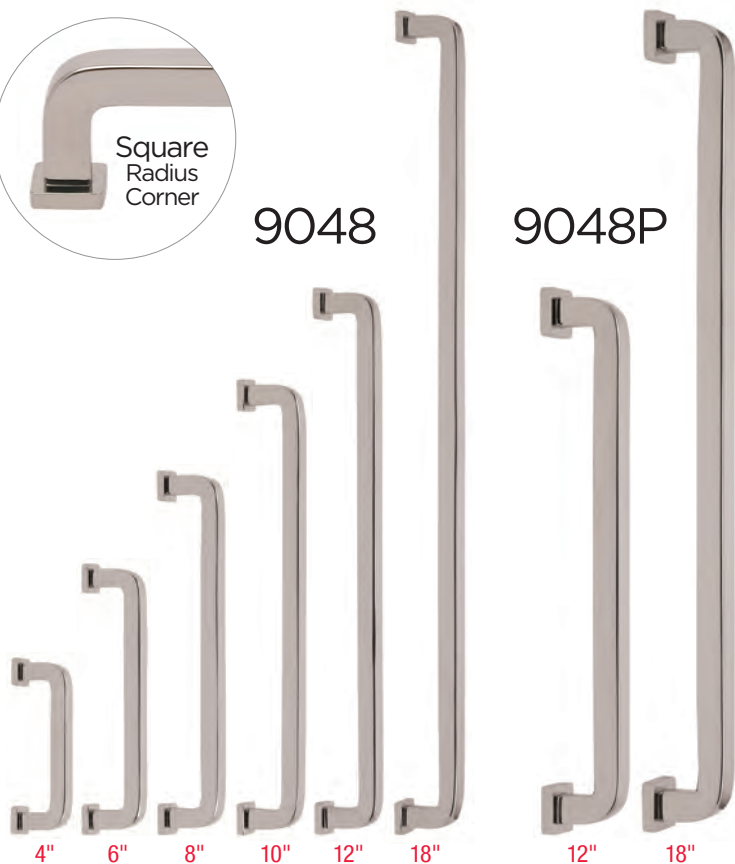

Item#	Center to Center	Overall Length	Proj.	FINISHES		
				US3A US14 US26	US4 US15	US5 US10B
9048 Cabinet Pull 3/4" w	9048/102	4"	4 3/4"	1 1/2"	\$32	\$37
	9048/153	6"	6 3/4"		41	47
	9048/203	8"	8 3/4"		51	58
	9048/254	10"	10 3/4"		62	71
	9048/305	12"	12 3/4"		72	82
9048/457	18"	18 3/4"		104	120	
9048P Appliance Pull 1 1/4" w	9048P/305	12"	13 1/8"	2"	\$165	\$189
	9048P/305B*	12"	13 1/8"		165	189
	9048P/457	18"	19 1/8"		233	268
	9048P/457B*	18"	19 1/8"		233	268

*To achieve back-to-back, order one regular pull and one B.

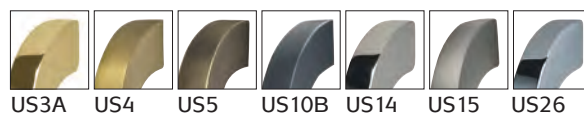
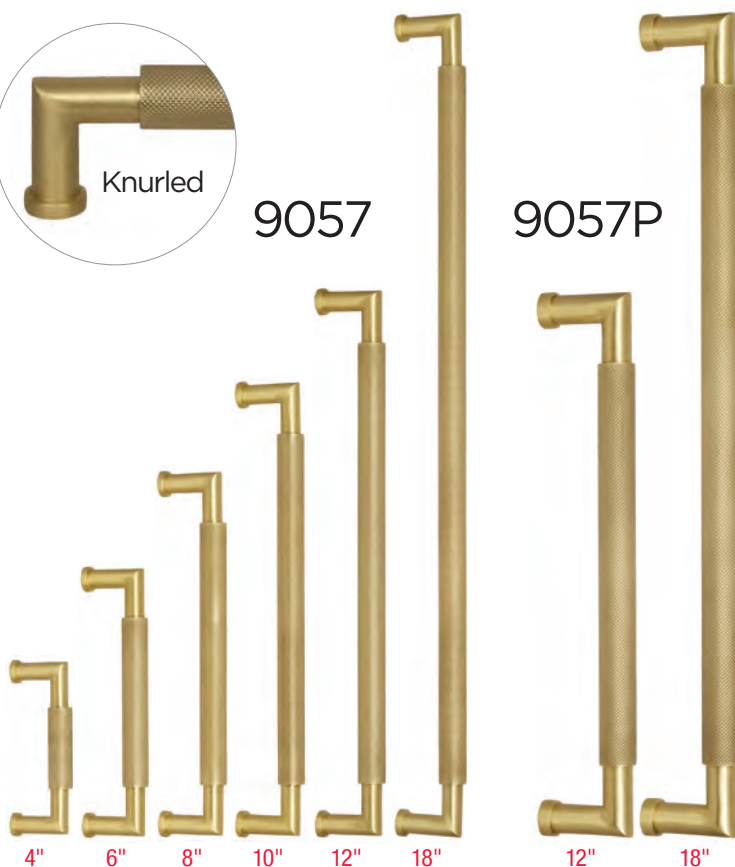

Item#	Center to Center	Overall Length	Proj.	FINISHES		
				US3A US14 US26	US4 US15	US5 US10B
9057 Cabinet Pull 5/8" w	9057/102	4"	4 5/8"	1 5/8"	\$30	\$35
	9057/153	6"	6 5/8"		43	50
	9057/203	8"	8 5/8"		60	69
	9057/254	10"	10 5/8"		74	84
	9057/305	12"	12 5/8"		88	101
9057/457	18"	18 5/8"		129	149	
9057P Appliance Pull 7/8" w	9057P/305	12"	13"	2 3/8"	\$180	\$206
	9057P/305B*	12"	13"		180	206
	9057P/457	18"	19"		258	297
	9057P/457B*	18"	19"		258	297

*To achieve back-to-back, order one regular pull and one B.

Suggested retail prices effective May 1, 2024.

Ultima IV

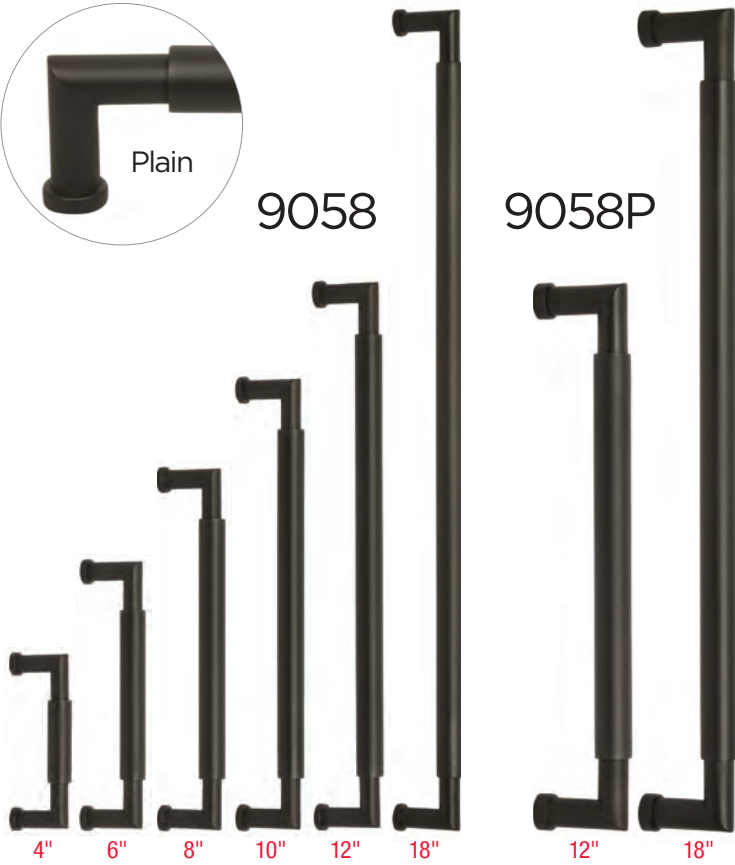

Item#	Center to Center	Overall Length	Proj.	FINISHES		
				US3A US14 US26	US4 US15	US5 US10B
9058 Cabinet Pull 5/8" w	9058/102	4"	4 5/8"	1 5/8"	\$29	\$33
	9058/153	6"	6 5/8"		42	48
	9058/203	8"	8 5/8"		57	65
	9058/254	10"	10 5/8"		70	80
	9058/305	12"	12 5/8"		84	96
	9058/457	18"	18 5/8"		123	142
9058P Appliance Pull 7/8" w	9058P/305	12"	13"	2 3/8"	\$172	\$198
	9058P/305B*	12"	13"		172	198
	9058P/457	18"	19"		249	286
	9058P/457B*	18"	19"		249	286

*To achieve back-to-back, order one regular pull and one B.

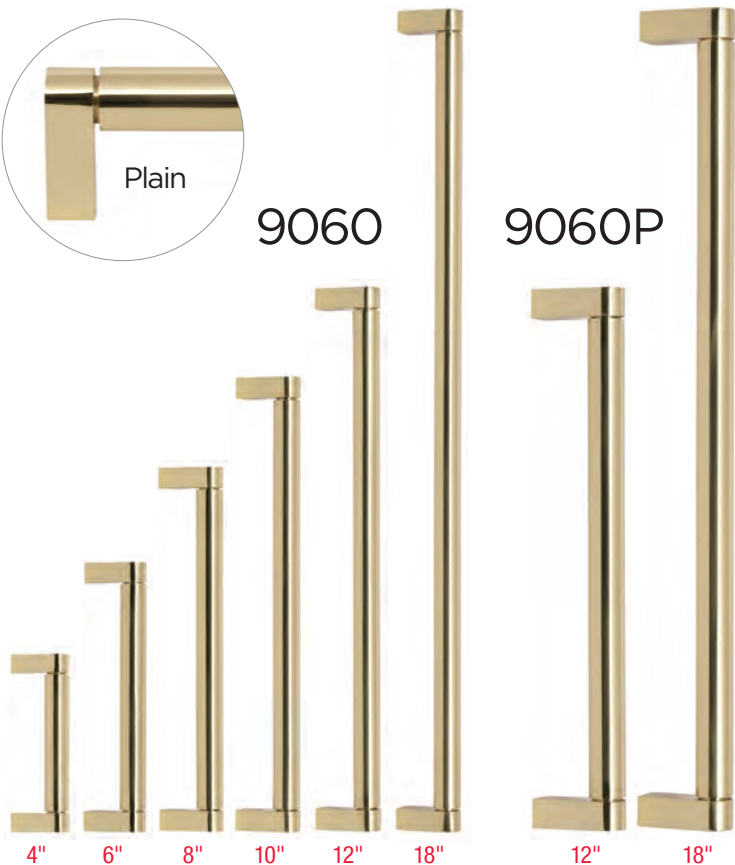

Item#	Center to Center	Overall Length	Proj.	FINISHES		
				US3A US14 US26	US4 US15	US5 US10B
9060 Cabinet Pull 5/8" w	9060/102	4"	4 1/2"	1 1/2"	\$41	\$47
	9060/153	6"	6 1/2"		55	63
	9060/203	8"	8 1/2"		68	78
	9060/254	10"	10 1/2"		82	94
	9060/305	12"	12 1/2"		95	109
	9060/457	18"	18 1/2"		135	155
9060P Appliance Pull 7/8" w	9060P/305	12"	12 3/4"	2 1/4"	\$196	\$225
	9060P/305B*	12"	12 3/4"		196	225
	9060P/457	18"	18 3/4"		273	314
	9060P/457B*	18"	18 3/4"		273	314

*To achieve back-to-back, order one regular pull and one B.

Suggested retail prices effective May 1, 2024.

Ultima IV

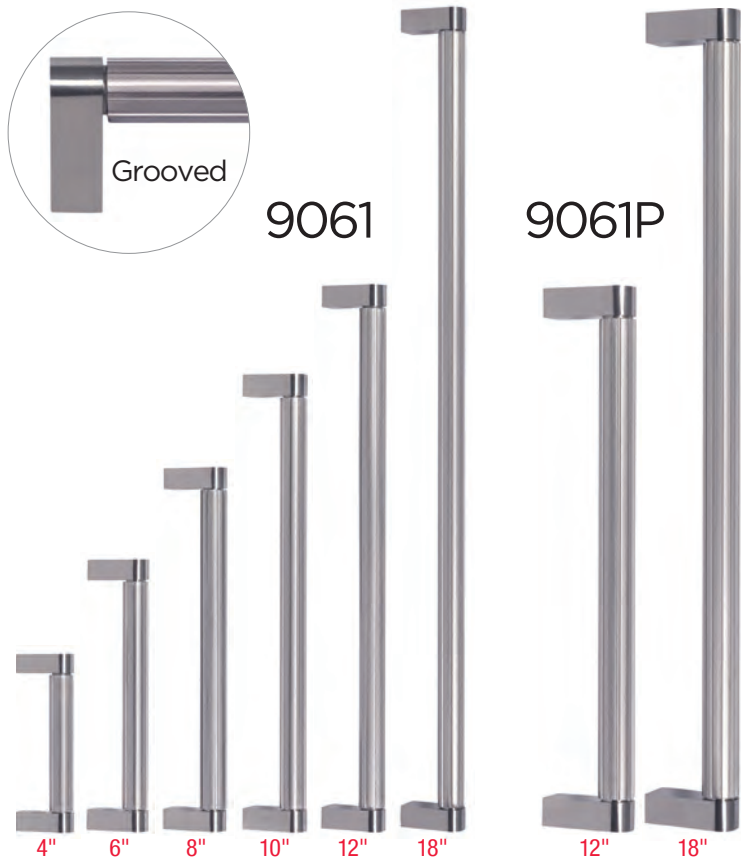

Item#	Center to Center	Overall Length	Proj.	FINISHES		
				US3A US14 US26	US4 US15	US5 US10B
9061	9061/102	4"	4 1/2"	1 1/2"	\$43	\$49
Cabinet Pull	9061/153	6"	6 1/2"		57	66
	9061/203	8"	8 1/2"		71	82
5/8" w	9061/254	10"	10 1/2"		86	98
	9061/305	12"	12 1/2"		99	114
	9061/457	18"	18 1/2"		142	163
9061P	9061P/305	12"	12 3/4"	2 1/4"	\$203	\$233
Appliance Pull	9061P/305B*	12"	12 3/4"		203	233
	9061P/457	18"	18 3/4"		283	326
7/8" w	9061P/457B*	18"	18 3/4"		283	326

*To achieve back-to-back, order one regular pull and one B.

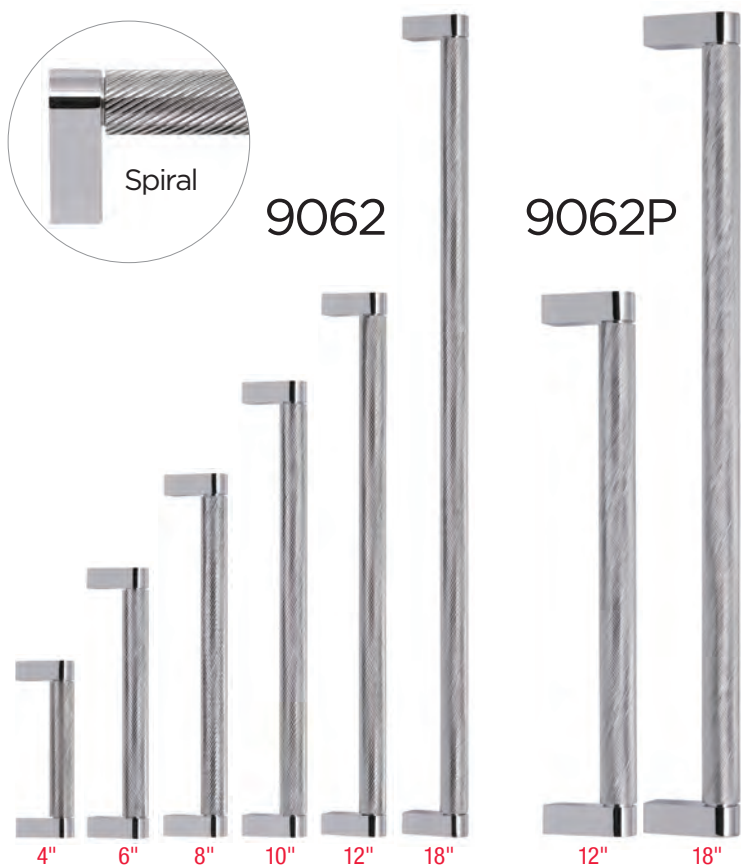

Item#	Center to Center	Overall Length	Proj.	FINISHES		
				US3A US14 US26	US4 US15	US5 US10B
9062	9062/102	4"	4 1/2"	1 1/2"	\$44	\$50
Cabinet Pull	9062/153	6"	6 1/2"		59	68
	9062/203	8"	8 1/2"		73	84
5/8" w	9062/254	10"	10 1/2"		88	102
	9062/305	12"	12 1/2"		103	118
	9062/457	18"	18 1/2"		147	169
9062P	9062P/305	12"	12 3/4"	2 1/4"	\$207	\$238
Appliance Pull	9062P/305B*	12"	12 3/4"		207	238
	9062P/457	18"	18 3/4"		290	333
7/8" w	9062P/457B*	18"	18 3/4"		290	333

*To achieve back-to-back, order one regular pull and one B.

Suggested retail prices effective May 1, 2024.

Ultima IV



More *Ultima IV* pulls and knobs to come in 2024!

Be sure to check our website regularly.

www.OMNIAindustries.com

Ultima Knobs

9004

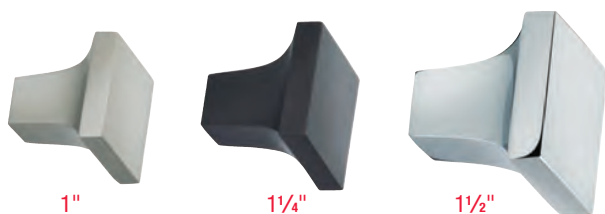

Item#	Width	Proj.	FINISHES				
			US3A US10B US15	US4 US14	US5 US15 US26	US5 US14 US26	
9004 Knob	9004/25	1" sq.	1"				\$16
	9004/32	1 1/4" sq.	1 1/4"				23
	9004/40	1 1/2" sq.	1 1/2"				34

9035

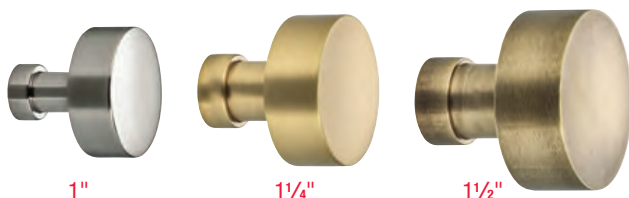

Item#	Dia.	Proj.	FINISHES				
			US3A US10B US15	US4 US14	US5 US15 US26	US5 US14 US26	
9035 Knob	9035/25	1"	1"				\$16
	9035/32	1 1/4"	1 1/4"				23
	9035/38	1 1/2"	1 1/2"				34

9036

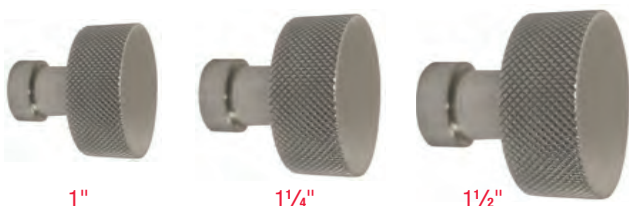

Item#	Dia.	Proj.	FINISHES				
			US3A US10B US15	US4 US14	US5 US15 US26	US5 US14 US26	
9036 Knob	9036/25	1"	1 5/16"				\$16
	9036/32	1 1/4"	1 9/16"				23
	9036/38	1 1/2"	1 1/2"				34

9164



Item#	Width of Knob	Width of Rose	Proj.	FINISHES				
				US3A US10B US15	US4 US14	US5 US15 US26	US5 US14 US26	
9164 Knob	9164/25	1"	7/8"	1"				\$16
	9164/32	1 1/4"	1"	1 1/4"				23
	9164/38	1 1/2"	1 1/4"	1 3/8"				34

9165



Rose is optional upon installation.

Item#	Dia. of Knob	Dia. of Rose	Proj.	FINISHES				
				US3 US10B US26	US3A US14	US4 US15	US5 US15 US26D	US5 US14 US26
9165 Knob	9165/25	1"	7/8"	1 5/8"				\$16
	9165/30	1 3/16"	1"	1 3/4"				23
	9165/35	1 3/8"	1"	1 7/8"				34

9151

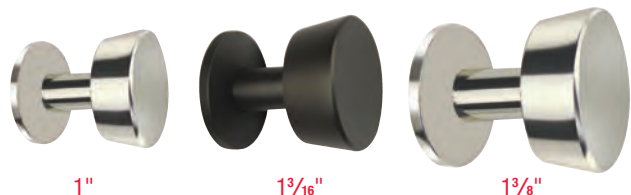

Rose is optional upon installation.

Item#	Dia. of Knob	Dia. of Rose	Proj.	FINISHES				
				US3 US10B US15	US3A US14	US4 US15	US5 US15 US26	US5 US14 US26
9151 Knob	9151/25	1"	7/8"	1"				\$12
	9151/30	1 3/16"	1 1/16"	1 1/4"				17
	9151/35	1 3/8"	1 1/16"	1 1/2"				24

9153



Item#	Dia.	Proj.	FINISHES				
			US3 US10B US26	US3A US14	US4 US15	US5 US15 US26D	US5 US14 US26
9153 Knob	9153/18	3/4"	1 5/16"				\$12
	9153/25	1"	1 1/4"				17

Suggested retail prices effective May 1, 2024.

TRADITIONS



9030



3 1/2"



5"



7"



12"



18"

	Item#	Center to Center	Overall Length	Max. Dia.	FINISHES	
					US3 US14 US15 US26	US5 US10B
9030 Cabinet Pull	9030/89	3 1/2"	4"	15/32"	\$16	\$19
	9030/128	5"	5 1/2"	17/32"	21	26
	9030/178	7"	7 5/8"	5/8"	38	45
9030 Appliance Pull	9030/305	12"	12 3/4"	7/8"	\$92	\$108
	9030/458	18"	18 7/8"	1"	197	227



9040



3 1/2"



5"



7"



12"



18"

	Item#	Center to Center	Overall Length	Max. Dia.	FINISHES	
					US3 US14 US15 US26	US5 US10B
9040 Cabinet Pull	9040/89	3 1/2"	4"	9/16"	\$16	\$19
	9040/128	5"	5 5/8"	5/8"	21	26
	9040/178	7"	7 5/8"	11/16"	38	45
9040 Appliance Pull	9040/305	12"	12 7/8"	13/16"	\$92	\$108
	9040/458	18"	19"	15/16"	197	227

Suggested retail prices effective May 1, 2024.

TRADITIONS

9045



1"



1 1/4"



1 1/2"



Item#	Dia.	Proj.	FINISHES		
			US3	US5	US10B
9045 Knob	9045/25	1"	1 1/16"	\$14	
	9045/31	1 1/4"	1 5/16"	21	
	9045/38	1 1/2"	1 1/2"	35	

Prodigy

9566

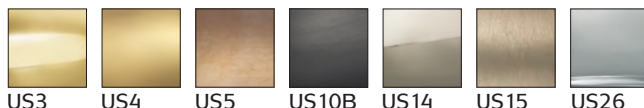

Item#	Dia.	Proj.	FINISHES		
			US3	US4	US5
9566 Knob	9566/32	1 5/16"	1 1/16"	\$29	

9936



Item#	Dia.	Proj.	FINISHES		
			US3	US4	US5
9936 Knob	9936/32	1 1/4"	1 1/16"	\$29	

9955

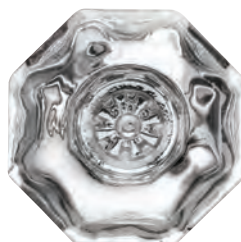

Item#	Dia.	Proj.	FINISHES		
			US3	US4	US5
9955 Knob	9955/32	1 1/4"	1 1/16"	\$29	

9956

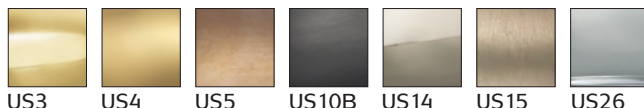

Item#	Dia.	Proj.	FINISHES		
			US3	US4	US5
9956 Knob	9956/32	1 1/16"	1 1/16"	\$29	

Suggested retail prices effective May 1, 2024.

STAINLESS STEEL

9457



	Item#	Center to Center	Overall Length	Proj.	FINISH US32D
9457	9457/96	3 3/4"	5 3/8"	1"	\$31
Cabinet Pull	9457/128	5"	6 5/8"		31
	9457/160	6 3/8"	7 7/8"		32
8 mm diameter	9457/192	7 5/8"	9 1/8"		34

9458

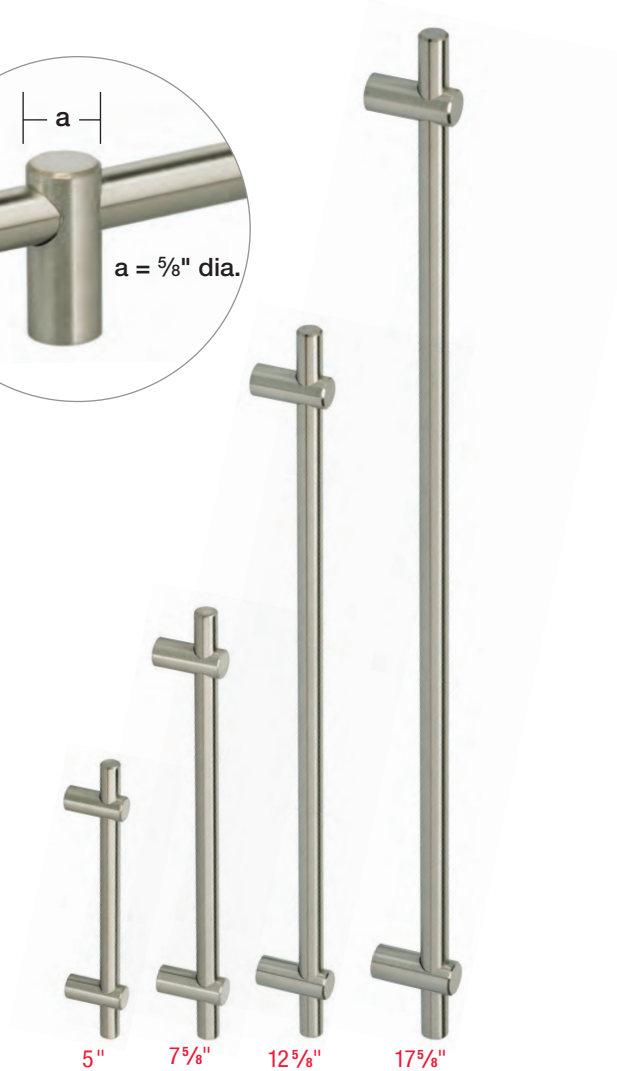
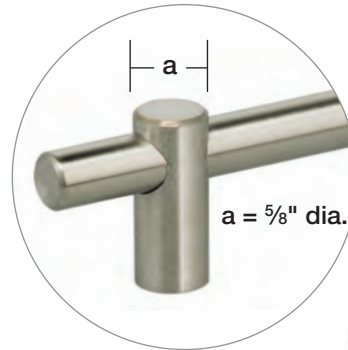

	Item#	Center to Center	Overall Length	Proj.	FINISH US32D
9458	9458/128	5"	7 1/4"	1 1/4"	\$33
Cabinet Pull	9458/192	7 5/8"	9 3/4"		41
	9458/320	12 5/8"	14 15/16"		54
12 mm diameter	9458/448	17 5/8"	20 1/8"		70

Suggested retail prices effective May 1, 2024.

STAINLESS STEEL

9464



	Item#	Center to Center	Overall Length	Proj.	FINISH US32D
9464 Cabinet Pull 10 mm diameter	9464/76	3"	4 ^{15/16} "	1 ^{3/16} "	\$14
	9464/96	3 ^{3/4} "	5 ^{3/4} "		15
	9464/128	5"	7"		18
	9464/192	7 ^{5/8} "	9 ^{1/2} "		23
	9464/320	12 ^{5/8} "	14 ^{9/16} "		33
	9464/448	17 ^{5/8} "	20 ^{1/2} "		47
	9464/640	25 ^{3/16} "	28 ^{3/8} "		85

9465



	Item#	Center to Center	Overall Length	Proj.	FINISH US32D
9465 Cabinet Pull 14 mm diameter	9465/96	3 ^{3/4} "	5 ^{3/4} "	1 ^{3/8} "	\$32
	9465/128	5"	7"		37
	9465/192	7 ^{5/8} "	9 ^{1/2} "		46
	9465/320	12 ^{5/8} "	14 ^{9/16} "		58
	9465/448	17 ^{5/8} "	20 ^{1/2} "		70
	9465/640	25 ^{3/16} "	28 ^{3/8} "		83
	9465/736	29"	32 ^{1/4} "		98

Suggested retail prices effective May 1, 2024.

STAINLESS STEEL

9450

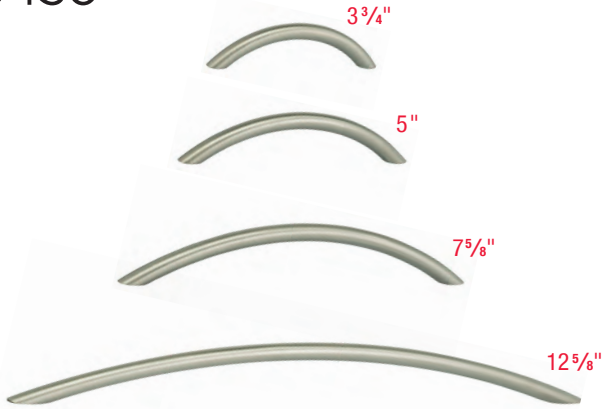

	Item#	Center to Center	Overall Length	Proj.	FINISH US32D
9450 Cabinet Pull 10 mm diameter	9450/96	3 ³ / ₄ "	4 ⁵ / ₈ "	1 ¹ / ₈ "	\$14
	9450/128	5"	5 ⁷ / ₈ "	1 ³ / ₁₆ "	15
	9450/192	7 ⁵ / ₈ "	8 ³ / ₄ "	1 ³ / ₈ "	21
	9450/320	12 ⁵ / ₈ "	14 ⁹ / ₁₆ "		43

9533

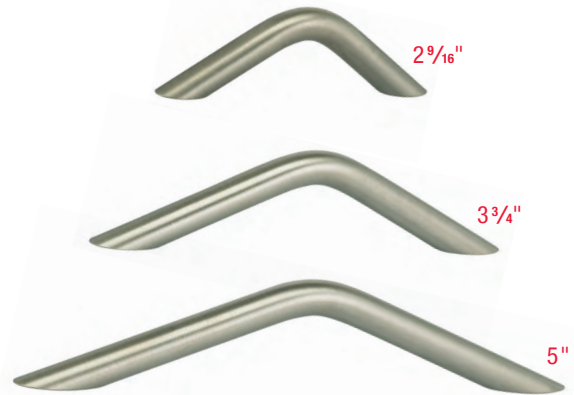

	Item#	Center to Center	Overall Length	Proj.	FINISH US32D
9533 Cabinet Pull 10 mm diameter	9533/64	2 ⁹ / ₁₆ "	3 ⁵ / ₈ "	1 ¹ / ₈ "	\$13
	9533/96	3 ³ / ₄ "	5 ³ / ₁₆ "	1 ³ / ₁₆ "	14
	9533/128	5"	6 ³ / ₄ "	1 ¹ / ₄ "	15

9537



	Item#	Center to Center	Overall Length	Proj.	FINISH US32D
9537 Cabinet Pull 8 mm diameter	9537/76	3"	3 ³ / ₈ "	1 ³ / ₁₆ "	\$12
	9537/102	4"	4 ³ / ₈ "		13
	9537/128	5"	5 ³ / ₈ "		14

9538



	Item#	Center to Center	Overall Length	Proj.	FINISH US32D
9538 Cabinet Pull 10 mm diameter	9538/76	3"	3 ⁷ / ₁₆ "	1 ³ / ₈ "	\$13
	9538/102	4"	4 ⁷ / ₁₆ "		14
	9538/128	5"	5 ¹ / ₂ "		15

Suggested retail prices effective May 1, 2024.

STAINLESS STEEL

9100



1"



1³/₁₆"

	Item#	Dia.	Proj.	FINISH US32D
9100 Knob	9100/25	1"	7/8"	\$11
	9100/30	1 ³ / ₁₆ "	1 ¹ / ₈ "	15

9153



3/4"



1³/₁₆"

	Item#	Dia.	Proj.	FINISH US32D
9153 Knob	9153/18	3/4"	1"	\$11
	9153/21	1 ³ / ₁₆ "	1 ¹ / ₈ "	15

9180



1"



1³/₁₆"

	Item#	Dia.	Proj.	FINISH US32D
9180 Knob	9180/25	1"	1 ¹ / ₈ "	\$15
	9180/30	1 ³ / ₁₆ "	1 ¹ / ₄ "	23

9181



3/4"



1⁵/₁₆"

	Item#	Dia.	Proj.	FINISH US32D
9181 Knob	9181/20	3/4"	1"	\$11
	9181/24	1 ⁵ / ₁₆ "	1 ³ / ₁₆ "	15

Suggested retail prices effective May 1, 2024.

Legacy

9100
Knob



Item#	Dia.	Proj.	FINISHES			
			US3 US26	US10B US26D	US14 VB	US15 VC VI
9100/31	1 7/32"	1 1/8"	\$16			

9102
Knob



Item#	Dia.	Proj.	FINISHES			
			US3 US26	US10B VB	US14 VC	US15 VI
9102/30	1 3/16"	1 1/8"	\$18			

9105
Knob



Item#	Dia.	Proj.	FINISHES			
			US3 US26	US10B US26D	US14 VB	US15 VC VI
9105/35	1 3/8"	1 1/2"	\$16			

9130
Knob



Item#	Dia.	Proj.	FINISHES			
			US3	US14	US15	SB
9130/30	1 3/16"	1 1/16"	\$14			

9141
Knob



Item#	Dia.	Proj.	FINISHES			
			US3 US26	US10B SB	US14 VB	US15 VC VI
9141/30	1 3/16"	1"	\$18			

9158
Knob



Item#	Dia.	Proj.	FINISHES			
			US3 US15	US10B US26	US14	
9158/30	1 3/16"	1 5/32"	\$18			

9430
Knob



Item#	Dia.	Proj.	FINISHES			
			US3 US26	US10B SB	US14 VB	US15 VC VI
9430/32	1 1/4"	1 1/4"	\$18			

Suggested retail prices effective May 1, 2024.

Suggested retail prices effective May 1, 2024.

Ornate

7105



	Item#	Dia.	Proj.	FINISHES		
				US3	US15A	SB
7105 Knob	7105/30	1 3/16"	1"		\$41	
	7105/40	1 9/16"	1 3/16"		58	

7417

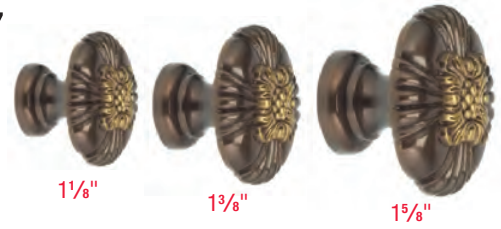

	Item#	Dia.	Proj.	FINISHES		
				US3	US15A	SB
7417 Knob	7417/28	1 1/8"	1"		\$44	
	7417/33	1 3/8"	1 1/8"		42	
	7417/42	1 5/8"	1 3/16"		60	

7420

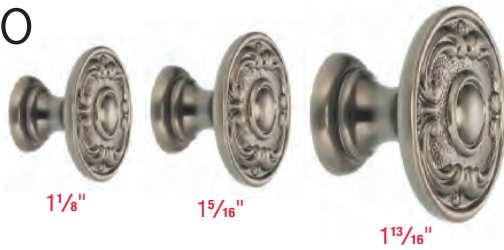

	Item#	Dia.	Proj.	FINISHES		
				US3	US15A	SB
7420 Knob	7420/28	1 1/8"	1 3/16"		\$39	
	7420/33	1 5/16"	1"		42	
	7420/46	1 13/16"	1 3/16"		58	

7430



	Item#	Dia.	Proj.	FINISHES		
				US3	US15A	SB
7430 Knob	7430/30	1 3/16"	1 1/8"		\$41	
	7430/38	1 1/2"	1 1/8"		56	
	7430/47	1 7/8"	1 1/8"		70	

7432



	Item#	Dia.	Proj.	FINISHES		
				US3	US14	US15A SB
7432 Pull	7432/76	3"	1 3/8"		\$53	
	7432/89	3 1/2"	1 9/16"		61	

7434



	Item#	Dia.	Proj.	FINISHES		
				US3	US15A	SB
7434 Knob	7434/28	1 1/8"	1"		\$38	
	7434/35	1 3/8"	1 3/16"		50	
	7434/42	1 5/8"	1 1/4"		60	

7435



	Item#	Dia.	Proj.	FINISHES		
				US3	US15A	SB
7435 Knob	7435/25	1"	1 3/16"		\$31	
	7435/30	1 3/16"	1"		40	
	7435/40	1 9/16"	1 3/16"		50	

7436



	Item#	Dia.	Proj.	FINISHES		
				US3	US14	US15A SB
7436 Knob	7436/25	1"	1 3/16"		\$31	
	7436/30	1 3/16"	1"		40	
	7436/40	1 9/16"	1 3/16"		55	

STAINLESS STEEL



	Item#	Center to Center	Overall Length	Proj.	FINISH US32D
720	720/220	8 ⁵ / ₈ "	15"	2 ³ / ₄ "	\$227
721	721/400	15 ³ / ₄ "	17 ⁵ / ₁₆ "	2 ⁹ / ₁₆ "	\$189
	721/800	31 ¹ / ₂ "	33"	2 ⁹ / ₁₆ "	317
722	722/400	15 ³ / ₄ "	17 ⁵ / ₁₆ "	2 ⁹ / ₁₆ "	\$153
4010	4010/300	8"	9"	2 ⁵ / ₈ "	\$168
	4010/B300	8"	9"	2 ⁵ / ₈ "	356
	4010/400	12"	13 ¹ / ₄ "	2 ¹⁵ / ₁₆ "	222
	4010/B400	12"	13 ¹ / ₄ "	2 ¹⁵ / ₁₆ "	462
	4010/500	16"	17 ¹ / ₂ "	3 ³ / ₈ "	288
4010/B500	16"	17 ¹ / ₂ "	3 ³ / ₈ "	593	
4019	4019/300	8"	9"	2 ⁵ / ₈ "	\$229
	4019/B300	8"	9"	2 ⁵ / ₈ "	478
	4019/400	12"	13 ¹ / ₄ "	2 ¹⁵ / ₁₆ "	283
	4019/B400	12"	13 ¹ / ₄ "	2 ¹⁵ / ₁₆ "	585
	4019/500	16"	17 ¹ / ₂ "	3 ³ / ₈ "	347
4019/B500	16"	17 ¹ / ₂ "	3 ³ / ₈ "	713	
8190	8190/300	11 ¹³ / ₁₆ "	15 ³ / ₄ "	3 ⁹ / ₁₆ "	\$344
	8190/B300	11 ¹³ / ₁₆ "	15 ³ / ₄ "	3 ⁹ / ₁₆ "	719
	8190/400	15 ³ / ₄ "	23 ⁵ / ₈ "	3 ⁹ / ₁₆ "	365
	8190/B400	15 ³ / ₄ "	23 ⁵ / ₈ "	3 ⁹ / ₁₆ "	756

For full Stainless Steel line, please see pages 24–27.
All pulls are available back-to-back.

ELITE



Item#	Center to Center	Overall Length	Proj.	FINISHES	
				US4 US14 US26	US5 US10B US15
1968P 19 ¹ / ₃₂ " W	1968P/305	12"	12 ¹⁵ / ₁₆ "	1 ³ / ₁₆ "	\$203 \$215
	1968P/305BB*	12"	12 ¹⁵ / ₁₆ "	1 ³ / ₁₆ "	203 215
	1968P/457	18"	18 ¹⁵ / ₁₆ "	1 ³ / ₁₆ "	261 272
	1968P/457BB*	18"	18 ¹⁵ / ₁₆ "	1 ³ / ₁₆ "	261 272
1969P 19 ¹ / ₃₂ " W	1969P/305	12"	13 ¹ / ₈ "	1 ³ / ₄ "	\$220 \$229
	1969P/305BB*	12"	13 ¹ / ₈ "	1 ³ / ₄ "	220 229
	1969P/457	18"	19 ¹ / ₈ "	1 ³ / ₄ "	272 278
	1969P/457BB*	18"	19 ¹ / ₈ "	1 ³ / ₄ "	272 278
1970P 13 ¹ / ₁₆ " W	1970P/305	12"	14 ³ / ₄ "	1 ³ / ₄ "	\$220 \$229
	1970P/305BB*	12"	14 ³ / ₄ "	1 ³ / ₄ "	220 229
	1970P/457	18"	20 ³ / ₄ "	1 ³ / ₄ "	272 278
	1970P/457BB*	18"	20 ³ / ₄ "	1 ³ / ₄ "	272 278
1971P 13 ¹ / ₁₆ " W	1971P/305	12"	12 ¹¹ / ₁₆ "	1 ³ / ₄ "	\$203 \$215
	1971P/305BB*	12"	12 ¹¹ / ₁₆ "	1 ³ / ₄ "	203 215
	1971P/457	18"	18 ⁹ / ₁₆ "	1 ³ / ₄ "	261 272
	1971P/457BB*	18"	18 ⁹ / ₁₆ "	1 ³ / ₄ "	261 272

*In order to achieve back-to-back, order one regular pull and one BB.

For full Elite line, please see pages 4–5.

Suggested retail prices effective May 1, 2024.

TRADITIONS

9030

9040



Item#	Center to Center	Overall Length	Proj.	FINISHES		
				US3 US14 US15 US26	US5 US10B	
9030	9030/305	12"	12 ³ / ₄ "	7 ⁷ / ₈ "	\$92	\$108
	9030/458	18"	18 ⁷ / ₈ "	1"	197	227
9040	9040/305	12"	12 ⁷ / ₈ "	13 ¹ / ₁₆ "	\$92	\$108
	9040/458	18"	19"	1 ⁵ / ₁₆ "	197	227

For full Traditions line, please see pages 22–23.

Ultima I

9006P

9007P

9009P

9013P



Item#	Center to Center	Overall Length	Proj.	FINISHES		NON-STOCK*	
				US15 US10B US26	US3 US3A US4 US5 US14		
9006P 1" w	9006P/440	17 ⁵ / ₁₆ "	17 ¹⁵ / ₁₆ "	2"	\$227	\$284	
	9006P/440B**	17 ⁵ / ₁₆ "	17 ¹⁵ / ₁₆ "	2"	227	284	
9007P 5/8" w	9007P/400†	17 ⁵ / ₁₆ "	17 ¹⁵ / ₁₆ "	2"	\$170	\$213	
9009P 7/8" w at widest point	9009P/415	16 ⁵ / ₁₆ "	18"	2 ⁵ / ₈ "	\$297	\$372	
	9009P/415B**	16 ⁵ / ₁₆ "	18"	2 ⁵ / ₈ "	297	372	
9013P 3/4" w (not square)	9013P/415	16 ⁵ / ₁₆ "	17 ¹⁵ / ₁₆ "	1 ⁷ / ₈ "	\$183	\$229	
	9013P/415B**	16 ⁵ / ₁₆ "	17 ¹⁵ / ₁₆ "	1 ⁷ / ₈ "	183	229	

*Non-stock finishes require a 12-week lead time and a minimum order of \$1,000.00 list.

**In order to achieve back-to-back, order one regular pull and one B.

†Not available back-to-back.

For full Ultima I line, please see pages 6–8.

Suggested retail prices effective May 1, 2024.

Ultima II

9010P 9023P 9024P 9025P 9027P 9028P



Item#	Center to Center	Overall Length	Proj.	FINISHES		
				US4 US14 US15 US26	US5 US10B	
9010P 3/4" w	9010P/305	12"	14"	2 5/16"	\$177	\$203
	9010P/305B*	12"	14"	2 5/16"	177	203
	9010P/457	18"	20"	2 5/16"	248	285
	9010P/457B*	18"	20"	2 5/16"	248	285
9023P 5/8" w	9023P/305	12"	12 3/4"	2 3/16"	\$172	\$197
	9023P/305B*	12"	12 3/4"	2 3/16"	172	197
	9023P/457	18"	18 3/4"	2 3/16"	238	273
	9023P/457B*	18"	18 3/4"	2 3/16"	238	273
9024P 1" w	9024P/305	12"	13"	2"	\$154	\$177
	9024P/305B*	12"	13"	2"	154	177
	9024P/457	18"	19"	2"	206	237
	9024P/457B*	18"	19"	2"	206	237
9025P 3/4" w	9025P/305	12"	12 3/4"	2"	\$176	\$202
	9025P/305B*	12"	12 3/4"	2"	176	202
	9025P/457	18"	18 3/4"	2"	246	283
	9025P/457B*	18"	18 3/4"	2"	246	283
9027P 3/4" w	9027P/305	12"	12 3/4"	2"	\$139	\$160
	9027P/305B*	12"	12 3/4"	2"	139	160
	9027P/457	18"	18 3/4"	2"	194	224
	9027P/457B*	18"	18 3/4"	2"	194	224
9028P 3/4" w	9028P/305	12"	13"	2"	\$146	\$168
	9028P/305B*	12"	13"	2"	146	168
	9028P/457	18"	19"	2"	194	224
	9028P/457B*	18"	19"	2"	194	224

*In order to achieve back-to-back, order one regular pull and one B.

For full Ultima II line, please see pages 9–11.

Ultima III

9029P 9031P 9037P 9038P 9039P



Item#	Center to Center	Overall Length	Proj.	FINISHES	
				US3A US5 US14 US15 US26	US4 US10B
9029P 3/4" w	9029P/305	12"	12 3/4"	2 3/16"	\$234
	9029P/305B*	12"	12 3/4"	2 3/16"	234
	9029P/457	18"	18 3/4"	2 3/16"	345
	9029P/457B*	18"	18 3/4"	2 3/16"	345
9031P 3/4" w	9031P/305	12"	12 3/4"	2 3/16"	\$249
	9031P/305B*	12"	12 3/4"	2 3/16"	249
	9031P/457	18"	18 3/4"	2 3/16"	370
	9031P/457B*	18"	18 3/4"	2 3/16"	370
9037P 7/16" max. dia.	9037P/305	12"	12 3/4"	2 1/8"	\$234
	9037P/305B*	12"	12 3/4"	2 1/8"	234
	9037P/457	18"	18 3/4"	2 1/8"	345
	9037P/457B*	18"	18 3/4"	2 1/8"	345
9038P 3/4" max. dia.	9038P/305	12"	12 3/4"	2 1/8"	\$234
	9038P/305B*	12"	12 3/4"	2 1/8"	234
	9038P/457	18"	18 3/4"	2 1/8"	345
	9038P/457B*	18"	18 3/4"	2 1/8"	345
9039P 13/16" w	9039P/305	12"	12 3/4"	2 1/8"	\$234
	9039P/305B*	12"	12 3/4"	2 1/8"	234
	9039P/457	18"	18 3/4"	2 1/8"	345
	9039P/457B*	18"	18 3/4"	2 1/8"	345

*In order to achieve back-to-back, order one regular pull and one B.

For full Ultima III line, please see pages 12–14.

Suggested retail prices effective May 1, 2024.

Ultima IV

9022P 9043P 9046P 9047P 9048P 9057P 9058P 9060P 9061P 9062P



Item#	Center to Center	Overall Length	Proj.	FINISHES		
				US3A US4 US14 US15 US26	US5 US10B	
9022P 1" W	9022P/305	12"	13"	2 1/16"	\$279	\$320
	9022P/305B*	12"	13"	2 1/16"	279	320
	9022P/457	18"	19"	2 1/16"	387	445
	9022P/457B*	18"	19"	2 1/16"	387	445
9043P 1" W	9043P/305	12"	13"	2"	\$206	\$237
	9043P/305B*	12"	13"	2"	206	237
	9043P/457	18"	19"	2"	289	332
	9043P/457B*	18"	19"	2"	289	332
9046P 3/4" W	9046P/305	12"	12 3/4"	2"	\$175	\$201
	9046P/305B*	12"	12 3/4"	2"	175	201
	9046P/457	18"	18 3/4"	2"	243	280
	9046P/457B*	18"	18 3/4"	2"	243	280
9047P 3/4" W	9047P/305	12"	12 3/4"	2"	\$139	\$160
	9047P/305B*	12"	12 3/4"	2"	139	160
	9047P/457	18"	18 3/4"	2"	194	224
	9047P/457B*	18"	18 3/4"	2"	194	224
9048P 1 1/4" W	9048P/305	12"	13 1/8"	2"	\$165	\$189
	9048P/305B*	12"	13 1/8"	2"	165	189
	9048P/457	18"	19 1/8"	2"	233	268
	9048P/457B*	18"	19 1/8"	2"	233	268

*In order to achieve back-to-back, order one regular pull and one B.

Item#	Center to Center	Overall Length	Proj.	FINISHES		
				US3A US4 US14 US15 US26	US5 US10B	
9057P 7/8" W	9057P/305	12"	13"	2 3/8"	\$180	\$206
	9057P/305B*	12"	13"	2 3/8"	180	206
	9057P/457	18"	19"	2 3/8"	258	297
	9057P/457B*	18"	19"	2 3/8"	258	297
9058P 7/8" W	9058P/305	12"	13"	2 3/8"	\$172	\$198
	9058P/305B*	12"	13"	2 3/8"	172	198
	9058P/457	18"	19"	2 3/8"	249	286
	9058P/457B*	18"	19"	2 3/8"	249	286
9060P 7/8" W	9060P/305	12"	12 3/4"	2 1/4"	\$196	\$225
	9060P/305B*	12"	12 3/4"	2 1/4"	196	225
	9060P/457	18"	18 3/4"	2 1/4"	273	314
	9060P/457B*	18"	18 3/4"	2 1/4"	273	314
9061P 7/8" W	9061P/305	12"	12 3/4"	2 1/4"	\$203	\$233
	9061P/305B*	12"	12 3/4"	2 1/4"	203	233
	9061P/457	18"	18 3/4"	2 1/4"	283	326
	9061P/457B*	18"	18 3/4"	2 1/4"	283	326
9062P 7/8" W	9062P/305	12"	12 3/4"	2 1/4"	\$207	\$238
	9062P/305B*	12"	12 3/4"	2 1/4"	207	238
	9062P/457	18"	18 3/4"	2 1/4"	290	333
	9062P/457B*	18"	18 3/4"	2 1/4"	290	333

*In order to achieve back-to-back, order one regular pull and one B.

For full Ultima IV line, please see pages 15–20.

Suggested retail prices effective May 1, 2024.

Flushcups • Solid Brass & Stainless Steel

652



L x W x D	FINISHES			
	US3	US10B	US26	US15 US26D
4 3/8" x 1 9/16" x 1/2"	\$41	\$46	\$42	

653



L x W x D	FINISHES			
	US3	US10B	US15	US26 US26D
4" x 1 3/4" x 1/2"	\$39	\$52	\$45	\$40

654



L x W x D	FINISHES		
	US3	US14	US26
	US15	SB	
4" x 1 3/4" x 1/2"	\$41	\$47	\$42

4297



L x W x D	FINISHES	
	US3	SB
5 3/8" x 1 9/16" x 1/2"	\$91	\$95

7500/65



Dia.	Depth	FINISH
		US32D
2 9/16"	5/8"	\$23

7501/51



Dia.	Depth	FINISH
		US32D
2"	5/8"	\$21

7502/35



Dia.	Depth	FINISH
		US32D
1 3/8"	1/2"	\$28

7503/52



Dia.	D	FINISHES		
		US3	SB	US32D
		US10B	US14	
		US15	US26	
2 3/16"	3/8"	\$51		\$16

7504/52



Dia.	Depth	FINISHES	
		US3	US32D
		US10B	
		US14	
		US15	
		US26	
		SB	
2 3/16"	3/8"	\$51	\$16

7505/120



L x W x D	FINISH
	US32D
4 3/4" x 1 9/16" x 1/2"	\$21

7506/100



L x W x D	FINISH
	US32D
4" x 2" x 1/2"	\$21

7507



Dia.	Depth	FINISH
		US32D
3 9/16"	1 3/16"	\$28

Suggested retail prices effective May 1, 2024.

Pocket Door Flushcups • Solid Brass & Stainless Steel

7012



L x W x D
5" x 2 1/4" x 1/2"
Proj. 3/32"
US32D **\$79**

7035



L x W x D
7" x 2 9/32" x 3/8"
Proj. 3/32"
ALL FINISHES **\$103**

7036



L x W x D
4 1/2" x 2 9/32" x 3/8"
Proj. 3/32"
ALL FINISHES **\$79**

7037



L x W x D
7" x 2 9/32" x 7/16"
Proj. 1/8"
ALL FINISHES **\$103**

7039



L x W x D
7" x 2 9/32" x 7/16"
Proj. 1/8"
ALL FINISHES **\$103**



US32D



US3



US3A



US4



US5



US10B



US14



US15



US26



US26D

Drop Rings & Flushcup • Solid Brass

9580



Item#	Dia.	Depth	FINISHES		
			US3	US4	SB
9580/50	2"	3/8"	\$24	\$28	

9588



Item#	L x W x D	FINISHES		
		US3	US4	SB
9588/60	2 3/8" x 1 7/8" x 3/8"	\$23	\$28	

9595

D/O - Discontinued when out of stock.



Item#	Dia.	Depth	FINISHES		
			US3	US4	SB
9595/50	2"	1/2"	\$19	\$21	\$19
9595/60	2 3/8"	9/16"	23	28	24

Suggested retail prices effective May 1, 2024.

Door Stops • Solid Brass & Stainless Steel

1147



Proj.	FINISHES			
	US3 US26	US15 US26D	US10B SB	
3"				\$18

1148



Proj.	FINISHES			
	US3 US26	US15 US26D	US10B SB	
3¾"				\$20

2001



D/O - Discontinued when out of stock.

Throw	Overall Length	Max. Width	FINISHES	
			US3	
2"	7 1/16"	1 1/8"	\$48	

Plunger Door Holder

Operates by stepping on plunger, which is fitted with a white rubber tip. Hold door firmly in any position. Releases by stepping on trigger plate.

7001



Dia.	Ht.	FINISHES			
		US3 US10B US15 US26D	US4 US14 US26 SB	US32D	PVD
7/8"	1 3/16"	\$29		\$19	\$28

7602/35



Dia.	Ht.	FINISH
1"	1 1/16"	US32D \$41

7605/87



Dia.	Proj.	FINISH
1"	3/4"	US32D \$61

7610



Item#	Dia.	Ht.	FINISH
7610/35	1"	1 3/8"	US32D \$21
7610/51	1"	2"	\$33

7000



Item#	Dia.	Ht.	FINISHES			
			US3 US26 US26D	US4 US14 US15 SB	US32D	PVD
7000	1 1/16"	1 1/16"	\$39	\$45	\$29	\$42
7000/55	1 1/16"	2 3/16"	N/A	N/A	39	N/A

7620/35



Sq.	Ht.	FINISH
1"	1 3/8"	US32D \$51

Ball Catch • Solid Brass

1600F



Faceplate: 2 1/8" L x 1" W
Strike Plate: 2 1/8" L x 1 3/8" W
Barrel: 3/4" Dia. x 1 1/4 L

Item#	FINISHES			
	US3 US15	US4 US26	US10B US26D	US14 SB
1600F* Ball Catch	1600F			\$31

*Ball projection is adjustable.

Suggested retail prices effective May 1, 2024.

Latch & Decorative Hooks • Solid Brass

156



Not Handed

	Height	Lever Width	FINISHES	
			US3	US26
156 Shutter Latch / Bi-fold Door Latch	2"	2 ³ / ₈ "		\$26

210



	Height	Proj.	FINISHES	
			US3	US26
210 Double Hook	3"	3"		\$26

212



	Height	Proj.	FINISHES	
			US3	US26
212 Hook	1 ⁵ / ₈ "	1 ⁵ / ₁₆ "		\$15

213



	Height	Proj.	FINISHES	
			US3	US26
213 Double Hook	1 ¹ / ₂ "	³ / ₄ "		\$15

215



D/O - Discontinued when out of stock.

	Base	Proj.	FINISH
			US3
215 Triple Swivel Hook	3 ¹ / ₂ " x 1 ³ / ₄ "	4 ⁵ / ₁₆ "	\$141

Suggested retail prices effective May 1, 2024.

Switchplates • Solid Brass

8004



8004/S SINGLE



8004/D DOUBLE

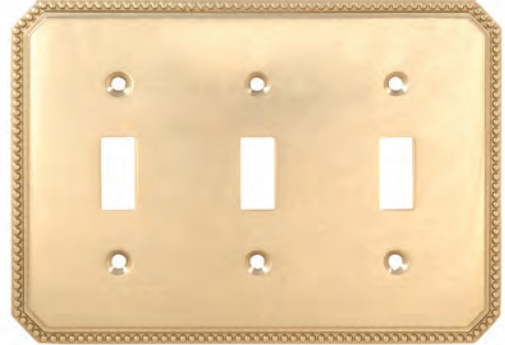

8004/T TRIPLE

D/O - Discontinued when out of stock.



8004/R DUPLEX RECEPTACLE



8004/C COMBINATION

Item#	FINISHES		
	US3	US15	US26 SB
8004			
Beaded Design 8004/S	\$29	\$34	\$32
8004/D	42	47	46
8004/T*	52	58	54
8004/R	29	34	32
8004/C	42	47	46

*Discontinued when out of stock.

8005



8005/S SINGLE



8005/D DOUBLE

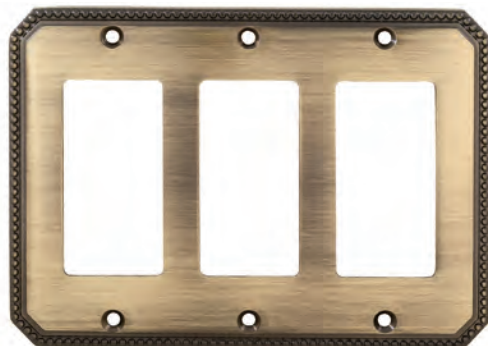

8005/T TRIPLE

D/O - Discontinued when out of stock.

Item#	FINISHES		
	US3	US15	US26 SB
8005			
Beaded Design 8005/S	\$29	\$34	\$32
8005/D	42	47	46
8005/T*	52	58	54

*Discontinued when out of stock.

Suggested retail prices effective May 1, 2024.

Switchplates • Solid Brass

8012



8012/S SINGLE



8012/D DOUBLE



8012/T TRIPLE

D/O - Discontinued when out of stock.



8012/R DUPLEX RECEPTACLE



8012/C COMBINATION

Item#	FINISHES		
	US3	US15	US26 US26D
8012			
8012/S	\$28	\$32	\$29
8012/D	40	46	41
8012/T*	50	55	52
8012/R	28	32	29
8012/C	40	46	41
8012/GFS	41	47	45

*Discontinued when out of stock.

8023



8023/S SINGLE



8023/D DOUBLE



8023/T TRIPLE

D/O - Discontinued when out of stock.

Item#	FINISHES		
	US3	US15	US26 US26D
8023			
8023/S	\$27	\$32	\$29
8023/D	40	46	41
8023/T*	50	55	52

*Discontinued when out of stock.

Suggested retail prices effective May 1, 2024.

Switchplates • Solid Brass

8014



8014/S SINGLE



8014/D DOUBLE



8014/T TRIPLE

D/O - Discontinued when out of stock.



8014/R DUPLEX RECEPTACLE



8014/C COMBINATION

Item#	FINISHES		
	US3	US15	US26 US26D SB
8014			
8014/S	\$29	\$32	\$31
8014/D	41	47	45
8014/T*	51	57	53
8014/R	29	32	31
8014/C	41	47	45

*Discontinued when out of stock.

8024



8024/S SINGLE



8024/D DOUBLE

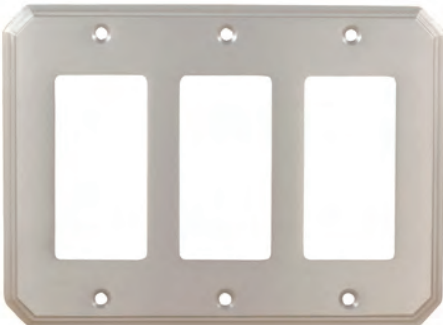

8024/T TRIPLE

D/O - Discontinued when out of stock.

Item#	FINISHES		
	US3	US15	US26 US26D SB
8024			
8024/S	\$29	\$32	\$31
8024/D	41	47	45
8024/T*	51	57	53

*Discontinued when out of stock.

Suggested retail prices effective May 1, 2024.

OMNIA TERMS & CONDITIONS OF SALE

(as of May 1, 2024)

WARRANTIES

Limited Mechanical Warranty

OMNIA Industries, Inc. ("OMNIA") offers to the original owner a Limited Warranty that all OMNIA products shall be free of mechanical abnormality for the duration that the original owner inhabits the residence in which the product was originally installed.

Exclusions

Any OMNIA product having an abnormality due to improper installation, forced entry, failure to exercise normal maintenance or against the consequences of uses for which our products were not designed is not covered by this warranty. Additionally, if an OMNIA product or component part is used with a product that is not ours or a component part (such as an OMNIA lock or latch with non-OMNIA knobs, levers, escutcheons and roses), any warranty shall be null and void. Warranty does not cover normal wear and tear.

FINISH WARRANTIES

(Includes General Maintenance)

Stainless Steel

OMNIA warrants its stainless steel finish shall be free from abnormalities in material and workmanship from tarnishing or rusting for either five (5) years from date of purchase for interior use or one (1) year from the date of purchase on exterior doors only for the duration that the original owner inhabits the residence in which the product was originally installed. Exposure to certain chemical or environmental conditions may promote surface oxidation. Please be aware that this is not an abnormality in the stainless steel but a reaction on the surface of the finish to the chemical environment which can be removed with a stainless steel polish or an abrasive pad. **Surface oxidation is not considered an abnormality in the product.**

Stainless Steel PVD

The OMNIA PVD finishes use an advanced finishing technology (Physical Vapor Deposition) to create a finish highly resistant to the effects of weather and normal use. For OMNIA products purchased with PVD finishes, OMNIA warrants the finish shall be free from abnormalities in materials and workmanship from tarnishing, flaking or pitting for the **Lifetime** of the applicable product for the duration that the original owner inhabits the residence in which the product was originally installed. Although the OMNIA PVD finishes are highly resistant to the effects of weather and normal use, they do require periodic maintenance. A build-up may occur if it is not performed, which may create a haze or darker look to the finish. This is neither tarnish nor an abnormality in the PVD finish. OMNIA PVD finishes can be maintained simply by wiping with a soft cloth and glass cleaner; or as an alternative, a non-abrasive metal polish which can be purchased at any hardware store. Rubbing alcohol may also be used to clean the surface of PVD finishes. **DO NOT use metal polishes that contain abrasives.**

Remaining Finishes

OMNIA warrants its finishes (excluding unlacquered finishes, stainless steel and

stainless steel PVD) shall be free from abnormalities in materials and workmanship from tarnishing, flaking or pitting for either five (5) years from date of purchase for interior use, or one (1) year from the date of purchase for use on exterior doors only for the duration that the original owner inhabits the residence in which the product was originally installed. Only use a damp cloth to clean surface of finish to remove dirt and grime. **DO NOT use household cleaners and/or chemicals.**

Exclusions

Any OMNIA product having an abnormality due to neglect, misuse, abuse or unreasonable or extraordinary use or lack of normal maintenance is not covered by this warranty. In addition, any OMNIA product having an abnormality due to use of paints, solvents or other chemicals is not covered by this warranty. Discontinued products will not be covered by any warranty. Finishes will not be warranted for any OMNIA product installed on an exterior metal door.

FOR ALL WARRANTIES, PLEASE NOTE: OMNIA is not responsible for labor charges related to installation, repair or replacement of any product under this warranty. OMNIA's liability under this warranty shall not exceed the sale price of the product.

PRICES

Prices are subject to change without notice. Invoices will reflect prices in effect at the time of shipment. OMNIA is not responsible for errors and/or omissions which may appear in any printed material. Orders held by OMNIA because of credit status may be repriced to pricing in effect on date of order release by OMNIA Credit Department.

RETURNED GOODS

Products must be returned within 60 days of original invoice date. There is a minimum 25% restock fee, plus a freight charge, for all unused and undamaged items returned in original condition. All returns must be accompanied with a completed Return Goods Form (RGF). Any return which exceeds \$1,000 net requires prior authorization. If a factory defect is claimed, please contact OMNIA for replacement or authorization. Any credit due will be determined upon inspection. Reordered or replacement materials will be billed when shipped. Returns will be credited after inspection and approval. All returns must be shipped freight prepaid. COD returns will be refused. Special order or discontinued items will not be accepted for return.

ORDERS & SPECIFICATIONS

OMNIA has the right to not accept orders in part or whole if the quantity, finishes or prices requested are not suitable. Packing, weights, measurements and designs are subject to change without notice. All special factory orders are non-cancelable, non-returnable and non-refundable.

ORDER CHANGES

If there are items not readily available, OMNIA will ship and backorder. Items temporarily out of stock will be backordered and so indicated on invoice. Backorders must be canceled prior to shipment of product. Orders canceled after

shipment from OMNIA will incur freight charges and a 25% restocking charge. Address changes after shipment will incur freight charges.

DISCONTINUED ITEMS & D/O

OMNIA may discontinue product or alter specifications at any time without prior notification or obligation. D/O designates a product which will continue to be available as long as inventory remains, after which the product will be discontinued. This program is intended to help our customers anticipate future needs and to avoid bidding or taking orders on parts which may not be available in sufficient quantities when needed.

SHIPMENTS

Smaller orders, shipments destined outside the US borders, and **all specially quoted contract orders are shipped FOB Cedar Grove, NJ.** Cremona bolt orders do not qualify for prepaid shipments. Freight charges will apply to contract orders. Please refer to job quote. There will be a handling fee in addition to freight charges. (Drop ship orders incur a higher handling fee.) In certain instances, a fee for insurance coverage may be added. OMNIA will select the quickest and best routes available. Consignee assumes risk of loss or damage after shipments have been delivered to carrier. Claims must be filed with the transportation company. We cannot accept consignee or third party billing for any shipment.

OPEN ACCOUNTS

Established accounts will be maintained on open account terms as long as payments are kept current. New accounts must submit proper trade and bank references.

SAMPLE PROGRAM

Cabinet Hardware

Samples of cabinet pulls up to 6" and cabinet knobs up to 1 1/4" dia. are available free of charge with a \$10 shipping fee for each item ordered. A maximum of 3 samples can be ordered. If ordering more than one sample, the additional samples must all be different part numbers.

Door Hardware

Single dummy samples of door knobs and levers with a list price value up to \$75 are available free of charge with a \$20 shipping fee for each item ordered. For single dummy samples with a list price value of \$76 and over, there is a \$30 shipping fee for each item ordered.

For each sample ordered, you will receive a discount coupon in the amount of the shipping fee. For each \$100 list purchase made through an authorized OMNIA dealer, you may apply one discount coupon. Since there is no charge for the product samples themselves, they cannot be returned to OMNIA for product credit.

If you are interested in a sample of a product other than cabinet hardware or single dummies, please contact OMNIA for shipping costs.

An Authorized OMNIA dealer may request a complete Dealer Terms & Conditions by emailing info@OMNIAindustries.com.



OMNIA
SINCE 1964

5 Cliffside Drive • Box 330
Cedar Grove, New Jersey 07009
tel 973.239.7272
Email: orders@OMNIAindustries.com
www.OMNIAindustries.com

