

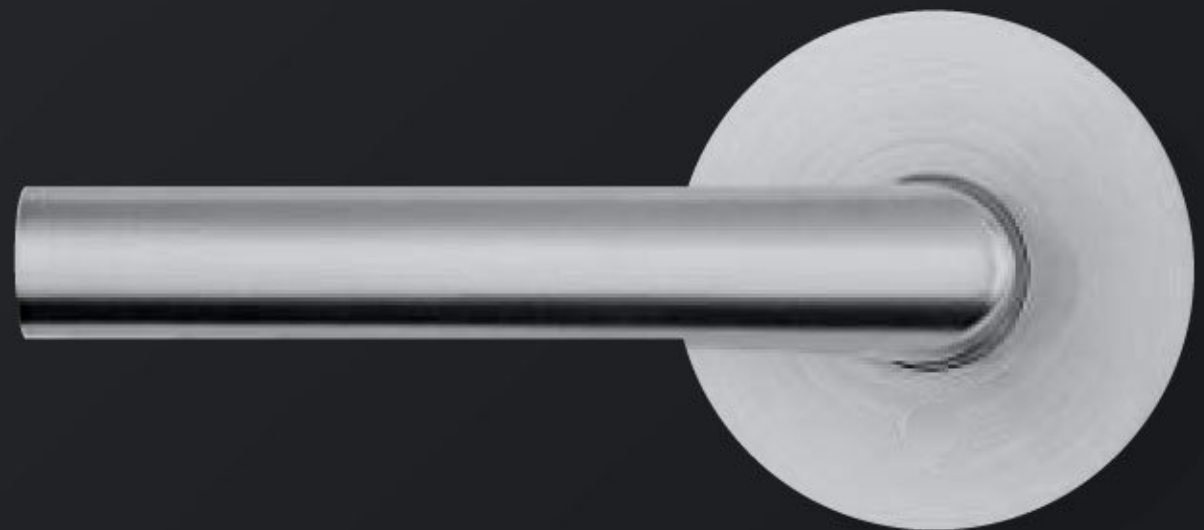

Door Hardware + Bath Accessories

Price Book



GENERAL INFORMATIONI-IX

HINGES 1-10
 COMMERCIAL HINGES 1-5
 RESIDENTIAL HINGES 6-8
 HINGE SCREWS 9
 CONTINUOUS GEARED HINGES 10

COMMERCIAL LOCKS 11-37
 MORTISE LOCKS 11-15
 ANNAPOLIS SERIES 16, 19
 PENDLETON SERIES 17, 19
 ALAMEDA SERIES 18, 19
 ELECTRIFIED ANNAPOLIS / PENDLETON / ALAMEDA 19
 FDP SERIES 20
 DAVIDSON SERIES 21
 PRINCETON SERIES 22-23
 AVALON 24
 CAMBRIDGE SERIES 25-26
 DALLAS SERIES 26
 SIERRA SERIES 27
 FD7 SERIES 28-29
 FD8 SERIES 30
 CONCORD SERIES 31
 HAMPTON / DAYTONA SERIES 32
 WESTFIELD SERIES 33
 NEWPORT / FREMONT SERIES 34
 TOLEDO / KENTON / STERLING SERIES 35
 MIRAGE / TACOMA / ONTARIO SERIES 36
 I/C CORE CYLINDER 37

RESIDENTIAL LOCKS 38-67
 ELECTRONIC KEYPAD / LEVERSET 38
 HANDLESETS 39-43
 TUSCANY / CATALINA SERIES 39
 ALHAMBRA / GRANADA SERIES 40
 LEXINGTON SERIES 41
 VICTORIAN / SPRINGFIELD SERIES 42
 TROY SERIES 42-43
 INTERCONNECTED HANDLESETS 44-45
 LEVERSETS 46-57
 MIRA / TAHOE SERIES 46
 ONYX SERIES 47
 ALTO SERIES 48
 NAPLES SERIES 49-50
 NEWBERRY SERIES 51
 VIANO SERIES 52
 FLORENCE / DENVER SERIES 53
 MILANO SERIES 54
 CALYPSO SERIES 55
 OLYMPIC SERIES 56
 SAVANNAH SERIES 57
 ANSI GRADE 2 58
 ALTO 2/CALYPSO 2 SERIES 58
 KNOBSETS 59-62
 KONA SERIES 59
 CHESTER / BELLE SERIES 60
 BARON SERIES 61
 SATURN SERIES 62
 DEADBOLTS 63-65
 FDK / FDS SERIES 63
 FD2 SERIES 64
 FD3 SERIES 65
 OTHER LOCKS 66-67
 SLIDING DOOR LOCKS 66
 COMBO SETS 67

PARTS & ACCESSORIES FOR DOOR LOCKS 68-86
 DOOR LOCK ACCESSORIES 68
 REKEYING PARTS 69-70

KEYS & CYLINDERS 71-73
 SCREWS 74-75
 UL-LATCHES 76-80
 LATCHES 81-83
 STRIKE PLATES 84-85
 OTHER CHARGES 86

EXIT DEVICES 87-135
 E9000 SERIES 87-100
 E9100 SERIES 101-112
 E9300 SERIES 113-114
 E7000 SERIES 115-122
 E5000 SERIES 123-129
 E8000 SERIES 130-134
 MULLIONS 135

ELECTRIC HARDWARE 136-138
 ELECTRIC STRIKES & MAGNETIC DOOR HOLDERS 136
 POWER TRANSFER DEVICES 137
 POWER SUPPLY 138

DOOR CLOSERS 139-146
 GC4400 SERIES 139-140
 GC5900 SERIES 141-142
 GC6800 SERIES 143-144
 GC8700 SERIES 145
 GC800 SERIES 146

COMMERCIAL DOOR HARDWARE 147-155
 SURFACE OVERHEAD DOOR STOPS 147-148
 FLUSH BOLTS / EXTENSION ROD / DUST PROOF STRIKE 149-150
 HINGE / WALL / DOME STOPS / MOP & ARMOR PLATE 151-152
 DOOR HOLDERS / FLOOR STOPS / DOOR GUARDS 153-154
 GUARD SHIM / DOOR ANGLE PROTECTOR 154
 PUSH & PULL PLATES & KICKPLATES 155

DOOR HARDWARE 156-175
 BARN DOOR HARDWARE 156-159
 DOOR VIEWERS & KNOCKERS 160-161
 NUMBERS & LETTERS 162-165
 DOOR STOPS 166
 HINGE PIN STOPS 167
 HANDRAIL BRACKETS / CRASH CHAINS 168
 BALL / ROLLER CATCHES / THE BLUE THING / SILENCER 169-170
 FLUSH / SURFACE BOLTS / BI-FOLD KNOBS 171-172
 FINGER PULL / CLOSET HARDWARE / POLE SOCKET SET 173
 SLIDING DOOR LOCKS 174-175

BATH ACCESSORIES 176-212
 SOLANO COLLECTION 176-177
 VINA COLLECTION 178-179
 EUREKA COLLECTION 180-181
 LA QUINTA COLLECTION 182-183
 CHARLESTON COLLECTION 184-185
 VENTURA COLLECTION 186-188
 CARMEL COLLECTION 189-190
 SEAL BEACH COLLECTION 191-192
 ESTES COLLECTION 193-194
 CAMPBELL COLLECTION 195-196
 CORONA COLLECTION 197-199
 EDISON COLLECTION 200-201
 PAPER HOLDER ROLLERS 201
 TOWEL BARS 202-203
 GRAB BARS 204-205
 SHOWER ROD & FLANGE SETS 206-207
 CURVED SHOWER ROD 208
 SPACIOUS SHOWER ROD 209-210
 HOSPITALITY ACCESSORIES 211
 RECESSED FIXTURES 212

TERMS AND CONDITIONS**PRICES**

All prices are subject to change without notice and are not guaranteed.

TERMS

Net 30 days from date of invoice on approved credit.

MINIMUM CHARGE

A service charge of \$5.00 will be added on to orders of \$50.00 or less.

CREDIT CARD FEE

All credit card payments will be charged an additional 3.5% convenience fee.

PACKING

Pamex will pack, mark, and ship the products according to its standard procedures for shipment unless both parties agree, in writing, that Pamex will comply with any special instructions provided by the customer. Compliance with special instructions may result in an extra service charge.

FREIGHT

All goods are invoiced FOB Chino, CA. Upon delivery of shipments to the carrier, title to, and the risk of loss or damage in transit for, such shipments passes to our customer.

FREIGHT ALLOWANCE

Full freight will be prepaid on orders of \$1,000 or more to a single destination in the continental U.S., by carrier and route of our choice. Shipments of less than \$1,000 will not be shipped on a prepaid basis. If higher freight charges are incurred from customers specifying a carrier or route of their choice, the additional cost will be added to that customer's invoice.

DELIVERY CONDITIONS

Shipping schedules are our best estimates and cannot be guaranteed. We are not responsible for any direct or consequential loss or damage resulting from an inability or delay in meeting shipping schedules. It is the customer's responsibility to count the total cartons before he/she signs the bill of lading. Claims for shortages, damage, and/or incorrectly filled orders must be filed with our customer service department within 7 days of receipt of material.

RETURNS

All merchandise returned for credit must have prior written authorization from the Pamex customer service department. A Return Merchandise Authorization (RMA) number will be issued and a copy of this itemized list must accompany the returned shipment with a stated explanation for the return. All merchandise returned for credit must be in clear salable condition. Requests for credit returns are allowed within six months of the original invoice date. All parts, special orders, and non-stock items are not returnable. A 40% restocking charge will be assessed on returned merchandise. Any labor items, such as keying charges, are not eligible for credit. Freight for the returned merchandise is the responsibility of the returning party.

ANSI STANDARD

All residential locks meet **A 156.2 series Grade 3 or Grade 2** requirements.

All commercial locks meet **A 156.2 series 4000 Grade 1 or Grade 2** requirements and UL 3-hour fire rating.

All commercial deadbolts meet **A 156.5 series 4000 Grade 1 or Grade 2** requirements and UL 3-hour fire rating.

LATCH STANDARD **Brass & Steel Casting**

Residential Series	<p>Exterior: 1" face, Adjustable deadlatch, 1/4" radius round corner mortise type.</p> <p>Interior: 1" face, Adjustable plainlatch, 1/4" radius round corner mortise type.</p> <p>Deadbolt: 1" face, Adjustable deadbolt, 1/4" radius round corner mortise type. (FD2, FD3 series) 1" face, Adjustable deadbolt, 1/4" radius round corner mortise type. (FDK, FDS series)</p> <p>The Grade 3 and Grade 2 locks supplied with UL latch meets NFPA 80-180 requirements for 1 hour wall with 1/3 hour fire rating.</p>
Commercial Series	<p>For Annapolis, Pendleton, Alameda Series--H. D. G1 Cylindrical Locks</p> <p>Exterior: 1-1/8" face, 2-3/4" UL listed deadlatch, square corner mortise type</p> <p>Interior: 1-1/8" face, 2-3/4" UL listed plainlatch, square corner mortise type</p> <p>For Davidson, Princeton, Avalon Series--H. D. G2 Cylindrical Locks</p> <p>Exterior: 1-1/8" face, 2-3/4" UL listed deadlatch, square corner mortise type</p> <p>Interior: 1-1/8" face, 2-3/4" UL listed plainlatch, square corner mortise type</p> <p>For G2 Tubular Interconnected Locks</p> <p>Double locking:</p> <p>Deadbolt: 1-1/8" face, Adjustable UL listed deadbolt, square corner mortise type</p> <p>Entry: 1-1/8" face, Adjustable UL listed deadlatch, square corner mortise type</p> <p>Single locking:</p> <p>Deadbolt: 1-1/8" face, Adjustable UL listed deadbolt, square corner mortise type</p> <p>Passage: 1-1/8" face, Adjustable UL listed plainlatch, square corner mortise type</p> <p>For Cambridge, Dallas, Sierra Series--G2 Tubular Locks</p> <p>Exterior: 1" face, Adjustable UL listed deadlatch, 1/4" radius round corner mortise type</p> <p>Interior: 1" face, Adjustable UL listed plainlatch, 1/4" radius round corner mortise type</p> <p>For Deadbolt-- FDP series 1-1/8" face, Adjustable UL listed deadbolt, square corner mortise type</p> <p>FD7 series 1" face, Adjustable UL listed deadbolt, square corner mortise type</p> <p>FD8 series 1" face, Adjustable non-UL listed deadbolt, round corner mortise type</p>

STRIKE PLATE STANDARD

Residential Series	<p>Tubular lock: FT4SP — 1-3/4"x2-1/4" full lip, 1/4" radius round corner</p> <p>Deadbolt: FD9SP — 1-3/4"x2-1/4" full lip, 1/4" radius round corner for FD2, FD3, FDK, FDS and G3 handlesets</p> <p>FD1SP — 1-1/8"x2-3/4", square corner for G2 handlesets</p>
Commercial Series	<p>For Annapolis, Pendleton, Alamedar: FASA — 1-1/4"x4-7/8" ASA-strike, square corner</p> <p>For Davidson, Princeton, Avalon: FASA — 1-1/4"x4-7/8" ASA-strike, square corner</p> <p>For Tubular Interconnected Locks:</p> <p>Deadbolt: FD1SP — 1-1/8"x2-3/4", square corner for deadbolt</p> <p>Tubular lock: FT7SPG — 1-1/8"x2-3/4" T-strike, square corner for leverset</p> <p>For Cambridge, Dallas, Sierra Series-- Tubular Locks:</p> <p>FT4SPG — 1-3/4"x2-1/4" full lip, 1/4" radius round corner</p> <p>For Deadbolt-- FDP series: FD1SP — 1-1/8"x2-3/4", square corner</p> <p>FD7 series: FD1SP — 1-1/8"x2-3/4", square corner</p> <p>FD8 series: FD1SP — 1-1/8"x2-3/4", square corner</p>

Note: Orders for product in 32D, 15, 15A, 26, or 26D finishes will be packaged with latches and strike plate in 32D finish.

Orders for product in 10B, 11P or 19 finishes will be packaged with latches and strike plate in 10B finish.

KEYWAY

Residential Series Standard: Pamex 5-pin cylinder KW keyway. (5-pin SC "C" keyway available)

Commercial Series Standard: Pamex 6-pin cylinder SC "C" keyway. (5-pin SC "C" and KW 5-pin keyway available)

FD8 Series with KW 5-pin as standard

PACKAGING

All locks are shipped box-packed as standard. Package includes latch, strike, screws and instructions. All key locks are packed with two keys. Visual Packaging is also available by special order only.

DOOR HANDING

How to determine the handing of a door:

- The hand of a door is always determined by facing the OUTSIDE of a door.
- If the hinge is on the left side of the door, the door is left handed (LH).
- If the hinge is on the right side of the door, the door is right handed (RH).

Not all products are handed; only specify handing when required.

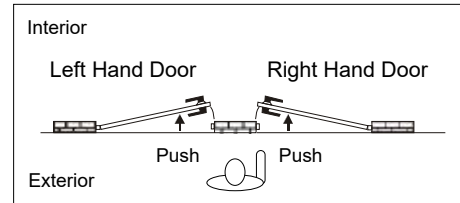

KEYING OPTION

Code	Description
KA2,3,4	Keyed Alike 2,3,4
KD	Keyed Differently
MK	Master Keyed
CK	Construction Keyed
MCK	Master + Construction Keyed
GMK	Grand Master Keyed

- All residential entry locks and deadbolts are shipped KA4 (Keyed Alike 4). Handlesets are shipped KD (Keyed Differently) unless otherwise specified.
- All commercial entry locks and deadbolts are shipped KA2 (Keyed Alike 2) unless otherwise specified. Interconnected locks are shipped KD (Keyed Differently).
- For rekeying charges, please see page 86.
- For I/C Core keying charge, please see pages 37 & 86.

PAMEX LOCKS FINISH CODE

Pamex Code	Description	US Code	BHMA Code
0	Oil Rubbed Bronze	10B	613
2	Polished Chrome	26	625
6	Satin Stainless Steel	32D	630
7	Polished Brass	3	605
8	Antique Brass	5	609
9	Matte Black	19	622
C	Antique Nickel	15A	620
M	Zirconium, Lifetime Polished Brass	L03	505
S	Satin Chrome	26D	626
P	Satin Nickel	15	619
K	Venetian Bronze	11P	

Door preparation template for **ALL** residential series, Grade 2 deadbolts and Grade 2 tubular locks.

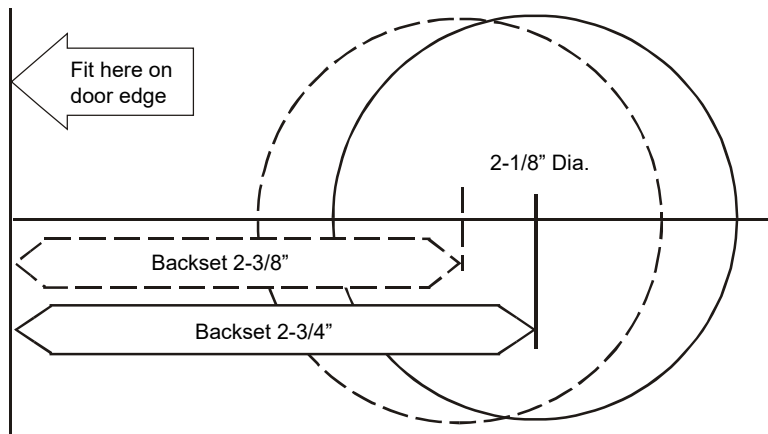

PAMEX PRODUCT WARRANTIES

Subject to the terms and conditions of this warranty, Pamex extends limited mechanical and finish warranties to the original user ("Original User") of all Pamex products ("Product(s)") against defects in workmanship, materials, or operation, subject to ordinary wear and tear as it pertains to particular installations, so long as the Original User occupies the residential premises upon which the Product was originally installed. This warranty is non-transferable and is subject to the following warranty periods, which begins running from the date of purchase of the Product:

Products	Warranty
Grade 1 Commercial Mortise Locks	Life-Time Mechanical / 5 Years Finish
Grade 1 Commercial Locks & Latches	Life-Time Mechanical / 5 Years Finish
Grade 2 Commercial Locks & Latches	Life-Time Mechanical / 5 Years Finish
GC4400 (Grade 1 - Door Closer)	25 Years Mechanical / 5 Years Finish
GC5900 (Grade 1 - Door Closer)	25 Years Mechanical / 5 Years Finish
GC6800 (Grade 1 - Door Closer)	25 Years Mechanical / 5 Years Finish
GC8700 (Grade 1 - Door Closer)	10 Years Mechanical / 5 Years Finish
GC800 (Grade 2 - Door Closer)	10 Years Mechanical / 5 Years Finish
E9000 (Grade 1 - Exit Device)	Life-Time Mechanical / 5 Years Finish
E9100 (Grade 1 - Exit Device)	Life-Time Mechanical / 5 Years Finish
E9300 (Grade 1 - Exit Device)	Life-Time Mechanical / 5 Years Finish
E7000 (Grade 1 - Exit Device)	10 Years Mechanical / 5 Years Finish
E5000 (Grade 1 - Exit Device)	10 Years Mechanical / 5 Years Finish
E8000 (Grade 2 - Exit Device)	10 Years Mechanical / 5 Years Finish
Commercial Door Hardware	1 Year Mechanical / 1 Year Finish
Bath & Hospitality Accessories	1 Year Mechanical / 1 Year Finish
Grade 2 Residential Exterior Handlesets	Life-Time Mechanical / 5 Years Finish
Grade 3 Residential Exterior Handlesets	Life-Time Mechanical / 5 Years Finish
Grade 3 Residential Deadbolts	Life-Time Mechanical / 5 Years Finish
Grade 3 Residential Interior Locks	Life-Time Mechanical / 5 Years Finish
Grade 2 / 3 Residential Interior Latches	Life-Time Mechanical / 5 Years Finish
Residential Door Hardware	1 Year Mechanical / 1 Year Finish
Bath Accessories	1 Year Mechanical / 1 Year Finish

This warranty does not apply to Products: (i) that have been subject to abuse, misuse, alteration, or negligence; (ii) that have been improperly installed, stored, maintained, or operated; or (iii) used for purposes for which they are not designed or intended, including use of residential Products in commercial or common area applications. The following costs and expenses are not covered by the provisions of this limited warranty: (i) labor costs for the removal and reinstallation of Products; (ii) shipping and freight expenses required to return products to Pamex; (iii) normal maintenance; and (iv) economic losses. In addition, this warranty does not cover deterioration or scratches in finishes resulting from the use of paints, solvents, or other chemicals.

Upon receipt of a returned Product deemed by Pamex to be defective, Pamex reserves the right to either repair or replace the Product, or refund the original purchase price to the original purchaser of the Product. In order to receive refund credit, the returned Product must include a prior written authorization for return issued by Pamex and be received by Pamex, with all return shipping charges prepaid by the returning party, within one year of delivery of the Product to the original purchaser.

Pamex is not liable for incidental or consequential damages. Some states do not allow the exclusion or limitation of incidental or consequential damages, so the above exclusion may not apply to you. This warranty gives you specific legal rights and you may also have other rights that vary from state to state.

Pamex reserves the right to make changes in designs and specifications or to make additions or improvements on its Products without notice and without incurring any obligation to incorporate them on Products previously manufactured.

To make a claim under this warranty, please contact Pamex's Customer Service Department at (800) 621-6869 or sales@pamexinc.com.

PAMEX® LOCK FINISH CHART

US CODE	3	5	10B	11P	15	15A	19	26	26D	32D	L03
BHMA	605	609	613		619	620	622	625	626	630	505
HANDLESETS											
Alhambra				•	•						•
Catalina	•		•		•	•					
Granada				•	•						•
Lexington	•	•	•	•	•	•	•	•			•
Springfield	•				•						
Troy			•	•	•		•	•			
Tuscany			•	•	•						
Victorian	•				•						
LEVERSETS											
Alto					•		•	•			
Calypso	•	•			•		•	•	•		
Denver	•		•		•						
Florence	•	•			•						
Milano	•	•		•	•		•				
Mira					•		•	•			
Naples	•		•	•	•	•	•	•			
Newberry	•		•		•	•					
Olympic	•	•			•		•	•	•		
Onyx					•		•	•			
Savannah	•	•			•						
Tahoe					•		•	•			
Viano	•		•		•	•					
KNOBSETS											
Baron	•	•	•	•	•	•	•			•	
Belle	•	•								•	
Chester	•		•	•	•						
Kona					•		•	•			
Saturn	•	•	•		•	•		•		•	•
DEADBOLTS											
FD2	•	•	•	•	•	•	•	•	•	•	
FD3	•	•	•	•	•	•	•	•		•	•
FDK/FDS					•		•	•			

PAMEX® COMMERCIAL LOCK FINISH CHART

US CODE	3	5	10B	11P	15	15A	19	26	26D	32D
BHMA	605	609	613		619	620	622	625	626	630
COMMERCIAL LOCKS										
Alameda			•		•				•	
Annapolis			•		•		•		•	
Avalon					•		•		•	
Cambridge	•	•	•		•		•		•	
Concord					•			•	•	
Dallas			•		•				•	
Daytona / Fremont			•		•				•	
Davidson			•		•				•	
Kenton / Tacoma					•		•	•		
Newport / Hampton			•		•					
Pendleton			•		•				•	
Princeton	•	•	•		•		•		•	
Sierra	•	•								•
Sterling / Ontario					•		•	•		
Toledo / Mirage					•		•	•		
Westfield					•		•	•	•	
FDP Deadbolt			•		•		•		•	
FD7 Deadbolt	•	•	•		•		•	•	•	•
FD8 Deadbolt			•		•		•	•	•	•

BATHROOM ACCESSORIES FINISH CHART

US CODE	26	3	15	12P	11P	19	15A
BHMA	625	605	619	716		622	620
	Chrome	Polished Brass	Satin Nickel	Dark Bronze	Venetian Bronze	Matte Black	Antique Nickel
Solano / Vina	•		•			•	
Eureka / La Quinta	•	•	•				
Charleston	•		•		•	•	
Ventura	•	•	•	•	•	•	•
Carmel	•	•	•	•		•	
Seal Beach	•	•	•	•		•	
Estes	•		•	•		•	
Campbell	•	•					
Corona	•	•	•	•		•	
Edison	•						

LEED PROGRAMS & CREDITS

LEED is an internationally recognized green building certification system, providing third-party verification that a building or community was designed and built using strategies aimed at improving performance across all the metric that matter most: energy savings, water efficiency, CO2 emissions reduction, improved indoor environmental quality, and stewardship of resources and sensitivity to their impacts.

The LEED rating system includes categories such as Sustainable Site, Water Efficiency and Materials and Resources. Pamex products fall under the category of Materials and Resources specifically for Credit 4: Recycled Content. You can get 1 point if the total recycled content for the material used is over 10% and 2 points if it's over 20%.

Credit	Requirement
Recycled Content MR 4.1	Use materials with recycled content such that the sum of the post-consumer recycled content plus one-half of the pre-consumer content constitutes at least 10% of the total values of the material in the project.
Recycled Content MR 4.2	Use materials with recycled content such that the sum of the post-consumer recycled content plus one-half of the pre-consumer content constitutes an additional 10% beyond MR Credit 4.1 (total of 20% based on cost) of the total values of the material in the project.

Post-consumer material is defined as waste material generated by households or by commercial, industrial and institution facilities in their role as end-user of the product, which can no longer be used for its intended purpose.

Pre-consumer material is defined as material diverted from the waste stream during the manufacturing process. Excluded is reutilization of materials such as rework, regrind or scrap generated in a process and capable of being reclaimed within the same process that generated it.

Based on the review of current LEED rating systems for applicability to architectural door hardware, Pamex states the following:

Materials and Resources: Recycled Content

Product	Post-Consumer Recycled Content %	Pre-Consumer Recycled Content %	Total LEED %
Door Closers			
GC4400 Series	47.0%	31.0%	62.5%
GC5900 Series	47.0%	31.0%	62.5%
GC6800 Series	47.0%	31.0%	62.5%
GC8700 Series	46.0%	31.0%	61.5%
GC800 Series	47.0%	30.0%	62.0%
Exit Devices			
E9000 Series	39.0%	33.0%	55.5%
E9100 Series	39.0%	33.0%	55.5%
E9300 Series	39.0%	33.0%	55.5%
E7000 Series	39.0%	33.0%	55.5%
E5000 Series	55.0%	31.0%	70.5%
E8000 Series	54.0%	30.0%	69.0%
Commercial Locks			
FYA Series Cylindrical Lock	26.0%	15.0%	33.5%
FYC Series Cylindrical Lock	24.0%	14.0%	31.0%
FLB Series Tubular Lock	17.0%	22.0%	28.0%
FI Series Interconnected Lock	15.0%	21.0%	25.5%
FDP Deadbolt	12.0%	27.0%	25.5%
FD7 Deadbolt	12.0%	27.0%	25.5%
FD8 Deadbolt	16.0%	23.0%	27.5%
Residential Locks			
Handleset	12.0%	27.0%	25.5%
Leverset	13.0%	26.0%	26.0%
Knobset	19.0%	22.0%	30.0%
FD2 Series Deadbolt	16.0%	23.0%	27.5%
FD3 Series Deadbolt	15.0%	26.0%	28.0%

BUY AMERICA ACT (BAA) AMERICAN RECOVERY & REINVESTMENT ACT (ARRA)

BAA was established give a preference for the United States government to purchase US manufactured products over competing products. However, there are two exceptions to BAA. The first exception deals with existing trade agreements with preferred WTO trading partners and NAFTA trading partners.

Many Pamex products are manufactured in Taiwan which are designated WTO country and by WTO agreements with the United States, products manufactured in Taiwan are exempt from BAA in federal contracts and federally funded jobs – either wholly funded or partially funded.

ARRA is part of the 2009 stimulus act which deals with iron, steel

and products manufactured from these items. As is the case with BAA, WTO designated countries are exempt from this Act.

The second exemption comes from BAA of March 3, 1933, which states that the federal government can purchase items which are not manufactured in the US if US goods and products are not available in sufficient quantity. This Act was amended by Executive Order #11501 in September 27, 1962. The change in the Act is known “Unreasonable Costs Provision”. This provision stated that if a domestic product is 6% or more costly than any foreign product from any country that product is exempt from BAA.

PRODUCT	STYLE	FUNCTIONS	FINISH	COO
Exit Devices				
E9000 / E9100 / E9300 Series	---	All	All	Taiwan
E7000 Series	---	All	All	Taiwan
E5000 Series	---	All	All	Taiwan
E8000 Series	---	All	All	Taiwan
Commercial Locks				
MS Series Mortise Lock	All	All	All	Taiwan
FYA Series Cylindrical Lock	All	All	All	Taiwan
FYC Series Cylindrical Lock	All	All	All	Taiwan
FLB Series Tubular Lock	All	All	All	Taiwan
FI Series Interconnected Lock	All	All	All	Taiwan
FDP/FD7/FD8 Series Deadbolt	All	All	All	Taiwan
Residential Locks				
Handleset	All	All	All	Taiwan
Leverset	All	All	All	Taiwan
Knobset	All	All	All	Taiwan
FD2/FD3 Series Deadbolt	All	All	All	Taiwan
Door Hardware				
Wall Stop (DD05-53/57)	All	---	All	Taiwan
Dome Stop (DD02-61/63)	All	---	All	Taiwan
H.D. Roller Catch (DD05-51/52)	All	---	All	Taiwan
Finger Pull (DD06-20)	All	---	All	Taiwan
Pull/Push Plate (DD09-10/20)	All	---	All	USA
Kick Plate (DD09-30/31)	All	---	All	USA/Taiwan
Bath Accessories				
Solano Collection	All	All	All	Taiwan
Vina Collection	All	All	All	Taiwan
Eureka Collection	All	All	All	Taiwan
La Quinta Collection	All	All	All	Taiwan
Charleston Collection	All	All	All	Taiwan
Ventura Collection	All	All	All	Taiwan
Carmel Collection	All	All	All	Taiwan
Seal Beach Collection	All	All	All	Taiwan
Estes Collection	All	All	All	Taiwan
Compbell Collection	All	All	All	Taiwan
Corona Collection	All	All	All	Taiwan
Edison Collection	All	All	All	Taiwan
Hospitality Accessories *	All	All	All	Taiwan
Crescent Shower Rod	All	All	All	Taiwan
Recessed Fixtures	All	All	All	Taiwan

* Recessed Vanity Tissue Box is not eligible for BAA.

FLORIDA BUILDING CODE APPROVED HARDWARE

Florida Building Code: **FL14722**
ASTM E1886/E1996/E330

Pamex is pleased to announce the following hardware have been tested and approved to meet the Florida Building Code:

FL#	Model	Description
14722.1	FI Interconnected Series	Interconnected Tubular Lock and Deadbolt for use on a Steel Door Panel - "Impact Rated" for Inswing or Outswing usage
14722.2	FD8 Deadbolt / F Series Knob or Lever	Grade 2 Removable Cylinder Deadbolt with Knob or Lever Lock for use on a Steel Door Panel - "Impact Rated" for Inswing or Outswing usage
14722.3	FD7 Deadbolt / F Series Knob or Lever	Grade 2 Deadbolt with Knob or Lever Lock for use on a Steel Door Panel - "Impact Rated" for Inswing or Outswing usage
14722.4	FD2 Deadbolt / F Series Knob or Lever	Grade 3 Deadbolt with Knob or Lever Lock for use on a Steel Door Panel - "Impact Rated" for Inswing or Outswing usage
Pending	FI Contemporary Interconnected Series	Interconnected Tubular Lock and Deadbolt for use on a Fiberglass Door - "Impact Rated" for Inswing or Outswing usage
Pending	FDS/FDK Deadbolt / FLT/FLS/FLT Lever	Grade 3 Deadbolt with Knob or Lever Lock for use on Fiberglass Door - "Impact Rated" for Inswing or Outswing usage

To view the complete information, please log onto www.floridabuilding.org.

CARE & MAINTENANCE STATEMENT

MECHANICAL

In order to extend the life of Pamex products, please complete the following steps:

- Inspect the lock for excessive accumulation of dirt and residue in the operating mechanism.
- Lubricate the keyway by placing a small amount of flaked graphite on the key and inserting it into the keyway.

Caution: Using too much flaked graphite will attract moisture and gum up the cylinder.

FINISH

Lifetime Polished Brass (PVD)

Wipe clean with a streak-free glass cleaner and soft cloth.

Satin Stainless Steel (US32D)

Use plastic pad or bronze wool. Protect with metal polish or car wax.





Oil-Rubbed Bronze (US10B) & Dark Bronze (US12P)

Use lemon oil then polish with dry cloth





Polished Brass (US3), Antique Brass (US5), Venetian Bronze (US11P), Antique Nickel (US15A), Satin Nickel (US15), Polished Chrome (US26) & Satin Chrome (US26D)

A final protective lacquer coating is applied to these finishes. To maintain the finish, wipe the hardware with a soft, water-dampened cloth. Never use abrasives, ammonia, or other harsh chemicals.

 * **WARNING:** Cancer and Reproductive Harm - www.P65warnings.ca.gov - See page 214 to learn more about California Proposition 65

	Model #	Description	Finish	QTY /Box	QTY /Case	List Price
 <p>4.5" x 4.5"</p>	0.134" Gauge					(each)
	H45-00NP	Square corner, plain bearings, NRP	USP	3	30	\$9.87
	H45-00NBL	Square corner, plain bearings, NRP	USL1	3	30	\$12.35
	H45-00NSN	Square corner, plain bearings, NRP	US15	3	30	\$12.35
	H45-00NSC	Square corner, plain bearings, NRP	US26D	3	30	\$12.35
	H45-00NOB	Square corner, plain bearings, NRP	US10B	3	30	\$14.20
	H45-00NSS	Square corner, plain bearings, NRP	US32D	3	30	\$35.48
 <p>4.5" x 4.5"</p>	0.134" Gauge					(each)
	H45-00RP	Square corner, plain bearings, removable pin	USP	3	30	\$8.98
	H45-00RBL	Square corner, plain bearings, removable pin	USL1	3	30	\$11.23
	H45-00RSN	Square corner, plain bearings, removable pin	US15	3	30	\$11.23
	H45-00RSC	Square corner, plain bearings, removable pin	US26D	3	30	\$11.23
	H45-00ROB	Square corner, plain bearings, removable pin	US10B	3	30	\$12.91
	H45-00RSS	Square corner, plain bearings, removable pin	US32D	3	30	\$32.24
 <p>4.5" x 4.5"</p>	0.134" Gauge					(each)
	H45-02NP	Square corner, 2 ball bearings, NRP	USP	3	30	\$11.85
	H45-02NBL	Square corner, 2 ball bearings, NRP	USL1	3	30	\$14.83
	H45-02NSN	Square corner, 2 ball bearings, NRP	US15	3	30	\$14.83
	H45-02NSC	Square corner, 2 ball bearings, NRP	US26D	3	30	\$14.83
	H45-02NOB	Square corner, 2 ball bearings, NRP	US10B	3	30	\$17.04
	H45-02NSS	Square corner, 2 ball bearings, NRP	US32D	3	30	\$42.56
 <p>4.5" x 4.5"</p>	0.134" Gauge					(each)
	H45-02RP	Square corner, 2 ball bearings, removable pin	USP	3	30	\$10.78
	H45-02RBL	Square corner, 2 ball bearings, removable pin	USL1	3	30	\$13.48
	H45-02RSN	Square corner, 2 ball bearings, removable pin	US15	3	30	\$13.48
	H45-02RSC	Square corner, 2 ball bearings, removable pin	US26D	3	30	\$13.48
	H45-02ROB	Square corner, 2 ball bearings, removable pin	US10B	3	30	\$15.50
	H45-02RSS	Square corner, 2 ball bearings, removable pin	US32D	3	30	\$38.70

	Model #	Description	Finish	QTY /Box	QTY /Case	List Price (each)
<p>4" x 4"</p> 	0.130" Gauge					
	H44-00NP	Square corner, plain bearings, NRP	USP	3	30	\$9.34
	H44-00NSB	Square corner, plain bearings, NRP	US4	3	30	\$10.04
	H44-00NBL	Square corner, plain bearings, NRP	USL1	3	30	\$11.68
	H44-00NSN	Square corner, plain bearings, NRP	US15	3	30	\$11.68
	H44-00NSC	Square corner, plain bearings, NRP	US26D	3	30	\$11.68
	H44-00NOB	Square corner, plain bearings, NRP	US10B	3	30	\$13.43
	H44-00NCP	Square corner, plain bearings, NRP	US26	3	30	\$14.79
	H44-00NSS	Square corner, plain bearings, NRP	US32D	3	30	\$29.96
<p>4" x 4"</p> 	0.130" Gauge					
	H44-10NP	1/4" radius, plain bearings, NRP	USP	3	30	\$9.34
	H44-10NSB	1/4" radius, plain bearings, NRP	US4	3	30	\$10.04
	H44-10NBL	1/4" radius, plain bearings, NRP	USL1	3	30	\$11.68
	H44-10NSN	1/4" radius, plain bearings, NRP	US15	3	30	\$11.68
	H44-10NSC	1/4" radius, plain bearings, NRP	US26D	3	30	\$11.68
	H44-10NOB	1/4" radius, plain bearings, NRP	US10B	3	30	\$13.43
	H44-10NCP	1/4" radius, plain bearings, NRP	US26	3	30	\$14.79
	H44-10NSS	1/4" radius, plain bearings, NRP	US32D	3	30	\$29.94
<p>4" x 4"</p> 	0.130" Gauge					
	H44-00RP	Square corner, plain bearings, removable pin	USP	3	30	\$7.18
	H44-00RSB	Square corner, plain bearings, removable pin	US4	3	30	\$7.70
	H44-00RBL	Square corner, plain bearings, removable pin	USL1	3	30	\$8.98
	H44-00RSN	Square corner, plain bearings, removable pin	US15	3	30	\$8.98
	H44-00RSC	Square corner, plain bearings, removable pin	US26D	3	30	\$8.98
	H44-00ROB	Square corner, plain bearings, removable pin	US10B	3	30	\$10.33
	H44-00RCP	Square corner, plain bearings, removable pin	US26	3	30	\$11.36
	H44-00RSS	Square corner, plain bearings, removable pin	US32D	3	30	\$25.80
<p>4" x 4"</p> 	0.130" Gauge					
	H44-10RP	1/4" radius, plain bearings, removable pin	USP	3	30	\$7.18
	H44-10RSB	1/4" radius, plain bearings, removable pin	US4	3	30	\$7.70
	H44-10RBL	1/4" radius, plain bearings, removable pin	USL1	3	30	\$8.98
	H44-10RSN	1/4" radius, plain bearings, removable pin	US15	3	30	\$8.98
	H44-10RSC	1/4" radius, plain bearings, removable pin	US26D	3	30	\$8.98
	H44-10ROB	1/4" radius, plain bearings, removable pin	US10B	3	30	\$10.33
	H44-10RCP	1/4" radius, plain bearings, removable pin	US26	3	30	\$11.36
	H44-10RSS	1/4" radius, plain bearings, removable pin	US32D	3	30	\$25.80

	Model #	Description	Finish	QTY /Box	QTY /Case	List Price (each)
 <p>4" x 4"</p>	0.130" Gauge (each)					
	H44-02NP	Square corner, 2 ball bearings, NRP	USP	3	30	\$11.20
	H44-02NSB	Square corner, 2 ball bearings, NRP	US4	3	30	\$12.04
	H44-02NBL	Square corner, 2 ball bearings, NRP	USL1	3	30	\$14.00
	H44-02NSN	Square corner, 2 ball bearings, NRP	US15	3	30	\$14.00
	H44-02NSC	Square corner, 2 ball bearings, NRP	US26D	3	30	\$14.00
	H44-02NOB	Square corner, 2 ball bearings, NRP	US10B	3	30	\$16.12
	H44-02NCP	Square corner, 2 ball bearings, NRP	US26	3	30	\$17.74
	H44-02NSS	Square corner, 2 ball bearings, NRP	US32D	3	30	\$40.24
 <p>4" x 4"</p>	0.130" Gauge (each)					
	H44-12NP	¼" radius, 2 ball bearings, NRP	USP	3	30	\$11.20
	H44-12NSB	¼" radius, 2 ball bearings, NRP	US4	3	30	\$12.04
	H44-12NBL	¼" radius, 2 ball bearings, NRP	USL1	3	30	\$14.00
	H44-12NSN	¼" radius, 2 ball bearings, NRP	US15	3	30	\$14.00
	H44-12NSC	¼" radius, 2 ball bearings, NRP	US26D	3	30	\$14.00
	H44-12NOB	¼" radius, 2 ball bearings, NRP	US10B	3	30	\$16.12
	H44-12NCP	¼" radius, 2 ball bearings, NRP	US26	3	30	\$17.74
	H44-12NSS	¼" radius, 2 ball bearings, NRP	US32D	3	30	\$40.24
 <p>4" x 4"</p>	0.130" Gauge (each)					
	H44-02RP	Square corner, 2 ball bearings, removable pin	USP	3	30	\$8.63
	H44-02RSB	Square corner, 2 ball bearings, removable pin	US4	3	30	\$9.28
	H44-02RBL	Square corner, 2 ball bearings, removable pin	USL1	3	30	\$10.79
	H44-02RSN	Square corner, 2 ball bearings, removable pin	US15	3	30	\$10.79
	H44-02RSC	Square corner, 2 ball bearings, removable pin	US26D	3	30	\$10.79
	H44-02ROB	Square corner, 2 ball bearings, removable pin	US10B	3	30	\$12.40
	H44-02RCP	Square corner, 2 ball bearings, removable pin	US26	3	30	\$13.64
	H44-02RSS	Square corner, 2 ball bearings, removable pin	US32D	3	30	\$30.97
 <p>4" x 4"</p>	0.130" Gauge (each)					
	H44-12RP	¼" radius, 2 ball bearings, removable pin	USP	3	30	\$8.63
	H44-12RSB	¼" radius, 2 ball bearings, removable pin	US4	3	30	\$9.28
	H44-12RBL	¼" radius, 2 ball bearings, removable pin	USL1	3	30	\$10.79
	H44-12RSN	¼" radius, 2 ball bearings, removable pin	US15	3	30	\$10.79
	H44-12RSC	¼" radius, 2 ball bearings, removable pin	US26D	3	30	\$10.79
	H44-12ROB	¼" radius, 2 ball bearings, removable pin	US10B	3	30	\$12.40
	H44-12RCP	¼" radius, 2 ball bearings, removable pin	US26	3	30	\$13.64
	H44-12RSS	¼" radius, 2 ball bearings, removable pin	US32D	3	30	\$30.97

3.5" x 3.5"

Model #	Description	Finish	QTY /Box	QTY /Case	List Price
0.130" Gauge					(each)
H35-00RP	Square corner, plain bearings, removable pin	USP	3	30	\$6.09
H35-00RSB	Square corner, plain bearings, removable pin	US4	3	30	\$6.55
H35-00RBL	Square corner, plain bearings, removable pin	USL1	3	30	\$7.64
H35-00RSN	Square corner, plain bearings, removable pin	US15	3	30	\$7.64
H35-00RSC	Square corner, plain bearings, removable pin	US26D	3	30	\$7.64
H35-00ROB	Square corner, plain bearings, removable pin	US10B	3	30	\$8.77
H35-00RCP	Square corner, plain bearings, removable pin	US26	3	30	\$9.66
H35-00RSS	Square corner, plain bearings, removable pin	US32D	3	30	\$21.94

3.5" x 3.5"

Model #	Description	Finish	QTY /Box	QTY /Case	List Price
0.130" Gauge					(each)
H35-10RP	¼" radius, plain bearings, removable pin	USP	3	30	\$6.09
H35-10RSB	¼" radius, plain bearings, removable pin	US4	3	30	\$6.55
H35-10RBL	¼" radius, plain bearings, removable pin	USL1	3	30	\$7.64
H35-10RSN	¼" radius, plain bearings, removable pin	US15	3	30	\$7.64
H35-10RSC	¼" radius, plain bearings, removable pin	US26D	3	30	\$7.64
H35-10ROB	¼" radius, plain bearings, removable pin	US10B	3	30	\$8.77
H35-10RCP	¼" radius, plain bearings, removable pin	US26	3	30	\$9.66
H35-10RSS	¼" radius, plain bearings, removable pin	US32D	3	30	\$21.94



4.5" x 4.5"



Model #	Description	Finish	QTY /Box	QTY /Case	List Price
0.134" Gauge					(each)
H45S-00P	Square corner, UL-Listed, G1	USP	1	30	\$19.40
H45S-00BL	Square corner, UL-Listed, G1	USL1	1	30	\$24.27
H45S-00SN	Square corner, UL-Listed, G1	US15	1	30	\$24.27
H45S-00SC	Square corner, UL-Listed, G1	US26D	1	30	\$24.27
H45S-00OB	Square corner, UL-Listed, G1	US10B	1	30	\$27.89
H45S-00CP	Square corner, UL-Listed, G1	US26	1	30	\$27.89
H45S-00SS	Square corner, UL-Listed, G1	US32D	1	30	\$63.85



4" x 4"





Model #	Description	Finish	QTY /Box	QTY /Case	List Price
0.133" Gauge					(each)
H44S-00P	Square corner, UL-Listed, G1	USP	1	30	\$16.16
H44S-00BL	Square corner, UL-Listed, G1	USL1	1	30	\$20.21
H44S-00SN	Square corner, UL-Listed, G1	US15	1	30	\$20.21
H44S-00SC	Square corner, UL-Listed, G1	US26D	1	30	\$20.21
H44S-00OB	Square corner, UL-Listed, G1	US10B	1	30	\$23.24
H44S-00CP	Square corner, UL-Listed, G1	US26	1	30	\$25.57
H44S-00SS	Square corner, UL-Listed, G1	US32D	1	30	\$58.05





4" x 4"











Model #	Description	Finish	QTY /Box	QTY /Case	List Price
0.133" Gauge					(each)
H44S-10P	1/4" radius, UL-Listed, G1	USP	1	30	\$16.16
H44S-10BL	1/4" radius, UL-Listed, G1	USL1	1	30	\$20.21
H44S-10SN	1/4" radius, UL-Listed, G1	US15	1	30	\$20.21
H44S-10SC	1/4" radius, UL-Listed, G1	US26D	1	30	\$20.21
H44S-10OB	1/4" radius, UL-Listed, G1	US10B	1	30	\$23.24
H44S-10CP	1/4" radius, UL-Listed, G1	US26	1	30	\$25.57
H44S-10SS	1/4" radius, UL-Listed, G1	US32D	1	30	\$58.05

	Model #	Description	Finish	QTY /Box	QTY /Case	List Price
4" x 4" 	0.097" Gauge					(each)
	HR44-10NP	¼" radius, plain bearings, NRP	USP	100	\$4.78	
	HR44-10NSB	¼" radius, plain bearings, NRP	US4	100	\$5.11	
	HR44-10NBL	¼" radius, plain bearings, NRP	USL1	100	\$5.27	
	HR44-10NSN	¼" radius, plain bearings, NRP	US15	100	\$5.27	
	HR44-10NSC	¼" radius, plain bearings, NRP	US26D	100	\$5.27	
	HR44-10NOB	¼" radius, plain bearings, NRP	US10B	100	\$5.64	
	HR44-10NCP	¼" radius, plain bearings, NRP	US26	100	\$6.20	
4" x 4" 	0.097" Gauge					(each)
	HR44-50NP	⅝" radius, plain bearings, NRP	USP	100	\$4.78	
	HR44-50NSB	⅝" radius, plain bearings, NRP	US4	100	\$5.11	
	HR44-50NBL	⅝" radius, plain bearings, NRP	USL1	100	\$5.27	
	HR44-50NSN	⅝" radius, plain bearings, NRP	US15	100	\$5.27	
	HR44-50NSC	⅝" radius, plain bearings, NRP	US26D	100	\$5.27	
	HR44-50NOB	⅝" radius, plain bearings, NRP	US10B	100	\$5.64	
	HR44-50NCP	⅝" radius, plain bearings, NRP	US26	100	\$6.20	
4" x 4" 	0.097" Gauge					(each)
	HR44-10RP	¼" radius, plain bearings, removable pin	USP	100	\$3.67	
	HR44-10RSB	¼" radius, plain bearings, removable pin	US4	100	\$3.96	
	HR44-10RBL	¼" radius, plain bearings, removable pin	USL1	100	\$4.07	
	HR44-10RSN	¼" radius, plain bearings, removable pin	US15	100	\$4.07	
	HR44-10RSC	¼" radius, plain bearings, removable pin	US26D	100	\$4.07	
	HR44-10ROB	¼" radius, plain bearings, removable pin	US10B	100	\$4.33	
	HR44-10RCP	¼" radius, plain bearings, removable pin	US26	100	\$4.76	
4" x 4" 	0.097" Gauge					(each)
	HR44-50RP	⅝" radius, plain bearings, removable pin	USP	100	\$3.67	
	HR44-50RSB	⅝" radius, plain bearings, removable pin	US4	100	\$3.96	
	HR44-50RBL	⅝" radius, plain bearings, removable pin	USL1	100	\$4.07	
	HR44-50RSN	⅝" radius, plain bearings, removable pin	US15	100	\$4.07	
	HR44-50RSC	⅝" radius, plain bearings, removable pin	US26D	100	\$4.07	
	HR44-50ROB	⅝" radius, plain bearings, removable pin	US10B	100	\$4.33	
	HR44-50RCP	⅝" radius, plain bearings, removable pin	US26	100	\$4.76	

	Model #	Description	Finish	QTY /Box	QTY /Case	List Price
 <p>4" x 4"</p>	0.097" Gauge					(each)
	HR44-12RP	¼" radius, 2 ball bearings, removable pin	USP		100	\$4.00
	HR44-12RSB	¼" radius, 2 ball bearings, removable pin	US4		100	\$4.31
	HR44-12RBL	¼" radius, 2 ball bearings, removable pin	USL1		100	\$4.42
	HR44-12RSN	¼" radius, 2 ball bearings, removable pin	US15		100	\$4.42
	HR44-12RSC	¼" radius, 2 ball bearings, removable pin	US26D		100	\$4.42
	HR44-12ROB	¼" radius, 2 ball bearings, removable pin	US10B		100	\$4.97
	HR44-12RCP	¼" radius, 2 ball bearings, removable pin	US26		100	\$5.47
 <p>4" x 4"</p>	0.097" Gauge					(each)
	HR44-52RP	⅝" radius, 2 ball bearings, removable pin	USP		100	\$4.00
	HR44-52RSB	⅝" radius, 2 ball bearings, removable pin	US4		100	\$4.31
	HR44-52RBL	⅝" radius, 2 ball bearings, removable pin	USL1		100	\$4.42
	HR44-52RSN	⅝" radius, 2 ball bearings, removable pin	US15		100	\$4.42
	HR44-52RSC	⅝" radius, 2 ball bearings, removable pin	US26D		100	\$4.42
	HR44-52ROB	⅝" radius, 2 ball bearings, removable pin	US10B		100	\$4.97
	HR44-52RCP	⅝" radius, 2 ball bearings, removable pin	US26		100	\$5.47
 <p>4" x 4"</p>	0.110" Gauge					(each)
	HR44S-10P	Spring Hinge, ¼" radius, UL Listed	USP	1	30	\$19.20
	HR44S-10SB	Spring Hinge, ¼" radius, UL Listed	US4	1	30	\$20.64
	HR44S-10BL	Spring Hinge, ¼" radius, UL Listed	USL1	1	30	\$21.11
	HR44S-10SN	Spring Hinge, ¼" radius, UL Listed	US15	1	30	\$21.11
	HR44S-10SC	Spring Hinge, ¼" radius, UL Listed	US26D	1	30	\$21.11
	HR44S-10OB	Spring Hinge, ¼" radius, UL Listed	US10B	1	30	\$24.28
	HR44S-10CP	Spring Hinge, ¼" radius, UL Listed	US26	1	30	\$26.71
 <p>4" x 4"</p>	0.110" Gauge					(each)
	HR44S-50P	Spring Hinge, ⅝" radius, UL Listed	USP	1	30	\$19.20
	HR44S-50SB	Spring Hinge, ⅝" radius, UL Listed	US4	1	30	\$20.64
	HR44S-50BL	Spring Hinge, ⅝" radius, UL Listed	USL1	1	30	\$21.11
	HR44S-50SN	Spring Hinge, ⅝" radius, UL Listed	US15	1	30	\$21.11
	HR44S-50SC	Spring Hinge, ⅝" radius, UL Listed	US26D	1	30	\$21.11
	HR44S-50OB	Spring Hinge, ⅝" radius, UL Listed	US10B	1	30	\$24.28
	HR44S-50CP	Spring Hinge, ⅝" radius, UL Listed	US26	1	30	\$26.71

	Model #	Description	Finish	QTY /Box	QTY /Case	List Price
3.5" x 3.5" 	0.087" Gauge					(each)
	HR35-10RP	1/4" radius, plain bearings, removable pin	USP	100	100	\$2.58
	HR35-10RSB	1/4" radius, plain bearings, removable pin	US4	100	100	\$2.80
	HR35-10RBL	1/4" radius, plain bearings, removable pin	USL1	100	100	\$2.82
	HR35-10RSN	1/4" radius, plain bearings, removable pin	US15	100	100	\$2.82
	HR35-10RSC	1/4" radius, plain bearings, removable pin	US26D	100	100	\$2.82
	HR35-10ROB	1/4" radius, plain bearings, removable pin	US10B	100	100	\$3.13
	HR35-10RCP	1/4" radius, plain bearings, removable pin	US26	100	100	\$3.44

3.5" x 3.5" 	0.087" Gauge					(each)
	HR35-50RP	5/8" radius, plain bearings, removable pin	USP	100	100	\$2.58
	HR35-50RSB	5/8" radius, plain bearings, removable pin	US4	100	100	\$2.80
	HR35-50RBL	5/8" radius, plain bearings, removable pin	USL1	100	100	\$2.82
	HR35-50RSN	5/8" radius, plain bearings, removable pin	US15	100	100	\$2.82
	HR35-50RSC	5/8" radius, plain bearings, removable pin	US26D	100	100	\$2.82
	HR35-50ROB	5/8" radius, plain bearings, removable pin	US10B	100	100	\$3.13
	HR35-50RCP	5/8" radius, plain bearings, removable pin	US26	100	100	\$3.44

Model #	Description	Finish	QTY /Case	List Price	
(price per bag, 100 pieces/bag, sold per bag only)					
Steel Machine Screws For 4.5" x 4.5" and 4" x 4" Commercial Hinges					
	HMS-122412P	12-24 x 1/2" Flat Head Machine Screws	USP	4,000	\$12.77
	HMS-122412SB	12-24 x 1/2" Flat Head Machine Screws	US4	4,000	\$12.77
	HMS-122412BL	12-24 x 1/2" Flat Head Machine Screws	USL1	4,000	\$12.77
	HMS-122412SN	12-24 x 1/2" Flat Head Machine Screws	US15	4,000	\$12.77
	HMS-122412CP	12-24 x 1/2" Flat Head Machine Screws	US26	4,000	\$12.77
	HMS-122412SS	12-24 x 1/2" Flat Head Machine Screws	US32D	4,000	\$38.30
(price per bag, 100 pieces/bag, sold per bag only)					
Steel Wood Screws For 4.5" x 4.5" Commercial Hinges					
	HWS-12114P	#12 x 1-1/4" Flat Head Wood Screws	USP	4,000	\$19.15
	HWS-12114SB	#12 x 1-1/4" Flat Head Wood Screws	US4	4,000	\$19.15
	HWS-12114BL	#12 x 1-1/4" Flat Head Wood Screws	USL1	4,000	\$19.15
	HWS-12114SN	#12 x 1-1/4" Flat Head Wood Screws	US15	4,000	\$19.15
	HWS-12114CP	#12 x 1-1/4" Flat Head Wood Screws	US26	4,000	\$19.15
	HWS-12114SS	#12 x 1-1/4" Flat Head Wood Screws	US32D	4,000	\$57.45
(price per bag, 100 pieces/bag, sold per bag only)					
Steel Wood Screws For 4" x 4" Commercial Hinges					
	HWS-1210P	#12 x 1" Flat Head Wood Screws	USP	4,000	\$19.15
	HWS-1210SB	#12 x 1" Flat Head Wood Screws	US4	4,000	\$19.15
	HWS-1210BL	#12 x 1" Flat Head Wood Screws	USL1	4,000	\$19.15
	HWS-1210SN	#12 x 1" Flat Head Wood Screws	US15	4,000	\$19.15
	HWS-1210CP	#12 x 1" Flat Head Wood Screws	US26	4,000	\$19.15
	HWS-1210SS	#12 x 1" Flat Head Wood Screws	US32D	4,000	\$57.45
(price per bag, 100 pieces/bag, sold per bag only)					
Steel Machine Screws For 3.5" x 3.5" Commercial Hinges / 4" x 4" Residential Spring Hinges					
	HMS-1012P	10-24 #10 x 1/2" Flat Head Machine Screws	USP	4,000	\$12.77
	HMS-1012SB	10-24 #10 x 1/2" Flat Head Machine Screws	US4	4,000	\$12.77
	HMS-1012BL	10-24 #10 x 1/2" Flat Head Machine Screws	USL1	4,000	\$12.77
	HMS-1012SN	10-24 #10 x 1/2" Flat Head Machine Screws	US15	4,000	\$12.77
	HMS-1012CP	10-24 #10 x 1/2" Flat Head Machine Screws	US26	4,000	\$12.77
	HMS-1012SS	10-24 #10 x 1/2" Flat Head Machine Screws	US32D	4,000	\$38.30
(price per bag, 100 pieces/bag, sold per bag only)					
Steel Wood Screws For 3.5" x 3.5" Commercial Hinges / 4" x 4" Residential Spring Hinges					
	HWS-1010P	#10 x 1" Flat Head Wood Screws	USP	4,000	\$12.77
	HWS-1010SB	#10 x 1" Flat Head Wood Screws	US4	4,000	\$12.77
	HWS-1010BL	#10 x 1" Flat Head Wood Screws	USL1	4,000	\$12.77
	HWS-1010SN	#10 x 1" Flat Head Wood Screws	US15	4,000	\$12.77
	HWS-1010CP	#10 x 1" Flat Head Wood Screws	US26	4,000	\$12.77
	HWS-1010SS	#10 x 1" Flat Head Wood Screws	US32D	4,000	\$38.30
(price per bag, 100 pieces/bag, sold per bag only)					
Steel Wood Screws For 4" x 4" Residential Hinges					
	HWS-910P	#9 x 1" Flat Head Wood Screws	USP	4,000	\$12.77
	HWS-910SB	#9 x 1" Flat Head Wood Screws	US4	4,000	\$12.77
	HWS-910BL	#9 x 1" Flat Head Wood Screws	USL1	4,000	\$12.77
	HWS-910SN	#9 x 1" Flat Head Wood Screws	US15	4,000	\$12.77
	HWS-910CP	#9 x 1" Flat Head Wood Screws	US26	4,000	\$12.77
(price per bag, 100 pieces/bag, sold per bag only)					
Steel Wood Screws For 3.5" x 3.5" Residential Hinges					
	HWS-934P	#9 x 3/4" Flat Head Wood Screws	USP	4,000	\$10.64
	HWS-934SB	#9 x 3/4" Flat Head Wood Screws	US4	4,000	\$10.64
	HWS-934BL	#9 x 3/4" Flat Head Wood Screws	USL1	4,000	\$10.64
	HWS-934SN	#9 x 3/4" Flat Head Wood Screws	US15	4,000	\$10.64
	HWS-934CP	#9 x 3/4" Flat Head Wood Screws	US26	4,000	\$10.64

Full Mortise



(each)

Model #	Description	Finish	QTY /Box	QTY /Case	List Price
HCFM110-83AL	Full Mortise Continuous Geared Hinge, 83"	Clear	1	10	\$274.54
HCFM110-83DB	Full Mortise Continuous Geared Hinge, 83"	DB	1	10	\$329.44
HCFM110-95AL	Full Mortise Continuous Geared Hinge, 95"	Clear	1	10	\$315.72
HCFM110-95DB	Full Mortise Continuous Geared Hinge, 95"	DB	1	10	\$377.49

*Oversized item for UPS shipping. Extra handling charge may apply.

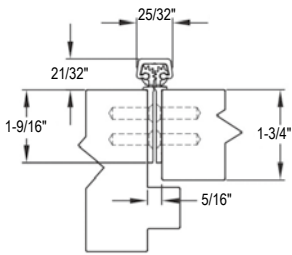

Full Surface



(each)

Model #	Description	Finish	QTY /Box	QTY /Case	List Price
HCFS570-83AL	Full Surface Continuous Geared Hinge, 1/16" Inset, 83"	Clear	1	10	\$343.17
HCFS570-83DB	Full Surface Continuous Geared Hinge, 1/16" Inset, 83"	DB	1	10	\$411.81
HCFS570-95AL	Full Surface Continuous Geared Hinge, 1/16" Inset, 95"	Clear	1	10	\$395.79
HCFS570-95DB	Full Surface Continuous Geared Hinge, 1/16" Inset, 95"	DB	1	10	\$471.29

*Oversized item for UPS shipping. Extra handling charge may apply.

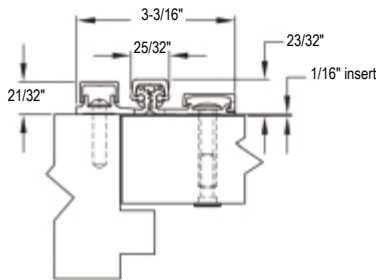



MS Series

**YT Lever
(Sectional Trim)**





*Case shown as with deadbolt

Model #	Function	ANSI	Finish	QTY /Case	Lbs /Case	List Price
  						
Single Cylinder without Deadbolt						
MS-YTS07	Storeroom	F07	US26D	6	36	\$452.99
MS-YTS05	Classroom	F05	US26D	6	36	\$452.99
MS-YTS04	Office / Entry	F04	US26D	6	36	\$452.99
Single Cylinder with Deadbolt						
MS-YTS21	Dormitory / Bedroom	F21	US26D	6	36	\$485.01
MS-YTS13	Corridor	F13	US26D	6	36	\$485.01
MS-YTS20	Entrance	F20	US26D	6	36	\$485.01
Double Cylinder without Deadbolt						
MS-YTS09	Apartment Entrance	F09	US26D	6	36	\$498.74
MS-YTS30	Institution	F30	US26D	6	36	\$498.74
Double Cylinder with Deadbolt						
MS-YTS14	Store / Utility Room	F14	US26D	6	36	\$523.91
Passage						
MS-YTS01	Passage	F01	US26D	6	36	\$370.62

**YM Lever
(Sectional Trim)**



*Case shown as with deadbolt

Model #	Function	ANSI	Finish	QTY /Case	Lbs /Case	List Price
  						
Single Cylinder without Deadbolt						
MS-YMS07	Storeroom	F07	US26D	6	36	\$452.99
MS-YMS05	Classroom	F05	US26D	6	36	\$452.99
MS-YMS04	Office / Entry	F04	US26D	6	36	\$452.99
Single Cylinder with Deadbolt						
MS-YMS21	Dormitory / Bedroom	F21	US26D	6	36	\$485.01
MS-YMS13	Corridor	F13	US26D	6	36	\$485.01
MS-YMS20	Entrance	F20	US26D	6	36	\$485.01
Double Cylinder without Deadbolt						
MS-YMS09	Apartment Entrance	F09	US26D	6	36	\$498.74
MS-YMS30	Institution	F30	US26D	6	36	\$498.74
Double Cylinder with Deadbolt						
MS-YMS14	Store / Utility Room	F14	US26D	6	36	\$523.91
Passage						
MS-YMS01	Passage	F01	US26D	6	36	\$370.62

MS Series

YH Lever
(Sectional Trim)



*Case shown as with deadbolt

Model #	Function	ANSI	Finish	QTY /Case	Lbs /Case	List Price
---------	----------	------	--------	-----------	-----------	------------

Single Cylinder without Deadbolt

MS-YHS07	Storeroom	F07	US26D	6	36	\$452.99
MS-YHS05	Classroom	F05	US26D	6	36	\$452.99
MS-YHS04	Office / Entry	F04	US26D	6	36	\$452.99

Single Cylinder with Deadbolt

MS-YHS21	Dormitory / Bedroom	F21	US26D	6	36	\$485.01
MS-YHS13	Corridor	F13	US26D	6	36	\$485.01
MS-YHS20	Entrance	F20	US26D	6	36	\$485.01

Double Cylinder without Deadbolt

MS-YHS09	Apartment Entrance	F09	US26D	6	36	\$498.74
MS-YHS30	Institution	F30	US26D	6	36	\$498.74

Double Cylinder with Deadbolt

MS-YHS14	Store / Utility Room	F14	US26D	6	36	\$523.91
-----------------	----------------------	-----	-------	---	----	----------

Passage

MS-YHS01	Passage	F01	US26D	6	36	\$370.62
-----------------	---------	-----	-------	---	----	----------

YR Lever
(Sectional Trim)



*Case shown as with deadbolt

Single Cylinder without Deadbolt

MS-YRS07	Storeroom	F07	US26D	6	36	\$452.99
MS-YRS05	Classroom	F05	US26D	6	36	\$452.99
MS-YRS04	Office / Entry	F04	US26D	6	36	\$452.99

Single Cylinder with Deadbolt

MS-YRS21	Dormitory / Bedroom	F21	US26D	6	36	\$485.01
MS-YRS13	Corridor	F13	US26D	6	36	\$485.01
MS-YRS20	Entrance	F20	US26D	6	36	\$485.01

Double Cylinder without Deadbolt

MS-YRS09	Apartment Entrance	F09	US26D	6	36	\$498.74
MS-YRS30	Institution	F30	US26D	6	36	\$498.74

Double Cylinder with Deadbolt

MS-YRS14	Store / Utility Room	F14	US26D	6	36	\$523.91
-----------------	----------------------	-----	-------	---	----	----------

Passage



MS-YRS01	Passage	F01	US26D	6	36	\$370.62
-----------------	---------	-----	-------	---	----	----------

MS Series

EYT Lever
(Escutcheon Plate Trim)





*Case shown as with deadbolt

Model #	Function	ANSI	Finish	QTY /Case	Lbs /Case	List Price
  						
Single Cylinder without Deadbolt						
MS-EYTS07	Storeroom	F07	US26D	6	36	\$544.50
MS-EYTS05	Classroom	F05	US26D	6	36	\$544.50
MS-EYTS04	Office / Entry	F04	US26D	6	36	\$544.50
Single Cylinder with Deadbolt						
MS-EYTS21	Dormitory / Bedroom	F21	US26D	6	36	\$581.10
MS-EYTS13	Corridor	F13	US26D	6	36	\$581.10
MS-EYTS20	Entrance	F20	US26D	6	36	\$581.10
Double Cylinder without Deadbolt						
MS-EYTS09	Apartment Entrance	F09	US26D	6	36	\$599.41
MS-EYTS30	Institution	F30	US26D	6	36	\$599.41
Double Cylinder with Deadbolt						
MS-EYTS14	Store / Utility Room	F14	US26D	6	36	\$626.86
Passage						
MS-EYTS01	Passage	F01	US26D	6	36	\$443.83

EYM Lever
(Escutcheon Plate Trim)





*Case shown as with deadbolt

Model #	Function	ANSI	Finish	QTY /Case	Lbs /Case	List Price
  						
Single Cylinder without Deadbolt						
MS-EYMS07	Storeroom	F07	US26D	6	36	\$544.50
MS-EYMS05	Classroom	F05	US26D	6	36	\$544.50
MS-EYMS04	Office / Entry	F04	US26D	6	36	\$544.50
Single Cylinder with Deadbolt						
MS-EYMS21	Dormitory / Bedroom	F21	US26D	6	36	\$581.10
MS-EYMS13	Corridor	F13	US26D	6	36	\$581.10
MS-EYMS20	Entrance	F20	US26D	6	36	\$581.10
Double Cylinder without Deadbolt						
MS-EYMS09	Apartment Entrance	F09	US26D	6	36	\$599.41
MS-EYMS30	Institution	F30	US26D	6	36	\$599.41
Double Cylinder with Deadbolt						
MS-EYMS14	Store / Utility Room	F14	US26D	6	36	\$626.86
Passage						
MS-EYMS01	Passage	F01	US26D	6	36	\$443.83

MS Series

EYH Lever
(Escutcheon Plate Trim)



Model #	Function	ANSI	Finish	QTY /Case	Lbs /Case	List Price
  						

Single Cylinder without Deadbolt

MS-EYHS07	Storeroom	F07	US26D	6	36	\$544.50
MS-EYHS05	Classroom	F05	US26D	6	36	\$544.50
MS-EYHS04	Office / Entry	F04	US26D	6	36	\$544.50

Single Cylinder with Deadbolt

MS-EYHS21	Dormitory / Bedroom	F21	US26D	6	36	\$581.10
MS-EYHS13	Corridor	F13	US26D	6	36	\$581.10
MS-EYHS20	Entrance	F20	US26D	6	36	\$581.10

Double Cylinder without Deadbolt

MS-EYHS09	Apartment Entrance	F09	US26D	6	36	\$599.41
MS-EYHS30	Institution	F30	US26D	6	36	\$599.41

Double Cylinder with Deadbolt

MS-EYHS14	Store / Utility Room	F14	US26D	6	36	\$626.86
------------------	----------------------	-----	-------	---	----	----------

Passage

MS-EYHS01	Passage	F01	US26D	6	36	\$443.83
------------------	---------	-----	-------	---	----	----------

*Case shown as with deadbolt

EYR Lever
(Escutcheon Plate Trim)



  						
---	--	--	--	--	--	--

Single Cylinder without Deadbolt

MS-EYRS07	Storeroom	F07	US26D	6	36	\$544.50
MS-EYRS05	Classroom	F05	US26D	6	36	\$544.50
MS-EYRS04	Office / Entry	F04	US26D	6	36	\$544.50

Single Cylinder with Deadbolt

MS-EYRS21	Dormitory / Bedroom	F21	US26D	6	36	\$581.10
MS-EYRS13	Corridor	F13	US26D	6	36	\$581.10
MS-EYRS20	Entrance	F20	US26D	6	36	\$581.10

Double Cylinder without Deadbolt

MS-EYRS09	Apartment Entrance	F09	US26D	6	36	\$599.41
MS-EYRS30	Institution	F30	US26D	6	36	\$599.41

Double Cylinder with Deadbolt

MS-EYRS14	Store / Utility Room	F14	US26D	6	36	\$626.86
------------------	----------------------	-----	-------	---	----	----------

Passage

MS-EYRS01	Passage	F01	US26D	6	36	\$443.83
------------------	---------	-----	-------	---	----	----------

*Case shown as with deadbolt

MS Series

Deadbolt



Short Deadbolt

Model #	Function	ANSI	Finish	QTY /Case	Lbs /Case	List Price
MSD-DS17	Cylinder and Thumbturn	F17	US26D	6	24	\$212.77
MSD-DS18	Cylinder Lock	F18	US26D	6	24	\$199.04
MSD-DS16	Double Cylinder	F16	US26D	6	24	\$233.36

1-1/8" Length



MS05/MCSC-AL	SC 6-pin Mortise Cylinder		US26D	40	30	\$37.32
MS05/MCKW-AL	KW 5-pin Mortise Cylinder		US26D	40	30	\$37.32
• MS05/MCD-AL	I/C Core Mortise Cylinder (w/o cylinder)		US26D	40	30	\$65.33
MS07/MCSC-AL	SC 6-pin Mortise Cylinder		US26D	40	30	\$37.32
MS07/MCKW-AL	KW 5-pin Mortise Cylinder		US26D	40	30	\$37.32
• MS07/MCD-AL	I/C Core Mortise Cylinder (w/o cylinder)		US26D	40	30	\$65.33

NOTE: OTHER FINISHES AND FUNCTIONS ARE AVAILABLE WITH FACTORY LEAD-TIME AND SUBJECT TO MINIMUM ORDER.

ANNAPOLIS

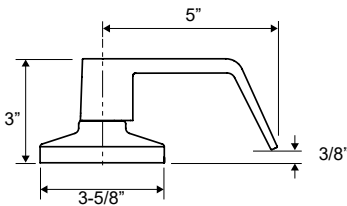

Latch: 1-1/8"x2-1/4" square corner, 2-3/4" backset, UL
Strike: FASA: 1-1/4"x4-7/8", square corner

Model #	Function	Finish	QTY /Case	Lbs /Case	List Price
FYT00C	Entry	US10B	6	32	\$317.52
FYT01C	Privacy	US10B	6	31	\$292.45
FYT03C	Passage	US10B	6	30	\$285.53
FYT04C	Half Dummy Trim	US10B	12	23	\$107.97
FYT05C	Storeroom	US10B	6	32	\$323.03
FYT08C	Classroom	US10B	6	32	\$323.03
FYT0CC	Communicating room	US10B	6	32	\$387.62
• FYT00D	I/C Core Entry (w/o IC core)	US10B	6	32	\$317.52
• FYT05D	I/C Core Storeroom (w/o IC core)	US10B	6	32	\$323.03
• FYT08D	I/C Core Classroom (w/o IC core)	US10B	6	32	\$323.03
• FYT0CD	I/C Core Communicating room (w/o IC core)	US10B	6	32	\$387.62
<hr/>					
FYT90C	Entry	US19	6	32	\$317.52
FYT91C	Privacy	US19	6	31	\$292.45
FYT93C	Passage	US19	6	30	\$285.53
FYT94C	Half Dummy Trim	US19	12	23	\$107.97
FYT95C	Storeroom	US19	6	32	\$323.03
FYT98C	Classroom	US19	6	32	\$323.03
FYT9CC	Communicating room	US19	6	32	\$387.62
• FYT90D	I/C Core Entry (w/o IC core)	US19	6	32	\$317.52
• FYT95D	I/C Core Storeroom (w/o IC core)	US19	6	32	\$323.03
• FYT98D	I/C Core Classroom (w/o IC core)	US19	6	32	\$323.03
• FYT9CD	I/C Core Communicating room (w/o IC core)	US19	6	32	\$387.62
<hr/>					
FYTP0C	Entry	US15	6	32	\$288.65
FYTP1C	Privacy	US15	6	31	\$265.87
FYTP3C	Passage	US15	6	30	\$259.59
FYTP4C	Half Dummy Trim	US15	12	23	\$98.15
FYTP5C	Storeroom	US15	6	32	\$293.66
FYTP8C	Classroom	US15	6	32	\$293.66
FYTPCC	Communicating room	US15	6	32	\$352.40
• FYTP0D	I/C Core Entry (w/o IC core)	US15	6	32	\$288.65
• FYTP5D	I/C Core Storeroom (w/o IC core)	US15	6	32	\$293.66
• FYTP8D	I/C Core Classroom (w/o IC core)	US15	6	32	\$293.66
• FYTPCD	I/C Core Communicating room (w/o IC core)	US15	6	32	\$352.40
<hr/>					
FYTS0C	Entry	US26D	6	32	\$288.65
FYTS1C	Privacy	US26D	6	31	\$265.87
FYTS3C	Passage	US26D	6	30	\$259.59
FYTS4C	Half Dummy Trim	US26D	12	23	\$98.15
FYTS5C	Storeroom	US26D	6	32	\$293.66
FYTS8C	Classroom	US26D	6	32	\$293.66
FYTS0D	I/C Core Entry (w/o IC core)	US26D	6	32	\$288.65
• FYTS5D	I/C Core Storeroom (w/o IC core)	US26D	6	32	\$293.66
• FYTS8D	I/C Core Classroom (w/o IC core)	US26D	6	32	\$293.66
• FYTSCD	I/C Core Communicating room (w/o IC core)	US26D	6	32	\$352.40

PENDLETON

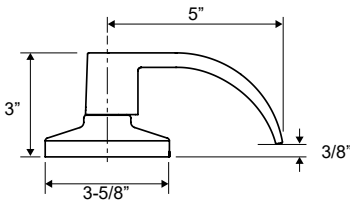

Latch: 1-1/8"x2-1/4" square corner, 2-3/4" backset, UL
Strike: FASA: 1-1/4"x4-7/8", square corner

Model #	Function	Finish	QTY /Case	Lbs /Case	List Price
FYM00C	Entry	US10B	6	32	\$317.52
FYM01C	Privacy	US10B	6	31	\$292.45
FYM03C	Passage	US10B	6	30	\$285.53
FYM04C	Half Dummy Trim	US10B	12	23	\$107.97
FYM05C	Storeroom	US10B	6	32	\$323.03
FYM08C	Classroom	US10B	6	32	\$323.03
FYM0CC	Communicating room	US10B	6	32	\$387.62
• FYM00D	I/C Core Entry (w/o IC core)	US10B	6	32	\$317.52
• FYM05D	I/C Core Storeroom (w/o IC core)	US10B	6	32	\$323.03
• FYM08D	I/C Core Classroom (w/o IC core)	US10B	6	32	\$323.03
• FYM0CD	I/C Core Communicating room (w/o IC core)	US10B	6	32	\$387.62
<hr/>					
FYMP0C	Entry	US15	6	32	\$288.65
FYMP1C	Privacy	US15	6	31	\$265.87
FYMP3C	Passage	US15	6	30	\$259.59
FYMP4C	Half Dummy Trim	US15	12	32	\$98.15
FYMP5C	Storeroom	US15	6	32	\$293.66
FYMP8C	Classroom	US15	6	32	\$293.66
FYMPCC	Communicating room	US15	6	32	\$352.40
• FYMP0D	I/C Core Entry (w/o IC core)	US15	6	32	\$288.65
• FYMP5D	I/C Core Storeroom (w/o IC core)	US15	6	32	\$293.66
• FYMP8D	I/C Core Classroom (w/o IC core)	US15	6	32	\$293.66
• FYMPCD	I/C Core Communicating room (w/o IC core)	US15	6	32	\$352.40
<hr/>					
FYMS0C	Entry	US26D	6	32	\$288.65
FYMS1C	Privacy	US26D	6	31	\$265.87
FYMS3C	Passage	US26D	6	30	\$259.59
FYMS4C	Half Dummy Trim	US26D	12	23	\$98.15
FYMS5C	Storeroom	US26D	6	32	\$293.66
FYMS8C	Classroom	US26D	6	32	\$293.66
FYMSCC	Communicating room	US26D	6	32	\$352.40
• FYMS0D	I/C Core Entry (w/o IC core)	US26D	6	32	\$288.65
• FYMS5D	I/C Core Storeroom (w/o IC core)	US26D	6	32	\$293.66
• FYMS8D	I/C Core Classroom (w/o IC core)	US26D	6	32	\$293.66
• FYMSCD	I/C Core Communicating room (w/o IC core)	US26D	6	32	\$352.40

NOTE: Cylindrical locks have quick-release function and pushbutton locking.

ALAMEDA

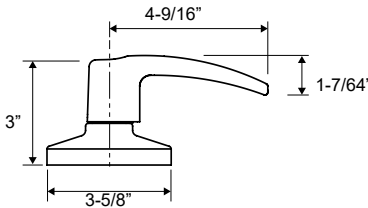

Latch: 1-1/8"x2-1/4" square corner, 2-3/4" backset, UL
Strike: FASA: 1-1/4"x4-7/8", square corner

Model #	Function	Finish	QTY /Case	Lbs /Case	List Price
FYH00C	Entry	US10B	6	32	\$317.52
FYH01C	Privacy	US10B	6	31	\$292.45
FYH03C	Passage	US10B	6	30	\$285.53
FYH04C	Half Dummy Trim	US10B	12	23	\$107.97
FYH05C	Storeroom	US10B	6	32	\$323.03
FYH08C	Classroom	US10B	6	32	\$323.03
FYH0CC	Communicating room	US10B	6	32	\$387.62
• FYH00D	I/C Core Entry (w/o IC core)	US10B	6	32	\$317.52
• FYH05D	I/C Core Storeroom (w/o IC core)	US10B	6	32	\$323.03
• FYH08D	I/C Core Classroom (w/o IC core)	US10B	6	32	\$323.03
• FYH0CD	I/C Core Communicating room (w/o IC core)	US10B	6	32	\$387.62
<hr/>					
FYHP0C	Entry	US15	6	32	\$288.65
FYHP1C	Privacy	US15	6	31	\$265.87
FYHP3C	Passage	US15	6	30	\$259.59
FYHP4C	Half Dummy Trim	US15	12	32	\$98.15
FYHP5C	Storeroom	US15	6	32	\$293.66
FYHP8C	Classroom	US15	6	32	\$293.66
FYHPCC	Communicating room	US15	6	32	\$352.40
• FYHP0D	I/C Core Entry (w/o IC core)	US15	6	32	\$288.65
• FYHP5D	I/C Core Storeroom (w/o IC core)	US15	6	32	\$293.66
• FYHP8D	I/C Core Classroom (w/o IC core)	US15	6	32	\$293.66
• FYHPCD	I/C Core Communicating room (w/o IC core)	US15	6	32	\$352.40
<hr/>					
FYHS0C	Entry	US26D	6	32	\$288.65
FYHS1C	Privacy	US26D	6	31	\$265.87
FYHS3C	Passage	US26D	6	30	\$259.59
FYHS4C	Half Dummy Trim	US26D	12	23	\$98.15
FYHS5C	Storeroom	US26D	6	32	\$293.66
FYHS8C	Classroom	US26D	6	32	\$293.66
FYHSCC	Communicating room	US26D	6	32	\$352.40
• FYHS0D	I/C Core Entry (w/o IC core)	US26D	6	32	\$288.65
• FYHS5D	I/C Core Storeroom (w/o IC core)	US26D	6	32	\$293.66
• FYHS8D	I/C Core Classroom (w/o IC core)	US26D	6	32	\$293.66
• FYHSCD	I/C Core Communicating room (w/o IC core)	US26D	6	32	\$352.40

NOTE: Cylindrical locks have quick-release function and pushbutton locking.

ANNAPOLIS



Model #	Function	Finish	QTY /Case	Lbs /Case	List Price
FYT05CE-SA	Electrified Fail-Safe Leverset	US10B	6	33	\$800.92
FYT95CE-SA	Electrified Fail-Safe Leverset	US19	6	33	\$800.92
FYTP5CE-SA	Electrified Fail-Safe Leverset	US15	6	33	\$772.91
FYTS5CE-SA	Electrified Fail-Safe Leverset	US26D	6	33	\$772.91
FYT05DE-SA	Electrified IC Fail-Safe Leverset (w/o IC core)	US10B	6	33	\$800.92
FYT95DE-SA	Electrified IC Fail-Safe Leverset (w/o IC core)	US19	6	33	\$800.92
FYTP5DE-SA	Electrified IC Fail-Safe Leverset (w/o IC core)	US15	6	33	\$772.91
FYTS5DE-SA	Electrified IC Fail-Safe Leverset (w/o IC core)	US26D	6	33	\$772.91
FYT05CE-SE	Electrified Fail-Secure Leverset	US10B	6	33	\$800.92
FYT95CE-SE	Electrified Fail-Secure Leverset	US19	6	33	\$800.92
FYTP5CE-SE	Electrified Fail-Secure Leverset	US15	6	33	\$772.91
FYTS5CE-SE	Electrified Fail-Secure Leverset	US26D	6	33	\$772.91
FYT05DE-SE	Electrified IC Fail-Secure Leverset (w/o IC core)	US10B	6	33	\$800.92
FYT95DE-SE	Electrified IC Fail-Secure Leverset (w/o IC core)	US19	6	33	\$800.92
FYTP5DE-SE	Electrified IC Fail-Secure Leverset (w/o IC core)	US15	6	33	\$772.91
FYTS5DE-SE	Electrified IC Fail-Secure Leverset (w/o IC core)	US26D	6	33	\$772.91

PENDLETON



Model #	Function	Finish	QTY /Case	Lbs /Case	List Price
FYM05CE-SA	Electrified Fail-Safe Leverset	US10B	6	33	\$800.92
FYMP5CE-SA	Electrified Fail-Safe Leverset	US15	6	33	\$772.91
FYMS5CE-SA	Electrified Fail-Safe Leverset	US26D	6	33	\$772.91
FYM05DE-SA	Electrified IC Fail-Safe Leverset (w/o IC core)	US10B	6	33	\$800.92
FYMP5DE-SA	Electrified IC Fail-Safe Leverset (w/o IC core)	US15	6	33	\$772.91
FYMS5DE-SA	Electrified IC Fail-Safe Leverset (w/o IC core)	US26D	6	33	\$772.91
FYM05CE-SE	Electrified Fail-Secure Leverset	US10B	6	33	\$800.92
FYMP5CE-SE	Electrified Fail-Secure Leverset	US15	6	33	\$772.91
FYMS5CE-SE	Electrified Fail-Secure Leverset	US26D	6	33	\$772.91
FYM05DE-SE	Electrified IC Fail-Secure Leverset (w/o IC core)	US10B	6	33	\$800.92
FYMP5DE-SE	Electrified IC Fail-Secure Leverset (w/o IC core)	US15	6	33	\$772.91
FYMS5DE-SE	Electrified IC Fail-Secure Leverset (w/o IC core)	US26D	6	33	\$772.91

ALAMEDA



Model #	Function	Finish	QTY /Case	Lbs /Case	List Price
FYH05CE-SA	Electrified Fail-Safe Leverset	US10B	6	33	\$800.92
FYHS5CE-SA	Electrified Fail-Safe Leverset	US26D	6	33	\$772.91
FYHP5CE-SA	Electrified Fail-Safe Leverset	US15	6	33	\$772.91
FYH05DE-SA	Electrified IC Fail-Safe Leverset (w/o IC core)	US10B	6	33	\$800.92
FYHS5DE-SA	Electrified IC Fail-Safe Leverset (w/o IC core)	US26D	6	33	\$772.91
FYHP5DE-SA	Electrified IC Fail-Safe Leverset (w/o IC core)	US15	6	33	\$772.91
FYH05CE-SE	Electrified Fail-Secure Leverset	US10B	6	33	\$800.92
FYHS5CE-SE	Electrified Fail-Secure Leverset	US26D	6	33	\$772.91
FYHP5CE-SE	Electrified Fail-Secure Leverset	US15	6	33	\$772.91
FYH05DE-SE	Electrified IC Fail-Secure Leverset (w/o IC core)	US10B	6	33	\$800.92
FYHS5DE-SE	Electrified IC Fail-Secure Leverset (w/o IC core)	US26D	6	33	\$772.91
FYHP5DE-SE	Electrified IC Fail-Secure Leverset (w/o IC core)	US15	6	33	\$772.91

**GRADE 1 DEADBOLTS
FDP SERIES**

Model #	Function	Finish	QTY /Case	Lbs /Case	List Price
---------	----------	--------	-----------	-----------	------------



FDP01	Single Cylinder	US10B	24	50	\$113.60
FDP91	Single Cylinder	US19	24	50	\$113.60
FDPP1	Single Cylinder	US15	24	50	\$103.28
FDPS1	Single Cylinder	US26D	24	50	\$103.28

• FDP0A	I/C Core Single Cylinder (w/o IC core)	US10B	24	47	\$113.60
• FDP9A	I/C Core Single Cylinder (w/o IC core)	US19	24	47	\$113.60
• FDPPA	I/C Core Single Cylinder (w/o IC core)	US15	24	47	\$103.28
• FDPSA	I/C Core Single Cylinder (w/o IC core)	US26D	24	47	\$103.28

FDP02	Double Cylinder	US10B	24	69	\$147.24
FDP92	Double Cylinder	US19	24	69	\$147.24
FDPP2	Double Cylinder	US15	24	69	\$133.86
FDPS2	Double Cylinder	US26D	24	69	\$133.86

• FDP0B	I/C Core Double Cylinder (w/o IC core)	US10B	24	47	\$147.24
• FDP9B	I/C Core Double Cylinder (w/o IC core)	US19	24	47	\$147.24
• FDPPB	I/C Core Double Cylinder (w/o IC core)	US15	24	47	\$133.86
• FDPSB	I/C Core Double Cylinder (w/o IC core)	US26D	24	47	\$133.86

FDP08	Classroom Single Cylinder	US10B	24	50	\$119.29
FDP98	Classroom Single Cylinder	US19	24	50	\$119.29
FDPP8	Classroom Single Cylinder	US15	24	50	\$108.44
FDPS8	Classroom Single Cylinder	US26D	24	50	\$108.44

• FDP08A	Classroom I/C Core Single Cylinder (w/o IC core)	US10B	24	47	\$119.29
• FDP98A	Classroom I/C Core Single Cylinder (w/o IC core)	US19	24	47	\$119.29
• FDPP8A	Classroom I/C Core Single Cylinder (w/o IC core)	US15	24	47	\$108.44
• FDPS8A	Classroom I/C Core Single Cylinder (w/o IC core)	US26D	24	47	\$108.44

NOTE: Single cylinder is ADA compliant.



Latch: 1-1/8"x2-1/4" square corner, Adj. backset, UL Strike: FD1SPS: 1-1/8"x2-3/4" square corner

COMMERCIAL LOCKS

DAVIDSON

HEAVY-DUTY GRADE 2 CYLINDRICAL LEVERSETS

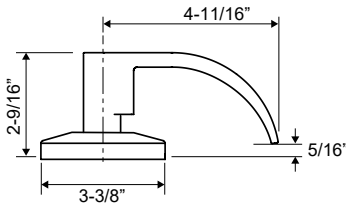

Latch: 1-1/8"x2-1/4" square corner, 2-3/4" backset, UL
Strike: FASA: 1-1/4"x4-7/8", square corner

Model #	Function	Finish	QTY /Case	Lbs /Case	List Price
FYN0DC	Entry w/ Clutch Mechanism	US10B	12	43	\$161.90
FYN01C	Privacy	US10B	12	40	\$135.56
FYN03C	Passage	US10B	12	39	\$132.35
FYN04C	Half Dummy Trim	US10B	40	47	\$59.57
FYN04CD	Double Dummy Trim	US10B	12	31	\$119.15
FYN0SC	Storeroom w/ Clutch Mechanism	US10B	12	45	\$164.69
FYN08C	Classroom	US10B	12	45	\$149.73
• FYN00D	I/C Core Entry (w/o IC core)	US10B	12	40	\$161.90
• FYN05D	I/C Core Storeroom (w/o IC core)	US10B	12	40	\$164.69
• FYN08D	I/C Core Classroom (w/o IC core)	US10B	12	40	\$164.69
FYNPDC	Entry w/ Clutch Mechanism	US15	12	43	\$147.19
FYNP1C	Privacy	US15	12	40	\$123.23
FYNP3C	Passage	US15	12	39	\$120.33
FYNP4C	Half Dummy Trim	US15	40	47	\$54.14
FYNP4CD	Double Dummy Trim	US15	12	31	\$108.33
FYNPSC	Storeroom w/ Clutch Mechanism	US15	12	45	\$149.73
FYNP8C	Classroom	US15	12	45	\$136.11
• FYNP0D	I/C Core Entry (w/o IC core)	US15	12	40	\$133.80
• FYNP5D	I/C Core Storeroom (w/o IC core)	US15	12	40	\$136.11
• FYNP8D	I/C Core Classroom (w/o IC core)	US15	12	40	\$136.11
FYNSDC	Entry w/ Clutch Mechanism	US26D	12	43	\$147.19
FYNS1C	Privacy	US26D	12	40	\$123.23
FYNS3C	Passage	US26D	12	39	\$120.33
FYNS4C	Half Dummy Trim	US26D	40	47	\$54.14
FYNS4CD	Double Dummy Trim	US26D	12	31	\$108.33
FYNSSC	Storeroom w/ Clutch Mechanism	US26D	12	45	\$149.73
FYNS8C	Classroom	US26D	12	45	\$136.11
• FYNS0D	I/C Core Entry (w/o IC core)	US26D	12	40	\$133.80
• FYNS5D	I/C Core Storeroom (w/o IC core)	US26D	12	40	\$136.11
• FYNS8D	I/C Core Classroom (w/o IC core)	US26D	12	40	\$136.11

COMMERCIAL LOCKS

NOTE: Cylindrical locks have quick-release function and pushbutton locking.

PRINCETON

HEAVY-DUTY GRADE 2 CYLINDRICAL LEVERSETS

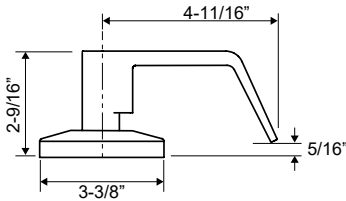

Latch: 1-1/8"x2-1/4" square corner, 2-3/4" backset, UL Strike: FASA: 1-1/4"x4-7/8", square corner

Model #	Function	Finish	QTY /Case	Lbs /Case	List Price
FY300C	Entry	US10B	12	43	\$147.19
FY30DC	Entry w/ Clutch Mechanism	US10B	12	43	\$161.90
FY301C	Privacy	US10B	12	40	\$135.56
FY303C	Passage	US10B	12	39	\$132.35
FY304C	Half Dummy Trim	US10B	40	47	\$59.57
FY304CD	Double Dummy Trim	US10B	12	31	\$119.15
FY305C	Storeroom	US10B	12	45	\$149.73
FY308C	Classroom	US10B	12	45	\$149.73
FY305C	Storeroom w/ Clutch Mechanism	US10B	12	45	\$164.69
• FY300D	I/C Core Entry (w/o IC core)	US10B	12	40	\$161.90
• FY305D	I/C Core Storeroom (w/o IC core)	US10B	12	40	\$164.69
• FY308D	I/C Core Classroom (w/o IC core)	US10B	12	40	\$164.69
FY390C	Entry	US19	12	43	\$147.19
FY39DC	Entry w/ Clutch Mechanism	US19	12	43	\$161.90
FY391C	Privacy	US19	12	40	\$135.56
FY393C	Passage	US19	12	39	\$132.35
FY394C	Half Dummy Trim	US19	40	47	\$59.57
FY394CD	Double Dummy Trim	US19	12	31	\$119.15
FY395C	Storeroom	US19	12	45	\$149.73
FY398C	Classroom	US19	12	45	\$149.73
FY395C	Storeroom w/ Clutch Mechanism	US19	12	45	\$164.69
• FY390D	I/C Core Entry (w/o IC core)	US19	12	40	\$161.90
• FY395D	I/C Core Storeroom (w/o IC core)	US19	12	40	\$164.69
• FY398D	I/C Core Classroom (w/o IC core)	US19	12	40	\$164.69
FY3P0C	Entry	US15	12	43	\$133.80
FY3PDC	Entry w/ Clutch Mechanism	US15	12	43	\$147.19
FY3P1C	Privacy	US15	12	40	\$123.23
FY3P3C	Passage	US15	12	39	\$120.33
FY3P4C	Half Dummy Trim	US15	40	47	\$54.14
FY3P4CD	Double Dummy Trim	US15	12	31	\$108.33
FY3P5C	Storeroom	US15	12	45	\$136.11
FY3P8C	Classroom	US15	12	45	\$136.11
FY3P5C	Storeroom w/ Clutch Mechanism	US15	12	45	\$149.73
• FY3P0D	I/C Core Entry (w/o IC core)	US15	12	40	\$147.19
• FY3P5D	I/C Core Storeroom (w/o IC core)	US15	12	40	\$149.73
• FY3P8D	I/C Core Classroom (w/o IC core)	US15	12	40	\$149.73
FY3S0C	Entry	US26D	12	43	\$133.80
FY3SDC	Entry w/ Clutch Mechanism	US26D	12	43	\$147.19
FY3S1C	Privacy	US26D	12	40	\$123.23
FY3S3C	Passage	US26D	12	39	\$120.33
FY3S4C	Half Dummy Trim	US26D	40	47	\$54.14
FY3S4CD	Double Dummy Trim	US26D	12	31	\$108.33
FY3S5C	Storeroom	US26D	12	45	\$136.11
FY3S8C	Classroom	US26D	12	45	\$136.11
FY3S5C	Storeroom w/ Clutch Mechanism	US26D	12	45	\$149.73
• FY3S0D	I/C Core Entry (w/o IC core)	US26D	12	40	\$147.19
• FY3S5D	I/C Core Storeroom (w/o IC core)	US26D	12	40	\$149.73
• FY3S8D	I/C Core Classroom (w/o IC core)	US26D	12	40	\$149.73

NOTE: Cylindrical locks have quick-release function and pushbutton locking.

PRINCETON

HEAVY-DUTY GRADE 2 CYLINDRICAL LEVERSETS



Model #	Function	Finish	QTY /Case	Lbs /Case	List Price
---------	----------	--------	-----------	-----------	------------

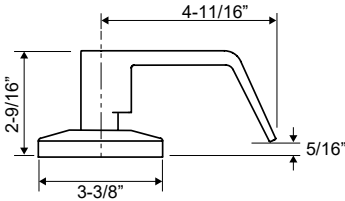

Latch: 1-1/8"x2-1/4" square corner, 2-3/4" backset, UL
 Strike: FASA: 1-1/4"x4-7/8", square corner

FY370C	Entry	US3	12	43	\$133.80
FY371C	Privacy	US3	12	40	\$123.23
FY373C	Passage	US3	12	39	\$120.33
FY374C	Half Dummy Trim	US3	40	47	\$54.14
FY375C	Storeroom	US3	12	45	\$136.11
FY378C	Classroom	US3	12	45	\$136.11
FY380C	Entry	US5	12	43	\$133.80
FY381C	Privacy	US5	12	40	\$123.23
FY383C	Passage	US5	12	39	\$120.33
FY384C	Half Dummy Trim	US5	40	47	\$54.14
FY385C	Storeroom	US5	12	45	\$136.11
FY388C	Classroom	US5	12	45	\$136.11

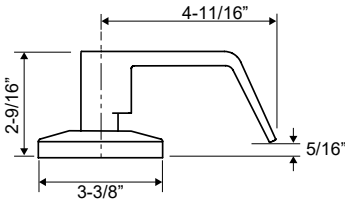

Latch: 1-1/8"x2-1/4" square corner, 2-3/4" backset, UL
 Strike: FASA: 1-1/4"x4-7/8", square corner

FY303CH	Communicating Passage	US10B	12	24	\$132.35
FY393CH	Communicating Passage	US19	12	24	\$132.35
FY3P3CH	Communicating Passage	US15	12	24	\$120.33
FY3S3CH	Communicating Passage	US26D	12	24	\$120.33

NOTE: Cylindrical locks have quick-release function and pushbutton locking.

AVALON

HEAVY-DUTY GRADE 2 CYLINDRICAL LEVERSETS

COMMERCIAL LOCKS

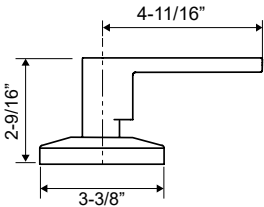

Latch: 1-1/8"x2-1/4" square corner, 2-3/4" backset, UL
Strike: FASA: 1-1/4"x4-7/8", square corner

Model #	Function	Finish	QTY /Case	Lbs /Case	List Price
FYG90C	Entry	US19	12	43	\$147.19
FYG91C	Privacy	US19	12	40	\$135.56
FYG93C	Passage	US19	12	39	\$132.35
FYG94C	Half Dummy Trim	US19	40	47	\$59.57
FYG94CD	Double Dummy Trim	US19	12	31	\$119.15
FYG95C	Storeroom	US19	12	45	\$149.73
FYG98C	Classroom	US19	12	45	\$149.73
FYG9DC	Entry w/ Clutch Mechanism	US19	12	43	\$161.90
FYG9SC	Storeroom w/ Clutch Mechanism	US19	12	45	\$164.69
FYG90D	I/C Core Entry (w/o IC core)	US19	12	40	\$161.90
FYG95D	I/C Core Storeroom (w/o IC core)	US19	12	40	\$164.69
FYG98D	I/C Core Classroom (w/o IC core)	US19	12	40	\$164.69
FYGP0C	Entry	US15	12	43	\$133.80
FYGP1C	Privacy	US15	12	40	\$123.23
FYGP3C	Passage	US15	12	39	\$120.33
FYGP4C	Half Dummy Trim	US15	40	47	\$54.14
FYGP4CD	Double Dummy Trim	US15	12	31	\$108.33
FYGP5C	Storeroom	US15	12	45	\$136.11
FYGP8C	Classroom	US15	12	45	\$136.11
FYGPDC	Entry w/ Clutch Mechanism	US15	12	43	\$147.19
FYGPSC	Storeroom w/ Clutch Mechanism	US15	12	45	\$149.73
FYGP0D	I/C Core Entry (w/o IC core)	US15	12	40	\$147.19
FYGP5D	I/C Core Storeroom (w/o IC core)	US15	12	40	\$149.73
FYGP8D	I/C Core Classroom (w/o IC core)	US15	12	40	\$149.73
FYGS0C	Entry	US26D	12	43	\$133.80
FYGS1C	Privacy	US26D	12	40	\$123.23
FYGS3C	Passage	US26D	12	39	\$120.33
FYGS4C	Half Dummy Trim	US26D	40	47	\$54.14
FYGS4CD	Double Dummy Trim	US26D	12	31	\$108.33
FYGS5C	Storeroom	US26D	12	45	\$136.11
FYGS8C	Classroom	US26D	12	45	\$136.11
FYGSDC	Entry w/ Clutch Mechanism	US26D	12	43	\$147.19
FYSSC	Storeroom w/ Clutch Mechanism	US26D	12	45	\$149.73
FYGS0D	I/C Core Entry (w/o IC core)	US26D	12	40	\$147.19
FYGS5D	I/C Core Storeroom (w/o IC core)	US26D	12	40	\$149.73
FYGS8D	I/C Core Classroom (w/o IC core)	US26D	12	40	\$149.73

NOTE: Cylindrical locks have quick-release function and pushbutton locking.

CAMBRIDGE

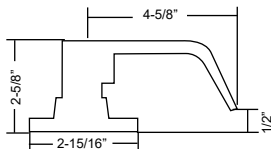

Latch: 1"x2-1/4" round corner, adjustable backset, UL
Strike: FT4SPG: 1-3/4"x2-1/4" full lip strike, round corner

Model #	Function	Finish	QTY /Case	Lbs /Case	List Price
FL300B	Entry	US10B	12	32	\$112.99
FL301B	Privacy	US10B	12	30	\$104.05
FL303B	Passage	US10B	12	29	\$101.58
FL303BH	Communicating Passage	US10B	12	22	\$101.58
FL304B	Half Dummy	US10B	40	36	\$45.73
FL304BD	Double Dummy	US10B	12	25	\$91.48
FL305B	Storeroom	US10B	12	32	\$114.89
FL308B	Classroom	US10B	12	32	\$114.89
FL300C	Entry w/Push Button	US10B	12	32	\$118.62
FL301C	Privacy w/Push Button	US10B	12	30	\$109.24
• FL300D	I/C Core Entry (w/o IC core)	US10B	12	40	\$112.99
• FL305D	I/C Core Storeroom (w/o IC core)	US10B	12	40	\$114.89
• FL308D	I/C Core Classroom (w/o IC core)	US10B	12	40	\$114.89
FL390B	Entry	US19	12	32	\$112.99
FL391B	Privacy	US19	12	30	\$104.05
FL393B	Passage	US19	12	29	\$101.58
FL393BH	Communicating Passage	US19	12	22	\$101.58
FL394B	Half Dummy	US19	40	36	\$45.73
FL394BD	Double Dummy	US19	12	25	\$91.48
FL395B	Storeroom	US19	12	32	\$114.89
FL398B	Classroom	US19	12	32	\$114.89
FL390C	Entry w/Push Button	US19	12	32	\$118.62
FL391C	Privacy w/Push Button	US19	12	30	\$109.24
• FL390D	I/C Core Entry (w/o IC core)	US19	12	40	\$112.99
• FL395D	I/C Core Storeroom (w/o IC core)	US19	12	40	\$114.89
• FL398D	I/C Core Classroom (w/o IC core)	US19	12	40	\$114.89
FL360B	Entry	US15	12	32	\$102.72
FL361B	Privacy	US15	12	30	\$94.59
FL363B	Passage	US15	12	29	\$92.37
FL363BH	Communicating Passage	US15	12	22	\$92.37
FL364B	Half Dummy	US15	40	36	\$41.59
FL364BD	Double Dummy	US15	12	25	\$83.17
FL365B	Storeroom	US15	12	32	\$104.44
FL368B	Classroom	US15	12	32	\$104.44
FL360C	Entry w/Push Button	US15	12	32	\$107.86
FL361C	Privacy w/Push Button	US15	12	30	\$99.30
• FL360D	I/C Core Entry (w/o IC core)	US15	12	40	\$102.72
• FL365D	I/C Core Storeroom (w/o IC core)	US15	12	40	\$104.44
• FL368D	I/C Core Classroom (w/o IC core)	US15	12	40	\$104.44
FL3S0B	Entry	US26D	12	32	\$102.72
FL3S1B	Privacy	US26D	12	30	\$94.59
FL3S3B	Passage	US26D	12	29	\$92.37
FL3S3BH	Communicating Passage	US26D	12	22	\$92.37
FL3S4B	Half Dummy	US26D	40	36	\$41.59
FL3S4BD	Double Dummy	US26D	12	25	\$83.17
FL3S5B	Storeroom	US26D	12	32	\$104.44
FL3S8B	Classroom	US26D	12	32	\$104.44
FL3S0C	Entry w/Push Button	US26D	12	32	\$107.86
FL3S1C	Privacy w/Push Button	US26D	12	30	\$99.30
• FL3S0D	I/C Core Entry (w/o IC core)	US26D	12	40	\$102.72
• FL3S5D	I/C Core Storeroom (w/o IC core)	US26D	12	40	\$104.44
• FL3S8D	I/C Core Classroom (w/o IC core)	US26D	12	40	\$104.44

CAMBRIDGE



Model #	Function	Finish	QTY /Case	Lbs /Case	List Price
FL370B	Entry	US3	12	32	\$99.62
FL371B	Privacy	US3	12	30	\$91.78
FL373B	Passage	US3	12	29	\$89.59
FL374B	Half Dummy	US3	40	36	\$40.32
FL375B	Storeroom	US3	12	32	\$101.43
FL378B	Classroom	US3	12	32	\$101.43
FL380B	Entry	US5	12	32	\$102.72
FL381B	Privacy	US5	12	30	\$94.59
FL383B	Passage	US5	12	29	\$92.37
FL384B	Half Dummy	US5	40	36	\$41.59
FL385B	Storeroom	US5	12	32	\$104.44
FL388B	Classroom	US5	12	32	\$104.44

DALLAS

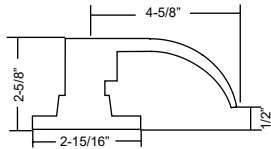

Latch: 1"x2-1/4" round corner, adjustable backset, UL
Strike: FT4SPG: 1-3/4"x2-1/4" full lip strike, round corner

Model #	Function	Finish	QTY /Case	Lbs /Case	List Price
FLN00B	Entry	US10B	12	32	\$112.99
FLN01B	Privacy	US10B	12	30	\$104.05
FLN03B	Passage	US10B	12	29	\$101.58
FLN03BH	Communicating Passage	US10B	12	22	\$101.58
FLN04B	Half Dummy	US10B	40	36	\$45.73
FLN04BD	Double Dummy	US10B	12	25	\$91.48
FLN05B	Storeroom	US10B	12	32	\$114.89
FLN08B	Classroom	US10B	12	32	\$114.89
FLN00C	Entry w/Push Button	US10B	12	32	\$118.62
FLN01C	Privacy w/Push Button	US10B	12	30	\$109.24
• FLN00D	I/C Core Entry (w/o IC core)	US10B	12	40	\$112.99
• FLN05D	I/C Core Storeroom (w/o IC core)	US10B	12	40	\$114.89
• FLN08D	I/C Core Classroom (w/o IC core)	US10B	12	40	\$114.89
FLNP0B	Entry	US15	12	32	\$102.72
FLNP1B	Privacy	US15	12	30	\$94.59
FLNP3B	Passage	US15	12	29	\$92.37
FLNP3BH	Communicating Passage	US15	12	22	\$92.37
FLNP4B	Half Dummy	US15	40	36	\$41.59
FLNP4BD	Double Dummy	US15	12	25	\$83.17
FLNP5B	Storeroom	US15	12	32	\$104.44
FLNP8B	Classroom	US15	12	32	\$104.44
FLNP0C	Entry w/Push Button	US15	12	32	\$107.86
FLNP1C	Privacy w/Push Button	US15	12	30	\$99.30
• FLNP0D	I/C Core Entry (w/o IC core)	US15	12	40	\$102.72
• FLNP5D	I/C Core Storeroom (w/o IC core)	US15	12	40	\$104.44
• FLNP8D	I/C Core Classroom (w/o IC core)	US15	12	40	\$104.44
FLNS0B	Entry	US26D	12	32	\$102.72
FLNS1B	Privacy	US26D	12	30	\$94.59
FLNS3B	Passage	US26D	12	29	\$92.37
FLNS3BH	Communicating Passage	US26D	12	22	\$92.37
FLNS4B	Half Dummy	US26D	40	36	\$41.59
FLNS4BD	Double Dummy	US26D	12	25	\$83.17
FLNS5B	Storeroom	US26D	12	32	\$104.44
FLNS8B	Classroom	US26D	12	32	\$104.44
FLNS0C	Entry w/Push Button	US26D	12	32	\$107.86
FLNS1C	Privacy w/Push Button	US26D	12	30	\$99.30
• FLNS0D	I/C Core Entry (w/o IC core)	US26D	12	40	\$102.72
• FLNS5D	I/C Core Storeroom (w/o IC core)	US26D	12	40	\$104.44
• FLNS8D	I/C Core Classroom (w/o IC core)	US26D	12	40	\$104.44

SIERRA

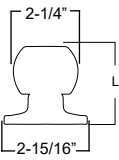

(Exterior Trim)
Entry/Privacy: 2-11/16"
Passage: 2-7/8"

Latch: 1"x2-1/4" round corner, adjustable backset, UL
Strike: FT4SPG: 1-3/4"x2-1/4" full lip strike, round corner

Model #	Function	Finish	QTY /Case	Lbs /Case	List Price
FT360B	Entry	US32D	24	48	\$58.26
FT361B	Privacy	US32D	24	43	\$44.71
FT363B	Passage	US32D	24	39	\$46.03
FT363BH	Communicating Passage	US32D	12	22	\$46.03
FT364B	Half Dummy Trim	US32D	40	21	\$20.69
FT365B	Storeroom	US32D	24	46	\$62.15
FT368B	Classroom	US32D	24	46	\$62.15
FT360C	Entry w/ Push Button	US32D	24	48	\$61.19
FT361C	Privacy w/ Push Button	US32D	24	43	\$50.09
(Cylindrical Lock)					
● FC360D	I/C Core Entry (w/o IC core)	US32D	12	40	\$61.19
● FC365D	I/C Core Storeroom (w/o IC core)	US32D	12	40	\$62.15
● FC368D	I/C Core Classroom (w/o IC core)	US32D	12	40	\$62.15
FT370B	Entry	US3	24	48	\$62.66
FT371B	Privacy	US3	24	43	\$51.34
FT373B	Passage	US3	24	39	\$49.37
FT374B	Half Dummy Trim	US3	40	21	\$22.27
FT375B	Storeroom	US3	24	46	\$66.88
FT380B	Entry	US5	24	48	\$64.61
FT381B	Privacy	US5	24	43	\$52.92
FT383B	Passage	US5	24	39	\$50.90
FT384B	Half Dummy Trim	US5	40	21	\$22.95
FT385B	Storeroom	US5	24	46	\$68.95
FT388B	Classroom	US5	24	46	\$68.95



FL303BP	Cover Plate for Tubular Communicating Passage	US10B	20	22	\$29.73
FL393BP	Cover Plate for Tubular Communicating Passage	US19	20	22	\$29.73
FL363BP	Cover Plate for Tubular Communicating Passage	US15	20	22	\$27.01
FL3S3BP	Cover Plate for Tubular Communicating Passage	US26D	20	22	\$27.01

FD7 SERIES



Latch: 1"x2-1/4" square corner, adjustable backset, UL
Strike: FD1SPS: 1-1/8"x2-3/4" square corner

Model #	Function	Finish	QTY /Case	Lbs /Case	List Price
FD701	Single Cylinder	US10B	24	50	\$66.27
FD791	Single Cylinder	US19	24	50	\$66.27
FD761	Single Cylinder	US32D	24	50	\$55.98
FD771	Single Cylinder	US3	24	50	\$60.26
FD781	Single Cylinder	US5	24	50	\$60.26
FD7P1	Single Cylinder	US15	24	50	\$60.26
FD7S1	Single Cylinder	US26D	24	50	\$60.26
FD721	Single Cylinder (ETA: 09/22)	US26	24	50	\$60.26
FD702	Double Cylinder	US10B	24	69	\$85.88
FD792	Double Cylinder	US19	24	69	\$85.88
FD762	Double Cylinder	US32D	24	69	\$73.08
FD772	Double Cylinder	US3	24	69	\$78.08
FD782	Double Cylinder	US5	24	69	\$78.08
FD7P2	Double Cylinder	US15	24	69	\$78.08
FD7S2	Double Cylinder	US26D	24	69	\$78.08
FD722	Double Cylinder (ETA: 09/22)	US26	24	69	\$78.08
• FD70A	I/C Core Single Cylinder (w/o IC core)	US10B	24	47	\$66.27
• FD79A	I/C Core Single Cylinder (w/o IC core)	US19	24	47	\$66.27
• FD76A	I/C Core Single Cylinder (w/o IC core)	US32D	24	47	\$55.98
• FD7PA	I/C Core Single Cylinder (w/o IC core)	US15	24	47	\$55.98
• FD7SA	I/C Core Single Cylinder (w/o IC core)	US26D	24	47	\$60.26
• FD72A	I/C Core Single Cylinder (w/o IC core)	US26	24	47	\$55.98
	(ETA: 09/22)				
• FD70B	I/C Core Double Cylinder (w/o IC core)	US10B	24	60	\$85.88
• FD79B	I/C Core Double Cylinder (w/o IC core)	US19	24	60	\$85.88
• FD76B	I/C Core Double Cylinder (w/o IC core)	US32D	24	60	\$73.08
• FD7PB	I/C Core Double Cylinder (w/o IC core)	US15	24	60	\$73.08
• FD7SB	I/C Core Double Cylinder (w/o IC core)	US26D	24	60	\$78.08
• FD72B	I/C Core Double Cylinder (w/o IC core)	US26	24	60	\$73.08
	(ETA: 09/22)				

FD7 SERIES Model # Function Finish QTY /Case Lbs /Case List Price



ONE-SIDED DEADBOLT

FD706	One-Sided Deadbolt	US10B	24	47	\$59.63
FD796	One-Sided Deadbolt	US19	24	47	\$59.63
FD766	One-Sided Deadbolt	US32D	24	47	\$50.38
FD7P6	One-Sided Deadbolt	US15	24	47	\$54.22
FD7S6	One-Sided Deadbolt	US26D	24	47	\$54.22
FD726	One-Sided Deadbolt	US26	24	47	\$54.22



CLASSROOM DEADBOLT

FD708	Classroom Deadbolt	US10B	24	50	\$69.57
FD798	Classroom Deadbolt	US19	24	50	\$69.57
FD768	Classroom Deadbolt	US32D	24	50	\$58.77
FD7P8	Classroom Deadbolt	US15	24	50	\$63.26
FD7S8	Classroom Deadbolt	US26D	24	50	\$63.26
FD728	Classroom Deadbolt	US26	24	50	\$63.26

Latch: 1"x2-1/4" square corner, adjustable backset, UL
Strike: FD1SPS: 1-1/8"x2-3/4" square corner

• FD708A	Classroom I/C Core Single Cylinder (w/o IC core)	US10B	24	50	\$69.57
• FD798A	Classroom I/C Core Single Cylinder (w/o IC core)	US19	24	50	\$69.57
• FD768A	Classroom I/C Core Single Cylinder (w/o IC core)	US32D	24	50	\$58.77
• FD7P8A	Classroom I/C Core Single Cylinder (w/o IC core)	US15	24	50	\$63.26
• FD7S8A	Classroom I/C Core Single Cylinder (w/o IC core)	US26D	24	50	\$63.26
• FD728A	Classroom I/C Core Single Cylinder (w/o IC core)	US26	24	50	\$63.26



INDICATOR DEADBOLT (non-UL Listed)

FD707	Indicator Deadbolt	US10B	24	36	\$66.27
FD797	Indicator Deadbolt	US19	24	36	\$66.27
FD767	Indicator Deadbolt	US32D	24	36	\$55.98
FD7P7	Indicator Deadbolt	US15	24	36	\$60.26
FD7S7	Indicator Deadbolt	US26D	24	36	\$60.26
FD727	Indicator Deadbolt	US26	24	36	\$60.26

Latch: 1"x2-1/4" square corner, adjustable backset
Strike: FD1SPS: 1-1/8"x2-3/4" square corner

FD8 Series



Latch: 1"x2-1/4" round corner, adjustable backset
Strike: FD1SPS: 1-1/8"x2-3/4" square corner

Model #	Function	Finish	QTY /Case	Lbs /Case	List Price
FD801	Single Cylinder w/ Adj. Non-UL Latch	US10B	24	45	\$63.29
FD801UL	Single Cylinder w/ Adj. UL Listed Latch	US10B	24	45	\$82.18
FD891	Single Cylinder w/ Adj. Non-UL Latch	US19	24	45	\$63.29
FD891UL	Single Cylinder w/ Adj. UL Listed Latch	US19	24	45	\$82.18
FD861	Single Cylinder w/ Adj. Non-UL Latch	US32D(15)	24	45	\$53.47
FD861UL	Single Cylinder w/ Adj. UL Listed Latch	US32D(15)	24	45	\$69.41
FD8S1	Single Cylinder w/ Adj. Non-UL Latch	US26D	24	45	\$57.56
FD8S1UL	Single Cylinder w/ Adj. UL Listed Latch	US26D	24	45	\$74.73
FD821	Single Cylinder w/ Adj. Non-UL Latch (ETA: 09/22)	US26	24	45	\$57.56
FD821UL	Single Cylinder w/ Adj. UL Listed Latch (ETA: 09/22)	US26	24	45	\$74.73

FKC-D80KW	Key and Cylinder only, KW 5-pin	US10B	100	12	\$17.85
FKC-D80SC5	Key and Cylinder only, SC 5-pin	US10B	100	12	\$17.85
FKC-D80SC6	Key and Cylinder only, SC 6-pin	US10B	100	12	\$17.85
FKC-D89KW	Key and Cylinder only, KW 5-pin	US19	100	12	\$17.85
FKC-D89SC5	Key and Cylinder only, SC 5-pin	US19	100	12	\$17.85
FKC-D89SC6	Key and Cylinder only, SC 6-pin	US19	100	12	\$17.85



FKC-D86KW	Key and Cylinder only, KW 5-pin	US32D(15)	100	12	\$17.85
FKC-D86SC5	Key and Cylinder only, SC 5-pin	US32D(15)	100	12	\$17.85
FKC-D86SC6	Key and Cylinder only, SC 6-pin	US32D(15)	100	12	\$17.85
FKC-D8SKW	Key and Cylinder only, KW 5-pin	US26D	100	12	\$17.85
FKC-D8SSC5	Key and Cylinder only, SC 5-pin	US26D	100	12	\$17.85
FKC-D8SSC6	Key and Cylinder only, SC 6-pin	US26D	100	12	\$17.85

(ETA: 09/22)

FKC-D82KW	Key & Cylinder for KW 5-pin	US26	100	12	\$17.85
FKC-D82SC5	Key & Cylinder for SC 5-pin	US26	100	12	\$17.85
FKC-D82SC6	Key & Cylinder for SC 6-pin	US26	100	12	\$17.85



FKCB-D86KW	Control Key Blank, KW 5-pin	US4	100	2	\$1.37
FKCB-D86SC5	Control Key Blank, SC 5-pin	US4	100	2	\$1.37
FKCB-D86SC6	Control Key Blank, SC 6-pin	US4	100	2	\$1.37



FKHO-D8	Cylinder Housing		100	20	\$5.27
----------------	------------------	--	-----	----	--------

CONCORD

4" Center-to-Center

Model # Function Finish QTY /Case Lbs /Case List Price



W/ CAMBRIDGE LEVER

FI3004	Entry, Double Locking	US10B	6	32	\$246.81
FI3034	Passage, Single Locking	US10B	6	31	\$224.40
FI3034-D8	Passage, Single Locking with Removable Cylinder Deadbolt	US10B	6	31	\$230.07
FI3034A	Passage, Single Locking with Small Format I/C (w/o IC core)	US10B	6	31	\$224.40
FI3904	Entry, Double Locking	US19	6	32	\$246.81
FI3934	Passage, Single Locking	US19	6	31	\$224.40
FI3934-D8	Passage, Single Locking with Removable Cylinder Deadbolt	US19	6	31	\$230.07
FI3934A	Passage, Single Locking with Small Format I/C (w/o IC core)	US19	6	31	\$224.40
FI3604	Entry, Double Locking	US15	6	32	\$224.40
FI3634	Passage, Single Locking	US15	6	31	\$203.99
FI3634-D8	Passage, Single Locking with Removable Cylinder Deadbolt	US15	6	31	\$208.57
FI3634A	Passage, Single Locking with Small Format I/C (w/o IC core)	US15	6	31	\$203.99
FI3S04	Entry, Double Locking	US26D	6	32	\$224.40
FI3S34	Passage, Single Locking	US26D	6	31	\$203.99
FI3S34-D8	Passage, Single Locking with Removable Cylinder Deadbolt	US26D	6	31	\$208.57
FI3S34A	Passage, Single Locking with Small Format I/C (w/o IC core)	US26D	6	31	\$203.99
FI3704	Entry, Double Locking	US3	6	32	\$224.40
FI3734	Passage, Single Locking	US3	6	31	\$203.99

Latch: Deadbolt: 1-1/8"x2-1/4" square corner, adj. backset, UL
 Handle: 1-1/8"x2-1/4" square corner, adj. backset, UL
 Strike: Deadbolt: FD1SPS: 1-1/8"x2-3/4" square corner
 Handle: FT7SPG: 1-1/8"x2-3/4" T-strike square corner

HAMPTON

4" Center-to-Center

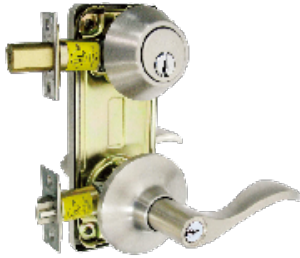

Model # Function Finish QTY /Case Lbs /Case List Price

W/ NAPLES LEVER

FIYE004L	Entry, Double Locking, LH	US10B	6	34	\$246.81
FIYE004R	Entry, Double Locking, RH	US10B	6	34	\$246.81
FIYE034L	Passage, Single Locking, LH	US10B	6	33	\$224.40
FIYE034R	Passage, Single Locking, RH	US10B	6	33	\$224.40
FIYE034L-D8	Passage, Single Locking, LH with Removable Cylinder Deadbolt	US10B	6	33	\$230.07
FIYE034R-D8	Passage, Single Locking, RH with Removable Cylinder Deadbolt	US10B	6	33	\$230.07
FIYE034AL	Passage, Single Locking, LH with Small Format I/C (w/o IC core)	US10B	6	33	\$224.40
FIYE034AR	Passage, Single Locking, RH with Small Format I/C (w/o IC core)	US10B	6	33	\$224.40
FIYEP04L	Entry, Double Locking, LH	US15	6	34	\$224.40
FIYEP04R	Entry, Double Locking, RH	US15	6	34	\$224.40
FIYEP34L	Passage, Single Locking, LH	US15	6	33	\$203.99
FIYEP34R	Passage, Single Locking, RH	US15	6	33	\$203.99
FIYEP34L-D8	Passage, Single Locking, LH with Removable Cylinder Deadbolt	US15	6	33	\$208.57
FIYEP34R-D8	Passage, Single Locking, RH with Removable Cylinder Deadbolt	US15	6	33	\$208.57
FIYEP34AL	Passage, Single Locking, LH with Small Format I/C (w/o IC core)	US15	6	33	\$203.99
FIYEP34AR	Passage, Single Locking, RH with Small Format I/C (w/o IC core)	US15	6	33	\$203.99

*Handing: Specify RH/LH

Latch: Deadbolt: 1-1/8"x2-1/4" square corner, adj. backset, UL
 Handle: 1-1/8"x2-1/4" square corner, adj. backset, UL
 Strike: Deadbolt: FD1SPS: 1-1/8"x2-3/4" square corner
 Handle: FT7SPG: 1-1/8"x2-3/4" T-strike square corner

DAYTONA

4" Center-to-Center



Model # Function Finish QTY /Case Lbs /Case List Price

W/ DALLAS LEVER

FIN004	Entry, Double Locking	US10B	6	32	\$246.81
FIN034	Passage, Single Locking	US10B	6	31	\$224.40
FIN034-D8	Passage, Single Locking with Removable Cylinder Deadbolt	US10B	6	31	\$230.07
FIN034A	Passage, Single Locking with Small Format I/C (w/o IC core)	US10B	6	31	\$224.40
FINP04	Entry, Double Locking	US15	6	32	\$224.40
FINP34	Passage, Single Locking	US15	6	31	\$203.99
FINP34-D8	Passage, Single Locking with Removable Cylinder Deadbolt	US15	6	31	\$208.57
FINP34A	Passage, Single Locking with Small Format I/C (w/o IC core)	US15	6	31	\$203.99
FINS04	Entry, Double Locking	US26D	6	32	\$224.40
FINS34	Passage, Single Locking	US26D	6	31	\$203.99
FINS34-D8	Passage, Single Locking with Removable Cylinder Deadbolt	US26D	6	31	\$208.57
FINS34A	Passage, Single Locking with Small Format I/C (w/o IC core)	US26D	6	31	\$203.99

Latch: Deadbolt: 1-1/8"x2-1/4" square corner, adj. backset, UL
 Handle: 1-1/8"x2-1/4" square corner, adj. backset, UL
 Strike: Deadbolt: FD1SPS: 1-1/8"x2-3/4" square corner
 Handle: FT7SPG: 1-1/8"x2-3/4" T-strike square corner

WESTFIELD

5-1/2" Center-to-Center

Model # Function Finish QTY /Case Lbs /Case List Price



W/ CAMBRIDGE LEVER

FI3005	Entry, Double Locking	US10B	6	32	\$246.81
FI3035	Passage, Single Locking	US10B	6	31	\$224.40
FI3035-D8	Passage, Single Locking with Removable Cylinder Deadbolt	US10B	6	31	\$230.07
FI3035A	Passage, Single Locking with Small Format I/C (w/o IC core)	US10B	6	31	\$224.40
FI3905	Entry, Double Locking	US19	6	32	\$246.81
FI3935	Passage, Single Locking	US19	6	31	\$224.40
FI3935-D8	Passage, Single Locking with Removable Cylinder Deadbolt	US19	6	31	\$230.07
FI3935A	Passage, Single Locking with Small Format I/C (w/o IC core)	US19	6	31	\$224.40
FI3605	Entry, Double Locking	US15	6	32	\$224.40
FI3635	Passage, Single Locking	US15	6	31	\$203.99
FI3635-D8	Passage, Single Locking with Removable Cylinder Deadbolt	US15	6	31	\$208.57
FI3635A	Passage, Single Locking with Small Format I/C (w/o IC core)	US15	6	31	\$203.99
FI3S05	Entry, Double Locking	US26D	6	32	\$224.40
FI3S35	Passage, Single Locking	US26D	6	31	\$203.99
FI3S35-D8	Passage, Single Locking with Removable Cylinder Deadbolt	US26D	6	31	\$208.57
FI3S35A	Passage, Single Locking with Small Format I/C (w/o IC core)	US26D	6	31	\$203.99
(ETA: 09/22)					
FI3205	Entry, Double Locking	US26	6	32	\$224.40
FI3235	Passage, Single Locking	US26	6	31	\$203.99
FI3235-D8	Passage, Single Locking with Removable Cylinder Deadbolt	US26	6	31	\$208.57
FI3235A	Passage, Single Locking with Small Format I/C (w/o IC core)	US26	6	31	\$203.99

Latch: Deadbolt: 1-1/8"x2-1/4" square corner, adj. backset, UL
 Handle: 1-1/8"x2-1/4" square corner, adj. backset, UL
 Strike: Deadbolt: FD1SPS: 1-1/8"x2-3/4" square corner
 Handle: FT7SPG: 1-1/8"x2-3/4" T-strike square corner

NEWPORT



5-1/2" Center-to-Center

Model #	Function	Finish	QTY /Case	Lbs /Case	List Price
W/ NAPLES LEVER					
FIYE005L	Entry, Double Locking, LH	US10B	6	34	\$246.81
FIYE005R	Entry, Double Locking, RH	US10B	6	34	\$246.81
FIYE035L	Passage, Single Locking, LH	US10B	6	33	\$224.40
FIYE035R	Passage, Single Locking, RH	US10B	6	33	\$224.40
FIYE035L-D8	Passage, Single Locking, LH with Removable Cylinder Deadbolt	US10B	6	33	\$230.07
FIYE035R-D8	Passage, Single Locking, RH with Removable Cylinder Deadbolt	US10B	6	33	\$230.07
FIYE035AL	Passage, Single Locking, LH with Small Format I/C (w/o IC core)	US10B	6	33	\$224.40
FIYE035AR	Passage, Single Locking, RH with Small Format I/C (w/o IC core)	US10B	6	33	\$224.40
FIYEP05L	Entry, Double Locking, LH	US15	6	34	\$224.40
FIYEP05R	Entry, Double Locking, RH	US15	6	34	\$224.40
FIYEP35L	Passage, Single Locking, LH	US15	6	33	\$203.99
FIYEP35R	Passage, Single Locking, RH	US15	6	33	\$203.99
FIYEP35L-D8	Passage, Single Locking, LH with Removable Cylinder Deadbolt	US15	6	33	\$208.57
FIYEP35R-D8	Passage, Single Locking, RH with Removable Cylinder Deadbolt	US15	6	33	\$208.57
FIYEP35AL	Passage, Single Locking, LH with Small Format I/C (w/o IC core)	US15	6	33	\$203.99
FIYEP35AR	Passage, Single Locking, RH with Small Format I/C (w/o IC core)	US15	6	33	\$203.99

*Handing: Specify RH/LH

Latch: Deadbolt: 1-1/8"x2-1/4" square corner, adj. backset, UL
 Handle: 1-1/8"x2-1/4" square corner, adj. backset, UL
 Strike: Deadbolt: FD1SPS: 1-1/8"x2-3/4" square corner
 Handle: FT7SPG: 1-1/8"x2-3/4" T-strike square corner

FREMONT



5-1/2" Center-to-Center

Model #	Function	Finish	QTY /Case	Lbs /Case	List Price
W/ DALLAS LEVER					
FIN005	Entry, Double Locking	US10B	6	32	\$246.81
FIN035	Passage, Single Locking	US10B	6	31	\$224.40
FIN035-D8	Passage, Single Locking with Removable Cylinder Deadbolt	US10B	6	31	\$230.07
FIN035A	Passage, Single Locking with Small Format I/C (w/o IC core)	US10B	6	31	\$224.40
FINP05	Entry, Double Locking	US15	6	32	\$224.40
FINP35	Passage, Single Locking	US15	6	31	\$203.99
FINP35-D8	Passage, Single Locking with Removable Cylinder Deadbolt	US15	6	31	\$208.57
FINP35A	Passage, Single Locking with Small Format I/C (w/o IC core)	US15	6	31	\$203.99
FINS05	Entry, Double Locking	US26D	6	32	\$224.40
FINS35	Passage, Single Locking	US26D	6	31	\$203.99
FINS35-D8	Passage, Single Locking with Removable Cylinder Deadbolt	US26D	6	31	\$208.57
FINS35A	Passage, Single Locking with Small Format I/C (w/o IC core)	US26D	6	31	\$203.99

Latch: Deadbolt: 1-1/8"x2-1/4" square corner, adj. backset, UL
 Handle: 1-1/8"x2-1/4" square corner, adj. backset, UL
 Strike: Deadbolt: FD1SPS: 1-1/8"x2-3/4" square corner
 Handle: FT7SPG: 1-1/8"x2-3/4" T-strike square corner

TOLEDO

4" Center-to-Center
Model # Function

Finish

QTY
/Case

Lbs
/Case

List
Price



W/ MIRA LEVER

Model #	Function	Finish	QTY /Case	Lbs /Case	List Price
FIT934	Passage, Single Locking	US19	6	31	\$314.15
FIT234	Passage, Single Locking	US26	6	31	\$285.59
FITP34	Passage, Single Locking	US15	6	31	\$285.59

Latch: Deadbolt: 1-1/8"x2-1/4" square corner, adj. backset, UL
Handle: 1-1/8"x2-1/4" square corner, adj. backset, UL
Strike: Deadbolt: FD1SPS: 1-1/8"x2-3/4" square corner
Handle: FT7SPG: 1-1/8"x2-3/4" T-strike square corner

KENTON

4" Center-to-Center
Model # Function

Finish

QTY
/Case

Lbs
/Case

List
Price



W/ TAHOE LEVER

Model #	Function	Finish	QTY /Case	Lbs /Case	List Price
FIK934	Passage, Single Locking	US19	6	31	\$314.15
FIK234	Passage, Single Locking	US26	6	31	\$285.59
FIKP34	Passage, Single Locking	US15	6	31	\$285.59

Latch: Deadbolt: 1-1/8"x2-1/4" square corner, adj. backset, UL
Handle: 1-1/8"x2-1/4" square corner, adj. backset, UL
Strike: Deadbolt: FD1SPS: 1-1/8"x2-3/4" square corner
Handle: FT7SPG: 1-1/8"x2-3/4" T-strike square corner

STERLING

4" Center-to-Center
Model # Function

Finish

QTY
/Case

Lbs
/Case

List
Price



W/ ONYX LEVER

Model #	Function	Finish	QTY /Case	Lbs /Case	List Price
FIS934	Passage, Single Locking	US19	6	31	\$314.15
FIS234	Passage, Single Locking	US26	6	31	\$285.59
FISP34	Passage, Single Locking	US15	6	31	\$285.59

Latch: Deadbolt: 1-1/8"x2-1/4" square corner, adj. backset, UL
Handle: 1-1/8"x2-1/4" square corner, adj. backset, UL
Strike: Deadbolt: FD1SPS: 1-1/8"x2-3/4" square corner
Handle: FT7SPG: 1-1/8"x2-3/4" T-strike square corner



Optional Vigo Lever with return to meet CA fire code
(See upcharge on page 86)

MIRAGE

5-1/2" Center-to-Center

Model #	Function	Finish	QTY /Case	Lbs /Case	List Price
---------	----------	--------	-----------	-----------	------------



W/ MIRA LEVER

FIT935	Passage, Single Locking	US19	6	31	\$314.15
FIT235	Passage, Single Locking	US26	6	31	\$285.59
FITP35	Passage, Single Locking	US15	6	31	\$285.59

Latch: Deadbolt: 1-1/8"x2-1/4" square corner, adj. backset, UL
 Handle: 1-1/8"x2-1/4" square corner, adj. backset, UL
 Strike: Deadbolt: FD1SPS: 1-1/8"x2-3/4" square corner
 Handle: FT7SPG: 1-1/8"x2-3/4" T-strike square corner

TACOMA

5-1/2" Center-to-Center

Model #	Function	Finish	QTY /Case	Lbs /Case	List Price
---------	----------	--------	-----------	-----------	------------



W/ TAHOE LEVER

FIK935	Passage, Single Locking	US19	6	31	\$314.15
FIK235	Passage, Single Locking	US26	6	31	\$285.59
FIKP35	Passage, Single Locking	US15	6	31	\$285.59

Latch: Deadbolt: 1-1/8"x2-1/4" square corner, adj. backset, UL
 Handle: 1-1/8"x2-1/4" square corner, adj. backset, UL
 Strike: Deadbolt: FD1SPS: 1-1/8"x2-3/4" square corner
 Handle: FT7SPG: 1-1/8"x2-3/4" T-strike square corner

ONTARIO

5-1/2" Center-to-Center

Model #	Function	Finish	QTY /Case	Lbs /Case	List Price
---------	----------	--------	-----------	-----------	------------



W/ ONYX LEVER

FIS935	Passage, Single Locking	US19	6	31	\$314.15
FIS235	Passage, Single Locking	US26	6	31	\$285.59
FISP35	Passage, Single Locking	US15	6	31	\$285.59

Latch: Deadbolt: 1-1/8"x2-1/4" square corner, adj. backset, UL
 Handle: 1-1/8"x2-1/4" square corner, adj. backset, UL
 Strike: Deadbolt: FD1SPS: 1-1/8"x2-3/4" square corner
 Handle: FT7SPG: 1-1/8"x2-3/4" T-strike square corner



Optional Vigo Lever with return to meet CA fire code
 (See upcharge on page 86)

I/C CORE



Model #	Function	Finish	QTY /Case	List Price
FKC-7CCS	7-pin I/C Core (keyed)	US26D	50	\$52.16
FKC-7UCC	7-pin uncombined I/C Core	US26D	50	\$33.01
FKC-7CCB	7-pin I/C Core (keyed)	US4(Brass)	50	\$52.16
FKC-7UCB	7-pin uncombined I/C Core	US4(Brass)	50	\$33.01
FKC-6CCS	6-pin I/C Core (keyed)	US26D	50	\$52.16
FKC-6UCC	6-pin uncombined I/C Core	US26D	50	\$33.01
FKC-6CCB	6-pin I/C Core (keyed)	US4(Brass)	50	\$52.16
FKC-6UCB	6-pin uncombined I/C Core	US4(Brass)	50	\$33.01
FKC-6CCC	6-pin Temporary Construction I/C Core (keyed)	US4(Brass)	50	\$41.73
FKB-IC7	7-pin I/C Core Key Blank		50	\$6.01
FCK-IC7	7-pin I/C Core Control Cut Key		50	\$7.51
FMK-IC7	7-pin I/C Core Master Cut Key		50	\$7.51
FKC-IC7	7-pin I/C Core Cut Key		50	\$7.51
FKB-IC6	6-pin I/C Core Key Blank		50	\$6.01
FCK-IC6	6-pin I/C Core Control Cut Key		50	\$7.51
FMK-IC6	6-pin I/C Core Master Cut Key		50	\$7.51
FKC-IC6	6-pin I/C Core Cut Key		50	\$7.51
FIC-GMK	I/C Core Grand Master Keying Charge			See Page 86

NOTES:

1. Fits BEST, Falcon and Arrow I/C Core.
2. BEST 6-pin "A2" keyway standard, 7-pin available.
3. Lock list price does not include I/C core.
4. I/C Core list prices include KA, KD, MK, keying charges. GMK system extra.
5. 2 control keys per order/job.
6. Temporary construction I/C core may return to Pamex for partial credit.

KEYPAD DEADBOLT



- Features:**
- Easy Installation, no hard wiring needed
 - Fits standard door prep
 - Easy programming. 4-6 digit user code.
 - Optional auto-locking function
 - Back-up key cylinder override
 - Powered by 4x AA batteries ( not included)
 - Non-handed design
 - Meets ANSI Grade 2
 - Allows up to 10 user codes
 - Lifetime mechanical warranty
 - 1 year electronics warranty
 - 5 year finish warranty

Model #	Function	Finish	QTY /Case	Lbs /Case	List Price
FKDD1	Electronic Keypad Deadbolt	US12P	6	24	\$322.92
FKDP1	Electronic Keypad Deadbolt	US15	6	24	\$322.92

Latch: 1"x2-1/4" round corner, adjustable backset
 Strike: FD1SP: 1-1/8"x2-3/4" square corner

KEYPAD LEVERSET



- Features:**
- Easy Installation, no hard wiring needed
 - Fits standard door prep
 - Easy programming. 4-6 digit user code.
 - Automatically relocks after 5 seconds
 - Back-up key cylinder override
 - Powered by 4x AA batteries ( not included)
 - Allows up to 100 user codes
 - Reversible lever fits both LH and RH door
 - ADA Compliant
 - Lifetime mechanical warranty
 - 1 year electronics warranty
 - 5 year finish warranty



Model #	Function	Finish	QTY /Case	Lbs /Case	List Price
FKLYED5	Electronic Keypad Leverset w/Naples Lever	US12P	6	24	\$383.30
FKLYEP5	Electronic Keypad Leverset w/Naples Lever	US15	6	24	\$383.30

Latch: 1"x2-1/4" round corner, adjustable backset
 Strike: FT4SP: 1-3/4"x2-1/4" full lip, round corner

TUSCANY



Model #	Function	Finish	QTY /Case	Lbs /Case	List Price
FST0F1	Single Cylinder	US10B	12	51	\$308.11
FST0F2	Double Cylinder	US10B	12	57	\$327.55
FST0F4	Dummy	US10B	12	44	\$280.89
FSTKF1	Single Cylinder	US11P	12	51	\$308.11
FSTKF2	Double Cylinder	US11P	12	57	\$327.55
FSTKF4	Dummy	US11P	12	44	\$280.89
FSTPF1	Single Cylinder	US15	12	51	\$277.30
FSTPF2	Double Cylinder	US15	12	57	\$294.80
FSTPF4	Dummy	US15	12	44	\$252.80

Latch: Deadbolt: 1"x2-1/4" round corner, adjustable backset
 Handle: 1"x2-1/4" round corner, adjustable backset
 Strike: Deadbolt: FD1SPS: 1-1/8"x2-3/4", square corner
 Handle: FT4SP: 1-3/4"x2-1/4" full lip, round corner

NOTE:

Tuscany series include the **Baron** interior trim as the standard. You may substitute with any knobs or levers at no additional charge, except for Mira, Tahoe, Onyx levers, or Kona knob, which are subject to the upcharges on page 86. Please specify handing on appropriate levers.

CATALINA



Model #	Function	Finish	QTY /Case	Lbs /Case	List Price
FSG031	Single Cylinder	US10B	4	30	\$369.73
FSG032	Double Cylinder	US10B	4	32	\$393.05
FSG034	Dummy	US10B	4	27	\$337.06
FSG731	Single Cylinder	US3	4	30	\$308.11
FSG732	Double Cylinder	US3	4	32	\$327.55
FSG734	Dummy	US3	4	27	\$280.89
FSGC31	Single Cylinder	US15A	4	30	\$332.75
FSGC32	Double Cylinder	US15A	4	32	\$353.75
FSGC34	Dummy	US15A	4	27	\$303.36
FSGP31	Single Cylinder	US15	4	30	\$332.75
FSGP32	Double Cylinder	US15	4	32	\$353.75
FSGP34	Dummy	US15	4	27	\$303.36

Latch: Deadbolt: 1"x2-1/4" round corner, adjustable backset
 Handle: 1"x2-1/4" round corner, adjustable backset
 Strike: Deadbolt: FD1SPS: 1-1/8"x2-3/4", square corner
 Handle: FT4SP: 1-3/4"x2-1/4" full lip, round corner

NOTE:

Catalina series include the **Saturn** interior trim as the standard. You may substitute with any knobs or levers at no additional charge, except for Mira, Tahoe, Onyx levers, or Kona knob, which are subject to the upcharges on page 86. Please specify handing on appropriate levers.

ALHAMBRA



Model #	Function	Finish	QTY /Case	Lbs /Case	List Price
FSLKF1	Single Cylinder	US11P	12	61	\$308.11
FSLKF2	Double Cylinder	US11P	12	67	\$327.55
FSLKF4	Dummy	US11P	12	47	\$280.89
(Lifetime Polished Brass Finish)					
FSLMF1	Single Cylinder	USL03	12	61	\$308.11
FSLMF2	Double Cylinder	USL03	12	67	\$327.55
FSLMF4	Dummy	USL03	12	47	\$280.89
FSLPF1	Single Cylinder	US15	12	61	\$277.30
FSLPF2	Double Cylinder	US15	12	67	\$294.80
FSLPF4	Dummy	US15	12	47	\$252.80

Latch: Deadbolt: 1"x2-1/4" round corner, adjustable backset
 Handle: 1"x2-1/4" round corner, adjustable backset
 Strike: Deadbolt: FD1SPS: 1-1/8"x2-3/4", square corner
 Handle: FT4SP: 1-3/4"x2-1/4" full lip, round corner

GRANADA



Model #	Function	Finish	QTY /Case	Lbs /Case	List Price
FSKKF1	Single Cylinder	US11P	12	60	\$308.11
FSKKF2	Double Cylinder	US11P	12	66	\$327.55
FSKKF4	Dummy	US11P	12	45	\$280.89
(Lifetime Polished Brass Finish)					
FSKMF1	Single Cylinder	USL03	12	60	\$308.11
FSKMF2	Double Cylinder	USL03	12	66	\$327.55
FSKMF4	Dummy	USL03	12	45	\$280.89
FSKPF1	Single Cylinder	US15	12	60	\$277.30
FSKPF2	Double Cylinder	US15	12	66	\$294.80
FSKPF4	Dummy	US15	12	45	\$252.80

Latch: Deadbolt: 1"x2-1/4" round corner, adjustable backset
 Handle: 1"x2-1/4" round corner, adjustable backset
 Strike: Deadbolt: FD1SPS: 1-1/8"x2-3/4", square corner
 Handle: FT4SP: 1-3/4"x2-1/4" full lip, round corner

NOTE:

Alhambra and Granada series include the **Baron** interior trim as the standard. You may substitute with any knobs or levers at no additional charge, except for Mira, Tahoe, Onyx levers, or Kona knob, which are subject to the upcharges on page 86. Please specify handing on appropriate levers.

LEXINGTON

Model #	Function	Finish	QTY /Case	Lbs /Case	List Price
FS7031	Single Cylinder	US10B	12	49	\$236.99
FS7032	Double Cylinder	US10B	12	57	\$251.96
FS7034	Dummy	US10B	12	36	\$216.08
FS7231	Single Cylinder	US26	12	49	\$213.30
FS7232	Double Cylinder	US26	12	57	\$226.78
FS7234	Dummy	US26	12	36	\$194.46
FS7731	Single Cylinder	US3	12	49	\$197.52
FS7732	Double Cylinder	US3	12	57	\$209.97
FS7734	Dummy	US3	12	36	\$180.07
FS7831	Single Cylinder	US5	12	49	\$213.30
FS7832	Double Cylinder	US5	12	57	\$226.78
FS7834	Dummy	US5	12	36	\$194.46
FS7C31	Single Cylinder	US15A	12	49	\$213.30
FS7C32	Double Cylinder	US15A	12	57	\$226.78
FS7C34	Dummy	US15A	12	36	\$194.46
FS7P31	Single Cylinder	US15	12	49	\$213.30
FS7P32	Double Cylinder	US15	12	57	\$226.78
FS7P34	Dummy	US15	12	36	\$194.46
(Lifetime Polished Brass Finish)					
FS7M31	Single Cylinder	USL03	12	49	\$236.99
FS7M32	Double Cylinder	USL03	12	57	\$251.96
FS7M34	Dummy	USL03	12	36	\$216.08
(Pack with Baron interior trim)					
FS7KF1	Single Cylinder	US11P	12	49	\$236.99
FS7KF2	Double Cylinder	US11P	12	57	\$251.96
FS7KF4	Dummy	US11P	12	36	\$216.08
(Pack with Baron interior trim)					
FS79F1	Single Cylinder	US19	12	49	\$236.99
FS79F2	Double Cylinder	US19	12	57	\$251.96
FS79F4	Dummy	US19	12	36	\$216.08

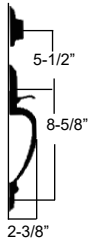

Latch: Deadbolt: 1"x2-1/4" round corner, adjustable backset
 Handle: 1"x2-1/4" round corner, adjustable backset
 Strike: Deadbolt: FD9SP: 1-3/4"x2-1/4" full lip, round corner
 Handle: FT4SP: 1-3/4"x2-1/4" full lip, round corner

NOTE:

Lexington series include the **Saturn** interior trim as standar. (FS7KF1, and FS79F1 include **Baron** interior trim). You may substitute with any knobs or levers at no additional charge, except for Mira, Tahoe, Onyx levers, or Kona knob, which are subject to the upcharges on page 86. Please specify handing on appropriate levers.

VICTORIAN



Model #	Function	Finish	QTY /Case	Lbs /Case	List Price
FS3731	Single Cylinder	US3	12	52	\$197.52
FS3732	Double Cylinder	US3	12	58	\$209.97
FS3734	Dummy	US3	12	45	\$180.07
FS3P31	Single Cylinder	US15	12	52	\$213.30
FS3P32	Double Cylinder	US15	12	58	\$226.78
FS3P34	Dummy	US15	12	45	\$194.46

Latch: Deadbolt: 1"x2-1/4" round corner, adjustable backset
 Handle: 1"x2-1/4" round corner, adjustable backset
 Strike: Deadbolt: FD9SP: 1-3/4"x2-1/4" full lip, round corner
 Handle: FT4SP: 1-3/4"x2-1/4" full lip, round corner

SPRINGFIELD

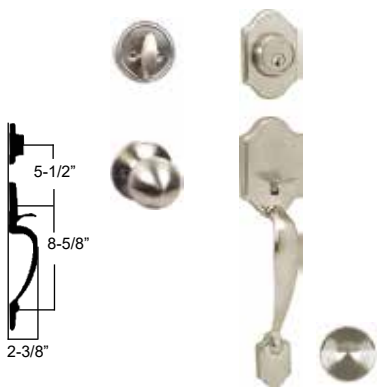

Model #	Function	Finish	QTY /Case	Lbs /Case	List Price
FSC731	Single Cylinder	US3	12	51	\$197.52
FSC732	Double Cylinder	US3	12	57	\$209.97
FSC734	Dummy	US3	12	44	\$180.07
FSCP31	Single Cylinder	US15	12	52	\$213.30
FSCP32	Double Cylinder	US15	12	58	\$226.78
FSCP34	Dummy	US15	12	45	\$194.46

Latch: Deadbolt: 1"x2-1/4" round corner, adjustable backset
 Handle: 1"x2-1/4" round corner, adjustable backset
 Strike: Deadbolt: FD9SP: 1-3/4"x2-1/4" full lip, round corner
 Handle: FT4SP: 1-3/4"x2-1/4" full lip, round corner

NOTE:

Victorian and Springfield series include the **Saturn** interior trim as the standard. You may substitute with any knobs or levers at no additional charge, except for Mira, Tahoe, Onyx levers, or Kona knob, which are subject to the upcharges on page 86. Please specify handing on appropriate levers.

TROY



Model #	Function	Finish	QTY /Case	Lbs /Case	List Price
FHS031	Single Cylinder	US10B	6	31	\$236.99
FHS032	Double Cylinder	US10B	6	35	\$251.96
FHS034	Dummy	US10B	6	27	\$216.08
FHS9F1	Single Cylinder	US19	6	31	\$236.99
FHS9F2	Double Cylinder	US19	6	35	\$251.96
FHS9F4	Dummy	US19	6	27	\$216.08
FHS231	Single Cylinder	US26	6	31	\$213.30
FHS232	Double Cylinder	US26	6	35	\$226.78
FHS234	Dummy	US26	6	27	\$194.46
FHSP31	Single Cylinder	US15	6	31	\$213.30
FHSP32	Double Cylinder	US15	6	35	\$226.78
FHSP34	Dummy	US15	6	27	\$194.46
FHSKF1	Single Cylinder	US11P	6	31	\$236.99
FHSKF2	Double Cylinder	US11P	6	35	\$251.96
FHSKF4	Dummy	US11P	6	27	\$216.08

Latch: Deadbolt: 1"x2-1/4" round corner, adjustable backset
 Handle: 1"x2-1/4" round corner, adjustable backset
 Strike: Deadbolt: FD9SP: 1-3/4"x2-1/4" full lip, round corner
 Handle: FT4SP: 1-3/4"x2-1/4" full lip, round corner

NOTE: Troy series include the **Saturn** interior trim as standard. (FHSKF1, FHS9F1 include **Baron** interior trim).

TROY		Model #	Function	Finish	QTY /Case	Lbs /Case	List Price
	FHS9LT1	Single Cylinder w/Mira Inside Trim	US19	6	33	\$273.32	
	FHS9LT2	Double Cylinder w/Mira Inside Trim	US19	6	37	\$288.29	
	FHS9LT4	Dummy w/Mira Inside Trim	US19	6	29	\$252.39	
	FHS2LT1	Single Cylinder w/Mira Inside Trim	US26	6	33	\$245.98	
	FHS2LT2	Double Cylinder w/Mira Inside Trim	US26	6	37	\$259.46	
	FHS2LT4	Dummy w/Mira Inside Trim	US26	6	29	\$227.14	
	FHSPLT1	Single Cylinder w/Mira Inside Trim	US15	6	33	\$245.98	
	FHSPLT2	Double Cylinder w/Mira Inside Trim	US15	6	37	\$259.46	
	FHSPLT4	Dummy w/Mira Inside Trim	US15	6	29	\$227.14	
		FHS9LK1L	Single Cylinder w/Tahoe Inside Trim, LH	US19	6	33	\$273.32
		FHS9LK1R	Single Cylinder w/Tahoe Inside Trim, RH	US19	6	33	\$273.32
		FHS9LK2L	Double Cylinder w/Tahoe Inside Trim, LH	US19	6	37	\$288.29
FHS9LK2R		Double Cylinder w/Tahoe Inside Trim, RH	US19	6	37	\$288.29	
FHS9LK4L		Dummy w/Tahoe Inside Trim, LH	US19	6	29	\$252.39	
FHS9LK4R		Dummy w/Tahoe Inside Trim, RH	US19	6	29	\$252.39	
FHS2LK1L		Single Cylinder w/Tahoe Inside Trim, LH	US26	6	33	\$245.98	
FHS2LK1R		Single Cylinder w/Tahoe Inside Trim, RH	US26	6	33	\$245.98	
FHS2LK2L		Double Cylinder w/Tahoe Inside Trim, LH	US26	6	37	\$259.46	
FHS2LK2R		Double Cylinder w/Tahoe Inside Trim, RH	US26	6	37	\$259.46	
FHS2LK4L		Dummy w/Tahoe Inside Trim, LH	US26	6	29	\$227.14	
FHS2LK4R		Dummy w/Tahoe Inside Trim, RH	US26	6	29	\$227.14	
	FHS9LS1	Single Cylinder w/Onyx Inside Trim	US19	6	33	\$273.32	
	FHS9LS2	Double Cylinder w/Onyx Inside Trim	US19	6	37	\$288.29	
	FHS9LS4	Dummy w/Onyx Inside Trim	US19	6	29	\$252.39	
	FHS2LS1	Single Cylinder w/Onyx Inside Trim	US26	6	33	\$245.98	
	FHS2LS2	Double Cylinder w/Onyx Inside Trim	US26	6	37	\$259.46	
	FHS2LS4	Dummy w/Onyx Inside Trim	US26	6	29	\$227.14	
	FHSPLS1	Single Cylinder w/Onyx Inside Trim	US15	6	33	\$245.98	
	FHSPLS2	Double Cylinder w/Onyx Inside Trim	US15	6	37	\$259.46	
	FHSPLS4	Dummy w/Onyx Inside Trim	US15	6	29	\$227.14	

**Handing: Specify RH/LH*

(With Naples Lever)

Model #	Function	Finish	QTY /Case	Lbs /Case	List Price
FST0YEI-L	Tuscany, Int'd Trim w/ Naples Lever, LH	US10B	6	31	\$367.84
FST0YEI-R	Tuscany, Int'd Trim w/ Naples Lever, RH	US10B	6	31	\$367.84
FSTKYEI-L	Tuscany, Int'd Trim w/ Naples Lever, LH	US11P	6	31	\$367.84
FSTKYEI-R	Tuscany, Int'd Trim w/ Naples Lever, RH	US11P	6	31	\$367.84
FSTPYEI-L	Tuscany, Int'd Trim w/ Naples Lever, LH	US15	6	31	\$329.24
FSTPYEI-R	Tuscany, Int'd Trim w/ Naples Lever, RH	US15	6	31	\$329.24
FSKKYEI-L	Granada, Int'd Trim w/ Naples Lever, LH	US11P	6	31	\$367.84
FSKKYEI-R	Granada, Int'd Trim w/ Naples Lever, RH	US11P	6	31	\$367.84
FSKPYEI-L	Granada, Int'd Trim w/ Naples Lever, LH	US15	6	31	\$329.24
FSKPYEI-R	Granada, Int'd Trim w/ Naples Lever, RH	US15	6	31	\$329.24
FSCPYEI-L	Springfield, Int'd Trim w/ Naples Lever, LH	US15	6	31	\$265.25
FSCPYEI-R	Springfield, Int'd Trim w/ Naples Lever, RH	US15	6	31	\$265.25
FS3PYEI-L	Victorian, Int'd Trim w/ Naples Lever, LH	US15	6	31	\$265.25
FS3PYEI-R	Victorian, Int'd Trim w/ Naples Lever, RH	US15	6	31	\$265.25
FHS0YEI-L	Troy, Int'd Trim w/ Naples Lever, LH	US10B	6	31	\$296.72
FHS0YEI-R	Troy, Int'd Trim w/ Naples Lever, RH	US10B	6	31	\$296.72
FHS9YEI-L	Troy, Int'd Trim w/ Naples Lever, LH	US19	6	31	\$296.72
FHS9YEI-R	Troy, Int'd Trim w/ Naples Lever, RH	US19	6	31	\$296.72
FHSPYEI-L	Troy, Int'd Trim w/ Naples Lever, LH	US15	6	31	\$265.25
FHSPYEI-R	Troy, Int'd Trim w/ Naples Lever, RH	US15	6	31	\$265.25



**Handing: Specify RH/LH*

(With Newberry Lever)

FST0AI-L	Tuscany, Int'd Trim w/ Newberry Lever, LH	US10B	6	31	\$367.84
FST0AI-R	Tuscany, Int'd Trim w/ Newberry Lever, RH	US10B	6	31	\$367.84
FSTPAI-L	Tuscany, Int'd Trim w/ Newberry Lever, LH	US15	6	31	\$329.24
FSTPAI-R	Tuscany, Int'd Trim w/ Newberry Lever, RH	US15	6	31	\$329.24
FSKPAI-L	Granada, Int'd Trim w/ Newberry Lever, LH	US15	6	31	\$329.24
FSKPAI-R	Granada, Int'd Trim w/ Newberry Lever, RH	US15	6	31	\$329.24
FSCPAI-L	Springfield, Int'd Trim w/ Newberry Lever, LH	US15	6	31	\$265.25
FSCPAI-R	Springfield, Int'd Trim w/ Newberry Lever, RH	US15	6	31	\$265.25
FS3PAI-L	Victorian, Int'd Trim w/ Newberry Lever, LH	US15	6	31	\$265.25
FS3PAI-R	Victorian, Int'd Trim w/ Newberry Lever, RH	US15	6	31	\$265.25
FHS0AI-L	Troy, Int'd Trim w/ Newberry Lever, LH	US10B	6	31	\$296.72
FHS0AI-R	Troy, Int'd Trim w/ Newberry Lever, RH	US10B	6	31	\$296.72
FHSPAI-L	Troy, Int'd Trim w/ Newberry Lever, LH	US15	6	31	\$265.25
FHSPAI-R	Troy, Int'd Trim w/ Newberry Lever, RH	US15	6	31	\$265.25



**Handing: Specify RH/LH*

(With Naples Lever)

FITS-LYE0-L	Interconnected Trim with Naples Lever, LH	US10B	12	25	\$59.73
FITS-LYE0-R	Interconnected Trim with Naples Lever, RH	US10B	12	25	\$59.73
FITS-LYE9-L	Interconnected Trim with Naples Lever, LH	US19	12	25	\$59.73
FITS-LYE9-R	Interconnected Trim with Naples Lever, RH	US19	12	25	\$59.73
FITS-LYEK-L	Interconnected Trim with Naples Lever, LH	US11P	12	25	\$59.73
FITS-LYEK-R	Interconnected Trim with Naples Lever, RH	US11P	12	25	\$59.73
FITS-LYEP-L	Interconnected Trim with Naples Lever, LH	US15	12	25	\$51.94
FITS-LYEP-R	Interconnected Trim with Naples Lever, RH	US15	12	25	\$51.94







**Handing: Specify RH/LH*

(With Newberry Lever)

FITS-LA0-L	Interconnected Trim with Newberry Lever, LH	US10B	12	25	\$59.73
FITS-LA0-R	Interconnected Trim with Newberry Lever, RH	US10B	12	25	\$59.73
FITS-LAP-L	Interconnected Trim with Newberry Lever, LH	US15	12	25	\$51.94
FITS-LAP-R	Interconnected Trim with Newberry Lever, RH	US15	12	25	\$51.94



	Model #	Function	Finish	QTY /Case	Lbs /Case	List Price
<p><i>*Handing: Specify RH/LH</i></p> 	(With Naples Lever)					
	FSLKYEI-L	Alhambra, Int'd Trim w/ Naples Lever, LH	US11P	6	31	\$367.84
	FSLKYEI-R	Alhambra, Int'd Trim w/ Naples Lever, RH	US11P	6	31	\$367.84
	FSLPYEI-L	Alhambra, Int'd Trim w/ Naples Lever, LH	US15	6	31	\$329.24
	FSLPYEI-R	Alhambra, Int'd Trim w/ Naples Lever, RH	US15	6	31	\$329.24
	FS70YEI-L	Lexington, Int'd Trim w/ Naples Lever, LH	US10B	6	31	\$296.72
	FS70YEI-R	Lexington, Int'd Trim w/ Naples Lever, RH	US10B	6	31	\$296.72
	FS79YEI-L	Lexington, Int'd Trim w/ Naples Lever, LH	US19	6	31	\$296.72
	FS79YEI-R	Lexington, Int'd Trim w/ Naples Lever, RH	US19	6	31	\$296.72
	FS7KYEI-L	Lexington, Int'd Trim w/ Naples Lever, LH	US11P	6	31	\$296.72
	FS7KYEI-R	Lexington, Int'd Trim w/ Naples Lever, RH	US11P	6	31	\$296.72
	FS7PYEI-L	Lexington, Int'd Trim w/ Naples Lever, LH	US15	6	31	\$265.25
	FS7PYEI-R	Lexington, Int'd Trim w/ Naples Lever, RH	US15	6	31	\$265.25
	FSG0YEI-L	Catalina, Int'd Trim w/ Naples Lever, LH	US10B	4	36	\$429.47
	FSG0YEI-R	Catalina, Int'd Trim w/ Naples Lever, RH	US10B	4	36	\$429.47
	FSGPYEI-L	Catalina, Int'd Trim w/ Naples Lever, LH	US15	4	36	\$384.68
	FSGPYEI-R	Catalina, Int'd Trim w/ Naples Lever, RH	US15	4	36	\$384.68
	<p><i>*Handing: Specify RH/LH</i></p> 	(With Newberry Lever)				
FSLPAI-L		Alhambra, Int'd Trim w/ Newberry Lever, LH	US15	6	31	\$329.24
FSLPAI-R		Alhambra, Int'd Trim w/ Newberry Lever, RH	US15	6	31	\$329.24
FS70AI-L		Lexington, Int'd Trim w/ Newberry Lever, LH	US10B	6	31	\$296.72
FS70AI-R		Lexington, Int'd Trim w/ Newberry Lever, RH	US10B	6	31	\$296.72
FS7PAI-L		Lexington, Int'd Trim w/ Newberry Lever, LH	US15	6	31	\$265.25
FS7PAI-R		Lexington, Int'd Trim w/ Newberry Lever, RH	US15	6	31	\$265.25
FSG0AI-L		Catalina, Int'd Trim w/ Newberry Lever, LH	US10B	4	36	\$429.47
FSG0AI-R		Catalina, Int'd Trim w/ Newberry Lever, RH	US10B	4	36	\$429.47
FSGPAI-L		Catalina, Int'd Trim w/ Newberry Lever, LH	US15	4	36	\$384.68
FSGPAI-R	Catalina, Int'd Trim w/ Newberry Lever, RH	US15	4	36	\$384.68	
<p><i>*Handing: Specify RH/LH</i></p> 	(With Naples Lever)					
	FIT-LYE0-L	Interconnected Trim with Naples Lever, LH	US10B	12	25	\$59.73
	FIT-LYE0-R	Interconnected Trim with Naples Lever, RH	US10B	12	25	\$59.73
	FIT-LYE9-L	Interconnected Trim with Naples Lever, LH	US19	12	25	\$59.73
	FIT-LYE9-R	Interconnected Trim with Naples Lever, RH	US19	12	25	\$59.73
	FIT-LYEK-L	Interconnected Trim with Naples Lever, LH	US11P	12	25	\$59.73
	FIT-LYEK-R	Interconnected Trim with Naples Lever, RH	US11P	12	25	\$59.73
	FIT-LYEP-L	Interconnected Trim with Naples Lever, LH	US15	12	25	\$51.94
FIT-LYEP-R	Interconnected Trim with Naples Lever, RH	US15	12	25	\$51.94	
<p><i>*Handing: Specify RH/LH</i></p> 	(With Newberry Lever)					
	FIT-LA0-L	Interconnected Trim with Newberry Lever, LH	US10B	12	25	\$59.73
	FIT-LA0-R	Interconnected Trim with Newberry Lever, RH	US10B	12	25	\$59.73
	FIT-LAP-L	Interconnected Trim with Newberry Lever, LH	US15	12	25	\$51.94
FIT-LAP-R	Interconnected Trim with Newberry Lever, RH	US15	12	25	\$51.94	

MIRA

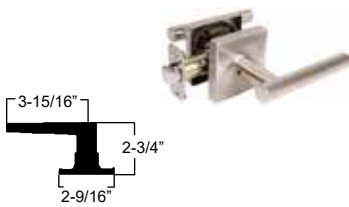

Latch: 1"x2-1/4" round corner, adjustable backset (FTR66C--45° latch)
Strike: 1-3/4"x2-1/4" full lip, round corner (FT4SP)

Model #	Function	Finish	QTY /Case	Lbs /Case	List Price
FLT908C	ADA Privacy (push button)	US19	12	28	\$82.42
FLT903C	Passage	US19	12	27	\$78.64
FLT904	Half Dummy Trim	US19	25	24	\$37.75
FLT208C	ADA Privacy (push button)	US26	12	28	\$74.17
FLT203C	Passage	US26	12	27	\$70.78
FLT204	Half Dummy Trim	US26	25	24	\$33.99
FLTP08C	ADA Privacy (push button)	US15	12	28	\$74.17
FLTP03C	Passage	US15	12	27	\$70.78
FLTP04	Half Dummy Trim	US15	25	24	\$33.99
With Square Rosette — Non-stocked Items					
FLT908CS	ADA Privacy (push button)	US19	12	28	\$86.99
FLT903CS	Passage	US19	12	27	\$83.22
FLT904S	Half Dummy Trim	US19	25	24	\$40.04
FLT208CS	ADA Privacy (push button)	US26	12	28	\$78.75
FLT203CS	Passage	US26	12	27	\$75.36
FLT204S	Half Dummy Trim	US26	25	24	\$36.27
FLTP08CS	ADA Privacy (push button)	US15	12	28	\$78.75
FLTP03CS	Passage	US15	12	27	\$75.36
FLTP04S	Half Dummy Trim	US15	25	24	\$36.27

TAHOE

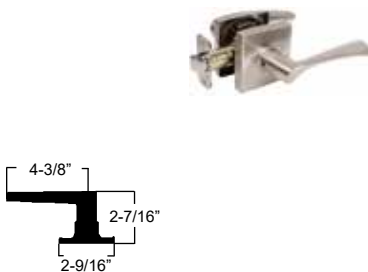

Latch: 1"x2-1/4" round corner, adjustable backset (FTR66C--45° latch)
Strike: 1-3/4"x2-1/4" full lip, round corner (FT4SP)

Model #	Function	Finish	QTY /Case	Lbs /Case	List Price
FLK908C	ADA Privacy (push button)	US19	12	28	\$82.42
FLK903C	Passage	US19	12	27	\$78.64
FLK904L	Half Dummy Trim, LH	US19	25	24	\$37.75
FLK904R	Half Dummy Trim, RH	US19	25	24	\$37.75
FLK208C	ADA Privacy (push button)	US26	12	28	\$74.17
FLK203C	Passage	US26	12	27	\$70.78
FLK204L	Half Dummy Trim, LH	US26	25	24	\$33.99
FLK204R	Half Dummy Trim, RH	US26	25	24	\$33.99
FLKP08C	ADA Privacy (push button)	US15	12	28	\$74.17
FLKP03C	Passage	US15	12	27	\$70.78
FLKP04L	Half Dummy Trim, LH	US15	25	24	\$33.99
FLKP04R	Half Dummy Trim, RH	US15	25	24	\$33.99
With Square Rosette — Non-stocked Items					
FLK908CS	ADA Privacy (push button)	US19	12	28	\$86.99
FLK903CS	Passage	US19	12	27	\$83.22
FLK904LS	Half Dummy Trim, LH	US19	25	24	\$40.04
FLK904RS	Half Dummy Trim, RH	US19	25	24	\$40.04
FLK208CS	ADA Privacy (push button)	US26	12	28	\$78.75
FLK203CS	Passage	US26	12	27	\$75.36
FLK204LS	Half Dummy Trim, LH	US26	25	24	\$36.27
FLK204RS	Half Dummy Trim, RH	US26	25	24	\$36.27
FLKP08CS	ADA Privacy (push button)	US15	12	28	\$78.75
FLKP03CS	Passage	US15	12	27	\$75.36
FLKP04LS	Half Dummy Trim, LH	US15	25	24	\$36.27
FLKP04RS	Half Dummy Trim, RH	US15	25	24	\$36.27

ONYX



ADA



Model #	Function	Finish	QTY /Case	Lbs /Case	List Price
FLS908C	ADA Privacy (push button)	US19	12	28	\$82.42
FLS903C	Passage	US19	12	27	\$78.64
FLS904	Half Dummy Trim	US19	25	24	\$37.75
FLS208C	ADA Privacy (push button)	US26	12	28	\$74.17
FLS203C	Passage	US26	12	27	\$70.78
FLS204	Half Dummy Trim	US26	25	12	\$33.99
FLSP08C	ADA Privacy (push button)	US15	12	28	\$74.17
FLSP03C	Passage	US15	12	27	\$70.78
FLSP04	Half Dummy Trim	US15	25	12	\$33.99

With Round Rosette — Non-stocked Items



FLS908CR	ADA Privacy (push button)	US19	12	28	\$86.99
FLS903CR	Passage	US19	12	27	\$83.22
FLS904R	Half Dummy Trim	US19	25	24	\$40.04
FLS208CR	ADA Privacy (push button)	US26	12	28	\$78.75
FLS203CR	Passage	US26	12	27	\$75.36
FLS204R	Half Dummy Trim	US26	25	12	\$36.27
FLSP08CR	ADA Privacy (push button)	US15	12	28	\$78.75
FLSP03CR	Passage	US15	12	27	\$75.36
FLSP04R	Half Dummy Trim	US15	25	12	\$36.27

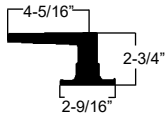

Latch: 1"x2-1/4" round corner, adjustable backset (FTR66C--45° latch)
 Strike: 1-3/4"x2-1/4" full lip, round corner (FT4SP)

NOTE: UL Listed backsets are available for purchasing, see page 78-79. Upcharge for change to UL backsets, see page 86.

ALTO



Model #	Function	Finish	QTY /Case	Lbs /Case	List Price
FLF900	Entry	US19	24	50	\$74.47
FLF901	Privacy	US19	24	44	\$59.00
FLF903	Passage	US19	24	42	\$58.08
FLF904	Half Dummy Trim	US19	50	34	\$26.85
FLF907C	ADA Entry (push button)	US19	24	50	\$85.79
FLF908C	ADA Privacy (push button)	US19	24	44	\$68.01
FLF200	Entry	US26	24	50	\$67.02
FLF201	Privacy	US26	24	44	\$53.09
FLF203	Passage	US26	24	42	\$52.25
FLF204	Half Dummy Trim	US26	50	34	\$24.17
FLF207C	ADA Entry (push button)	US26	24	50	\$77.24
FLF208C	ADA Privacy (push button)	US26	24	44	\$61.21
FLFP00	Entry	US15	24	50	\$67.02
FLFP01	Privacy	US15	24	44	\$53.09
FLFP03	Passage	US15	24	42	\$52.25
FLFP04	Half Dummy Trim	US15	50	34	\$24.17
FLFP07C	ADA Entry (push button)	US15	24	50	\$77.24
FLFP08C	ADA Privacy (push button)	US15	24	44	\$61.21

With Square Rosette — Non-stocked Items

FLF900S	Entry	US19	24	50	\$82.25
FLF901S	Privacy	US19	24	44	\$66.78
FLF903S	Passage	US19	24	42	\$65.85
FLF904S	Half Dummy Trim	US19	50	34	\$30.74
FLF907CS	ADA Entry (push button)	US19	24	50	\$93.57
FLF908CS	ADA Privacy (push button)	US19	24	44	\$75.78
FLF200S	Entry	US26	24	50	\$74.80
FLF201S	Privacy	US26	24	44	\$60.87
FLF203S	Passage	US26	24	42	\$60.03
FLF204S	Half Dummy Trim	US26	50	34	\$28.06
FLF207CS	ADA Entry (push button)	US26	24	50	\$85.01
FLF208CS	ADA Privacy (push button)	US26	24	44	\$68.99
FLFP00S	Entry	US15	24	50	\$74.80
FLFP01S	Privacy	US15	24	44	\$60.87
FLFP03S	Passage	US15	24	42	\$60.03
FLFP04S	Half Dummy Trim	US15	50	34	\$28.06
FLFP07CS	ADA Entry (push button)	US15	24	50	\$85.01
FLFP08CS	ADA Privacy (push button)	US15	24	44	\$68.99

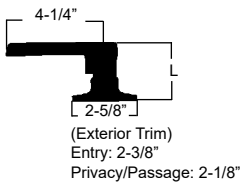

Latch: 1"x2-1/4" round corner, adjustable backset
Strike: FT4SP: 1-3/4"x2-1/4" full lip, round corner

NOTE: UL Listed backsets are available for purchasing, see page 78-79. Upcharge for change to UL backsets, see page 86.

NAPLES

*Handing: Specify RH/LH

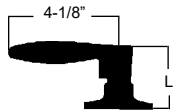

(Exterior Trim)
Entry: 2-3/8"
Privacy/Passage: 2-1/8"

Latch: 1"x2-1/4" round corner, adjustable backset
Strike: FT4SP: 1-3/4"x2-1/4" full lip, round corner

Model #	Function	Finish	QTY /Case	Lbs /Case	List Price
FLYE000L	Entry, LH	US10B	24	46	\$68.91
FLYE000R	Entry, RH	US10B	24	46	\$68.91
FLYE001L	Privacy, LH	US10B	24	40	\$54.60
FLYE001R	Privacy, RH	US10B	24	40	\$54.60
FLYE003L	Passage, LH	US10B	24	38	\$53.75
FLYE003R	Passage, RH	US10B	24	38	\$53.75
FLYE004L	Half Dummy Trim, LH	US10B	50	30	\$24.85
FLYE004R	Half Dummy Trim, RH	US10B	50	30	\$24.85
FLYE007CL	ADA Entry, LH (push button)	US10B	24	46	\$79.40
FLYE007CR	ADA Entry, RH (push button)	US10B	24	46	\$79.40
FLYE008CL	ADA Privacy, LH (push button)	US10B	24	40	\$62.93
FLYE008CR	ADA Privacy, RH (push button)	US10B	24	40	\$62.93
FLYE200L	Entry, LH	US26	24	46	\$62.02
FLYE200R	Entry, RH	US26	24	46	\$62.02
FLYE201L	Privacy, LH	US26	24	40	\$49.13
FLYE201R	Privacy, RH	US26	24	40	\$49.13
FLYE203L	Passage, LH	US26	24	38	\$48.35
FLYE203R	Passage, RH	US26	24	38	\$48.35
FLYE204L	Half Dummy Trim, LH	US26	50	30	\$22.36
FLYE204R	Half Dummy Trim, RH	US26	50	30	\$22.36
FLYE207CL	ADA Entry, LH (push button)	US26	24	46	\$71.47
FLYE207CR	ADA Entry, RH (push button)	US26	24	46	\$71.47
FLYE208CL	ADA Privacy, LH (push button)	US26	24	40	\$56.65
FLYE208CR	ADA Privacy, RH (push button)	US26	24	40	\$56.65
FLYE700L	Entry, LH	US3	24	46	\$57.41
FLYE700R	Entry, RH	US3	24	46	\$57.41
FLYE701L	Privacy, LH	US3	24	40	\$45.50
FLYE701R	Privacy, RH	US3	24	40	\$45.50
FLYE703L	Passage, LH	US3	24	38	\$44.80
FLYE703R	Passage, RH	US3	24	38	\$44.80
FLYE704L	Half Dummy Trim, LH	US3	50	30	\$20.69
FLYE704R	Half Dummy Trim, RH	US3	50	30	\$20.69
FLYE900L	Entry, LH	US19	24	46	\$68.91
FLYE900R	Entry, RH	US19	24	46	\$68.91
FLYE901L	Privacy, LH	US19	24	40	\$54.60
FLYE901R	Privacy, RH	US19	24	40	\$54.60
FLYE903L	Passage, LH	US19	24	38	\$53.75
FLYE903R	Passage, RH	US19	24	38	\$53.75
FLYE904L	Half Dummy Trim, LH	US19	50	30	\$24.85
FLYE904R	Half Dummy Trim, RH	US19	50	30	\$24.85
FLYE907CL	ADA Entry, LH (push button)	US19	24	46	\$79.40
FLYE907CR	ADA Entry, RH (push button)	US19	24	46	\$79.40
FLYE908CL	ADA Privacy, LH (push button)	US19	24	40	\$62.93
FLYE908CR	ADA Privacy, RH (push button)	US19	24	40	\$62.93

RESIDENTIAL LOCKS

NOTE: UL Listed backsets are available for purchasing, see page 78-79. Upcharge for change to UL backsets, see page 86.

NAPLES

*Handing: Specify RH/LH



ADA

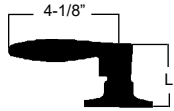

(Exterior Trim)
Entry: 2-3/8"
Privacy/Passage: 2-1/8"

Latch: 1"x2-1/4" round corner, adjustable backset
Strike: FT4SP: 1-3/4"x2-1/4" full lip, round corner

Model #	Function	Finish	QTY /Case	Lbs /Case	List Price
FLYEC00L	Entry, LH	US15A	24	46	\$62.02
FLYEC00R	Entry, RH	US15A	24	46	\$62.02
FLYEC01L	Privacy, LH	US15A	24	40	\$49.13
FLYEC01R	Privacy, RH	US15A	24	40	\$49.13
FLYEC03L	Passage, LH	US15A	24	38	\$48.35
FLYEC03R	Passage, RH	US15A	24	38	\$48.35
FLYEC04L	Half Dummy Trim, LH	US15A	50	30	\$22.36
FLYEC04R	Half Dummy Trim, RH	US15A	50	30	\$22.36
FLYEK00L	Entry, LH	US11P	24	46	\$68.91
FLYEK00R	Entry, RH	US11P	24	46	\$68.91
FLYEK01L	Privacy, LH	US11P	24	40	\$54.60
FLYEK01R	Privacy, RH	US11P	24	40	\$54.60
FLYEK03L	Passage, LH	US11P	24	38	\$53.75
FLYEK03R	Passage, RH	US11P	24	38	\$53.75
FLYEK04L	Half Dummy Trim, LH	US11P	50	30	\$24.85
FLYEK04R	Half Dummy Trim, RH	US11P	50	30	\$24.85
FLYEK07CL	ADA Entry, LH (push button)	US11P	24	46	\$79.40
FLYEK07CR	ADA Entry, RH (push button)	US11P	24	46	\$79.40
FLYEK08CL	ADA Privacy, LH (push button)	US11P	24	40	\$62.93
FLYEK08CR	ADA Privacy, RH (push button)	US11P	24	40	\$62.93
FLYEP00L	Entry, LH	US15	24	46	\$62.02
FLYEP00R	Entry, RH	US15	24	46	\$62.02
FLYEP01L	Privacy, LH	US15	24	40	\$49.13
FLYEP01R	Privacy, RH	US15	24	40	\$49.13
FLYEP03L	Passage, LH	US15	24	38	\$48.35
FLYEP03R	Passage, RH	US15	24	38	\$48.35
FLYEP04L	Half Dummy Trim, LH	US15	50	30	\$22.36
FLYEP04R	Half Dummy Trim, RH	US15	50	30	\$22.36
FLYEP07CL	ADA Entry, LH (push button)	US15	24	46	\$71.47
FLYEP07CR	ADA Entry, RH (push button)	US15	24	46	\$71.47
FLYEP08CL	ADA Privacy, LH (push button)	US15	24	40	\$56.65
FLYEP08CR	ADA Privacy, RH (push button)	US15	24	40	\$56.65

NOTE: UL Listed backsets are available for purchasing, see page 78-79. Upcharge for change to UL backsets, see page 86.

NEWBERRY

*Handing: Specify RH/LH

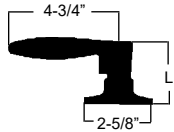

(Exterior Trim)
Entry: 2-3/8"
Privacy/Passage: 2"

Latch: 1"x2-1/4" round corner, adjustable backset
Strike: FT4SP: 1-3/4"x2-1/4" full lip, round corner

Model #	Function	Finish	QTY /Case	Lbs /Case	List Price
FLA000L	Entry, LH	US10B	24	47	\$68.91
FLA000R	Entry, RH	US10B	24	47	\$68.91
FLA001L	Privacy, LH	US10B	24	42	\$54.60
FLA001R	Privacy, RH	US10B	24	42	\$54.60
FLA003L	Passage, LH	US10B	24	39	\$53.75
FLA003R	Passage, RH	US10B	24	39	\$53.75
FLA004L	Half Dummy Trim, LH	US10B	50	33	\$24.85
FLA004R	Half Dummy Trim, RH	US10B	50	33	\$24.85
FLA007CL	ADA Entry, LH (push button)	US10B	24	46	\$79.40
FLA007CR	ADA Entry, RH (push button)	US10B	24	46	\$79.40
FLA008CL	ADA Privacy, LH (push button)	US10B	24	40	\$62.93
FLA008CR	ADA Privacy, RH (push button)	US10B	24	40	\$62.93
FLA700L	Entry, LH	US3	24	47	\$57.41
FLA700R	Entry, RH	US3	24	47	\$57.41
FLA701L	Privacy, LH	US3	24	42	\$45.50
FLA701R	Privacy, RH	US3	24	42	\$45.50
FLA703L	Passage, LH	US3	24	39	\$44.80
FLA703R	Passage, RH	US3	24	39	\$44.80
FLA704L	Half Dummy Trim, LH	US3	50	33	\$20.69
FLA704R	Half Dummy Trim, RH	US3	50	33	\$20.69
FLAC00L	Entry, LH	US15A	24	47	\$62.02
FLAC00R	Entry, RH	US15A	24	47	\$62.02
FLAC01L	Privacy, LH	US15A	24	42	\$49.13
FLAC01R	Privacy, RH	US15A	24	42	\$49.13
FLAC03L	Passage, LH	US15A	24	39	\$48.35
FLAC03R	Passage, RH	US15A	24	39	\$48.35
FLAC04L	Half Dummy Trim, LH	US15A	50	33	\$22.36
FLAC04R	Half Dummy Trim, RH	US15A	50	33	\$22.36
FLAP00L	Entry, LH	US15	24	47	\$62.02
FLAP00R	Entry, RH	US15	24	47	\$62.02
FLAP01L	Privacy, LH	US15	24	42	\$49.13
FLAP01R	Privacy, RH	US15	24	42	\$49.13
FLAP03L	Passage, LH	US15	24	39	\$48.35
FLAP03R	Passage, RH	US15	24	39	\$48.35
FLAP04L	Half Dummy Trim, LH	US15	50	33	\$22.36
FLAP04R	Half Dummy Trim, RH	US15	50	33	\$22.36
FLAP07CL	ADA Entry, LH (push button)	US15	24	46	\$71.47
FLAP07CR	ADA Entry, RH (push button)	US15	24	46	\$71.47
FLAP08CL	ADA Privacy, LH (push button)	US15	24	40	\$56.65
FLAP08CR	ADA Privacy, RH (push button)	US15	24	40	\$56.65

RESIDENTIAL LOCKS

NOTE: UL Listed backsets are available for purchasing, see page 78-79. Upcharge for change to UL backsets, see page 86.

VIANO

*Handing: Specify RH/LH

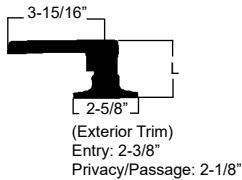

Latch: 1"x2-1/4" round corner, adjustable backset
Strike: FT4SP: 1-3/4"x2-1/4" full lip, round corner

Model #	Function	Finish	QTY /Case	Lbs /Case	List Price
FLV000L	Entry, LH	US10B	24	44	\$68.91
FLV000R	Entry, RH	US10B	24	44	\$68.91
FLV001L	Privacy, LH	US10B	24	39	\$54.60
FLV001R	Privacy, RH	US10B	24	39	\$54.60
FLV003L	Passage, LH	US10B	24	37	\$53.75
FLV003R	Passage, RH	US10B	24	37	\$53.75
FLV004L	Half Dummy Trim, LH	US10B	50	29	\$24.85
FLV004R	Half Dummy Trim, RH	US10B	50	29	\$24.85
FLV007CL	ADA Entry, LH (push button)	US10B	24	46	\$79.40
FLV007CR	ADA Entry, RH (push button)	US10B	24	46	\$79.40
FLV008CL	ADA Privacy, LH (push button)	US10B	24	40	\$62.93
FLV008CR	ADA Privacy, RH (push button)	US10B	24	40	\$62.93
FLV700L	Entry, LH	US3	24	44	\$57.41
FLV700R	Entry, RH	US3	24	44	\$57.41
FLV701L	Privacy, LH	US3	24	39	\$45.50
FLV701R	Privacy, RH	US3	24	39	\$45.50
FLV703L	Passage, LH	US3	24	37	\$44.80
FLV703R	Passage, RH	US3	24	37	\$44.80
FLV704L	Half Dummy Trim, LH	US3	50	29	\$20.69
FLV704R	Half Dummy Trim, RH	US3	50	29	\$20.69
FLVC00L	Entry, LH	US15A	24	44	\$62.02
FLVC00R	Entry, RH	US15A	24	44	\$62.02
FLVC01L	Privacy, LH	US15A	24	39	\$49.13
FLVC01R	Privacy, RH	US15A	24	39	\$49.13
FLVC03L	Passage, LH	US15A	24	37	\$48.35
FLVC03R	Passage, RH	US15A	24	37	\$48.35
FLVC04L	Half Dummy Trim, LH	US15A	50	29	\$22.36
FLVC04R	Half Dummy Trim, RH	US15A	50	29	\$22.36
FLVP00L	Entry, LH	US15	24	44	\$62.02
FLVP00R	Entry, RH	US15	24	44	\$62.02
FLVP01L	Privacy, LH	US15	24	39	\$49.13
FLVP01R	Privacy, RH	US15	24	39	\$49.13
FLVP03L	Passage, LH	US15	24	37	\$48.35
FLVP03R	Passage, RH	US15	24	37	\$48.35
FLVP04L	Half Dummy Trim, LH	US15	50	29	\$22.36
FLVP04R	Half Dummy Trim, RH	US15	50	29	\$22.36
FLVP07CL	ADA Entry, LH (push button)	US15	24	46	\$71.47
FLVP07CR	ADA Entry, RH (push button)	US15	24	46	\$71.47
FLVP08CL	ADA Privacy, LH (push button)	US15	24	40	\$56.65
FLVP08CR	ADA Privacy, RH (push button)	US15	24	40	\$56.65

NOTE: UL Listed backsets are available for purchasing, see page 78-79. Upcharge for change to UL backsets, see page 86.

FLORENCE



ADA

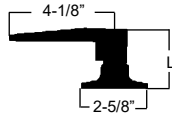

(Exterior Trim)
Entry: 2-3/8"
Privacy/Passage: 2"

Latch: 1"x2-1/4" round corner, adjustable backset

Strike: FT4SP: 1-3/4"x2-1/4" full lip, round corner

Model #	Function	Finish	QTY /Case	Lbs /Case	List Price
FLH700	Entry	US3	24	44	\$57.41
FLH701	Privacy	US3	24	39	\$45.50
FLH703	Passage	US3	24	37	\$44.80
FLH704	Half Dummy Trim	US3	50	29	\$20.69
FLH800	Entry	US5	24	44	\$62.02
FLH801	Privacy	US5	24	39	\$49.13
FLH803	Passage	US5	24	37	\$48.35
FLH804	Half Dummy Trim	US5	50	29	\$22.36
FLHP00	Entry	US15	24	44	\$62.02
FLHP01	Privacy	US15	24	39	\$49.13
FLHP03	Passage	US15	24	37	\$48.35
FLHP04	Half Dummy Trim	US15	50	29	\$22.36
FLHP07C	ADA Entry (push button)	US15	24	46	\$71.47
FLHP08C	ADA Privacy (push button)	US15	24	40	\$56.65

DENVER



ADA

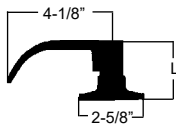

(Exterior Trim)
Entry: 2-3/8"
Privacy/Passage: 2"

Latch: 1"x2-1/4" round corner, adjustable backset

Strike: FT4SP: 1-3/4"x2-1/4" full lip, round corner

Model #	Function	Finish	QTY /Case	Lbs /Case	List Price
FLN000	Entry	US10B	24	46	\$68.91
FLN001	Privacy	US10B	24	40	\$54.60
FLN003	Passage	US10B	24	38	\$53.75
FLN004	Half Dummy Trim	US10B	50	30	\$24.85
FLN007C	ADA Entry (push button)	US10B	24	46	\$79.40
FLN008C	ADA Privacy (push button)	US10B	24	40	\$62.93
FLN700	Entry	US3	24	46	\$57.41
FLN701	Privacy	US3	24	40	\$45.50
FLN703	Passage	US3	24	38	\$44.80
FLN704	Half Dummy Trim	US3	50	30	\$20.69
FLNP00	Entry	US15	24	46	\$62.02
FLNP01	Privacy	US15	24	40	\$49.13
FLNP03	Passage	US15	24	38	\$48.35
FLNP04	Half Dummy Trim	US15	50	30	\$22.36
FLNP07C	ADA Entry (push button)	US15	24	46	\$71.47
FLNP08C	ADA Privacy (push button)	US15	24	40	\$56.65

NOTE: UL Listed backsets are available for purchasing, see page 78-79. Upcharge for change to UL backsets, see page 86.

MILANO

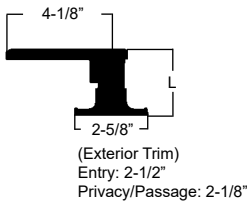

Latch: 1"x2-1/4" round corner, adjustable backset
 Strike: FT4SP: 1-3/4"x2-1/4" full lip, round corner

Model #	Function	Finish	QTY /Case	Lbs /Case	List Price
FLP700	Entry	US3	24	44	\$52.73
FLP701	Privacy	US3	24	39	\$41.84
FLP703	Passage	US3	24	37	\$40.23
FLP704	Half Dummy Trim	US3	50	29	\$19.33
FLP800	Entry	US5	24	44	\$56.97
FLP801	Privacy	US5	24	39	\$45.20
FLP803	Passage	US5	24	37	\$43.45
FLP804	Half Dummy Trim	US5	50	29	\$20.86
FLPK00	Entry	US11P	24	44	\$63.28
FLPK01	Privacy	US11P	24	39	\$50.22
FLPK03	Passage	US11P	24	37	\$48.27
FLPK04	Half Dummy Trim	US11P	50	29	\$23.18
FLPK07C	ADA Entry (push button)	US11P	24	46	\$72.92
FLPK08C	ADA Privacy (push button)	US11P	24	40	\$57.86
FLPP00	Entry	US15	24	44	\$56.97
FLPP01	Privacy	US15	24	39	\$45.20
FLPP03	Passage	US15	24	37	\$43.45
FLPP04	Half Dummy Trim	US15	50	29	\$20.86
FLPP07C	ADA Entry (push button)	US15	24	46	\$65.65
FLPP08C	ADA Privacy (push button)	US15	24	40	\$52.09
(ETA: 09/22)					
FLP900	Entry	US19	24	44	\$63.28
FLP901	Privacy	US19	24	39	\$50.22
FLP903	Passage	US19	24	37	\$48.27
FLP904	Half Dummy Trim	US19	50	29	\$23.18
FLP907C	ADA Entry (push button)	US19	24	46	\$72.92
FLP908C	ADA Privacy (push button)	US19	24	40	\$57.86

NOTE: UL Listed backsets are available for purchasing, see page 78-79. Upcharge for change to UL backsets, see page 86.

RESIDENTIAL LOCKS

CALYPSO

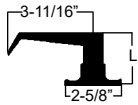

(Exterior Trim)
Entry: 2-7/16"
Privacy/Passage: 2"

Latch: 1"x2-1/4" round corner, adjustable backset
Strike: FT4SP: 1-3/4"x2-1/4" full lip, round corner

Model #	Function	Finish	QTY /Case	Lbs /Case	List Price
FLU600	Entry	US15	24	40	\$54.14
FLU601	Privacy	US15	24	35	\$39.53
FLU603	Passage	US15	24	34	\$37.73
FLU604	Half Dummy Trim	US15	50	26	\$20.04
FLU607C	ADA Entry (push button)	US15	24	46	\$62.40
FLU608C	ADA Privacy (push button)	US15	24	40	\$45.58
FLU700	Entry	US3	24	40	\$51.56
FLU701	Privacy	US3	24	35	\$37.41
FLU703	Passage	US3	24	34	\$35.78
FLU704	Half Dummy Trim	US3	50	26	\$18.07
FLU800	Entry	US5	24	40	\$54.14
FLU801	Privacy	US5	24	35	\$39.53
FLU803	Passage	US5	24	34	\$37.73
FLU804	Half Dummy Trim	US5	50	26	\$20.04
FLU900	Entry	US19	24	40	\$60.16
FLU901	Privacy	US19	24	35	\$43.94
FLU903	Passage	US19	24	34	\$41.92
FLU904	Half Dummy Trim	US19	50	26	\$22.27
FLU907C	ADA Entry (push button)	US19	24	46	\$69.33
FLU908C	ADA Privacy (push button)	US19	24	40	\$50.63
FLUS00	Entry	US26D	24	40	\$54.14
FLUS01	Privacy	US26D	24	35	\$39.53
FLUS03	Passage	US26D	24	34	\$37.73
FLUS04	Half Dummy Trim	US26D	50	26	\$20.04
FLUS07C	ADA Entry (push button)	US26D	24	46	\$62.40
FLUS08C	ADA Privacy (push button)	US26D	24	40	\$45.58
(in stock)					
FLU200	Entry	US26	24	40	\$54.14
FLU201	Privacy	US26	24	35	\$39.53
FLU203	Passage	US26	24	34	\$37.73
FLU204	Half Dummy Trim	US26	50	26	\$20.04
FLU207C	ADA Entry (push button)	US26	24	46	\$62.40
FLU208C	ADA Privacy (push button)	US26	24	40	\$45.58
STOREROOM FUNCTION (ETA: 09/22)					
FLU205	Storeroom	US26	24	46	\$62.40
FLU605	Storeroom	US15	24	46	\$62.40
FLU905	Storeroom	US19	24	46	\$69.33
FLUS05	Storeroom	US26D	24	46	\$62.40

RESIDENTIAL LOCKS

NOTE: UL Listed backsets are available for purchasing, see page 78-79. Upcharge for change to UL backsets, see page 86.

OLYMPIC

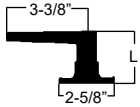

(Exterior Trim)
Entry: 2-7/16"
Privacy/Passage: 2"

Latch: 1"x2-1/4" round corner, adjustable backset
Strike: FT4SP: 1-3/4"x2-1/4" full lip, round corner

RESIDENTIAL LOCKS

Model #	Function	Finish	QTY /Case	Lbs /Case	List Price
FLG200	Entry	US26	24	40	\$54.14
FLG201	Privacy	US26	24	35	\$39.53
FLG203	Passage	US26	24	34	\$37.73
FLG204	Half Dummy Trim	US26	50	26	\$20.04
FLG207C	ADA Entry (push button)	US26	24	46	\$62.40
FLG208C	ADA Privacy (push button)	US26	24	40	\$45.58
<hr/>					
FLG600	Entry	US15	24	40	\$54.14
FLG601	Privacy	US15	24	35	\$39.53
FLG603	Passage	US15	24	34	\$37.73
FLG604	Half Dummy Trim	US15	50	26	\$20.04
FLG607C	ADA Entry (push button)	US15	24	46	\$62.40
FLG608C	ADA Privacy (push button)	US15	24	40	\$45.58
<hr/>					
FLG700	Entry	US3	24	40	\$51.56
FLG701	Privacy	US3	24	35	\$37.41
FLG703	Passage	US3	24	34	\$35.78
FLG704	Half Dummy Trim	US3	50	26	\$18.07
<hr/>					
FLG800	Entry	US5	24	40	\$54.14
FLG801	Privacy	US5	24	35	\$39.53
FLG803	Passage	US5	24	34	\$37.73
FLG804	Half Dummy Trim	US5	50	26	\$20.04
<hr/>					
FLG900	Entry	US19	24	40	\$60.16
FLG901	Privacy	US19	24	35	\$43.94
FLG903	Passage	US19	24	34	\$41.92
FLG904	Half Dummy Trim	US19	50	26	\$22.27
FLG907C	ADA Entry (push button)	US19	24	46	\$69.33
FLG908C	ADA Privacy (push button)	US19	24	40	\$50.63
<hr/>					
FLGS00	Entry	US26D	24	40	\$54.14
FLGS01	Privacy	US26D	24	35	\$39.53
FLGS03	Passage	US26D	24	34	\$37.73
FLGS04	Half Dummy Trim	US26D	50	26	\$20.04
FLGS07C	ADA Entry (push button)	US26D	24	46	\$62.40
FLGS08C	ADA Privacy (push button)	US26D	24	40	\$45.58
<hr/>					
STOREROOM FUNCTION					
FLG205	Storeroom	US26	24	46	\$62.40
FLG605	Storeroom	US15	24	46	\$62.40
FLG905	Storeroom (ETA: 09/22)	US19	24	46	\$69.33
FLGS05	Storeroom	US26D	24	46	\$62.40

NOTE: UL Listed backsets are available for purchasing, see page 78-79. Upcharge for change to UL backsets, see page 86.

SAVANNAH

*Handing: Specify RH/LH

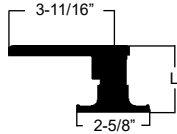

(Exterior Trim)
Entry: 2-3/8"
Privacy/Passage: 2"

Latch: 1"x2-1/4" round corner, adjustable backset
Strike: FT4SP: 1-3/4"x2-1/4" full lip, round corner

Model #	Function	Finish	QTY /Case	Lbs /Case	List Price
FL6700L	Entry, LH	US3	24	40	\$52.73
FL6700R	Entry, RH	US3	24	40	\$52.73
FL6701L	Privacy, LH	US3	24	35	\$41.84
FL6701R	Privacy, RH	US3	24	35	\$41.84
FL6703L	Passage, LH	US3	24	34	\$40.23
FL6703R	Passage, RH	US3	24	34	\$40.23
FL6704L	Half Dummy Trim, LH	US3	50	26	\$19.33
FL6704R	Half Dummy Trim, RH	US3	50	26	\$19.33
FL6800L	Entry, LH	US5	24	40	\$56.97
FL6800R	Entry, RH	US5	24	40	\$56.97
FL6801L	Privacy, LH	US5	24	35	\$45.20
FL6801R	Privacy, RH	US5	24	35	\$45.20
FL6803L	Passage, LH	US5	24	34	\$43.45
FL6803R	Passage, RH	US5	24	34	\$43.45
FL6804L	Half Dummy Trim, LH	US5	50	26	\$20.86
FL6804R	Half Dummy Trim, RH	US5	50	26	\$20.86
FL6P00L	Entry, LH	US15	24	40	\$56.97
FL6P00R	Entry, RH	US15	24	40	\$56.97
FL6P01L	Privacy, LH	US15	24	35	\$45.20
FL6P01R	Privacy, RH	US15	24	35	\$45.20
FL6P03L	Passage, LH	US15	24	34	\$43.45
FL6P03R	Passage, RH	US15	24	34	\$43.45
FL6P04L	Half Dummy Trim, LH	US15	50	26	\$20.86
FL6P04R	Half Dummy Trim, RH	US15	50	26	\$20.86
FL6P07CL	ADA Entry, LH (push button)	US15	24	46	\$65.65
FL6P07CR	ADA Entry, RH (push button)	US15	24	46	\$65.65
FL6P08CL	ADA Privacy, LH (push button)	US15	24	40	\$52.09
FL6P08CR	ADA Privacy, RH (push button)	US15	24	40	\$52.09

RESIDENTIAL LOCKS

NOTE: UL Listed backsets are available for purchasing, see page 78-79. Upcharge for change to UL backsets, see page 86.

ALTO 2

ANSI GRADE 2

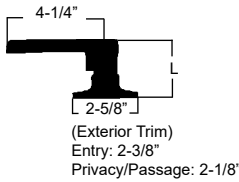

Latch: 1"x2-1/4" round corner, adjustable backset
Strike: FT4SP: 1-3/4"x2-1/4" full lip, round corner

Model #	Function	Finish	QTY /Case	Lbs /Case	List Price
(ETA: 09/22)					
FLF900G	Entry	US19	24	50	\$93.01
FLF901G	Privacy	US19	24	44	\$73.76
FLF903G	Passage	US19	24	42	\$72.58
FLF907CG	ADA Entry (push button)	US19	24	50	\$107.20
FLF908CG	ADA Privacy (push button)	US19	24	44	\$84.95
FLF200G	Entry	US26	24	50	\$83.76
FLF201G	Privacy	US26	24	44	\$66.34
FLF203G	Passage	US26	24	42	\$65.27
FLF207CG	ADA Entry (push button)	US26	24	50	\$96.56
FLF208CG	ADA Privacy (push button)	US26	24	44	\$76.45
FLFP00G	Entry	US15	24	50	\$83.76
FLFP01G	Privacy	US15	24	44	\$66.34
FLFP03G	Passage	US15	24	42	\$65.27
FLFP07CG	ADA Entry (push button)	US15	24	50	\$96.56
FLFP08CG	ADA Privacy (push button)	US15	24	44	\$76.45

CALYPSO 2

ANSI GRADE 2

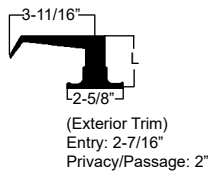

Latch: 1"x2-1/4" round corner, adjustable backset
Strike: FT4SP: 1-3/4"x2-1/4" full lip, round corner

Model #	Function	Finish	QTY /Case	Lbs /Case	List Price
(ETA: 09/22)					
FLU900G	Entry	US19	24	40	\$75.16
FLU901G	Privacy	US19	24	35	\$54.84
FLU903G	Passage	US19	24	34	\$52.37
FLU907CG	ADA Entry (push button)	US19	24	46	\$86.56
FLU908CG	ADA Privacy (push button)	US19	24	40	\$63.23
FLU200G	Entry	US26	24	40	\$67.63
FLU201G	Privacy	US26	24	35	\$49.35
FLU203G	Passage	US26	24	34	\$47.10
FLU207CG	ADA Entry (push button)	US26	24	46	\$77.96
FLU208CG	ADA Privacy (push button)	US26	24	40	\$56.88
FLU600G	Entry	US15	24	40	\$67.63
FLU601G	Privacy	US15	24	35	\$49.35
FLU603G	Passage	US15	24	34	\$47.10
FLU607CG	ADA Entry (push button)	US15	24	46	\$77.96
FLU608CG	ADA Privacy (push button)	US15	24	40	\$56.88
FLUS00G	Entry	US26D	24	40	\$67.63
FLUS01G	Privacy	US26D	24	35	\$49.35
FLUS03G	Passage	US26D	24	34	\$47.10
FLUS07CG	ADA Entry (push button)	US26D	24	46	\$77.96
FLUS08CG	ADA Privacy (push button)	US26D	24	40	\$56.88

KONA

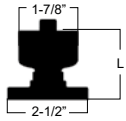

(Exterior Trim)
Entry/Privacy: 2-5/16"
Passage: 2-5/16"

Latch: 1"x2-1/4" round corner, adjustable backset
Strike: FT4SP: 1-3/4"x2-1/4" full lip, round corner



Model #	Function	Finish	QTY /Case	Lbs /Case	List Price
---------	----------	--------	-----------	-----------	------------

With Round Rosette

FTK900	Entry	US19	24	30	\$70.02
FTK910	Privacy	US19	24	26	\$56.36
FTK930	Passage	US19	24	24	\$53.41
FTK940	Half Dummy Knob	US19	50	16	\$28.27

FTK200	Entry	US26	24	30	\$59.06
FTK210	Privacy	US26	24	26	\$47.54
FTK230	Passage	US26	24	24	\$45.07
FTK240	Half Dummy Knob	US26	50	16	\$23.88

FTKP00	Entry	US15	24	30	\$59.06
FTKP10	Privacy	US15	24	26	\$47.54
FTKP30	Passage	US15	24	24	\$45.07
FTKP40	Half Dummy Knob	US15	50	16	\$23.88

With Square Rosette

FTK900S	Entry	US19	24	30	\$78.77
FTK910S	Privacy	US19	24	26	\$63.41
FTK930S	Passage	US19	24	24	\$60.09
FTK940S	Half Dummy Knob	US19	50	16	\$31.80

FTK200S	Entry	US26	24	30	\$66.44
FTK210S	Privacy	US26	24	26	\$53.49
FTK230S	Passage	US26	24	24	\$50.71
FTK240S	Half Dummy Knob	US26	50	16	\$26.87

FTKP00S	Entry	US15	24	30	\$66.44
FTKP10S	Privacy	US15	24	26	\$53.49
FTKP30S	Passage	US15	24	24	\$50.71
FTKP40S	Half Dummy Knob	US15	50	16	\$26.87

NOTE: UL Listed backsets are available for purchasing, see page 78-79. Upcharge for change to UL backsets, see page 86.

CHESTER

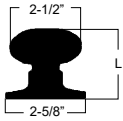

(Exterior Trim)
Entry/Privacy: 2-7/16"
Passage: 2-9/16"

Latch: 1"x2-1/4" round corner, adjustable backset
Strike: FT4SP: 1-3/4"x2-1/4" full lip, round corner

Model #	Function	Finish	QTY /Case	Lbs /Case	List Price
FTYL000	Entry	US10B	24	30	\$47.23
FTYL010	Privacy	US10B	24	26	\$38.02
FTYL030	Passage	US10B	24	24	\$36.04
FTYL040	Half Dummy Knob	US10B	50	16	\$19.09
FTYL700	Entry	US3	24	30	\$39.36
FTYL710	Privacy	US3	24	26	\$31.70
FTYL730	Passage	US3	24	24	\$30.05
FTYL740	Half Dummy Knob	US3	50	16	\$15.92
FTYLK00	Entry	US11P	24	30	\$47.23
FTYLK10	Privacy	US11P	24	26	\$38.02
FTYLK30	Passage	US11P	24	24	\$36.04
FTYLK40	Half Dummy Knob	US11P	50	16	\$19.09
FTYLP00	Entry	US15	24	30	\$42.52
FTYLP10	Privacy	US15	24	26	\$34.23
FTYLP30	Passage	US15	24	24	\$32.44
FTYLP40	Half Dummy Knob	US15	50	16	\$17.18

BELLE

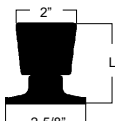

(Exterior Trim)
Entry/Privacy: 2-1/2"
Passage: 2-1/2"

Latch: 1"x2-1/4" round corner, adjustable backset
Strike: FT4SP: 1-3/4"x2-1/4" full lip, round corner

Model #	Function	Finish	QTY /Case	Lbs /Case	List Price
FT6600	Entry	US32D	24	30	\$31.01
FT6610	Privacy	US32D	24	26	\$24.75
FT6630	Passage	US32D	24	24	\$23.28
FT6640	Half Dummy Knob	US32D	50	16	\$12.56
FT6700	Entry	US3	24	30	\$32.82
FT6710	Privacy	US3	24	26	\$26.41
FT6730	Passage	US3	24	24	\$25.04
FT6740	Half Dummy Knob	US3	50	16	\$13.26
FT6800	Entry	US5	24	30	\$36.48
FT6810	Privacy	US5	24	26	\$29.94
FT6830	Passage	US5	24	24	\$28.47
FT6840	Half Dummy Knob	US5	50	16	\$14.74

NOTE: UL Listed backsets are available for purchasing, see page 78-79. Upcharge for change to UL backsets, see page 86.

BARON

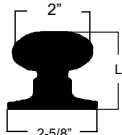

(Exterior Trim)
Entry/Privacy: 2-3/8"
Passage: 2-3/8"

Latch: 1"x2-1/4" round corner, adjustable backset
Strike: FT4SP: 1-3/4"x2-1/4" full lip, round corner

Model #	Function	Finish	QTY /Case	Lbs /Case	List Price
FTF000	Entry	US10B	24	30	\$43.75
FTF010	Privacy	US10B	24	26	\$35.23
FTF030	Passage	US10B	24	24	\$33.38
FTF040	Half Dummy Knob	US10B	50	16	\$17.67
FTF600	Entry	US32D	24	30	\$34.33
FTF610	Privacy	US32D	24	26	\$27.89
FTF630	Passage	US32D	24	24	\$26.42
FTF640	Half Dummy Knob	US32D	50	16	\$14.01
FTF700	Entry	US3	24	30	\$36.47
FTF710	Privacy	US3	24	26	\$29.36
FTF730	Passage	US3	24	24	\$27.81
FTF740	Half Dummy Knob	US3	50	16	\$14.74
FTF800	Entry	US5	24	30	\$39.36
FTF810	Privacy	US5	24	26	\$31.70
FTF830	Passage	US5	24	24	\$30.05
FTF840	Half Dummy Knob	US5	50	16	\$15.92
FTF900	Entry	US19	24	30	\$43.75
FTF910	Privacy	US19	24	26	\$35.23
FTF930	Passage	US19	24	24	\$33.38
FTF940	Half Dummy Knob	US19	50	16	\$17.67
FTFC00	Entry	US15A	24	30	\$39.36
FTFC10	Privacy	US15A	24	26	\$31.70
FTFC30	Passage	US15A	24	24	\$30.05
FTFC40	Half Dummy Knob	US15A	50	16	\$15.92
FTFK00	Entry	US11P	24	30	\$43.75
FTFK10	Privacy	US11P	24	26	\$35.23
FTFK30	Passage	US11P	24	24	\$33.38
FTFK40	Half Dummy Knob	US11P	50	16	\$17.65
FTFP00	Entry	US15	24	30	\$39.36
FTFP10	Privacy	US15	24	26	\$31.70
FTFP30	Passage	US15	24	24	\$30.05
FTFP40	Half Dummy Knob	US15	50	16	\$15.92

RESIDENTIAL LOCKS

NOTE: UL Listed backsets are available for purchasing, see page 78-79. Upcharge for change to UL backsets, see page 86.

SATURN

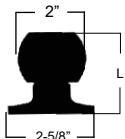

2-5/8"
(Exterior Trim)
Entry/Privacy: 2-1/2"
Passage: 2-11/16"

Latch: 1"x2-1/4" round corner, adjustable backset
Strike: FT4SP: 1-3/4"x2-1/4" full lip, round corner

Model #	Function	Finish	QTY /Case	Lbs /Case	List Price
FT3000	Entry	US10B	24	30	\$39.36
FT3010	Privacy	US10B	24	26	\$31.70
FT3030	Passage	US10B	24	24	\$30.05
FT3040	Half Dummy Knob	US10B	50	16	\$15.92
<hr/>					
FT3200	Entry	US26	24	30	\$35.45
FT3210	Privacy	US26	24	26	\$28.52
FT3230	Passage	US26	24	24	\$27.03
FT3240	Half Dummy Knob	US26	50	16	\$14.32
<hr/>					
FT3600	Entry	US32D	24	30	\$31.01
FT3610	Privacy	US32D	24	26	\$24.75
FT3630	Passage	US32D	24	24	\$23.28
FT3640	Half Dummy Knob	US32D	50	16	\$12.56
FC3650	Storeroom (Cylindrical)	US32D	24	36	\$36.32
<hr/>					
FT3700	Entry	US3	24	30	\$32.82
FT3710	Privacy	US3	24	26	\$26.41
FT3730	Passage	US3	24	24	\$25.04
FT3740	Half Dummy Knob	US3	50	16	\$13.26
FC3750	Storeroom (Cylindrical)	US3	24	36	\$38.07
<hr/>					
FT3800	Entry	US5	24	30	\$35.45
FT3810	Privacy	US5	24	26	\$28.52
FT3830	Passage	US5	24	24	\$27.03
FT3840	Half Dummy Knob	US5	50	16	\$14.32
FC3850	Storeroom (Cylindrical)	US5	24	36	\$41.12
<hr/>					
FT3C00	Entry	US15A	24	30	\$35.45
FT3C10	Privacy	US15A	24	26	\$28.52
FT3C30	Passage	US15A	24	24	\$27.03
FT3C40	Half Dummy Knob	US15A	50	16	\$14.32
<hr/>					
FT3P00	Entry	US15	24	30	\$35.45
FT3P10	Privacy	US15	24	26	\$28.52
FT3P30	Passage	US15	24	24	\$27.03
FT3P40	Half Dummy Knob	US15	50	16	\$14.32

NOTE: UL Listed backsets are available for purchasing, see page 78-79. Upcharge for change to UL backsets, see page 86.

FDK Series



ADA



Latch: 1"x2-1/4" round corner, adjustable backset
Strike: FD9SP: 1-3/4"x2-1/4" full lip, round corner

Model #	Function	Finish	QTY /Case	Lbs /Case	List Price
FDK91	Single Cylinder	US19	24	32	\$69.17
FDK92	Double Cylinder	US19	24	48	\$86.46
FDK94	One-sided Deadbolt	US19	24	25	\$33.55
FDK96	One-sided Deadbolt w/cover	US19	24	30	\$55.86
FDK21	Single Cylinder	US26	24	32	\$62.25
FDK22	Double Cylinder	US26	24	48	\$77.82
FDK24	One-sided Deadbolt	US26	24	25	\$30.21
FDK26	One-sided Deadbolt w/cover	US26	24	30	\$50.27
FDKP1	Single Cylinder	US15	24	32	\$62.25
FDKP2	Double Cylinder	US15	24	48	\$77.82
FDKP4	One-sided Deadbolt	US15	24	25	\$30.21
FDKP6	One-sided Deadbolt w/cover	US15	24	30	\$50.27

FDS Series



ADA



Latch: 1"x2-1/4" round corner, adjustable backset
Strike: FD9SP: 1-3/4"x2-1/4" full lip, round corner

Model #	Function	Finish	QTY /Case	Lbs /Case	List Price
FDS91	Single Cylinder	US19	24	32	\$69.17
FDS92	Double Cylinder	US19	24	48	\$86.46
FDS94	One-sided Deadbolt	US19	24	25	\$33.55
FDS96	One-sided Deadbolt w/cover	US19	24	30	\$55.86
FDS21	Single Cylinder	US26	24	32	\$62.25
FDS22	Double Cylinder	US26	24	48	\$77.82
FDS24	One-sided Deadbolt	US26	24	25	\$30.21
FDS26	One-sided Deadbolt w/cover	US26	24	30	\$50.27
FDSP1	Single Cylinder	US15	24	32	\$62.25
FDSP2	Double Cylinder	US15	24	48	\$77.82
FDSP4	One-sided Deadbolt	US15	24	25	\$30.21
FDSP6	One-sided Deadbolt w/cover	US15	24	30	\$50.27



FDS94P	One-sided Deadbolt Cover	US19	24	16	\$22.99
FDS24P	One-sided Deadbolt Cover	US26	24	16	\$20.06
FDSP4P	One-sided Deadbolt Cover	US15	24	16	\$20.06

NOTE: UL Listed backsets are available for purchasing, see page 80. Upcharge for change to UL backsets, see page 86.

FD2 Series



Latch: 1"x2-1/4" round corner, adjustable backset
Strike: FD9SP: 1-3/4"x2-1/4" full lip, round corner

Model #	Function	Finish	QTY /Case	Lbs /Case	List Price
(Zinc die-cast cylinder housing)					
FD201	Single Cylinder	US10B	24	25	\$38.52
FD221	Single Cylinder	US26	24	25	\$34.65
FD261	Single Cylinder	US32D	24	25	\$30.57
FD271	Single Cylinder	US3	24	25	\$32.09
FD281	Single Cylinder	US5	24	25	\$34.65
FD291	Single Cylinder	US19	24	25	\$38.52
FD2C1	Single Cylinder	US15A	24	25	\$34.65
FD2K1	Single Cylinder	US11P	24	25	\$38.52
FD2P1	Single Cylinder	US15	24	25	\$34.65
FD2S1	Single Cylinder	US26D	24	25	\$34.65



Latch: 1"x2-1/4" round corner, adjustable backset
Strike: FD9SP: 1-3/4"x2-1/4" full lip, round corner

Model #	Function	Finish	QTY /Case	Lbs /Case	List Price
(Zinc die-cast cylinder housing)					
FD202	Double Cylinder	US10B	24	30	\$46.77
FD222	Double Cylinder	US26	24	30	\$42.08
FD262	Double Cylinder	US32D	24	30	\$37.47
FD272	Double Cylinder	US3	24	30	\$38.97
FD282	Double Cylinder	US5	24	30	\$42.08
FD292	Double Cylinder	US19	24	30	\$46.77
FD2C2	Double Cylinder	US15A	24	30	\$42.08
FD2K2	Double Cylinder	US11P	24	30	\$46.77
FD2P2	Double Cylinder	US15	24	30	\$42.08
FD2S2	Double Cylinder	US26D	24	30	\$42.08



Latch: 1"x2-1/4" round corner, adjustable backset
Strike: FD9SP: 1-3/4"x2-1/4" full lip, round corner

Model #	Function	Finish	QTY /Case	Lbs /Case	List Price
FD204	One-Sided Deadbolt	US10B	24	15	\$20.76
FD224	One-Sided Deadbolt	US26	24	15	\$18.67
FD264	One-Sided Deadbolt	US32D	24	15	\$16.93
FD274	One-Sided Deadbolt	US3	24	15	\$17.31
FD284	One-Sided Deadbolt	US5	24	15	\$18.67
FD294	One-Sided Deadbolt	US19	24	15	\$20.76
FD2C4	One-Sided Deadbolt	US15A	24	15	\$18.67
FD2K4	One-Sided Deadbolt	US11P	24	15	\$20.76
FD2P4	One-Sided Deadbolt	US15	24	15	\$18.67
FD2S4	One-Sided Deadbolt	US26D	24	15	\$18.67



Latch: 1"x2-1/4" round corner, adjustable backset
Strike: FD9SP: 1-3/4"x2-1/4" full lip, round corner

Model #	Function	Finish	QTY /Case	Lbs /Case	List Price
FD206	One-Sided Deadbolt w/Cover	US10B	24	18	\$32.19
FD226	One-Sided Deadbolt w/Cover	US26	24	18	\$28.98
FD266	One-Sided Deadbolt w/Cover	US32D	24	18	\$26.23
FD276	One-Sided Deadbolt w/Cover	US3	24	18	\$26.86
FD286	One-Sided Deadbolt w/Cover	US5	24	18	\$28.98
FD296	One-Sided Deadbolt w/Cover	US19	24	18	\$32.19
FD2C6	One-Sided Deadbolt w/Cover	US15A	24	18	\$28.98
FD2K6	One-Sided Deadbolt w/Cover	US11P	24	18	\$32.19
FD2P6	One-Sided Deadbolt w/Cover	US15	24	18	\$28.98
FD2S6	One-Sided Deadbolt w/Cover	US26D	24	18	\$28.98



Model #	Function	Finish	QTY /Case	Lbs /Case	List Price
FD204P	Cover Plate Only	US10B	24	6	\$11.43
FD224P	Cover Plate Only	US26	24	6	\$10.30
FD264P	Cover Plate Only	US32D	24	6	\$9.32
FD274P	Cover Plate Only	US3	24	6	\$9.53
FD284P	Cover Plate Only	US5	24	6	\$10.30
FD294P	Cover Plate Only	US19	24	6	\$11.43
FD2C4P	Cover Plate Only	US15A	24	6	\$10.30
FD2K4P	Cover Plate Only	US11P	24	6	\$11.43
FD2P4P	Cover Plate Only	US15	24	6	\$10.30
FD2S4P	Cover Plate Only	US26D	24	6	\$10.30

NOTE: UL Listed backsets are available for purchasing, see page 80. Upcharge for change to UL backsets, see page 86.

FD3 Series



(Solid Brass Cylinder housing)

Model #	Function	Finish	QTY /Case	Lbs /Case	List Price
FD301	Single Cylinder	US10B	24	30	\$44.04
FD321	Single Cylinder	US26	24	30	\$39.65
FD361	Single Cylinder	US32D	24	30	\$35.12
FD371	Single Cylinder	US3	24	30	\$36.70
FD381	Single Cylinder	US5	24	30	\$39.65
FD391	Single Cylinder	US19	24	30	\$44.04
FD3C1	Single Cylinder	US15A	24	30	\$39.65
FD3K1	Single Cylinder	US11P	24	30	\$44.04
FD3P1	Single Cylinder	US15	24	30	\$39.65

Latch: 1"x2-1/4" round corner, adjustable backset
 Strike: FD9SP: 1-3/4"x2-1/4" full lip, round corner



(Solid Brass Cylinder housing)

Model #	Function	Finish	QTY /Case	Lbs /Case	List Price
FD302	Double Cylinder	US10B	24	39	\$55.86
FD322	Double Cylinder	US26	24	39	\$50.29
FD362	Double Cylinder	US32D	24	39	\$44.86
FD372	Double Cylinder	US3	24	39	\$46.57
FD382	Double Cylinder	US5	24	39	\$50.29
FD392	Double Cylinder	US19	24	39	\$55.86
FD3C2	Double Cylinder	US15A	24	39	\$50.29
FD3K2	Double Cylinder	US11P	24	39	\$55.86
FD3P2	Double Cylinder	US15	24	39	\$50.29

Latch: 1"x2-1/4" round corner, adjustable backset
 Strike: FD9SP: 1-3/4"x2-1/4" full lip, round corner

NOTE: UL Listed backsets are available for purchasing, see page 80. Upcharge for change to UL backsets, see page 86.

SLIDING DOOR LOCKS (Weiser Style)



Model #	Function	Finish	QTY /Case	Lbs /Case	List Price
FF1010	Privacy	US10B	48	22	\$27.13
FF1030	Passage	US10B	48	20	\$21.57
FF1210	Privacy	US26	48	22	\$24.41
FF1230	Passage	US26	48	20	\$19.41
FF1710	Privacy	US3	48	22	\$22.60
FF1730	Passage	US3	48	20	\$17.98
FF1810	Privacy	US5	48	22	\$24.41
FF1830	Passage	US5	48	20	\$19.41
FF1C10	Privacy	US15A	48	22	\$24.41
FF1C30	Passage	US15A	48	20	\$19.41
FF1P10	Privacy	US15	48	22	\$24.41
FF1P30	Passage	US15	48	20	\$19.41
FF1S10	Privacy	US26D	48	22	\$24.41
FF1S30	Passage	US26D	48	20	\$19.41

* Fit door thickness: 1-5/16" to 1-3/4"

* Hardened plastic thumb turn

(Please check with sales team for available quantity before placing your order.)

Notching Dimensions

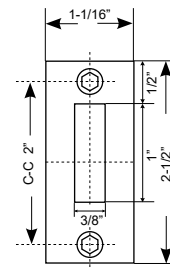
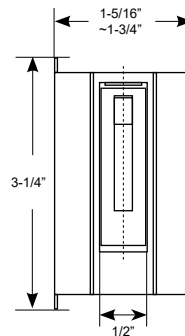
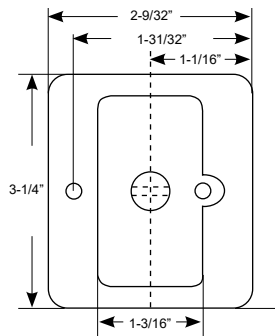
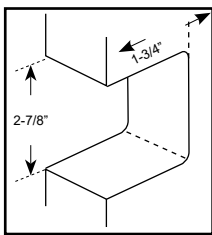

SINGLE DEADBOLT + KNOB ENTRY

Model #	Function	Finish	QTY /Case	Lbs /Case	List Price
---------	----------	--------	-----------	-----------	------------



FD2 Single Cylinder DB + Saturn Entry

FT3621	Combo Set	US32D	12	28	\$61.14
FT3721	Combo Set	US3	12	28	\$64.89
FT3821	Combo Set	US5	12	28	\$70.16

Standard Pack : Keyed Alike 4-4, Case quantity only.



FD2 Single Cylinder DB + Belle Entry

FT6621	Combo Set	US32D	12	28	\$61.14
FT6721	Combo Set	US3	12	28	\$64.89
FT6821	Combo Set	US5	12	28	\$70.16

Standard Pack : Keyed Alike 4-4, Case quantity only.



FD2 Single Cylinder DB + Baron Entry

FTF621	Combo Set	US32D	12	28	\$64.89
FTF721	Combo Set	US3	12	28	\$68.55
FTF821	Combo Set	US5	12	28	\$74.08

Standard Pack : Keyed Alike 4-4, Case quantity only.

CONSTRUCTION LOCKS

Model #	Function	Finish	QTY /Case	Lbs /Case	List Price
---------	----------	--------	-----------	-----------	------------



CTS600	Entry Knobset	US32D	25	29	\$27.93
CD261	Single Cylinder Deadbolt	US32D	24	25	\$27.51
CD262	Double Cylinder Deadbolt	US32D	24	30	\$33.73
CT3610	Privacy	US32D	24	26	\$22.28
CT3630	Passage	US32D	24	24	\$20.97



* No key included unless requested

	Model #	Description	Finish	List Price
	<i>For any combination of Knob, Deadbolt, or Lever Locks</i>			
	FWD-2	Two-hole Wooden Display Mount		\$131.98
	<i>For any combination of Knob, Deadbolt, or Lever Locks</i>			
	FWD-3	Three-hole Wooden Display Mount		\$131.98
	<i>For Handleset Locks</i>			
	FWD-S	Handleset Wooden Display Mount		\$131.98
	<i>For Interconnected Locks (C-T-C: 5-1/2")</i>			
	FWD-I5	Interconnected Lock Wooden Display Mount		\$131.98
<i>For Interconnected Locks (C-T-C: 4")</i>				
	FWD-I4	Interconnected Lock Wooden Display Mount		\$131.98
*Dimension Mount: 19" x 4-7/8", Base: 7-7/8" x 4-7/8", Backset: 2-3/8"				
	FCW-S72	Concealed Washer for FST, FSK, FSL, FSG Bottom Post	US26	\$6.89
	FCW-S77	Concealed Washer for FST, FSK, FSL, FSG Bottom Post	US3	\$6.89
	FCW-S78	Concealed Washer for FST, FSK, FSL, FSG Bottom Post	US5	\$6.89
	FCW-S79	Concealed Washer for FST, FSK, FSL, FSG Bottom Post	US19(10B)	\$6.89
	FCW-S7C	Concealed Washer for FST, FSK, FSL, FSG Bottom Post	US15A	\$6.89
	FCW-S7K	Concealed Washer for FST, FSK, FSL, FSG Bottom Post	US11P	\$6.89
	FCW-S7P	Concealed Washer for FST, FSK, FSL, FSG Bottom Post	US15	\$6.89
	FSW-S72	Snap-on Washer for FS7, FSC, FS3, FHS Bottom Post	US26	\$6.89
	FSW-S77	Snap-on Washer for FS7, FSC, FS3, FHS Bottom Post	US3	\$6.89
	FSW-S78	Snap-on Washer for FS7, FSC, FS3, FHS Bottom Post	US5	\$6.89
	FSW-S79	Snap-on Washer for FS7, FSC, FS3, FHS Bottom Post	US19(10B)	\$6.89
	FSW-S7C	Snap-on Washer for FS7, FSC, FS3, FHS Bottom Post	US15A	\$6.89
	FSW-S7K	Snap-on Washer for FS7, FSC, FS3, FHS Bottom Post	US11P	\$6.89
	FSW-S7P	Snap-on Washer for FS7, FSC, FS3, FHS Bottom Post	US15	\$6.89
EXTENSION KIT FOR 2" TO 2-1/4" THICKNESS DOOR - Long Tail Piece, Screws, Spindle Plate (please specify finishes)				
	FEK-S71	Extension Kit for FS7, FSC, FS3, FSG Single Cylinder		\$21.87
	FEK-S72	Extension Kit for FS7, FSC, FS3, FSG Double Cylinders		\$21.87
	FEK-SK1	Extension Kit for FST, FSK, FSL Single Cylinder		\$21.87
	FEK-SK2	Extension Kit for FST, FSK, FSL Double Cylinders		\$21.87
	FEK-T30	Extension Kit for all Knobsets Entry/Privacy		\$17.49
	FEK-T33	Extension Kit for all Knobsets Passage		\$17.49
	FEK-LG0	Extension Kit for all Reversible Leversets Entry/Privacy		\$17.49
	FEK-LG3	Extension Kit for all Reversible Leversets Passage		\$17.49
	FEK-LT3	Extension Kit for all Contemporary Leversets Passage		\$17.49
	FEK-D31	Extension Kit for Single Cylinder Deadbolt		\$8.06
	FEK-D32	Extension Kit for Double Cylinder Deadbolts		\$8.06
	FEK-L3B	Extension Kit for all FLB G2 Leversets Passage		\$25.50
(Extension Kit is not available for G3 Tubular Pushbutton Entry and Privacy)				





PARTS FOR LOCKS

	Model #	Function	Finish	QTY	List Price	
	FKK-KW	Pamex Keying Kit (for Kwikset Keyway)		1	\$255.66	
	FKK-SC	Pamex Keying Kit (for Schlage "C" Keyway)		1	\$255.66	
	(price per bag, sold per bag only)					
		FRK-001	Cylinder Spring		50/bag	\$8.06
		FRK-002	Plug Cap Spring		50/bag	\$8.06
		FRK-003	C-Type Clip		20/bag	\$8.06
		FRK-004	Cylinder Housing Cap		50/bag	\$8.06
		FRK-005	Spring Retainer Pin		50/bag	\$8.06
FRK-006		Plastic Following Tool		1	\$2.69	
	FRK-007	Cap Removal Tool for FD2, FD3, FDK, FDS		1	\$11.54	
	FRK-007G	Cap Removal Tool for FDP, FD7, FD8, Commercial Locks		1	\$11.54	
	FRK-008	"C" Clip Removal Tool		1	\$5.37	
<i>For Kwikset 5-pin Keyway</i>						
	FKB-KW5	Key Blank	Chrome	1	\$1.21	
	FKB-CKKW5	Construction Key Blank	Copper	1	\$1.21	
	FKB-MKKW5	Master Key Blank	Gold	1	\$1.21	
	FKC-KW5	Extra Cut Keys	Chrome	1	\$1.68	
	FKC-CKKW5	Extra Cut Construction Keys	Copper	1	\$1.68	
	FKC-MKKW5	Extra Cut Master Keys	Gold	1	\$1.68	
<i>For Schlage "C" 5-pin Keyway</i>						
	FKB-SC5	Key Blank	Chrome	1	\$1.21	
	FKB-CKSC5	Construction Key Blank	Copper	1	\$1.21	
	FKB-MKSC5	Master Key Blank	Gold	1	\$1.21	
	FKC-SC5	Extra Cut Keys	Chrome	1	\$1.68	
	FKC-CKSC5	Extra Cut Construction Keys	Copper	1	\$1.68	
	FKC-MKSC5	Extra Cut Master Keys	Gold	1	\$1.68	
<i>For Schlage "C" 6-pin Keyway</i>						
	FKB-SC6	Key Blank	Chrome	1	\$1.43	
	FKB-CKSC6	Construction Key Blank	Copper	1	\$1.43	
	FKB-MKSC6	Master Key Blank	Gold	1	\$1.43	
	FKC-SC6	Extra Cut Keys	Chrome	1	\$2.01	
	FKC-CKSC6	Extra Cut Construction Keys	Copper	1	\$2.01	
	FKC-MKSC6	Extra Cut Master Keys	Gold	1	\$2.01	



PARTS FOR LOCKS

Model #	Description	Dimension	QTY	List Price
For Kwikset Keyway			(price per bag, sold per bag only)	
 FBP-KW1	KW Bottom Pin #1	.170"	200/bag	\$24.64
FBP-KW2	KW Bottom Pin #2	.193"	200/bag	\$24.64
FBP-KW3	KW Bottom Pin #3	.216"	200/bag	\$24.64
FBP-KW4	KW Bottom Pin #4	.239"	200/bag	\$24.64
FBP-KW5	KW Bottom Pin #5	.262"	200/bag	\$24.64
FBP-KW6	KW Bottom Pin #6	.285"	200/bag	\$24.64
FBP-KW7	KW Bottom Pin #7	.308"	200/bag	\$24.64
<hr/>				
FMP-KW2	KW Master Pin #2	.046"	200/bag	\$24.64
FMP-KW3	KW Master Pin #3	.069"	200/bag	\$24.64
FMP-KW4	KW Master Pin #4	.092"	200/bag	\$24.64
FMP-KW5	KW Master Pin #5	.115"	200/bag	\$24.64
FMP-KW6	KW Master Pin #6	.138"	200/bag	\$24.64
<hr/>				
FTP-KW1	KW Standard Top Pin	.160"	200/bag	\$24.64
<hr/>				
FCB-KW2	KW Construction Ball #2	.046"	200/bag	\$49.27
FCB-KW4	KW Construction Ball #4	.092"	200/bag	\$49.27
For Schlage Keyway			(price per bag, sold per bag only)	
 FBP-SC0	SC Bottom Pin #0	.165"	200/bag	\$24.64
FBP-SC1	SC Bottom Pin #1	.180"	200/bag	\$24.64
FBP-SC2	SC Bottom Pin #2	.196"	200/bag	\$24.64
FBP-SC3	SC Bottom Pin #3	.211"	200/bag	\$24.64
FBP-SC4	SC Bottom Pin #4	.226"	200/bag	\$24.64
FBP-SC5	SC Bottom Pin #5	.241"	200/bag	\$24.64
FBP-SC6	SC Bottom Pin #6	.256"	200/bag	\$24.64
FBP-SC7	SC Bottom Pin #7	.270"	200/bag	\$24.64
FBP-SC8	SC Bottom Pin #8	.285"	200/bag	\$24.64
FBP-SC9	SC Bottom Pin #9	.300"	200/bag	\$24.64
<hr/>				
FMP-SC2	SC Master Pin #2	.030"	200/bag	\$24.64
FMP-SC3	SC Master Pin #3	.045"	200/bag	\$24.64
FMP-SC4	SC Master Pin #4	.060"	200/bag	\$24.64
FMP-SC5	SC Master Pin #5	.075"	200/bag	\$24.64
FMP-SC6	SC Master Pin #6	.090"	200/bag	\$24.64
FMP-SC7	SC Master Pin #7	.105"	200/bag	\$24.64
FMP-SC8	SC Master Pin #8	.120"	200/bag	\$24.64
FMP-SC9	SC Master Pin #9	.135"	200/bag	\$24.64
<hr/>				
FTP-SC1	SC Standard Top Pin		200/bag	\$24.64
<hr/>				
FCB-SC3	SC Construction Ball #3	.045"	200/bag	\$49.27
FCB-SC6	SC Construction Ball #6	.090"	200/bag	\$49.27

RESIDENTIAL LOCKS KEY AND CYLINDER -- KWIKSET 5-PIN KEYWAY

Model #	Function	Finish	QTY	List Price
 FKC-T36KW	Key & Cylinder for FT3, FT6, FTYL Series	US26	1	\$16.92
FKC-T37KW	Key & Cylinder for FT3, FT6, FTYL Series	US3	1	\$16.92
FKC-TF6KW	Key & Cylinder for FTF Series and all leversets	US26	1	\$16.92
FKC-TF7KW	Key & Cylinder for FTF Series and all leversets	US3	1	\$16.92
FKC-LU67KW	Key & Cylinder for LU607C-ADA Entry	US26	1	\$16.92
FKC-LU77KW	Key & Cylinder for LN007C-ADA Entry	US3	1	\$16.92
 FKC-D201KW	Key & Cylinder for FD201	US10B	1	\$16.92
FKC-D221KW	Key & Cylinder for FD221	US26	1	\$16.92
FKC-D261KW	Key & Cylinder for FD261	US32D	1	\$16.92
FKC-D271KW	Key & Cylinder for FD271	US3	1	\$16.92
FKC-D281KW	Key & Cylinder for FD281	US5	1	\$16.92
FKC-D291KW	Key & Cylinder for FD291	US19	1	\$16.92
FKC-D2C1KW	Key & Cylinder for FD2C1	US15A	1	\$16.92
FKC-D2K1KW	Key & Cylinder for FD2K1	US11P	1	\$16.92
FKC-D2P1KW	Key & Cylinder for FD2P1	US15	1	\$16.92
FKC-D2S1KW	Key & Cylinder for FD2S1	US26D	1	\$16.92
FKC-DK21KW	Key & Cylinder for FDK21/FDS21	US26	1	\$16.92
FKC-DKP1KW	Key & Cylinder for FDKP1/FDSP1	US15	1	\$16.92
 FKC-D202KW	Key & Cylinder for FD202	US10B	1	\$27.10
FKC-D222KW	Key & Cylinder for FD222	US26	1	\$27.10
FKC-D262KW	Key & Cylinder for FD262	US32D	1	\$27.10
FKC-D272KW	Key & Cylinder for FD272	US3	1	\$27.10
FKC-D282KW	Key & Cylinder for FD282	US5	1	\$27.10
FKC-D292KW	Key & Cylinder for FD292	US19	1	\$27.10
FKC-D2C2KW	Key & Cylinder for FD2C2	US15A	1	\$27.10
FKC-D2K2KW	Key & Cylinder for FD2K2	US11P	1	\$27.10
FKC-D2P2KW	Key & Cylinder for FD2P2	US15	1	\$27.10
FKC-D2S2KW	Key & Cylinder for FD2S2	US26D	1	\$27.10
FKC-DK22KW	Key & Cylinder for FDK22/FDS22	US26	1	\$27.10
FKC-DKP2KW	Key & Cylinder for FDKP2/FDSP2	US15	1	\$27.10
 FKC-D301KW	Key & Cylinder for FD301 & Handleset	US10B	1	\$18.64
FKC-D321KW	Key & Cylinder for FD321 & Handleset	US26	1	\$18.64
FKC-D361KW	Key & Cylinder for FD361 & Handleset	US32D	1	\$18.64
FKC-D371KW	Key & Cylinder for FD371 & Handleset	US3	1	\$18.64
FKC-D381KW	Key & Cylinder for FD381 & Handleset	US5	1	\$18.64
FKC-D391KW	Key & Cylinder for FD391 & Handleset	US19	1	\$18.64
FKC-D3C1KW	Key & Cylinder for FD3C1 & Handleset	US15A	1	\$18.64
FKC-D3K1KW	Key & Cylinder for FD3K1 & Handleset	US11P	1	\$18.64
FKC-D3P1KW	Key & Cylinder for FD3P1 & Handleset	US15	1	\$18.64
FKC-D3M1KW	Key & Cylinder for FD3M1 & Handleset	USL03	1	\$18.64
 FKC-D302KW	Key & Cylinder for FD302 & Handleset	US10B	1	\$29.86
FKC-D322KW	Key & Cylinder for FD322 & Handleset	US26	1	\$29.86
FKC-D362KW	Key & Cylinder for FD362 & Handleset	US32D	1	\$29.86
FKC-D372KW	Key & Cylinder for FD372 & Handleset	US3	1	\$29.86
FKC-D382KW	Key & Cylinder for FD382 & Handleset	US5	1	\$29.86
FKC-D392KW	Key & Cylinder for FD392 & Handleset	US19	1	\$29.86
FKC-D3C2KW	Key & Cylinder for FD3C2 & Handleset	US15A	1	\$29.86
FKC-D3K2KW	Key & Cylinder for FD3K2 & Handleset	US11P	1	\$29.86
FKC-D3P2KW	Key & Cylinder for FD3P2 & Handleset	US15	1	\$29.86
FKC-D3M2KW	Key & Cylinder for FD3M2 & Handleset	USL03	1	\$29.86

RESIDENTIAL LOCKS KEY AND CYLINDER -- SCHLAGE 5-PIN KEYWAY









Model #	Function	Finish	QTY	List Price
 FKC-T36SC	Key & Cylinder for FT3, FT6, FTYL Series	US26	1	\$16.92
FKC-T37SC	Key & Cylinder for FT3, FT6, FTYL Series	US3	1	\$16.92
FKC-TF6SC	Key & Cylinder for FTF Series and all leversets	US26	1	\$16.92
FKC-TF7SC	Key & Cylinder for FTF Series and all leversets	US3	1	\$16.92
FKC-LU67SC	Key & Cylinder for LU607C-ADA Entry	US26	1	\$16.92
FKC-LU77SC	Key & Cylinder for LN007C-ADA Entry	US3	1	\$16.92
 FKC-D201SC	Key & Cylinder for FD201	US10B	1	\$16.92
FKC-D261SC	Key & Cylinder for FD261	US32D	1	\$16.92
FKC-D271SC	Key & Cylinder for FD271	US3	1	\$16.92
FKC-D2P1SC	Key & Cylinder for FD2P1	US15	1	\$16.92
FKC-D2S1SC	Key & Cylinder for FD2S1	US26D	1	\$16.92
FKC-DK21SC	Key & Cylinder for FDK21/FDS21	US26	1	\$16.92
FKC-DKP1SC	Key & Cylinder for FDKP1/FDSP1	US15	1	\$16.92
 FKC-D301SC	Key & Cylinder for FD301 & Handleset	US10B	1	\$18.64
FKC-D321SC	Key & Cylinder for FD321 & Handleset	US26	1	\$18.64
FKC-D361SC	Key & Cylinder for FD361 & Handleset	US32D	1	\$18.64
FKC-D371SC	Key & Cylinder for FD371 & Handleset	US3	1	\$18.64
FKC-D381SC	Key & Cylinder for FD381 & Handleset	US5	1	\$18.64
FKC-D391SC	Key & Cylinder for FD391 & Handleset	US19	1	\$18.64
FKC-D3C1SC	Key & Cylinder for FD3C1 & Handleset	US15A	1	\$18.64
FKC-D3K1SC	Key & Cylinder for FD3K1 & Handleset	US11P	1	\$18.64
FKC-D3P1SC	Key & Cylinder for FD3P1 & Handleset	US15	1	\$18.64
 FKC-D302SC	Key & Cylinder for FD302 & Handleset	US10B	1	\$29.86
FKC-D322SC	Key & Cylinder for FD322 & Handleset	US26	1	\$29.86
FKC-D362SC	Key & Cylinder for FD362 & Handleset	US32D	1	\$29.86
FKC-D372SC	Key & Cylinder for FD372 & Handleset	US3	1	\$29.86
FKC-D382SC	Key & Cylinder for FD382 & Handleset	US5	1	\$29.86
FKC-D392SC	Key & Cylinder for FD392 & Handleset	US19	1	\$29.86
FKC-D3C2SC	Key & Cylinder for FD3C2 & Handleset	US15A	1	\$29.86
FKC-D3K2SC	Key & Cylinder for FD3K2 & Handleset	US11P	1	\$29.86
FKC-D3P2SC	Key & Cylinder for FD3P2 & Handleset	US15	1	\$29.86
FKC-D2S2SC	Key & Cylinder for FD2S2	US26D	1	\$27.10
FKC-DK22SC	Key & Cylinder for FDK22/FDS22	US26	1	\$27.10
FKC-DKP2SC	Key & Cylinder for FDKP2/FDSP2	US15	1	\$27.10

COMMERCIAL LOCKS KEY AND CYLINDER -- KWIKSET 5-PIN KEYWAY

 FKC-Y3S0KW	Key & Cylinder for Princeton Entry/Storeroom	US26	1	\$18.64
FKC-Y370KW	Key & Cylinder for Princeton Entry/Storeroom	US3	1	\$18.64
FKC-Y3S5KW	Key & Cylinder for Princeton Classroom	US26	1	\$18.64
FKC-Y375KW	Key & Cylinder for Princeton Classroom	US3	1	\$18.64
FKC-Y3SDKW	Key & Cylinder for Princeton Clutch Entry/Storeroom	US26	1	\$18.64
 FKC-L360BKW	Key & Cylinder for Grade 2 Tubular Leverset Entry/Classroom	US26	1	\$18.64
FKC-L370BKW	Key & Cylinder for Grade 2 Tubular Leverset Entry/Classroom	US3	1	\$18.64
FKC-L365BKW	Key & Cylinder for Grade 2 Tubular Leverset Storeroom	US26	1	\$18.64
FKC-L375BKW	Key & Cylinder for Grade 2 Tubular Leverset Storeroom	US3	1	\$18.64
 FKC-IS23KW	Key & Cylinder for G2 Interconnected Lock - Single Locking	US26	1	\$18.64
FKC-ISP3KW	Key & Cylinder for G2 Interconnected Lock - Single Locking	US15	1	\$18.64
FKC-IN03KW	Key & Cylinder for G2 Interconnected Lock - Single Locking	US10B	1	\$18.64
FKC-I363KW	Key & Cylinder for G2 Interconnected Lock - Single Locking	US32D	1	\$18.64
FKC-I373KW	Key & Cylinder for G2 Interconnected Lock - Single Locking	US3	1	\$18.64
FKC-INP3KW	Key & Cylinder for G2 Interconnected Lock - Single Locking	US15	1	\$18.64
FKC-I3S3KW	Key & Cylinder for G2 Interconnected Lock - Single Locking	US26D	1	\$18.64
FKC-IN00KW	Key & Cylinder for G2 Interconnected Lock - Double Locking	US10B	1	\$29.86
FKC-I360KW	Key & Cylinder for G2 Interconnected Lock - Double Locking	US32D	1	\$29.86
FKC-I370KW	Key & Cylinder for G2 Interconnected Lock - Double Locking	US3	1	\$29.86
FKC-INP0KW	Key & Cylinder for G2 Interconnected Lock - Double Locking	US15	1	\$29.86
FKC-I3S0KW	Key & Cylinder for G2 Interconnected Lock - Double Locking	US26D	1	\$29.86

	Model #	Function	Finish	QTY	List Price
	FKC-D701KW	Key & Cylinder for FD701	US10B	1	\$18.64
	FKC-D721KW	Key & Cylinder for FD721	US26	1	\$18.64
	FKC-D761KW	Key & Cylinder for FD761	US32D	1	\$18.64
	FKC-D771KW	Key & Cylinder for FD771	US3	1	\$18.64
	FKC-D781KW	Key & Cylinder for FD781	US5	1	\$18.64
	FKC-D7S1KW	Key & Cylinder for FD7S1	US26D	1	\$18.64
	FKC-D7P1KW	Key & Cylinder for FD7P1	US15	1	\$18.64
	FKC-D702KW	Key & Cylinder for FD702	US10B	1	\$29.86
	FKC-D722KW	Key & Cylinder for FD722	US26	1	\$29.86
	FKC-D762KW	Key & Cylinder for FD762	US32D	1	\$29.86
	FKC-D772KW	Key & Cylinder for FD772	US3	1	\$29.86
	FKC-D782KW	Key & Cylinder for FD782	US5	1	\$29.86
	FKC-D7S2KW	Key & Cylinder for FD7S2	US26D	1	\$29.86
	FKC-D7P2KW	Key & Cylinder for FD7P2	US15	1	\$29.86
COMMERCIAL LOCKS KEY AND CYLINDER -- SCHLAGE 6-PIN KEYWAY					
	FKC-Y3S0SC	Key & Cylinder for Princeton Entry/Storage	US26	1	\$18.64
	FKC-Y370SC	Key & Cylinder for Princeton Entry/Storage	US3	1	\$18.64
	FKC-Y3S5SC	Key & Cylinder for Princeton Classroom	US26	1	\$18.64
	FKC-Y375SC	Key & Cylinder for Princeton Classroom	US3	1	\$18.64
	FKC-Y3SDSC	Key & Cylinder for Princeton Clutch Entry/Storage	US26	1	\$18.64
	FKC-L360BSC	Key & Cylinder for Grade 2 Tubular Leverset Entry/Classroom	US26	1	\$18.64
	FKC-L370BSC	Key & Cylinder for Grade 2 Tubular Leverset Entry/Classroom	US3	1	\$18.64
	FKC-L365BSC	Key & Cylinder for Grade 2 Tubular Leverset Storage	US26	1	\$18.64
	FKC-L375BSC	Key & Cylinder for Grade 2 Tubular Leverset Storage	US3	1	\$18.64
	FKC-IS23SC	Key & Cylinder for G2 Interconnected Lock - Single Locking	US26	1	\$18.64
	FKC-ISP3SC	Key & Cylinder for G2 Interconnected Lock - Single Locking	US15	1	\$18.64
	FKC-IN03SC	Key & Cylinder for G2 Interconnected Lock - Single Locking	US10B	1	\$18.64
	FKC-I363SC	Key & Cylinder for G2 Interconnected Lock - Single Locking	US32D	1	\$18.64
	FKC-I373SC	Key & Cylinder for G2 Interconnected Lock - Single Locking	US3	1	\$18.64
	FKC-INP3SC	Key & Cylinder for G2 Interconnected Lock - Single Locking	US15	1	\$18.64
	FKC-I3S3SC	Key & Cylinder for G2 Interconnected Lock - Single Locking	US26D	1	\$18.64
	FKC-IN00SC	Key & Cylinder for G2 Interconnected Lock - Double Locking	US10B	1	\$29.86
	FKC-I360SC	Key & Cylinder for G2 Interconnected Lock - Double Locking	US32D	1	\$29.86
	FKC-I370SC	Key & Cylinder for G2 Interconnected Lock - Double Locking	US3	1	\$29.86
	FKC-INP0SC	Key & Cylinder for G2 Interconnected Lock - Double Locking	US15	1	\$29.86
	FKC-I3S0SC	Key & Cylinder for G2 Interconnected Lock - Double Locking	US26D	1	\$29.86
	FKC-D701SC	Key & Cylinder for FD701	US10B	1	\$18.64
	FKC-D721SC	Key & Cylinder for FD721	US26	1	\$18.64
	FKC-D761SC	Key & Cylinder for FD761	US32D	1	\$18.64
	FKC-D771SC	Key & Cylinder for FD771	US3	1	\$18.64
	FKC-D781SC	Key & Cylinder for FD781	US5	1	\$18.64
	FKC-D7S1SC	Key & Cylinder for FD7S1	US26D	1	\$18.64
	FKC-D7P1SC	Key & Cylinder for FD7P1	US15	1	\$18.64
		FKC-D702SC	Key & Cylinder for FD702	US10B	1
FKC-D722SC		Key & Cylinder for FD722	US26	1	\$29.86
FKC-D762SC		Key & Cylinder for FD762	US32D	1	\$29.86
FKC-D772SC		Key & Cylinder for FD772	US3	1	\$29.86
FKC-D782SC		Key & Cylinder for FD782	US5	1	\$29.86
FKC-D7S2SC		Key & Cylinder for FD7S2	US26D	1	\$29.86
FKC-D7P2SC		Key & Cylinder for FD7P2	US15	1	\$29.86

PARTS FOR LOCKS

Model #	Description	Finish	QTY	List Price
	FSP-S7P31 Screw Pack for Single Cylinder Handleset	Chrome	1	\$3.76
	FSP-S7731 Screw Pack for Single Cylinder Handleset	Brass	1	\$3.76
	FSP-S7831 Screw Pack for Single Cylinder Handleset	Black	1	\$3.76
	FSP-S7P32 Screw Pack for Double Cylinder Handleset	Chrome	1	\$3.76
	FSP-S7732 Screw Pack for Double Cylinder Handleset	Brass	1	\$3.76
	FSP-S7832 Screw Pack for Double Cylinder Handleset	Black	1	\$3.76
	FSP-S7P34 Screw Pack for Dummy Handleset	Chrome	1	\$3.76
	FSP-S7734 Screw Pack for Dummy Handleset	Brass	1	\$3.76
	FSP-S7834 Screw Pack for Dummy Handleset	Black	1	\$3.76
	FSP-T36 Screw Pack for Knobset and Leverset	Chrome	1	\$1.88
	FSP-T37 Screw Pack for Knobset and Leverset	Brass	1	\$1.88
	FSP-T38 Screw Pack for Knobset and Leverset	Black	1	\$1.88
	FSP-LT2 Screw Pack for Contemporary Leverset	Chrome	1	\$1.88
	FSP-D361 Screw Pack for FD2, FD3, FDK, FDS Single Cylinder Deadbolt	Chrome	1	\$1.88
	FSP-D371 Screw Pack for FD2 and FD3 Single Cylinder Deadbolt	Brass	1	\$1.88
	FSP-D381 Screw Pack for FD2 and FD3 Single Cylinder Deadbolt	Black	1	\$1.88
	FSP-D362 Screw Pack for FD2, FD3, FDK, FDS Double Cylinder Deadbolt	Chrome	1	\$1.88
	FSP-D372 Screw Pack for FD2 and FD3 Double Cylinder Deadbolt	Brass	1	\$1.88
	FSP-D382 Screw Pack for FD2 and FD3 Double Cylinder Deadbolt	Black	1	\$1.88
	FSPMD-S7P31 Machine Screw for Single Cylinder Handleset Deadbolt	Chrome	1	\$0.53
	FSPMD-S7731 Machine Screw for Single Cylinder Handleset Deadbolt	Brass	1	\$0.53
	FSPMD-S7831 Machine Screw for Single Cylinder Handleset Deadbolt	Black	1	\$0.53
	FSPMD-S7P32 Machine Screw for Double Cylinder Handleset Deadbolt	Chrome	1	\$0.53
	FSPMD-S7732 Machine Screw for Double Cylinder Handleset Deadbolt	Brass	1	\$0.53
	FSPMD-S7832 Machine Screw for Double Cylinder Handleset Deadbolt	Black	1	\$0.53
	FSPM-T36 Machine Screw for Knobset and Leverset	Chrome	1	\$0.53
	FSPM-T37 Machine Screw for Knobset and Leverset	Brass	1	\$0.53
	FSPM-T38 Machine Screw for Knobset and Leverset	Black	1	\$0.53
	FSPM-LT2 Machine Screw for Mira, Tahoe, Onyx Series	Chrome	1	\$0.53
	FSPM-D361 Machine Screw for FD2, FD3, FDK, FDS Single Cylinder Deadbolt	Chrome	1	\$0.53
	FSPM-D371 Machine Screw for FD2 and FD3 Single Cylinder Deadbolt	Brass	1	\$0.53
	FSPM-D381 Machine Screw for FD2 and FD3 Single Cylinder Deadbolt	Black	1	\$0.53
	FSPM-D362 Machine Screw for FD2, FD3, FDK, FDS Double Cylinder Deadbolt	Chrome	1	\$0.53
	FSPM-D372 Machine Screw for FD2 and FD3 Double Cylinder Deadbolt	Brass	1	\$0.53
	FSPM-D382 Machine Screw for FD2 and FD3 Double Cylinder Deadbolt	Black	1	\$0.53
	FSPW-6 Two-part Wood Screw for Strike and Latch	Chrome	1	\$0.27
	FSPW-7 Two-part Wood Screw for Strike and Latch	Brass	1	\$0.27
	FSPW-8 Two-part Wood Screw for Strike and Latch	Black	1	\$0.27
	FSPW-6ASA Two-part Wood Screw for ASA Strike	Chrome	1	\$0.41
	FSPW-7ASA Two-part Wood Screw for ASA Strike	Brass	1	\$0.41
	FSPW-8ASA Two-part Wood Screw for ASA Strike	Black	1	\$0.41
	FSPW3-6 3" Wood Screw for Strike	Chrome	1	\$0.80
	FSPW3-9 3" Wood Screw for Strike	Black	1	\$0.80



Model #	Description	Finish	QTY	List Price
FSP-Y3S	Screw Pack for Princeton Series	Chrome	1	\$1.88
FSP-Y37	Screw Pack for Princeton Series	Brass	1	\$1.88
FSP-Y38	Screw Pack for Princeton Series	Black	1	\$1.88
FSP-L36B	Screw Pack for G2 Tubular Locks	Chrome	1	\$1.88
FSP-L37B	Screw Pack for G2 Tubular Locks	Brass	1	\$1.88
FSP-L38B	Screw Pack for G2 Tubular Locks	Black	1	\$1.88
FSP-D761	Screw Pack for FDP/FD7/FD8 Single Cylinder Deadbolt	Chrome	1	\$1.88
FSP-D771	Screw Pack for FDP/FD7/FD8 Single Cylinder Deadbolt	Brass	1	\$1.88
FSP-D781	Screw Pack for FDP/FD7/FD8 Single Cylinder Deadbolt	Black	1	\$1.88
FSP-D762	Screw Pack for FDP/FD7 Double Cylinder Deadbolt	Chrome	1	\$1.88
FSP-D772	Screw Pack for FDP/FD7 Double Cylinder Deadbolt	Brass	1	\$1.88
FSP-D782	Screw Pack for FDP/FD7 Double Cylinder Deadbolt	Black	1	\$1.88
FSP-I36	Screw Pack for G2 Interconnected Locks	Chrome	1	\$3.76
FSP-I37	Screw Pack for G2 Interconnected Locks	Brass	1	\$3.76
FSP-I30	Screw Pack for G2 Interconnected Locks	Black	1	\$3.76
FSPM-YC	Machine Screw for FYA/FYC Series	Chrome	1	\$0.53
FSPM-L36B	Machine Screw for FL36B, FL3SB, FLNPB, FT36B Series	Chrome	1	\$0.53
FSPM-L37B	Machine Screw for FL37B, FT37B Series	Brass	1	\$0.53
FSPM-L38B	Machine Screw for FL38B, FLN0B, FT38B Series	Black	1	\$0.53
FSPM-D761	Machine Screw for FDP/FD7/FD8 Single Cylinder Deadbolt	Chrome	1	\$0.53
FSPM-D771	Machine Screw for FDP/FD7/FD8 Single Cylinder Deadbolt	Brass	1	\$0.53
FSPM-D781	Machine Screw for FDP/FD7/FD8 Single Cylinder Deadbolt	Black	1	\$0.53
FSPM-D762	Machine Screw for DP/FD7 Double Cylinder Deadbolt	Chrome	1	\$0.53
FSPM-D772	Machine Screw for DP/FD7 Double Cylinder Deadbolt	Brass	1	\$0.53
FSPM-D782	Machine Screw for DP/FD7 Double Cylinder Deadbolt	Black	1	\$0.53
FSPMR-D761	1/4"x1-1/2" Machine Screw for FD7 Rose Plate	Chrome	1	\$0.53
FSPMR-D771	1/4"x1-1/2" Machine Screw for FD7 Rose Plate	Brass	1	\$0.53
FSPMR-D781	1/4"x1-1/2" Machine Screw for FD7 Rose Plate	Black	1	\$0.53
FSPMD-I3	Machine Screw for Interconnected Lock Deadbolt	Chrome	1	\$0.53
FSPMC-I3	Machine Screw for Interconnected Lock Plate	Black	1	\$0.53
FSPML-I36	Machine Screw for Interconnected Lock Loverset	Chrome	1	\$0.53
FSPML-I37	Machine Screw for Interconnected Lock Loverset	Brass	1	\$0.53
FSPML-I30	Machine Screw for Interconnected Lock Loverset	Black	1	\$0.53

*Locks in US 32D, 15, 15A, 26 or 26D finishes will be packaged with chrome screws.

*Locks in US 5, 10B, 11P or 19 finishes will be packaged with black screws.

PARTS FOR LOCKS



For Cylindrical Lockset
UL Listed
Square Corner
1/2" Throw Mortise Latch



Deadlatch



Plainlatch

Model #	Description	Finish	QTY	List Price
FCS01-UL	1" Face Plate, 2-3/8", Deadlatch, UL Listed	US10B(19)	1	\$21.54
FCS02A-UL	1" Face Plate, 2-3/8", Plainlatch, Privacy, UL Listed	US10B(19)	1	\$21.54
FCS02-UL	1" Face Plate, 2-3/8", Plainlatch, Passage, UL Listed	US10B(19)	1	\$21.54
FCS03-UL	1" Face Plate, 2-3/4", Deadlatch, UL Listed	US10B(19)	1	\$21.54
FCS04A-UL	1" Face Plate, 2-3/4", Plainlatch, Privacy, UL Listed	US10B(19)	1	\$21.54
FCS04-UL	1" Face Plate, 2-3/4", Plainlatch, Passage, UL Listed	US10B(19)	1	\$21.54
FCS03W-UL	1-1/8" Face Plate, 2-3/4", Deadlatch, UL Listed	US10B(19)	1	\$21.54
FCS04AW-UL	1-1/8" Face Plate, 2-3/4", Plainlatch, Privacy, UL Listed	US10B(19)	1	\$21.54
FCS04W-UL	1-1/8" Face Plate, 2-3/4", Plainlatch, Passage, UL Listed	US10B(19)	1	\$21.54
FCS61-UL	1" Face Plate, 2-3/8", Deadlatch, UL Listed	US32D	1	\$21.54
FCS62A-UL	1" Face Plate, 2-3/8", Plainlatch, Privacy, UL Listed	US32D	1	\$21.54
FCS62-UL	1" Face Plate, 2-3/8", Plainlatch, Passage, UL Listed	US32D	1	\$21.54
FCS63-UL	1" Face Plate, 2-3/4", Deadlatch, UL Listed	US32D	1	\$21.54
FCS64A-UL	1" Face Plate, 2-3/4", Plainlatch, Privacy, UL Listed	US32D	1	\$21.54
FCS64-UL	1" Face Plate, 2-3/4", Plainlatch, Passage, UL Listed	US32D	1	\$21.54
FCS63W-UL	1-1/8" Face Plate, 2-3/4", Deadlatch, UL Listed	US32D	1	\$21.54
FCS64AW-UL	1-1/8" Face Plate, 2-3/4", Plainlatch, Privacy, UL Listed	US32D	1	\$21.54
FCS64W-UL	1-1/8" Face Plate, 2-3/4", Plainlatch, Passage, UL Listed	US32D	1	\$21.54
FCS71-UL	1" Face Plate, 2-3/8", Deadlatch, UL Listed	US3	1	\$21.54
FCS72A-UL	1" Face Plate, 2-3/8", Plainlatch, Privacy, UL Listed	US3	1	\$21.54
FCS72-UL	1" Face Plate, 2-3/8", Plainlatch, Passage, UL Listed	US3	1	\$21.54
FCS73-UL	1" Face Plate, 2-3/4", Deadlatch, UL Listed	US3	1	\$21.54
FCS74A-UL	1" Face Plate, 2-3/4", Plainlatch, Privacy, UL Listed	US3	1	\$21.54
FCS74-UL	1" Face Plate, 2-3/4", Plainlatch, Passage, UL Listed	US3	1	\$21.54
FCS73W-UL	1-1/8" Face Plate, 2-3/4", Deadlatch, UL Listed	US3	1	\$21.54
FCS74AW-UL	1-1/8" Face Plate, 2-3/4", Plainlatch, Privacy, UL Listed	US3	1	\$21.54
FCS74W-UL	1-1/8" Face Plate, 2-3/4", Plainlatch, Passage, UL Listed	US3	1	\$21.54
FCS81-UL	1" Face Plate, 2-3/8", Deadlatch, UL Listed	US5	1	\$21.54
FCS82A-UL	1" Face Plate, 2-3/8", Plainlatch, Privacy, UL Listed	US5	1	\$21.54
FCS82-UL	1" Face Plate, 2-3/8", Plainlatch, Passage, UL Listed	US5	1	\$21.54
FCS83-UL	1" Face Plate, 2-3/4", Deadlatch, UL Listed	US5	1	\$21.54
FCS84A-UL	1" Face Plate, 2-3/4", Plainlatch, Privacy, UL Listed	US5	1	\$21.54
FCS84-UL	1" Face Plate, 2-3/4", Plainlatch, Passage, UL Listed	US5	1	\$21.54
FCS83W-UL	1-1/8" Face Plate, 2-3/4", Deadlatch, UL Listed	US5	1	\$21.54
FCS84AW-UL	1-1/8" Face Plate, 2-3/4", Plainlatch, Privacy, UL Listed	US5	1	\$21.54
FCS84W-UL	1-1/8" Face Plate, 2-3/4", Plainlatch, Passage, UL Listed	US5	1	\$21.54



For Cylindrical Lockset
UL Listed
Square Corner
3/4" Throw, Anti-friction Deadlatch



FCS03WT-UL	1-1/8" Face Plate, 2-3/4", Deadlatch, UL Listed	US10B(19)	1	\$95.09
FCS63WT-UL	1-1/8" Face Plate, 2-3/4", Deadlatch, UL Listed	US32D	1	\$95.09

* All latches are not sold with screws.



For Cylindrical Lockset
1/4" Radius Round Corner
1/2" Throw Mortise Latch



Deadlatch



Plainlatch

Model #	Description	Finish	QTY	List Price
FCR01-UL	1" Face Plate, 2-3/8", Deadlatch, UL Listed	US10B(19)	1	\$21.54
FCR02A-UL	1" Face Plate, 2-3/8", Plainlatch, Privacy, UL Listed	US10B(19)	1	\$21.54
FCR02-UL	1" Face Plate, 2-3/8", Plainlatch, Passage, UL Listed	US10B(19)	1	\$21.54
FCR03-UL	1" Face Plate, 2-3/4", Deadlatch, UL Listed	US10B(19)	1	\$21.54
FCR04A-UL	1" Face Plate, 2-3/4", Plainlatch, Privacy, UL Listed	US10B(19)	1	\$21.54
FCR04-UL	1" Face Plate, 2-3/4", Plainlatch, Passage, UL Listed	US10B(19)	1	\$21.54
FCR61-UL	1" Face Plate, 2-3/8", Deadlatch, UL Listed	US32D	1	\$21.54
FCR62A-UL	1" Face Plate, 2-3/8", Plainlatch, Privacy, UL Listed	US32D	1	\$21.54
FCR62-UL	1" Face Plate, 2-3/8", Plainlatch, Passage, UL Listed	US32D	1	\$21.54
FCR63-UL	1" Face Plate, 2-3/4", Deadlatch, UL Listed	US32D	1	\$21.54
FCR64A-UL	1" Face Plate, 2-3/4", Plainlatch, Privacy, UL Listed	US32D	1	\$21.54
FCR64-UL	1" Face Plate, 2-3/4", Plainlatch, Passage, UL Listed	US32D	1	\$21.54
FCR71-UL	1" Face Plate, 2-3/8", Deadlatch, UL Listed	US3	1	\$21.54
FCR72A-UL	1" Face Plate, 2-3/8", Plainlatch, Privacy, UL Listed	US3	1	\$21.54
FCR72-UL	1" Face Plate, 2-3/8", Plainlatch, Passage, UL Listed	US3	1	\$21.54
FCR73-UL	1" Face Plate, 2-3/4", Deadlatch, UL Listed	US3	1	\$21.54
FCR74A-UL	1" Face Plate, 2-3/4", Plainlatch, Privacy, UL Listed	US3	1	\$21.54
FCR74-UL	1" Face Plate, 2-3/4", Plainlatch, Passage, UL Listed	US3	1	\$21.54
FCR81-UL	1" Face Plate, 2-3/8", Deadlatch, UL Listed	US5	1	\$21.54
FCR82A-UL	1" Face Plate, 2-3/8", Plainlatch, Privacy, UL Listed	US5	1	\$21.54
FCR82-UL	1" Face Plate, 2-3/8", Plainlatch, Passage, UL Listed	US5	1	\$21.54
FCR83-UL	1" Face Plate, 2-3/4", Deadlatch, UL Listed	US5	1	\$21.54
FCR84A-UL	1" Face Plate, 2-3/4", Plainlatch, Privacy, UL Listed	US5	1	\$21.54
FCR84-UL	1" Face Plate, 2-3/4", Plainlatch, Passage, UL Listed	US5	1	\$21.54

* All latches are not sold with screws.



For Tubular Lockset
 UL Listed
 Square Corner
 1/2" Throw Mortise Latch



Deadlatch



Plainlatch

Model #	Description	Finish	QTY	List Price
FTS05-UL	1" Face Plate, Adjustable Deadlatch, UL Listed	US10B(19)	1	\$23.14
FTS06-UL	1" Face Plate, Adjustable Plainlatch, UL Listed	US10B(19)	1	\$23.14
FTS05G-UL	1" Face Plate, Adjustable Deadlatch, UL Listed for Storeroom, Classroom and Interconnected Locks	US10B(19)	1	\$23.14
FTS06G-UL	1" Face, Adj. Plainlatch, UL, for Interconnected Locks	US10B(19)	1	\$23.14
FTS05WG-UL	1-1/8" Face Plate, Adjustable Deadlatch, UL Listed for Storeroom, Classroom and Interconnected Locks	US10B(19)	1	\$23.14
FTS06WG-UL	1-1/8" Face, Adj. Plainlatch, UL, for Interconnected Locks	US10B(19)	1	\$23.14
FTS06C-UL	1" Face Plate, Adjustable Plainlatch, UL Listed for Mira, Tahoe, Onyx Series only (45° Structure)	US10B(19)	1	\$28.93
FTS65-UL	1" Face Plate, Adjustable Deadlatch, UL Listed	US32D	1	\$23.14
FTS66-UL	1" Face Plate, Adjustable Plainlatch, UL Listed	US32D	1	\$23.14
FTS65G-UL	1" Face Plate, Adjustable Deadlatch, UL Listed for Storeroom, Classroom and Interconnected Locks	US32D	1	\$23.14
FTS66G-UL	1" Face, Adj. Plainlatch, UL, for Interconnected Locks	US32D	1	\$23.14
FTS65WG-UL	1-1/8" Face Plate, Adjustable Deadlatch, UL Listed for Storeroom, Classroom and Interconnected Locks	US32D	1	\$23.14
FTS66WG-UL	1-1/8" Face, Adj. Plainlatch, UL, for Interconnected Locks	US32D	1	\$23.14
FTS66C-UL	1" Face Plate, Adjustable Plainlatch, UL Listed for Mira, Tahoe, Onyx Series only (45° Structure)	US32D	1	\$28.93
FTS75-UL	1" Face Plate, Adjustable Deadlatch, UL Listed	US3	1	\$23.14
FTS76-UL	1" Face Plate, Adjustable Plainlatch, UL Listed	US3	1	\$23.14
FTS75G-UL	1" Face Plate, Adjustable Deadlatch, UL Listed for Storeroom, Classroom and Interconnected Locks	US3	1	\$23.14
FTS76G-UL	1" Face, Adj. Plainlatch, UL, for Interconnected Locks	US3	1	\$23.14
FTS75WG-UL	1-1/8" Face Plate, Adjustable Deadlatch, UL Listed for Storeroom, Classroom and Interconnected Locks	US3	1	\$23.14
FTS76WG-UL	1-1/8" Face, Adj. Plainlatch, UL, for Interconnected Locks	US3	1	\$23.14
FTS85-UL	1" Face Plate, Adjustable Deadlatch, UL Listed	US5	1	\$23.14
FTS86-UL	1" Face Plate, Adjustable Plainlatch, UL Listed	US5	1	\$23.14
FTS85G-UL	1" Face Plate, Adjustable Deadlatch, UL Listed for Storeroom, and Classroom	US5	1	\$23.14

* All latches are not sold with screws.



For Tubular Lockset
UL Listed
1/4" Radius Round Corner
1/2" Throw Mortise Latch



Deadlatch



Plainlatch

Model #	Description	Finish	QTY	List Price
FTR05-UL	1" Face Plate, Adjustable Deadlatch, UL Listed	US10B(19)	1	\$23.14
FTR06-UL	1" Face Plate, Adjustable Plainlatch, UL Listed	US10B(19)	1	\$23.14
FTR05G-UL	1" Face Plate, Adjustable Deadlatch, UL List for Storeroom, Classroom and Interconnected Locks	US10B(19)	1	\$23.14
FTR06G-UL	1" Face, Adj. Plainlatch, UL, for Interconnected Locks	US10B(19)	1	\$23.14
FTR06C-UL	1" Face Plate, Adjustable Plainlatch, UL Listed for Mira, Tahoe, Onyx Series only (45° Structure)	US10B(19)	1	\$28.93
FTR65-UL	1" Face Plate, Adjustable Deadlatch, UL Listed	US32D	1	\$23.14
FTR66-UL	1" Face Plate, Adjustable Plainlatch, UL Listed	US32D	1	\$23.14
FTR65G-UL	1" Face Plate, Adjustable Deadlatch, UL Listed for Storeroom, Classroom and Interconnected Locks	US32D	1	\$23.14
FTR66G-UL	1" Face, Adj. Plainlatch, UL, for Interconnected Locks	US32D	1	\$23.14
FTR66C-UL	1" Face Plate, Adjustable Plainlatch, UL Listed for Mira, Tahoe, Onyx Series only (45° Structure)	US32D	1	\$28.93
FTR75-UL	1" Face Plate, Adjustable Deadlatch, UL Listed	US3	1	\$23.14
FTR76-UL	1" Face Plate, Adjustable Plainlatch, UL Listed	US3	1	\$23.14
FTR75G-UL	1" Face Plate, Adjustable Deadlatch, UL Listed for Storeroom, Classroom and Interconnected Locks	US3	1	\$23.14
FTR76G-UL	1" Face, Adj. Deadlatch, UL, for Interconnected Locks	US3	1	\$23.14
FTR85-UL	1" Face Plate, Adjustable Deadlatch, UL Listed	US5	1	\$23.14
FTR86-UL	1" Face Plate, Adjustable Plainlatch, UL Listed	US5	1	\$23.14
FTR85G-UL	1" Face Plate, Adjustable Deadlatch, UL Listed for Storeroom, and Classroom	US5	1	\$23.14

Gate Latch for Deadbolt
1/4" Radius Round Corner
1/2" Throw Mortise Latch



FTDR01	1" Face Plate, 2-3/8", Gate Latch	US10B(19)	1	\$25.87
FTDR61	1" Face Plate, 2-3/8", Gate Latch	US32D	1	\$25.87

* All latches are not sold with screws.



For G2 & G3 Deadbolts
UL Listed
Square Corner
1" Throw Mortise Deadbolt



Model #	Description	Finish	QTY	List Price
FDS05-UL	1" Face Plate, Adjustable Deadbolt, UL Listed	US10B(19)	1	\$25.87
FDS05W-UL	1-1/8" Face Plate, Adjustable Deadbolt, UL Listed	US10B(19)	1	\$25.87
FDS65-UL	1" Face Plate, Adjustable Deadbolt, UL Listed	US32D	1	\$25.87
FDS65W-UL	1-1/8" Face Plate, Adjustable Deadbolt, UL Listed	US32D	1	\$25.87
FDS75-UL	1" Face Plate, Adjustable Deadbolt, UL Listed	US3	1	\$25.87
FDS75W-UL	1-1/8" Face Plate, Adjustable Deadbolt, UL Listed	US3	1	\$25.87
FDS85-UL	1" Face Plate, Adjustable Deadbolt, UL Listed	US5	1	\$25.87



For G2 & G3 Deadbolts
UL Listed
1/4" Radius Round Corner
1" Throw Mortise Deadbolt



FDR05-UL	1" Face Plate, Adjustable Deadbolt, UL Listed	US10B(19)	1	\$25.87
FDR65-UL	1" Face Plate, Adjustable Deadbolt, UL Listed	US32D	1	\$25.87
FDR75-UL	1" Face Plate, Adjustable Deadbolt, UL Listed	US3	1	\$25.87
FDR85-UL	1" Face Plate, Adjustable Deadbolt, UL Listed	US5	1	\$25.87



For G1 Deadbolts
UL Listed
Square Corner
1" Throw Mortise Deadbolt



FDS05PW-UL	1-1/8" Face Plate, Adjustable Deadbolt, UL Listed	US10B(19)	1	\$34.50
FDS65PW-UL	1-1/8" Face Plate, Adjustable Deadbolt, UL Listed	US32D	1	\$34.50

* All latches are not sold with screws.

For Cylindrical Lockset
1/4" Radius Round Corner
1/2" Throw Mortise Latch



Deadlatch



Plainlatch

Model #	Description	Finish	QTY	List Price
FCR61	1" Face Plate, 2-3/8", Deadlatch	US32D	1	\$8.06
FCR62A	1" Face Plate, 2-3/8", Plainlatch, Privacy	US32D	1	\$8.06
FCR62	1" Face Plate, 2-3/8", Plainlatch, Passage	US32D	1	\$8.06
FCR63	1" Face Plate, 2-3/4", Deadlatch	US32D	1	\$8.06
FCR64A	1" Face Plate, 2-3/4", Plainlatch, Privacy	US32D	1	\$8.06
FCR64	1" Face Plate, 2-3/4", Plainlatch, Passage	US32D	1	\$8.06
FCR71	1" Face Plate, 2-3/8", Deadlatch	US3	1	\$8.06
FCR72A	1" Face Plate, 2-3/8", Plainlatch, Privacy	US3	1	\$8.06
FCR72	1" Face Plate, 2-3/8", Plainlatch, Passage	US3	1	\$8.06
FCR73	1" Face Plate, 2-3/4", Deadlatch	US3	1	\$8.06
FCR74A	1" Face Plate, 2-3/4", Plainlatch, Privacy	US3	1	\$8.06
FCR74	1" Face Plate, 2-3/4", Plainlatch, Passage	US3	1	\$8.06
FCR81	1" Face Plate, 2-3/8", Deadlatch	US5	1	\$8.06
FCR82A	1" Face Plate, 2-3/8", Plainlatch, Privacy	US5	1	\$8.06
FCR82	1" Face Plate, 2-3/8", Plainlatch, Passage	US5	1	\$8.06
FCR83	1" Face Plate, 2-3/4", Deadlatch	US5	1	\$8.06
FCR84A	1" Face Plate, 2-3/4", Plainlatch, Privacy	US5	1	\$8.06
FCR84	1" Face Plate, 2-3/4", Plainlatch, Passage	US5	1	\$8.06

* All latches are not sold with screws.

For Tubular Lockset
Square Corner
1/2" Throw Mortise Latch



Deadlatch



Plainlatch

FTS05	1" Face Plate, Adjustable Deadlatch	US10B(19)	1	\$9.71
FTS06	1" Face Plate, Adjustable Plainlatch	US10B(19)	1	\$9.71
FTS06C	1" Face Plate, Adjustable Plainlatch for Mira, Tahoe, Onyx Series only (45° Structure)	US10B(19)	1	\$12.13
FTS65	1" Face Plate, Adjustable Deadlatch	US32D	1	\$9.71
FTS66	1" Face Plate, Adjustable Plainlatch	US32D	1	\$9.71
FTS66C	1" Face Plate, Adjustable Plainlatch for Mira, Tahoe, Onyx Series only (45° Structure)	US32D	1	\$12.13
FTS75	1" Face Plate, Adjustable Deadlatch	US3	1	\$9.71
FTS76	1" Face Plate, Adjustable Plainlatch	US3	1	\$9.71
FTS85	1" Face Plate, Adjustable Deadlatch	US5	1	\$9.71
FTS86	1" Face Plate, Adjustable Plainlatch	US5	1	\$9.71

* All latches are not sold with screws.

For Tubular Lockset
1/4" Radius Round Corner
1/2" Throw Mortise Latch



Deadlatch



Plainlatch

Model #	Description	Finish	QTY	List Price
FTR05	1" Face Plate, Adjustable Deadlatch	US10B(19)	1	\$9.71
FTR06	1" Face Plate, Adjustable Plainlatch	US10B(19)	1	\$9.71
FTR06C	1" Face Plate, Adjustable Plainlatch for Mira, Tahoe, Onyx Series only (45° Structure)	US10B(19)	1	\$12.13
FTR65	1" Face Plate, Adjustable Deadlatch	US32D	1	\$9.71
FTR66	1" Face Plate, Adjustable Plainlatch	US32D	1	\$9.71
FTR66C	1" Face Plate, Adjustable Plainlatch for Mira, Tahoe, Onyx Series only (45° Structure)	US32D	1	\$12.13
FTR75	1" Face Plate, Adjustable Deadlatch	US3	1	\$9.71
FTR76	1" Face Plate, Adjustable Plainlatch	US3	1	\$9.71
FTR85	1" Face Plate, Adjustable Deadlatch	US5	1	\$9.71
FTR86	1" Face Plate, Adjustable Plainlatch	US5	1	\$9.71
FTRK5	1" Face Plate, Adjustable Deadlatch	US11P	1	\$9.71
FTRK6	1" Face Plate, Adjustable Plainlatch	US11P	1	\$9.71

For Deadbolt
Square Corner,
1" Throw Mortise Deadbolt



FDS05	1" Face Plate, Adjustable Deadbolt	US10B(19)	1	\$12.41
FDS65	1" Face Plate, Adjustable Deadbolt	US32D	1	\$12.41
FDS75	1" Face Plate, Adjustable Deadbolt	US3	1	\$12.41
FDS85	1" Face Plate, Adjustable Deadbolt	US5	1	\$12.41



For Deadbolt
1/4" Radius Round Corner,
1" Throw Mortise Deadbolt





FDR05	1" Face Plate, Adjustable Deadbolt	US10B(19)	1	\$12.41
FDR65	1" Face Plate, Adjustable Deadbolt	US32D	1	\$12.41
FDR75	1" Face Plate, Adjustable Deadbolt	US3	1	\$12.41
FDR85	1" Face Plate, Adjustable Deadbolt	US5	1	\$12.41
FDRK5	1" Face Plate, Adjustable Deadbolt	US11P	1	\$12.41

* All latches are not sold with screws.

DRIVE-IN LATCHES AND FACE PLATES

	Model #	Description	Finish	QTY	List Price
<p>For Tubular Lockset Drive-in Latch, 1/2" Throw</p>  <p>Deadlatch</p>  <p>Plainlatch</p>	FTD05	1" Drive-In, Adjustable Deadlatch	US10B(19)	1	\$9.71
	FTD06	1" Drive-In, Adjustable Plainlatch	US10B(19)	1	\$9.71
	FTD65	1" Drive-In, Adjustable Deadlatch	US32D	1	\$9.71
	FTD66	1" Drive-In, Adjustable Plainlatch	US32D	1	\$9.71
	FTD66C	1" Drive-In, Adjustable Plainlatch for Mira, Tahoe, Onyx Series only (45° Structure)	US32D	1	\$12.13
	FTD75	1" Drive-In, Adjustable Deadlatch	US3	1	\$9.71
	FTD76	1" Drive-In, Adjustable Plainlatch	US3	1	\$9.71
	FTD85	1" Drive-In, Adjustable Deadlatch	US5	1	\$9.71
	FTD86	1" Drive-In, Adjustable Plainlatch	US5	1	\$9.71

<p>For Deadbot Drive-in Latch, 1" Throw</p> 	FDD05	1" Drive-In, Adjustable Deadbolt	US10B(19)	1	\$12.41
	FDD65	1" Drive-In, Adjustable Deadbolt	US32D	1	\$12.41
	FDD75	1" Drive-In, Adjustable Deadbolt	US3	1	\$12.41
	FDD85	1" Drive-In, Adjustable Deadbolt	US5	1	\$12.41

 	FSFP-SS	2-1/4"x1" Square Corner Removal Face Plate	US32D	1	\$1.88
	FSFP-PB	2-1/4"x1" Square Corner Removal Face Plate	US3	1	\$1.88
	FSFP-AB	2-1/4"x1" Square Corner Removal Face Plate	US5	1	\$1.88
	FSFP-OB	2-1/4"x1" Square Corner Removal Face Plate	US10B(19)	1	\$1.88
	FRFP-SS	2-1/4"x1" Round Corner Removal Face Plate	US32D	1	\$1.88
	FRFP-PB	2-1/4"x1" Round Corner Removal Face Plate	US3	1	\$1.88
	FRFP-AB	2-1/4"x1" Round Corner Removal Face Plate	US5	1	\$1.88
	FRFP-OB	2-1/4"x1" Round Corner Removal Face Plate	US10B(19)	1	\$1.88

* Face plates are not sold with screws.

DUST BOX FOR STRIKES

	Model #	Description	Finish	QTY	List Price
	FDB-T4	Dust Box for T4SP	White	1	\$1.09
	FDB-T7	Dust Box for T7SP	White	1	\$1.09
	FDB-D9	Dust Box for D9SP/D5SP	White	1	\$1.09
	FDB-D1	Dust Box for D1SP	White	1	\$1.09

* Dust boxes are not sold with screws.

LOCKSET STRIKES

Model # Description Finish QTY List Price

Thickness: 0.049" (18 gauge)

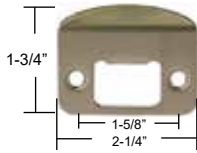

FT4SP-PB Full Lip, Round Corner Strike, 2-1/4"x1-3/4" US3 1 \$1.88

FT4SP-AB Full Lip, Round Corner Strike, 2-1/4"x1-3/4" US5 1 \$1.88

FT4SP-SS Full Lip, Round Corner Strike, 2-1/4"x1-3/4" US32D 1 \$1.88

FT4SP-OB Full Lip, Round Corner Strike, 2-1/4"x1-3/4" US10B(19) 1 \$1.88

FT4SP-VB Full Lip, Round Corner Strike, 2-1/4"x1-3/4" US11P 1 \$1.88

Thickness: 0.078" (14 gauge)

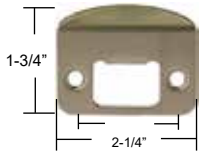

FT4SPG-PB Grade 2, Full Lip, Round Corner Strike, 2-1/4"x1-3/4" US3 1 \$2.82

FT4SPG-AB Grade 2, Full Lip, Round Corner Strike, 2-1/4"x1-3/4" US5 1 \$2.82

FT4SPG-SS Grade 2, Full Lip, Round Corner Strike, 2-1/4"x1-3/4" US32D 1 \$2.82

FT4SPG-OB Grade 2, Full Lip, Round Corner Strike, 2-1/4"x1-3/4" US10B(19) 1 \$2.82

Thickness: 0.049" (18 gauge)

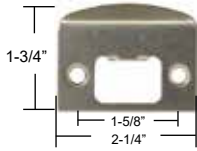

FT5SP-PB Full Lip, Square Corner Strike, 2-1/4"x1-3/4" US3 1 \$1.88

FT5SP-AB Full Lip, Square Corner Strike, 2-1/4"x1-3/4" US5 1 \$1.88

FT5SP-SS Full Lip, Square Corner Strike, 2-1/4"x1-3/4" US32D 1 \$1.88

Thickness: 0.049" (18 gauge)

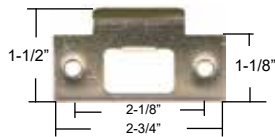

FT7SP-PB 3/8" Lip, T-Strike, 2-3/4"x1-1/8" US3 1 \$1.88

FT7SP-AB 3/8" Lip, T-Strike, 2-3/4"x1-1/8" US5 1 \$1.88

FT7SP-SS 3/8" Lip, T-Strike, 2-3/4"x1-1/8" US32D 1 \$1.88

FT7SP-OB 3/8" Lip, T-Strike, 2-3/4"x1-1/8" US10B(19) 1 \$1.88

Thickness: 0.078" (14 gauge)

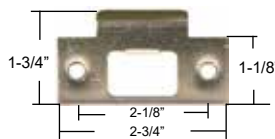

FT7SPG-PB Grade 2, 5/8" Lip, T-Strike, 2-3/4"x1-1/8" US3 1 \$2.82

FT7SPG-AB Grade 2, 5/8" Lip, T-Strike, 2-3/4"x1-1/8" US5 1 \$2.82

FT7SPG-SS Grade 2, 5/8" Lip, T-Strike, 2-3/4"x1-1/8" US32D 1 \$2.82

FT7SPG-OB Grade 2, 5/8" Lip, T-Strike, 2-3/4"x1-1/8" US10B(19) 1 \$2.82

Thickness: 0.078" (14 gauge)

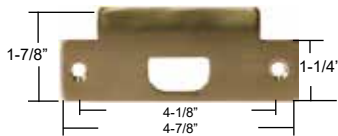

FASA-PB ASA Strike, 4-7/8"x1-1/4" with 3/4" screws US3 1 \$11.31

FASA-AB ASA Strike, 4-7/8"x1-1/4" with 3/4" screws US5 1 \$11.31

FASA-SS ASA Strike, 4-7/8"x1-1/4" with 3/4" screws US32D 1 \$11.31

FASA-OB ASA Strike, 4-7/8"x1-1/4" with 3/4" screws US10B(19) 1 \$11.31

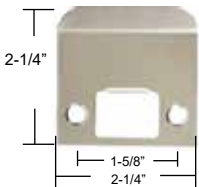

FT5SPE-SS 2-1/4" Extended Lip, Square Corner Strike, 2-1/4"x2-1/4" US32D 1 \$8.47

FT5SPE-OB 2-1/4" Extended Lip, Square Corner Strike, 2-1/4"x2-1/4" US10B 1 \$8.47

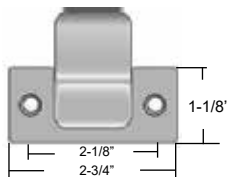

FT7SPA-SS 2-3/4"x1-1/8" Adjustable T-Strike US32D 1 \$8.47

FT7SPA-OB 2-3/4"x1-1/8" Adjustable T-Strike US10B(19) 1 \$8.47

* All strike plates are not sold with screws, except FASA, FTZSP, FD6SP, FDZSP, FDDSP.

PARTS FOR LOCKS

DEADBOLT STRIKES

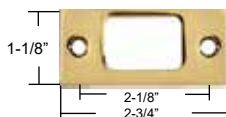
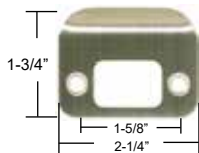
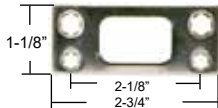
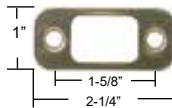
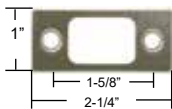
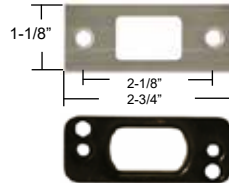
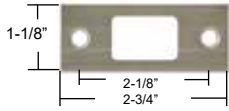

Model #	Description	Finish	QTY	List Price
FD1SP-PB	Large, Square Corner Strike, 2-3/4"x 1-1/8"	US3	1	\$1.88
FD1SP-AB	Large, Square Corner Strike, 2-3/4"x 1-1/8"	US5	1	\$1.88
FD1SP-SS	Large, Square Corner Strike, 2-3/4"x 1-1/8"	US32D	1	\$1.88
FD1SP-OB	Large, Square Corner Strike, 2-3/4"x 1-1/8"	US10B(19)	1	\$1.88
FD1SPS-PB	Large Square Corner Strike, 2-3/4"x1-1/8" w/Reinforced Plate, 3" Wooden Screws	US3	1	\$5.37
FD1SPS-AB	Large Square Corner Strike, 2-3/4"x1-1/8" w/Reinforced Plate, 3" Wooden Screws	US5	1	\$5.37
FD1SPS-SS	Large Square Corner Strike, 2-3/4"x1-1/8" w/Reinforced Plate, 3" Wooden Screws	US32D	1	\$5.37
FD1SPS-OB	Large Square Corner Strike, 2-3/4"x1-1/8" w/Reinforced Plate, 3" Wooden Screws	US10B(19)	1	\$5.37
FD2SP-PB	Square Corner Strike, 2-1/4"x1"	US3	1	\$1.88
FD2SP-AB	Square Corner Strike, 2-1/4"x1"	US5	1	\$1.88
FD2SP-SS	Square Corner Strike, 2-1/4"x1"	US32D	1	\$1.88
FD2SP-OB	Square Corner Strike, 2-1/4"x1"	US10B(19)	1	\$1.88
FD5SP-PB	Round Corner Strike, 2-1/4"x1"	US3	1	\$1.88
FD5SP-AB	Round Corner Strike, 2-1/4"x1"	US5	1	\$1.88
FD5SP-SS	Round Corner Strike, 2-1/4"x1"	US32D	1	\$1.88
FD5SP-OB	Round Corner Strike, 2-1/4"x1"	US10B(19)	1	\$1.88
FD6SP-PB	Security Square Corner Strike, 2-3/4"x 1-1/8" w/ two 3" screws	US3	1	\$5.37
FD6SP-AB	Security Square Corner Strike, 2-3/4"x 1-1/8" w/ two 3" screws	US5	1	\$5.37
FD6SP-SS	Security Square Corner Strike, 2-3/4"x 1-1/8" w/ two 3" screws	US32D	1	\$5.37
FD9SP-PB	Full Lip, Round Corner Strike, 2-1/4"x 1-3/4"	US3	1	\$1.88
FD9SP-AB	Full Lip, Round Corner Strike, 2-1/4"x 1-3/4"	US5	1	\$1.88
FD9SP-SS	Full Lip, Round Corner Strike, 2-1/4"x 1-3/4"	US32D	1	\$1.88
FD9SP-OB	Full Lip, Round Corner Strike, 2-1/4"x 1-3/4"	US10B(19)	1	\$1.88
FD9SP-VB	Full Lip, Round Corner Strike, 2-1/4"x 1-3/4"	US11P	1	\$1.88
FDDSP-PB	Security Round Corner Strike, 3-5/8"x 1-1/4" w/ two 3" screws	US3	1	\$5.37
FDDSP-SS	Security Round Corner Strike, 3-5/8"x 1-1/4" w/ two 3" screws	US32D	1	\$5.37
FDDSP-OB	Security Round Corner Strike, 3-5/8"x 1-1/4" w/ two 3" screws	US10B(19)	1	\$5.37
FD1SPA-SS	Offset Square Corner Strike, 2-3/4"x 1-1/8"	US32D	1	\$3.56
FD1SPA-OB	Offset Square Corner Strike, 2-3/4"x 1-1/8"	US10B(19)	1	\$3.56

* All strike plates are not sold with screws, except FASA, FTZSP, FD6SP, FDZSP, FDDSP.

PARTS FOR LOCKS

CONTEMPORARY SERIES UPCHARGES

Description	Price
(Apply To Standard Discount Only)	
Handlesets substitute with Mira, Tahoe, Onyx, Kona inside trim only	\$11.00
Handlesets substitute with FDK/FDS turn piece only	\$5.60
Handlesets substitute with Mira, Tahoe, Onyx, Kona inside trim and FDK/FDS turn piece	\$16.60
Contemporary interconnected lock series substitute with Vigo (FLR) trim	\$4.80

LATCH/STRIKE PLATE UPCHARGES

Description	Price
(Apply To Standard Discount Only)	
Changes to 6 way latch	\$2.40
Changes to adjustable UL latch	\$8.40
Changes to FDDSP, FD6SP, FD1SPS Strike Plate	\$2.40
T4SP,T7SP, D1SP, D9SP changes to ASA strike plate	\$6.40
T4SP changes to T7SPA	\$3.60
Deadbolt changes to gate latch	\$9.00
Split finish or style on any locks	\$4.00

VISUAL PACK UPCHARGES

Description	Price
(Apply To Standard Discount Only)	
	
Deadbolt, knobset, leverest	\$3.00
Combo set	\$6.00

REKEYING CHARGES

Description	Price
For KW and SC keyway (Apply To Standard Discount Only)	
KD Keyed Differently	\$3.00
KA Keyed Alike	\$3.00
MK Master Keyed	\$4.40
CK Construction Keyed	\$5.20
MCK Master + Construction Keyed	\$5.20
KTP Key-To-Pass Keyed	\$5.20
GMK Grand Master Keyed	\$11.00
GMCK Grand Master/Construction Keyed (Per Cylinder)	\$11.00

For Best SFIC (Apply To Standard Discount Only)

FIC-GMK Grand Master Keyed	\$28.00
----------------------------	---------

NOTE: Rekeying charges will be applied per cylinder for double cylinder deadbolts and double locking interconnected locks.

PARTS FOR LOCKS

E9000 SERIES -- Grade 1, Non Fire Rated

	Model #	Function	Finish	QTY /Case	Lbs /Case	List Price
RIM TYPE 	E9000/EO3-SS	Exit Only For Door 32" to 36" Wide	US32D	3	40	\$805.39
	E9000/EO3-AL	Exit Only For Door 32" to 36" Wide	US26D	3	40	\$739.35
	E9000/EO3-DB	Exit Only For Door 32" to 36" Wide	US10B	3	40	\$739.35
	E9000/EO3-BL	Exit Only For Door 32" to 36" Wide	US19	3	40	\$739.35
	E9000/EO4-SS	Exit only for door 44" to 48" wide	US32D	3	46	\$868.75
	E9000/EO4-AL	Exit only for door 44" to 48" wide	US26D	3	46	\$797.46
	E9000/EO4-DB	Exit only for door 44" to 48" wide	US10B	3	46	\$797.46
	E9000/EO4-BL	Exit only for door 44" to 48" wide	US19	3	46	\$797.46



VERTICAL ROD

	Model #	Function	Finish	QTY /Case	Lbs /Case	List Price
	E9000V/EO3X7-SS	Surface Vertical Rod 36" x 84"(WxH)	US32D	2	38	\$1,103.77
	E9000V/EO3X7-AL	Surface Vertical Rod 36" x 84"(WxH)	US26D	2	38	\$1,064.15
	E9000V/EO3X7-DB	Surface Vertical Rod 36" x 84"(WxH)	US10B	2	38	\$1,064.15
	E9000V/EO3X7-BL	Surface Vertical Rod 36" x 84"(WxH)	US19	2	38	\$1,064.15
	E9000V/EO3X8-SS	Surface Vertical Rod 36" x 96"(WxH)	US32D	2	39	\$1,161.86
	E9000V/EO3X8-AL	Surface Vertical Rod 36" x 96"(WxH)	US26D	2	39	\$1,116.98
	E9000V/EO3X8-DB	Surface Vertical Rod 36" x 96"(WxH)	US10B	2	39	\$1,116.98
	E9000V/EO3X8-BL	Surface Vertical Rod 36" x 96"(WxH)	US19	2	39	\$1,116.98
	E9000V/EO4X7-SS	Surface Vertical Rod 48" x 84"(WxH)	US32D	2	43	\$1,180.34
	E9000V/EO4X7-AL	Surface Vertical Rod 48" x 84"(WxH)	US26D	2	43	\$1,135.45
	E9000V/EO4X7-DB	Surface Vertical Rod 48" x 84"(WxH)	US10B	2	43	\$1,135.45
	E9000V/EO4X7-BL	Surface Vertical Rod 48" x 84"(WxH)	US19	2	43	\$1,135.45
	E9000V/EO4X8-SS	Surface Vertical Rod 48" x 96"(WxH)	US32D	2	44	\$1,190.89
	E9000V/EO4X8-AL	Surface Vertical Rod 48" x 96"(WxH)	US26D	2	44	\$1,146.01
	E9000V/EO4X8-DB	Surface Vertical Rod 48" x 96"(WxH)	US10B	2	44	\$1,146.01
	E9000V/EO4X8-BL	Surface Vertical Rod 48" x 96"(WxH)	US19	2	44	\$1,146.01
	E9000V/EO4X10-SS	Surface Vertical Rod 48" x 120"(WxH)	US32D	2	45	\$1,285.96
	E9000V/EO4X10-AL	Surface Vertical Rod 48" x 120"(WxH)	US26D	2	45	\$1,238.45
E9000V/EO4X10-DB	Surface Vertical Rod 48" x 120"(WxH)	US10B	2	45	\$1,238.45	
E9000V/EO4X10-BL	Surface Vertical Rod 48" x 120"(WxH)	US19	2	45	\$1,238.45	



	E9000/D24-SS	24" Dummy Set	US32D	3	30	\$723.52
	E9000/D24-AL	24" Dummy Set	US26D	3	30	\$657.50
	E9000/D24-DB	24" Dummy Set	US10B	3	30	\$657.50
	E9000/D24-BL	24" Dummy Set	US19	3	30	\$657.50
	E9000/D36-SS	36" Dummy Set	US32D	3	36	\$723.52
	E9000/D36-AL	36" Dummy Set	US26D	3	36	\$657.50
	E9000/D36-DB	36" Dummy Set	US10B	3	36	\$657.50
	E9000/D36-BL	36" Dummy Set	US19	3	36	\$657.50

OPTIONAL DELAYED EGRESS ADD-ON FOR E9000 SERIES

E9000/DE	Delayed Egress	10	20	\$1,876.40
E9000/ADE	All-in-one Delayed Egress	10	20	\$3,687.59

EF9000 SERIES -- Grade 1, 3 Hours UL Fire Rated

RIM TYPE	Model #	Function	Finish	QTY /Case	Lbs /Case	List Price
	EF9000/EO3-SS	Exit Only For Door 32" to 36" Wide	US32D	3	40	\$921.57
	EF9000/EO3-AL	Exit Only For Door 32" to 36" Wide	US26D	3	40	\$887.25
	EF9000/EO3-DB	Exit Only For Door 32" to 36" Wide	US10B	3	40	\$887.25
	EF9000/EO3-BL	Exit Only For Door 32" to 36" Wide	US19	3	40	\$887.25
	EF9000/EO4-SS	Exit Only For Door 44" to 48" Wide	US32D	3	46	\$1,043.03
	EF9000/EO4-AL	Exit Only For Door 44" to 48" Wide	US26D	3	46	\$955.90
	EF9000/EO4-DB	Exit Only For Door 44" to 48" Wide	US10B	3	46	\$955.90
	EF9000/EO4-BL	Exit Only For Door 44" to 48" Wide	US19	3	46	\$955.90



VERTICAL ROD

VERTICAL ROD	Model #	Function	Finish	QTY /Case	Lbs /Case	List Price
	EF9000V/EO3X7-SS	Surface Vertical Rod 36" x 84"(WxH)	US32D	2	38	\$1,267.49
	EF9000V/EO3X7-AL	Surface Vertical Rod 36" x 84"(WxH)	US26D	2	38	\$1,222.59
	EF9000V/EO3X7-DB	Surface Vertical Rod 36" x 84"(WxH)	US10B	2	38	\$1,222.59
	EF9000V/EO3X7-BL	Surface Vertical Rod 36" x 84"(WxH)	US19	2	38	\$1,222.59
	EF9000V/EO3X8-SS	Surface Vertical Rod 36" x 96"(WxH)	US32D	2	39	\$1,336.14
	EF9000V/EO3X8-AL	Surface Vertical Rod 36" x 96"(WxH)	US26D	2	39	\$1,283.33
	EF9000V/EO3X8-DB	Surface Vertical Rod 36" x 96"(WxH)	US10B	2	39	\$1,283.33
	EF9000V/EO3X8-BL	Surface Vertical Rod 36" x 96"(WxH)	US19	2	39	\$1,283.33
	EF9000V/EO4X7-SS	Surface Vertical Rod 48" x 84"(WxH)	US32D	2	43	\$1,357.26
	EF9000V/EO4X7-AL	Surface Vertical Rod 48" x 84"(WxH)	US26D	2	43	\$1,307.10
	EF9000V/EO4X7-DB	Surface Vertical Rod 48" x 84"(WxH)	US10B	2	43	\$1,307.10
	EF9000V/EO4X7-BL	Surface Vertical Rod 48" x 84"(WxH)	US19	2	43	\$1,307.10
	EF9000V/EO4X8-SS	Surface Vertical Rod 48" x 96"(WxH)	US32D	2	44	\$1,367.83
	EF9000V/EO4X8-AL	Surface Vertical Rod 48" x 96"(WxH)	US26D	2	44	\$1,317.66
	EF9000V/EO4X8-DB	Surface Vertical Rod 48" x 96"(WxH)	US10B	2	44	\$1,317.66
	EF9000V/EO4X8-BL	Surface Vertical Rod 48" x 96"(WxH)	US19	2	44	\$1,317.66
EF9000V/EO4X10-SS	Surface Vertical Rod 48" x 120"(WxH)	US32D	2	45	\$1,476.09	
EF9000V/EO4X10-AL	Surface Vertical Rod 48" x 120"(WxH)	US26D	2	45	\$1,423.28	
EF9000V/EO4X10-DB	Surface Vertical Rod 48" x 120"(WxH)	US10B	2	45	\$1,423.28	
EF9000V/EO4X10-BL	Surface Vertical Rod 48" x 120"(WxH)	US19	2	45	\$1,423.28	



LESS BOTTOM ROD

LESS BOTTOM ROD	Model #	Function	Finish	QTY /Case	Lbs /Case	List Price
	EF9000V/LBR37-SS	LBR Vertical Rod 36" x 84"(WxH)	US32D	2	34	\$1,267.49
	EF9000V/LBR37-AL	LBR Vertical Rod 36" x 84"(WxH)	US26D	2	34	\$1,222.59
	EF9000V/LBR37-DB	LBR Vertical Rod 36" x 84"(WxH)	US10B	2	34	\$1,222.59
	EF9000V/LBR37-BL	LBR Vertical Rod 36" x 84"(WxH)	US19	2	34	\$1,222.59
	EF9000V/LBR38-SS	LBR Vertical Rod 36" x 96"(WxH)	US32D	2	35	\$1,336.14
	EF9000V/LBR38-AL	LBR Vertical Rod 36" x 96"(WxH)	US26D	2	35	\$1,283.33
	EF9000V/LBR38-DB	LBR Vertical Rod 36" x 96"(WxH)	US10B	2	35	\$1,283.33
	EF9000V/LBR38-BL	LBR Vertical Rod 36" x 96"(WxH)	US19	2	35	\$1,283.33
	EF9000V/LBR47-SS	LBR Vertical Rod 48" x 84"(WxH)	US32D	2	37	\$1,357.26
	EF9000V/LBR47-AL	LBR Vertical Rod 48" x 84"(WxH)	US26D	2	37	\$1,307.10
	EF9000V/LBR47-DB	LBR Vertical Rod 48" x 84"(WxH)	US10B	2	37	\$1,307.10
	EF9000V/LBR47-BL	LBR Vertical Rod 48" x 84"(WxH)	US19	2	37	\$1,307.10
	EF9000V/LBR48-SS	LBR Vertical Rod 48" x 96"(WxH)	US32D	2	38	\$1,367.83
	EF9000V/LBR48-AL	LBR Vertical Rod 48" x 96"(WxH)	US26D	2	38	\$1,317.66
	EF9000V/LBR48-DB	LBR Vertical Rod 48" x 96"(WxH)	US10B	2	38	\$1,317.66
	EF9000V/LBR48-BL	LBR Vertical Rod 48" x 96"(WxH)	US19	2	38	\$1,317.66
EF9000V/LBR410-SS	LBR Vertical Rod 48" x 120"(WxH)	US32D	2	39	\$1,476.09	
EF9000V/LBR410-AL	LBR Vertical Rod 48" x 120"(WxH)	US26D	2	39	\$1,423.28	
EF9000V/LBR410-DB	LBR Vertical Rod 48" x 120"(WxH)	US10B	2	39	\$1,423.28	
EF9000V/LBR410-BL	LBR Vertical Rod 48" x 120"(WxH)	US19	2	39	\$1,423.28	



E9020 SERIES -- Grade 1, Non Fire Rated

	Model #	Function	Finish	QTY /Case	Lbs /Case	List Price
 <p>BHMA CERTIFIED</p>	E9020V/EO3X7-SS	Concealed Vertical Rod 36" x 84"(WxH)	US32D	2	36	\$1,103.77
	E9020V/EO3X7-AL	Concealed Vertical Rod 36" x 84"(WxH)	US26D	2	36	\$1,064.15
	E9020V/EO3X7-DB	Concealed Vertical Rod 36" x 84"(WxH)	US10B	2	36	\$1,064.15
	E9020V/EO3X7-BL	Concealed Vertical Rod 36" x 84"(WxH)	US19	2	36	\$1,064.15
	E9020V/EO3X8-SS	Concealed Vertical Rod 36" x 96"(WxH)	US32D	2	37	\$1,161.86
	E9020V/EO3X8-AL	Concealed Vertical Rod 36" x 96"(WxH)	US26D	2	37	\$1,116.98
	E9020V/EO3X8-DB	Concealed Vertical Rod 36" x 96"(WxH)	US10B	2	37	\$1,116.98
	E9020V/EO3X8-BL	Concealed Vertical Rod 36" x 96"(WxH)	US19	2	37	\$1,116.98
	E9020V/EO4X7-SS	Concealed Vertical Rod 48" x 84"(WxH)	US32D	2	42	\$1,180.34
	E9020V/EO4X7-AL	Concealed Vertical Rod 48" x 84"(WxH)	US26D	2	42	\$1,135.45
	E9020V/EO4X7-DB	Concealed Vertical Rod 48" x 84"(WxH)	US10B	2	42	\$1,135.45
	E9020V/EO4X7-BL	Concealed Vertical Rod 48" x 84"(WxH)	US19	2	42	\$1,135.45
	E9020V/EO4X8-SS	Concealed Vertical Rod 48" x 96"(WxH)	US32D	2	43	\$1,190.89
	E9020V/EO4X8-AL	Concealed Vertical Rod 48" x 96"(WxH)	US26D	2	43	\$1,146.01
	E9020V/EO4X8-DB	Concealed Vertical Rod 48" x 96"(WxH)	US10B	2	43	\$1,146.01
	E9020V/EO4X8-BL	Concealed Vertical Rod 48" x 96"(WxH)	US19	2	43	\$1,146.01

(ETA for new items: 09/22)

EF9020 SERIES -- Grade 1, 3 Hours UL Fire Rated







	Model #	Function	Finish	QTY /Case	Lbs /Case	List Price
 <p>UL LISTED BHMA CERTIFIED</p>	EF9020V/EO3X7-SS	Concealed Vertical Rod 36" x 84"(WxH)	US32D	2	36	\$1,267.49
	EF9020V/EO3X7-AL	Concealed Vertical Rod 36" x 84"(WxH)	US26D	2	36	\$1,122.59
	EF9020V/EO3X7-DB	Concealed Vertical Rod 36" x 84"(WxH)	US10B	2	36	\$1,122.59
	EF9020V/EO3X7-BL	Concealed Vertical Rod 36" x 84"(WxH)	US19	2	36	\$1,122.59
	EF9020V/EO3X8-SS	Concealed Vertical Rod 36" x 96"(WxH)	US32D	2	37	\$1,336.14
	EF9020V/EO3X8-AL	Concealed Vertical Rod 36" x 96"(WxH)	US26D	2	37	\$1,283.33
	EF9020V/EO3X8-DB	Concealed Vertical Rod 36" x 96"(WxH)	US10B	2	37	\$1,283.33
	EF9020V/EO3X8-BL	Concealed Vertical Rod 36" x 96"(WxH)	US19	2	37	\$1,283.33
	EF9020V/EO4X7-SS	Concealed Vertical Rod 48" x 84"(WxH)	US32D	2	42	\$1,357.26
	EF9020V/EO4X7-AL	Concealed Vertical Rod 48" x 84"(WxH)	US26D	2	42	\$1,307.10
	EF9020V/EO4X7-DB	Concealed Vertical Rod 48" x 84"(WxH)	US10B	2	42	\$1,307.10
	EF9020V/EO4X7-BL	Concealed Vertical Rod 48" x 84"(WxH)	US19	2	42	\$1,307.10
	EF9020V/EO4X8-SS	Concealed Vertical Rod 48" x 96"(WxH)	US32D	2	43	\$1,367.83
	EF9020V/EO4X8-AL	Concealed Vertical Rod 48" x 96"(WxH)	US26D	2	43	\$1,317.66
	EF9020V/EO4X8-DB	Concealed Vertical Rod 48" x 96"(WxH)	US10B	2	43	\$1,317.66
	EF9020V/EO4X8-BL	Concealed Vertical Rod 48" x 96"(WxH)	US19	2	43	\$1,317.66



(ETA for new items: 09/22)





CONCEALED LESS BOTTOM ROD



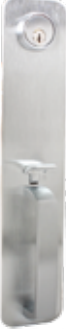

	Model #	Function	Finish	QTY /Case	Lbs /Case	List Price
 <p>UL LISTED BHMA CERTIFIED</p>	EF9020V/LBR37-SS	Concealed Vertical LBR 36" x 84"(WxH)	US32D	2	31	\$1,267.49
	EF9020V/LBR37-AL	Concealed Vertical LBR 36" x 84"(WxH)	US26D	2	31	\$1,122.59
	EF9020V/LBR37-DB	Concealed Vertical LBR 36" x 84"(WxH)	US10B	2	31	\$1,122.59
	EF9020V/LBR37-BL	Concealed Vertical LBR 36" x 84"(WxH)	US19	2	31	\$1,122.59
	EF9020V/LBR38-SS	Concealed Vertical LBR 36" x 96"(WxH)	US32D	2	32	\$1,336.14
	EF9020V/LBR38-AL	Concealed Vertical LBR 36" x 96"(WxH)	US26D	2	32	\$1,283.33
	EF9020V/LBR38-DB	Concealed Vertical LBR 36" x 96"(WxH)	US10B	2	32	\$1,283.33
	EF9020V/LBR38-BL	Concealed Vertical LBR 36" x 96"(WxH)	US19	2	32	\$1,283.33
	EF9020V/LBR47-SS	Concealed Vertical LBR 48" x 84"(WxH)	US32D	2	37	\$1,357.26
	EF9020V/LBR47-AL	Concealed Vertical LBR 48" x 84"(WxH)	US26D	2	37	\$1,307.10
	EF9020V/LBR47-DB	Concealed Vertical LBR 48" x 84"(WxH)	US10B	2	37	\$1,307.10
	EF9020V/LBR47-BL	Concealed Vertical LBR 48" x 84"(WxH)	US19	2	37	\$1,307.10
	EF9020V/LBR48-SS	Concealed Vertical LBR 48" x 96"(WxH)	US32D	2	38	\$1,367.83
	EF9020V/LBR48-AL	Concealed Vertical LBR 48" x 96"(WxH)	US26D	2	38	\$1,317.66
	EF9020V/LBR48-DB	Concealed Vertical LBR 48" x 96"(WxH)	US10B	2	38	\$1,317.66
	EF9020V/LBR48-BL	Concealed Vertical LBR 48" x 96"(WxH)	US19	2	38	\$1,317.66

(ETA for new items: 09/22)

		Model #	Function	Finish	QTY /Case	Lbs /Case	List Price
<p>L3 LEVER Reversible</p>  <p>Entry (Mortise Cylinder)</p>  <p>Storeroom (Rim Cylinder)</p>  <p>Passage/Dummy</p>	Fits 1-3/4" ~ 2" door thickness (compatible with E9000/EF9000 series)						
	E9000/L3-AL	Heavy Duty L3 Lever Entry Lock	US26D	6	28	\$389.49	
	E9000/L3-DB	Heavy Duty L3 Lever Entry Lock	US10B	6	28	\$389.49	
	E9000/L3-BL	Heavy Duty L3 Lever Entry Lock	US19	6	28	\$389.49	
	E9000/L3D-AL	I/C Core HD L3 Lever Entry Lock (w/o IC core)	US26D	6	28	\$389.49	
	E9000/L3D-DB	I/C Core HD L3 Lever Entry Lock (w/o IC core)	US10B	6	28	\$389.49	
	E9000/L3D-BL	I/C Core HD L3 Lever Entry Lock (w/o IC core)	US19	6	28	\$389.49	
	E9000/L3S-AL	Heavy Duty L3 Lever Storeroom Lock	US26D	6	28	\$389.49	
	E9000/L3S-DB	Heavy Duty L3 Lever Storeroom Lock	US10B	6	28	\$389.49	
	E9000/L3S-BL	Heavy Duty L3 Lever Storeroom Lock	US19	6	28	\$389.49	
	E9000/L3SD-AL	I/C Core HD L3 Lever Storeroom Lock (w/o IC core)	US26D	6	28	\$389.49	
	E9000/L3SD-DB	I/C Core HD L3 Lever Storeroom Lock (w/o IC core)	US10B	6	28	\$389.49	
	E9000/L3SD-BL	I/C Core HD L3 Lever Storeroom Lock (w/o IC core)	US19	6	28	\$389.49	
	E9000/L3PA-AL	Heavy Duty L3 Lever Passage	US26D	6	24	\$327.43	
	E9000/L3PA-DB	Heavy Duty L3 Lever Passage	US10B	6	24	\$327.43	
	E9000/L3PA-BL	Heavy Duty L3 Lever Passage	US19	6	24	\$327.43	
	E9000/D3-AL	Heavy Duty L3 Lever Dummy Set	US26D	6	24	\$327.43	
	E9000/D3-DB	Heavy Duty L3 Lever Dummy Set	US10B	6	24	\$327.43	
	E9000/D3-BL	Heavy Duty L3 Lever Dummy Set	US19	6	24	\$327.43	
	<p>LN LEVER Reversible</p>  <p>Entry (Mortise Cylinder)</p>  <p>Storeroom (Rim Cylinder)</p>  <p>Passage/Dummy</p>	E9000/LN-AL	Heavy Duty LN Lever Entry Lock	US26D	6	28	\$389.49
E9000/LN-DB		Heavy Duty LN Lever Entry Lock	US10B	6	28	\$389.49	
E9000/LND-AL		I/C Core HD LN Lever Entry Lock (w/o IC core)	US26D	6	28	\$389.49	
E9000/LND-DB		I/C Core HD LN Lever Entry Lock (w/o IC core)	US10B	6	28	\$389.49	
E9000/LNS-AL		Heavy Duty LN Lever Storeroom Lock	US26D	6	28	\$389.49	
E9000/LNS-DB		Heavy Duty LN Lever Storeroom Lock	US10B	6	28	\$389.49	
E9000/LNSD-AL		I/C Core HD LN Lever Storeroom Lock (w/o IC core)	US26D	6	28	\$389.49	
E9000/LNSD-DB		I/C Core HD LN Lever Storeroom Lock (w/o IC core)	US10B	6	28	\$389.49	
E9000/LNPA-AL		Heavy Duty LN Lever Passage	US26D	6	24	\$327.43	
E9000/LNPA-DB		Heavy Duty LN Lever Passage	US10B	6	24	\$327.43	
E9000/DN-AL		Heavy Duty LN Lever Dummy Set	US26D	6	24	\$327.43	
E9000/DN-DB		Heavy Duty LN Lever Dummy Set	US10B	6	24	\$327.43	

		Model #	Function	Finish	QTY /Case	Lbs /Case	List Price
LH LEVER Reversible (ETA for new items: 09/22)	 Entry (Mortise Cylinder)	E9000/LH-AL	Heavy Duty LH Lever Entry Lock	US26D	6	28	\$389.49
		E9000/LH-DB	Heavy Duty LH Lever Entry Lock	US10B	6	28	\$389.49
		E9000/LH-BL	Heavy Duty LH Lever Entry Lock	US19	6	28	\$389.49
 Storeroom (Rim Cylinder)	 Passage/Dummy	E9000/LHD-AL I/C Core HD LH Lever Entry Lock (w/o IC core)	US26D	6	28	\$389.49	
		E9000/LHD-DB I/C Core HD LH Lever Entry Lock (w/o IC core)	US10B	6	28	\$389.49	
		E9000/LHD-BL I/C Core HD LH Lever Entry Lock (w/o IC core)	US19	6	28	\$389.49	
		E9000/LHS-AL Heavy Duty LH Lever Storeroom Lock	US26D	6	28	\$389.49	
		E9000/LHS-DB Heavy Duty LH Lever Storeroom Lock	US10B	6	28	\$389.49	
		E9000/LHS-BL Heavy Duty LH Lever Storeroom Lock	US19	6	28	\$389.49	
		E9000/LHSD-AL I/C Core HD LH Lever Storeroom Lock (w/o IC core)	US26D	6	28	\$389.49	
		E9000/LHSD-DB I/C Core HD LH Lever Storeroom Lock (w/o IC core)	US10B	6	28	\$389.49	
		E9000/LHSD-BL I/C Core HD LH Lever Storeroom Lock (w/o IC core)	US19	6	28	\$389.49	
		E9000/LHPA-AL	Heavy Duty LH Lever Passage	US26D	6	24	\$327.43
		E9000/LHPA-DB	Heavy Duty LH Lever Passage	US10B	6	24	\$327.43
		E9000/LHPA-BL	Heavy Duty LH Lever Passage	US19	6	24	\$327.43
		E9000/DH-AL	Heavy Duty LH Lever Dummy Trim	US26D	6	24	\$327.43
		E9000/DH-DB	Heavy Duty LH Lever Dummy Trim	US10B	6	24	\$327.43
		E9000/DH-BL	Heavy Duty LH Lever Dummy Trim	US19	6	24	\$327.43

Model #	Function	Finish	QTY /Case	Lbs /Case	List Price
 <p>Fits 1-3/4" ~ 2" door thickness (compatible with E9000/EF9000 series)</p> <p>Mortise Cylinder (ETA for new items: 09/22)</p>					
E9200/L-AL	Pull Plate with Thumb Piece Entry	US26D	6	23	\$295.74
E9200/L-DB	Pull Plate with Thumb Piece Entry	US10B	6	23	\$295.74
E9200/L-BL	Pull Plate with Thumb Piece Entry	US19	6	23	\$295.74
⚙ E9200/LD-AL	I/C Core Pull Plate with Thumb Piece Entry	US26D	6	23	\$295.74
⚙ E9200/LD-DB	I/C Core Pull Plate with Thumb Piece Entry	US10B	6	23	\$295.74
⚙ E9200/LD-BL	I/C Core Pull Plate with Thumb Piece Entry	US19	6	23	\$295.74
 <p>Rim Cylinder (ETA for new items: 09/22)</p>					
E9200/LS-AL	Pull Plate Storeroom (Night Latch)	US26D	12	32	\$258.79
E9200/LS-DB	Pull Plate Storeroom (Night Latch)	US10B	12	32	\$258.79
E9200/LS-BL	Pull Plate Storeroom (Night Latch)	US19	12	32	\$258.79
⚙ E9200/LSD-AL	I/C Core Pull Plate Storeroom (w/o IC core)	US26D	12	32	\$258.79
⚙ E9200/LSD-DB	I/C Core Pull Plate Storeroom (w/o IC core)	US10B	12	32	\$258.79
⚙ E9200/LSD-BL	I/C Core Pull Plate Storeroom (w/o IC core)	US19	12	32	\$258.79
 <p>(ETA for new items: 09/22)</p>					
E9200/PA-AL	Pull Plate with Thumb Piece Passage	US26D	6	20	\$258.79
E9200/PA-DB	Pull Plate with Thumb Piece Passage	US10B	6	20	\$258.79
E9200/PA-BL	Pull Plate with Thumb Piece Passage	US19	6	20	\$258.79
 <p>(ETA for new items: 09/22)</p>					
E9200/D-AL	Pull Plate Dummy Trim	US26D	12	25	\$187.49
E9200/D-DB	Pull Plate Dummy Trim	US10B	12	25	\$187.49
E9200/D-BL	Pull Plate Dummy Trim	US19	12	25	\$187.49

	Model #	Function	Finish	QTY	Lbs	List Price	
				/Case	/Case		
 <p>(ETA for new items: 09/22)</p>	(compatible with E9000/EF9000 series)						
	E9000/36AK-SS	Alarm Kit for 36" Rim and Vertical Rod Exit Devices	US32D	6	18	\$477.95	
	E9000/36AK-AL	Alarm Kit for 36" Rim and Vertical Rod Exit Devices	US26D	6	18	\$443.61	
	E9000/36AK-DB	Alarm Kit for 36" Rim and Vertical Rod Exit Devices	US10B	6	18	\$443.61	
	E9000/36AK-BL	Alarm Kit for 36" Rim and Vertical Rod Exit Devices	US19	6	18	\$443.61	
	E9000/48AK-SS	Alarm Kit for 48" Rim and Vertical Rod Exit Devices	US32D	6	20	\$525.49	
	E9000/48AK-AL	Alarm Kit for 48" Rim and Vertical Rod Exit Devices	US26B	6	20	\$483.23	
	E9000/48AK-DB	Alarm Kit for 48" Rim and Vertical Rod Exit Devices	US10B	6	20	\$483.23	
 <p>(ETA for new items: 09/22)</p>	(compatible with E9000/EF9000 series)						
	E9000/36CD-SS	Dogging Kit for 36" Exit Devices	US32D	6	18	\$137.30	
	E9000/36CD-AL	Dogging Kit for 36" Exit Devices	US26D	6	18	\$126.74	
	E9000/36CD-DB	Dogging Kit for 36" Exit Devices	US10B	6	18	\$126.74	
	E9000/36CD-BL	Dogging Kit for 36" Exit Devices	US19	6	18	\$126.74	
	E9000/48CD-SS	Dogging Kit for 48" Exit Devices	US32D	6	20	\$150.51	
	E9000/48CD-AL	Dogging Kit for 48" Exit Devices	US26D	6	20	\$137.30	
	E9000/48CD-DB	Dogging Kit for 48" Exit Devices	US10B	6	20	\$137.30	
	E9000/48CD-BL	Dogging Kit for 48" Exit Devices	US19	6	20	\$137.30	
	E9000/36ICCD-SS	I/C Core Dogging Kit for 36" Exit (w/o IC core)	US32D	6	18	\$137.30	
	E9000/36ICCD-AL	I/C Core Dogging Kit for 36" Exit (w/o IC core)	US26D	6	18	\$126.74	
	E9000/36ICCD-DB	I/C Core Dogging Kit for 36" Exit (w/o IC core)	US10B	6	18	\$126.74	
	E9000/36ICCD-BL	I/C Core Dogging Kit for 36" Exit (w/o IC core)	US19	6	18	\$126.74	
	E9000/48ICCD-SS	I/C Core Dogging Kit for 48" Exit (w/o IC core)	US32D	6	20	\$150.51	
	E9000/48ICCD-AL	I/C Core Dogging Kit for 48" Exit (w/o IC core)	US26D	6	20	\$137.30	
E9000/48ICCD-DB	I/C Core Dogging Kit for 48" Exit (w/o IC core)	US10B	6	20	\$137.30		
E9000/48ICCD-BL	I/C Core Dogging Kit for 48" Exit (w/o IC core)	US19	6	20	\$137.30		
	(compatible with E9000/EF9000 series)						
	E9000V/38K-SS	Extension Kit for 8' High Door for E9000 Series	US32D	12	15	\$65.67	
	E9000V/38K-AL	Extension Kit for 8' High Door for E9000 Series	US26D	12	15	\$46.90	
	E9000V/38K-DB	Extension Kit for 8' High Door for E9000 Series	US10B	12	15	\$46.90	
	E9000V/38K-BL	Extension Kit for 8' High Door for E9000 Series	US19	12	15	\$46.90	
	E9000V/310K-SS	Extension Kit for 10' High Door for E9000 Series	US32D	12	15	\$72.23	
	E9000V/310K-AL	Extension Kit for 10' High Door for E9000 Series	US26D	12	15	\$51.41	
	E9000V/310K-DB	Extension Kit for 10' High Door for E9000 Series	US10B	12	15	\$51.41	
	E9000V/310K-BL	Extension Kit for 10' High Door for E9000 Series	US19	12	15	\$51.41	
		(compatible with E9000/EF9000 series)					
		E9000/GBK-SS	Glass Bead for Rim Type	US32D	40	20	\$60.96
		E9000/GBK-AL	Glass Bead for Rim Type	US26D	40	20	\$69.74
E9000/GBK-DB		Glass Bead for Rim Type	US10B	40	20	\$136.22	
E9000/GBK-BL		Glass Bead for Rim Type (ETA: 09/22)	US19	40	20	\$136.22	
	(compatible with E9000/EF9000 series)						
	E9000V/GBK-SS	Glass Bead for Vertical Rod	US32D	40	30	\$100.05	
	E9000V/GBK-AL	Glass Bead for Vertical Rod	US26D	40	30	\$111.58	
	E9000V/GBK-DB	Glass Bead for Vertical Rod	US10B	40	30	\$193.41	
	E9000V/GBK-BL	Glass Bead for Vertical Rod (ETA: 09/22)	US19	40	30	\$193.41	



Model #	Function	Finish	QTY /Case	Lbs /Case	List Price
(For Entry Trim) (ETA for new items: 09/22)					
E9000/MCSC-AL	SC 6-pin Mortise Cylinder	US26D	40	30	\$37.32
E9000/MCSC-DB	SC 6-pin Mortise Cylinder	US10B	40	30	\$37.32
E9000/MCSC-BL	SC 6-pin Mortise Cylinder	US19	40	30	\$37.32
E9000/MCKW-AL	KW 5-pin Mortise Cylinder	US26D	40	30	\$37.32
E9000/MCKW-DB	KW 5-pin Mortise Cylinder	US10B	40	30	\$37.32
E9000/MCKW-BL	KW 5-pin Mortise Cylinder	US19	40	30	\$37.32
E9000/MCD-AL	I/C Core Mortise Cylinder (w/o IC core)	US26D	40	30	\$65.33
E9000/MCD-DB	I/C Core Mortise Cylinder (w/o IC core)	US10B	40	30	\$65.33
E9000/MCD-BL	I/C Core Mortise Cylinder (w/o IC core)	US19	40	30	\$65.33
E9200/MCSC-AL	SC 6-pin Mortise Cylinder	US26D	40	30	\$37.32
E9200/MCSC-DB	SC 6-pin Mortise Cylinder	US10B	40	30	\$37.32
E9200/MCSC-BL	SC 6-pin Mortise Cylinder	US19	40	30	\$37.32
E9200/MCKW-AL	KW 5-pin Mortise Cylinder	US26D	40	30	\$37.32
E9200/MCKW-DB	KW 5-pin Mortise Cylinder	US10B	40	30	\$37.32
E9200/MCKW-BL	KW 5-pin Mortise Cylinder	US19	40	30	\$37.32
E9200/MCD-AL	I/C Core Mortise Cylinder (w/o IC core)	US26D	40	30	\$65.33
E9200/MCD-DB	I/C Core Mortise Cylinder (w/o IC core)	US10B	40	30	\$65.33
E9200/MCD-BL	I/C Core Mortise Cylinder (w/o IC core)	US19	40	30	\$65.33



(For Storeroom Trim)(ETA for new items: 09/22)					
E9000/RCSC-AL	SC 6-pin Rim Cylinder	US26D	40	30	\$37.32
E9000/RCSC-DB	SC 6-pin Rim Cylinder	US10B	40	30	\$37.32
E9000/RCSC-BL	SC 6-pin Rim Cylinder	US19	40	30	\$37.32
E9000/RCKW-AL	KW 5-pin Rim Cylinder	US26D	40	30	\$37.32
E9000/RCKW-DB	KW 5-pin Rim Cylinder	US10B	40	30	\$37.32
E9000/RCKW-BL	KW 5-pin Rim Cylinder	US19	40	30	\$37.32
E9000/RCD-AL	I/C Core Rim Cylinder (w/o IC core)	US26D	40	30	\$65.33
E9000/RCD-DB	I/C Core Rim Cylinder (w/o IC core)	US10B	40	30	\$65.33
E9000/RCD-BL	I/C Core Rim Cylinder (w/o IC core)	US19	40	30	\$65.33
E9200/RCSC-AL	SC 6-pin Rim Cylinder	US26D	40	30	\$37.32
E9200/RCSC-DB	SC 6-pin Rim Cylinder	US10B	40	30	\$37.32
E9200/RCSC-BL	SC 6-pin Rim Cylinder	US19	40	30	\$37.32
E9200/RCKW-AL	KW 5-pin Rim Cylinder	US26D	40	30	\$37.32
E9200/RCKW-DB	KW 5-pin Rim Cylinder	US10B	40	30	\$37.32
E9200/RCKW-BL	KW 5-pin Rim Cylinder	US19	40	30	\$37.32
E9200/RCD-AL	I/C Core Rim Cylinder (w/o IC core)	US26D	40	30	\$65.33
E9200/RCD-DB	I/C Core Rim Cylinder (w/o IC core)	US10B	40	30	\$65.33
E9200/RCD-BL	I/C Core Rim Cylinder (w/o IC core)	US19	40	30	\$65.33



	Model #	Function	Finish	QTY /Case	Lbs /Case	List Price
	E4000/DC52-AL	Door Coordinator for 54"-98" Door Width	US26D	10	28	\$147.53
	E4000/DC60-AL	Door Coordinator for 97"-112" Door Width	US26D	10	30	\$162.61
	E4000/FB18-AL	Filler Bar, 18-5/8" for 72" Pair Door	US26D	10	6	\$21.23
	E4000/FB42-AL	Filler Bar, 42-5/8" for 96" Pair Door	US26D	10	6	\$47.77
	E4000/MB2	Mounting Bracket for Stop Width Over 2-1/4" (price per pair, sold per pair only)		25	48	\$60.00
	E4000/MB3	Mounting Bracket for Stop Width between 7/8"-2-1/4" (price per pair, sold per pair only)		25	48	\$77.42
	E4000/CB-DB	Carry Bar	US10B	50	22	\$34.40
	E4000/GDC7-AL	Gravity Door Coordinator 6-1/2" Projection	US26D	20	44	\$79.79
	E4000/GDC7-DB	Gravity Door Coordinator 6-1/2" Projection	US10B	20	44	\$79.79
	EF9000/AFL	Auxiliary Fire Bolt for Less Bottom Rod		50	16	\$62.73
	(compatible with E9000/EF9000 series)					
	E9000/OLSP-AL	Overlapping Strike Plate	US26D	50	20	\$32.03
	E9000/OLSP-DB	Overlapping Strike Plate	US10B	50	20	\$32.03
	E9000/OLSP-BL	Overlapping Strike Plate (ETA: 09/22)	US19	50	20	\$32.03
	E9000/WSK	Windstorm Reinforcement Kit		20	10	\$30.10

	Model #	Function	Finish	QTY /Case	Lbs /Case	List Price
	(For Rim Device)					
	E8000/SB6-AL	Sex Nuts, Female Part Only (set of 6)	US26D	50	6	\$10.71
	E8000/SB6-DB	Sex Nuts, Female Part Only (set of 6)	US10B	50	6	\$10.71
	E8000/SB6-BL	Sex Nuts, Female Part Only (set of 6)	US19	50	6	\$10.71
	(For Top and Bottom Latch)					
	E8000/SB4-AL	Sex Nuts, Female Part Only (set of 4)	US26D	50	6	\$7.14
	E8000/SB4-DB	Sex Nuts, Female Part Only (set of 4)	US10B	50	6	\$7.14
	E8000/SB4-BL	Sex Nuts, Female Part Only (set of 4)	US19	50	6	\$7.14
	E8000/ASA-AL	Blank ASA Strike (4-7/8"x1-1/4")	US26D	50	10	\$12.13
	E8000/5SP-AL	Latch Hole Filler Plate (2-1/4"x1-1/8")	US26D	50	10	\$4.04
	E9000/TS-AL	Threshold Strike	US26D	20	10	\$12.49

E9000 SERIES -- Electric Latch Retraction, Grade 1, Non Fire Rated

Model #	Function	Finish	QTY /Case	Lbs /Case	List Price
RIM TYPE					
E900E/EO3-SS	Exit only for door 32" to 36" wide	US32D	3	46	\$2,492.21
E900E/EO3-AL	Exit only for door 32" to 36" wide	US26D	3	46	\$2,415.85
E900E/EO3-DB	Exit only for door 32" to 36" wide	US10B	3	46	\$2,415.85
E900E/EO3-BL	Exit only for door 32" to 36" wide	US19	3	46	\$2,415.85
E900E/EO4-SS	Exit only for door 44" to 48" wide	US32D	3	52	\$2,565.82
E900E/EO4-AL	Exit only for door 44" to 48" wide	US26D	3	52	\$2,481.30
E900E/EO4-DB	Exit only for door 44" to 48" wide	US10B	3	52	\$2,481.30
E900E/EO4-BL	Exit only for door 44" to 48" wide	US19	3	52	\$2,481.30



VERTICAL ROD

E900EV/EO3X7-SS	Surface Vertical Rod 36" x 84"(WxH)	US32D	2	40	\$2,833.05
E900EV/EO3X7-AL	Surface Vertical Rod 36" x 84"(WxH)	US26D	2	40	\$2,789.41
E900EV/EO3X7-DB	Surface Vertical Rod 36" x 84"(WxH)	US10B	2	40	\$2,789.41
E900EV/EO3X7-BL	Surface Vertical Rod 36" x 84"(WxH)	US19	2	40	\$2,789.41
E900EV/EO3X8-SS	Surface Vertical Rod 36" x 96"(WxH)	US32D	2	41	\$2,901.20
E900EV/EO3X8-AL	Surface Vertical Rod 36" x 96"(WxH)	US26D	2	41	\$2,849.41
E900EV/EO3X8-DB	Surface Vertical Rod 36" x 96"(WxH)	US10B	2	41	\$2,849.41
E900EV/EO3X8-BL	Surface Vertical Rod 36" x 96"(WxH)	US19	2	41	\$2,849.41
E900EV/EO4X7-SS	Surface Vertical Rod 48" x 84"(WxH)	US32D	2	45	\$2,923.00
E900EV/EO4X7-AL	Surface Vertical Rod 48" x 84"(WxH)	US26D	2	45	\$2,871.21
E900EV/EO4X7-DB	Surface Vertical Rod 48" x 84"(WxH)	US10B	2	45	\$2,871.21
E900EV/EO4X7-BL	Surface Vertical Rod 48" x 84"(WxH)	US19	2	45	\$2,871.21
E900EV/EO4X8-SS	Surface Vertical Rod 48" x 96"(WxH)	US32D	2	46	\$2,933.92
E900EV/EO4X8-AL	Surface Vertical Rod 48" x 96"(WxH)	US26D	2	46	\$2,882.12
E900EV/EO4X8-DB	Surface Vertical Rod 48" x 96"(WxH)	US10B	2	46	\$2,882.12
E900EV/EO4X8-BL	Surface Vertical Rod 48" x 96"(WxH)	US19	2	46	\$2,882.12
E900EV/EO4X10-SS	Surface Vertical Rod 48" x 120"(WxH)	US32D	2	47	\$3,043.00
E900EV/EO4X10-AL	Surface Vertical Rod 48" x 120"(WxH)	US26D	2	47	\$2,988.46
E900EV/EO4X10-DB	Surface Vertical Rod 48" x 120"(WxH)	US10B	2	47	\$2,988.46
E900EV/EO4X10-BL	Surface Vertical Rod 48" x 120"(WxH)	US19	2	47	\$2,988.46

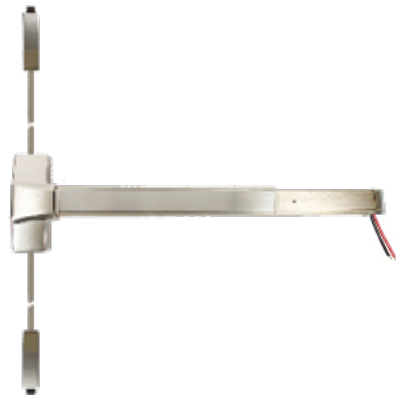

OPTIONAL ADD-ON FOR E9000 SERIES ELECTRIC LATCH RETRACTION

E9000/REX	Request to Exit	10	20	\$224.96
E9000/LBM	Latch Bolt Monitoring	10	20	\$224.96
E9000/REXLBM	Request to Exit+Latch Bolt Monitoring	10	20	\$449.91

*For all electric hardware, please check availability and lead-time with sales department first.

EF9000 SERIES -- Electric Latch Retraction, Grade 1, Fire Rated

RIM TYPE



Model #	Function	Finish/Case	QTY	Lbs /Case	List Price
EF900E/EO3-SS	Exit only for door 32" to 36" wide	US32D	3	46	\$2,625.81
EF900E/EO3-AL	Exit only for door 32" to 36" wide	US26D	3	46	\$2,584.91
EF900E/EO3-DB	Exit only for door 32" to 36" wide	US10B	3	46	\$2,584.91
EF900E/EO3-BL	Exit only for door 32" to 36" wide	US19	3	46	\$2,584.91
EF900E/EO4-SS	Exit only for door 44" to 48" wide	US32D	3	52	\$2,764.87
EF900E/EO4-AL	Exit only for door 44" to 48" wide	US26D	3	52	\$2,663.97
EF900E/EO4-DB	Exit only for door 44" to 48" wide	US10B	3	52	\$2,663.97
EF900E/EO4-BL	Exit only for door 44" to 48" wide	US19	3	52	\$2,663.97

VERTICAL ROD

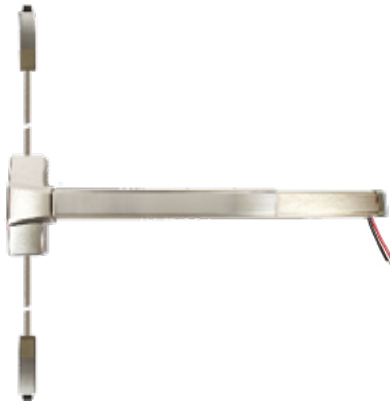

EF900EV/EO3X7-SS	Surface Vertical Rod 36" x 84"(WxH)	US32D	2	40	\$3,021.17
EF900EV/EO3X7-AL	Surface Vertical Rod 36" x 84"(WxH)	US26D	2	40	\$2,969.37
EF900EV/EO3X7-DB	Surface Vertical Rod 36" x 84"(WxH)	US10B	2	40	\$2,969.37
EF900EV/EO3X7-BL	Surface Vertical Rod 36" x 84"(WxH)	US19	2	40	\$2,969.37
EF900EV/EO3X8-SS	Surface Vertical Rod 36" x 96"(WxH)	US32D	2	41	\$3,100.25
EF900EV/EO3X8-AL	Surface Vertical Rod 36" x 96"(WxH)	US26D	2	41	\$3,040.25
EF900EV/EO3X8-DB	Surface Vertical Rod 36" x 96"(WxH)	US10B	2	41	\$3,040.25
EF900EV/EO3X8-BL	Surface Vertical Rod 36" x 96"(WxH)	US19	2	41	\$3,040.25
EF900EV/EO4X7-SS	Surface Vertical Rod 48" x 84"(WxH)	US32D	2	45	\$3,124.79
EF900EV/EO4X7-AL	Surface Vertical Rod 48" x 84"(WxH)	US26D	2	45	\$3,067.54
EF900EV/EO4X7-DB	Surface Vertical Rod 48" x 84"(WxH)	US10B	2	45	\$3,067.54
EF900EV/EO4X7-BL	Surface Vertical Rod 48" x 84"(WxH)	US19	2	45	\$3,067.54
EF900EV/EO4X8-SS	Surface Vertical Rod 48" x 96"(WxH)	US32D	2	46	\$3,135.70
EF900EV/EO4X8-AL	Surface Vertical Rod 48" x 96"(WxH)	US26D	2	46	\$3,078.45
EF900EV/EO4X8-DB	Surface Vertical Rod 48" x 96"(WxH)	US10B	2	46	\$3,078.45
EF900EV/EO4X8-BL	Surface Vertical Rod 48" x 96"(WxH)	US19	2	46	\$3,078.45
EF900EV/EO4X10-SS	Surface Vertical Rod 48" x 120"(WxH)	US32D	2	47	\$3,386.56
EF900EV/EO4X10-AL	Surface Vertical Rod 48" x 120"(WxH)	US26D	2	47	\$3,323.84
EF900EV/EO4X10-DB	Surface Vertical Rod 48" x 120"(WxH)	US10B	2	47	\$3,323.84
EF900EV/EO4X10-BL	Surface Vertical Rod 48" x 120"(WxH)	US19	2	47	\$3,323.84

LESS BOTTOM ROD



EF900EV/LBR37-SS	LBR Vertical Rod 36" x 84"(WxH)	US32D	2	36	\$3,021.17
EF900EV/LBR37-AL	LBR Vertical Rod 36" x 84"(WxH)	US26D	2	36	\$2,969.37
EF900EV/LBR37-DB	LBR Vertical Rod 36" x 84"(WxH)	US10B	2	36	\$2,969.37
EF900EV/LBR37-BL	LBR Vertical Rod 36" x 84"(WxH)	US19	2	36	\$2,969.37
EF900EV/LBR38-SS	LBR Vertical Rod 36" x 96"(WxH)	US32D	2	37	\$3,100.25
EF900EV/LBR38-AL	LBR Vertical Rod 36" x 96"(WxH)	US26D	2	37	\$3,040.25
EF900EV/LBR38-DB	LBR Vertical Rod 36" x 96"(WxH)	US10B	2	37	\$3,040.25
EF900EV/LBR38-BL	LBR Vertical Rod 36" x 96"(WxH)	US19	2	37	\$3,040.25
EF900EV/LBR47-SS	LBR Vertical Rod 48" x 84"(WxH)	US32D	2	39	\$3,124.79
EF900EV/LBR47-AL	LBR Vertical Rod 48" x 84"(WxH)	US26D	2	39	\$3,067.54
EF900EV/LBR47-DB	LBR Vertical Rod 48" x 84"(WxH)	US10B	2	39	\$3,067.54
EF900EV/LBR47-BL	LBR Vertical Rod 48" x 84"(WxH)	US19	2	39	\$3,067.54
EF900EV/LBR48-SS	LBR Vertical Rod 48" x 96"(WxH)	US32D	2	40	\$3,135.70
EF900EV/LBR48-AL	LBR Vertical Rod 48" x 96"(WxH)	US26D	2	40	\$3,078.45
EF900EV/LBR48-DB	LBR Vertical Rod 48" x 96"(WxH)	US10B	2	40	\$3,078.45
EF900EV/LBR48-BL	LBR Vertical Rod 48" x 96"(WxH)	US19	2	40	\$3,078.45
EF900EV/LBR410-SS	LBR Vertical Rod 48" x 120"(WxH)	US32D	2	41	\$3,386.56
EF900EV/LBR410-AL	LBR Vertical Rod 48" x 120"(WxH)	US26D	2	41	\$3,323.84
EF900EV/LBR410-DB	LBR Vertical Rod 48" x 120"(WxH)	US10B	2	41	\$3,323.84
EF900EV/LBR410-BL	LBR Vertical Rod 48" x 120"(WxH)	US19	2	41	\$3,323.84

E9020 SERIES -- Electric Latch Retraction, Grade 1, Non Fire Rated

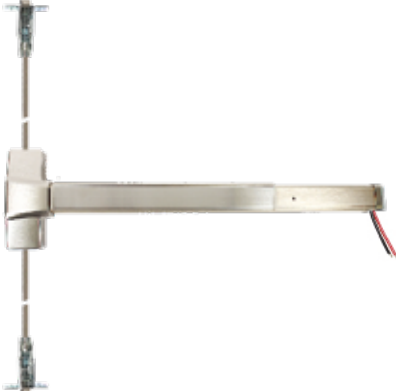
	Model #	Function	Finish/Case	QTY /Case	Lbs /Case	List Price
	E902EV/EO3X7-SS	Concealed Vertical Rod 36" x 84"(WxH)	US32D	2	40	\$2,833.05
	E902EV/EO3X7-AL	Concealed Vertical Rod 36" x 84"(WxH)	US26D	2	40	\$2,789.41
	E902EV/EO3X7-DB	Concealed Vertical Rod 36" x 84"(WxH)	US10B	2	40	\$2,789.41
	E902EV/EO3X8-SS	Concealed Vertical Rod 36" x 96"(WxH)	US32D	2	41	\$2,901.20
	E902EV/EO3X8-AL	Concealed Vertical Rod 36" x 96"(WxH)	US26D	2	41	\$2,849.41
	E902EV/EO3X8-DB	Concealed Vertical Rod 36" x 96"(WxH)	US10B	2	41	\$2,849.41
	E902EV/EO4X7-SS	Concealed Vertical Rod 48" x 84"(WxH)	US32D	2	45	\$2,923.00
	E902EV/EO4X7-AL	Concealed Vertical Rod 48" x 84"(WxH)	US26D	2	45	\$2,871.21
	E902EV/EO4X7-DB	Concealed Vertical Rod 48" x 84"(WxH)	US10B	2	45	\$2,871.21
	E902EV/EO4X8-SS	Concealed Vertical Rod 48" x 96"(WxH)	US32D	2	46	\$2,933.92
	E902EV/EO4X8-AL	Concealed Vertical Rod 48" x 96"(WxH)	US26D	2	46	\$2,882.12
	E902EV/EO4X8-DB	Concealed Vertical Rod 48" x 96"(WxH)	US10B	2	46	\$2,882.12

EF9020 SERIES -- Electric Latch Retraction, Grade 1, Fire Rated

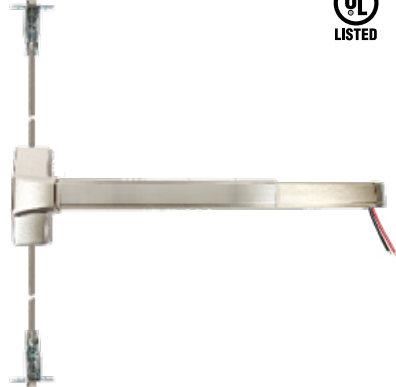
	Model #	Function	Finish/Case	QTY /Case	Lbs /Case	List Price
	EF902EV/EO3X7-SS	Concealed Vertical Rod 36" x 84"(WxH)	US32D	2	40	\$3,021.17
	EF902EV/EO3X7-AL	Concealed Vertical Rod 36" x 84"(WxH)	US26D	2	40	\$2,969.37
	EF902EV/EO3X7-DB	Concealed Vertical Rod 36" x 84"(WxH)	US10B	2	40	\$2,969.37
	EF902EV/EO3X8-SS	Concealed Vertical Rod 36" x 96"(WxH)	US32D	2	41	\$3,100.25
	EF902EV/EO3X8-AL	Concealed Vertical Rod 36" x 96"(WxH)	US26D	2	41	\$3,040.25
	EF902EV/EO3X8-DB	Concealed Vertical Rod 36" x 96"(WxH)	US10B	2	41	\$3,040.25
	EF902EV/EO4X7-SS	Concealed Vertical Rod 48" x 84"(WxH)	US32D	2	45	\$3,124.79
	EF902EV/EO4X7-AL	Concealed Vertical Rod 48" x 84"(WxH)	US26D	2	45	\$3,067.54
	EF902EV/EO4X7-DB	Concealed Vertical Rod 48" x 84"(WxH)	US10B	2	45	\$3,067.54
	EF902EV/EO4X8-SS	Concealed Vertical Rod 48" x 96"(WxH)	US32D	2	46	\$3,135.70
	EF902EV/EO4X8-AL	Concealed Vertical Rod 48" x 96"(WxH)	US26D	2	46	\$3,078.45
	EF902EV/EO4X8-DB	Concealed Vertical Rod 48" x 96"(WxH)	US10B	2	46	\$3,078.45

CONCEALED LESS BOTTOM ROD

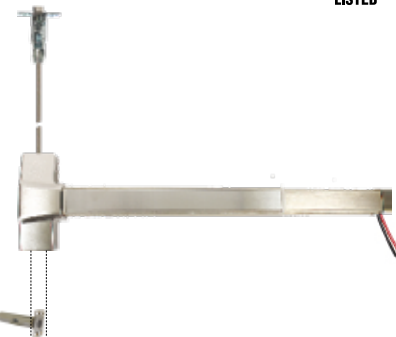
	Model #	Function	Finish/Case	QTY /Case	Lbs /Case	List Price
	EF902EV/LBR37-SS	Concealed LBR Vertical Rod 36" x 84"(WxH)	US32D	2	36	\$3,021.17
	EF902EV/LBR37-AL	Concealed LBR Vertical Rod 36" x 84"(WxH)	US26D	2	36	\$2,969.37
	EF902EV/LBR37-DB	Concealed LBR Vertical Rod 36" x 84"(WxH)	US10B	2	36	\$2,969.37
	EF902EV/LBR38-SS	Concealed LBR Vertical Rod 36" x 96"(WxH)	US32D	2	37	\$3,100.25
	EF902EV/LBR38-AL	Concealed LBR Vertical Rod 36" x 96"(WxH)	US26D	2	37	\$3,040.25
	EF902EV/LBR38-DB	Concealed LBR Vertical Rod 36" x 96"(WxH)	US10B	2	37	\$3,040.25
	EF902EV/LBR47-SS	Concealed LBR Vertical Rod 48" x 84"(WxH)	US32D	2	39	\$3,124.79
	EF902EV/LBR47-AL	Concealed LBR Vertical Rod 48" x 84"(WxH)	US26D	2	39	\$3,067.54
	EF902EV/LBR47-DB	Concealed LBR Vertical Rod 48" x 84"(WxH)	US10B	2	39	\$3,067.54
	EF902EV/LBR48-SS	Concealed LBR Vertical Rod 48" x 96"(WxH)	US32D	2	40	\$3,135.70
	EF902EV/LBR48-AL	Concealed LBR Vertical Rod 48" x 96"(WxH)	US26D	2	40	\$3,078.45
	EF902EV/LBR48-DB	Concealed LBR Vertical Rod 48" x 96"(WxH)	US10B	2	40	\$3,078.45

L3 LEVER



Model #	Function	Finish	QTY /Case	Lbs /Case	List Price
E9000/L3SE-AL	Heavy Duty Fail-Secure Lock	US26D	6	28	\$1,117.94
E9000/L3SE-DB	Heavy Duty Fail-Secure Lock	US10B	6	28	\$1,117.94
E9000/L3SE-BL	Heavy Duty Fail-Secure Lock	US19	6	28	\$1,117.94
E9000/L3SDE-AL	I/C Core HD Fail-Secure Lock (w/o IC core)	US26D	6	28	\$1,117.94
E9000/L3SDE-DB	I/C Core HD Fail-Secure Lock (w/o IC core)	US10B	6	28	\$1,117.94
E9000/L3SDE-BL	I/C Core HD Fail-Secure Lock (w/o IC core)	US19	6	28	\$1,117.94
E9000/L3SA-AL	Heavy Duty Fail-Safe Lock	US26D	6	28	\$1,117.94
E9000/L3SA-DB	Heavy Duty Fail-Safe Lock	US10B	6	28	\$1,117.94
E9000/L3SA-BL	Heavy Duty Fail-Safe Lock	US19	6	28	\$1,117.94
E9000/L3SDA-AL	I/C Core HD Fail-Safe Lock (w/o IC core)	US26D	6	28	\$1,117.94
E9000/L3SDA-DB	I/C Core HD Fail-Safe Lock (w/o IC core)	US10B	6	28	\$1,117.94
E9000/L3SDA-BL	I/C Core HD Fail-Safe Lock (w/o IC core)	US19	6	28	\$1,117.94

LN LEVER



E9000/LNSE-AL	Heavy Duty Fail-Secure Lock	US26D	6	28	\$1,117.94
E9000/LNSE-DB	Heavy Duty Fail-Secure Lock	US10B	6	28	\$1,117.94
E9000/LNSDE-AL	I/C Core HD Fail-Secure Lock (w/o IC core)	US26D	6	28	\$1,117.94
E9000/LNSDE-DB	I/C Core HD Fail-Secure Lock (w/o IC core)	US10B	6	28	\$1,117.94
E9000/LNSA-AL	Heavy Duty Fail-Safe Lock	US26D	6	28	\$1,117.94
E9000/LNSA-DB	Heavy Duty Fail-Safe Lock	US10B	6	28	\$1,117.94
E9000/LNSDA-AL	I/C Core HD Fail-Safe Lock (w/o IC core)	US26D	6	28	\$1,117.94
E9000/LNSDA-DB	I/C Core HD Fail-Safe Lock (w/o IC core)	US10B	6	28	\$1,117.94



LH LEVER





E9000/LHSE-AL	Heavy Duty Fail-Secure Lock	US26D	6	28	\$1,117.94
E9000/LHSE-DB	Heavy Duty Fail-Secure Lock	US10B	6	28	\$1,117.94
E9000/LHSDE-AL	I/C Core HD Fail-Secure Lock (w/o IC core)	US26D	6	28	\$1,117.94
E9000/LHSDE-DB	I/C Core HD Fail-Secure Lock (w/o IC core)	US10B	6	28	\$1,117.94
E9000/LHSA-AL	Heavy Duty Fail-Safe Lock	US26D	6	28	\$1,117.94
E9000/LHSA-DB	Heavy Duty Fail-Safe Lock	US10B	6	28	\$1,117.94
E9000/LHSDA-AL	I/C Core HD Fail-Safe Lock (w/o IC core)	US26D	6	28	\$1,117.94
E9000/LHSDA-DB	I/C Core HD Fail-Safe Lock (w/o IC core)	US10B	6	28	\$1,117.94

*For all electric hardware, please check availability and lead-time with sales department first.

E9100 SERIES -- Grade 1, Non Fire Rated

Model #	Function	Finish	QTY /Case	Lbs /Case	List Price
RIM TYPE					
					
E9100/EO3-SS	Exit Only For Door 32" to 36" Wide	US32D	3	40	\$965.17
E9100/EO3-AL	Exit Only For Door 32" to 36" Wide	US26D	3	40	\$886.52
E9100/EO3-DB	Exit Only For Door 32" to 36" Wide	US10B	3	40	\$886.52
E9100/EO3-BL	Exit Only For Door 32" to 36" Wide	US19	3	40	\$886.52
					
E9100/EO4-SS	Exit Only For Door 44" to 48" Wide	US32D	3	46	\$1,041.43
E9100/EO4-AL	Exit Only For Door 44" to 48" Wide	US26D	3	46	\$958.02
E9100/EO4-DB	Exit Only For Door 44" to 48" Wide	US10B	3	46	\$958.02
E9100/EO4-BL	Exit Only For Door 44" to 48" Wide	US19	3	46	\$958.02



VERTICAL ROD



Model #	Function	Finish	QTY /Case	Lbs /Case	List Price
					
E9100V/EO3X7-SS	Surface Vertical Rod 36" x 84"(WxH)	US32D	2	38	\$1,325.02
E9100V/EO3X7-AL	Surface Vertical Rod 36" x 84"(WxH)	US26D	2	38	\$1,277.36
E9100V/EO3X7-DB	Surface Vertical Rod 36" x 84"(WxH)	US10B	2	38	\$1,277.36
E9100V/EO3X7-BL	Surface Vertical Rod 36" x 84"(WxH)	US19	2	38	\$1,277.36
E9100V/EO3X8-SS	Surface Vertical Rod 36" x 96"(WxH)	US32D	2	39	\$1,394.13
E9100V/EO3X8-AL	Surface Vertical Rod 36" x 96"(WxH)	US26D	2	39	\$1,339.32
E9100V/EO3X8-DB	Surface Vertical Rod 36" x 96"(WxH)	US10B	2	39	\$1,339.32
E9100V/EO3X8-BL	Surface Vertical Rod 36" x 96"(WxH)	US19	2	39	\$1,339.32
E9100V/EO4X7-SS	Surface Vertical Rod 48" x 84"(WxH)	US32D	2	43	\$1,415.58
E9100V/EO4X7-AL	Surface Vertical Rod 48" x 84"(WxH)	US26D	2	43	\$1,363.15
E9100V/EO4X7-DB	Surface Vertical Rod 48" x 84"(WxH)	US10B	2	43	\$1,363.15
E9100V/EO4X7-BL	Surface Vertical Rod 48" x 84"(WxH)	US19	2	43	\$1,363.15
E9100V/EO4X8-SS	Surface Vertical Rod 48" x 96"(WxH)	US32D	2	44	\$1,429.88
E9100V/EO4X8-AL	Surface Vertical Rod 48" x 96"(WxH)	US26D	2	44	\$1,375.06
E9100V/EO4X8-DB	Surface Vertical Rod 48" x 96"(WxH)	US10B	2	44	\$1,375.06
E9100V/EO4X8-BL	Surface Vertical Rod 48" x 96"(WxH)	US19	2	44	\$1,375.06
					

OPTIONAL DELAYED EGRESS ADD-ON FOR E9100 SERIES

E9100/DE	Delayed Egress	10	20	\$1,876.40
E9100/ADE	All-in-one Delayed Egress	10	20	\$3,687.59

EF9100 SERIES -- Grade 1, 3 Hours UL Fire Rated

	Model #	Function	Finish	QTY /Case	Lbs /Case	List Price
RIM TYPE  	EF9100/EO3-SS	Exit Only For Door 32" to 36" Wide	US32D	3	40	\$1,105.78
	EF9100/EO3-AL	Exit Only For Door 32" to 36" Wide	US26D	3	40	\$1,065.26
	EF9100/EO3-DB	Exit Only For Door 32" to 36" Wide	US10B	3	40	\$1,065.26
	EF9100/EO3-BL	Exit Only For Door 32" to 36" Wide	US19	3	40	\$1,065.26
	EF9100/EO4-SS	Exit Only For Door 44" to 48" Wide	US32D	3	46	\$1,251.14
	EF9100/EO4-AL	Exit Only For Door 44" to 48" Wide	US26D	3	46	\$1,146.28
	EF9100/EO4-DB	Exit Only For Door 44" to 48" Wide	US10B	3	46	\$1,146.28
	EF9100/EO4-BL	Exit Only For Door 44" to 48" Wide	US19	3	46	\$1,146.28

	Model #	Function	Finish	QTY /Case	Lbs /Case	List Price
VERTICAL ROD  	EF9100V/EO3X7-SS	Surface Vertical Rod 36" x 84"(WxH)	US32D	2	38	\$1,520.44
	EF9100V/EO3X7-AL	Surface Vertical Rod 36" x 84"(WxH)	US26D	2	38	\$1,465.63
	EF9100V/EO3X7-DB	Surface Vertical Rod 36" x 84"(WxH)	US10B	2	38	\$1,465.63
	EF9100V/EO3X7-BL	Surface Vertical Rod 36" x 84"(WxH)	US19	2	38	\$1,465.63
	EF9100V/EO3X8-SS	Surface Vertical Rod 36" x 96"(WxH)	US32D	2	39	\$1,603.84
	EF9100V/EO3X8-AL	Surface Vertical Rod 36" x 96"(WxH)	US26D	2	39	\$1,539.50
	EF9100V/EO3X8-DB	Surface Vertical Rod 36" x 96"(WxH)	US10B	2	39	\$1,539.50
	EF9100V/EO3X8-BL	Surface Vertical Rod 36" x 96"(WxH)	US19	2	39	\$1,539.50
	EF9100V/EO4X7-SS	Surface Vertical Rod 48" x 84"(WxH)	US32D	2	43	\$1,627.68
	EF9100V/EO4X7-AL	Surface Vertical Rod 48" x 84"(WxH)	US26D	2	43	\$1,568.10
	EF9100V/EO4X7-DB	Surface Vertical Rod 48" x 84"(WxH)	US10B	2	43	\$1,568.10
	EF9100V/EO4X7-BL	Surface Vertical Rod 48" x 84"(WxH)	US19	2	43	\$1,568.10
	EF9100V/EO4X8-SS	Surface Vertical Rod 48" x 96"(WxH)	US32D	2	44	\$1,641.98
	EF9100V/EO4X8-AL	Surface Vertical Rod 48" x 96"(WxH)	US26D	2	44	\$1,580.02
	EF9100V/EO4X8-DB	Surface Vertical Rod 48" x 96"(WxH)	US10B	2	44	\$1,580.02
	EF9100V/EO4X8-BL	Surface Vertical Rod 48" x 96"(WxH)	US19	2	44	\$1,580.02

	Model #	Function	Finish	QTY /Case	Lbs /Case	List Price
LESS BOTTOM ROD  	EF9100V/LBR37-SS	LBR Vertical Rod 36" x 84"(WxH)	US32D	2	34	\$1,520.44
	EF9100V/LBR37-AL	LBR Vertical Rod 36" x 84"(WxH)	US26D	2	34	\$1,465.63
	EF9100V/LBR37-DB	LBR Vertical Rod 36" x 84"(WxH)	US10B	2	34	\$1,465.63
	EF9100V/LBR37-BL	LBR Vertical Rod 36" x 84"(WxH)	US19	2	34	\$1,465.63
	EF9100V/LBR38-SS	LBR Vertical Rod 36" x 96"(WxH)	US32D	2	35	\$1,603.84
	EF9100V/LBR38-AL	LBR Vertical Rod 36" x 96"(WxH)	US26D	2	35	\$1,539.50
	EF9100V/LBR38-DB	LBR Vertical Rod 36" x 96"(WxH)	US10B	2	35	\$1,539.50
	EF9100V/LBR38-BL	LBR Vertical Rod 36" x 96"(WxH)	US19	2	35	\$1,539.50
	EF9100V/LBR47-SS	LBR Vertical Rod 48" x 84"(WxH)	US32D	2	37	\$1,627.68
	EF9100V/LBR47-AL	LBR Vertical Rod 48" x 84"(WxH)	US26D	2	37	\$1,568.10
	EF9100V/LBR47-DB	LBR Vertical Rod 48" x 84"(WxH)	US10B	2	37	\$1,568.10
	EF9100V/LBR47-BL	LBR Vertical Rod 48" x 84"(WxH)	US19	2	37	\$1,568.10
	EF9100V/LBR48-SS	LBR Vertical Rod 48" x 96"(WxH)	US32D	2	38	\$1,641.98
	EF9100V/LBR48-AL	LBR Vertical Rod 48" x 96"(WxH)	US26D	2	38	\$1,580.02
	EF9100V/LBR48-DB	LBR Vertical Rod 48" x 96"(WxH)	US10B	2	38	\$1,580.02
	EF9100V/LBR48-BL	LBR Vertical Rod 48" x 96"(WxH)	US19	2	38	\$1,580.02

E9120 SERIES -- Grade 1, Non Fire Rated







	Model #	Function	Finish	QTY /Case	Lbs /Case	List Price
 <p>BHMA CERTIFIED</p> <p>(ETA for new items: 09/22)</p>	E9120V/EO3X7-SS	Concealed Vertical Rod 36" x 84"(WxH)	US32D	2	36	\$1,325.02
	E9120V/EO3X7-AL	Concealed Vertical Rod 36" x 84"(WxH)	US26D	2	36	\$1,277.36
	E9120V/EO3X7-DB	Concealed Vertical Rod 36" x 84"(WxH)	US10B	2	36	\$1,277.36
	E9120V/EO3X7-BL	Concealed Vertical Rod 36" x 84"(WxH)	US19	2	36	\$1,277.36
	E9120V/EO3X8-SS	Concealed Vertical Rod 36" x 96"(WxH)	US32D	2	37	\$1,394.13
	E9120V/EO3X8-AL	Concealed Vertical Rod 36" x 96"(WxH)	US26D	2	37	\$1,339.32
	E9120V/EO3X8-DB	Concealed Vertical Rod 36" x 96"(WxH)	US10B	2	37	\$1,339.32
	E9120V/EO3X8-BL	Concealed Vertical Rod 36" x 96"(WxH)	US19	2	37	\$1,339.32
	E9120V/EO4X7-SS	Concealed Vertical Rod 48" x 84"(WxH)	US32D	2	42	\$1,415.58
	E9120V/EO4X7-AL	Concealed Vertical Rod 48" x 84"(WxH)	US26D	2	42	\$1,363.15
	E9120V/EO4X7-DB	Concealed Vertical Rod 48" x 84"(WxH)	US10B	2	42	\$1,363.15
	E9120V/EO4X7-BL	Concealed Vertical Rod 48" x 84"(WxH)	US19	2	42	\$1,363.15
	E9120V/EO4X8-SS	Concealed Vertical Rod 48" x 96"(WxH)	US32D	2	43	\$1,429.88
	E9120V/EO4X8-AL	Concealed Vertical Rod 48" x 96"(WxH)	US26D	2	43	\$1,375.06
	E9120V/EO4X8-DB	Concealed Vertical Rod 48" x 96"(WxH)	US10B	2	43	\$1,375.06
	E9120V/EO4X8-BL	Concealed Vertical Rod 48" x 96"(WxH)	US19	2	43	\$1,375.06



EF9120 SERIES -- Grade 1, 3 Hours UL Fire Rated





	Model #	Function	Finish	QTY /Case	Lbs /Case	List Price
 <p>UL LISTED BHMA CERTIFIED</p> <p>(ETA for new items: 09/22)</p>	EF9120V/EO3X7-SS	Concealed Vertical Rod 36" x 84"(WxH)	US32D	2	36	\$1,520.44
	EF9120V/EO3X7-AL	Concealed Vertical Rod 36" x 84"(WxH)	US26D	2	36	\$1,465.63
	EF9120V/EO3X7-DB	Concealed Vertical Rod 36" x 84"(WxH)	US10B	2	36	\$1,465.63
	EF9120V/EO3X7-BL	Concealed Vertical Rod 36" x 84"(WxH)	US19	2	36	\$1,465.63
	EF9120V/EO3X8-SS	Concealed Vertical Rod 36" x 96"(WxH)	US32D	2	37	\$1,603.84
	EF9120V/EO3X8-AL	Concealed Vertical Rod 36" x 96"(WxH)	US26D	2	37	\$1,539.50
	EF9120V/EO3X8-DB	Concealed Vertical Rod 36" x 96"(WxH)	US10B	2	37	\$1,539.50
	EF9120V/EO3X8-BL	Concealed Vertical Rod 36" x 96"(WxH)	US19	2	37	\$1,539.50
	EF9120V/EO4X7-SS	Concealed Vertical Rod 48" x 84"(WxH)	US32D	2	42	\$1,627.68
	EF9120V/EO4X7-AL	Concealed Vertical Rod 48" x 84"(WxH)	US26D	2	42	\$1,568.10
	EF9120V/EO4X7-DB	Concealed Vertical Rod 48" x 84"(WxH)	US10B	2	42	\$1,568.10
	EF9120V/EO4X7-BL	Concealed Vertical Rod 48" x 84"(WxH)	US19	2	42	\$1,568.10
	EF9120V/EO4X8-SS	Concealed Vertical Rod 48" x 96"(WxH)	US32D	2	43	\$1,641.98
	EF9120V/EO4X8-AL	Concealed Vertical Rod 48" x 96"(WxH)	US26D	2	43	\$1,580.02
	EF9120V/EO4X8-DB	Concealed Vertical Rod 48" x 96"(WxH)	US10B	2	43	\$1,580.02
	EF9120V/EO4X8-BL	Concealed Vertical Rod 48" x 96"(WxH)	US19	2	43	\$1,580.02

CONCEALED LESS BOTTOM ROD

	Model #	Function	Finish	QTY /Case	Lbs /Case	List Price
 <p>UL LISTED BHMA CERTIFIED</p> <p>(ETA for new items: 09/22)</p>	EF9120V/LBR37-SS	Concealed Vertical LBR 36" x 84"(WxH)	US32D	2	31	\$1,520.44
	EF9120V/LBR37-AL	Concealed Vertical LBR 36" x 84"(WxH)	US26D	2	31	\$1,465.63
	EF9120V/LBR37-DB	Concealed Vertical LBR 36" x 84"(WxH)	US10B	2	31	\$1,465.63
	EF9120V/LBR37-BL	Concealed Vertical LBR 36" x 84"(WxH)	US19	2	31	\$1,465.63
	EF9120V/LBR38-SS	Concealed Vertical LBR 36" x 96"(WxH)	US32D	2	32	\$1,603.84
	EF9120V/LBR38-AL	Concealed Vertical LBR 36" x 96"(WxH)	US26D	2	32	\$1,539.50
	EF9120V/LBR38-DB	Concealed Vertical LBR 36" x 96"(WxH)	US10B	2	32	\$1,539.50
	EF9120V/LBR38-BL	Concealed Vertical LBR 36" x 96"(WxH)	US19	2	32	\$1,539.50
	EF9120V/LBR47-SS	Concealed Vertical LBR 48" x 84"(WxH)	US32D	2	37	\$1,627.68
	EF9120V/LBR47-AL	Concealed Vertical LBR 48" x 84"(WxH)	US26D	2	37	\$1,568.10
	EF9120V/LBR47-DB	Concealed Vertical LBR 48" x 84"(WxH)	US10B	2	37	\$1,568.10
	EF9120V/LBR47-BL	Concealed Vertical LBR 48" x 84"(WxH)	US19	2	37	\$1,568.10
	EF9120V/LBR48-SS	Concealed Vertical LBR 48" x 96"(WxH)	US32D	2	38	\$1,641.98
	EF9120V/LBR48-AL	Concealed Vertical LBR 48" x 96"(WxH)	US26D	2	38	\$1,580.02
	EF9120V/LBR48-DB	Concealed Vertical LBR 48" x 96"(WxH)	US10B	2	38	\$1,580.02
	EF9120V/LBR48-BL	Concealed Vertical LBR 48" x 96"(WxH)	US19	2	38	\$1,580.02





		Model #	Function	Finish	QTY /Case	Lbs /Case	List Price	
<p>L3 LEVER (Narrow Stile)</p> <p>Reversible</p>  <p>Entry (Mortise Cylinder)</p>  <p>Storeroom (Rim Cylinder)</p>  <p>Passage/Dummy</p>		Fits 1-3/4" ~ 2" door thickness (compatible with E9100/EF9100 series)						
			E9100/L3-AL	Heavy Duty L3 Lever Entry Lock	US26D	6	28	\$389.49
			E9100/L3-DB	Heavy Duty L3 Lever Entry Lock	US10B	6	28	\$389.49
			E9100/L3-BL	Heavy Duty L3 Lever Entry Lock	US19	6	28	\$389.49
			⚡ E9100/L3D-AL	I/C Core HD L3 Lever Entry Lock (w/o IC core)	US26D	6	28	\$389.49
			⚡ E9100/L3D-DB	I/C Core HD L3 Lever Entry Lock (w/o IC core)	US10B	6	28	\$389.49
			⚡ E9100/L3D-BL	I/C Core HD L3 Lever Entry Lock (w/o IC core)	US19	6	28	\$389.49
			E9100/L3S-AL	Heavy Duty L3 Lever Storeroom Lock	US26D	6	28	\$389.49
			E9100/L3S-DB	Heavy Duty L3 Lever Storeroom Lock	US10B	6	28	\$389.49
			E9100/L3S-BL	Heavy Duty L3 Lever Storeroom Lock	US19	6	28	\$389.49
			⚡ E9100/L3SD-AL	I/C Core HD L3 Lever Storeroom Lock (w/o IC core)	US26D	6	28	\$389.49
			⚡ E9100/L3SD-DB	I/C Core HD L3 Lever Storeroom Lock (w/o IC core)	US10B	6	28	\$389.49
			⚡ E9100/L3SD-BL	I/C Core HD L3 Lever Storeroom Lock (w/o IC core)	US19	6	28	\$389.49
			E9100/L3PA-AL	Heavy Duty L3 Lever Passage	US26D	6	24	\$327.43
			E9100/L3PA-DB	Heavy Duty L3 Lever Passage	US10B	6	24	\$327.43
			E9100/L3PA-BL	Heavy Duty L3 Lever Passage	US19	6	24	\$327.43
			E9100/D3-AL	Heavy Duty L3 Lever Dummy Set	US26D	6	24	\$327.43
			E9100/D3-DB	Heavy Duty L3 Lever Dummy Set	US10B	6	24	\$327.43
			E9100/D3-BL	Heavy Duty L3 Lever Dummy Set	US19	6	24	\$327.43
		<p>LN LEVER (Narrow Stile)</p> <p>Reversible</p>  <p>Entry (Mortise Cylinder)</p>  <p>Storeroom (Rim Cylinder)</p>  <p>Passage/Dummy</p>		E9100/LN-AL	Heavy Duty LN Lever Entry Lock	US26D	6	28
E9100/LN-DB	Heavy Duty LN Lever Entry Lock			US10B	6	28	\$389.49	
⚡ E9100/LND-AL	I/C Core HD LN Lever Entry Lock (w/o IC core)			US26D	6	28	\$389.49	
⚡ E9100/LND-DB	I/C Core HD LN Lever Entry Lock (w/o IC core)			US10B	6	28	\$389.49	
E9100/LNS-AL	Heavy Duty LN Lever Storeroom Lock			US26D	6	28	\$389.49	
E9100/LNS-DB	Heavy Duty LN Lever Storeroom Lock			US10B	6	28	\$389.49	
⚡ E9100/LNSD-AL	I/C Core HD LN Lever Storeroom Lock (w/o IC core)			US26D	6	28	\$389.49	
⚡ E9100/LNSD-DB	I/C Core HD LN Lever Storeroom Lock (w/o IC core)			US10B	6	28	\$389.49	
E9100/LNPA-AL	Heavy Duty LN Lever Passage			US26D	6	24	\$327.43	
E9100/LNPA-DB	Heavy Duty LN Lever Passage			US10B	6	24	\$327.43	
E9100/DN-AL	Heavy Duty LN Lever Dummy Set			US26D	6	24	\$327.43	
E9100/DN-DB	Heavy Duty LN Lever Dummy Set			US10B	6	24	\$327.43	

		Model #	Function	Finish	QTY /Case	Lbs /Case	List Price	
<p>LH LEVER (Narrow Stile)</p> <p>Reversible</p>  <p>Entry (Mortise Cylinder)</p>  <p>Storeroom (Rim Cylinder)</p>  <p>Passage/Dummy</p>								
		(ETA for new items: 09/22)						
		E9100/LH-AL	Heavy Duty LH Lever Entry Lock	US26D	6	28	\$389.49	
		E9100/LH-DB	Heavy Duty LH Lever Entry Lock	US10B	6	28	\$389.49	
		E9100/LH-BL	Heavy Duty LH Lever Entry Lock	US19	6	28	\$389.49	
		E9100/LHD-AL	I/C Core HD LH Lever Entry Lock (w/o IC core)	US26D	6	28	\$389.49	
		E9100/LHD-DB	I/C Core HD LH Lever Entry Lock (w/o IC core)	US10B	6	28	\$389.49	
		E9100/LHD-BL	I/C Core HD LH Lever Entry Lock (w/o IC core)	US19	6	28	\$389.49	
		E9100/LHS-AL	Heavy Duty LH Lever Storeroom Lock	US26D	6	28	\$389.49	
		E9100/LHS-DB	Heavy Duty LH Lever Storeroom Lock	US10B	6	28	\$389.49	
		E9100/LHS-BL	Heavy Duty LH Lever Storeroom Lock	US19	6	28	\$389.49	
		E9100/LHSD-AL	I/C Core HD LH Lever Storeroom Lock (w/o IC core)	US26D	6	28	\$389.49	
		E9100/LHSD-DB	I/C Core HD LH Lever Storeroom Lock (w/o IC core)	US10B	6	28	\$389.49	
		E9100/LHSD-BL	I/C Core HD LH Lever Storeroom Lock (w/o IC core)	US19	6	28	\$389.49	
		E9100/LHPA-AL	Heavy Duty LH Lever Passage	US26D	6	24	\$327.43	
		E9100/LHPA-DB	Heavy Duty LH Lever Passage	US10B	6	24	\$327.43	
		E9100/LHPA-BL	Heavy Duty LH Lever Passage	US19	6	24	\$327.43	
		E9100/DH-AL	Heavy Duty LH Lever Dummy Trim	US26D	6	24	\$327.43	
		E9100/DH-DB	Heavy Duty LH Lever Dummy Trim	US10B	6	24	\$327.43	
		E9100/DH-BL	Heavy Duty LH Lever Dummy Trim	US19	6	24	\$327.43	

	Model #	Function	Finish	QTY /Case	Lbs /Case	List Price
	(compatible with E9100/EF9100 series) (ETA for new items: 09/22)					
	E9100/36AK-SS	Alarm Kit for 36" Rim and Vertical Rod Exit Devices	US32D	6	18	\$477.95
	E9100/36AK-AL	Alarm Kit for 36" Rim and Vertical Rod Exit Devices	US26D	6	18	\$443.61
	E9100/36AK-DB	Alarm Kit for 36" Rim and Vertical Rod Exit Devices	US10B	6	18	\$443.61
	E9100/36AK-BL	Alarm Kit for 36" Rim and Vertical Rod Exit Devices	US19	6	18	\$443.61
	E9100/48AK-SS	Alarm Kit for 48" Rim and Vertical Rod Exit Devices	US32D	6	20	\$525.49
	E9100/48AK-AL	Alarm Kit for 48" Rim and Vertical Rod Exit Devices	US26D	6	20	\$483.23
	E9100/48AK-DB	Alarm Kit for 48" Rim and Vertical Rod Exit Devices	US10B	6	20	\$483.23
	E9100/48AK-BL	Alarm Kit for 48" Rim and Vertical Rod Exit Devices	US19	6	20	\$483.23
	(compatible with E9100/EF9100 series) (ETA for new items: 09/22)					
	E9100/36CD-SS	Dogging Kit for 36" Exit Devices	US32D	6	18	\$137.30
	E9100/36CD-AL	Dogging Kit for 36" Exit Devices	US26D	6	18	\$126.74
	E9100/36CD-DB	Dogging Kit for 36" Exit Devices	US10B	6	18	\$126.74
	E9100/36CD-BL	Dogging Kit for 36" Exit Devices	US19	6	18	\$126.74
	E9100/48CD-SS	Dogging Kit for 48" Exit Devices	US32D	6	20	\$150.51
	E9100/48CD-AL	Dogging Kit for 48" Exit Devices	US26D	6	20	\$137.30
	E9100/48CD-DB	Dogging Kit for 48" Exit Devices	US10B	6	20	\$137.30
	E9100/48CD-BL	Dogging Kit for 48" Exit Devices	US10B	6	20	\$137.30
	(ETA for new items: 09/22)					
	E9100/36ICCD-SS	I/C Core Dogging Kit for 36" Exit (w/o IC core)	US32D	6	18	\$137.30
	E9100/36ICCD-AL	I/C Core Dogging Kit for 36" Exit (w/o IC core)	US26D	6	18	\$126.74
	E9100/36ICCD-DB	I/C Core Dogging Kit for 36" Exit (w/o IC core)	US10B	6	18	\$126.74
	E9100/36ICCD-BL	I/C Core Dogging Kit for 36" Exit (w/o IC core)	US19	6	18	\$126.74
	E9100/48ICCD-SS	I/C Core Dogging Kit for 48" Exit (w/o IC core)	US32D	6	20	\$150.51
	E9100/48ICCD-AL	I/C Core Dogging Kit for 48" Exit (w/o IC core)	US26D	6	20	\$137.30
	E9100/48ICCD-DB	I/C Core Dogging Kit for 48" Exit (w/o IC core)	US10B	6	20	\$137.30
	E9100/48ICCD-BL	I/C Core Dogging Kit for 48" Exit (w/o IC core)	US19	6	20	\$137.30
	(compatible with E9100/EF9100 series) (ETA for new items: 09/22)					
	E9100V/38K-SS	Extension kit for 8' high door for E9100 series	US32D	12	15	\$65.67
	E9100V/38K-AL	Extension kit for 8' high door for E9100 series	US26D	12	15	\$46.90
	E9100V/38K-DB	Extension kit for 8' high door for E9100 series	US10B	12	15	\$46.90
	E9100V/38K-BL	Extension kit for 8' high door for E9100 series	US19	12	15	\$46.90

	Model #	Function	Finish	QTY /Case	Lbs /Case	List Price	
	(compatible with E9100/EF9100 series)						
	E9100/OLSP-AL	Overlapping Strike Plate	US26D	50	20	\$23.46	
	E9100/OLSP-DB	Overlapping Strike Plate	US10B	50	20	\$23.46	
	E9100/OLSP-BL	Overlapping Strike Plate (ETA: 09/22)	US19	50	20	\$23.46	
	(For Entry Trim)						
	E9100/MCSC-AL	SC 6-pin Mortise Cylinder	US26D	40	30	\$37.32	
	E9100/MCSC-DB	SC 6-pin Mortise Cylinder	US10B	40	30	\$37.32	
	E9100/MCSC-BL	SC 6-pin Mortise Cylinder	US19	40	30	\$37.32	
	E9100/MCKW-AL	KW 5-pin Mortise Cylinder	US26D	40	30	\$37.32	
	E9100/MCKW-DB	KW 5-pin Mortise Cylinder	US10B	40	30	\$37.32	
	E9100/MCKW-BL	KW 5-pin Mortise Cylinder	US19	40	30	\$37.32	
	E9100/MCD-AL	I/C Core Mortise Cylinder (w/o IC core)	US26D	40	30	\$65.33	
	E9100/MCD-DB	I/C Core Mortise Cylinder (w/o IC core)	US10B	40	30	\$65.33	
	E9100/MCD-BL	I/C Core Mortise Cylinder (w/o IC core)	US19	40	30	\$65.33	
		(For Storeroom Trim)					
		E9100/RCSC-AL	SC 6-pin Rim Cylinder	US26D	40	30	\$37.32
		E9100/RCSC-DB	SC 6-pin Rim Cylinder	US10B	40	30	\$37.32
E9100/RCSC-BL		SC 6-pin Rim Cylinder	US19	40	30	\$37.32	
E9100/RCKW-AL		KW 5-pin Rim Cylinder	US26D	40	30	\$37.32	
E9100/RCKW-DB		KW 5-pin Rim Cylinder	US10B	40	30	\$37.32	
E9100/RCKW-BL		KW 5-pin Rim Cylinder	US19	40	30	\$37.32	
E9100/RCD-AL		I/C Core Rim Cylinder (w/o IC core)	US26D	40	30	\$65.33	
E9100/RCD-DB		I/C Core Rim Cylinder (w/o IC core)	US10B	40	30	\$65.33	
E9100/RCD-BL		I/C Core Rim Cylinder (w/o IC core)	US19	40	30	\$65.33	

	Model #	Function	Finish	QTY /Case	Lbs /Case	List Price
	E4000/DC52-AL	Door Coordinator for 54"-98" Door Width	US26D	10	28	\$147.53
	E4000/DC60-AL	Door Coordinator for 97"-112" Door Width	US26D	10	30	\$162.61
	E4000/FB18-AL	Filler Bar, 18-5/8" for 72" Pair Door	US26D	10	6	\$21.23
	E4000/FB42-AL	Filler Bar, 42-5/8" for 96" Pair Door	US26D	10	6	\$47.77
	E4000/MB2	Mounting Bracket for Stop Width Over 2-1/4" (price per pair, sold per pair only)		25	48	\$60.00
	E4000/MB3	Mounting Bracket for Stop Width between 7/8"-2-1/4" (price per pair, sold per pair only)		25	48	\$77.42
	E4000/CB-DB	Carry Bar	US10B	50	22	\$34.40
	E4000/GDC7-AL	Gravity Door Coordinator 6-1/2" Projection	US26D	20	44	\$79.79
	E4000/GDC7-DB	Gravity Door Coordinator 6-1/2" Projection	US10B	20	44	\$79.79
	EF9000/AFL	Auxiliary Fire Bolt for Less Bottom Rod		50	16	\$62.73

	Model #	Function	Finish	QTY /Case	Lbs /Case	List Price
	(For Rim Device)					
	E8000/SB6-AL	Sex Nuts, Female Part Only (set of 6)	US26D	50	6	\$10.71
	E8000/SB6-DB	Sex Nuts, Female Part Only (set of 6)	US10B	50	6	\$10.71
	E8000/SB6-BL	Sex Nuts, Female Part Only (set of 6)	US19	50	6	\$10.71
	(For Top and Bottom Latch)					
	E8000/SB4-AL	Sex Nuts, Female Part Only (set of 4)	US26D	50	6	\$7.14
	E8000/SB4-DB	Sex Nuts, Female Part Only (set of 4)	US10B	50	6	\$7.14
	E8000/SB4-BL	Sex Nuts, Female Part Only (set of 4)	US19	50	6	\$7.14
	E8000/ASA-AL Blank ASA Strike (4-7/8"x1-1/4")					
			US26D	50	10	\$12.13
	E8000/5SP-AL Latch Hole Filler Plate (2-1/4"x1-1/8")					
			US26D	50	10	\$4.04
	E9100/TS-AL Threshold Strike					
			US26D	20	10	\$12.49

E9100 SERIES -- Electric Latch Retraction, Grade 1, Non Fire Rated

Model #	Function	Finish	QTY /Case	Lbs /Case	List Price
NARROW STILE RIM TYPE					
E910E/EO3-SS	Exit Only For Door 32" to 36" Wide	US32D	3	46	\$2,652.43
E910E/EO3-AL	Exit Only For Door 32" to 36" Wide	US26D	3	46	\$2,561.86
E910E/EO3-DB	Exit Only For Door 32" to 36" Wide	US10B	3	46	\$2,561.86
E910E/EO3-BL	Exit Only For Door 32" to 36" Wide	US19	3	46	\$2,561.86
E910E/EO4-SS	Exit Only For Door 44" to 48" Wide	US32D	3	52	\$2,738.22
E910E/EO4-AL	Exit Only For Door 44" to 48" Wide	US26D	3	52	\$2,640.51
E910E/EO4-DB	Exit Only For Door 44" to 48" Wide	US10B	3	52	\$2,640.51
E910E/EO4-BL	Exit Only For Door 44" to 48" Wide	US19	3	52	\$2,640.51



NARROW STILE VERTICAL ROD

E910EV/EO3X7-SS	Surface Vertical Rod 36" x 84"(WxH)	US32D	2	40	\$3,052.79
E910EV/EO3X7-AL	Surface Vertical Rod 36" x 84"(WxH)	US26D	2	40	\$3,002.75
E910EV/EO3X7-DB	Surface Vertical Rod 36" x 84"(WxH)	US10B	2	40	\$3,002.75
E910EV/EO3X7-BL	Surface Vertical Rod 36" x 84"(WxH)	US19	2	40	\$3,002.75
E910EV/EO3X8-SS	Surface Vertical Rod 36" x 96"(WxH)	US32D	2	41	\$3,133.81
E910EV/EO3X8-AL	Surface Vertical Rod 36" x 96"(WxH)	US26D	2	41	\$3,071.86
E910EV/EO3X8-DB	Surface Vertical Rod 36" x 96"(WxH)	US10B	2	41	\$3,071.86
E910EV/EO3X8-BL	Surface Vertical Rod 36" x 96"(WxH)	US19	2	41	\$3,071.86
E910EV/EO4X7-SS	Surface Vertical Rod 48" x 84"(WxH)	US32D	2	45	\$3,157.65
E910EV/EO4X7-AL	Surface Vertical Rod 48" x 84"(WxH)	US26D	2	45	\$3,098.07
E910EV/EO4X7-DB	Surface Vertical Rod 48" x 84"(WxH)	US10B	2	45	\$3,098.07
E910EV/EO4X7-BL	Surface Vertical Rod 48" x 84"(WxH)	US19	2	45	\$3,098.07
E910EV/EO4X8-SS	Surface Vertical Rod 48" x 96"(WxH)	US32D	2	46	\$3,171.95
E910EV/EO4X8-AL	Surface Vertical Rod 48" x 96"(WxH)	US26D	2	46	\$3,109.99
E910EV/EO4X8-DB	Surface Vertical Rod 48" x 96"(WxH)	US10B	2	46	\$3,109.99
E910EV/EO4X8-BL	Surface Vertical Rod 48" x 96"(WxH)	US19	2	46	\$3,109.99





OPTIONAL ADD-ON FOR E9100 SERIES ELECTRIC LATCH RETRACTION

E9100/REX	Request to Exit	10	20	\$224.96
E9100/LBM	Latch Bolt Monitoring	10	20	\$224.96
E9100/REXLBM	Request to Exit+Latch Bolt Monitoring	10	20	\$449.91

*For all electric hardware, please check availability and lead-time with sales department first.

EF9100 SERIES -- Electric Latch Retraction, Grade 1, Fire Rated

	Model #	Function	Finish	QTY /Case	Lbs /Case	List Price
<p>NARROW STILE RIM TYPE</p>  	EF910E/EO3-SS	Exit Only For Door 32" to 36" Wide	US32D	3	46	\$2,809.71
	EF910E/EO3-AL	Exit Only For Door 32" to 36" Wide	US26D	3	46	\$2,762.05
	EF910E/EO3-DB	Exit Only For Door 32" to 36" Wide	US10B	3	46	\$2,762.05
	EF910E/EO3-BL	Exit Only For Door 32" to 36" Wide	US19	3	46	\$2,762.05
	EF910E/EO4-SS	Exit Only For Door 44" to 48" Wide	US32D	3	52	\$2,971.77
	EF910E/EO4-AL	Exit Only For Door 44" to 48" Wide	US26D	3	52	\$2,852.61
	EF910E/EO4-DB	Exit Only For Door 44" to 48" Wide	US10B	3	52	\$2,852.61
	EF910E/EO4-BL	Exit Only For Door 44" to 48" Wide	US19	3	52	\$2,852.61

NARROW STILE VERTICAL ROD

	Model #	Function	Finish	QTY /Case	Lbs /Case	List Price
 	EF910EV/EO3X7-SS	Surface Vertical Rod 36" x 84"(WxH)	US32D	2	40	\$3,274.42
	EF910EV/EO3X7-AL	Surface Vertical Rod 36" x 84"(WxH)	US26D	2	40	\$3,212.46
	EF910EV/EO3X7-DB	Surface Vertical Rod 36" x 84"(WxH)	US10B	2	40	\$3,212.46
	EF910EV/EO3X7-BL	Surface Vertical Rod 36" x 84"(WxH)	US19	2	40	\$3,212.46
	EF910EV/EO3X8-SS	Surface Vertical Rod 36" x 96"(WxH)	US32D	2	41	\$3,367.36
	EF910EV/EO3X8-AL	Surface Vertical Rod 36" x 96"(WxH)	US26D	2	41	\$3,295.87
	EF910EV/EO3X8-DB	Surface Vertical Rod 36" x 96"(WxH)	US10B	2	41	\$3,295.87
	EF910EV/EO3X8-BL	Surface Vertical Rod 36" x 96"(WxH)	US19	2	41	\$3,295.87
	EF910EV/EO4X7-SS	Surface Vertical Rod 48" x 84"(WxH)	US32D	2	45	\$3,395.96
	EF910EV/EO4X7-AL	Surface Vertical Rod 48" x 84"(WxH)	US26D	2	45	\$3,329.24
	EF910EV/EO4X7-DB	Surface Vertical Rod 48" x 84"(WxH)	US10B	2	45	\$3,329.24
	EF910EV/EO4X7-BL	Surface Vertical Rod 48" x 84"(WxH)	US19	2	45	\$3,329.24
	EF910EV/EO4X8-SS	Surface Vertical Rod 48" x 96"(WxH)	US32D	2	46	\$3,410.26
	EF910EV/EO4X8-AL	Surface Vertical Rod 48" x 96"(WxH)	US26D	2	46	\$3,341.15
	EF910EV/EO4X8-DB	Surface Vertical Rod 48" x 96"(WxH)	US10B	2	46	\$3,341.15
	EF910EV/EO4X8-BL	Surface Vertical Rod 48" x 96"(WxH)	US19	2	46	\$3,341.15

NARROW STILE LESS BOTTOM ROD

	Model #	Function	Finish	QTY /Case	Lbs /Case	List Price
 	EF910EV/LBR37-SS	LBR Vertical Rod 36" x 84"(WxH)	US32D	2	36	\$3,274.42
	EF910EV/LBR37-AL	LBR Vertical Rod 36" x 84"(WxH)	US26D	2	36	\$3,212.46
	EF910EV/LBR37-DB	LBR Vertical Rod 36" x 84"(WxH)	US10B	2	36	\$3,212.46
	EF910EV/LBR37-BL	LBR Vertical Rod 36" x 84"(WxH)	US19	2	36	\$3,212.46
	EF910EV/LBR38-SS	LBR Vertical Rod 36" x 96"(WxH)	US32D	2	37	\$3,367.36
	EF910EV/LBR38-AL	LBR Vertical Rod 36" x 96"(WxH)	US26D	2	37	\$3,295.87
	EF910EV/LBR38-DB	LBR Vertical Rod 36" x 96"(WxH)	US10B	2	37	\$3,295.87
	EF910EV/LBR38-BL	LBR Vertical Rod 36" x 96"(WxH)	US19	2	37	\$3,295.87
	EF910EV/LBR47-SS	LBR Vertical Rod 48" x 84"(WxH)	US32D	2	39	\$3,395.96
	EF910EV/LBR47-AL	LBR Vertical Rod 48" x 84"(WxH)	US26D	2	39	\$3,329.24
	EF910EV/LBR47-DB	LBR Vertical Rod 48" x 84"(WxH)	US10B	2	39	\$3,329.24
	EF910EV/LBR47-BL	LBR Vertical Rod 48" x 84"(WxH)	US19	2	39	\$3,329.24
	EF910EV/LBR48-SS	LBR Vertical Rod 48" x 96"(WxH)	US32D	2	40	\$3,410.26
	EF910EV/LBR48-AL	LBR Vertical Rod 48" x 96"(WxH)	US26D	2	40	\$3,341.15
	EF910EV/LBR48-DB	LBR Vertical Rod 48" x 96"(WxH)	US10B	2	40	\$3,341.15
	EF910EV/LBR48-BL	LBR Vertical Rod 48" x 96"(WxH)	US19	2	40	\$3,341.15

E9120 SERIES -- Electric Latch Retraction, Grade 1, Non Fire Rated

Model #	Function	Finish	QTY /Case	Lbs /Case	List Price
E912EV/EO3X7-SS	Concealed Vertical Rod 36" x 84"(WxH)	US32D	2	40	\$3,052.79
E912EV/EO3X7-AL	Concealed Vertical Rod 36" x 84"(WxH)	US26D	2	40	\$3,002.75
E912EV/EO3X7-DB	Concealed Vertical Rod 36" x 84"(WxH)	US10B	2	40	\$3,002.75
E912EV/EO3X8-SS	Concealed Vertical Rod 36" x 96"(WxH)	US32D	2	41	\$3,133.81
E912EV/EO3X8-AL	Concealed Vertical Rod 36" x 96"(WxH)	US26D	2	41	\$3,071.86
E912EV/EO3X8-DB	Concealed Vertical Rod 36" x 96"(WxH)	US10B	2	41	\$3,071.86
E912EV/EO4X7-SS	Concealed Vertical Rod 48" x 84"(WxH)	US32D	2	45	\$3,157.65
E912EV/EO4X7-AL	Concealed Vertical Rod 48" x 84"(WxH)	US26D	2	45	\$3,098.07
E912EV/EO4X7-DB	Concealed Vertical Rod 48" x 84"(WxH)	US10B	2	45	\$3,098.07
E912EV/EO4X8-SS	Concealed Vertical Rod 48" x 96"(WxH)	US32D	2	46	\$3,171.95
E912EV/EO4X8-AL	Concealed Vertical Rod 48" x 96"(WxH)	US26D	2	46	\$3,109.99
E912EV/EO4X8-DB	Concealed Vertical Rod 48" x 96"(WxH)	US10B	2	46	\$3,109.99

NARROW STILE
CONCEALED VERTICAL ROD



EF9120 SERIES -- Electric Latch Retraction, Grade 1, Fire Rated

Model #	Function	Finish	QTY /Case	Lbs /Case	List Price
EF912EV/EO3X7-SS	Concealed Vertical Rod 36" x 84"(WxH)	US32D	2	40	\$3,274.42
EF912EV/EO3X7-AL	Concealed Vertical Rod 36" x 84"(WxH)	US26D	2	40	\$3,212.46
EF912EV/EO3X7-DB	Concealed Vertical Rod 36" x 84"(WxH)	US10B	2	40	\$3,212.46
EF912EV/EO3X8-SS	Concealed Vertical Rod 36" x 96"(WxH)	US32D	2	41	\$3,367.36
EF912EV/EO3X8-AL	Concealed Vertical Rod 36" x 96"(WxH)	US26D	2	41	\$3,295.87
EF912EV/EO3X8-DB	Concealed Vertical Rod 36" x 96"(WxH)	US10B	2	41	\$3,295.87
EF912EV/EO4X7-SS	Concealed Vertical Rod 48" x 84"(WxH)	US32D	2	45	\$3,395.96
EF912EV/EO4X7-AL	Concealed Vertical Rod 48" x 84"(WxH)	US26D	2	45	\$3,329.24
EF912EV/EO4X7-DB	Concealed Vertical Rod 48" x 84"(WxH)	US10B	2	45	\$3,329.24
EF912EV/EO4X8-SS	Concealed Vertical Rod 48" x 96"(WxH)	US32D	2	46	\$3,410.26
EF912EV/EO4X8-AL	Concealed Vertical Rod 48" x 96"(WxH)	US26D	2	46	\$3,341.15
EF912EV/EO4X8-DB	Concealed Vertical Rod 48" x 96"(WxH)	US10B	2	46	\$3,341.15

NARROW STILE
CONCEALED VERTICAL ROD







CONCEALED LESS BOTTOM
ROD

Model #	Function	Finish	QTY /Case	Lbs /Case	List Price
EF912EV/LBR37-SS	Concealed LBR Vertical Rod 36" x 84"(WxH)	US32D	2	36	\$3,274.42
EF912EV/LBR37-AL	Concealed LBR Vertical Rod 36" x 84"(WxH)	US26D	2	36	\$3,212.46
EF912EV/LBR37-DB	Concealed LBR Vertical Rod 36" x 84"(WxH)	US10B	2	36	\$3,212.46
EF912EV/LBR38-SS	Concealed LBR Vertical Rod 36" x 96"(WxH)	US32D	2	37	\$3,367.36
EF912EV/LBR38-AL	Concealed LBR Vertical Rod 36" x 96"(WxH)	US26D	2	37	\$3,295.87
EF912EV/LBR38-DB	Concealed LBR Vertical Rod 36" x 96"(WxH)	US10B	2	37	\$3,295.87
EF912EV/LBR47-SS	Concealed LBR Vertical Rod 48" x 84"(WxH)	US32D	2	39	\$3,395.96
EF912EV/LBR47-AL	Concealed LBR Vertical Rod 48" x 84"(WxH)	US26D	2	39	\$3,329.24
EF912EV/LBR47-DB	Concealed LBR Vertical Rod 48" x 84"(WxH)	US10B	2	39	\$3,329.24
EF912EV/LBR48-SS	Concealed LBR Vertical Rod 48" x 96"(WxH)	US32D	2	40	\$3,410.26
EF912EV/LBR48-AL	Concealed LBR Vertical Rod 48" x 96"(WxH)	US26D	2	40	\$3,341.15
EF912EV/LBR48-DB	Concealed LBR Vertical Rod 48" x 96"(WxH)	US10B	2	40	\$3,341.15



E9300 SERIES -- Grade 1

	Model #	Function	Finish	QTY /Case	Lbs /Case	List Price
RIM TYPE  	Non-Fire Rated					
	E9300/EO3-AL	Entry Exit Only For Door 32" to 36" Wide	US26D	3	40	\$960.40
	E9300/EO4-AL	Entry Exit Only For Door 44" to 48" Wide	US26D	3	46	\$1,036.66
	E9350/EO3-AL	Storeroom Exit Only For Door 32" to 36" Wide	US26D	3	40	\$960.40
	E9350/EO4-AL	Storeroom Exit Only For Door 44" to 48" Wide	US26D	3	46	\$1,036.66

	Fire Rated 					
	EF9300/EO3-AL	Entry Exit Only For Door 32" to 36" Wide	US26D	3	40	\$1,153.43
	EF9300/EO4-AL	Entry Exit Only For Door 44" to 48" Wide	US26D	3	46	\$1,241.62
	EF9350/EO3-AL	Storeroom Exit Only For Door 32" to 36" Wide	US26D	3	40	\$1,153.43
	EF9350/EO4-AL	Storeroom Exit Only For Door 44" to 48" Wide	US26D	3	46	\$1,241.62

E9300 SERIES -- Grade 1

L3 LEVER

Reversible



Storeroom
(Rim Cylinder)



Entry
(Mortise Cylinder)



Passage/Dummy

Model #	Function	Finish	QTY /Case	Lbs /Case	List Price
E9300/L3-AL	Heavy Duty L3 Lever Entry Lock	US26D	6	28	\$389.49
E9300/L3D-AL	I/C Core HD L3 Lever Entry Lock (w/o IC core)	US26D	6	28	\$389.49
E9300/L3S-AL	Heavy Duty L3 Lever Storeroom Lock	US26D	6	28	\$389.49
E9300/L3SD-AL	I/C Core HD L3 Lever Storeroom Lock (w/o IC core)	US26D	6	28	\$389.49
E9300/L3PA-AL	Heavy Duty L3 Lever Passage Lock	US26D	6	28	\$327.43
E9300/D3-AL	Heavy Duty L3 Lever Dummy Set	US26D	6	28	\$327.43

LN LEVER

Reversible



Storeroom
(Rim Cylinder)



Entry
(Mortise Cylinder)



Passage/Dummy

E9300/LN-AL	Heavy Duty LN Lever Entry Lock	US26D	6	28	\$389.49
E9300/LND-AL	I/C Core HD LN Lever Entry Lock (w/o IC core)	US26D	6	28	\$389.49
E9300/LNS-AL	Heavy Duty LN Lever Storeroom Lock	US26D	6	28	\$389.49
E9300/LNSD-AL	I/C Core HD LN Lever Storeroom Lock (w/o IC core)	US26D	6	28	\$389.49
E9300/LNPA-AL	Heavy Duty LN Lever Passage Lock	US26D	6	28	\$327.43
E9300/DN-AL	Heavy Duty LN Lever Dummy Set	US26D	6	28	\$327.43

LH LEVER

Reversible



Storeroom
(Rim Cylinder)



Entry
(Mortise Cylinder)



Passage/Dummy

E9300/LH-AL	Heavy Duty LH Lever Entry Lock	US26D	6	28	\$389.49
E9300/LHD-AL	I/C Core HD LH Lever Entry Lock (w/o IC core)	US26D	6	28	\$389.49
E9300/LHS-AL	Heavy Duty LH Lever Storeroom Lock	US26D	6	28	\$389.49
E9300/LHSD-AL	I/C Core HD LH Lever Storeroom Lock (w/o IC core)	US26D	6	28	\$389.49
E9300/LHPA-AL	Heavy Duty LH Lever Passage Lock	US26D	6	28	\$327.43
E9300/DH-AL	Heavy Duty LH Lever Dummy Set	US26D	6	28	\$327.43

E7000 SERIES -- Grade 1, Non Fire Rated

	Model #	Function	Finish	QTY /Case	Lbs /Case	List Price
	E7000/EO3-SS	Exit Only For Door 32" to 36" Wide	US32D	2	44	\$480.99
	E7000/EO3-AL	Exit Only For Door 32" to 36" Wide	US26D	2	44	\$343.56
	E7000/EO3-DB	Exit Only For Door 32" to 36" Wide	US10B	2	44	\$343.56
	E7000/EO4-SS	Exit Only For Door 44" to 48" Wide	US32D	2	44	\$518.50
	E7000/EO4-AL	Exit Only For Door 44" to 48" Wide	US26D	2	44	\$370.36
	E7000/EO4-DB	Exit Only For Door 44" to 48" Wide	US10B	2	44	\$370.36

VERTICAL ROD

	E7000V/EO3X7-SS	Surface Vertical Rod 36" x 84" (WxH)	US32D	2	62	\$696.93
	E7000V/EO3X7-AL	Surface Vertical Rod 36" x 84" (WxH)	US26D	2	62	\$536.12
	E7000V/EO3X7-DB	Surface Vertical Rod 36" x 84" (WxH)	US10B	2	62	\$536.12
	E7000V/EO3X8-SS	Surface Vertical Rod 36" x 96" (WxH)	US32D	2	62	\$731.80
	E7000V/EO3X8-AL	Surface Vertical Rod 36" x 96" (WxH)	US26D	2	62	\$562.91
	E7000V/EO3X8-DB	Surface Vertical Rod 36" x 96" (WxH)	US10B	2	62	\$562.91
	E7000V/EO368-SS	Surface Vertical Rod 36" x 80" (WxH)	US32D	2	62	\$731.80
	E7000V/EO368-AL	Surface Vertical Rod 36" x 80" (WxH)	US26D	2	62	\$562.91
	E7000V/EO368-DB	Surface Vertical Rod 36" x 80" (WxH)	US10B	2	62	\$562.91
	E7000V/EO4X8-SS	Surface Vertical Rod 48" x 96" (WxH)	US32D	2	62	\$751.29
	E7000V/EO4X8-AL	Surface Vertical Rod 48" x 96" (WxH)	US26D	2	62	\$577.93
	E7000V/EO4X8-DB	Surface Vertical Rod 48" x 96" (WxH)	US10B	2	62	\$577.93

(compatible with E7000/EF7000 series)



E7000/AK-SS Alarm Kit	US32D	12	30	\$280.45
E7000/AK-AL Alarm Kit	US26D	12	30	\$252.40
E7000/AK-DB Alarm Kit	US10B	12	30	\$252.40

EF7000 SERIES -- Grade 1, 3 Hours UL Fire Rated

RIM TYPE











Model #	Function	Finish	QTY /Case	Lbs /Case	List Price
EF7000/EO3-SS	Exit Only For Door 32" to 36" Wide	US32D	2	21	\$577.17
EF7000/EO3-AL	Exit Only For Door 32" to 36" Wide	US26D	2	21	\$412.29
EF7000/EO3-DB	Exit Only For Door 32" to 36" Wide	US10B	2	21	\$412.29
EF7000/EO4-SS	Exit Only For Door 44" to 48" Wide	US32D	2	24	\$622.21
EF7000/EO4-AL	Exit Only For Door 44" to 48" Wide	US26D	2	24	\$444.44
EF7000/EO4-DB	Exit Only For Door 44" to 48" Wide	US10B	2	24	\$444.44









VERTICAL ROD



EF7000V/EO3X7-SS	Surface Vertical Rod 36" x 84" (WxH)	US32D	2	32	\$836.31
EF7000V/EO3X7-AL	Surface Vertical Rod 36" x 84" (WxH)	US26D	2	32	\$643.34
EF7000V/EO3X7-DB	Surface Vertical Rod 36" x 84" (WxH)	US10B	2	32	\$643.34
EF7000V/EO3X8-SS	Surface Vertical Rod 36" x 96" (WxH)	US32D	2	33	\$878.15
EF7000V/EO3X8-AL	Surface Vertical Rod 36" x 96" (WxH)	US26D	2	33	\$675.49
EF7000V/EO3X8-DB	Surface Vertical Rod 36" x 96" (WxH)	US10B	2	33	\$675.49
EF7000V/EO368-SS	Surface Vertical Rod 36" x 80" (WxH)	US32D	2	33	\$878.15
EF7000V/EO368-AL	Surface Vertical Rod 36" x 80" (WxH)	US26D	2	33	\$675.49
EF7000V/EO368-DB	Surface Vertical Rod 36" x 80" (WxH)	US10B	2	33	\$675.49
EF7000V/EO4X8-SS	Surface Vertical Rod 48" x 96" (WxH)	US32D	2	34	\$901.57
EF7000V/EO4X8-AL	Surface Vertical Rod 48" x 96" (WxH)	US26D	2	34	\$693.51
EF7000V/EO4X8-DB	Surface Vertical Rod 48" x 96" (WxH)	US10B	2	34	\$693.51
Less Bottom Rod with Auxiliary Fire Bolt					
EF7000V/LBR37-SS	LBR Vertical Rod 36" x 84" (WxH)	US32D	2	30	\$836.31
EF7000V/LBR37-AL	LBR Vertical Rod 36" x 84" (WxH)	US26D	2	30	\$643.34
EF7000V/LBR37-DB	LBR Vertical Rod 36" x 84" (WxH)	US10B	2	30	\$643.34
EF7000V/LBR38-SS	LBR Vertical Rod 36" x 96" (WxH)	US32D	2	31	\$878.15
EF7000V/LBR38-AL	LBR Vertical Rod 36" x 96" (WxH)	US26D	2	31	\$675.49
EF7000V/LBR38-DB	LBR Vertical Rod 36" x 96" (WxH)	US10B	2	31	\$675.49
EF7000V/LBR368-SS	LBR Vertical Rod 36" x 80" (WxH)	US32D	2	31	\$878.15
EF7000V/LBR368-AL	LBR Vertical Rod 36" x 80" (WxH)	US26D	2	31	\$675.49
EF7000V/LBR368-DB	LBR Vertical Rod 36" x 80" (WxH)	US10B	2	31	\$675.49
EF7000V/LBR48-SS	LBR Vertical Rod 48" x 96" (WxH)	US32D	2	32	\$901.57
EF7000V/LBR48-AL	LBR Vertical Rod 48" x 96" (WxH)	US26D	2	32	\$693.51
EF7000V/LBR48-DB	LBR Vertical Rod 48" x 96" (WxH)	US10B	2	32	\$693.51

	Model #	Function	Finish	QTY /Case	Lbs /Case	List Price
Reversible 	Fit 1-3/4" to 2" door thickness. (Compatible with E7000 & E5000 Series Exit Devices)					
	E5000/L-AL	Heavy Duty Lever Entry Lock	US26D	8	39	\$294.96
	E5000/L-DB	Heavy Duty Lever Entry Lock	US10B	8	39	\$294.96
	• E5000/LD-AL	I/C Core HD Lever Entry Lock (w/o IC Core)	US26D	8	39	\$294.96
	• E5000/LD-DB	I/C Core HD Lever Entry Lock (w/o IC Core)	US10B	8	39	\$294.96
Reversible 	Fit 1-3/4" to 2" door thickness. (Compatible with E7000 & E5000 Series Exit Devices)					
	E5000/LS-AL	Heavy Duty Lever Storeroom Lock	US26D	8	39	\$294.96
	E5000/LS-DB	Heavy Duty Lever Storeroom Lock	US10B	8	39	\$294.96
	• E5000/LSD-AL	I/C Core HD Lever Storeroom Lock (w/o IC Core)	US26D	8	39	\$294.96
	• E5000/LSD-DB	I/C Core HD Lever Storeroom Lock (w/o IC Core)	US10B	8	39	\$294.96
Reversible 	Fit 1-3/4" to 2" door thickness. (Compatible with E7000 & E5000 Series Exit Devices)					
	E5000/LPA-AL	Heavy Duty Lever Passage Lock	US26D	8	35	\$255.66
	E5000/LPA-DB	Heavy Duty Lever Passage Lock	US10B	8	35	\$255.66
	E5000/D-AL	Heavy Duty Lever Dummy Set	US26D	8	35	\$255.66
	E5000/D-DB	Heavy Duty Lever Dummy Set	US10B	8	35	\$255.66
	Fit 1-3/4" to 2-1/4" door thickness. (Compatible with E7000 & E5000 Series Exit Devices)					
	E7000/L-AL	Thumb Piece Entry	US26D	10	37	\$168.54
	E7000/L-DB	Thumb Piece Entry	US10B	10	37	\$168.54
	• E7000/LD-AL	I/C Core Thumb Piece Entry (w/o IC Core)	US26D	10	37	\$168.54
	• E7000/LD-DB	I/C Core Thumb Piece Entry (w/o IC Core)	US10B	10	37	\$168.54
	Fit 1-3/4" to 2-1/4" door thickness. (Compatible with E7000 & E5000 Series Exit Devices)					
	E7000/LS-AL	Storeroom	US26D	10	37	\$152.80
	E7000/LS-DB	Storeroom	US10B	10	37	\$152.80
	• E7000/LSD-AL	I/C Core Storeroom (w/o IC Core)	US26D	10	37	\$152.80
	• E7000/LSD-DB	I/C Core Storeroom (w/o IC Core)	US10B	10	37	\$152.80
	Fit 1-3/4" to 2-1/4" door thickness. (Compatible with E7000 & E5000 Series Exit Devices)					
	E7000/PA-AL	Thumb Piece Passage	US26D	10	33	\$126.80
	E7000/PA-DB	Thumb Piece Passage	US10B	10	33	\$126.80

	Model #	Function	Finish	QTY /Case	Lbs /Case	List Price
	Fit 1-3/4" to 2-1/4" door thickness. (Compatible with E7000 & E5000 Series Exit Devices)					
	E7000/D-AL	Dummy Trim	US26D	20	33	\$96.48
	E7000/D-DB	Dummy Trim	US10B	20	33	\$96.48
<p>Crossbore: 2-1/8"</p> 	Fit 1-3/8" to 1-3/4" door thickness. (Compatible with E7000, E5000, & E8000 Series Exit Devices)					
	E8000/L-AL	Lever Entry Lock	US26D	20	37	\$90.29
	E8000/L-DB	Lever Entry Lock	US10B	20	37	\$90.29
	• E8000/LD-AL	I/C Core Lever Entry Lock (w/o IC Core)	US26D	20	37	\$90.29
	• E8000/LD-DB	I/C Core Lever Entry Lock (w/o IC Core)	US10B	20	37	\$90.29
<p>Crossbore: 2-1/8"</p> 	Fit 1-3/8" to 1-3/4" door thickness. (Compatible with E7000, E5000, & E8000 Series Exit Devices)					
	E8000/LS-AL	Lever Storeroom Lock	US26D	20	37	\$90.29
	E8000/LS-DB	Lever Storeroom Lock	US10B	20	37	\$90.29
	• E8000/LSD-AL	I/C Core Lever Storeroom Lock (w/o IC Core)	US26D	20	37	\$90.29
	• E8000/LSD-DB	I/C Core Lever Storeroom Lock (w/o IC Core)	US10B	20	37	\$90.29
<p>Crossbore: 2-1/8"</p> 	Fit 1-3/8" to 1-3/4" door thickness. (Compatible with E7000, E5000, & E8000 Series Exit Devices)					
	E8000/LPA-AL	Lever Passage Lock	US26D	20	33	\$78.28
	E8000/LPA-DB	Lever Passage Lock	US10B	20	33	\$78.28
<p>Crossbore: 2-1/8"</p> 	Fit 1-3/8" to 1-3/4" door thickness. (Compatible with E7000, E5000, & E8000 Series Exit Devices)					
	E8000/D-AL	Lever Dummy Set	US26D	20	33	\$78.28
	E8000/D-DB	Lever Dummy Set	US10B	20	33	\$78.28
<p>Crossbore: 2-1/8"</p> 	Fit 1-3/8" to 1-3/4" door thickness. (Compatible with E7000, E5000, & E8000 Series Exit Devices)					
	E8000/K-AL	Knob Entry Lock	US26D	20	29	\$57.18
	E8000/K-DB	Knob Entry Lock	US10B	20	29	\$57.18
	• E8000/KD-AL	I/C Core Knob Entry Lock (w/o IC Core)	US26D	20	29	\$57.18
	• E8000/KD-DB	I/C Core Knob Entry Lock (w/o IC Core)	US10B	20	29	\$57.18

	Model #	Function	Finish	QTY /Case	Lbs /Case	List Price
	E7000V/38K-SS	Extension Kit for 8' High Door for E7000 Series	US32D	12	15	\$65.67
	E7000V/38K-AL	Extension Kit for 8' High Door for E7000 Series	US26D	12	15	\$46.90
	E7000V/38K-DB	Extension Kit for 8' High Door for E7000 Series	US10B	12	15	\$46.90
	E8000/NLS-AL	Pull and Rim Cylinder - Single Rim	US26D	12	16	\$46.73
	E8000/NLS-DB	Pull and Rim Cylinder - Single Rim	US10B	12	16	\$46.73
Crossbore: 1-5/16"						
	E8000/NL-AL	Pull and Rim Cylinder - Double Rim	US26D	12	6	\$52.43
	E8000/NL-DB	Pull and Rim Cylinder - Double Rim	US10B	12	6	\$52.43
Crossbore: 1-5/16"						
	E8000/EOP-AL	Cover Plate Only	US26D	12	6	\$13.54
	E8000/EOP-DB	Cover Plate Only	US10B	12	6	\$13.54
	E8000/DT-AL	Pull Plate Only	US26D	12	8	\$16.05
	E8000/DT-DB	Pull Plate Only	US10B	12	8	\$16.05
	1/8" Thickness					
	E8000/SK-AL	Shim Kit for E7000/E5000/E8000 Rim Type	US26D	50	10	\$7.66
	1/16" Thickness					
	E8000V/SK-AL	Shim Kit for E7000/E5000/E8000 Vertical Rod	US26D	50	10	\$15.35
	E4000/OLSP-AL	Overlapping Strike Plate	US26D	50	20	\$21.67
	E4000/OLSP-DB	Overlapping Strike Plate	US10B	50	20	\$21.67



Model #	Function	Finish	QTY /Case	Lbs /Case	List Price
(For E7000/L Entry)					
E7000/MCSC-AL	SC 6-pin Mortise Cylinder	US26D	40	30	\$37.32
E7000/MCSC-DB	SC 6-pin Mortise Cylinder	US10B	40	30	\$37.32
(For E7000/L Entry)					
E7000/MCKW-AL	KW 5-pin Mortise Cylinder	US26D	40	30	\$37.32
E7000/MCKW-DB	KW 5-pin Mortise Cylinder	US10B	40	30	\$37.32
(For E7000/LD Entry)					
• E7000/MCD-AL	I/C Core Mortise Cylinder (w/o IC Core)	US26D	40	30	\$65.33
• E7000/MCD-DB	I/C Core Mortise Cylinder (w/o IC Core)	US10B	40	30	\$65.33
(For E5000/L Entry)					
E5000/MC0SC-AL	SC 6-pin Mortise Cylinder	US26D	40	30	\$37.32
E5000/MC0SC-DB	SC 6-pin Mortise Cylinder	US10B	40	30	\$37.32
E5000/MC0KW-AL	KW 5-pin Mortise Cylinder	US26D	40	30	\$37.32
E5000/MC0KW-DB	KW 5-pin Mortise Cylinder	US10B	40	30	\$37.32
• E5000/MC0D-AL	I/C Core Mortise Cylinder (w/o IC Core)	US26D	40	30	\$65.33
• E5000/MC0D-DB	I/C Core Mortise Cylinder (w/o IC Core)	US10B	40	30	\$65.33





(For E5000/LS Storeroom)					
E5000/MC5SC-AL	SC 6-pin Mortise Cylinder	US26D	40	30	\$37.32
E5000/MC5SC-DB	SC 6-pin Mortise Cylinder	US10B	40	30	\$37.32
E5000/MC5KW-AL	KW 5-pin Mortise Cylinder	US26D	40	30	\$37.32
E5000/MC5KW-DB	KW 5-pin Mortise Cylinder	US10B	40	30	\$37.32
• E5000/MC5D-AL	I/C Core Mortise Cylinder (w/o IC Core)	US26D	40	30	\$65.33
• E5000/MC5D-DB	I/C Core Mortise Cylinder (w/o IC Core)	US10B	40	30	\$65.33

(For E7000/LS Storeroom)					
E7000/RCSC-AL	SC 6-pin Rim Cylinder	US26D	40	30	\$37.32
E7000/RCSC-DB	SC 6-pin Rim Cylinder	US10B	40	30	\$37.32
(For E7000/LS Storeroom)					
E7000/RCKW-AL	KW 5-pin Rim Cylinder	US26D	40	30	\$37.32
E7000/RCKW-DB	KW 5-pin Rim Cylinder	US10B	40	30	\$37.32
(For E7000/LSD Storeroom)					
• E7000/RCD-AL	I/C Core Rim Cylinder (w/o IC Core)	US26D	40	30	\$65.33
• E7000/RCD-DB	I/C Core Rim Cylinder (w/o IC Core)	US10B	40	30	\$65.33



(For E8000/NLS, E8000/NL)					
E8000/RCSC-AL	SC 6-pin Rim Cylinder	US26D	40	30	\$37.32
E8000/RCSC-DB	SC 6-pin Rim Cylinder	US10B	40	30	\$37.32
(For E8000/NLS, E8000/NL)					
E8000/RCKW-AL	KW 5-pin Rim Cylinder	US26D	40	30	\$37.32
E8000/RCKW-DB	KW 5-pin Rim Cylinder	US10B	40	30	\$37.32
(For E8000/NLS, E8000/NL)					
• E8000/RCD-AL	I/C Core Rim Cylinder (w/o IC Core)	US26D	40	30	\$65.33
• E8000/RCD-DB	I/C Core Rim Cylinder (w/o IC Core)	US10B	40	30	\$65.33

	Model #	Function	Finish	QTY /Case	Lbs /Case	List Price
	E4000/DC52-AL	Door Coordinator for 54"-98" Door Width	US26D	10	28	\$147.53
	E4000/DC60-AL	Door Coordinator for 97"-112" Door Width	US26D	10	30	\$162.61
	E4000/FB18-AL	Filler Bar, 18-5/8" for 72" Pair Door	US26D	10	6	\$21.23
	E4000/FB42-AL	Filler Bar, 42-5/8" for 96" Pair Door	US26D	10	6	\$47.77
	E4000/MB2	Mounting Bracket for Stop Width Over 2-1/4" (price per pair, sold per pair only)		25	48	\$60.00
	E4000/MB3	Mounting Bracket for Stop Width between 7/8"-2-1/4" (price per pair, sold per pair only)		25	48	\$77.42
	E4000/CB-DB	Carry Bar	US10B	50	22	\$34.40
	E4000/GDC7-AL	Gravity Door Coordinator 6-1/2" Projection	US26D	20	44	\$79.79
	E4000/GDC7-DB	Gravity Door Coordinator 6-1/2" Projection	US10B	20	44	\$79.79
	EF5000/AFL	Auxiliary Fire Bolt for Less Bottom Rod		50	16	\$62.73

	Model #	Function	Finish	QTY /Case	Lbs /Case	List Price
	(For Rim Device)					
	E8000/SB6-AL	Sex Nuts, Female Part Only (set of 6)	US26D	50	6	\$10.71
	E8000/SB6-DB	Sex Nuts, Female Part Only (set of 6)	US10B	50	6	\$10.71
	(For Top and Bottom Latch)					
	E8000/SB4-AL	Sex Nuts, Female Part Only (set of 4)	US26D	50	6	\$7.14
	E8000/SB4-DB	Sex Nuts, Female Part Only (set of 4)	US10B	50	6	\$7.14
	E8000/ASA-AL	Blank ASA Strike (4-7/8"x1-1/4")	US26D	50	10	\$12.13
	E8000/5SP-AL	Latch Hole Filler Plate (2-1/4"x1-1/8")	US26D	50	10	\$4.04
	E9000/TS-AL	Threshold Strike	US26D	20	10	\$12.49



E5000 SERIES -- Grade 1, Non Fire Rated

	Model #	Function	Finish	QTY /Case	Lbs /Case	List Price
	E5000/EO3-SS	Exit Only For Door 32" to 36" Wide	US32D	4	37	\$329.52
	E5000/EO3-AL	Exit Only For Door 32" to 36" Wide	US26D	4	37	\$235.37
	E5000/EO3-DB	Exit Only For Door 32" to 36" Wide	US10B	4	37	\$235.37
	E5000/EO3-BL	Exit Only For Door 32" to 36" Wide	US19	4	37	\$235.37
	E5000/EO4-SS	Exit Only For Door 44" to 48" Wide	US32D	4	37	\$362.50
	E5000/EO4-AL	Exit Only For Door 44" to 48" Wide	US26D	4	37	\$258.93
	E5000/EO4-DB	Exit Only For Door 44" to 48" Wide	US10B	4	37	\$258.93
	E5000/EO4-BL	Exit Only For Door 44" to 48" Wide	US19	4	37	\$258.93

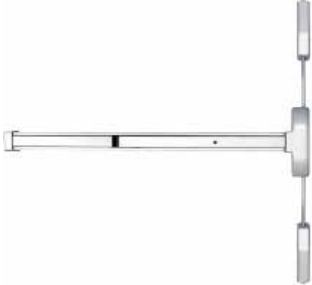
VERTICAL ROD







	E5000V/EO3X7-SS	Surface Vertical Rod 36" x 84" (WxH)	US32D	2	29	\$491.18
	E5000V/EO3X7-AL	Surface Vertical Rod 36" x 84" (WxH)	US26D	2	29	\$409.31
	E5000V/EO3X7-DB	Surface Vertical Rod 36" x 84" (WxH)	US10B	2	29	\$409.31
	E5000V/EO3X7-BL	Surface Vertical Rod 36" x 84" (WxH)	US19	2	29	\$409.31
	E5000V/EO3X8-SS	Surface Vertical Rod 36" x 96" (WxH)	US32D	2	29	\$515.72
	E5000V/EO3X8-AL	Surface Vertical Rod 36" x 96" (WxH)	US26D	2	29	\$429.79
	E5000V/EO3X8-DB	Surface Vertical Rod 36" x 96" (WxH)	US10B	2	29	\$429.79
	E5000V/EO3X8-BL	Surface Vertical Rod 36" x 96" (WxH)	US19	2	29	\$429.79
	E5000V/EO4X8-SS	Surface Vertical Rod 48" x 96" (WxH)	US32D	2	33	\$540.29
	E5000V/EO4X8-AL	Surface Vertical Rod 48" x 96" (WxH)	US26D	2	33	\$450.23
	E5000V/EO4X8-DB	Surface Vertical Rod 48" x 96" (WxH)	US10B	2	33	\$450.23
	E5000V/EO4X8-BL	Surface Vertical Rod 48" x 96" (WxH)	US19	2	33	\$450.23

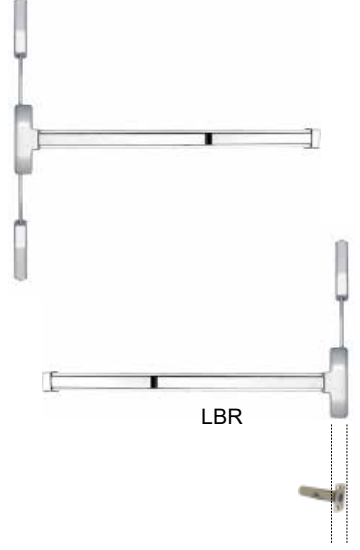





EF5000 SERIES -- Grade 1, 1-1/2 Hours UL Fire Rated









	Model #	Function	Finish	QTY /Case	Lbs /Case	List Price
 	EF5000/EO3-SS	Exit Only For Door 32" to 36" Wide	US32D	4	37	\$443.98
	EF5000/EO3-AL	Exit Only For Door 32" to 36" Wide	US26D	4	37	\$317.14
	EF5000/EO3-DB	Exit Only For Door 32" to 36" Wide	US10B	4	37	\$317.14
	EF5000/EO3-BL	Exit Only For Door 32" to 36" Wide	US19	4	37	\$317.14
	EF5000/EO4-SS	Exit Only For Door 44" to 48" Wide	US32D	4	47	\$488.38
	EF5000/EO4-AL	Exit Only For Door 44" to 48" Wide	US26D	4	47	\$348.84
	EF5000/EO4-DB	Exit Only For Door 44" to 48" Wide	US10B	4	47	\$348.84
	EF5000/EO4-BL	Exit Only For Door 44" to 48" Wide	US19	4	47	\$348.84

VERTICAL ROD

 	EF5000V/EO3X7-SS	Surface Vertical Rod 36" x 84" (WxH)	US32D	2	29	\$643.32	
	EF5000V/EO3X7-AL	Surface Vertical Rod 36" x 84" (WxH)	US26D	2	29	\$494.86	
	EF5000V/EO3X7-DB	Surface Vertical Rod 36" x 84" (WxH)	US10B	2	29	\$494.86	
	EF5000V/EO3X7-BL	Surface Vertical Rod 36" x 84" (WxH)	US19	2	29	\$494.86	
	EF5000V/EO3X8-SS	Surface Vertical Rod 36" x 96" (WxH)	US32D	2	29	\$675.49	
	EF5000V/EO3X8-AL	Surface Vertical Rod 36" x 96" (WxH)	US26D	2	29	\$519.62	
	EF5000V/EO3X8-DB	Surface Vertical Rod 36" x 96" (WxH)	US10B	2	29	\$519.62	
	EF5000V/EO3X8-BL	Surface Vertical Rod 36" x 96" (WxH)	US19	2	29	\$519.62	
	EF5000V/EO4X8-SS	Surface Vertical Rod 48" x 96" (WxH)	US32D	2	33	\$707.65	
	EF5000V/EO4X8-AL	Surface Vertical Rod 48" x 96" (WxH)	US26D	2	33	\$544.36	
	EF5000V/EO4X8-DB	Surface Vertical Rod 48" x 96" (WxH)	US10B	2	33	\$544.36	
	EF5000V/EO4X8-BL	Surface Vertical Rod 48" x 96" (WxH)	US19	2	33	\$544.36	
	Less Bottom Rod with Auxiliary Fire Bolt						
	EF5000V/LBR37-SS	LBR Vertical Rod 36" x 84" (WxH)	US32D	2	25	\$643.32	
	EF5000V/LBR37-AL	LBR Vertical Rod 36" x 84" (WxH)	US26D	2	25	\$494.86	
	EF5000V/LBR37-DB	LBR Vertical Rod 36" x 84" (WxH)	US10B	2	25	\$494.86	
	EF5000V/LBR37-BL	LBR Vertical Rod 36" x 84" (WxH)	US19	2	25	\$494.86	
	EF5000V/LBR38-SS	LBR Vertical Rod 36" x 96" (WxH)	US32D	2	25	\$675.49	
	EF5000V/LBR38-AL	LBR Vertical Rod 36" x 96" (WxH)	US26D	2	25	\$519.62	
	EF5000V/LBR38-DB	LBR Vertical Rod 36" x 96" (WxH)	US10B	2	25	\$519.62	
EF5000V/LBR38-BL	LBR Vertical Rod 36" x 96" (WxH)	US19	2	25	\$519.62		
EF5000V/LBR48-SS	LBR Vertical Rod 48" x 96" (WxH)	US32D	2	29	\$707.65		
EF5000V/LBR48-AL	LBR Vertical Rod 48" x 96" (WxH)	US26D	2	29	\$544.36		
EF5000V/LBR48-DB	LBR Vertical Rod 48" x 96" (WxH)	US10B	2	29	\$544.36		
EF5000V/LBR48-BL	LBR Vertical Rod 48" x 96" (WxH)	US19	2	29	\$544.36		

	Model #	Function	Finish	QTY /Case	Lbs /Case	List Price
Reversible 	Fit 1-3/4" to 2" door thickness. (Compatible with E7000 & E5000 Series Exit Devices)					
	E5000/L-AL	Heavy Duty Lever Entry Lock	US26D	8	39	\$294.96
	E5000/L-DB	Heavy Duty Lever Entry Lock	US10B	8	39	\$294.96
	E5000/L-BL	Heavy Duty Lever Entry Lock	US19	8	39	\$294.96
	E5000/LD-AL	I/C Core HD Lever Entry Lock (w/o IC Core)	US26D	8	39	\$294.96
	E5000/LD-DB	I/C Core HD Lever Entry Lock (w/o IC Core)	US10B	8	39	\$294.96
	E5000/LD-BL	I/C Core HD Lever Entry Lock (w/o IC Core)	US19	8	39	\$294.96
Reversible 	Fit 1-3/4" to 2" door thickness. (Compatible with E7000 & E5000 Series Exit Devices)					
	E5000/LS-AL	Heavy Duty Lever Storeroom Lock	US26D	8	39	\$294.96
	E5000/LS-DB	Heavy Duty Lever Storeroom Lock	US10B	8	39	\$294.96
	E5000/LS-BL	Heavy Duty Lever Storeroom Lock	US19	8	39	\$294.96
	E5000/LSD-AL	I/C Core HD Lever Storeroom Lock (w/o IC Core)	US26D	8	39	\$294.96
	E5000/LSD-DB	I/C Core HD Lever Storeroom Lock (w/o IC Core)	US10B	8	39	\$294.96
	E5000/LSD-BL	I/C Core HD Lever Storeroom Lock (w/o IC Core)	US19	8	39	\$294.96
Reversible 	Fit 1-3/4" to 2" door thickness. (Compatible with E7000 & E5000 Series Exit Devices)					
	E5000/LPA-AL	Heavy Duty Lever Passage Lock	US26D	8	35	\$255.66
	E5000/LPA-DB	Heavy Duty Lever Passage Lock	US10B	8	35	\$255.66
	E5000/LPA-BL	Heavy Duty Lever Passage Lock	US19	8	35	\$255.66
	E5000/D-AL	Heavy Duty Lever Dummy Set	US26D	8	35	\$255.66
	E5000/D-DB	Heavy Duty Lever Dummy Set	US10B	8	35	\$255.66
	E5000/D-BL	Heavy Duty Lever Dummy Set	US19	8	35	\$255.66
	Fit 1-3/4" to 2-1/4" door thickness. (Compatible with E7000 & E5000 Series Exit Devices)					
	E7000/L-AL	Thumb Piece Entry	US26D	10	37	\$168.54
	E7000/L-DB	Thumb Piece Entry	US10B	10	37	\$168.54
	E7000/LD-AL	I/C Core Thumb Piece Entry (w/o IC Core)	US26D	10	37	\$168.54
	E7000/LD-DB	I/C Core Thumb Piece Entry (w/o IC Core)	US10B	10	37	\$168.54
	Fit 1-3/4" to 2-1/4" door thickness. (Compatible with E7000 & E5000 Series Exit Devices)					
	E7000/LS-AL	Storeroom	US26D	10	37	\$152.80
	E7000/LS-DB	Storeroom	US10B	10	37	\$152.80
	E7000/LSD-AL	I/C Core Storeroom (w/o IC Core)	US26D	10	37	\$152.80
	E7000/LSD-DB	I/C Core Storeroom (w/o IC Core)	US10B	10	37	\$152.80
	Fit 1-3/4" to 2-1/4" door thickness. (Compatible with E7000 & E5000 Series Exit Devices)					
	E7000/PA-AL	Thumb Piece Passage	US26D	10	33	\$126.80
	E7000/PA-DB	Thumb Piece Passage	US10B	10	33	\$126.80





Model #	Function	Finish	QTY /Case	Lbs /Case	List Price
Fit 1-3/4" to 2-1/4" door thickness. (Compatible with E7000 & E5000 Series Exit Devices)					
	E7000/D-AL Dummy Trim	US26D	20	33	\$96.48
	E7000/D-DB Dummy Trim	US10B	20	33	\$96.48
Crossbore: 2-1/8"					
Fit 1-3/8" to 1-3/4" door thickness. (Compatible with E7000, E5000, & E8000 Series Exit Devices)					
	E8000/L-AL Lever Entry Lock	US26D	20	37	\$90.29
	E8000/L-DB Lever Entry Lock	US10B	20	37	\$90.29
	E8000/L-BL Lever Entry Lock (ETA: 09/22)	US19	20	37	\$90.29
	• E8000/LD-AL I/C Core Lever Entry Lock (w/o IC Core)	US26D	20	37	\$90.29
	• E8000/LD-DB I/C Core Lever Entry Lock (w/o IC Core)	US10B	20	37	\$90.29
	• E8000/LD-BL I/C Core Lever Entry Lock (w/o IC Core) (ETA: 09/22)	US19	20	37	\$90.29
Crossbore: 2-1/8"					
Fit 1-3/8" to 1-3/4" door thickness. (Compatible with E7000, E5000, & E8000 Series Exit Devices)					
	E8000/LS-AL Lever Storeroom Lock	US26D	20	37	\$90.29
	E8000/LS-DB Lever Storeroom Lock	US10B	20	37	\$90.29
	E8000/LS-BL Lever Storeroom Lock (ETA: 09/22)	US19	20	37	\$90.29
	• E8000/LSD-AL I/C Core Lever Storeroom Lock (w/o IC Core)	US26D	20	37	\$90.29
	• E8000/LSD-DB I/C Core Lever Storeroom Lock (w/o IC Core)	US10B	20	37	\$90.29
	• E8000/LSD-BL I/C Core Lever Storeroom Lock (w/o IC Core) (ETA: 09/22)	US19	20	37	\$90.29
Crossbore: 2-1/8"					
Fit 1-3/8" to 1-3/4" door thickness. (Compatible with E7000, E5000, & E8000 Series Exit Devices)					
	E8000/LPA-AL Lever Passage Lock	US26D	20	33	\$78.28
	E8000/LPA-DB Lever Passage Lock	US10B	20	33	\$78.28
	E8000/LPA-BL Lever Passage Lock (ETA: 09/22)	US19	20	33	\$78.28
Crossbore: 2-1/8"					
Fit 1-3/8" to 1-3/4" door thickness. (Compatible with E7000, E5000, & E8000 Series Exit Devices)					
	E8000/D-AL Lever Dummy Set	US26D	20	33	\$78.28
	E8000/D-DB Lever Dummy Set	US10B	20	33	\$78.28
	E8000/D-BL Lever Dummy Set (ETA: 09/22)	US19	20	33	\$78.28
Crossbore: 2-1/8"					
Fit 1-3/8" to 1-3/4" door thickness. (Compatible with E7000, E5000, & E8000 Series Exit Devices)					
	E8000/K-AL Knob Entry Lock	US26D	20	29	\$57.18
	E8000/K-DB Knob Entry Lock	US10B	20	29	\$57.18
	• E8000/KD-AL I/C Core Knob Entry Lock (w/o IC Core)	US26D	20	29	\$57.18
	• E8000/KD-DB I/C Core Knob Entry Lock (w/o IC Core)	US10B	20	29	\$57.18

	Model #	Function	Finish	QTY /Case	Lbs /Case	List Price
	E5000V/38K-SS	Extension Kit for 8' High Door for E5000 Series	US32D	12	15	\$65.67
	E5000V/38K-AL	Extension Kit for 8' High Door for E5000 Series	US26D	12	15	\$46.90
	E5000V/38K-DB	Extension Kit for 8' High Door for E5000 Series	US10B	12	15	\$46.90
	E5000V/38K-BL	Extension Kit for 8' High Door for E5000 Series	US19	12	15	\$46.90
Fit 1-3/8" to 1-3/4" door thickness. (Compatible with E7000, E5000, & E8000 Series Exit Devices)						
	E8000/NLS-AL	Pull and Rim Cylinder - Single Rim	US26D	12	16	\$46.73
	E8000/NLS-DB	Pull and Rim Cylinder - Single Rim	US10B	12	16	\$46.73
	E8000/NLS-BL	Pull and Rim Cylinder - Single Rim (ETA: 09/22)	US19	12	16	\$46.73
Crossbore: 1-5/16"						
Fit 1-3/8" to 1-3/4" door thickness. (Compatible with E7000, E5000, & E8000 Series Exit Devices)						
	E8000/NL-AL	Pull and Rim Cylinder - Double Rim	US26D	12	6	\$52.43
	E8000/NL-DB	Pull and Rim Cylinder - Double Rim	US10B	12	6	\$52.43
	E8000/NL-BL	Pull and Rim Cylinder - Double Rim (ETA: 09/22)	US19	12	6	\$52.43
Crossbore: 1-5/16"						
	E8000/EOP-AL	Cover Plate Only	US26D	12	6	\$13.54
	E8000/EOP-DB	Cover Plate Only	US10B	12	6	\$13.54
	E8000/EOP-BL	Cover Plate Only (ETA: 09/22)	US19	12	6	\$13.54
	E8000/DT-AL	Pull Plate Only	US26D	12	8	\$16.05
	E8000/DT-DB	Pull Plate Only	US10B	12	8	\$16.05
	E8000/DT-BL	Pull Plate Only (ETA: 09/22)	US19	12	8	\$16.05
	1/8" Thickness					
	E8000/SK-AL	Shim Kit for E7000/E5000/E8000 Rim Type	US26D	50	10	\$7.66
	1/16" Thickness					
	E8000V/SK-AL	Shim Kit for E7000/E5000/E8000 Vertical Rod	US26D	50	10	\$15.35
	E4000/OLSP-AL	Overlapping Strike Plate	US26D	50	20	\$21.67
	E4000/OLSP-DB	Overlapping Strike Plate	US10B	50	20	\$21.67
	E4000/OLSP-BL	Overlapping Strike Plate (ETA: 09/22)	US19	50	20	\$21.67

Model #	Function	Finish	QTY /Case	Lbs /Case	List Price
(For E7000/L Entry)					
E7000/MCSC-AL	SC 6-pin Mortise Cylinder	US26D	40	30	\$37.32
E7000/MCSC-DB	SC 6-pin Mortise Cylinder	US10B	40	30	\$37.32
(For E7000/L Entry)					
E7000/MCKW-AL	KW 5-pin Mortise Cylinder	US26D	40	30	\$37.32
E7000/MCKW-DB	KW 5-pin Mortise Cylinder	US10B	40	30	\$37.32
(For E7000/LD Entry)					
• E7000/MCD-AL	I/C Core Mortise Cylinder (w/o IC Core)	US26D	40	30	\$65.33
• E7000/MCD-DB	I/C Core Mortise Cylinder (w/o IC Core)	US10B	40	30	\$65.33
(For E5000/L Entry)					
E5000/MC0SC-AL	SC 6-pin Mortise Cylinder	US26D	40	30	\$37.32
E5000/MC0SC-DB	SC 6-pin Mortise Cylinder	US10B	40	30	\$37.32
E5000/MC0SC-BL	SC 6-pin Mortise Cylinder	US19	40	30	\$37.32
E5000/MC0KW-AL	KW 5-pin Mortise Cylinder	US26D	40	30	\$37.32
E5000/MC0KW-DB	KW 5-pin Mortise Cylinder	US10B	40	30	\$37.32
E5000/MC0KW-BL	KW 5-pin Mortise Cylinder	US19	40	30	\$37.32
• E5000/MC0D-AL	I/C Core Mortise Cylinder (w/o IC Core)	US26D	40	30	\$65.33
• E5000/MC0D-DB	I/C Core Mortise Cylinder (w/o IC Core)	US10B	40	30	\$65.33
• E5000/MC0D-BL	I/C Core Mortise Cylinder (w/o IC Core)	US19	40	30	\$65.33
(For E5000/LS Storeroom)					
E5000/MC5SC-AL	SC 6-pin Mortise Cylinder	US26D	40	30	\$37.32
E5000/MC5SC-DB	SC 6-pin Mortise Cylinder	US10B	40	30	\$37.32
E5000/MC5SC-BL	SC 6-pin Mortise Cylinder	US19	40	30	\$37.32
E5000/MC5KW-AL	KW 5-pin Mortise Cylinder	US26D	40	30	\$37.32
E5000/MC5KW-DB	KW 5-pin Mortise Cylinder	US10B	40	30	\$37.32
E5000/MC5KW-BL	KW 5-pin Mortise Cylinder	US19	40	30	\$37.32
• E5000/MC5D-AL	I/C Core Mortise Cylinder (w/o IC Core)	US26D	40	30	\$65.33
• E5000/MC5D-DB	I/C Core Mortise Cylinder (w/o IC Core)	US10B	40	30	\$65.33
• E5000/MC5D-BL	I/C Core Mortise Cylinder (w/o IC Core)	US19	40	30	\$65.33
(For E7000/LS Storeroom)					
E7000/RCSC-AL	SC 6-pin Rim Cylinder	US26D	40	30	\$37.32
E7000/RCSC-DB	SC 6-pin Rim Cylinder	US10B	40	30	\$37.32
(For E7000/LS Storeroom)					
E7000/RCKW-AL	KW 5-pin Rim Cylinder	US26D	40	30	\$37.32
E7000/RCKW-DB	KW 5-pin Rim Cylinder	US10B	40	30	\$37.32
(For E7000/LSD Storeroom)					
• E7000/RCD-AL	I/C Core Rim Cylinder (w/o IC Core)	US26D	40	30	\$65.33
• E7000/RCD-DB	I/C Core Rim Cylinder (w/o IC Core)	US10B	40	30	\$65.33
(For E8000/NLS, E8000/NL)					
E8000/RCSC-AL	SC 6-pin Rim Cylinder	US26D	40	30	\$37.32
E8000/RCSC-DB	SC 6-pin Rim Cylinder	US10B	40	30	\$37.32
(For E8000/NLS, E8000/NL)					
E8000/RCKW-AL	KW 5-pin Rim Cylinder	US26D	40	30	\$37.32
E8000/RCKW-DB	KW 5-pin Rim Cylinder	US10B	40	30	\$37.32
(For E8000/NLS, E8000/NL)					
• E8000/RCD-AL	I/C Core Rim Cylinder (w/o IC Core)	US26D	40	30	\$65.33
• E8000/RCD-DB	I/C Core Rim Cylinder (w/o IC Core)	US10B	40	30	\$65.33



	Model #	Function	Finish	QTY /Case	Lbs /Case	List Price
	E4000/DC52-AL	Door Coordinator for 54"-98" Door Width	US26D	10	28	\$147.53
	E4000/DC60-AL	Door Coordinator for 97"-112" Door Width	US26D	10	30	\$162.61
	E4000/FB18-AL	Filler Bar, 18-5/8" for 72" Pair Door	US26D	10	6	\$21.23
	E4000/FB42-AL	Filler Bar, 42-5/8" for 96" Pair Door	US26D	10	6	\$47.77
	E4000/MB2	Mounting Bracket for Stop Width Over 2-1/4" (price per pair, sold per pair only)		25	48	\$60.00
	E4000/MB3	Mounting Bracket for Stop Width between 7/8"-2-1/4" (price per pair, sold per pair only)		25	48	\$77.42
	E4000/CB-DB	Carry Bar	US10B	50	22	\$34.40
	E4000/GDC7-AL	Gravity Door Coordinator 6-1/2" Projection	US26D	20	44	\$79.79
	E4000/GDC7-DB	Gravity Door Coordinator 6-1/2" Projection	US10B	20	44	\$79.79
	EF5000/AFL	Auxiliary Fire Bolt for Less Bottom Rod		50	16	\$62.73

	Model #	Function	Finish	QTY /Case	Lbs /Case	List Price
	(For Rim Device)					
	E8000/SB6-AL	Sex Nuts, Female Part Only (set of 6)	US26D	50	6	\$10.71
	E8000/SB6-DB	Sex Nuts, Female Part Only (set of 6)	US10B	50	6	\$10.71
	E8000/SB6-GB	Sex Nuts, Female Part Only (set of 6)	US4	50	6	\$10.71
	E8000/SB6-BL	Sex Nuts, Female Part Only (set of 6)	US19	50	6	\$10.71
	(For Top and Bottom Latch)					
	E8000/SB4-AL	Sex Nuts, Female Part Only (set of 4)	US26D	50	6	\$7.14
	E8000/SB4-DB	Sex Nuts, Female Part Only (set of 4)	US10B	50	6	\$7.14
	E8000/SB4-GB	Sex Nuts, Female Part Only (set of 4)	US4	50	6	\$7.14
	E8000/SB4-BL	Sex Nuts, Female Part Only (set of 4)	US19	50	6	\$7.14
	E8000/ASA-AL	Blank ASA Strike (4-7/8"x1-1/4")	US26D	50	10	\$12.13
	E8000/5SP-AL	Latch Hole Filler Plate (2-1/4"x1-1/8")	US26D	50	10	\$4.04
	E9000/TS-AL	Threshold Strike	US26D	20	10	\$12.49



E8000 SERIES -- Grade 2, Non Fire Rated

	Model #	Function	Finish	QTY /Case	Lbs /Case	List Price
	E8000/EO3-AL	Exit Only For Door 32" to 36" Wide	US26D	6	45	\$219.22
	E8000/EO3-DB	Exit Only For Door 32" to 36" Wide	US10B	6	45	\$219.22
	E8000/EO3-PB	Exit Only For Door 32" to 36" Wide	US3	6	45	\$315.60



VERTICAL ROD







	E8000V/EO3X7-AL	Surface Vertical Rod 36" x 84" (WxH)	US26D	4	56	\$381.24
	E8000V/EO3X7-DB	Surface Vertical Rod 36" x 84" (WxH)	US10B	4	56	\$381.24
	E8000V/EO3X7-PB	Surface Vertical Rod 36" x 84" (WxH)	US3	4	56	\$543.40
	E8000V/EO3X8-AL	Surface Vertical Rod 36" x 96" (WxH)	US26D	4	56	\$428.96
	E8000V/EO3X8-DB	Surface Vertical Rod 36" x 96" (WxH)	US10B	4	56	\$428.96
	E8000V/EO3X8-PB	Surface Vertical Rod 36" x 96" (WxH)	US3	4	56	\$609.70

EF8000 SERIES -- Grade 2, 1-1/2 Hours UL Fire Rated

	Model #	Function	Finish	QTY /Case	Lbs /Case	List Price
 	EF8000/EO3-AL	Exit Only For Door 32" to 36" Wide	US26D	6	50	\$248.74
	EF8000/EO3-DB	Exit Only For Door 32" to 36" Wide	US10B	6	50	\$248.74
	EF8000/EO3-PB	Exit Only For Door 32" to 36" Wide	US3	6	50	\$348.20

VERTICAL ROD

 	EF8000V/EO3X7-AL	Surface Vertical Rod 36" x 84" (WxH)	US26D	4	56	\$460.92
	EF8000V/EO3X7-DB	Surface Vertical Rod 36" x 84" (WxH)	US10B	4	56	\$460.92
	EF8000V/EO3X7-PB	Surface Vertical Rod 36" x 84" (WxH)	US3	4	56	\$637.02
	EF8000V/EO3X8-AL	Surface Vertical Rod 36" x 96" (WxH)	US26D	4	56	\$510.18
	EF8000V/EO3X8-DB	Surface Vertical Rod 36" x 96" (WxH)	US10B	4	56	\$510.18
	EF8000V/EO3X8-PB	Surface Vertical Rod 36" x 96" (WxH)	US3	4	56	\$702.36

	Model #	Function	Finish	QTY /Case	Lbs /Case	List Price
<p>Crossbore: 2-1/8"</p> 	Fit 1-3/8" to 1-3/4" door thickness. (Compatible with E7000, E5000, & E8000 Series Exit Devices)					
	E8000/L-AL	Lever Entry Lock	US26D	20	37	\$90.29
	E8000/L-DB	Lever Entry Lock	US10B	20	37	\$90.29
	E8000/L-PB	Lever Entry Lock	US3	20	37	\$115.05
	• E8000/LD-AL	I/C Core Lever Entry Lock (w/o IC Core)	US26D	20	37	\$90.29
	• E8000/LD-DB	I/C Core Lever Entry Lock (w/o IC Core)	US10B	20	37	\$90.29
<p>Crossbore: 2-1/8"</p> 	Fit 1-3/8" to 1-3/4" door thickness. (Compatible with E7000, E5000, & E8000 Series Exit Devices)					
	E8000/LS-AL	Lever Storeroom Lock	US26D	20	37	\$90.29
	E8000/LS-DB	Lever Storeroom Lock	US10B	20	37	\$90.29
	E8000/LS-PB	Lever Storeroom Lock	US3	20	37	\$115.05
	• E8000/LSD-AL	I/C Core Lever Storeroom Lock (w/o IC Core)	US26D	20	37	\$90.29
	• E8000/LSD-DB	I/C Core Lever Storeroom Lock (w/o IC Core)	US10B	20	37	\$90.29
<p>Crossbore: 2-1/8"</p> 	Fit 1-3/8" to 1-3/4" door thickness. (Compatible with E7000, E5000, & E8000 Series Exit Devices)					
	E8000/LPA-AL	Lever Passage Lock	US26D	20	33	\$78.28
	E8000/LPA-DB	Lever Passage Lock	US10B	20	33	\$78.28
	E8000/LPA-PB	Lever Passage Lock	US3	20	33	\$91.56
<p>Crossbore: 2-1/8"</p> 	Fit 1-3/8" to 1-3/4" door thickness. (Compatible with E7000, E5000, & E8000 Series Exit Devices)					
	E8000/D-AL	Lever Dummy Trim	US26D	20	33	\$78.28
	E8000/D-DB	Lever Dummy Trim	US10B	20	33	\$78.28
<p>Crossbore: 2-1/8"</p> 	Fit 1-3/8" to 1-3/4" door thickness. (Compatible with E7000, E5000, & E8000 Series Exit Devices)					
	E8000/K-AL	Knob Entry Lock	US26D	20	29	\$57.18
	E8000/K-DB	Knob Entry Lock	US10B	20	29	\$57.18
	E8000/K-PB	Knob Entry Lock	US3	20	29	\$69.56
	• E8000/KD-AL	I/C Core Knob Entry Lock (w/o IC Core)	US26D	20	29	\$57.18
	• E8000/KD-DB	I/C Core Knob Entry Lock (w/o IC Core)	US10B	20	29	\$57.18
	E8000V/38K-AL	Extension Kit for 8' High Door	US26D	12	15	\$51.48
	E8000V/38K-DB	Extension Kit for 8' High Door	US10B	12	15	\$51.48
	E8000V/38K-PB	Extension Kit for 8' High Door	US3	12	15	\$68.63

Crossbore: 1-5/16"



Model #	Function	Finish	QTY /Case	Lbs /Case	List Price
E8000/NLS-AL	Pull and Rim Cylinder - Single Rim	US26D	12	16	\$46.73
E8000/NLS-DB	Pull and Rim Cylinder - Single Rim	US10B	12	16	\$46.73
E8000/NLS-GB	Pull and Rim Cylinder - Single Rim	US4	12	16	\$46.73

Crossbore: 1-5/16"



E8000/NL-AL	Pull and Rim Cylinder - Double Rim	US26D	12	6	\$52.43
E8000/NL-DB	Pull and Rim Cylinder - Double Rim	US10B	12	6	\$52.43
E8000/NL-GB	Pull and Rim Cylinder - Double Rim	US4	12	6	\$52.43

(For E8000/NLS, E8000/NL)



E8000/RCSC-AL	SC 6-pin Rim Cylinder	US26D	40	30	\$37.32
E8000/RCSC-DB	SC 6-pin Rim Cylinder	US10B	40	30	\$37.32
E8000/RCSC-GB	SC 6-pin Rim Cylinder	US4	40	30	\$37.32

(For E8000/NLS, E8000/NL)

E8000/RCKW-AL	KW 5-pin Rim Cylinder	US26D	40	30	\$37.32
E8000/RCKW-DB	KW 5-pin Rim Cylinder	US10B	40	30	\$37.32
E8000/RCKW-GB	KW 5-pin Rim Cylinder	US4	40	30	\$37.32

(For E8000/NLS, E8000/NL)

E8000/RCD-AL	I/C Core Rim Cylinder (w/o IC Core)	US26D	40	30	\$65.33
E8000/RCD-DB	I/C Core Rim Cylinder (w/o IC Core)	US10B	40	30	\$65.33
E8000/RCD-GB	I/C Core Rim Cylinder (w/o IC Core)	US4	40	30	\$65.33



E8000/EOP-AL	Cover Plate Only	US26D	12	6	\$13.54
E8000/EOP-DB	Cover Plate Only	US10B	12	6	\$13.54
E8000/EOP-GB	Cover Plate Only	US4	12	6	\$13.54



E8000/DT-AL	Pull Plate Only	US26D	12	8	\$16.05
E8000/DT-DB	Pull Plate Only	US10B	12	8	\$16.05
E8000/DT-GB	Pull Plate Only	US4	12	8	\$16.05

1/8" Thickness



E8000/SK-AL	Shim Kit for E7000/E5000/E8000 Rim Type	US26D	50	10	\$7.66
--------------------	---	-------	----	----	--------

1/16" Thickness













E8000V/SK-AL	Shim Kit for E7000/E5000/E8000 Vertical Rod	US26D	50	10	\$15.35
---------------------	---	-------	----	----	---------







E4000/OLSP-AL	Overlapping Strike Plate	US26D	50	20	\$21.67
E4000/OLSP-DB	Overlapping Strike Plate	US10B	50	20	\$21.67



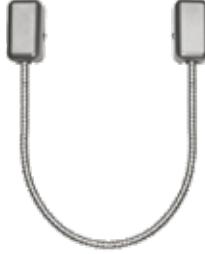

	Model #	Function	Finish	QTY /Case	Lbs /Case	List Price
	E4000/DC52-AL	Door Coordinator for 54"-98" Door Width	US26D	10	28	\$147.53
	E4000/DC60-AL	Door Coordinator for 97"-112" Door Width	US26D	10	30	\$162.61
	E4000/FB18-AL	Filler Bar, 18-5/8" for 72" Pair Door	US26D	10	6	\$21.23
	E4000/FB42-AL	Filler Bar, 42-5/8" for 96" Pair Door	US26D	10	6	\$47.77
	E4000/MB2	Mounting Bracket for Stop Width Over 2-1/4" (price per pair, sold per pair only)		25	48	\$54.15
	E4000/MB3	Mounting Bracket for Stop Width between 7/8"-2-1/4" (price per pair, sold per pair only)		25	48	\$77.42
	E4000/CB-DB	Carry Bar	US10B	50	22	\$34.40
	E4000/GDC7-AL	Gravity Door Coordinator 6-1/2" Projection	US26D	20	44	\$79.79
	E4000/GDC7-DB	Gravity Door Coordinator 6-1/2" Projection	US10B	20	44	\$79.79
	EF5000/AFL	Auxiliary Fire Bolt for Less Bottom Rod		50	16	\$62.73

	Model #	Function	Finish	QTY /Case	Lbs /Case	List Price
	(For Rim Device)					
	E8000/SB6-AL	Sex Nuts, Female Part Only (set of 6)	US26D	50	6	\$10.71
	E8000/SB6-DB	Sex Nuts, Female Part Only (set of 6)	US10B	50	6	\$10.71
	E8000/SB6-GB	Sex Nuts, Female Part Only (set of 6)	US4	50	6	\$10.71
	(For Top and Bottom Latch)					
	E8000/SB4-AL	Sex Nuts, Female Part Only (set of 4)	US26D	50	6	\$7.14
	E8000/SB4-DB	Sex Nuts, Female Part Only (set of 4)	US10B	50	6	\$7.14
	E8000/SB4-GB	Sex Nuts, Female Part Only (set of 4)	US4	50	6	\$7.14
	E8000/ASA-AL	Blank ASA Strike (4-7/8"x1-1/4")	US26D	50	10	\$12.13
	E8000/5SP-AL	Latch Hole Filler Plate (2-1/4"x1-1/8")	US26D	50	10	\$4.04
	E9000/TS-AL	Threshold Strike	US26D	20	10	\$12.49





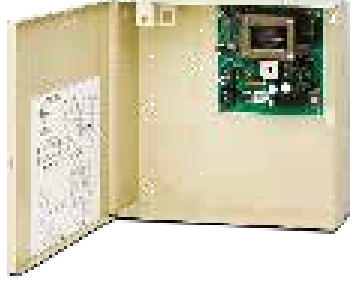







Model #	Function	Finish	QTY /Case	Lbs /Case	List Price	
	Non-Fire Rated Removable					
	E9000/RM7	7' Non-Fire Removable Mullion	USP	1	30	\$812.78
	E9000/RM8	8' Non-Fire Removable Mullion	USP	1	32	\$812.78
 	UL Rated Removable					
	EF9000/RM7	7' UL Removable Mullion	USP	1	30	\$1,015.97
	EF9000/RM8	8' UL Removable Mullion	USP	1	32	\$1,015.97
	Non-Fire Rated Keyed Removable					
	E9000/KRM7	7' Non-Fire Keyed Removable Mullion	USP	1	30	\$893.05
	E9000/KRM8	8' Non-Fire Keyed Removable Mullion	USP	1	32	\$893.05
	E9000/KRMD7	7' Non-Fire I/C Core Removable Mullion	USP	1	30	\$893.05
	E9000/KRMD8	8' Non-Fire I/C Core Removable Mullion	USP	1	32	\$893.05
 	UL Rated Keyed Removable					
	EF9000/KRM7	7' UL Keyed Removable Mullion	USP	1	30	\$1,116.31
	EF9000/KRM8	8' UL Keyed Removable Mullion	USP	1	32	\$1,116.31
	EF9000/KRMD7	7' UL I/C Core Removable Mullion	USP	1	30	\$1,116.31
	EF9000/KRMD8	8' UL I/C Core Removable Mullion	USP	1	32	\$1,116.31
 	Must order for use with fire-rated Mullion & Rim Device to meet fire code (sold separately)					
	EF9000/MRS	Mullion Rim Strike	USP	20	10	\$22.58
	EF9000/MSH	Strike Hook	USP	20	10	\$22.58





	Model #	Function	Finish	List Price
	ES-100SS	Electric Strike for Latch Throw up to 5/8", Field Selectable, 12 & 24 VDC	US32D	\$333.88
 	ES-200SS	UL Listed Electric Strike for Latch Throw up to 3/4", Field Selectable, 12 & 24 VDC	US32D	\$421.89
	ES-200OB	UL Listed Electric Strike for Latch Throw up to 3/4", Field Selectable, 12 & 24 VDC	US10B	\$493.11
	ES-200FSS	UL Fire Rated Electric Strike for Latch Throw up to 3/4", Field Selectable, 12 & 24 VDC	US32D	\$981.54
	ES-200FOB	UL Fire Rated Electric Strike for Latch Throw up to 3/4", Field Selectable, 12 & 24 VDC	US10B	\$1,046.12
 	ES-S412SS	UL Listed Electric Strike for Rim Exit Device, Fail-Secure, 12VDC	US32D	\$2,030.59
	ES-S424SS	UL Listed Electric Strike for Rim Exit Device, Fail-Secure, 24VDC	US32D	\$2,030.59
	ES-F412SS	UL Listed Electric Strike for Rim Exit Device, Fail-Safe, 12VDC	US32D	\$2,121.65
	ES-F424SS	UL Listed Electric Strike for Rim Exit Device, Fail-Safe, 24VDC	US32D	\$2,121.65
 	EMH-R1224AL	UL Listed Recess Mount Magnetic Door Holder, 12&24V	US26D	\$361.20
	EMH-R24120AL	UL Listed Recess Mount Magnetic Door Holder, 24&120V	US26D	\$361.20
 	EMH-S1224AL	UL Listed Surface Mount Magnetic Door Holder, 12&24V	US26D	\$403.68
	EMH-S24120AL	UL Listed Surface Mount Magnetic Door Holder, 24&120V	US26D	\$403.68
	EMH-E05AL	1/2" Extension Rod	US26D	\$55.70
	EMH-E1AL	1" Extension Rod	US26D	\$55.70
	EMH-E15AL	1-1/2" Extension Rod	US26D	\$66.82
	EMH-E2AL	2" Extension Rod	US26D	\$83.53
	EMH-E3AL	3" Extension Rod	US26D	\$83.53
	EMH-E4AL	4" Extension Rod	US26D	\$111.36
	EMH-E5AL	5" Extension Rod	US26D	\$139.24
	EMH-AE15AL	1-1/2" Adjustable Extension Rod	US26D	\$64.02
EMH-AE4AL	4" Adjustable Extension Rod	US26D	\$111.39	

	Model #	Function	Finish	List Price
	EPT-H4CP	4.5" x 4.5" Standard Weight, 1 Amp, 4 Conductor Power Transfer Hinge	US26	\$415.84
	EPT-H4SC	4.5" x 4.5" Standard Weight, 1 Amp, 4 Conductor Power Transfer Hinge	US26D	\$415.84
	EPT-H4OB	4.5" x 4.5" Standard Weight, 1 Amp, 4 Conductor Power Transfer Hinge	US10B	\$415.84
	EPT-H10CP	4.5" x 4.5" Standard Weight, 1 Amp, 10 Conductor Power Transfer Hinge	US26	\$540.29
	EPT-H10SC	4.5" x 4.5" Standard Weight, 1 Amp, 10 Conductor Power Transfer Hinge	US26D	\$540.29
	EPT-H10OB	4.5" x 4.5" Standard Weight, 1 Amp, 10 Conductor Power Transfer Hinge	US10B	\$540.29
		EPT-L2SS	18" Armored Flex Conduit	US32D
		EPT-L3SS	18" Armored Flex Conduit with Wire Junction Box	US32D
		EPT-L5SS	UL Listed Concealed Power Transfer Device	US32D
	EPT-M2AL	UL Listed Heavy Duty Mortise Power Transfer Device, 2 Conductors	US26D	\$995.55
	EPT-M2DB	UL Listed Heavy Duty Mortise Power Transfer Device, 2 Conductors	US10B	\$995.55
	EPT-M10AL	UL Listed Heavy Duty Mortise Power Transfer Device, 10 Conductors	US26D	\$995.55
	EPT-M10DB	UL Listed Heavy Duty Mortise Power Transfer Device, 10 Conductors	US10B	\$995.55







	Model #	Function	List Price
 		Enclosure: 7.25" W x 8.375" H x 3.625" D	
	EPS-1	UL Listed 1 Amp Power Supply Unit	\$725.44
 		Enclosure: 12" W x 12" H x 4" D	
	EPS-2	UL Listed 2 Amp Power Supply Unit	\$1,113.96
	EPS-UC1	Universal Controller - Relay & System Logic Modes	\$267.09
	EPS-B124	12V, 4 Amp Hour Backup Battery	\$111.39
	EPS-B127	12V, 7 Amp Hour Backup Battery	\$167.08

*For all electric hardware, please check availability and lead-time with sales department first.

GC4400 SERIES		Model #	Function	Finish	QTY /Case	Lbs /Case	List Price
	  	GC4400BF-AL	Regular/Parallel Arm, size 1-6	AL/689	3	38	\$298.54
	GC4400BF-DB	Barrier Free, Back Check	DB/695	3	38	\$298.54	
	GC4400BF-BL		BL/693	3	38	\$298.54	
	GC4400BFDA-AL	Regular/Parallel Arm, size 1-6	AL/689	3	38	\$305.79	
	GC4400BFDA-DB	Barrier Free, Delayed Action,	DB/695	3	38	\$305.79	
	GC4400BFDA-BL	Back Check	BL/693	3	38	\$305.79	
	<hr/>						
	GSCNSA440-AL	Spring Cush-N-Stop Arm	AL/689	20	24	\$149.56	
	GSCNSA440-DB	Spring Cush-N-Stop Arm	DB/695	20	24	\$149.56	
	GSCNSA440-BL	Spring Cush-N-Stop Arm	BL/693	20	24	\$149.56	
	GCNSA440-AL	Cush-N-Stop Arm	AL/689	20	24	\$106.87	
	GCNSA440-DB	Cush-N-Stop Arm	DB/695	20	24	\$106.87	
	GCNSA440-BL	Cush-N-Stop Arm	BL/693	20	24	\$106.87	
<hr/>							
	GSHCHA440-AL	Spring Handle Control Hold Open Arm	AL/689	20	24	\$166.54	
	GSHCHA440-DB	Spring Handle Control Hold Open Arm	DB/695	20	24	\$166.54	
	GSHCHA440-BL	Spring Handle Control Hold Open Arm	BL/693	20	24	\$166.54	
<hr/>							
	GHCHA440-AL	Handle Control Hold Open Arm	AL/689	20	24	\$132.63	
	GHCHA440-DB	Handle Control Hold Open Arm	DB/695	20	24	\$132.63	
	GHCHA440-BL	Handle Control Hold Open Arm	BL/693	20	24	\$132.63	
<hr/>							
	GTA440-AL	Track Arm Set	AL/689	20	20	\$76.17	
	GTA440-DB	Track Arm Set	DB/695	20	20	\$76.17	
	GTA440-BL	Track Arm Set	BL/693	20	20	\$76.17	
<hr/>							
	GTHA440-AL	Track Hold Open Arm Set	AL/689	20	20	\$84.64	
	GTHA440-DB	Track Hold Open Arm Set	DB/695	20	20	\$84.64	
	GTHA440-BL	Track Hold Open Arm Set	BL/693	20	20	\$84.64	
<hr/>							
	GMRA440-AL	Door Closer Arm Set	AL/689	20	16	\$34.83	
	GMRA440-DB	Door Closer Arm Set	DB/695	20	16	\$34.83	
	GMRA440-BL	Door Closer Arm Set	BL/693	20	16	\$34.83	
<hr/>							
	GFDB440-AL	Flat Drop Bracket (Regular Arm Mount)	AL/689	10	20	\$39.68	
	GFDB440-DB	Flat Drop Bracket (Regular Arm Mount)	DB/695	10	20	\$39.68	
	GFDB440-BL	Flat Drop Bracket (Regular Arm Mount)	BL/693	10	20	\$39.68	
<hr/>							
	GFDB442-AL	Flat Drop Bracket (Parallel Arm Mount)	AL/689	10	20	\$39.68	
	GFDB442-DB	Flat Drop Bracket (Parallel Arm Mount)	DB/695	10	20	\$39.68	
	GFDB442-BL	Flat Drop Bracket (Parallel Arm Mount)	BL/693	10	20	\$39.68	















GC4400 SERIES		Model #	Function	Finish	QTY /Case	Lbs /Case	List Price
	GPB440-AL	Parallel Bracket	AL/689	10	8	\$8.51	
	GPB440-DB	Parallel Bracket	DB/695	10	8	\$8.51	
	GPB440-BL	Parallel Bracket	BL/693	10	8	\$8.51	
	GPBE440-AL	Extra Clearance Parallel Bracket	AL/689	10	8	\$24.31	
	GPBE440-BL	Extra Clearance Parallel Bracket	BL/693	10	8	\$24.31	
	GFC440-AL	Full Plastic Cover	AL/689	20	8	\$33.14	
	GFC440-DB	Full Plastic Cover	DB/695	20	8	\$33.14	
	GFC440-BL	Full Plastic Cover	BL/693	20	8	\$33.14	
	GSB590-AL	Sex Nuts, Female Part Only (set of 4)	AL/689	50	12	\$7.49	
	GSB590-DB	Sex Nuts, Female Part Only (set of 4)	DB/695	50	12	\$7.49	
	GTB590-AL	Thru Bolts, Male Part Only (set of 4)	AL/689	50	6	\$3.77	
	GTB590-DB	Thru Bolts, Male Part Only (set of 4)	DB/695	50	6	\$3.77	

GC5900 SERIES		Model #	Function	Finish	QTY /Case	Lbs /Case	List Price
	  	GC5900BF-AL	Regular/Parallel Arm, size 1-6	AL/689	4	34	\$162.54
	GC5900BF-DB	Barrier Free, Back Check	DB/695	4	34	\$162.54	
	GC5900BF-GB		GB/696	4	34	\$162.54	
	GC5900BF-BL		BL/693	4	34	\$162.54	
	GC5900BFDA-AL	Regular/Parallel Arm, size 1-6	AL/689	4	34	\$166.48	
	GC5900BFDA-DB	Barrier Free, Delayed Action,	DB/695	4	34	\$166.48	
	GC5900BFDA-GB	Back Check	GB/696	4	34	\$166.48	
	GC5900BFDA-BL		BL/693	4	34	\$166.48	
		GSCNSA590-AL	Spring Cush-N-Stop Arm	AL/689	20	24	\$149.56
		GSCNSA590-DB	Spring Cush-N-Stop Arm	DB/695	20	24	\$149.56
GSCNSA590-BL		Spring Cush-N-Stop Arm	BL/693	20	24	\$149.56	
	GCNSA590-AL	Cush-N-Stop Arm	AL/689	20	24	\$106.87	
	GCNSA590-DB	Cush-N-Stop Arm	DB/695	20	24	\$106.87	
	GCNSA590-BL	Cush-N-Stop Arm	BL/693	20	24	\$106.87	
	GSHCHA590-AL	Spring Handle Control Hold Open Arm	AL/689	20	24	\$166.54	
	GSHCHA590-DB	Spring Handle Control Hold Open Arm	DB/695	20	24	\$166.54	
	GSHCHA590-BL	Spring Handle Control Hold Open Arm	BL/693	20	24	\$166.54	
	GHCHA590-AL	Handle Control Hold Open Arm	AL/689	20	24	\$132.63	
	GHCHA590-DB	Handle Control Hold Open Arm	DB/695	20	24	\$132.63	
	GHCHA590-BL	Handle Control Hold Open Arm	BL/693	20	24	\$132.63	
	GTA590-AL	Track Arm Set	AL/689	20	20	\$76.17	
	GTA590-DB	Track Arm Set	DB/695	20	20	\$76.17	
	GTA590-BL	Track Arm Set	BL/693	20	20	\$76.17	
	GTHA590-AL	Track Hold Open Arm Set	AL/689	20	20	\$84.64	
	GTHA590-DB	Track Hold Open Arm Set	DB/695	20	20	\$84.64	
	GTHA590-BL	Track Hold Open Arm Set	BL/693	20	20	\$84.64	
	GMRA590-AL	Door Closer Arm Set	AL/689	20	16	\$34.83	
	GMRA590-DB	Door Closer Arm Set	DB/695	20	16	\$34.83	
	GMRA590-BL	Door Closer Arm Set	BL/693	20	16	\$34.83	
	GHFA590-AL	Door Hold Open Arm Set	AL/689	20	20	\$70.54	
	GHFA590-DB	Door Hold Open Arm Set	DB/695	20	20	\$70.54	
	GHFA590-BL	Door Hold Open Arm Set	BL/693	20	20	\$70.54	

GC5900 SERIES		Model #	Function	Finish	QTY /Case	Lbs /Case	List Price
	GFDB590-AL	Flat Drop Bracket for Parallel Arm	AL/689	10	20	\$39.68	
	GFDB590-DB	Flat Drop Bracket for Parallel Arm	DB/695	10	20	\$39.68	
	GFDB590-GB	Flat Drop Bracket for Parallel Arm	GB/696	10	20	\$39.68	
	GFDB590-BL	Flat Drop Bracket for Parallel Arm	BL/693	10	20	\$39.68	
	GFDB592-AL	Narrow Flat Drop Bracket	AL/689	10	20	\$39.68	
	GFDB592-DB	Narrow Flat Drop Bracket	DB/695	10	20	\$39.68	
	GFDB592-GB	Narrow Flat Drop Bracket	GB/696	10	20	\$39.68	
	GFDB592-BL	Narrow Flat Drop Bracket	BL/693	10	20	\$39.68	
	GPB590-AL	Parallel Bracket	AL/689	10	8	\$8.51	
	GPB590-DB	Parallel Bracket	DB/695	10	8	\$8.51	
	GPB590-GB	Parallel Bracket	GB/696	10	8	\$8.51	
	GPB590-BL	Parallel Bracket	BL/693	10	8	\$8.51	
	GPBE590-AL	Extra Clearance Parallel Bracket	GB/696	10	8	\$24.31	
	GPBE590-BL	Extra Clearance Parallel Bracket	AL/689	10	8	\$24.31	
	GPBF590-AL	Parallel Bracket for Hold Open Arm	AL/689	10	10	\$13.77	
	GPBF590-DB	Parallel Bracket for Hold Open Arm	DB/695	10	10	\$13.77	
	GPBF590-GB	Parallel Bracket for Hold Open Arm	GB/696	10	10	\$13.77	
	GPBF590-BL	Parallel Bracket for Hold Open Arm	BL/693	10	10	\$13.77	
	GFC590-AL	Full Plastic Cover	AL/689	20	8	\$33.14	
	GFC590-DB	Full Plastic Cover	DB/695	20	8	\$33.14	
	GFC590-GB	Full Plastic Cover	GB/696	20	8	\$33.14	
	GFC590-BL	Full Plastic Cover	BL/693	20	8	\$33.14	
	GSB590-AL	Sex Nuts, Female Part Only (set of 4)	AL/689	50	12	\$7.49	
	GSB590-DB	Sex Nuts, Female Part Only (set of 4)	DB/695	50	12	\$7.49	
	GSB590-GB	Sex Nuts, Female Part Only (set of 4)	GB/696	50	12	\$7.49	
	GTB590-AL	Thru Bolts, Male Part Only (set of 4)	AL/689	50	6	\$3.77	
	GTB590-DB	Thru Bolts, Male Part Only (set of 4)	DB/695	50	6	\$3.77	
	GTB590-GB	Thru Bolts, Male Part Only (set of 4)	GB/696	50	6	\$3.77	

GC6800 SERIES		Model #	Function	Finish	QTY /Case	Lbs /Case	List Price
	  	GC6800BF-AL	Regular/Parallel Arm, size 1-6	AL/689	4	32	\$178.71
	GC6800BF-DB	Barrier Free, Back Check	DB/695	4	32	\$178.71	
	GC6800BFDA-AL	Regular/Parallel Arm, size 1-6	AL/689	4	32	\$183.06	
	GC6800BFDA-DB	Barrier Free, Delayed Action, Back Check	DB/695	4	32	\$183.06	
	GSCNSA680-AL	Spring Cush-N-Stop Arm	AL/689	20	24	\$149.56	
	GSCNSA680-DB	Spring Cush-N-Stop Arm	DB/695	20	24	\$149.56	
	GCNSA680-AL	Cush-N-Stop Arm	AL/689	20	24	\$106.87	
	GCNSA680-DB	Cush-N-Stop Arm	DB/695	20	24	\$106.87	
	GSHCHA680-AL	Spring Handle Control Hold Open Arm	AL/689	20	24	\$166.54	
	GSHCHA680-DB	Spring Handle Control Hold Open Arm	DB/695	20	24	\$166.54	
	GHCHA680-AL	Handle Control Hold Open Arm	AL/689	20	24	\$132.63	
	GHCHA680-DB	Handle Control Hold Open Arm	DB/695	20	24	\$132.63	
	GTA680-AL	Track Arm Set	AL/689	20	20	\$76.17	
	GTA680-DB	Track Arm Set	DB/695	20	20	\$76.17	
	GTHA680-AL	Track Hold Open Arm Set	AL/689	20	20	\$84.64	
	GTHA680-DB	Track Hold Open Arm Set	DB/695	20	20	\$84.64	
	GMRA680-AL	Door Closer Arm Set	AL/689	20	16	\$34.83	
	GMRA680-DB	Door Closer Arm Set	DB/695	20	16	\$34.83	
	GHFA680-AL	Door Hold Open Arm Set	AL/689	20	20	\$70.54	
	GHFA680-DB	Door Hold Open Arm Set	DB/695	20	20	\$70.54	

GC6800 SERIES		Model #	Function	Finish	QTY /Case	Lbs /Case	List Price
	GFDB680-AL	Flat Drop Bracket for Narrow Top Rail	AL/689	10	20	\$39.68	
	GFDB680-DB	Flat Drop Bracket for Narrow Top Rail	DB/695	10	20	\$39.68	
	GFDB682-AL	Flat Drop Bracket for Parallel Arm	AL/689	10	8	\$39.68	
	GFDB682-DB	Flat Drop Bracket for Parallel Arm	DB/695	10	8	\$39.68	
	GPB680-AL	Parallel Bracket	AL/689	10	8	\$8.51	
	GPB680-DB	Parallel Bracket	DB/695	10	8	\$8.51	
	GPBF680-AL	Parallel Bracket for Hold Open Arm	AL/689	10	8	\$13.77	
	GPBF680-DB	Parallel Bracket for Hold Open Arm	DB/695	10	8	\$13.77	
	GPBE680-AL	Extra Clearance Parallel Bracket	AL/689	10	8	\$24.31	
	GPBE680-DB	Extra Clearance Parallel Bracket	DB/695	10	8	\$24.31	
	GBSS680-AL	Blade Stop Spacer	AL/689	40	8	\$16.21	
	GBSS680-DB	Blade Stop Spacer	DB/695	40	8	\$16.21	
	GSC680-AL	Slim Plastic Cover	AL/689	20	8	\$33.14	
	GSC680-DB	Slim Plastic Cover	DB/695	20	8	\$33.14	
	GFC680-AL	Full Plastic Cover	AL/689	20	8	\$33.14	
	GFC680-DB	Full Plastic Cover	DB/695	20	8	\$33.14	
	GSB590-AL	Sex Nuts, Female Part Only (set of 4)	AL/689	50	12	\$7.49	
	GSB590-DB	Sex Nuts, Female Part Only (set of 4)	DB/695	50	12	\$7.49	
	GTB590-AL	Thru Bolts, Male Part Only (set of 4)	AL/689	50	6	\$3.77	
	GTB590-DB	Thru Bolts, Male Part Only (set of 4)	DB/695	50	6	\$3.77	

GC8700 SERIES		Model #	Function	Finish	QTY /Case	Lbs /Case	List Price
		GC8700-AL	Regular/Parallel Arm, size 3-6	AL/689	6	38	\$129.15
		GC8700-DB	Back Check	DB/695	6	38	\$129.15
		GC8700-GB		GB/696	6	38	\$129.15
		GC8700-BL		BL/693	6	38	\$129.15
		GC8700BF-AL	Regular/Parallel Arm, size 1-4	AL/689	6	38	\$129.15
		GC8700BF-DB	Barrier Free, Back Check	DB/695	6	38	\$129.15
		GC8700BF-GB		GB/696	6	38	\$129.15
		GC8700BF-BL		BL/693	6	38	\$129.15
		GC8716BF-AL	Regular/Parallel Arm, size 1-6	AL/689	6	38	\$129.15
		GC8716BF-DB	Barrier Free, Back Check	DB/695	6	38	\$129.15
		GC8716BF-GB		GB/696	6	38	\$129.15
		GC8716BF-BL		BL/693	6	38	\$129.15
	GHFA870-AL	Hold Open Arm	AL/689	20	20	\$70.54	
	GHFA870-DB	Hold Open Arm	DB/695	20	20	\$70.54	
	GHFA870-GB	Hold Open Arm	GB/696	20	20	\$70.54	
	GHFA870-BL	Hold Open Arm	BL/693	20	20	\$70.54	
	GMRA870-AL	Door Closer Arm Set	AL/689	20	16	\$34.83	
	GMRA870-DB	Door Closer Arm Set	DB/695	20	16	\$34.83	
	GMRA870-GB	Door Closer Arm Set	GB/696	20	16	\$34.83	
	GMRA870-BL	Door Closer Arm Set	BL/693	20	16	\$34.83	
	GFDB870-AL	Flat Drop Bracket	AL/689	10	20	\$39.68	
	GFDB870-DB	Flat Drop Bracket	DB/695	10	20	\$39.68	
	GFDB870-GB	Flat Drop Bracket	GB/696	10	20	\$39.68	
	GFDB870-BL	Flat Drop Bracket	BL/693	10	20	\$39.68	
	GFDB872-AL	Flat Drop Bracket for Parallel	AL/689	10	20	\$39.68	
	GFDB872-DB	Flat Drop Bracket for Parallel	DB/695	10	20	\$39.68	
	GFDB872-GB	Flat Drop Bracket for Parallel	GB/696	10	20	\$39.68	
	GFDB872-BL	Flat Drop Bracket for Parallel	BL/693	10	20	\$39.68	
	GPB870-AL	Parallel Bracket	AL/689	10	8	\$8.51	
	GPB870-DB	Parallel Bracket	DB/695	10	8	\$8.51	
	GPB870-GB	Parallel Bracket	GB/696	10	8	\$8.51	
	GPB870-BL	Parallel Bracket	BL/693	10	8	\$8.51	
	GPBF870-AL	Parallel Bracket for Hold Open Arm	AL/689	10	8	\$13.77	
	GPBF870-DB	Parallel Bracket for Hold Open Arm	DB/695	10	8	\$13.77	
	GPBF870-GB	Parallel Bracket for Hold Open Arm	GB/696	10	8	\$13.77	
	GPBF870-BL	Parallel Bracket for Hold Open Arm	BL/693	10	8	\$13.77	
	GFC870-AL	Full Plastic Cover	AL/689	20	8	\$26.85	
	GFC870-DB	Full Plastic Cover	DB/695	20	8	\$26.85	
	GFC870-GB	Full Plastic Cover	GB/696	20	8	\$26.85	
	GFC870-BL	Full Plastic Cover	BL/693	20	8	\$26.85	
	GSB590-AL	Sex Nuts, Female Part Only (set of 4)	AL/689	50	12	\$7.49	
	GSB590-DB	Sex Nuts, Female Part Only (set of 4)	DB/695	50	12	\$7.49	
	GSB590-GB	Sex Nuts, Female Part Only (set of 4)	GB/696	50	12	\$7.49	
	GSB590-BL	Sex Nuts, Female Part Only (set of 4)	BL/693	50	12	\$7.49	
	GTB590-AL	Thru Bolts, Male Part Only (set of 4)	AL/689	50	6	\$3.77	
	GTB590-DB	Thru Bolts, Male Part Only (set of 4)	DB/695	50	6	\$3.77	
	GTB590-GB	Thru Bolts, Male Part Only (set of 4)	GB/696	50	6	\$3.77	
	GTB590-BL	Thru Bolts, Male Part Only (set of 4)	BL/693	50	6	\$3.77	

GC800 SERIES



Model #	Function	Finish	QTY /Case	Lbs /Case	List Price
GC802-AL	Regular/Parallel Arm, size 2	AL/689	6	31	\$74.27
GC802-DB	Regular/Parallel Arm, size 2	DB/695	6	31	\$74.27
GC802-GB	Regular/Parallel Arm, size 2	GB/696	6	31	\$74.27
GC803-AL	Regular/Parallel Arm, size 3	AL/689	6	36	\$79.85
GC803-DB	Regular/Parallel Arm, size 3	DB/695	6	36	\$79.85
GC803-GB	Regular/Parallel Arm, size 3	GB/696	6	36	\$79.85
GC804-AL	Regular/Parallel Arm, size 4	AL/689	6	38	\$94.44
GC804-DB	Regular/Parallel Arm, size 4	DB/695	6	38	\$94.44
GC804-GB	Regular/Parallel Arm, size 4	GB/696	6	38	\$94.44



GHFA800-AL	Hold Open Arm	AL/689	20	24	\$70.54
GHFA800-DB	Hold Open Arm	DB/695	20	24	\$70.54
GHFA800-GB	Hold Open Arm	GB/696	20	24	\$70.54



GMRA800-AL	Door Closer Arm Set	AL/689	20	16	\$34.83
GMRA800-DB	Door Closer Arm Set	DB/695	20	16	\$34.83
GMRA800-GB	Door Closer Arm Set	GB/696	20	16	\$34.83



GFDB800-AL	Flat Drop Bracket for GC802,803,804	AL/689	10	20	\$39.68
GFDB800-DB	Flat Drop Bracket for GC802,803,804	DB/695	10	20	\$39.68
GFDB800-GB	Flat Drop Bracket for GC802,803,804	GB/696	10	20	\$39.68



GPB800-AL	Parallel Bracket for GC800	AL/689	10	8	\$8.51
GPB800-DB	Parallel Bracket for GC800	DB/695	10	8	\$8.51
GPB800-GB	Parallel Bracket for GC800	GB/696	10	8	\$8.51



GSB590-AL	Sex Nuts, Female Part Only (set of 4)	AL/689	50	12	\$7.49
GSB590-DB	Sex Nuts, Female Part Only (set of 4)	DB/695	50	12	\$7.49
GSB590-GB	Sex Nuts, Female Part Only (set of 4)	GB/696	50	12	\$7.49















GTB590-AL	Thru Bolts, Male Part Only (set of 4)	AL/689	50	6	\$3.77
GTB590-DB	Thru Bolts, Male Part Only (set of 4)	DB/695	50	6	\$3.77
GTB590-GB	Thru Bolts, Male Part Only (set of 4)	GB/696	50	6	\$3.77

Model #	Function	Finish	QTY /Case	Lbs /Case	List Price		
	DD08-13H30SS	30" Surface Overhead Stop Medium Duty - Hold Open	US32D	10	30	\$247.77	
	DD08-13S30SS	30" Surface Overhead Stop Medium Duty - Stop Only - UL Listed	US32D	10	30	\$247.77	
	DD08-13F30SS	30" Surface Overhead Stop Medium Duty - Friction	US32D	10	30	\$247.77	
	DD08-13H36SS	36" Surface Overhead Stop Medium Duty - Hold Open	US32D	10	30	\$247.77	
	DD08-13H36BL	36" Surface Overhead Stop Medium Duty - Hold Open	US19	10	30	\$271.68	
	DD08-13S36SS	36" Surface Overhead Stop Medium Duty - Stop Only - UL Listed	US32D	10	30	\$247.77	
	DD08-13S36BL	36" Surface Overhead Stop Medium Duty - Stop Only - UL Listed	US19	10	30	\$271.68	
	DD08-13F36SS	36" Surface Overhead Stop Medium Duty - Friction	US32D	10	30	\$247.77	
		DD08-14H30SS	30" Surface Overhead Stop Heavy Duty - Hold Open	US32D	10	30	\$544.41
		DD08-14S30SS	30" Surface Overhead Stop Heavy Duty - Stop Only - UL Listed	US32D	10	30	\$544.41
DD08-14F30SS		30" Surface Overhead Stop Heavy Duty - Friction	US32D	10	30	\$544.41	
DD08-14H36SS		36" Surface Overhead Stop Heavy Duty - Hold Open	US32D	10	30	\$544.41	
DD08-14S36SS		36" Surface Overhead Stop Heavy Duty - Stop Only - UL Listed	US32D	10	30	\$544.41	
DD08-14F36SS		36" Surface Overhead Stop Heavy Duty - Friction	US32D	10	30	\$544.41	

	Model #	Function	Finish	QTY /Case	Lbs /Case	List Price
	DD08-15H30SS	30" Concealed Overhead Stop Medium Duty - Hold Open	US32D	10	30	\$217.14
	DD08-15S30SS	30" Concealed Overhead Stop Medium Duty - Stop Only - UL Listed	US32D	10	30	\$217.14
	DD08-15F30SS	30" Concealed Overhead Stop Medium Duty - Friction	US32D	10	30	\$217.14
	DD08-15H36SS	36" Concealed Overhead Stop Medium Duty - Hold Open	US32D	10	30	\$217.14
	DD08-15S36SS	36" Concealed Overhead Stop Medium Duty - Stop Only - UL Listed	US32D	10	30	\$217.14
	DD08-15F36SS	36" Concealed Overhead Stop Medium Duty - Friction	US32D	10	30	\$217.14

COMMERCIAL D.H.

	DD08-16H30SS	30" Concealed Overhead Stop Heavy Duty - Hold Open	US32D	10	30	\$541.28
	DD08-16S30SS	30" Concealed Overhead Stop Heavy Duty - Stop Only - UL Listed	US32D	10	30	\$541.28
	DD08-16F30SS	30" Concealed Overhead Stop Heavy Duty - Friction	US32D	10	30	\$541.28
	DD08-16H36SS	36" Concealed Overhead Stop Heavy Duty - Hold Open	US32D	10	30	\$541.28
	DD08-16S36SS	36" Concealed Overhead Stop Heavy Duty - Stop Only - UL Listed	US32D	10	30	\$541.28
	DD08-16F36SS	36" Concealed Overhead Stop Heavy Duty - Friction	US32D	10	30	\$541.28

	Model #	Description	Finish	QTY /Box	QTY /Case	List Price
 	DD05-63CP	UL Rated Manual Flush Bolt for Metal Doors	US26	1	24	\$39.85
	DD05-63SN	UL Rated Manual Flush Bolt for Metal Doors	US15	1	24	\$39.85
	DD05-63SC	UL Rated Manual Flush Bolt for Metal Doors	US26D	1	24	\$39.85
	DD05-63OB	UL Rated Manual Flush Bolt for Metal Doors	US10B	1	24	\$44.04
	DD05-63BL	UL Rated Manual Flush Bolt for Metal Doors	US19	1	24	\$44.04
 	DD05-64CP	UL Rated Manual Flush Bolt for Wood Doors	US26	1	24	\$47.83
	DD05-64SN	UL Rated Manual Flush Bolt for Wood Doors	US15	1	24	\$47.83
	DD05-64SC	UL Rated Manual Flush Bolt for Wood Doors	US26D	1	24	\$47.83
	DD05-64OB	UL Rated Manual Flush Bolt for Wood Doors	US10B	1	24	\$52.85
	DD05-64BL	UL Rated Manual Flush Bolt for Wood Doors	US19	1	24	\$52.85
 	(price per pair, sold per pair only)					
	DD05-65CP	UL Rated Automatic Flush Bolt for Metal Doors	US26	pair	24	\$192.32
	DD05-65SC	UL Rated Automatic Flush Bolt for Metal Doors	US26D	pair	24	\$192.32
	DD05-65OB	UL Rated Automatic Flush Bolt for Metal Doors	US10B	pair	24	\$211.56
	DD05-65BL	UL Rated Automatic Flush Bolt for Metal Doors	US19	pair	24	\$211.56
(ETA: 09/22)						
 	(price per set, sold per set only)					
	DD05-65FCP	UL Auto Flush Bolt with Fire Bolt for Metal Doors	US26	set	24	\$182.72
	DD05-65FSC	UL Auto Flush Bolt with Fire Bolt for Metal Doors	US26D	set	24	\$182.72
	DD05-65FOB	UL Auto Flush Bolt with Fire Bolt for Metal Doors	US10B	set	24	\$200.97
	DD05-65FBL	UL Auto Flush Bolt with Fire Bolt for Metal Doors	US19	set	24	\$200.97
(ETA: 09/22)						
 	(price per pair, sold per pair only)					
	DD05-66CP	UL Rated Automatic Flush Bolt for Wood Doors	US26	pair	24	\$206.25
	DD05-66SC	UL Rated Automatic Flush Bolt for Wood Doors	US26D	pair	24	\$206.25
	DD05-66OB	UL Rated Automatic Flush Bolt for Wood Doors	US10B	pair	24	\$226.88
	DD05-66BL	UL Rated Automatic Flush Bolt for Wood Doors	US19	pair	24	\$226.88
(ETA: 09/22)						
 	(price per set, sold per set only)					
	DD05-66FCP	UL Auto Flush Bolt with Fire Bolt for Wood Doors	US26	set	24	\$195.94
	DD05-66FSC	UL Auto Flush Bolt with Fire Bolt for Wood Doors	US26D	set	24	\$195.94
	DD05-66FOB	UL Auto Flush Bolt with Fire Bolt for Wood Doors	US10B	set	24	\$215.53
	DD05-66FBL	UL Auto Flush Bolt with Fire Bolt for Wood Doors	US19	set	24	\$215.53
(ETA: 09/22)						





	Model #	Description	Finish	QTY /Box	QTY /Case	List Price
   						(price per pair, sold per pair only)
	DD05-67CP	UL Constant Flush Bolt for Metal Doors	US26	pair	24	\$192.32
	DD05-67SC	UL Constant Flush Bolt for Metal Doors	US26D	pair	24	\$192.32
	DD05-67OB	UL Constant Flush Bolt for Metal Doors	US10B	pair	24	\$211.56
	DD05-67BL	UL Constant Flush Bolt for Metal Doors	US19	pair	24	\$211.56
		(ETA: 09/22)				
						(price per set, sold per set only)
	DD05-67FCP	UL Constant Flush Bolt with Fire Bolt for Metal Doors	US26	set	24	\$182.72
	DD05-67FSC	UL Constant Flush Bolt with Fire Bolt for Metal Doors	US26D	set	24	\$182.72
	DD05-67FOB	UL Constant Flush Bolt with Fire Bolt for Metal Doors	US10B	set	24	\$200.97
	DD05-67FBL	UL Constant Flush Bolt with Fire Bolt for Metal Doors	US19	set	24	\$200.97
		(ETA: 09/22)				
						(price per pair, sold per pair only)
	DD05-68CP	UL Constant Flush Bolt for Wood Doors	US26	pair	24	\$206.25
	DD05-68SC	UL Constant Flush Bolt for Wood Doors	US26D	pair	24	\$206.25
	DD05-68OB	UL Constant Flush Bolt for Wood Doors	US10B	pair	24	\$226.88
	DD05-68BL	UL Constant Flush Bolt for Wood Doors	US19	pair	24	\$226.88
		(ETA: 09/22)				
						(price per set, sold per set only)
	DD05-68FCP	UL Constant Flush Bolt with Fire Bolt for Wood Doors	US26	set	24	\$195.94
	DD05-68FSC	UL Constant Flush Bolt with Fire Bolt for Wood Doors	US26D	set	24	\$195.94
	DD05-68FOB	UL Constant Flush Bolt with Fire Bolt for Wood Doors	US10B	set	24	\$215.53
	DD05-68FBL	UL Constant Flush Bolt with Fire Bolt for Wood Doors	US19	set	24	\$215.53
		(ETA: 09/22)				
	DD05-618	18" Flush Bolt Extension Rod		20	100	\$8.30
	DD05-624	24" Flush Bolt Extension Rod		20	100	\$10.42
	DD05-603CP	Dust Proof Strike for Flush Bolts	US26	10	100	\$38.09
	DD05-603SN	Dust Proof Strike for Flush Bolts	US15	10	100	\$38.09
	DD05-603SC	Dust Proof Strike for Flush Bolts	US26D	10	100	\$38.09
	DD05-603OB	Dust Proof Strike for Flush Bolts	US10B	10	100	\$41.90
	DD05-603BL	Dust Proof Strike for Flush Bolts	US19	10	100	\$41.90
	DD05-604CP	Dust Proof Strike (w/o face plate) for Flush Bolts	US26	10	100	\$34.26
	DD05-604SN	Dust Proof Strike (w/o face plate) for Flush Bolts	US15	10	100	\$34.26
	DD05-604SC	Dust Proof Strike (w/o face plate) for Flush Bolts	US26D	10	100	\$34.26
	DD05-604OB	Dust Proof Strike (w/o face plate) for Flush Bolts	US10B	10	100	\$37.69
	DD05-604BL	Dust Proof Strike (w/o face plate) for Flush Bolts	US19	10	100	\$37.69

	Model #	Description	Finish	QTY /Box	QTY /Case	List Price
	DD02-48CP	Door Saver II Commercial Hinge Pin Stop	US26	50	500	\$47.53
	DD02-48SN	Door Saver II Commercial Hinge Pin Stop	US15	50	500	\$47.53
	DD02-48OB	Door Saver II Commercial Hinge Pin Stop	US10B	50	500	\$50.29
	DD02-48BL	Door Saver II Commercial Hinge Pin Stop	US19	50	500	\$50.29
	DD02-25CP	Roller Bumpers	US26	10	100	\$14.81
	DD02-25SN	Roller Bumpers	US15	10	100	\$16.31
	DD02-25OB	Roller Bumpers	US10B	10	100	\$17.03
	2-1/2" Diameter					
	DD02-53SS	Concave Wall Stop	US32D	20	200	\$5.69
	DD02-53CP	Concave Wall Stop	US26	20	200	\$8.11
	DD02-53PB	Concave Wall Stop	US3	20	200	\$8.11
	DD02-53SN	Concave Wall Stop	US15	20	200	\$8.90
	DD02-53OB	Concave Wall Stop	US10B	20	200	\$9.71
DD02-53BL	Concave Wall Stop	US19	20	200	\$9.71	
	2-1/2" Diameter					
	DD02-57SS	Convex Wall Stop	US32D	20	200	\$5.69
	DD02-57CP	Convex Wall Stop	US26	20	200	\$8.11
	DD02-57PB	Convex Wall Stop	US3	20	200	\$8.11
	DD02-57SN	Convex Wall Stop	US15	20	200	\$8.90
	DD02-57OB	Convex Wall Stop	US10B	20	200	\$9.71
DD02-57BL	Convex Wall Stop	US19	20	200	\$9.71	
	1-3/4" Diameter					
	DD02-61CP	Dome Stop--Low Profile (1/8")	US26	20	200	\$8.33
	DD02-61PB	Dome Stop--Low Profile (1/8")	US3	20	200	\$8.33
	DD02-61SN	Dome Stop--Low Profile (1/8")	US15	20	200	\$9.17
	DD02-61OB	Dome Stop--Low Profile (1/8")	US10B	20	200	\$10.01
DD02-61BL	Dome Stop--Low Profile (1/8")	US19	20	200	\$10.01	
	1-3/4" Diameter					
	DD02-63CP	Dome Stop--High Profile (7/16")	US26	20	200	\$10.01
	DD02-63PB	Dome Stop--High Profile (7/16")	US3	20	200	\$10.01
	DD02-63SN	Dome Stop--High Profile (7/16")	US15	20	200	\$10.99
	DD02-63OB	Dome Stop--High Profile (7/16")	US10B	20	200	\$12.02
DD02-63BL	Dome Stop--High Profile (7/16")	US19	20	200	\$12.02	

	Model #	Description	Finish	QTY /Box	QTY /Case	List Price
	DD02-601	Riser for Dome Stop 3/8" Thick	US26D	50	400	\$6.11
	DD02-602	Riser for Dome Stop 5/8" Thick	US26D	50	400	\$6.11
	DD02-603CP	Riser for Dome Stop 3/8" Thick	US26	20	200	\$6.68
	DD02-603PB	Riser for Dome Stop 3/8" Thick	US3	20	200	\$6.68
	DD02-603SN	Riser for Dome Stop 3/8" Thick	US15	20	200	\$6.68
	DD02-603OB	Riser for Dome Stop 3/8" Thick	US10B	20	200	\$6.68
	DD02-603BL	Riser for Dome Stop 3/8" Thick	US19	20	200	\$6.68
	DD09-30434OB	4" X 34" Anodized Aluminum Mop Plate	US10B		10	\$49.19
	DD09-30434SS	4" X 34" SS Mop Plate	US32D		10	\$41.87
	DD09-323634OB	36" X 34" Anodized Aluminum Armor Plate	US10B		6	\$440.56
	DD09-323634SS	36" X 34" SS Armor Plate	US32D		6	\$418.57
Options: Adhesive Type (Scotch Mount) available with factory lead-time						
		WH Warnock Hersey - 90 min. fire rating on wood door and 3 hr on metal door				
	DD09-323634FSS	36" X 34" WH SS Armor Plate	US32D		6	\$450.03
Options: Adhesive Type (Scotch Mount) available with factory lead-time						

	Model #	Description	Finish	QTY /Box	QTY /Case	List Price
	DD02-28CP	4" Drop-Down Door Holder	US26	25	100	\$11.93
	DD02-28SN	4" Drop-Down Door Holder	US15	25	100	\$13.12
	DD02-28OB	4" Drop-Down Door Holder	US10B	25	100	\$13.73
	DD02-29CP	5" Kick Down Door Holder	US26	25	100	\$44.99
	DD02-29PB	5" Kick Down Door Holder	US3	25	100	\$44.99
	DD02-29SN	5" Kick Down Door Holder	US15	25	100	\$49.51
	DD02-29OB	5" Kick Down Door Holder	US10B	25	100	\$54.02
	DD02-71CP	Commercial Floor Stop	US26	10	60	\$44.12
	DD02-71SN	Commercial Floor Stop	US15	10	60	\$48.54
	DD02-71OB	Commercial Floor Stop	US10B	10	60	\$50.73
	DD02-71BL	Commercial Floor Stop	US19	10	60	\$50.73
	DD02-73CP	Goose Neck Floor Stop	US26	10	60	\$29.23
	DD02-73SN	Goose Neck Floor Stop	US15	10	60	\$30.62
	DD02-73OB	Goose Neck Floor Stop	US10B	10	60	\$32.12
	DD02-73BL	Goose Neck Floor Stop	US19	10	60	\$32.12
	DD02-75SS	Cylindrical Floor Stop	US32D	10	60	\$24.49
	DD02-75CP	Cylindrical Floor Stop	US26	10	60	\$26.90
	DD02-75OB	Cylindrical Floor Stop	US10B	10	60	\$26.90
	DD02-75BL	Cylindrical Floor Stop	US19	10	60	\$26.90
	DD10-10SS	Latch Guard Protector for Lever w/ 3-3/4" Rose	US32D		10	\$90.96
	DD10-10AL	Latch Guard Protector for Lever w/ 3-3/4" Rose	US26D		10	\$52.94
	DD10-10DB	Latch Guard Protector for Lever w/ 3-3/4" Rose	US10B		10	\$56.02
	DD10-11SS	Universal Latch Guard Protector	US32D		10	\$83.48
	DD10-11AL	Universal Latch Guard Protector	US26D		10	\$52.55
	DD10-11DB	Universal Latch Guard Protector	US10B		10	\$55.40



	Model #	Description	Finish	QTY /Box	QTY /Case	List Price
	(Zinc Die-cast)					
	DD04-31CP	Swing Bar Door Security Guard	US26	10	100	\$13.13
	DD04-31PB	Swing Bar Door Security Guard	US3	10	100	\$13.13
	DD04-31SN	Swing Bar Door Security Guard	US15	10	100	\$15.10
	DD04-31OB	Swing Bar Door Security Guard	US10B	10	100	\$15.77
	(Zinc Die-cast)					
	DD04-33CP	Door Security Guard with Rubber Bumper	US26	10	100	\$17.06
	DD04-33PB	Door Security Guard with Rubber Bumper	US3	10	100	\$17.06
	DD04-33SN	Door Security Guard with Rubber Bumper	US15	10	100	\$19.63
	DD04-33OB	Door Security Guard with Rubber Bumper	US10B	10	100	\$20.46
	DD04-310	Door Guard Shim for DD04-31		50	200	\$1.98
	DD04-300CP	Door Angle Protector	US26	50	100	\$3.17
	DD04-300PB	Door Angle Protector	US3	50	100	\$3.17
	DD04-300SN	Door Angle Protector	US15	50	100	\$3.65
	DD04-300OB	Door Angle Protector	US10B	50	100	\$3.77
	DD04-36CP	Privacy Door Latch	US26	5	20	\$54.35
	DD04-36SN	Privacy Door Latch	US15	5	20	\$62.15
	DD04-36OB	Privacy Door Latch	US10B	5	20	\$68.34
	DD04-36BL	Privacy Door Latch	US19	5	20	\$68.34







	Model #	Description	Finish	QTY /Case	List Price
	DD09-1035PB	3-1/2" x 15" Solid Brass Push Plate	US3	10	\$45.13
	DD09-1035SN	3-1/2" x 15" Solid Brass Push Plate	US15	10	\$58.66
	DD09-1035OB	3-1/2" x 15" Solid Brass Push Plate	US10B	10	\$60.18
	DD09-1035BL	3-1/2" x 15" Solid Brass Push Plate	US19	10	\$60.18
	DD09-20135PB	3-1/2" x 15" Solid Brass Pull Plate	US3	10	\$113.89
	DD09-20135SN	3-1/2" x 15" Solid Brass Pull Plate	US15	10	\$121.20
	DD09-20135OB	3-1/2" x 15" Solid Brass Pull Plate	US10B	10	\$132.37
	DD09-20135BL	3-1/2" x 15" Solid Brass Pull Plate	US19	10	\$132.37
Screw-Mount Type					
	DD09-30630BT	6" x 30" Anodized Aluminum Kickplate	US4 (Dull Brass)	10	\$36.27
	DD09-30630SN	6" x 30" Anodized Aluminum Kickplate	US15	10	\$44.94
	DD09-30630OB	6" x 30" Anodized Aluminum Kickplate	US10B	10	\$48.16
	DD09-30634BT	6" x 34" Anodized Aluminum Kickplate	US4 (Dull Brass)	10	\$40.32
	DD09-30634SN	6" x 34" Anodized Aluminum Kickplate	US15	10	\$49.95
	DD09-30634OB	6" x 34" Anodized Aluminum Kickplate	US10B	10	\$53.51
	DD09-30834BT	8" x 34" Anodized Aluminum Kickplate	US4 (Dull Brass)	10	\$53.81
	DD09-30834SN	8" x 34" Anodized Aluminum Kickplate	US15	10	\$66.63
	DD09-30834OB	8" x 34" Anodized Aluminum Kickplate	US10B	10	\$71.96
	DD09-30834BL	8" x 34" Anodized Aluminum Kickplate	US19	10	\$71.96
	DD09-30834SS	8" x 34" Stainless Steel Kickplate (0.04")	US32D	10	\$75.09
	DD09-301034BT	10" x 34" Anodized Aluminum Kickplate	US4 (Dull Brass)	10	\$67.25
DD09-301034SN	10" x 34" Anodized Aluminum Kickplate	US15	10	\$83.29	
DD09-301034OB	10" x 34" Anodized Aluminum Kickplate	US10B	10	\$89.95	
DD09-301034BL	10" x 34" Anodized Aluminum Kickplate	US19	10	\$89.95	
DD09-301034SS	10" x 34" Stainless Steel Kickplate (0.04")	US32D	10	\$93.86	
Tape-On Type. Recommended for Steel Doors.					
	DD09-31834BT	8" x 34" Anodized Aluminum Kickplate	US4 (Dull Brass)	10	\$53.81
	DD09-31834SN	8" x 34" Anodized Aluminum Kickplate	US15	10	\$66.63
	DD09-31834OB	8" x 34" Anodized Aluminum Kickplate	US10B	10	\$71.96

	Model #	Description	Finish	QTY /Box	QTY /Case	List Price
	Bent Strap Wheel (Steel)					
	DD11-1178BL	Surface mount, Bent Strap Wheel, for Wood Doors, 6'6"	US19	1	1	\$317.49
	DD11-1196BL	Surface mount, Bent Strap Wheel, for Wood Doors, 8'0"	US19	1	1	\$349.78
	DD11-1178SN	Surface mount, Bent Strap Wheel, for Wood Doors, 6'6"	US15	1	1	\$443.95
	DD11-1196SN	Surface mount, Bent Strap Wheel, for Wood Doors, 8'0"	US15	1	1	\$489.69
	Add-A-Door Kit (Less Track)					
	DD11-1100KBL	Bent Strap Wheel Kit (Less Track)	US19	1	10	\$204.67
	DD11-1100KSN	Bent Strap Wheel Kit (Less Track)	US15	1	10	\$266.60
	DD11-1100BL	Bent Strap Wheel only, for Wood door	US19	1	10	\$161.58
	DD11-1100SN	Bent Strap Wheel only, for Wood door	US15	1	10	\$199.28
	Single Wheel (Steel)					
	DD11-1378BL	Top Mount, Single Wheel, for Wood Doors, 6'6"	US19	1	1	\$317.49
	DD11-1396BL	Top Mount, Single Wheel, for Wood Doors, 8'0"	US19	1	1	\$349.78
	DD11-1378SN	Top Mount, Single Wheel, for Wood Doors, 6'6"	US15	1	1	\$443.95
	DD11-1396SN	Top Mount, Single Wheel, for Wood Doors, 8'0"	US15	1	1	\$489.69
	Add-A-Door Kit (Less Track)					
	DD11-1300KBL	Top Mount Single Wheel Kit (Less Track)	US19	1	10	\$210.63
	DD11-1300KSN	Top Mount Single Wheel Kit (Less Track)	US15	1	10	\$266.60
	DD11-1300BL	Top Mount, Single Wheel only	US19	1	10	\$161.58
	DD11-1300SN	Top Mount, Single Wheel only	US15	1	10	\$199.28
	DD11-12FBGBL	Adjustable Floor Roller Guide	US19	5	25	\$18.30
	DD11-12FBGSN	Adjustable Floor Roller Guide	US15	5	25	\$30.66

	Model #	Description	Finish	QTY /Box	QTY /Case	List Price
	DD11-10FTR78BL	6'6" Flat Track	US19	2	10	\$126.57
	DD11-10FTR78SN	6'6" Flat Track	US15	2	10	\$177.74
	DD11-10FTR96BL	8' Flat Track	US19	2	10	\$140.04
	DD11-10FTR96SN	8' Flat Track	US15	2	10	\$196.58
	DD11-10ETR24BL	24" Extension Flat Track	US19	4	20	\$64.63
	DD11-10ETR24SN	24" Extension Flat Track	US15	4	20	\$88.87
						(Price per pair)
	DD11-10SCKBL	Soft Closing Kit for Flat Track (pair)	US19	10	10	\$97.40
	DD11-10SCKSN	Soft Closing Kit for Flat Track (pair)	US15	10	10	\$97.40
	DD11-10PL1BL	Hand Pull	US19	10	100	\$32.83
	DD11-10PL1SN	Hand Pull	US15	10	100	\$36.10
	DD11-10PL2BL	Recessed Flush Pull	US19	10	100	\$16.42
	DD11-10PL2SN	Recessed Flush Pull	US15	10	100	\$18.05
	DD11-10PL4BL	Handle with Flush Pull	US19	10	20	\$42.90
	DD11-10PL4SN	Handle with Flush Pull	US15	10	20	\$64.33
	DD11-PL1BL	Privacy Latch	US19	10	100	\$18.85
	DD11-PL1SN	Privacy Latch	US15	10	100	\$24.24
 <p>Set of 5</p> <p>Set of 6</p>	DD11-BPK5BL	Bypass Kit (set of 5 for 6'6" track)	US19	1	10	\$155.11
	DD11-BPK5SN	Bypass Kit (set of 5 for 6'6" track)	US15	1	10	\$186.14
	DD11-BPK6BL	Bypass Kit (set of 6 for 8' track)	US19	1	10	\$193.89
	DD11-BPK6SN	Bypass Kit (set of 6 for 8' track)	US15	1	10	\$232.67

DOOR HARDWARE

Model #	Description	Finish	QTY /Box	QTY /Case	List Price
Strap Wheel (Stainless Steel)					
	DD11-2178SS	Surface Mount, Strap Wheel, for Wood Doors, 6'6"	US32D	1 16	\$704.94
	DD11-2196SS	Surface Mount, Strap Wheel, for Wood Doors, 8'0"	US32D	1 16	\$774.90
	DD11-21S78SS	Surface Mount, Strap Wheel, for Wood Doors, Soft Closing, 6'6"	US32D	1 16	\$785.69
	DD11-21S96SS	Surface Mount, Strap Wheel, for Wood Doors, Soft Closing, 8'0"	US32D	1 16	\$855.62
Add-A-Door Kit (Less Track)					
	DD11-2100KSS	Strap Wheel Kit, for Wood Door	US32D	10	\$565.52
	DD11-2200KSS	Strap Wheel Kit, for Glass Door	US32D	10	\$565.52
	DD11-2100SS	Surface Mount, Strap Wheel only, for Wood Door	US32D	10	\$430.87
	DD11-2200SS	Surface Mount, Strap Wheel only, for Glass Door	US32D	10	\$430.87
Single Wheel (Stainless Steel)					
	DD11-2378SS	Top Mount, Single Wheel, for Wood doors, 6'6"	US32D	1 15	\$575.80
	DD11-2396SS	Top Mount, Single Wheel, for Wood doors, 8'0"	US32D	1 15	\$632.30
	DD11-23S78SS	Top Mount, Single Wheel, for Wood Doors, Soft Closing, 6'6"	US32D	1 15	\$656.52
	DD11-23S96SS	Top Mount, Single Wheel, for Wood Doors, Soft Closing, 8'0"	US32D	1 15	\$713.02
Add-A-Door Kit (Less Track)					
	DD11-2300KSS	Top Mount, Single Wheel Kit, for Wood Door	US32D	10	\$452.41
	DD11-2300SS	Top Mount, Single Wheel only, for Wood door	US32D	10	\$282.76

	Model #	Description	Finish	QTY /Box	QTY /Case	List Price
Bent Strap Wheel (Steel)						
	DD11-20TR78SS	6'6" Track	US32D	2	10	\$242.37
	DD11-20TR96SS	8' Track	US32D	2	10	\$323.15
	DD01-20TR24SS	24" Extension Track	US32D	4	20	\$43.09
	DD11-10PL1BL	Hand Pull	US19	10	100	\$32.83
	DD11-10PL1SN	Hand Pull	US15	10	100	\$36.10
	DD11-10PL2BL	Recessed Flush Pull	US19	10	100	\$16.42
	DD11-10PL2SN	Recessed Flush Pull	US15	10	100	\$18.05
	DD11-10PL4BL	Handle with Flush Pull	US19	10	20	\$42.90
	DD11-10PL4SN	Handle with Flush Pull	US15	10	20	\$64.33
	DD11-PL1BL	Privacy Latch	US19	10	100	\$18.85
	DD11-PL1SN	Privacy Latch	US15	10	100	\$24.24
	DD11-12FBGBL	Adjustable Floor Roller Guide	US19	5	25	\$18.30
	DD11-12FBGSN	Adjustable Floor Roller Guide	US15	5	25	\$30.66

	Model #	Description	Finish	QTY /Box	QTY /Case	List Price
1/2" Hole 	DD01-160CP	160° Viewer, Size 1-3/8" to 2-1/4"	US26	50	400	\$4.19
	DD01-160PB	160° Viewer, Size 1-3/8" to 2-1/4"	US3	50	400	\$4.19
	DD01-160AB	160° Viewer, Size 1-3/8" to 2-1/4"	US5	50	400	\$4.19
	DD01-160SN	160° Viewer, Size 1-3/8" to 2-1/4"	US15	50	400	\$4.40
	DD01-160OB	160° Viewer, Size 1-3/8" to 2-1/4"	US10B	50	400	\$4.69
	DD01-160BL	160° Viewer, Size 1-3/8" to 2-1/4"	US19	50	400	\$4.69
9/16" Hole 	DD01-180CP	180° Viewer, Size 1-3/8" to 2-1/4"	US26	50	400	\$5.49
	DD01-180PB	180° Viewer, Size 1-3/8" to 2-1/4"	US3	50	400	\$5.49
	DD01-180AB	180° Viewer, Size 1-3/8" to 2-1/4"	US5	50	400	\$5.49
	DD01-180SN	180° Viewer, Size 1-3/8" to 2-1/4"	US15	50	400	\$6.03
	DD01-180OB	180° Viewer, Size 1-3/8" to 2-1/4"	US10B	50	400	\$6.62
	DD01-180BL	180° Viewer, Size 1-3/8" to 2-1/4"	US19	50	400	\$6.62
9/16" Hole 	DD01-181CP	180° Viewer, Size 0.98" to 1.65"	US26	50	400	\$6.03
	DD01-181SN	180° Viewer, Size 0.98" to 1.65"	US15	50	400	\$6.03
	DD01-181OB	180° Viewer, Size 0.98" to 1.65"	US10B	50	400	\$6.62
	DD01-181BL	180° Viewer, Size 0.98" to 1.65"	US19	50	400	\$6.62
1/2" Hole 	DD01-160ULCP	UL, 160° Viewer, Size 1-3/8" to 2-1/4"	US26	50	400	\$9.08
	DD01-160ULPB	UL, 160° Viewer, Size 1-3/8" to 2-1/4"	US3	50	400	\$9.08
	DD01-160ULSN	UL, 160° Viewer, Size 1-3/8" to 2-1/4"	US15	50	400	\$10.20
	DD01-160ULOB	UL, 160° Viewer, Size 1-3/8" to 2-1/4"	US10B	50	400	\$10.82
	DD01-160ULBL	UL, 160° Viewer, Size 1-3/8" to 2-1/4"	US19	50	400	\$10.82
UL Listed						
9/16" Hole 	DD01-180ULCP	UL, 180° Viewer, Size 1-3/8" to 2-1/4"	US26	50	400	\$16.52
	DD01-180ULPB	UL, 180° Viewer, Size 1-3/8" to 2-1/4"	US3	50	400	\$16.52
	DD01-180ULSN	UL, 180° Viewer, Size 1-3/8" to 2-1/4"	US15	50	400	\$18.19
	DD01-180ULOB	UL, 180° Viewer, Size 1-3/8" to 2-1/4"	US10B	50	400	\$19.81
	DD01-180ULBL	UL, 180° Viewer, Size 1-3/8" to 2-1/4"	US19	50	400	\$19.81
UL Listed						
9/16" Hole 	DD01-181ULCP	UL, 180° Viewer, Size 0.98" to 1.65"	US26	50	400	\$18.19
	DD01-181ULSN	UL, 180° Viewer, Size 0.98" to 1.65"	US15	50	400	\$18.19
	DD01-181ULOB	UL, 180° Viewer, Size 0.98" to 1.65"	US10B	50	400	\$19.81
	DD01-181ULBL	UL, 180° Viewer, Size 0.98" to 1.65"	US19	50	400	\$19.81
UL Listed						
1/2" Hole 	DD01-K160CP	4" High Knocker w/160° Viewer	US26	20	200	\$10.75
	DD01-K160PB	4" High Knocker w/160° Viewer	US3	20	200	\$10.75
	DD01-K160AB	4" High Knocker w/160° Viewer	US5	20	200	\$10.75
	DD01-K160SN	4" High Knocker w/160° Viewer	US15	20	200	\$12.88
	DD01-K160OB	4" High Knocker w/160° Viewer	US10B	20	200	\$14.46
	DD01-K160BL	4" High Knocker w/160° Viewer	US19	20	200	\$14.46

DOOR HARDWARE

	Model #	Description	Finish	QTY /Box	QTY /Case	List Price
1/2" Hole 	DD01-K160ULCP	4" High Knocker w/160° UL Viewer	US26	20	200	\$16.14
	DD01-K160ULPB	4" High Knocker w/160° UL Viewer	US3	20	200	\$16.14
	DD01-K160ULSN	4" High Knocker w/160° UL Viewer	US15	20	200	\$19.50
	DD01-K160ULOB	4" High Knocker w/160° UL Viewer	US10B	20	200	\$21.51
	DD01-K160ULBL	4" High Knocker w/160° UL Viewer	US19	20	200	\$21.51
UL Listed						
9/16" Hole 	DD01-K180CP	5-1/2" High Knocker w/180° Viewer	US26	10	100	\$13.54
	DD01-K180PB	5-1/2" High Knocker w/180° Viewer	US3	10	100	\$13.54
	DD01-K180AB	5-1/2" High Knocker w/180° Viewer	US5	10	100	\$13.54
	DD01-K180SN	5-1/2" High Knocker w/180° Viewer	US15	10	100	\$17.47
	DD01-K180OB	5-1/2" High Knocker w/180° Viewer	US10B	10	100	\$18.76
	DD01-K180BL	5-1/2" High Knocker w/180° Viewer	US19	10	100	\$18.76
9/16" Hole 	DD01-K180ULCP	5-1/2" High Knocker w/180° UL Viewer	US26	10	100	\$24.57
	DD01-K180ULPB	5-1/2" High Knocker w/180° UL Viewer	US3	10	100	\$24.57
	DD01-K180ULSN	5-1/2" High Knocker w/180° UL Viewer	US15	10	100	\$29.62
	DD01-K180ULOB	5-1/2" High Knocker w/180° UL Viewer	US10B	10	100	\$31.96
	DD01-K180ULBL	5-1/2" High Knocker w/180° UL Viewer	US19	10	100	\$31.96
UL Listed						
	DD01-180COVCP	9/16" Door Viewer Cover	US26	100	1000	\$1.38
	DD01-180COVSN	9/16" Door Viewer Cover	US15	100	1000	\$1.38
	DD01-180COVOB	9/16" Door Viewer Cover	US10B	100	1000	\$1.76
	DD01-180COVBL	9/16" Door Viewer Cover	US19	100	1000	\$1.76
	DD01-KS6PB	6" High Solid Brass Door Knocker	US3	10	50	\$43.70
	DD01-KS6SN	6" High Solid Brass Door Knocker	US15	10	50	\$49.76
	DD01-KS6OB	6" High Solid Brass Door Knocker	US10B	10	50	\$52.49
	DD01-KS8PB	8" High Solid Brass Door Knocker	US3	10	50	\$54.66
	DD01-KS8SN	8" High Solid Brass Door Knocker	US15	10	50	\$62.24
	DD01-KS8OB	8" High Solid Brass Door Knocker	US10B	10	50	\$65.60
1/2" Hole 	DD01-KS8VPB	Solid Brass Door Knocker with 160° Viewer	US3	10	50	\$56.39
	DD01-KS8VSN	Solid Brass Door Knocker with 160° Viewer	US15	10	50	\$64.15
	DD01-KS8VOB	Solid Brass Door Knocker with 160° Viewer	US10B	10	50	\$67.62

DOOR HARDWARE



Model #	Description	Finish	QTY /Box	QTY /Case	List Price
DD07-400BL	4" Zinc Nail-On House Number #0	US19	50	500	\$1.61
DD07-401BL	4" Zinc Nail-On House Number #1	US19	50	500	\$1.61
DD07-402BL	4" Zinc Nail-On House Number #2	US19	50	500	\$1.61
DD07-403BL	4" Zinc Nail-On House Number #3	US19	50	500	\$1.61
DD07-404BL	4" Zinc Nail-On House Number #4	US19	50	500	\$1.61
DD07-405BL	4" Zinc Nail-On House Number #5	US19	50	500	\$1.61
DD07-406BL	4" Zinc Nail-On House Number #6	US19	50	500	\$1.61
DD07-407BL	4" Zinc Nail-On House Number #7	US19	50	500	\$1.61
DD07-408BL	4" Zinc Nail-On House Number #8	US19	50	500	\$1.61
DD07-409BL	4" Zinc Nail-On House Number #9	US19	50	500	\$1.61
DD07-400PB	4" Zinc Nail-On House Number #0	US3	50	500	\$1.61
DD07-401PB	4" Zinc Nail-On House Number #1	US3	50	500	\$1.61
DD07-402PB	4" Zinc Nail-On House Number #2	US3	50	500	\$1.61
DD07-403PB	4" Zinc Nail-On House Number #3	US3	50	500	\$1.61
DD07-404PB	4" Zinc Nail-On House Number #4	US3	50	500	\$1.61
DD07-405PB	4" Zinc Nail-On House Number #5	US3	50	500	\$1.61
DD07-406PB	4" Zinc Nail-On House Number #6	US3	50	500	\$1.61
DD07-407PB	4" Zinc Nail-On House Number #7	US3	50	500	\$1.61
DD07-408PB	4" Zinc Nail-On House Number #8	US3	50	500	\$1.61
DD07-409PB	4" Zinc Nail-On House Number #9	US3	50	500	\$1.61



DD07-40ABL	4" Zinc Nail-On House Letter #A	US19	50	500	\$2.35
DD07-40BBL	4" Zinc Nail-On House Letter #B	US19	50	500	\$2.35
DD07-40CBL	4" Zinc Nail-On House Letter #C	US19	50	500	\$2.35
DD07-40DBL	4" Zinc Nail-On House Letter #D	US19	50	500	\$2.35
DD07-40EBL	4" Zinc Nail-On House Letter #E	US19	50	500	\$2.35
DD07-40FBL	4" Zinc Nail-On House Letter #F	US19	50	500	\$2.35
DD07-40APB	4" Zinc Nail-On House Letter #A	US3	50	500	\$2.35
DD07-40BPB	4" Zinc Nail-On House Letter #B	US3	50	500	\$2.35
DD07-40CPB	4" Zinc Nail-On House Letter #C	US3	50	500	\$2.35
DD07-40DPB	4" Zinc Nail-On House Letter #D	US3	50	500	\$2.35
DD07-40EPB	4" Zinc Nail-On House Letter #E	US3	50	500	\$2.35
DD07-40FPB	4" Zinc Nail-On House Letter #F	US3	50	500	\$2.35

DOOR HARDWARE

Model #	Description	Finish	QTY /Box	QTY /Case	List Price
DD07-4S0PB	4" Heavy Duty House Number #0	US3	10	100	\$7.61
DD07-4S1PB	4" Heavy Duty House Number #1	US3	10	100	\$7.61
DD07-4S2PB	4" Heavy Duty House Number #2	US3	10	100	\$7.61
DD07-4S3PB	4" Heavy Duty House Number #3	US3	10	100	\$7.61
DD07-4S4PB	4" Heavy Duty House Number #4	US3	10	100	\$7.61
DD07-4S5PB	4" Heavy Duty House Number #5	US3	10	100	\$7.61
DD07-4S6PB	4" Heavy Duty House Number #6	US3	10	100	\$7.61
DD07-4S7PB	4" Heavy Duty House Number #7	US3	10	100	\$7.61
DD07-4S8PB	4" Heavy Duty House Number #8	US3	10	100	\$7.61
DD07-4S9PB	4" Heavy Duty House Number #9	US3	10	100	\$7.61
DD07-4S0SN	4" Heavy Duty House Number #0	US15	10	100	\$9.08
DD07-4S1SN	4" Heavy Duty House Number #1	US15	10	100	\$9.08
DD07-4S2SN	4" Heavy Duty House Number #2	US15	10	100	\$9.08
DD07-4S3SN	4" Heavy Duty House Number #3	US15	10	100	\$9.08
DD07-4S4SN	4" Heavy Duty House Number #4	US15	10	100	\$9.08
DD07-4S5SN	4" Heavy Duty House Number #5	US15	10	100	\$9.08
DD07-4S6SN	4" Heavy Duty House Number #6	US15	10	100	\$9.08
DD07-4S7SN	4" Heavy Duty House Number #7	US15	10	100	\$9.08
DD07-4S8SN	4" Heavy Duty House Number #8	US15	10	100	\$9.08
DD07-4S9SN	4" Heavy Duty House Number #9	US15	10	100	\$9.08
DD07-4S0OB	4" Heavy Duty House Number #0	US10B	10	100	\$11.37
DD07-4S1OB	4" Heavy Duty House Number #1	US10B	10	100	\$11.37
DD07-4S2OB	4" Heavy Duty House Number #2	US10B	10	100	\$11.37
DD07-4S3OB	4" Heavy Duty House Number #3	US10B	10	100	\$11.37
DD07-4S4OB	4" Heavy Duty House Number #4	US10B	10	100	\$11.37
DD07-4S5OB	4" Heavy Duty House Number #5	US10B	10	100	\$11.37
DD07-4S6OB	4" Heavy Duty House Number #6	US10B	10	100	\$11.37
DD07-4S7OB	4" Heavy Duty House Number #7	US10B	10	100	\$11.37
DD07-4S8OB	4" Heavy Duty House Number #8	US10B	10	100	\$11.37
DD07-4S9OB	4" Heavy Duty House Number #9	US10B	10	100	\$11.37



DOOR HARDWARE



Model #	Description	Finish	QTY /Box	QTY /Case	List Price
DD07-4S0BL	4" Heavy Duty House Number #0	US19	10	100	\$11.37
DD07-4S1BL	4" Heavy Duty House Number #1	US19	10	100	\$11.37
DD07-4S2BL	4" Heavy Duty House Number #2	US19	10	100	\$11.37
DD07-4S3BL	4" Heavy Duty House Number #3	US19	10	100	\$11.37
DD07-4S4BL	4" Heavy Duty House Number #4	US19	10	100	\$11.37
DD07-4S5BL	4" Heavy Duty House Number #5	US19	10	100	\$11.37
DD07-4S6BL	4" Heavy Duty House Number #6	US19	10	100	\$11.37
DD07-4S7BL	4" Heavy Duty House Number #7	US19	10	100	\$11.37
DD07-4S8BL	4" Heavy Duty House Number #8	US19	10	100	\$11.37
DD07-4S9BL	4" Heavy Duty House Number #9	US19	10	100	\$11.37







DD07-4SAPB	4" Heavy Duty House Letter #A	US3	10	100	\$12.16
DD07-4SBPB	4" Heavy Duty House Letter #B	US3	10	100	\$12.16
DD07-4SCPb	4" Heavy Duty House Letter #C	US3	10	100	\$12.16
DD07-4SDPB	4" Heavy Duty House Letter #D	US3	10	100	\$12.16
DD07-4SASN	4" Heavy Duty House Letter #A	US15	10	100	\$12.57
DD07-4SBSN	4" Heavy Duty House Letter #B	US15	10	100	\$12.57
DD07-4SCSN	4" Heavy Duty House Letter #C	US15	10	100	\$12.57
DD07-4SDSN	4" Heavy Duty House Letter #D	US15	10	100	\$12.57
DD07-4SABL	4" Heavy Duty House Letter #A	US19	10	100	\$18.83
DD07-4SBBL	4" Heavy Duty House Letter #B	US19	10	100	\$18.83
DD07-4SCBL	4" Heavy Duty House Letter #C	US19	10	100	\$18.83
DD07-4SDBL	4" Heavy Duty House Letter #D	US19	10	100	\$18.83





Model #	Description	Finish	QTY /Box	QTY /Case	List Price
DD07-6S0PB	6" Heavy Duty House Number #0	US3	10	100	\$18.86
DD07-6S1PB	6" Heavy Duty House Number #1	US3	10	100	\$18.86
DD07-6S2PB	6" Heavy Duty House Number #2	US3	10	100	\$18.86
DD07-6S3PB	6" Heavy Duty House Number #3	US3	10	100	\$18.86
DD07-6S4PB	6" Heavy Duty House Number #4	US3	10	100	\$18.86
DD07-6S5PB	6" Heavy Duty House Number #5	US3	10	100	\$18.86
DD07-6S6PB	6" Heavy Duty House Number #6	US3	10	100	\$18.86
DD07-6S7PB	6" Heavy Duty House Number #7	US3	10	100	\$18.86
DD07-6S8PB	6" Heavy Duty House Number #8	US3	10	100	\$18.86
DD07-6S9PB	6" Heavy Duty House Number #9	US3	10	100	\$18.86
DD07-6S0SN	6" Heavy Duty House Number #0	US15	10	100	\$22.68
DD07-6S1SN	6" Heavy Duty House Number #1	US15	10	100	\$22.68
DD07-6S2SN	6" Heavy Duty House Number #2	US15	10	100	\$22.68
DD07-6S3SN	6" Heavy Duty House Number #3	US15	10	100	\$22.68
DD07-6S4SN	6" Heavy Duty House Number #4	US15	10	100	\$22.68
DD07-6S5SN	6" Heavy Duty House Number #5	US15	10	100	\$22.68
DD07-6S6SN	6" Heavy Duty House Number #6	US15	10	100	\$22.68
DD07-6S7SN	6" Heavy Duty House Number #7	US15	10	100	\$22.68
DD07-6S8SN	6" Heavy Duty House Number #8	US15	10	100	\$22.68
DD07-6S9SN	6" Heavy Duty House Number #9	US15	10	100	\$22.68
DD07-6S0OB	6" Heavy Duty House Number #0	US10B	10	100	\$26.15
DD07-6S1OB	6" Heavy Duty House Number #1	US10B	10	100	\$26.15
DD07-6S2OB	6" Heavy Duty House Number #2	US10B	10	100	\$26.15
DD07-6S3OB	6" Heavy Duty House Number #3	US10B	10	100	\$26.15
DD07-6S4OB	6" Heavy Duty House Number #4	US10B	10	100	\$26.15
DD07-6S5OB	6" Heavy Duty House Number #5	US10B	10	100	\$26.15
DD07-6S6OB	6" Heavy Duty House Number #6	US10B	10	100	\$26.15
DD07-6S7OB	6" Heavy Duty House Number #7	US10B	10	100	\$26.15
DD07-6S8OB	6" Heavy Duty House Number #8	US10B	10	100	\$26.15
DD07-6S9OB	6" Heavy Duty House Number #9	US10B	10	100	\$26.15



	Model #	Description	Finish	QTY /Box	QTY /Case	List Price
	DD02-20CP	3-1/8" Cast Door Stop	US26	100	600	\$2.07
	DD02-20PB	3-1/8" Cast Door Stop	US3	100	600	\$2.07
	DD02-20AB	3-1/8" Cast Door Stop	US5	100	600	\$2.07
	DD02-20SN	3-1/8" Cast Door Stop	US15	100	600	\$2.33
	DD02-20OB	3-1/8" Cast Door Stop	US10B	100	600	\$2.44
	DD02-20BL	3-1/8" Cast Door Stop	US19	100	600	\$2.44
	DD02-22CP	2-7/8" Light Duty Cast Door Stop	US26	100	600	\$1.92
	DD02-22PB	2-7/8" Light Duty Cast Door Stop	US3	100	600	\$1.92
	DD02-22AB	2-7/8" Light Duty Cast Door Stop	US5	100	600	\$1.92
	DD02-23CP	3" Rigid Door Stop	US26	20	200	\$11.37
	DD02-23PB	3" Rigid Door Stop	US3	20	200	\$11.37
	DD02-23SN	3" Rigid Door Stop	US15	20	200	\$13.67
	DD02-23OB	3" Rigid Door Stop	US10B	20	200	\$14.78
	DD02-23BL	3" Rigid Door Stop	US19	20	200	\$14.78
	DD02-30CP	3" Spring Stop	US26	100	500	\$1.21
	DD02-30PB	3" Spring Stop	US3	100	500	\$1.21
	DD02-30AB	3" Spring Stop	US5	100	500	\$1.21
	DD02-30SN	3" Spring Stop	US15	100	500	\$1.33
	DD02-30OB	3" Spring Stop	US10B	100	500	\$1.37
	DD02-30BL	3" Spring Stop	US19	100	500	\$1.37
	DD02-31CP	3-1/8" Heavy Duty Spring Stop	US26	100	600	\$0.86
	DD02-31PB	3-1/8" Heavy Duty Spring Stop	US3	100	600	\$0.86
	DD02-31AB	3-1/8" Heavy Duty Spring Stop	US5	100	600	\$0.86
	DD02-31SN	3-1/8" Heavy Duty Spring Stop	US15	100	600	\$0.97
	DD02-31AN	3-1/8" Heavy Duty Spring Stop	US15A	100	600	\$0.97
	DD02-31OB	3-1/8" Heavy Duty Spring Stop	US10B	100	600	\$1.16
	DD02-31BL	3-1/8" Heavy Duty Spring Stop	US19	100	600	\$1.16
	DD02-32CP	3-3/4" Jumbo Spring Stop	US26	100	400	\$1.02
	DD02-32PB	3-3/4" Jumbo Spring Stop	US3	100	400	\$1.02
	DD02-32AB	3-3/4" Jumbo Spring Stop	US5	100	400	\$1.02
	DD02-32SN	3-3/4" Jumbo Spring Stop	US15	100	400	\$1.32
	DD02-32OB	3-3/4" Jumbo Spring Stop	US10B	100	400	\$1.51
	DD02-32BL	3-3/4" Jumbo Spring Stop	US19	100	400	\$1.51

DOOR HARDWARE

	Model #	Description	Finish	QTY /Box	QTY /Case	List Price
	DD02-40CP	Hinge Pin Stop	US26	100	600	\$1.38
	DD02-40PB	Hinge Pin Stop	US3	100	600	\$1.38
	DD02-40AB	Hinge Pin Stop	US5	100	600	\$1.38
	DD02-40SN	Hinge Pin Stop	US15	100	600	\$1.59
	DD02-40OB	Hinge Pin Stop	US10B	100	600	\$1.64
	DD02-40BL	Hinge Pin Stop	US19	100	600	\$1.64
	DD02-41CP	Heavy Duty Hinge Pin Stop	US26	100	300	\$2.15
	DD02-41PB	Heavy Duty Hinge Pin Stop	US3	100	300	\$2.15
	DD02-41AB	Heavy Duty Hinge Pin Stop	US5	100	300	\$2.15
	DD02-41SN	Heavy Duty Hinge Pin Stop	US15	100	300	\$2.51
	DD02-41AN	Heavy Duty Hinge Pin Stop	US15A	100	300	\$2.51
	DD02-41OB	Heavy Duty Hinge Pin Stop	US10B	100	300	\$3.01
	DD02-41BL	Heavy Duty Hinge Pin Stop	US19	100	300	\$3.01
	DD02-42CP	Deluxe Hinge Pin Stop	US26	100	300	\$2.39
	DD02-42PB	Deluxe Hinge Pin Stop	US3	100	300	\$2.39
	DD02-42AB	Deluxe Hinge Pin Stop	US5	100	300	\$2.39
	DD02-42SN	Deluxe Hinge Pin Stop	US15	100	300	\$2.73
	DD02-42OB	Deluxe Hinge Pin Stop	US10B	100	300	\$3.47
	DD02-42BL	Deluxe Hinge Pin Stop	US19	100	300	\$3.47
	DD02-44CP	Door Security Hinge Pin Stop	US26	50	300	\$4.35
	DD02-44PB	Door Security Hinge Pin Stop	US3	50	300	\$4.35
	DD02-44AB	Door Security Hinge Pin Stop	US5	50	300	\$4.35
	DD02-44SN	Door Security Hinge Pin Stop	US15	50	300	\$4.35
	DD02-44AN	Door Security Hinge Pin Stop	US15A	50	300	\$4.35
	DD02-44OB	Door Security Hinge Pin Stop	US10B	50	300	\$4.35
	DD02-44BL	Door Security Hinge Pin Stop	US19	50	300	\$4.35
	DD02-45CP	Adjustable Hinge Pin Stop	US26	100	300	\$3.79
	DD02-45SN	Adjustable Hinge Pin Stop	US15	100	300	\$3.97
	DD02-45OB	Adjustable Hinge Pin Stop	US10B	100	300	\$4.30
	DD02-46CP	Door Saver II Hinge Pin Stop	US26	50	500	\$14.16
	DD02-46SN	Door Saver II Hinge Pin Stop	US15	50	500	\$14.16
	DD02-46OB	Door Saver II Hinge Pin Stop	US10B	50	500	\$15.56
	DD02-46BL	Door Saver II Hinge Pin Stop	US19	50	500	\$15.56
	DD02-47CP	Door Saver III Residential Hinge Pin Stop	US26	50	500	\$11.32
	DD02-47SN	Door Saver III Residential Hinge Pin Stop	US15	50	500	\$11.32
	DD02-47OB	Door Saver III Residential Hinge Pin Stop	US10B	50	500	\$12.47
	DD02-47BL	Door Saver III Residential Hinge Pin Stop	US19	50	500	\$12.47

	Model #	Description	Finish	QTY /Box	QTY /Case	List Price
	DD03-10CP	Handrail Bracket	US26	50	200	\$3.40
	DD03-10PB	Handrail Bracket	US3	50	200	\$3.40
	DD03-10AB	Handrail Bracket	US5	50	200	\$3.40
	DD03-10SN	Handrail Bracket	US15	50	200	\$4.11
	DD03-10OB	Handrail Bracket	US10B	50	200	\$4.50
	DD03-10BL	Handrail Bracket	US19	50	200	\$4.50
	DD03-11CP	Heavy Duty Handrail Bracket	US26	50	100	\$5.64
	DD03-11PB	Heavy Duty Handrail Bracket	US3	50	100	\$5.64
	DD03-11AB	Heavy Duty Handrail Bracket	US5	50	100	\$5.64
	DD03-11SN	Heavy Duty Handrail Bracket	US15	50	100	\$6.83
	DD03-11OB	Heavy Duty Handrail Bracket	US10B	50	100	\$7.46
	DD03-12CP	Jumbo Heavy Duty Handrail Bracket	US26	25	100	\$9.84
	DD03-12PB	Jumbo Heavy Duty Handrail Bracket	US3	25	100	\$9.84
	DD03-12SN	Jumbo Heavy Duty Handrail Bracket	US15	25	100	\$11.36
	DD03-12OB	Jumbo Heavy Duty Handrail Bracket	US10B	25	100	\$12.39
	DD03-12BL	Jumbo Heavy Duty Handrail Bracket	US19	25	100	\$12.39
	DD03-13CP	ADA Heavy Duty Handrail Bracket	US26	25	100	\$6.26
	DD03-13SN	ADA Heavy Duty Handrail Bracket	US15	25	100	\$6.89
	DD03-13OB	ADA Heavy Duty Handrail Bracket	US10B	25	100	\$7.52
	DD04-20	Sliding Glass Door Pin	US26	50	300	\$1.77
	DD08-10	Spring Crash Chain	US26	10	100	\$4.77
	DD08-11	Spring Crash Chain w/Vinyl	US26	10	100	\$5.22

	Model #	Description	Finish	QTY /Box	QTY /Case	List Price
 <p>*Face: 2-1/4"x1", Strike: 2-1/4"x1-3/8" Hole Size: Dia. 7/8", Depth: 1-1/8"</p>	DD05-10CP	Adj. Ball Catch w/Radius Corner Face/Strike	US26	50	200	\$4.07
	DD05-10PB	Adj. Ball Catch w/Radius Corner Face/Strike	US3	50	200	\$4.07
	DD05-10AB	Adj. Ball Catch w/Radius Corner Face/Strike	US5	50	200	\$4.07
	DD05-10SN	Adj. Ball Catch w/Radius Corner Face/Strike	US15	50	200	\$4.93
	DD05-10OB	Adj. Ball Catch w/Radius Corner Face/Strike	US10B	50	200	\$5.09
	DD05-10BL	Adj. Ball Catch w/Radius Corner Face/Strike	US19	50	200	\$5.09
	DD05-100CP	Round Corner Strike for Ball Catch	US26	200	1000	\$1.30
	DD05-100PB	Round Corner Strike for Ball Catch	US3	200	1000	\$1.30
	DD05-100AB	Round Corner Strike for Ball Catch	US5	200	1000	\$1.30
	DD05-100SN	Round Corner Strike for Ball Catch	US15	200	1000	\$1.30
	DD05-100OB	Round Corner Strike for Ball Catch	US10B	200	1000	\$1.42
	DD05-100BL	Round Corner Strike for Ball Catch	US19	200	1000	\$1.42
 <p>*Strike: 2-1/4"x1-3/8" Hole Size: Dia. 7/8", Depth: 1-1/8"</p>	DD05-30CP	Adj. Ball Catch Drive-In Style	US26	50	200	\$3.96
	DD05-30PB	Adj. Ball Catch Drive-In Style	US3	50	200	\$3.96
	DD05-30AB	Adj. Ball Catch Drive-In Style	US5	50	200	\$3.96
	DD05-30SN	Adj. Ball Catch Drive-In Style	US15	50	200	\$4.80
	DD05-30OB	Adj. Ball Catch Drive-In Style	US10B	50	200	\$5.33
	DD05-30BL	Adj. Ball Catch Drive-In Style	US19	50	200	\$5.33
	DD05-300	Adj. Ball Catch Only Drive-In Style	US26	50	300	\$3.65
	DD04-30	The Blue Thing Door Latch	Blue	100	300	\$3.43
	DD02-81	Silencer for Metal Frame	Gray	(price per bag, sold per bag only)		100/bag \$39.65
	DD02-82	Silencer for Wood Frame	Gray	(price per bag, sold per bag only)		100/bag \$59.47

	Model #	Description	Finish	QTY /Box	QTY /Case	List Price
	DD05-50CP	Quick Field-Installed Roller Catch	US26	50	200	\$2.35
	DD05-50PB	Quick Field-Installed Roller Catch	US3	50	200	\$2.35
	DD05-50AB	Quick Field-Installed Roller Catch	US5	50	200	\$2.35
	DD05-50SN	Quick Field-Installed Roller Catch	US15	50	200	\$2.73
	DD05-50OB	Quick Field-Installed Roller Catch	US10B	50	200	\$2.83
	DD05-51CP	Heavy Duty Roller Catch w/Full-lip Strike	US26	25	100	\$37.75
	DD05-51PB	Heavy Duty Roller Catch w/Full-lip Strike	US3	25	100	\$37.75
	DD05-51SN	Heavy Duty Roller Catch w/Full-lip Strike	US15	25	100	\$41.52
	DD05-51OB	Heavy Duty Roller Catch w/Full-lip Strike	US10B	25	100	\$45.29
	DD05-51BL	Heavy Duty Roller Catch w/Full-lip Strike	US19	25	100	\$45.29
	DD05-52CP	Heavy Duty Roller Catch w/T Strike	US26	25	100	\$33.69
	DD05-52PB	Heavy Duty Roller Catch w/T Strike	US3	25	100	\$33.69
	DD05-52SN	Heavy Duty Roller Catch w/T Strike	US15	25	100	\$36.80
	DD05-52OB	Heavy Duty Roller Catch w/T Strike	US10B	25	100	\$40.40
	DD05-52BL	Heavy Duty Roller Catch w/T-Strike	US19	25	100	\$40.40
	DD05-511CP	Full-lip Strike for Heavy Duty Roller Catch	US26	50	500	\$12.02
	DD05-511PB	Full-lip Strike for Heavy Duty Roller Catch	US3	50	500	\$12.02
	DD05-511SN	Full-lip Strike for Heavy Duty Roller Catch	US15	50	500	\$13.48
	DD05-511OB	Full-lip Strike for Heavy Duty Roller Catch	US10B	50	500	\$14.45
	DD05-511BL	Full-lip Strike for Heavy Duty Roller Catch	US19	50	500	\$14.45
	DD05-512CP	T-strike for Heavy Duty Roller Catch	US26	50	500	\$9.59
	DD05-512PB	T-strike for Heavy Duty Roller Catch	US3	50	500	\$9.59
	DD05-512SN	T-strike for Heavy Duty Roller Catch	US15	50	500	\$9.59
	DD05-512OB	T-strike for Heavy Duty Roller Catch	US10B	50	500	\$10.46
	DD05-512BL	T-strike for Heavy Duty Roller Catch	US19	50	500	\$10.46

DOOR HARDWARE

	Model #	Description	Finish	QTY /Box	QTY /Case	List Price
	DD05-60CP	6" Flush Bolt--Round Corner	US26	25	100	\$14.10
	DD05-60PB	6" Flush Bolt--Round Corner	US3	25	100	\$14.10
	DD05-60AB	6" Flush Bolt--Round Corner	US5	25	100	\$14.10
	DD05-60SN	6" Flush Bolt--Round Corner	US15	25	100	\$16.12
	DD05-60OB	6" Flush Bolt--Round Corner	US10B	25	100	\$16.79
	DD05-60BL	6" Flush Bolt--Round Corner	US19	25	100	\$16.79
	DD05-61CP	6" Flush Bolt--Square Corner	US26	25	100	\$14.10
	DD05-61PB	6" Flush Bolt--Square Corner	US3	25	100	\$14.10
	DD05-61SN	6" Flush Bolt--Square Corner	US15	25	100	\$16.12
	DD05-61OB	6" Flush Bolt--Square Corner	US10B	25	100	\$16.79
	DD05-600CP	Strikes and Screws only for DD05-60/61	US26	50	500	\$2.39
	DD05-600PB	Strikes and Screws only for DD05-60/61	US3	50	500	\$2.39
	DD05-600SN	Strikes and Screws only for DD05-60/61	US15	50	500	\$2.94
	DD05-600OB	Strikes and Screws only for DD05-60/61	US10B	50	500	\$3.29
	DD05-600BL	Strikes and Screws only for DD05-60/61	US19	50	500	\$3.29
	DD05-62CP	7" Single Route Flush Bolt-Round Corner	US26	25	100	\$13.96
	DD05-62PB	7" Single Route Flush Bolt-Round Corner	US3	25	100	\$13.96
	DD05-62SN	7" Single Route Flush Bolt-Round Corner	US15	25	100	\$15.35
	DD05-62OB	7" Single Route Flush Bolt-Round Corner	US10B	25	100	\$16.71
	DD05-602CP	Strikes and Screws only for DD05-62	US26	50	500	\$2.39
	DD05-602PB	Strikes and Screws only for DD05-62	US3	50	500	\$2.39
	DD05-602SN	Strikes and Screws only for DD05-62	US15	50	500	\$2.94
	DD05-602OB	Strikes and Screws only for DD05-62	US10B	50	500	\$3.29
	DD05-700CP	Strikes and Screws only for Surface Bolt	US26	50	500	\$1.04
	DD05-700PB	Strikes and Screws only for Surface Bolt	US3	50	500	\$1.04
	DD05-700AB	Strikes and Screws only for Surface Bolt	US5	50	500	\$1.04
	DD05-700SN	Strikes and Screws only for Surface Bolt	US15	50	500	\$1.16
	DD05-700OB	Strikes and Screws only for Surface Bolt	US10B	50	500	\$1.25

DOOR HARDWARE

	Model #	Description	Finish	QTY /Box	QTY /Case	List Price
	DD05-703CP	3" Surface Bolt	US26	50	250	\$10.59
	DD05-703PB	3" Surface Bolt	US3	50	250	\$10.59
	DD05-703AB	3" Surface Bolt	US5	50	250	\$10.59
	DD05-704CP	4" Surface Bolt	US26	50	100	\$11.73
	DD05-704PB	4" Surface Bolt	US3	50	100	\$11.73
	DD05-704AB	4" Surface Bolt	US5	50	100	\$11.73
	DD05-704SN	4" Surface Bolt	US15	50	100	\$13.65
	DD05-704OB	4" Surface Bolt	US10B	50	100	\$14.74
	DD05-706CP	6" Surface Bolt	US26	50	100	\$17.14
	DD05-706PB	6" Surface Bolt	US3	50	100	\$17.14
	DD05-706AB	6" Surface Bolt	US5	50	100	\$17.14
	DD05-706SN	6" Surface Bolt	US15	50	100	\$19.14
	DD05-706AN	6" Surface Bolt	US15A	50	100	\$19.14
	DD05-706OB	6" Surface Bolt	US10B	50	100	\$20.54
	DD06-10CP	1-1/4" Bi-fold Knob with Back Plate	US26	20	200	\$5.17
	DD06-10PB	1-1/4" Bi-fold Knob with Back Plate	US3	20	200	\$5.17
	DD06-10AB	1-1/4" Bi-fold Knob with Back Plate	US5	20	200	\$5.17
	DD06-10SN	1-1/4" Bi-fold Knob with Back Plate	US15	20	200	\$5.87
	DD06-10OB	1-1/4" Bi-fold Knob with Back Plate	US10B	20	200	\$6.13
	DD06-10BL	1-1/4" Bi-fold Knob with Back Plate	US19	20	200	\$6.13
	DD06-11CP	1-1/4" Bi-fold Knob Only	US26	50	200	\$4.04
	DD06-11PB	1-1/4" Bi-fold Knob Only	US3	50	200	\$4.04
	DD06-11AB	1-1/4" Bi-fold Knob Only	US5	50	200	\$4.04
	DD06-11SN	1-1/4" Bi-fold Knob Only	US15	50	200	\$4.58
	DD06-11OB	1-1/4" Bi-fold Knob Only	US10B	50	200	\$4.90
	DD06-11BL	1-1/4" Bi-fold Knob Only	US19	50	200	\$4.90

DOOR HARDWARE

	Model #	Description	Finish	QTY /Box	QTY /Case	List Price
	DD06-20CP	2-1/8" Finger Pull, Snap-In Installation (no nail)	US26	100	500	\$1.50
	DD06-20PB	2-1/8" Finger Pull, Snap-In Installation (no nail)	US3	100	500	\$1.50
	DD06-20AB	2-1/8" Finger Pull, Snap-In Installation (no nail)	US5	100	500	\$1.50
	DD06-20SN	2-1/8" Finger Pull, Snap-In Installation (no nail)	US15	100	500	\$1.60
	DD06-20OB	2-1/8" Finger Pull, Snap-In Installation (no nail)	US10B	100	500	\$1.72
	DD06-20BL	2-1/8" Finger Pull, Snap-In Installation (no nail)	US19	100	500	\$1.72
	DD06-31WC	Single Leaf Shelf & Rod Support Bracket	White		20	\$3.20
	DD06-32WC	Heavy Duty Adj. Shelf & Rod Support Bracket	White		20	\$5.09
	DD06-33WC	Heavy Duty Fixed Shelf & Rod Support Bracket	White		20	\$5.46
	DD06-34WC	Heavy Duty Fixed Shelf Bracket	White		20	\$5.26
	DD06-40WC	White Plastic Pole Socket Set (1-3/8")	White	50	500	\$1.18
	DD06-42PB	Metal Pole Socket Set (1-1/2")	US3	10	100	\$9.55
	DD06-42WH	Metal Pole Socket Set (1-1/2")	White	10	100	\$9.55
	DD06-42SN	Metal Pole Socket Set (1-1/2")	US15	10	100	\$10.00
	DD06-42OB	Metal Pole Socket Set (1-1/2")	US10B	10	100	\$11.13
	DD06-42BL	Metal Pole Socket Set (1-1/2")	US19	10	100	\$11.13

SLIDING DOOR LOCKS (Kwikset Style)



Model #	Function	Finish	QTY /Case	Lbs /Case	List Price
PF1210	Privacy	US26	48	21	\$17.16
PF1230	Passage	US26	48	17	\$14.54
PF1710	Privacy	US3	48	21	\$17.16
PF1730	Passage	US3	48	17	\$14.54
PF1810	Privacy	US5	48	21	\$17.16
PF1830	Passage	US5	48	17	\$14.54
PF1C10	Privacy	US15A	48	21	\$17.91
PF1C30	Passage	US15A	48	17	\$15.23
PF1D10	Privacy	US12P	48	21	\$20.22
PF1D30	Passage	US12P	48	17	\$17.20
PF1910	Privacy	US19	48	21	\$20.22
PF1930	Passage	US19	48	17	\$17.20
PF1P10	Privacy	US15	48	21	\$17.91
PF1P30	Passage	US15	48	17	\$15.23

* Fit door thickness: 1-5/16" ~1-9/16". For thicker doors (up to 1-3/4"), please specify.
 * Metal thumb turn

Notching Dimensions

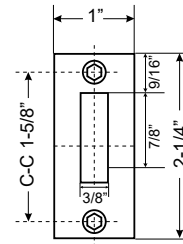
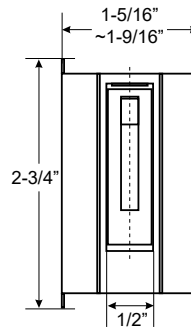
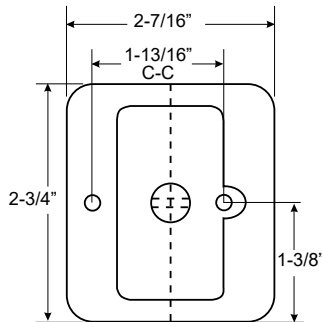
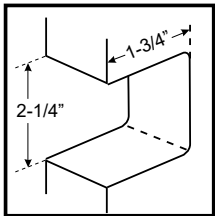

DOOR HARDWARE

SLIDING DOOR LOCKS (Kwikset Style)

	Model #	Function	Finish	QTY /Case	Lbs /Case	List Price
	2-3/8" Backset Standard					
	PF2210	Privacy	US26	24	21	\$38.15
	PF2230	Passage	US26	24	17	\$34.35
	PF2D10	Privacy	US12P	24	21	\$42.39
	PF2D30	Passage	US12P	24	17	\$38.15
	PF2910	Privacy	US19	24	21	\$42.39
	PF2930	Passage	US19	24	17	\$38.15
	PF2P10	Privacy	US15	24	21	\$38.15
	PF2P30	Passage	US15	24	17	\$34.35
	PF2S10	Privacy	US26D	24	21	\$38.15
PF2S30	Passage	US26D	24	17	\$34.35	
	PTR21	2-3/8" Privacy Latch	US26	200		\$8.84
	PTRD1	2-3/8" Privacy Latch	US12P	200		\$8.84
	PTR91	2-3/8" Privacy Latch	US19	200		\$8.84
	PTRP1	2-3/8" Privacy Latch	US15	200		\$8.84
	PTRS1	2-3/8" Privacy Latch	US26D	200		\$8.84
	PTR22	2-3/8" Passage Latch	US26	200		\$8.84
	PTRD2	2-3/8" Passage Latch	US12P	200		\$8.84
	PTR92	2-3/8" Passage Latch	US19	200		\$8.84
	PTRP2	2-3/8" Passage Latch	US15	200		\$8.84
	PTRS2	2-3/8" Passage Latch	US26D	200		\$8.84
	PTR23	2-3/4" Privacy Latch	US26	200		\$8.84
	PTRD3	2-3/4" Privacy Latch	US12P	200		\$8.84
	PTR93	2-3/4" Privacy Latch	US19	200		\$8.84
	PTRP3	2-3/4" Privacy Latch	US15	200		\$8.84
	PTRS3	2-3/4" Privacy Latch	US26D	200		\$8.84
	PTR24	2-3/4" Passage Latch	US26	200		\$8.84
	PTRD4	2-3/4" Passage Latch	US12P	200		\$8.84
	PTR94	2-3/4" Passage Latch	US19	200		\$8.84
	PTRP4	2-3/4" Passage Latch	US15	200		\$8.84
	PTRS4	2-3/4" Passage Latch	US26D	200		\$8.84

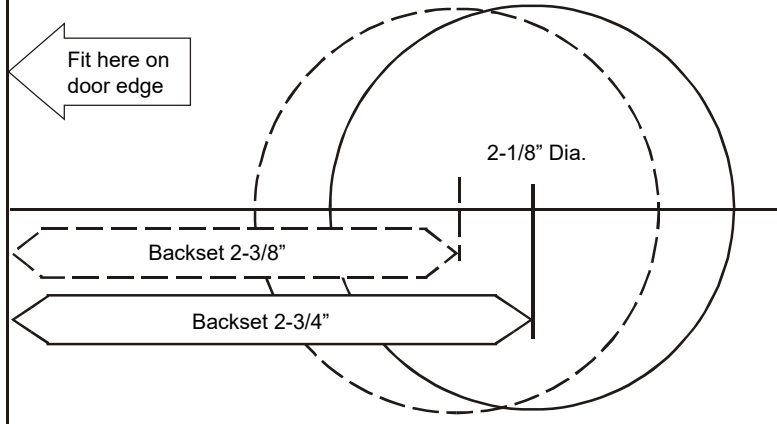





DOOR HARDWARE

	Model #	Description	Finish	QTY /Case	List Price
	BC12BL-21	Single Robe Hook	US19	50	\$28.05
	BC12CP-21	Single Robe Hook	US26	50	\$22.96
	BC12SN-21	Single Robe Hook	US15	50	\$25.25
	BC12BL-32	Metal Towel Ring	US19	50	\$55.50
	BC12CP-32	Metal Towel Ring	US26	50	\$45.39
	BC12SN-32	Metal Towel Ring	US15	50	\$49.95
	BC12BL-30	Metal Circle Towel Ring	US19	50	\$38.13
	BC12CP-30	Metal Circle Towel Ring	US26	50	\$40.99
	BC12SN-30	Metal Circle Towel Ring	US15	50	\$47.43
	BC12BL-42	Surface Paper Holder	US19	50	\$60.02
	BC12CP-42	Surface Paper Holder	US26	50	\$49.11
	BC12SN-42	Surface Paper Holder	US15	50	\$54.02
	BC12BL-43	European-Style Paper Holder	US19	50	\$53.67
	BC12CP-43	European-Style Paper Holder	US26	50	\$43.93
	BC12SN-43	European-Style Paper Holder	US15	50	\$48.31
	BC12BL-45	Straight Post Paper Holder	US19	25	\$60.02
	BC12CP-45	Straight Post Paper Holder	US26	25	\$49.11
	BC12SN-45	Straight Post Paper Holder	US15	25	\$54.02
	BC12BL-48	Pivot Paper Holder	US19	25	\$82.45
	BC12CP-48	Pivot Paper Holder	US26	25	\$68.87
	BC12SN-48	Pivot Paper Holder	US15	25	\$75.54

	Model #	Description	Finish	QTY /Case	List Price
	BC12BL-15800	Posts (Pair) for 5/8" Round Bar	US19	50	\$52.97
	BC12CP-15800	Posts (Pair) for 5/8" Round Bar	US26	50	\$43.33
	BC12SN-15800	Posts (Pair) for 5/8" Round Bar	US15	50	\$47.68
5/8" Round Towel Bar Set					
	BC12BL-15818	18"x 5/8" Towel Bar Set	US19	25	\$61.13
	BC12BL-15824	24"x 5/8" Towel Bar Set	US19	25	\$64.02
	BC12BL-15830	30"x 5/8" Towel Bar Set	US19	25	\$66.30
	BC12CP-15818	18"x 5/8" Towel Bar Set	US26	25	\$49.91
	BC12CP-15824	24"x 5/8" Towel Bar Set	US26	25	\$52.39
	BC12CP-15830	30"x 5/8" Towel Bar Set	US26	25	\$54.27
	BC12SN-15818	18"x 5/8" Towel Bar Set	US15	25	\$54.90
	BC12SN-15824	24"x 5/8" Towel Bar Set	US15	25	\$57.63
	BC12SN-15830	30"x 5/8" Towel Bar Set	US15	25	\$59.68
	BC12BL-15800D	Posts (Pair) for 5/8" Double Round Bar	US19	25	\$83.17
	BC12CP-15800D	Posts (Pair) for 5/8" Double Round Bar	US26	25	\$69.35
	BC12SN-15800D	Posts (Pair) for 5/8" Double Round Bar	US15	25	\$76.26
5/8" Round Double Towel Bar Set					
	BC12BL-15824D	24"x 5/8" Double Towel Bar Set	US19	25	\$100.57
	BC12CP-15824D	24"x 5/8" Double Towel Bar Set	US26	25	\$83.88
	BC12SN-15824D	24"x 5/8" Double Towel Bar Set	US15	25	\$92.23



	Model #	Description	Finish	QTY /Case	List Price
	BC14BL-21	Single Robe Hook	US19	50	\$28.05
	BC14CP-21	Single Robe Hook	US26	50	\$22.96
	BC14SN-21	Single Robe Hook	US15	50	\$25.25
	BC14BL-32	Metal Towel Ring	US19	50	\$55.50
	BC14CP-32	Metal Towel Ring	US26	50	\$45.39
	BC14SN-32	Metal Towel Ring	US15	50	\$49.95
	BC14BL-30	Metal Circle Towel Ring	US19	50	\$38.13
	BC14CP-30	Metal Circle Towel Ring	US26	50	\$40.99
	BC14SN-30	Metal Circle Towel Ring	US15	50	\$47.43
	BC14BL-42	Surface Paper Holder	US19	50	\$60.02
	BC14CP-42	Surface Paper Holder	US26	50	\$49.11
	BC14SN-42	Surface Paper Holder	US15	50	\$54.02
	BC14BL-43	European-Style Paper Holder	US19	50	\$53.67
	BC14CP-43	European-Style Paper Holder	US26	50	\$43.93
	BC14SN-43	European-Style Paper Holder	US15	50	\$48.31
	BC14BL-45	Straight Post Paper Holder	US19	25	\$60.02
	BC14CP-45	Straight Post Paper Holder	US26	25	\$49.11
	BC14SN-45	Straight Post Paper Holder	US15	25	\$54.02
	BC14BL-48	Pivot Paper Holder	US19	25	\$82.45
	BC14CP-48	Pivot Paper Holder	US26	25	\$68.87
	BC14SN-48	Pivot Paper Holder	US15	25	\$75.54



	Model #	Description	Finish	QTY /Case	List Price
	BC14BL-15800	Posts (Pair) for 5/8" Round Bar	US19	50	\$52.97
	BC14CP-15800	Posts (Pair) for 5/8" Round Bar	US26	50	\$43.33
	BC14SN-15800	Posts (Pair) for 5/8" Round Bar	US15	50	\$47.68
5/8" Round Towel Bar Set					
	BC14BL-15818	18"x 5/8" Towel Bar Set	US19	25	\$61.13
	BC14BL-15824	24"x 5/8" Towel Bar Set	US19	25	\$64.02
	BC14BL-15830	30"x 5/8" Towel Bar Set	US19	25	\$66.30
	BC14CP-15818	18"x 5/8" Towel Bar Set	US26	25	\$49.91
	BC14CP-15824	24"x 5/8" Towel Bar Set	US26	25	\$52.39
	BC14CP-15830	30"x 5/8" Towel Bar Set	US26	25	\$54.27
	BC14SN-15818	18"x 5/8" Towel Bar Set	US15	25	\$54.90
	BC14SN-15824	24"x 5/8" Towel Bar Set	US15	25	\$57.63
	BC14SN-15830	30"x 5/8" Towel Bar Set	US15	25	\$59.68
	BC14BL-15800D	Posts (Pair) for 5/8" Double Round Bar	US19	25	\$83.17
	BC14CP-15800D	Posts (Pair) for 5/8" Double Round Bar	US26	25	\$69.35
	BC14SN-15800D	Posts (Pair) for 5/8" Double Round Bar	US15	25	\$76.26
5/8" Round Double Towel Bar Set					
	BC14BL-15824D	24"x 5/8" Double Towel Bar Set	US19	25	\$100.57
	BC14CP-15824D	24"x 5/8" Double Towel Bar Set	US26	25	\$83.88
	BC14SN-15824D	24"x 5/8" Double Towel Bar Set	US15	25	\$92.23

	Model #	Description	Finish	QTY /Case	List Price
	BS9CP-22	Double Robe Hook	US26	20	\$26.10
	BS9PB-22	Double Robe Hook	US3	20	\$26.10
	BS9SN-22	Double Robe Hook	US15	20	\$28.70
	BS9CP-50	T/T Holder with Glass Tumbler	US26	20	\$37.81
	BS9PB-50	T/T Holder with Glass Tumbler	US3	20	\$37.81
	BS9SN-50	T/T Holder with Glass Tumbler	US15	20	\$41.59
	BS9CP-60	Soap Holder with Glass Dish	US26	20	\$37.81
	BS9PB-60	Soap Holder with Glass Dish	US3	20	\$37.81
	BS9SN-60	Soap Holder with Glass Dish	US15	20	\$41.59
	BS9CP-30	Metal Towel Ring	US26	20	\$32.83
	BS9PB-30	Metal Towel Ring	US3	20	\$32.83
	BS9SN-30	Metal Towel Ring	US15	20	\$36.09
	BS9CP-42	Surface Paper Holder	US26	20	\$52.17
	BS9PB-42	Surface Paper Holder	US3	20	\$52.17
	BS9SN-42	Surface Paper Holder	US15	20	\$57.40
	BS9CP-43	European-Style Paper Holder	US26	20	\$46.33
	BS9PB-43	European-Style Paper Holder	US3	20	\$46.33
	BS9SN-43	European-Style Paper Holder	US15	20	\$50.97

Model #	Description	Finish	QTY /Case	List Price	
5/8" Round Towel Bar Set					
BS9CP-15818	18" x 5/8" Towel Bar Set	US26	20	\$53.49	
BS9CP-15824	24" x 5/8" Towel Bar Set	US26	20	\$57.13	
BS9CP-15830	30" x 5/8" Towel Bar Set	US26	20	\$60.28	
	BS9PB-15818	18" x 5/8" Towel Bar Set	US3	20	\$53.49
	BS9PB-15824	24" x 5/8" Towel Bar Set	US3	20	\$57.13
	BS9PB-15830	30" x 5/8" Towel Bar Set	US3	20	\$60.28
	BS9SN-15818	18" x 5/8" Towel Bar Set	US15	20	\$58.84
	BS9SN-15824	24" x 5/8" Towel Bar Set	US15	20	\$62.82
	BS9SN-15830	30" x 5/8" Towel Bar Set	US15	20	\$66.30





5/8" Round Double Towel Bar Set					
	BS9CP-15824D	24" x 5/8" Double Towel Bar Shelf	US26	20	\$92.67
	BS9PB-15824D	24" x 5/8" Double Towel Bar Shelf	US3	20	\$92.67
	BS9SN-15824D	24" x 5/8" Double Towel Bar Shelf	US15	20	\$101.91

	Model #	Description	Finish	QTY /Case	List Price
	BS8CP-22	Double Robe Hook	US26	20	\$26.10
	BS8PB-22	Double Robe Hook	US3	20	\$26.10
	BS8SN-22	Double Robe Hook	US15	20	\$28.70
	BS8CP-50	T/T Holder with Glass Tumbler	US26	20	\$37.81
	BS8PB-50	T/T Holder with Glass Tumbler	US3	20	\$37.81
	BS8SN-50	T/T Holder with Glass Tumbler	US15	20	\$41.59
	BS8CP-60	Soap Holder with Glass Dish	US26	20	\$37.81
	BS8PB-60	Soap Holder with Glass Dish	US3	20	\$37.81
	BS8SN-60	Soap Holder with Glass Dish	US15	20	\$41.59
	BS8CP-30	Metal Towel Ring	US26	20	\$32.83
	BS8PB-30	Metal Towel Ring	US3	20	\$32.83
	BS8SN-30	Metal Towel Ring	US15	20	\$36.09
	BS8CP-42	Surface Paper Holder	US26	20	\$52.17
	BS8PB-42	Surface Paper Holder	US3	20	\$52.17
	BS8SN-42	Surface Paper Holder	US15	20	\$57.40
	BS8CP-43	European-Style Paper Holder	US26	20	\$46.33
	BS8PB-43	European-Style Paper Holder	US3	20	\$46.33
	BS8SN-43	European-Style Paper Holder	US15	20	\$50.97

Model #	Description	Finish	QTY /Case	List Price
5/8" Round Towel Bar Set				
BS8CP-15818	18" x 5/8" Towel Bar Set	US26	20	\$53.49
BS8CP-15824	24" x 5/8" Towel Bar Set	US26	20	\$57.13
BS8CP-15830	30" x 5/8" Towel Bar Set	US26	20	\$60.28
				
BS8PB-15818	18" x 5/8" Towel Bar Set	US3	20	\$53.49
BS8PB-15824	24" x 5/8" Towel Bar Set	US3	20	\$57.13
BS8PB-15830	30" x 5/8" Towel Bar Set	US3	20	\$60.28
				
BS8SN-15818	18" x 5/8" Towel Bar Set	US15	20	\$58.84
BS8SN-15824	24" x 5/8" Towel Bar Set	US15	20	\$62.82
BS8SN-15830	30" x 5/8" Towel Bar Set	US15	20	\$66.30

5/8" Round Double Towel Bar Set				
BS8CP-15824D	24" x 5/8" Double Towel Bar Shelf	US26	20	\$92.67
BS8PB-15824D	24" x 5/8" Double Towel Bar Shelf	US3	20	\$92.67
BS8SN-15824D	24" x 5/8" Double Towel Bar Shelf	US15	20	\$101.91









	Model #	Description	Finish	QTY /Case	List Price
	BC10CP-22	Double Robe Hook	US26	50	\$18.93
	BC10SN-22	Double Robe Hook	US15	50	\$20.84
	BC10VB-22	Double Robe Hook	US11P	50	\$22.72
	BC10BL-22	Double Robe Hook	US19	50	\$22.72
	BC10CP-32	Metal Towel Ring	US26	50	\$37.47
	BC10SN-32	Metal Towel Ring	US15	50	\$41.21
	BC10VB-32	Metal Towel Ring	US11P	50	\$44.98
	BC10BL-32	Metal Towel Ring	US19	50	\$44.98
	BC10CP-42	Surface Paper Holder	US26	50	\$40.54
	BC10SN-42	Surface Paper Holder	US15	50	\$44.59
	BC10VB-42	Surface Paper Holder	US11P	50	\$48.65
	BC10BL-42	Surface Paper Holder	US19	50	\$48.65
	BC10CP-43	European-Style Paper Holder	US26	50	\$36.25
	BC10SN-43	European-Style Paper Holder	US15	50	\$39.90
	BC10VB-43	European-Style Paper Holder	US11P	50	\$43.53
	BC10BL-43	European-Style Paper Holder	US19	50	\$43.53

Model #	Description	Finish	QTY /Case	List Price
 BC10CP-13800	Posts (Pair) for 3/4" Round Bar	US26	50	\$36.09
BC10SN-13800	Posts (Pair) for 3/4" Round Bar	US15	50	\$39.35
BC10VB-13800	Posts (Pair) for 3/4" Round Bar	US11P	50	\$42.93
BC10BL-13800	Posts (Pair) for 3/4" Round Bar	US19	50	\$42.93

3/4" Round Towel Bar Set





 BC10CP-13818	18" X 3/4" Towel Bar Set	US26	25	\$41.20
BC10CP-13824	24" X 3/4" Towel Bar Set	US26	25	\$43.24
BC10CP-13830	30" X 3/4" Towel Bar Set	US26	25	\$44.80
BC10SN-13818	18" X 3/4" Towel Bar Set	US15	25	\$45.33
BC10SN-13824	24" X 3/4" Towel Bar Set	US15	25	\$47.59
BC10SN-13830	30" X 3/4" Towel Bar Set	US15	25	\$49.27
BC10VB-13818	18" X 3/4" Towel Bar Set	US11P	25	\$49.47
BC10VB-13824	24" X 3/4" Towel Bar Set	US11P	25	\$51.91
BC10VB-13830	30" X 3/4" Towel Bar Set	US11P	25	\$53.75
BC10BL-13818	18" X 3/4" Towel Bar Set	US19	25	\$49.47
BC10BL-13824	24" X 3/4" Towel Bar Set	US19	25	\$51.91
BC10BL-13830	30" X 3/4" Towel Bar Set	US19	25	\$53.75

	Model #	Description	Finish	QTY /Case	List Price
	BC7CP-22	Double Robe Hook	US26	20	\$16.58
	BC7PB-22	Double Robe Hook	US3	20	\$16.58
	BC7SN-22	Double Robe Hook	US15	20	\$18.21
	BC7AN-22	Double Robe Hook	US15A	20	\$18.21
	BC7VB-22	Double Robe Hook	US11P	20	\$19.89
	BC7DB-22	Double Robe Hook	US12P	20	\$19.89
	BC7BL-22	Double Robe Hook	US19	20	\$19.89
	BC7CP-50	T/T Holder with Acrylic Tumbler	US26	20	\$20.83
	BC7PB-50	T/T Holder with Acrylic Tumbler	US3	20	\$20.83
	BC7SN-50	T/T Holder with Acrylic Tumbler	US15	20	\$22.94
	BC7DB-50	T/T Holder with Acrylic Tumbler	US12P	20	\$25.03
	BC7CP-60	Soap Holder with Acrylic Dish	US26	20	\$20.83
	BC7PB-60	Soap Holder with Acrylic Dish	US3	20	\$20.83
	BC7SN-60	Soap Holder with Acrylic Dish	US15	20	\$22.94
	BC7DB-60	Soap Holder with Acrylic Dish	US12P	20	\$25.03
	BC7CP-30	Metal Towel Ring	US26	50	\$21.88
	BC7PB-30	Metal Towel Ring	US3	50	\$21.88
	BC7SN-30	Metal Towel Ring	US15	50	\$24.04
	BC7AN-30	Metal Towel Ring	US15A	50	\$24.04
	BC7VB-30	Metal Towel Ring	US11P	50	\$26.23
	BC7DB-30	Metal Towel Ring	US12P	50	\$26.23
	BC7BL-30	Metal Towel Ring	US19	50	\$26.23

Model #	Description	Finish	QTY /Case	List Price	
	BC7CP-42	Surface Paper Holder	US26	50	\$35.48
	BC7PB-42	Surface Paper Holder	US3	50	\$35.48
	BC7SN-42	Surface Paper Holder	US15	50	\$39.04
	BC7AN-42	Surface Paper Holder	US15A	50	\$39.04
	BC7VB-42	Surface Paper Holder	US11P	50	\$42.58
	BC7DB-42	Surface Paper Holder	US12P	50	\$42.58
	BC7BL-42	Surface Paper Holder	US19	50	\$42.58
	BC7CP-43	European-Style Paper Holder	US26	50	\$31.73
	BC7PB-43	European-Style Paper Holder	US3	50	\$31.73
	BC7SN-43	European-Style Paper Holder	US15	50	\$34.90
	BC7AN-43	European-Style Paper Holder	US15A	50	\$34.90
	BC7VB-43	European-Style Paper Holder	US11P	50	\$38.09
	BC7DB-43	European-Style Paper Holder	US12P	50	\$38.09
	BC7BL-43	European-Style Paper Holder	US19	50	\$38.09
	BC7CP-13800	Posts (Pair) for 3/4" Round Bar	US26	50	\$31.27
	BC7PB-13800	Posts (Pair) for 3/4" Round Bar	US3	50	\$31.27
	BC7SN-13800	Posts (Pair) for 3/4" Round Bar	US15	50	\$34.42
	BC7AN-13800	Posts (Pair) for 3/4" Round Bar	US15A	50	\$34.42
	BC7VB-13800	Posts (Pair) for 3/4" Round Bar	US11P	50	\$37.54
	BC7DB-13800	Posts (Pair) for 3/4" Round Bar	US12P	50	\$37.54
	BC7BL-13800	Posts (Pair) for 3/4" Round Bar	US19	50	\$37.54

Model #	Description	Finish	QTY /Case	List Price
3/4" Round Towel Bar Set				
BC7CP-13818	18" X 3/4" Towel Bar Set	US26	25	\$36.04
BC7CP-13824	24" X 3/4" Towel Bar Set	US26	25	\$37.83
BC7CP-13830	30" X 3/4" Towel Bar Set	US26	25	\$39.17
BC7PB-13818	18" X 3/4" Towel Bar Set	US3	25	\$36.04
BC7PB-13824	24" X 3/4" Towel Bar Set	US3	25	\$37.83
BC7PB-13830	30" X 3/4" Towel Bar Set	US3	25	\$39.17
BC7SN-13818	18" X 3/4" Towel Bar Set	US15	25	\$39.66
BC7SN-13824	24" X 3/4" Towel Bar Set	US15	25	\$41.63
BC7SN-13830	30" X 3/4" Towel Bar Set	US15	25	\$43.10
BC7AN-13818	18" X 3/4" Towel Bar Set	US15A	25	\$39.66
BC7AN-13824	24" X 3/4" Towel Bar Set	US15A	25	\$41.63
BC7AN-13830	30" X 3/4" Towel Bar Set	US15A	25	\$43.10
BC7VB-13818	18" X 3/4" Towel Bar Set	US11P	25	\$43.24
BC7VB-13824	24" X 3/4" Towel Bar Set	US11P	25	\$45.42
BC7VB-13830	30" X 3/4" Towel Bar Set	US11P	25	\$47.00
BC7DB-13818	18" X 3/4" Towel Bar Set	US12P	25	\$43.24
BC7DB-13824	24" X 3/4" Towel Bar Set	US12P	25	\$45.42
BC7DB-13830	30" X 3/4" Towel Bar Set	US12P	25	\$47.00
BC7BL-13818	18" X 3/4" Towel Bar Set	US19	25	\$43.24
BC7BL-13824	24" X 3/4" Towel Bar Set	US19	25	\$45.42
BC7BL-13830	30" X 3/4" Towel Bar Set	US19	25	\$47.00
5/8" Round Double Towel Bar Set				
BC7CP-15824D	24" X 5/8" Double Towel Bar Shelf	US26	25	\$60.54
BC7SN-15824D	24" X 5/8" Double Towel Bar Shelf	US15	25	\$66.60
BC7VB-15824D	24" X 5/8" Double Towel Bar Shelf	US11P	25	\$72.65
BC7DB-15824D	24" X 5/8" Double Towel Bar Shelf	US12P	25	\$72.65
BC7BL-15824D	24" X 5/8" Double Towel Bar Shelf	US19	25	\$72.65



	Model #	Description	Finish	QTY /Case	List Price
	BC6CP-22	Double Robe Hook	US26	50	\$15.73
	BC6PB-22	Double Robe Hook	US3	50	\$15.73
	BC6SN-22	Double Robe Hook	US15	50	\$17.33
	BC6DB-22	Double Robe Hook	US12P	50	\$18.89
	BC6BL-22	Double Robe Hook (in stock)	US19	50	\$18.89
	BC6CP-50	T/T Holder with Acrylic Tumbler	US26	20	\$17.82
	BC6PB-50	T/T Holder with Acrylic Tumbler	US3	20	\$17.82
	BC6SN-50	T/T Holder with Acrylic Tumbler	US15	20	\$19.56
	BC6CP-60	Soap Holder with Acrylic Dish	US26	20	\$17.82
	BC6PB-60	Soap Holder with Acrylic Dish	US3	20	\$17.82
	BC6SN-60	Soap Holder with Acrylic Dish	US15	20	\$19.56
	BC6CP-30	Metal Towel Ring	US26	50	\$20.76
	BC6PB-30	Metal Towel Ring	US3	50	\$20.76
	BC6SN-30	Metal Towel Ring	US15	50	\$22.86
	BC6DB-30	Metal Towel Ring	US12P	50	\$24.93
	BC6BL-30	Metal Towel Ring (in stock)	US19	50	\$24.93
	BC6CP-42	Surface Paper Holder	US26	50	\$33.68
	BC6PB-42	Surface Paper Holder	US3	50	\$33.68
	BC6SN-42	Surface Paper Holder	US15	50	\$37.05
	BC6DB-42	Surface Paper Holder	US12P	50	\$40.43
	BC6BL-42	Surface Paper Holder (in stock)	US19	50	\$40.43
	BC6CP-43	European-Style Paper Holder	US26	50	\$30.15
	BC6PB-43	European-Style Paper Holder	US3	50	\$30.15
	BC6SN-43	European-Style Paper Holder	US15	50	\$33.17
	BC6DB-43	European-Style Paper Holder	US12P	50	\$36.18
	BC6BL-43	European-Style Paper Holder (in stock)	US19	50	\$36.18

Model #	Description	Finish	QTY /Case	List Price
BC6CP-13800	Posts (Pair) for 3/4" Round Bar	US26	50	\$29.76
BC6PB-13800	Posts (Pair) for 3/4" Round Bar	US3	50	\$29.76
BC6SN-13800	Posts (Pair) for 3/4" Round Bar	US15	50	\$32.75
BC6DB-13800	Posts (Pair) for 3/4" Round Bar	US12P	50	\$35.72
BC6BL-13800	Posts (Pair) for 3/4" Round Bar (in stock)	US19	50	\$35.72



3/4" Round Towel Bar Set







BC6CP-13818	18" x 3/4" Towel Bar Set	US26	25	\$34.50
BC6CP-13824	24" x 3/4" Towel Bar Set	US26	25	\$36.28
BC6CP-13830	30" x 3/4" Towel Bar Set	US26	25	\$37.62
BC6PB-13818	18" x 3/4" Towel Bar Set	US3	25	\$34.50
BC6PB-13824	24" x 3/4" Towel Bar Set	US3	25	\$36.28
BC6PB-13830	30" x 3/4" Towel Bar Set	US3	25	\$37.62
BC6SN-13818	18" x 3/4" Towel Bar Set	US15	25	\$37.93
BC6SN-13824	24" x 3/4" Towel Bar Set	US15	25	\$39.93
BC6SN-13830	30" x 3/4" Towel Bar Set	US15	25	\$41.39
BC6DB-13818	18" x 3/4" Towel Bar Set	US12P	25	\$41.39
BC6DB-13824	24" x 3/4" Towel Bar Set	US12P	25	\$43.55
BC6DB-13830	30" x 3/4" Towel Bar Set	US12P	25	\$45.14
BC6BL-13818	18" x 3/4" Towel Bar Set (in stock)	US19	25	\$41.39
BC6BL-13824	24" x 3/4" Towel Bar Set (in stock)	US19	25	\$43.55
BC6BL-13830	30" x 3/4" Towel Bar Set (in stock)	US19	25	\$45.14



5/8" Round Double Towel Bar Set

BC6CP-15824D	24" X 5/8" Double Towel Bar Shelf	US26	25	\$58.06
BC6SN-15824D	24" X 5/8" Double Towel Bar Shelf	US15	25	\$63.85
BC6DB-15824D	24" X 5/8" Double Towel Bar Shelf	US12P	25	\$69.68
BC6BL-15824D	24" X 5/8" Double Towel Bar Shelf (ETA: 09/22)	US19	25	\$69.68



	Model #	Description	Finish	QTY /Case	List Price
	BC5CP-21	Single Robe Hook	US26	100	\$6.85
	BC5PB-21	Single Robe Hook	US3	100	\$6.85
	BC5SN-21	Single Robe Hook	US15	100	\$9.22
	BC5DB-21	Single Robe Hook	US12P	100	\$10.26
	BC5BL-21	Single Robe Hook	US19	100	\$10.26
	BC5CP-50	Toothbrush /Tumbler Holder	US26	100	\$10.67
	BC5PB-50	Toothbrush /Tumbler Holder	US3	100	\$10.67
	BC5SN-50	Toothbrush /Tumbler Holder	US15	100	\$14.39
	BC5CP-60	Soap Dish	US26	100	\$10.67
	BC5PB-60	Soap Dish	US3	100	\$10.67
	BC5SN-60	Soap Dish	US15	100	\$14.39
	BC5CP-30	Metal Towel Ring	US26	100	\$13.33
	BC5PB-30	Metal Towel Ring	US3	100	\$13.33
	BC5SN-30	Metal Towel Ring	US15	100	\$17.96
	BC5DB-30	Metal Towel Ring	US12P	100	\$19.96
	BC5BL-30	Metal Towel Ring	US19	100	\$19.96
	BC5CP-42	Surface Paper Holder	US26	100	\$16.75
	BC5PB-42	Surface Paper Holder	US3	100	\$16.75
	BC5SN-42	Surface Paper Holder	US15	100	\$22.61
	BC5DB-42	Surface Paper Holder	US12P	100	\$25.13
	BC5BL-42	Surface Paper Holder	US19	100	\$25.13
	BC5CP-43	European-Style Paper Holder	US26	100	\$15.07
	BC5SN-43	European-Style Paper Holder	US15	100	\$20.36
	BC5DB-43	European-Style Paper Holder	US12P	100	\$22.61
	BC5BL-43	European-Style Paper Holder	US19	100	\$22.61





Model #	Description	Finish	QTY /Case	List Price
BC5CP-13800	Posts (Pair) for 3/4" Round Bar	US26	100	\$15.81
BC5PB-13800	Posts (Pair) for 3/4" Round Bar	US3	100	\$15.81
BC5SN-13800	Posts (Pair) for 3/4" Round Bar	US15	100	\$21.35
BC5DB-13800	Posts (Pair) for 3/4" Round Bar	US12P	100	\$23.70
BC5BL-13800	Posts (Pair) for 3/4" Round Bar	US19	100	\$23.70





3/4" Round Towel Bar Set

BC5CP-13818	18" x 3/4" Towel Bar Set	US26	25	\$21.11
BC5CP-13824	24" x 3/4" Towel Bar Set	US26	25	\$23.07
BC5CP-13830	30" x 3/4" Towel Bar Set	US26	25	\$24.57
BC5PB-13818	18" x 3/4" Towel Bar Set	US3	25	\$21.11
BC5PB-13824	24" x 3/4" Towel Bar Set	US3	25	\$23.07
BC5PB-13830	30" x 3/4" Towel Bar Set	US3	25	\$24.57
BC5SN-13818	18" x 3/4" Towel Bar Set	US15	25	\$28.47
BC5SN-13824	24" x 3/4" Towel Bar Set	US15	25	\$31.14
BC5SN-13830	30" x 3/4" Towel Bar Set	US15	25	\$33.16
BC5DB-13818	18" x 3/4" Towel Bar Set	US12P	25	\$31.64
BC5DB-13824	24" x 3/4" Towel Bar Set	US12P	25	\$34.60
BC5DB-13830	30" x 3/4" Towel Bar Set	US12P	25	\$36.85
BC5BL-13818	18" x 3/4" Towel Bar Set	US19	25	\$31.64
BC5BL-13824	24" x 3/4" Towel Bar Set	US19	25	\$34.60
BC5BL-13830	30" x 3/4" Towel Bar Set	US19	25	\$36.85



	Model #	Description	Finish	QTY /Case	List Price
	BC4CP-22	Double Robe Hook	US26	100	\$6.69
	BC4SN-22	Double Robe Hook	US15	100	\$9.05
	BC4DB-22	Double Robe Hook	US12P	100	\$9.60
	BC4BL-22	Double Robe Hook (ETA: 09/22)	US19	100	\$9.60
	BC4CP-30	Metal Towel Ring	US26	100	\$11.71
	BC4SN-30	Metal Towel Ring	US15	100	\$13.85
	BC4DB-30	Metal Towel Ring	US12P	100	\$19.40
	BC4BL-30	Metal Towel Ring (ETA: 09/22)	US19	100	\$19.40
	BC4CP-42	Surface Paper Holder	US26	100	\$13.13
	BC4SN-42	Surface Paper Holder	US15	100	\$15.97
	BC4DB-42	Surface Paper Holder	US12P	100	\$22.17
	BC4BL-42	Surface Paper Holder (ETA: 09/22)	US19	100	\$22.17
	BC4CP-43	European-Style Paper Holder	US26	100	\$12.71
	BC4SN-43	European-Style Paper Holder	US15	100	\$14.37
	BC4DB-43	European-Style Paper Holder	US12P	100	\$19.96
	BC4BL-43	European-Style Paper Holder (ETA: 09/22)	US19	100	\$19.96





Model #	Description	Finish	QTY /Case	List Price
	BC4CP-13800 Posts (Pair) for 3/4" Round Bar	US26	100	\$12.39
	BC4SN-13800 Posts (Pair) for 3/4" Round Bar	US15	100	\$15.05
	BC4DB-13800 Posts (Pair) for 3/4" Round Bar	US12P	100	\$18.83
	BC4BL-13800 Posts (Pair) for 3/4" Round Bar (ETA: 09/22)	US19	100	\$18.83
3/4" Round Towel Bar Set				
	BC4CP-13818 18" x 3/4" Towel Bar Set	US26	25	\$16.53
	BC4CP-13824 24" x 3/4" Towel Bar Set	US26	25	\$18.09
	BC4CP-13830 30" x 3/4" Towel Bar Set	US26	25	\$19.25
	BC4SN-13818 18" x 3/4" Towel Bar Set	US15	25	\$20.09
	BC4SN-13824 24" x 3/4" Towel Bar Set	US15	25	\$21.97
	BC4SN-13830 30" x 3/4" Towel Bar Set	US15	25	\$23.39
	BC4DB-13818 18" x 3/4" Towel Bar Set	US12P	25	\$25.11
	BC4DB-13824 24" x 3/4" Towel Bar Set	US12P	25	\$27.47
	BC4DB-13830 30" x 3/4" Towel Bar Set	US12P	25	\$29.24
	BC4BL-13818 18" x 3/4" Towel Bar Set (ETA: 09/22)	US19	25	\$25.11
	BC4BL-13824 24" x 3/4" Towel Bar Set (ETA: 09/22)	US19	25	\$27.47
	BC4BL-13830 30" x 3/4" Towel Bar Set (ETA: 09/22)	US19	25	\$29.24





	Model #	Description	Finish	QTY /Case	List Price
	BC2CP-22	Double Robe Hook	US26	100	\$3.91
	BC2PB-22	Double Robe Hook	US3	100	\$4.84
	BC2CP-50	Toothbrush / Tumbler Holder	US26	100	\$5.38
	BC2PB-50	Toothbrush / Tumbler Holder	US3	100	\$6.91
	BC2CP-60	Soap Dish	US26	100	\$5.38
	BC2PB-60	Soap Dish	US3	100	\$6.91
	BC2CP-30	Metal Towel Ring	US26	100	\$8.65
	BC2PB-30	Metal Towel Ring	US3	100	\$9.81
	BC2CP-31	Lucite Towel Ring	US26	100	\$7.79



	Model #	Description	Finish	QTY /Case	List Price	
	BC2CP-41	Surface Paper Holder(White Roller)	US26	100	\$8.77	
	BC2PB-41	Surface Paper Holder(White Roller)	US3	100	\$10.19	
	BC2CP-42	Surface Paper Holder(Chrome Roller)	US26	100	\$10.26	
	BC2PB-42	Surface Paper Holder(PB Roller)	US3	100	\$11.37	
	BC2CP-13800	Posts(Pair) for 3/4" Square Bar	US26	100	\$7.48	
	BC2PB-13800	Posts(Pair) for 3/4" Square Bar	US3	100	\$8.88	
3/4" Aluminum Square Towel Bar Set						
	BC2CP-13818	18" X 3/4" Towel Bar Set	US26	100	\$10.27	
	BC2CP-13824	24" X 3/4" Towel Bar Set	US26	100	\$11.15	
	BC2CP-13830	30" X 3/4" Towel Bar Set	US26	100	\$12.02	
	BC2CP-13836	36" X 3/4" Towel Bar Set	US26	100	\$13.45	
	BC2PB-13818	18" X 3/4" Towel Bar Set	US3	100	\$14.01	
	BC2PB-13824	24" X 3/4" Towel Bar Set	US3	100	\$15.79	
	BC2PB-13830	30" X 3/4" Towel Bar Set	US3	100	\$17.31	
	3/4" Stainless Steel Square Towel Bar Set					
	BC2SS-13818	18" X 3/4" Towel Bar Set	US32D	100	\$13.10	
BC2SS-13824	24" X 3/4" Towel Bar Set	US32D	100	\$14.85		
BC2SS-13830	30" X 3/4" Towel Bar Set	US32D	100	\$16.55		

	Model #	Description	Finish	QTY /Case	List Price
	BC3CP-22	Double Robe Hook	US26	100	\$3.91
	BC3PB-22	Double Robe Hook	US3	100	\$4.84
	BC3SN-22	Double Robe Hook	US15	100	\$6.86
	BC3DB-22	Double Robe Hook	US12P	100	\$9.60
	BC3BL-22	Double Robe Hook	US19	100	\$9.60
	BC3CP-50	Toothbrush / Tumbler Holder	US26	100	\$5.38
	BC3PB-50	Toothbrush / Tumbler Holder	US3	100	\$6.91
	BC3CP-60	Soap Dish	US26	100	\$5.38
	BC3PB-60	Soap Dish	US3	100	\$6.91
	BC3CP-30	Metal Towel Ring	US26	100	\$7.93
	BC3PB-30	Metal Towel Ring	US3	100	\$9.27
	BC3SN-30	Metal Towel Ring	US15	100	\$13.85
	BC3DB-30	Metal Towel Ring	US12P	100	\$19.40
	BC3BL-30	Metal Towel Ring	US19	100	\$19.40

	Model #	Description	Finish	QTY /Case	List Price
	BC3CP-41	Surface Paper Holder(White Roller)	US26	100	\$7.42
	BC3PB-41	Surface Paper Holder(White Roller)	US3	100	\$8.88
	BC3SN-41	Surface Paper Holder(White Roller)	US15	100	\$12.99
	BC3DB-41	Surface Paper Holder(White Roller)	US12P	100	\$18.18
	BC3BL-41	Surface Paper Holder(White Roller)	US19	100	\$18.18
	BC3CP-42	Surface Paper Holder(CP Roller)	US26	100	\$8.88
	BC3PB-42	Surface Paper Holder(PB Roller)	US3	100	\$9.91
	BC3SN-42	Surface Paper Holder(SN Roller)	US15	100	\$15.51
	BC3DB-42	Surface Paper Holder(DB Roller)	US12P	100	\$21.72
	BC3BL-42	Surface Paper Holder(BL Roller)	US19	100	\$21.72
	BC3CP-13800	Posts(Pair) for 3/4" Square Bar	US26	100	\$6.60
	BC3PB-13800	Posts(Pair) for 3/4" Square Bar	US3	100	\$8.03
	BC3SN-13800	Posts(Pair) for 3/4" Square Bar	US15	100	\$11.54
	BC3DB-13800	Posts(Pair) for 3/4" Square Bar	US12P	100	\$16.17
	BC3BL-13800	Posts(Pair) for 3/4" Square Bar	US19	100	\$16.17
3/4" Aluminum Square Towel Bar Set					
	BC3CP-13818	18" X 3/4" Towel Bar Set	US26	100	\$9.40
	BC3CP-13824	24" X 3/4" Towel Bar Set	US26	100	\$10.27
	BC3CP-13830	30" X 3/4" Towel Bar Set	US26	100	\$11.14
	BC3CP-13836	36" X 3/4" Towel Bar Set	US26	100	\$12.58
	BC3PB-13818	18" X 3/4" Towel Bar Set	US3	100	\$13.15
	BC3PB-13824	24" X 3/4" Towel Bar Set	US3	100	\$14.95
	BC3PB-13830	30" X 3/4" Towel Bar Set	US3	100	\$16.47
	BC3SN-13818	18" X 3/4" Towel Bar Set	US15	25	\$17.17
	BC3SN-13824	24" X 3/4" Towel Bar Set	US15	25	\$18.91
	BC3SN-13830	30" X 3/4" Towel Bar Set	US15	25	\$20.62
	BC3DB-13818	18" X 3/4" Towel Bar Set	US12P	25	\$24.03
	BC3DB-13824	24" X 3/4" Towel Bar Set	US12P	25	\$26.49
BC3DB-13830	30" X 3/4" Towel Bar Set	US12P	25	\$28.87	

	Model #	Description	Finish	QTY /Case	List Price
	3/4" Aluminum Square Towel Bar Set				
	BC3BL-13818	18" X 3/4" Towel Bar Set	US19	25	\$24.03
	BC3BL-13824	24" X 3/4" Towel Bar Set	US19	25	\$26.49
	BC3BL-13830	30" X 3/4" Towel Bar Set	US19	25	\$28.87
	3/4" Stainless Steel Square Towel Bar Set (Posts are Zinc Die-cast in Chrome Finish)				
	BC3SS-13818	18" X 3/4" Towel Bar Set	US32D	100	\$12.22
	BC3SS-13824	24" X 3/4" Towel Bar Set	US32D	100	\$13.98
	BC3SS-13830	30" X 3/4" Towel Bar Set	US32D	100	\$15.67
	BC3CP-15800	Posts(Pair) for 5/8" Round Bar	US26	100	\$6.60
	BC3SN-15800	Posts(Pair) for 5/8" Round Bar	US15	100	\$11.54
	BC3DB-15800	Posts(Pair) for 5/8" Round Bar	US12P	100	\$16.17
	BC3BL-15800	Posts(Pair) for 5/8" Round Bar	US19	100	\$16.17
	5/8" Aluminum Round Towel Bar Set				
	BC3CP-15818	18" X 5/8" Towel Bar Set	US26	100	\$13.05
	BC3CP-15824	24" X 5/8" Towel Bar Set	US26	100	\$14.95
	BC3CP-15830	30" X 5/8" Towel Bar Set	US26	100	\$16.88
	BC3SN-15818	18" X 5/8" Towel Bar Set	US15	25	\$18.62
	BC3SN-15824	24" X 5/8" Towel Bar Set	US15	25	\$20.83
	BC3SN-15830	30" X 5/8" Towel Bar Set	US15	25	\$22.97
	BC3DB-15818	18" X 5/8" Towel Bar Set	US12P	25	\$24.03
	BC3DB-15824	24" X 5/8" Towel Bar Set	US12P	25	\$26.49
	BC3DB-15830	30" X 5/8" Towel Bar Set	US12P	25	\$28.87
	BC3BL-15818	18" X 5/8" Towel Bar Set	US19	25	\$24.03
	BC3BL-15824	24" X 5/8" Towel Bar Set	US19	25	\$26.49
	BC3BL-15830	30" X 5/8" Towel Bar Set	US19	25	\$28.87

	Model #	Description	Finish	QTY /Case	List Price
Zinc Die-cast, Exposed Screws					
	BE2CP-22	Double Robe Hook	US26	100	\$3.75
	BE2CP-50	Toothbrush / Tumbler Holder	US26	100	\$4.22
	BE2CP-60	Soap Dish	US26	100	\$4.22
	BE2CP-30	Metal Towel Ring	US26	100	\$7.80
	BE2CP-41	Surface Paper Holder(White Roller)	US26	100	\$5.79

Model #	Description	Finish	QTY /Case	List Price	
Zinc Die-cast, Exposed Screws					
	BE2CP-15800	Posts(Pair) for 5/8" Square Bar	US26	100	\$5.10
	BE2CP-13800	Posts(Pair) for 3/4" Square Bar	US26	100	\$6.21

Model #	Description	Finish	QTY /Case	List Price	
5/8" Aluminum Square Towel Bar Set					
	BE2CP-15818	18" X 5/8" Towel Bar Set	US26	100	\$7.69
	BE2CP-15824	24" X 5/8" Towel Bar Set	US26	100	\$8.57
	BE2CP-15830	30" X 5/8" Towel Bar Set	US26	100	\$9.43
3/4" Aluminum Square Towel Bar Set					
	BE2CP-13818	18" X 3/4" Towel Bar Set	US26	100	\$9.01
	BE2CP-13824	24" X 3/4" Towel Bar Set	US26	100	\$9.91
	BE2CP-13830	30" X 3/4" Towel Bar Set	US26	100	\$10.75

PAPER HOLDER ROLLERS

Model #	Description	Finish	QTY /Case	List Price	
For Carmel, Seal Beach, Estes, Campbell, Corona, and Edison Series					
	BRWH-001	Plastic Roller	White	200	\$2.04
	BRCP-001	Plastic Roller	US26	200	\$2.22
	BRPB-001	Plastic Roller	US3	200	\$2.46
	BRSN-001	Plastic Roller	US15	200	\$2.46
	BRBL-001	Plastic Roller (in stock)	US19	200	\$2.46
For Eureka, La Quinta, Vina, Solano, Charleston, and Ventura Series					
	BRCP-002	Metal Roller	US26	200	\$5.25
	BRPB-002	Metal Roller	US3	200	\$5.71
	BRSN-002	Metal Roller	US15	200	\$6.60
	BRAN-002	Metal Roller	US15A	200	\$6.60
	BRVB-002	Metal Roller	US11P	200	\$7.92
	BRDB-002	Metal Roller	US12P	200	\$7.92
	BRBL-002	Metal Roller	US19	200	\$7.92

Model #	Description	Finish	QTY /Case	List Price
<i>3/4" Round Towel Bar for Charleston, Ventura, Carmel, Seal Beach, Estes Collection</i>				
BRCP-13018R	18" X 3/4" Round Towel Bar Only	US26	50	\$5.30
BRCP-13024R	24" X 3/4" Round Towel Bar Only	US26	50	\$7.25
BRCP-13030R	30" X 3/4" Round Towel Bar Only	US26	50	\$8.74
BRWH-13018R	18" X 3/4" Round Towel Bar Only	White	50	\$5.30
BRWH-13024R	24" X 3/4" Round Towel Bar Only	White	50	\$7.25
BRWH-13030R	30" X 3/4" Round Towel Bar Only	White	50	\$8.74
BRPB-13018R	18" X 3/4" Round Towel Bar Only	US3	50	\$5.30
BRPB-13024R	24" X 3/4" Round Towel Bar Only	US3	50	\$7.25
BRPB-13030R	30" X 3/4" Round Towel Bar Only	US3	50	\$8.74
BRSN-13018R	18" X 3/4" Round Towel Bar Only	US15	50	\$9.24
BRSN-13024R	24" X 3/4" Round Towel Bar Only	US15	50	\$12.42
BRSN-13030R	30" X 3/4" Round Towel Bar Only	US15	50	\$15.36
BRAN-13018R	18" X 3/4" Round Towel Bar Only	US15A	50	\$9.24
BRAN-13024R	24" X 3/4" Round Towel Bar Only	US15A	50	\$12.42
BRAN-13030R	30" X 3/4" Round Towel Bar Only	US15A	50	\$15.36
BRDB-13018R	18" X 3/4" Round Towel Bar Only	US12P	50	\$10.90
BRDB-13024R	24" X 3/4" Round Towel Bar Only	US12P	50	\$14.68
BRDB-13030R	30" X 3/4" Round Towel Bar Only	US12P	50	\$18.13
BRVB-13018R	18" X 3/4" Round Towel Bar Only	US11P	50	\$10.90
BRVB-13024R	24" X 3/4" Round Towel Bar Only	US11P	50	\$14.68
BRVB-13030R	30" X 3/4" Round Towel Bar Only	US11P	50	\$18.13
BRBL-13018R	18" X 3/4" Round Towel Bar Only	US19	50	\$10.90
BRBL-13024R	24" X 3/4" Round Towel Bar Only	US19	50	\$14.68
BRBL-13030R	30" X 3/4" Round Towel Bar Only	US19	50	\$18.13



Model #	Description	Finish	QTY /Case	List Price
5/8" Round Towel Bar for Solano, Vina, and Corona Collection				
BRCP-15018R	18" X 5/8" Round Towel Bar Only	US26	50	\$6.45
BRCP-15024R	24" X 5/8" Round Towel Bar Only	US26	50	\$8.35
BRCP-15030R	30" X 5/8" Round Towel Bar Only	US26	50	\$10.27
<hr/>				
BRSN-15018R	18" X 5/8" Round Towel Bar Only	US15	50	\$7.08
BRSN-15024R	24" X 5/8" Round Towel Bar Only	US15	50	\$9.27
BRSN-15030R	30" X 5/8" Round Towel Bar Only	US15	50	\$11.43
<hr/>				
BRDB-15018R	18" X 5/8" Round Towel Bar Only	US12P	50	\$7.87
BRDB-15024R	24" X 5/8" Round Towel Bar Only	US12P	50	\$10.32
BRDB-15030R	30" X 5/8" Round Towel Bar Only	US12P	50	\$12.69
<hr/>				
BRBL-15018R	18" X 5/8" Round Towel Bar Only	US19	50	\$7.87
BRBL-15024R	24" X 5/8" Round Towel Bar Only	US19	50	\$10.32
BRBL-15030R	30" X 5/8" Round Towel Bar Only	US19	50	\$12.69
<hr/>				
3/4" Square Aluminum Towel Bar for Campbell, Corona, and Edison Collection				
BRCP-13018	18" X 3/4" Square Towel Bar Only	US26	50	\$2.86
BRCP-13024	24" X 3/4" Square Towel Bar Only	US26	50	\$3.77
BRCP-13030	30" X 3/4" Square Towel Bar Only	US26	50	\$4.67
BRCP-13036	36" X 3/4" Square Towel Bar Only	US26	50	\$6.12
<hr/>				
BRPB-13018	18" X 3/4" Square Towel Bar Only	US3	50	\$5.26
BRPB-13024	24" X 3/4" Square Towel Bar Only	US3	50	\$7.10
BRPB-13030	30" X 3/4" Square Towel Bar Only	US3	50	\$8.64
<hr/>				
BRSN-13018	18" X 3/4" Square Towel Bar Only	US15	50	\$5.63
BRSN-13024	24" X 3/4" Square Towel Bar Only	US15	50	\$7.37
BRSN-13030	30" X 3/4" Square Towel Bar Only	US15	50	\$9.07
<hr/>				
BRDB-13018	18" X 3/4" Square Towel Bar Only	US12P	50	\$7.87
BRDB-13024	24" X 3/4" Square Towel Bar Only	US12P	50	\$10.32
BRDB-13030	30" X 3/4" Square Towel Bar Only	US12P	50	\$12.69
<hr/>				
BRBL-13018	18" X 3/4" Square Towel Bar Only	US19	50	\$7.87
BRBL-13024	24" X 3/4" Square Towel Bar Only	US19	50	\$10.32
BRBL-13030	30" X 3/4" Square Towel Bar Only	US19	50	\$12.69
<hr/>				
3/4" Square Stainless Steel Towel Bar for Campbell, Corona, and Edison Collection				
BRSS-13018	18" X 3/4" Square Stainless Steel Bar Only	US32D	50	\$5.77
BRSS-13024	24" X 3/4" Square Stainless Steel Bar Only	US32D	50	\$7.55
BRSS-13030	30" X 3/4" Square Stainless Steel Bar Only	US32D	50	\$9.31
<hr/>				
5/8" Square Aluminum Towel Bar for Edison Collection				
BRCP-15018	18" X 5/8" Square Towel Bar Only	US26	50	\$2.65
BRCP-15024	24" X 5/8" Square Towel Bar Only	US26	50	\$3.55
BRCP-15030	30" X 5/8" Square Towel Bar Only	US26	50	\$4.44

Specifications:

- ❖ Type 304 Satin Stainless Steel Bar with .050" Wall Thickness (18 Gauge).
- ❖ Mounting Flanges with .073" Wall Thickness (14 Gauge).
- ❖ 1-1/2" Diameter Tube Bar
- ❖ Flanges are 3" Diameter with 3 Hole Mounts.
- ❖ 2" Stainless Steel Mounting Screws.
- ❖ 1-1/2" Wall Clearance on All Bars to Meet ADA Code Requirements.
- ❖ Tested to Withstand 250 lbs. Pull/Push When Properly Installed.
- ❖ Concealed Flange Covers are "Snap and Twist" Type.
- ❖ Bulk Pack with Poly Bag and Head Card.



ADA

	Model #	Description	Finish	QTY /Case	List Price
	BGBSS-1212E	12" x 1-1/2" Exposed Screws	US32D	12	\$44.43
	BGBSS-1218E	18" x 1-1/2" Exposed Screws	US32D	12	\$48.35
	BGBSS-1224E	24" x 1-1/2" Exposed Screws	US32D	12	\$52.91
	BGBSS-1230E	30" x 1-1/2" Exposed Screws	US32D	12	\$58.43
	BGBSS-1232E	32" x 1-1/2" Exposed Screws	US32D	12	\$61.08
	BGBSS-1236E	36" x 1-1/2" Exposed Screws	US32D	12	\$66.12
	BGBSS-1242E	42" x 1-1/2" Exposed Screws	US32D	12	\$70.78
	BGBSS-1248E	48" x 1-1/2" Exposed Screws	US32D	12	\$76.15

	BGBSS-1212C	12" x 1-1/2" Concealed Screws	US32D	12	\$52.80
	BGBSS-1218C	18" x 1-1/2" Concealed Screws	US32D	12	\$57.47
	BGBSS-1224C	24" x 1-1/2" Concealed Screws	US32D	12	\$62.87
	BGBSS-1230C	30" x 1-1/2" Concealed Screws	US32D	12	\$69.51
	BGBSS-1232C	32" x 1-1/2" Concealed Screws	US32D	12	\$72.59
	BGBSS-1236C	36" x 1-1/2" Concealed Screws	US32D	12	\$76.47
	BGBSS-1242C	42" x 1-1/2" Concealed Screws	US32D	12	\$82.03
	BGBSS-1248C	48" x 1-1/2" Concealed Screws	US32D	12	\$88.44
	BGBBL-1212C	12" x 1-1/2" Concealed Screws	US19	12	\$63.36
BGBBL-1218C	18" x 1-1/2" Concealed Screws	US19	12	\$68.97	
BGBBL-1224C	24" x 1-1/2" Concealed Screws	US19	12	\$75.44	
BGBBL-1236C	36" x 1-1/2" Concealed Screws	US19	12	\$91.78	
BGBBL-1242C	42" x 1-1/2" Concealed Screws	US19	12	\$98.43	
BGBBL-1248C	48" x 1-1/2" Concealed Screws	US19	12	\$106.13	

Specifications:

- ❖ Type 304 Satin Stainless Steel Bar with .050" Wall Thickness (18 Gauge).
- ❖ Mounting Flanges with .073" Wall Thickness (14 Gauge).
- ❖ 1-1/2" Diameter Tube Bar
- ❖ Flanges are 3" Diameter with 3 Hole Mounts.
- ❖ 2" Stainless Steel Mounting Screws.
- ❖ 1-1/2" Wall Clearance on All Bars to Meet ADA Code Requirements.
- ❖ Tested to Withstand 250 lbs. Pull/Push When Properly Installed.
- ❖ Concealed Flange Covers are "Snap and Twist" Type.
- ❖ Bulk Pack with Poly Bag and Head Card.
- ❖ Textured Satin.



	Model #	Description	Finish	QTY /Case	List Price
	BGBSS-1212P	12" x 1-1/2" Peened Concealed Screws	US32D	12	\$63.37
	BGBSS-1218P	18" x 1-1/2" Peened Concealed Screws	US32D	12	\$66.09
	BGBSS-1224P	24" x 1-1/2" Peened Concealed Screws	US32D	12	\$72.31
	BGBSS-1236P	36" x 1-1/2" Peened Concealed Screws	US32D	12	\$87.98
	BGBSS-1242P	42" x 1-1/2" Peened Concealed Screws	US32D	12	\$94.34

STAINLESS STEEL SWING UP GRAB BARS



Specifications:

- ❖ Type 304 Satin Stainless Steel Bar with 0.05" Wall Thickness(18 Gauge)
- ❖ 1-1/4" Diameter Tube Bar
- ❖ Down dimensions: 30" W (front to back) x 10-3/16" H.
- ❖ Base plate measures 3-1/16" W x 10-3/16" H.
- ❖ Back plate 3/16" thickness
- ❖ Operates with Less Than 5 Pounds of Force
- ❖ 300 lb. weight limit
- ❖ Textured Satin
- ❖ Not to be mounted on drywall, sheetrock, plaster, fiberglass, acrylic, or any other similar hollow wall surfaces without appropriate wood or steel backing material.



	Model #	Description	Finish	QTY /Case	List Price
	BGBSS-1430SWP	30" x 1-1/4" Peened Swing Up Grab Bar	US32D	12	\$303.31
	BGBWH-1430SWP	30" x 1-1/4" Swing Up Grab Bar	White	12	\$303.31

	Model #	Description	Finish	QTY /Case	List Price
	BSFCP-01	ABS Plastic Adjustable Flange Set	US26	200	\$2.52
	BSFCP-02	Zinc Adjustable Flange Set	US26	200	\$7.89
	BSFSN-02	Zinc Adjustable Flange Set	US15	200	\$9.47
	BSFDB-02	Zinc Adjustable Flange Set	US12P	200	\$11.31
	BSFBL-02	Zinc Adjustable Flange Set	US19	200	\$11.31
	BSFCP-03	Zinc Die-cast Exposed Screw Flange Set--Chrome	US26	200	\$7.06
	BSFSN-03	Zinc Die-cast Exposed Screw Flange Set--Chrome	US15	200	\$8.46
	BSFDB-03	Zinc Die-cast Exposed Screw Flange Set--Chrome	US12P	200	\$11.31
	BSFBL-03	Zinc Die-cast Exposed Screw Flange Set--Chrome	US19	200	\$11.31
	BSFSS-04	Stainless Steel Concealed Flange Set	US32D	200	\$7.06
	BSFBL-04	Stainless Steel Concealed Flange Set	US19	200	\$11.31
	0.025" (22 Gauge)				
	BSRCP-501	5 FT. X 1" Aluminum Shower Rod	US26	25	\$12.22
	BSRSN-501	5 FT. X 1" Aluminum Shower Rod	US15	25	\$19.54
	BSRDB-501	5 FT. X 1" Aluminum Shower Rod	US12P	25	\$19.54
	BSRBL-501	5 FT. X 1" Aluminum Shower Rod	US19	25	\$19.54
	BSRSS-501	5 FT. X 1" Stainless Steel Shower Rod	US32D	25	\$42.74
	0.025" (22 Gauge)				
	BSRCP-601	6 FT. X 1" Aluminum Shower Rod	US26	25	\$14.47
	BSRSN-601	6 FT. X 1" Aluminum Shower Rod	US15	25	\$23.13
	BSRDB-601	6 FT. X 1" Aluminum Shower Rod	US12P	25	\$23.13
BSRBL-601	6 FT. X 1" Aluminum Shower Rod	US19	25	\$23.13	
BSRSS-601	6 FT. X 1" Stainless Steel Shower Rod	US32D	25	\$50.59	
	BSRCP-511	5 FT. X 1" Rod and ABS Adj. Flange Set	US26	50	\$14.76
	BSRCP-611	6 FT. X 1" Rod and ABS Adj. Flange Set	US26	50	\$16.98

	Model #	Description	Finish	QTY /Case	List Price
	BSRCP-521	5 FT. X 1" Rod and Zinc Adj. Flange Set	US26	50	\$20.11
	BSRSN-521	5 FT. X 1" Rod and Zinc Adj. Flange Set	US15	50	\$29.01
	BSRDB-521	5 FT. X 1" Rod and Zinc Adj. Flange Set	US12P	50	\$30.86
	BSRBL-521	5 FT. X 1" Rod and Zinc Adj. Flange Set	US19	50	\$30.86
	BSRCP-621	6 FT. X 1" Rod and Zinc Adj. Flange Set	US26	50	\$22.35
	BSRSN-621	6 FT. X 1" Rod and Zinc Adj. Flange Set	US15	50	\$32.60
	BSRDB-621	6 FT. X 1" Rod and Zinc Adj. Flange Set	US12P	50	\$34.43
	BSRBL-621	6 FT. X 1" Rod and Zinc Adj. Flange Set	US19	50	\$34.43
	BSRCP-531	5 FT. X 1" Rod and Zinc Exposed Flange Set	US26	50	\$19.29
	BSRSN-531	5 FT. X 1" Rod and Zinc Exposed Flange Set	US15	50	\$28.00
	BSRDB-531	5 FT. X 1" Rod and Zinc Exposed Flange Set	US12P	50	\$30.86
	BSRBL-531	5 FT. X 1" Rod and Zinc Exposed Flange Set	US19	50	\$30.86
	BSRCP-631	6 FT. X 1" Rod and Zinc Exposed Flange Set	US26	50	\$21.52
	BSRSN-631	6 FT. X 1" Rod and Zinc Exposed Flange Set	US15	50	\$31.59
	BSRDB-631	6 FT. X 1" Rod and Zinc Exposed Flange Set	US12P	50	\$34.43
	BSRBL-631	6 FT. X 1" Rod and Zinc Exposed Flange Set	US19	50	\$34.43
	(Aluminum Rod)				
	BSRCP-541	5 FT. X 1" Rod and SS Concealed Flange Set	US26	25	\$19.29
	BSRBL-541	5 FT. X 1" Rod and SS Concealed Flange Set	US19	25	\$30.86
	BSRCP-641	6 FT. X 1" Rod and SS Concealed Flange Set	US26	25	\$21.52
	BSRBL-641	6 FT. X 1" Rod and SS Concealed Flange Set	US19	25	\$34.43
	(Stainless Steel Rod)				
BSRSS-541	5 FT. X 1" SS Rod & SS Concealed Flange Set	US32D	25	\$49.82	
BSRSS-641	6 FT. X 1" SS Rod & SS Concealed Flange Set	US32D	25	\$57.66	

Features:

- ❖ 25% More Showering Space
- ❖ Eliminates Elbow-Cling
- ❖ Fits Standard or Oval Bath Tub
- ❖ Fits Standard Shower Curtain
- ❖ Prevents Water Leakage at The Corners
- ❖ Easily Cut down to Custom Size
- ❖ 1" Diameter Stainless Steel Rod
- ❖ Durable Zinc Die-Cast Swivel Brackets
- ❖ 2 Chrome Plated Flanges Included(2-1/2" W X 2" H)
- ❖ Complete Mounting Hardware Included (Stainless Steel Wood Screws, #10 Allen Wrench, Tile Anchors, Sheet Rock, Anchors and Instruction)



Model #	Description	Finish	QTY /Case	List Price
---------	-------------	--------	-----------	------------

(No broken case shipments)

BSFCP-05	Flange Set for Curved Rod	US26	12	\$84.95
BSFSN-05	Flange Set for Curved Rod	US15	12	\$94.44
BSFBL-05	Flange Set for Curved Rod (ETA: 09/22)	US19	12	\$103.87



BSRCP-502	5 FT. x1" Curved Rod Only	US26	12	\$47.01
BSRSN-502	5 FT. x1" Curved Rod Only	US15	12	\$51.72
BSRBL-502	5 FT. x1" Curved Rod Only (ETA: 09/22)	US19	12	\$56.87

BSRCP-602	6 FT. x1" Curved Rod Only	US26	12	\$88.48
BSRSN-602	6 FT. x1" Curved Rod Only	US15	12	\$98.28
BSRBL-602	6 FT. x1" Curved Rod Only (ETA: 09/22)	US19	12	\$108.10







BSRCP-552	5 FT Curved Shower Rod w/ Flange	US26	12	\$123.86
BSRSN-552	5 FT Curved Shower Rod w/ Flange	US15	12	\$137.67
BSRBL-552	5 FT Curved Shower Rod w/ Flange (ETA: 09/22)	US19	12	\$151.45

BSRCP-652	6 FT Curved Shower Rod w/ Flange	US26	12	\$173.43
BSRSN-652	6 FT Curved Shower Rod w/ Flange	US15	12	\$192.71
BSRBL-652	6 FT Curved Shower Rod w/ Flange (ETA: 09/22)	US19	12	\$211.97

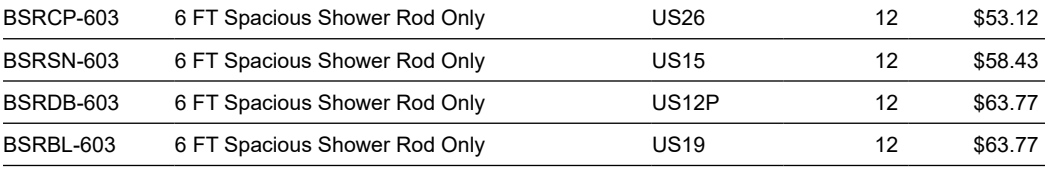

Features:







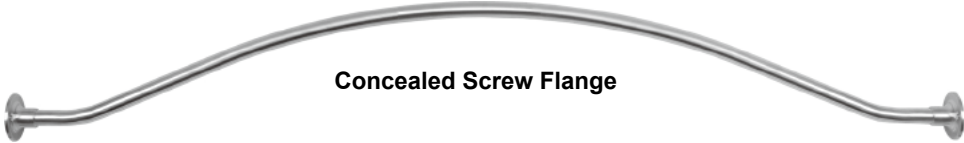

- ❖ 25% More Showering Space
- ❖ Eliminates Elbow-Cling
- ❖ Fits Standard or Oval Bath Tub
- ❖ Fits Standard Shower Curtain
- ❖ Prevents Water Leakage at The Corners
- ❖ 1" Diameter Stainless Steel Rod
- ❖ Durable Stainless Steel Flanges
- ❖ Complete Mounting Hardware Included
(SS Wood Screws, #10 Allen Wrench, Tile Anchors and Anchors)

	Model #	Description	Finish	QTY /Case	List Price
Exposed Screw Flange 	(No broken case shipments)				
	BSFCP-07	SS Flange Set for Spacious Rod	US26	12	\$31.14
	BSFSN-07	SS Flange Set for Spacious Rod	US15	12	\$34.24
	BSFDB-07	SS Flange Set for Spacious Rod	US12P	12	\$37.36
	BSFBL-07	SS Flange Set for Spacious Rod	US19	12	\$37.36
					
	BSRCP-503	5 FT Spacious Shower Rod Only	US26	12	\$47.01
	BSRSN-503	5 FT Spacious Shower Rod Only	US15	12	\$51.72
	BSRDB-503	5 FT Spacious Shower Rod Only	US12P	12	\$56.42
	BSRBL-503	5 FT Spacious Shower Rod Only	US19	12	\$56.42
					
	BSRCP-603	6 FT Spacious Shower Rod Only	US26	12	\$53.12
	BSRSN-603	6 FT Spacious Shower Rod Only	US15	12	\$58.43
	BSRDB-603	6 FT Spacious Shower Rod Only	US12P	12	\$63.77
	BSRBL-603	6 FT Spacious Shower Rod Only	US19	12	\$63.77
					
	BSRCP-573	5 FT Spacious Shower Rod w/ Flange	US26	12	\$62.25
	BSRSN-573	5 FT Spacious Shower Rod w/ Flange	US15	12	\$68.50
	BSRDB-573	5 FT Spacious Shower Rod w/ Flange	US12P	12	\$74.72
	BSRBL-573	5 FT Spacious Shower Rod w/ Flange	US19	12	\$74.72
	BSRCP-673	6 FT Spacious Shower Rod w/ Flange	US26	12	\$74.72
	BSRSN-673	6 FT Spacious Shower Rod w/ Flange	US15	12	\$82.16
	BSRDB-673	6 FT Spacious Shower Rod w/ Flange	US12P	12	\$89.64
	BSRBL-673	6 FT Spacious Shower Rod w/ Flange	US19	12	\$89.64

Features:

- ❖ 25% More Showering Space
- ❖ Eliminates Elbow-Cling
- ❖ Fits Standard or Oval Bath Tub
- ❖ Fits Standard Shower Curtain
- ❖ Prevents Water Leakage at The Corners
- ❖ 1" Diameter Stainless Steel Rod
- ❖ Durable Stainless Steel Flanges
- ❖ Complete Mounting Hardware Included
(SS Wood Screws, #10 Allen Wrench, Tile Anchors and Anchors)

	Model #	Description	Finish	QTY /Case	List Price
	Concealed Screw Flange (No broken case shipments)				
	BSFCP-09	SS Flange Set for Spacious Rod	US26	12	\$56.01
	BSFSN-09	SS Flange Set for Spacious Rod	US15	12	\$61.60
	BSFDB-09	SS Flange Set for Spacious Rod	US12P	12	\$67.23
	BSFBL-09	SS Flange Set for Spacious Rod	US19	12	\$67.23
					
	BSRCP-503	5 FT Spacious Shower Rod Only	US26	12	\$47.01
	BSRSN-503	5 FT Spacious Shower Rod Only	US15	12	\$51.72
	BSRDB-503	5 FT Spacious Shower Rod Only	US12P	12	\$56.42
	BSRBL-503	5 FT Spacious Shower Rod Only	US19	12	\$56.42
					
	BSRCP-603	6 FT Spacious Shower Rod Only	US26	12	\$53.12
	BSRSN-603	6 FT Spacious Shower Rod Only	US15	12	\$58.43
	BSRDB-603	6 FT Spacious Shower Rod Only	US12P	12	\$63.77
	BSRBL-603	6 FT Spacious Shower Rod Only	US19	12	\$63.77
	BSRCP-593	5 FT Spacious Shower Rod w/ Flange	US26	12	\$99.61
	BSRSN-593	5 FT Spacious Shower Rod w/ Flange	US15	12	\$109.57
	BSRDB-593	5 FT Spacious Shower Rod w/ Flange	US12P	12	\$119.54
	BSRBL-593	5 FT Spacious Shower Rod w/ Flange	US19	12	\$119.54
	BSRCP-693	6 FT Spacious Shower Rod w/ Flange	US26	12	\$105.83
	BSRSN-693	6 FT Spacious Shower Rod w/ Flange	US15	12	\$116.44
	BSRDB-693	6 FT Spacious Shower Rod w/ Flange	US12P	12	\$127.06
	BSRBL-693	6 FT Spacious Shower Rod w/ Flange	US19	12	\$127.06

	Model #	Description	Finish	QTY /Case	List Price
	BTSCP-1318	18" Towel Shelf with Bar Overall Size: 20-1/2" W x 8-1/2" x 9-1/2" D	US26	6	\$140.41
	BTSCP-1324	24" Towel Shelf with Bar Overall Size: 26-1/2" W x 8-1/2" x 9-1/2" D	US26	6	\$157.40
	BC3CP-44	Recessed Extra Paper Holder Overall size: 6-3/8" W x 6-3/8" H x 4" D Wall opening: 5-1/4" W x 5-1/4" H x 4-1/4" D	US26	12	\$57.00
	BC3CP-44D	Twin Recessed Paper Holder Overall size: 12-1/4" W x 6-1/8" H x 1-3/4" D Wall opening: 11" W x 5" H x 1-3/4" D	US26	12	\$58.81
	BC3CP-41D	Surface Mount Twin Paper Holder 13" W x 2-1/4" H x 3" D	US26	12	\$44.58
	BTDCP-47	Recessed Tissue Dispenser Overall size: 11-13/16" W x 6" H x 2-5/8" D Wall opening: 10-11/16" W x 4-7/8" H x 2-3/8" D	US26	12	\$37.47
	BTDCP-07	Recessed Tissue Dispenser Cover 11-13/16" W x 6" H	US26	50	\$23.39
	BTDCP-400	Recessed Vanity Tissue Box Overall size: 11-3/8" W x 6-1/4" H x 2-3/8" D		12	\$17.24
	BCLCP-72	Retractable Clothes Line	US26	50	\$39.44
	BC2CP-400	Recessed Wall Clamp		100	\$4.12

	Model #	Description	Finish	QTY /Case	List Price
	BC2CP-43	Shallow Recessed Paper Holder	US26	20	\$40.67
	*Shallow: 1" deep, Overall Size: 6" x 6", Wall Opening: 5-1/8" x 5-1/8"				
	BC2CP-44	Deep Recessed Paper Holder	US26	20	\$47.03
	BC2SS-44	Deep Recessed Paper Holder	US32D	20	\$47.03
	*Shallow: 1-5/8" deep, Overall Size: 6-1/8" x 6-1/8", Wall Opening: 5-1/4" x 5-1/4"				
	BC2CP-63	Shallow Recessed Soap Holder and Grab	US26	20	\$40.11
	*Shallow: 1" deep, Overall Size: 6" x 6", Wall Opening: 5-1/8" x 5-1/8"				
	BC2CP-64	Deep Recessed Soap Holder and Grab	US26	20	\$46.66
	*Shallow: 1-5/8" deep, Overall Size: 6-1/8" x 6-1/8", Wall Opening: 5-1/4" x 5-1/4"				

A

Alameda, 18-19
 Alhambra, 40
 Alto, 48
 Alto 2, 58
 Annapolis, 16, 19
 Armor Plate, 152
 Avalon, 24

B

Ball Catches, 169
 Barn Door Hardware, 156-159
 Baron, 61
 Bath Accessories, 176-212
 Belle, 60
 Bi-fold Knobs, 172

C

Calypso, 55
 Calypso 2, 58
 Cambridge, 25-26
 Campbell, 195-196
 Carmel, 189-190
 Catalina, 39
 Charleston, 184-185
 Chester, 60
 Closet Hardware, 173
 Combo Sets, 67
 Commercial Door Hardware, 147-155
 Commercial Locks, 11-37
 Concealed Washer, 68
 Concord, 31
 Construction Locks, 67
 Corona, 197-199
 Crash Chain, 168
 Curved Shower Rod, 208

D

Dallas, 26
 Davidson, 21
 Daytona, 32
 Deadbolts, 20, 28-30, 63-65
 FDK / FDS Series, 63
 FD2 Series, 64
 FD3 Series, 65
 FD7 Series, 28

FD8 Series, 30

FDP Series, 20

Delayed Egress, 87

Denver, 53

Door Angle Protector, 154

Door Closers, 139-146

 GC4400 Series, 139-140

 GC5900 Series, 141-142

 GC6800 Series, 143-144

 GC8700 Series, 145

 GC800 Series, 146

Door Guards, 154

Door Hardware, 156-175

Door Stops, 151-153, 166-167

 Cast Stops, 166

 Dome Stops, 151-152

 Door Saver Hinge Pin Stops, 151, 167

 Floor Stops, 153

 Hinge Pin Stops, 167

 Spring Stops, 166

 Wall Stops, 151

Door Viewer & Knockers, 160-161

Dust Box, 83

Dust Proof Strike, 150

E

Edison, 200-201

Electric Hardware, 136-137

Electric Latch Retraction, 97-99

Electric Strikes, 136

Electrified Locksets, 138

Estes, 193-194

Eureka, 180-181

Exit Devices, 87-135

 Accessories, 131-134

 E5000 Series, 123-129

 E7000 Series, 115-122

 E8000 Series, 130-134

 E9000 Series, 87-100

 E9100 Series, 101-112

 E9300 Series, 113-114

Extension Kit, 68

Extension Rod, 93, 106, 119, 126, 131

F

Finger Pulls, 173

Floor Roller Guide, 156

Florence, 53

Flush Bolts, 149-150, 171

Fremont, 34

G

Gate Latch, 79

General Information, I-IX

Glass Bead Kit, 93

Grab Bars, 204-205

Granada, 40

H

Hampton, 32

Handleset, 39-45

Handrail Bracket, 168

Hinges, 1-10

Hinge Screws, 9

Hospitality Accessories, 211

I

I/C Core Cylinder, 37

Indicator Deadbolt, 29

Interconnected Handlesets, 44-45

K

Kenton, 35

Keypad Locks, 38

Keys and Cylinders, 71-73

Kick-Down Door Holder, 153

Kickplates, 155

Knobsets, 27, 59-62, 67

Kona, 59

L

La Quinta, 182-183

Latch Guard Protector, 153

Latch Bolt Monitoring, 92

Latches, 76-83

Leversets, 46-58

Lexington, 41

M

Magnetic Door Holders, 136

Milano, 54

Mira, 46



*** WARNING:** Cancer and Reproductive Harm - www.P65warnings.ca.gov - See page 214 to learn more about California Proposition 65

Mirage, 36	Push Plates, 155	Surface Bolts, 171-172
Mop Plate, 152		Swing Up Grab Bar, 205
Mortise Locks, 11-15	R	
Mullions, 135	Recessed Fixtures, 212	T
N	Rekeying Charge, 86	Tacoma, 36
Naples, 49-50	Rekeying Parts, 69-70	Tahoe, 46
Newberry, 51	Residential Hinges, 6-8	The Blue Thing, 169
Newport, 34	Residential Locks, 38-67	Toledo, 35
Number & Letter, 162-165	Request to Exit, 97	Towel Bars, 202-203
O	Roller Bumper, 151	Troy, 42-43
Olympic, 56	Roller Catches, 170	Tuscany, 39
Ontario, 36	S	U
Onyx, 47	Saturn, 62	UL Door Viewers, 160
Other Charges, 86	Savannah, 57	UL Latches, 76-80
Overhead Door Stops, 147-148	Screws, 74-75	Upcharge, 86
P	Seal Beach, 191-192	V
Paper Holder Roller, 201	Shelf & Rod Support, 173	Ventura, 186-188
Pendleton, 17, 19	Shower Rod and Flange Sets, 206-210	Viano, 52
Pole Socket Set, 173	Sierra, 27	Victorian, 42
Power Supply, 138	Silencer, 169	Vina, 178-179
Power Transfer Devices, 137	Sliding Door Locks, 66, 174-175	W
Princeton, 22-23	Solano, 176-177	Westfield, 33
Privacy Door Latch, 154	Spacious Shower Rod, 209-210	Wooden Display Mount, 68
Pull Plates, 155	Springfield, 42	
	Sterling, 35	
	Strike Plates, 84-85	

CALIFORNIA PROPOSITION 65 OVERVIEW

What is Proposition 65?

Proposition 65 requires businesses to provide warnings to Californians about significant exposures to chemicals that cause cancer, birth defects or other reproductive harm. This enables Californians to make informed decisions about their exposures to these chemicals.

Proposition 65 requires California to publish a list of chemicals known to cause cancer, birth defects or other reproductive harm. This list, which must be updated at least once a year, has grown to include approximately 900 chemicals since it was first published in 1987.

What does the warning look like?

 **WARNING: Cancer and Reproductive Harm** - www.P65warnings.ca.gov

What does a warning mean?

The product package associated with the warning could expose individuals to one or more of the chemicals on the list.

How do I learn more about Proposition 65?

Visit this website to learn more about Proposition 65.

<https://www.p65warnings.ca.gov/>

Where do I find answers related to businesses?

https://www.p65warnings.ca.gov/sites/default/files/art_6_business_qa.pdf



Headquarters
 4000 Nimitz Ct.
 Chino, CA 91710

Distribution Center
 8400 Westmonland Dr. NW
 Concord, NC 28027

Phone

1800 808-4768

1800 828-8860

Fax

1800 808-8358

1800 808-8307

sales@panmed.com | panmed.com



Minority Business Enterprise Certified Company

Certificate Number 0004262