



Rekeying Manual

■ Tubular Lockset

■ Leverset

■ Deadbolt

Before rekeying a lock, please read this instruction carefully and retain it for future reference

TABLE OF CONTENTS

1.	Rekeying kit	-P.2
2.	Lockset Components	
2.1	Tubular Lockset	
2.1.1	Knobset	-P.3
2.1.2	Leverset	P.4
2.2	Deadbolt	
2.2.1	Single Cylinder Deadbolt	P.5
2.2.2	Double Cylinder Deadbolt	P.6
3.	Lockset Disassembly, Rekeying, Assembly	
3.1	Tubular Lockset	P.7-16
3.2	Deadbolt	P.17-22
4.	Principle of Pin Tumbler Mechanism	P.23-25
5.	Keying Device	P.26
5.1	Keyed Different (KD)	-P.27
5.2	Master Keyed (MK)	P.27-29
5.3	Construction Keyed (CK)	P.30-32
5.4	Keyed Alike (KA)	-P.32

1. KEYING KIT

This Keying Kit contains assorted pins, springs, circlip and tools needed for servicing tubular lockset, deadbolt, cylindrical lockset and handleset..

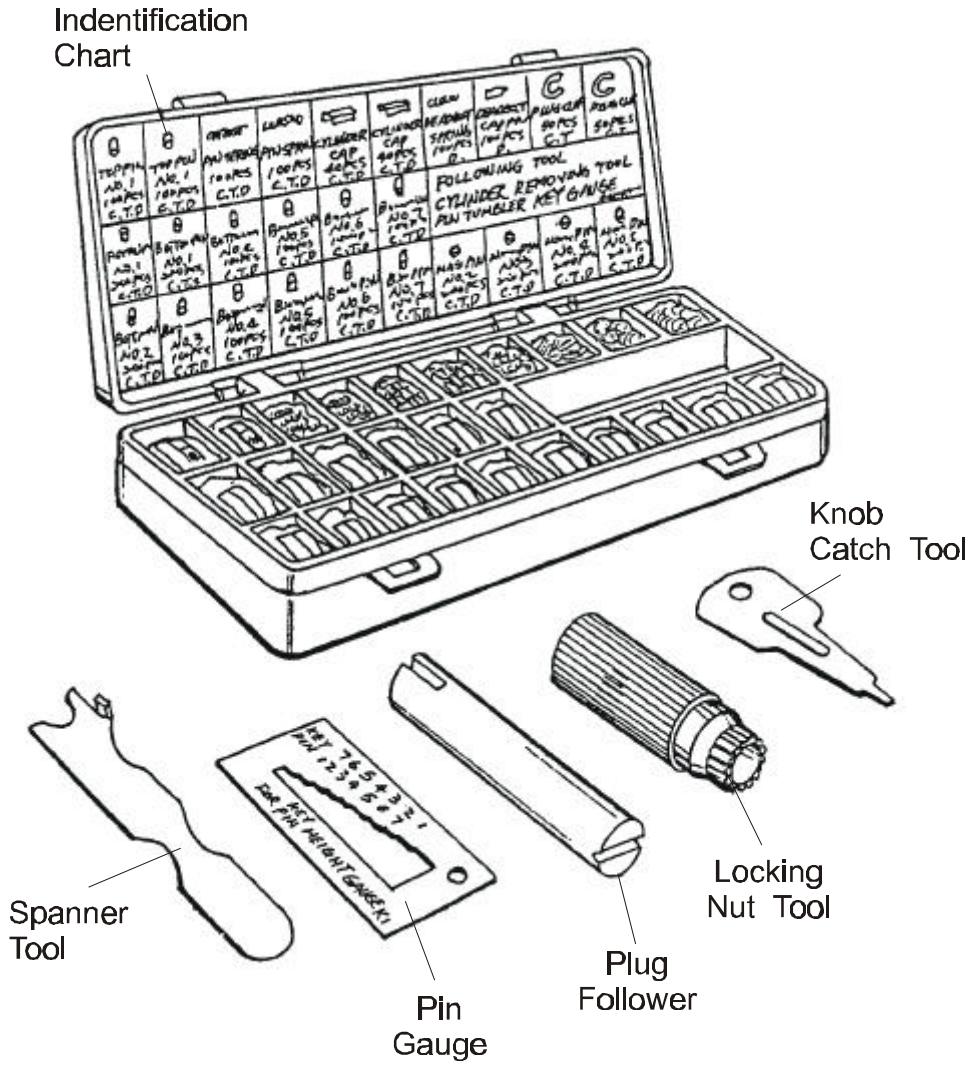

2. LOCKSET COMPONENTS

2.1 Tubular lockset

2.1.1 knobset

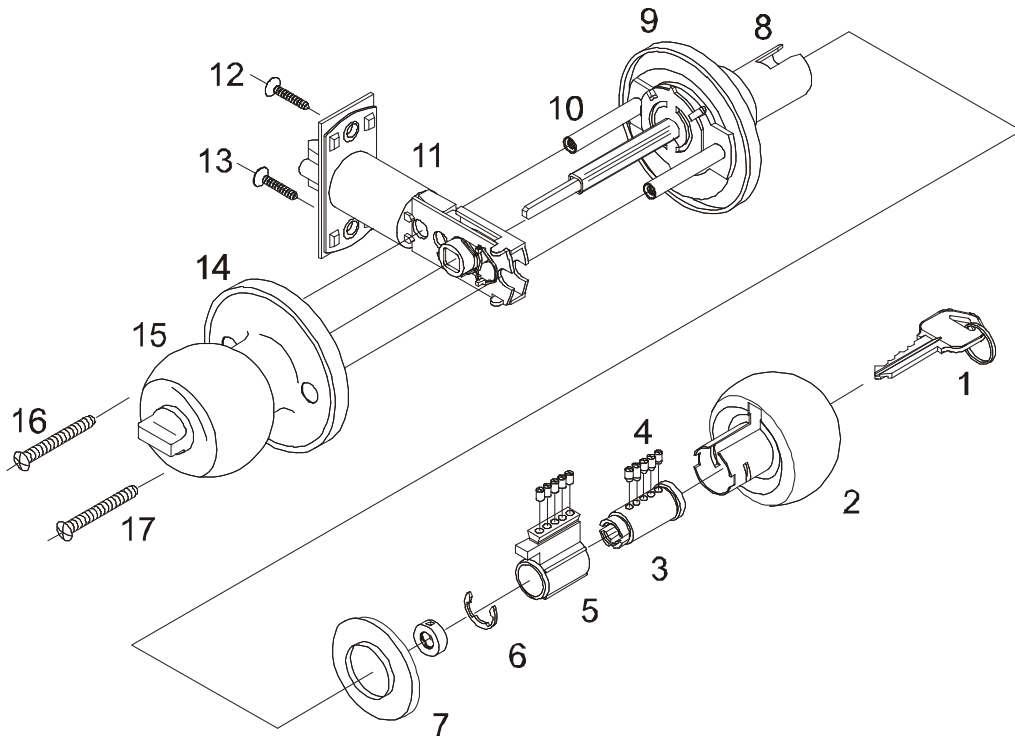

- | | |
|---------------------------|---------------------|
| (1) Key | (10) Spindle |
| (2) Outside Knob | (11) Latch |
| (3) Plug | (12) Wood Screw |
| (4) Bottom Pin | (13) Wood Screw |
| (5) Cylinder Housing | (14) Inside Rose |
| (6) Circlip | (15) Inside Knob |
| (7) Outside Knob Rear Cap | (16) Mounting Screw |
| (8) Rollback | (17) Mounting Screw |
| (9) Outside Rose Unit | |

2.1.2 Leverset

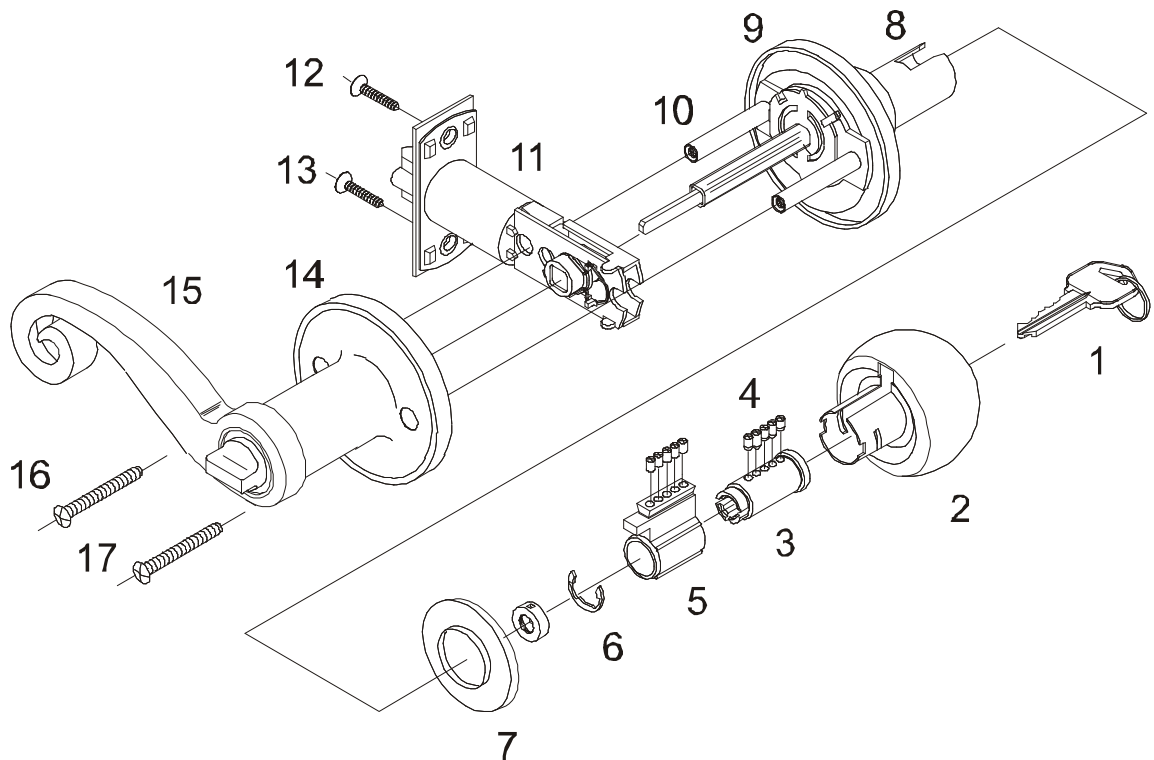

- | | |
|---------------------------|---------------------|
| (1) Key | (10) Spindle |
| (2) Outside Knob | (11) Latch |
| (3) Plug | (12) Wood Screw |
| (4) Bottom Pin | (13) Wood Screw |
| (5) Cylinder Housing | (14) Inside Rose |
| (6) Circlip | (15) Inside Knob |
| (7) Outside Knob Rear Cap | (16) Mounting Screw |
| (8) Rollback | (17) Mounting Screw |
| (9) Outside Rose unit | |

2.2 Deadbolt

2.2.1 Single Cylinder Deadbolt

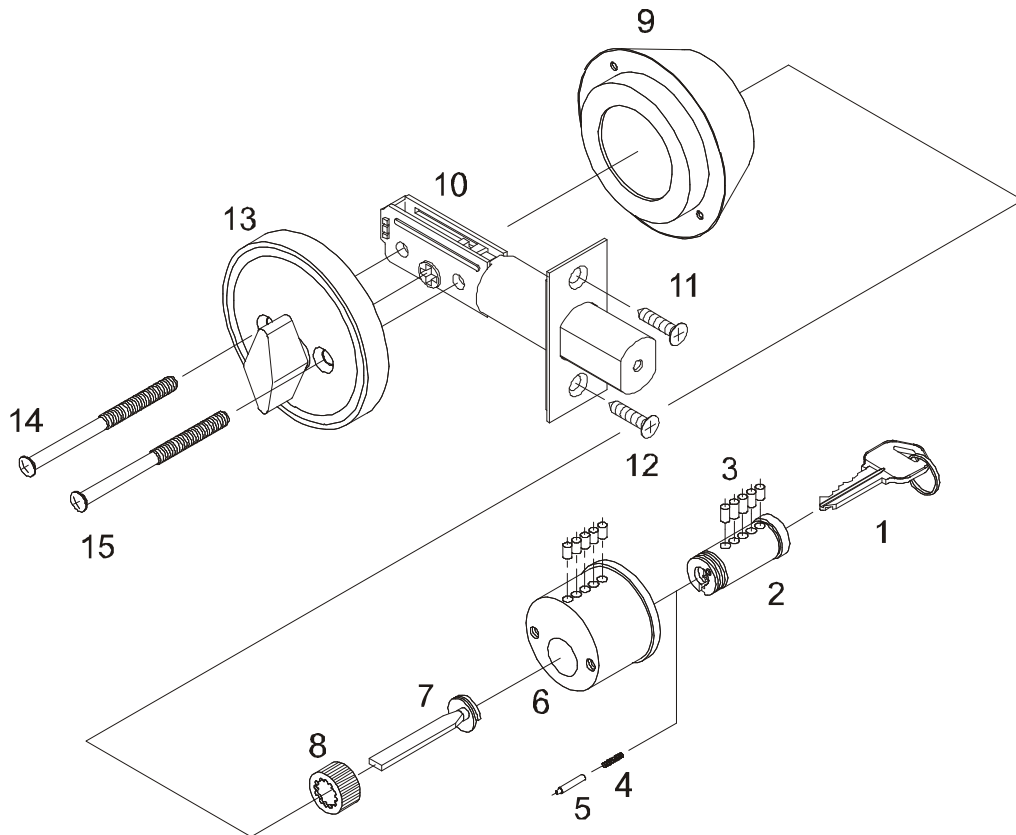

- | | |
|----------------------|----------------------------|
| (1) Key | (9) Outside Cylinder Guard |
| (2) Plug | (10) Deadbolt Latch |
| (3) Bottom Pin | (11) Wood Screw |
| (4) Retaining Spring | (12) Wood Screw |
| (5) Retaining Pin | (13) Inside Trim |
| (6) Cylinder Housing | (14) Mounting Screw |
| (7) Tail Piece | (15) Mounting Screw |
| (8) Locking Nut | |

2.2.2 Double Cylinder Deadbolt

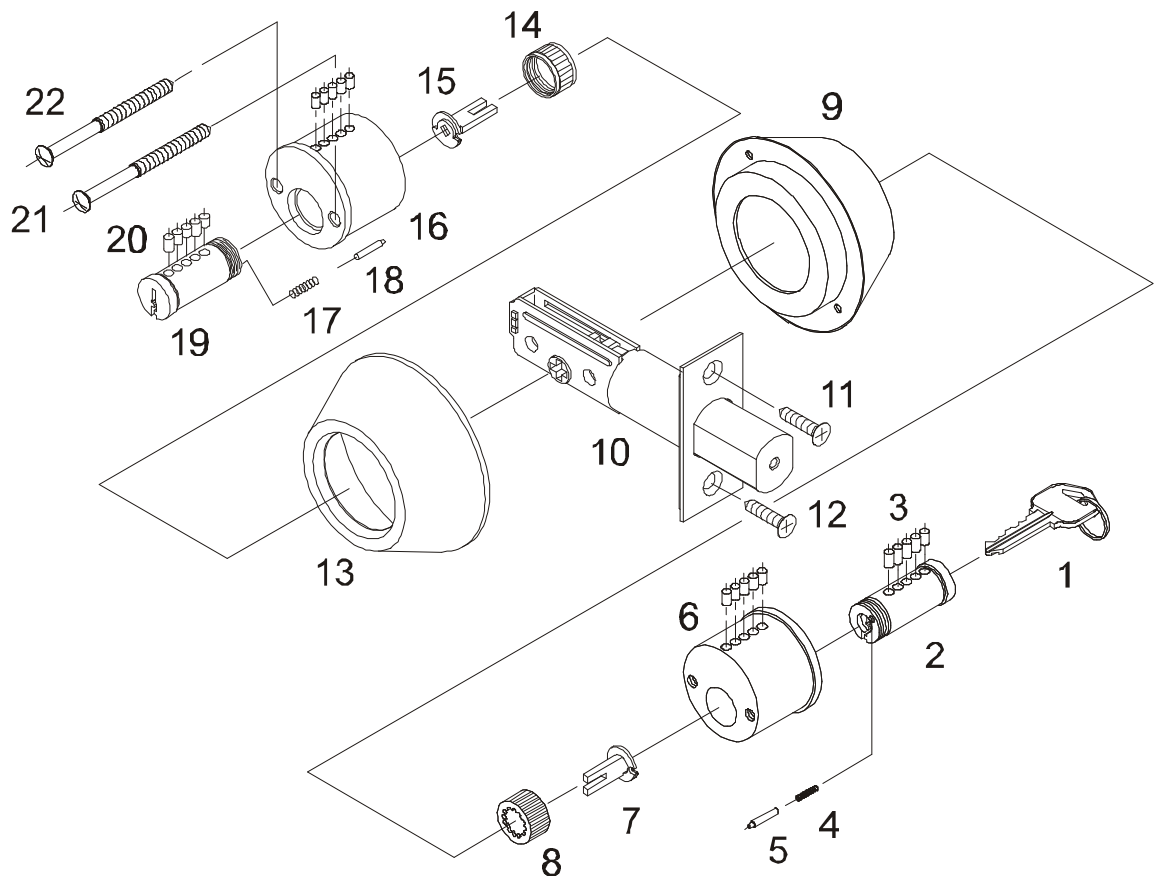



- | | | | |
|-------|--------------------------|------|-------------------------|
| (1) | Key | (12) | Wood Screw |
| (2) | Plug | (13) | Inside Cylinder Guard |
| (3) | Bottom Pin | (14) | Locking Nut |
| (4) | Retaining Spring | (15) | Inside Tail Piece |
| (5) | Retaining Pin | (16) | Inside Cylinder Housing |
| (6) | Outside Cylinder Housing | (17) | Retaining Spring |
| (7) | Outside Tail Piece | (18) | Retaining Pin |
| (8) | Locking Nut | (19) | Plug |
| (9) | Outside Cylinder Guard | (20) | Bottom Pin |
| (10) | Deadbolt Latch | (21) | Mounting Screw |
| (11) | Wood Screw | | |

3. LOCKSET DISASSEMBLY, REKEYING, ASSEMBLY

Please refer to Section 5 for keying and pinning systems.

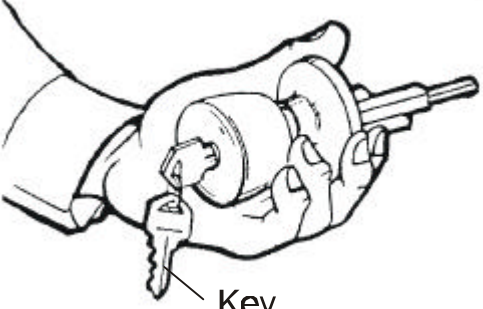
3.1 Tubular Lockset

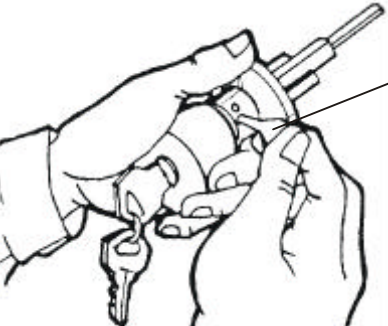
<p>1. Insert key.</p>	 <p>Key</p>
<p>2. Turn outside knob counterclockwise until the knob catch aligns and is visible under the catch hole.</p>	 <p>Knob Catch Hole</p> <p>Outside Knob</p>
<p>3. Use knob catch tool to depress knob catch and pull to disengage outside knob.</p>	 <p>Knob Catch Tool</p>

4. Pull out outside knob.

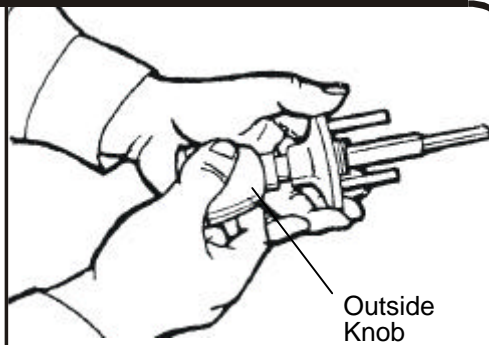

5. Use a flat tool to pick up cap at knob bottom until the cap pops off the shank.

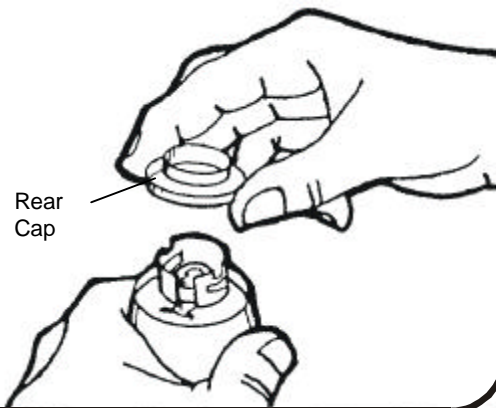
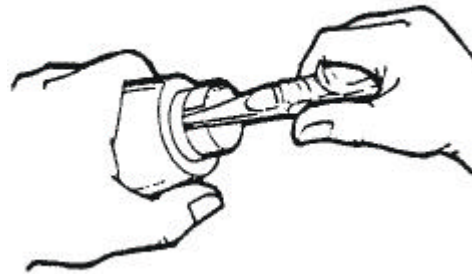

6. Use forefinger to press the plug in the knob. Pull out the key and then remove cylinder plug assembly with long nose pliers. (Note : Do not pull out the key before pressing the plug with forefinger to avoid dropping the plug.)

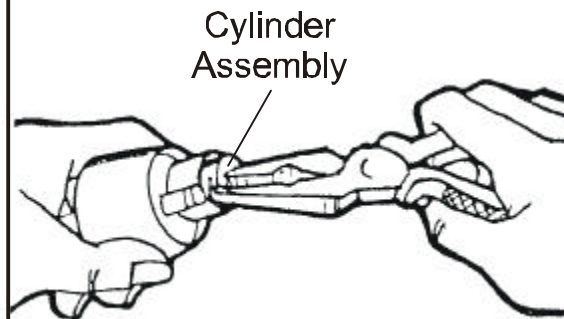
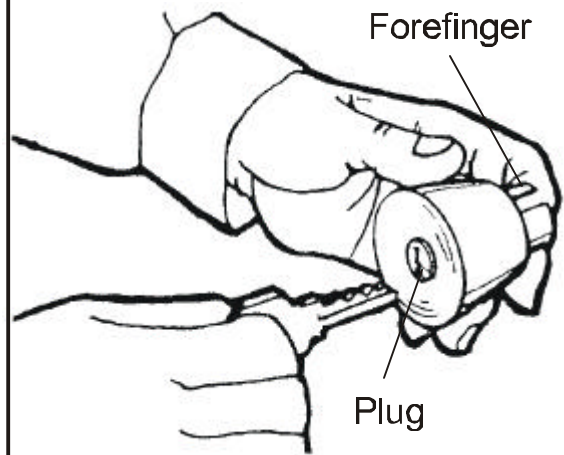

7. Insert the key again into the plug.

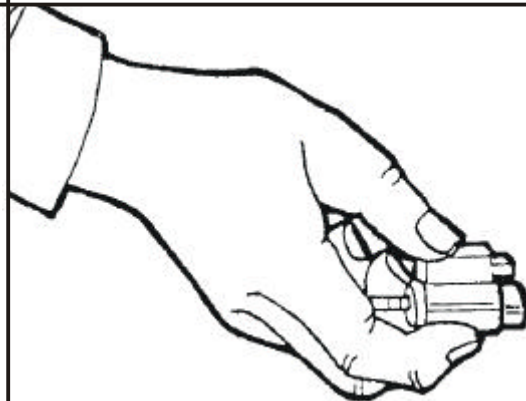

8. Use end of spanner tool to push out circlip.

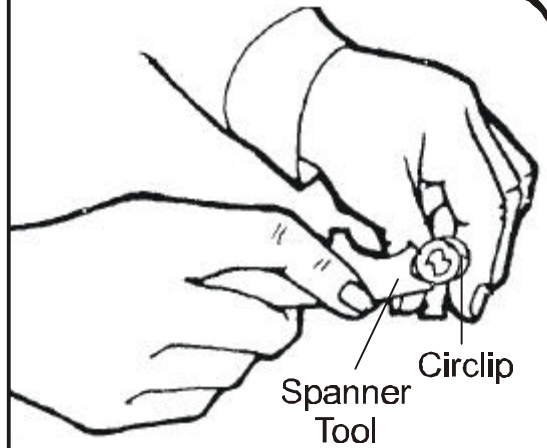

9. Remove circlip with prong of spanner.

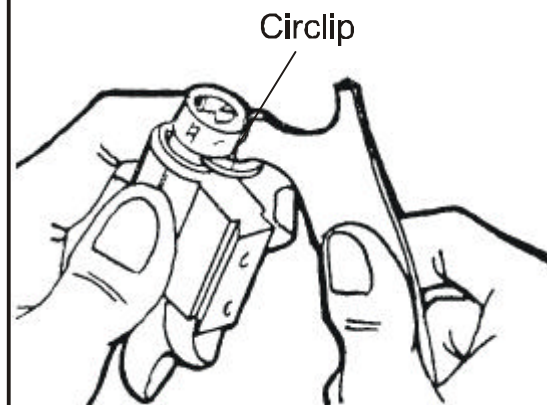

10. Turn key 45°-90° left or right.

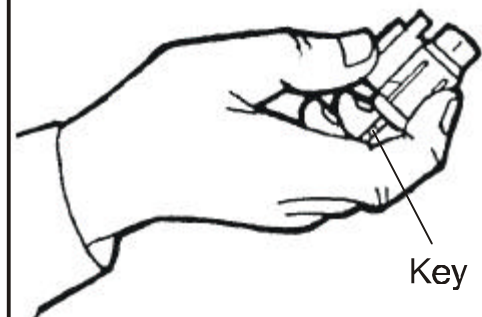

11. Insert plug follower to push plug out of cylinder housing.
(Note : 2 slots on plug follower head should always be kept horizontal before you insert the follower.)

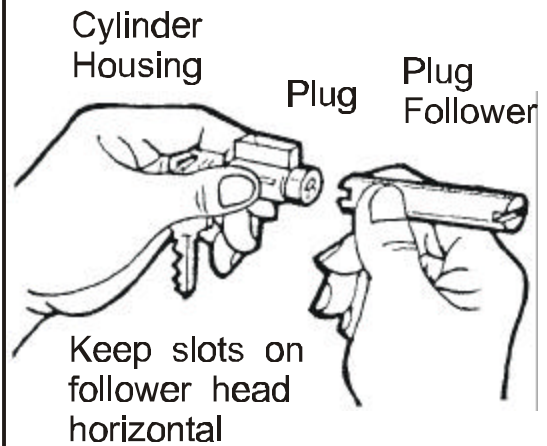

Caution :
Do not pull out plug follower from cylinder housing, otherwise top pins and springs will drop out of housing.

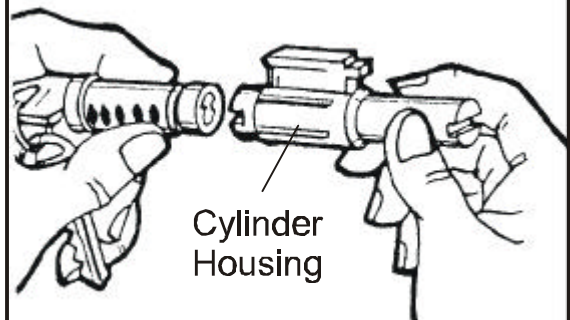

12. Pull out key from plug and remove bottom pins out of pin holes.

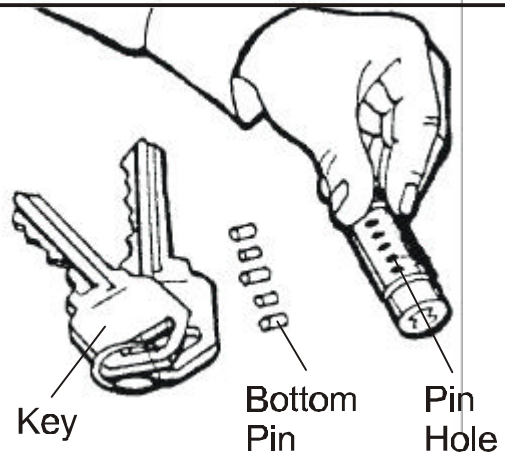

13. Insert new key.
Read the number stamped on key bow, for example, 32533.

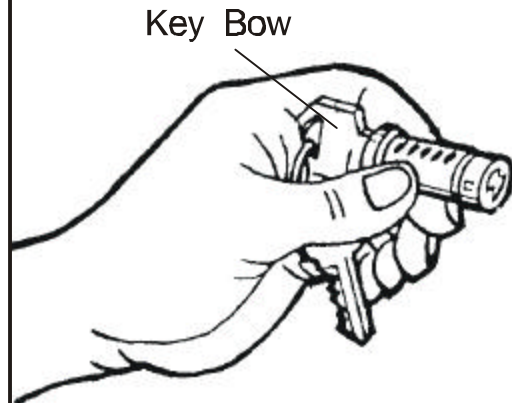

14. Pick a bottom pin #3 from keying kit box and load it into 1st hole next to key head, load a bottom pin #2 into 2nd hole, bottom pin #5 into 3rd hole, bottom pin #3 into 4th hole and bottom pin #3 into 5th hole.

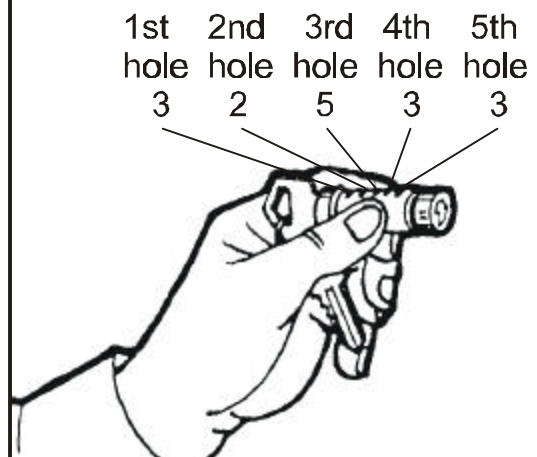

15. Make sure all pins are flush with surface of plug with key inserted.
File off any excess length of pins as needed.
Rotate plug with the help of the key when filing so that the pin top conforms with the contour of the plug.

16. Turn key 45° - 90° and insert plug back into cylinder housing.
(Slots on follower end should always be kept horizontal to avoid pins from being trapped)

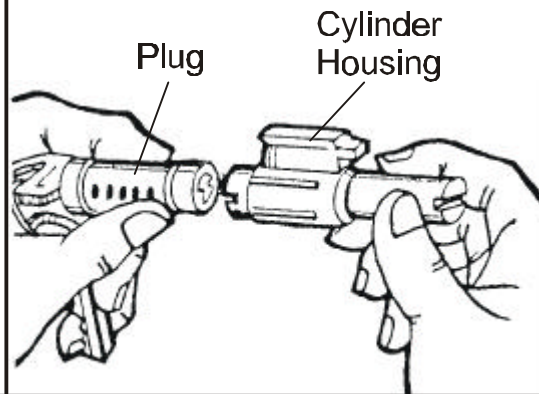

17. Push out plug follower.

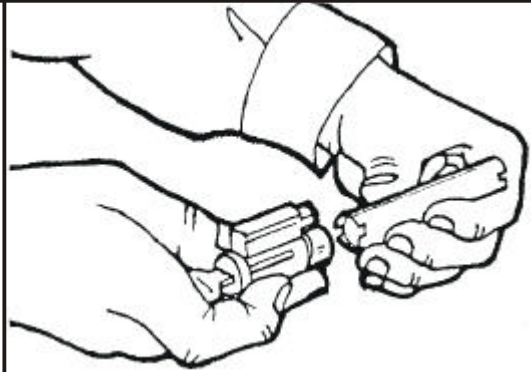

18. Load circlip.

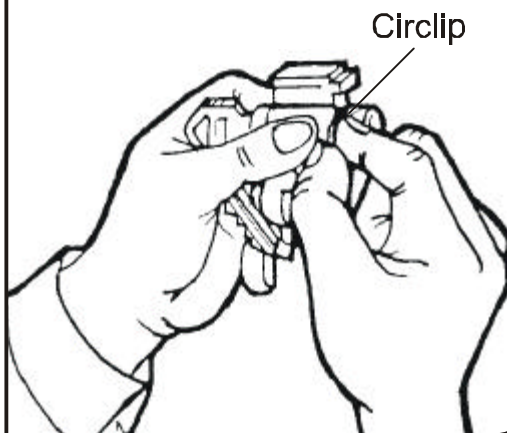

19. Secure circlip firmly in place by using long nose pliers.

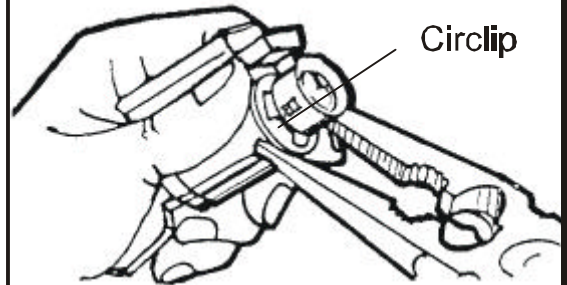

20. Operate key to check if plug rotates smoothly against cylinder housing without interference.

21. Pull out key.

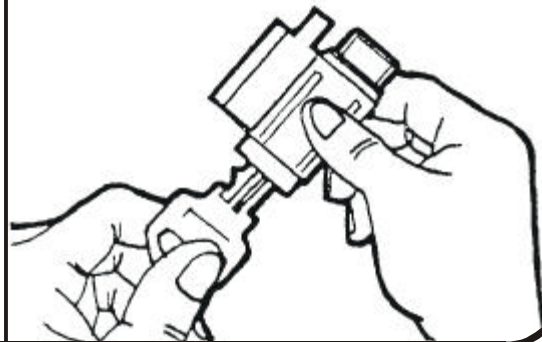

22. Push cylinder assembly into outside knob.

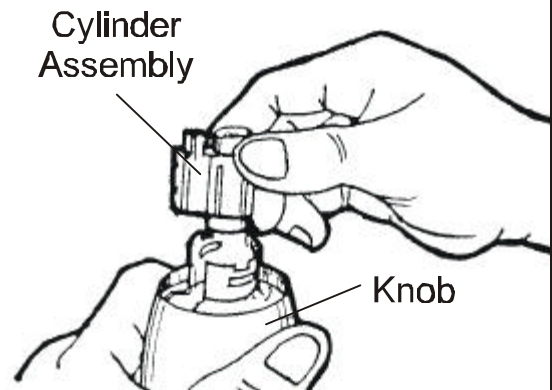

23. Push rear cap to fit onto knob shank.

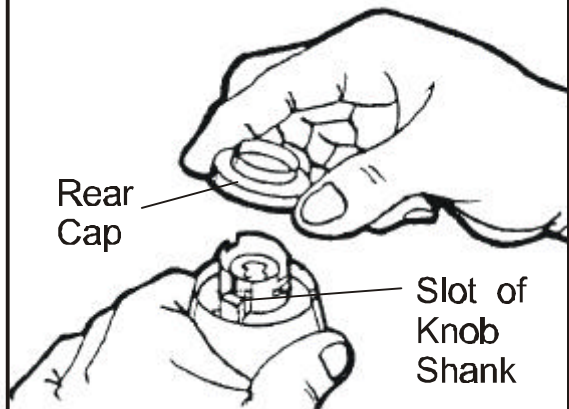

24. Align slot of knob shank and rollback then push outside knob all the way in until knob is retained by knob catch firmly.

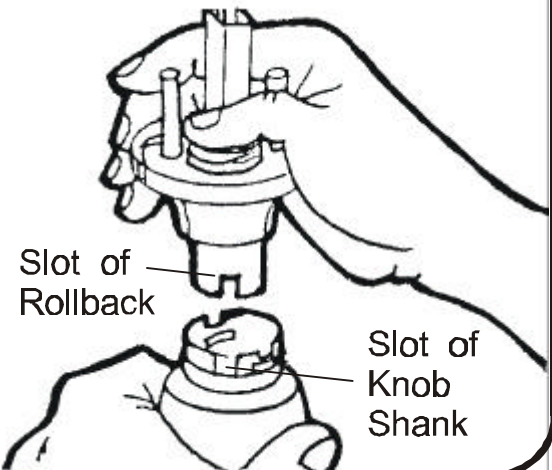

25. Turn knob to check if lock functions properly.

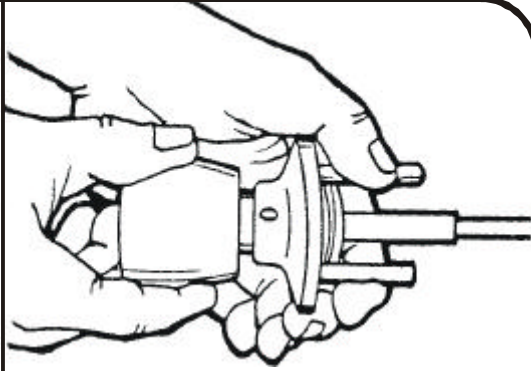

26. Insert the key again to check if key functions properly.

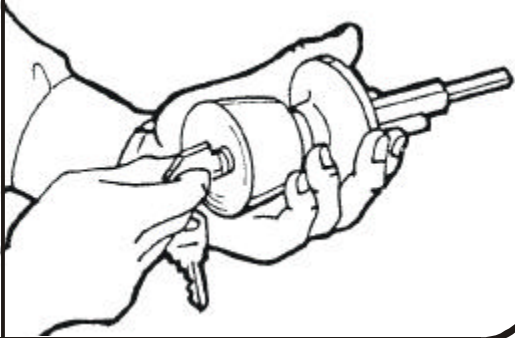

3.2 Deadbolt

1. Disassemble deadbolt, remove cylinder from cylinder guard, insert the key.
Note: Regardless of zinc diecast or solid brass cylinder housing, the rekeying procedure is the same.

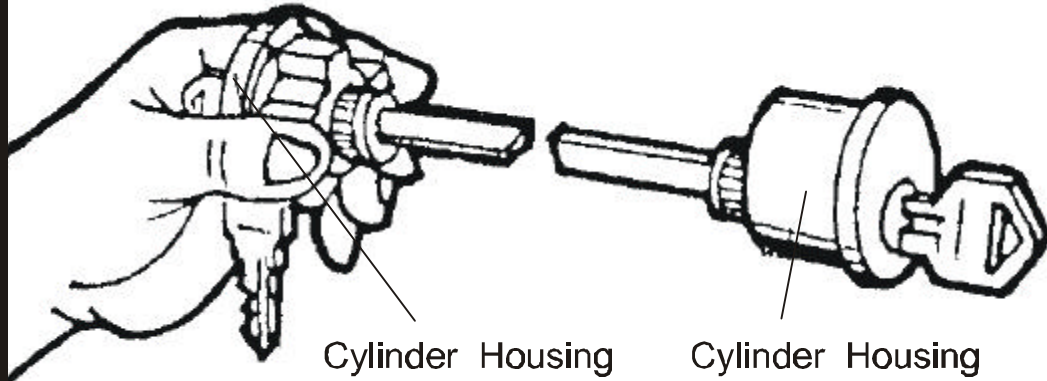

2. Apply locking nut tool and turn counterclockwise to loosen locking nut.

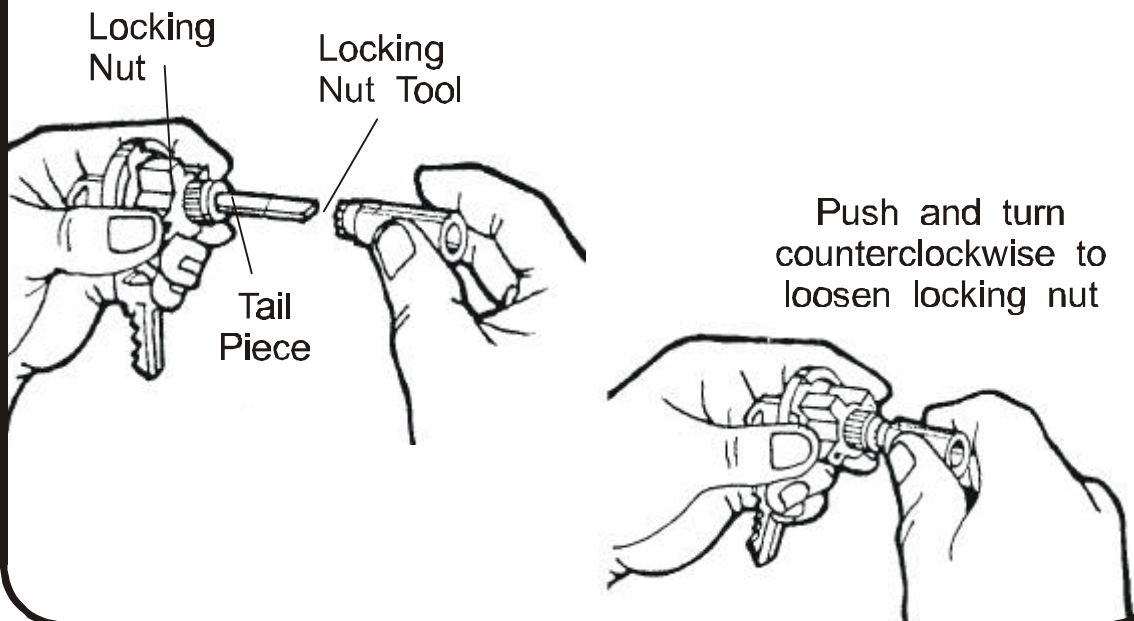

3. Remove locking nut and tail piece.

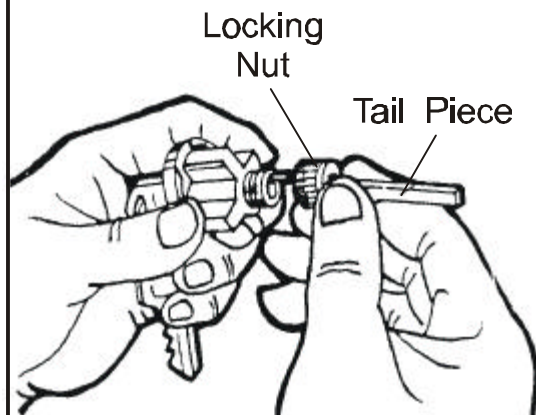

4. Remove retaining pin and spring.

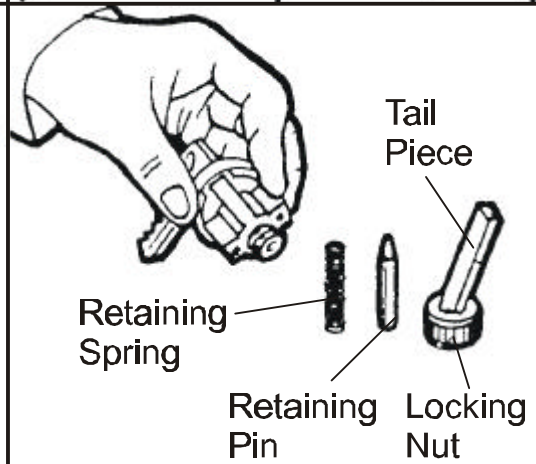

5. Trun key 45° - 90°.

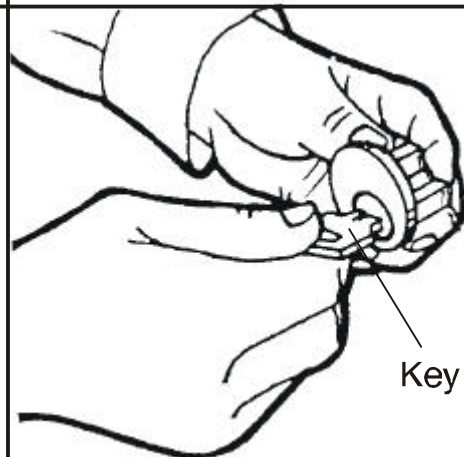

6. Insert plug follower to push plug out of cylinder housing.
(Note : 2 slots on follower should always be kept horizontal before you insert the follower.)

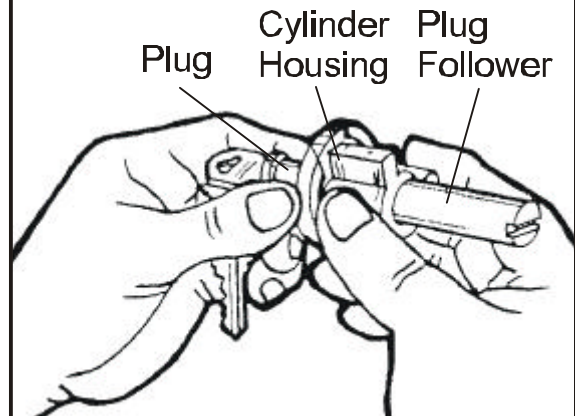

Caution :
Do not pull out plug follower from cylinder housing, otherwise top pins and springs will drop out of housing.

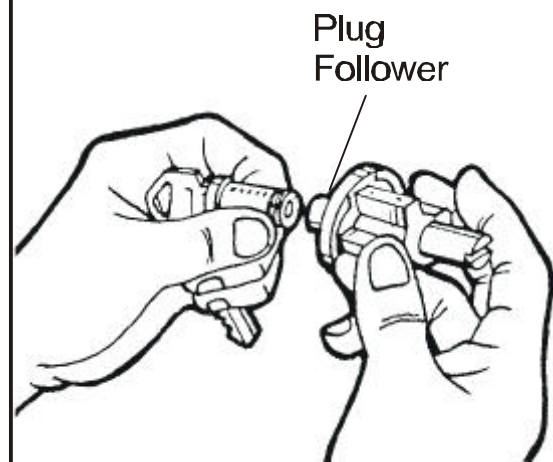

7. Pull out key and remove bottom pins out of pin holes.

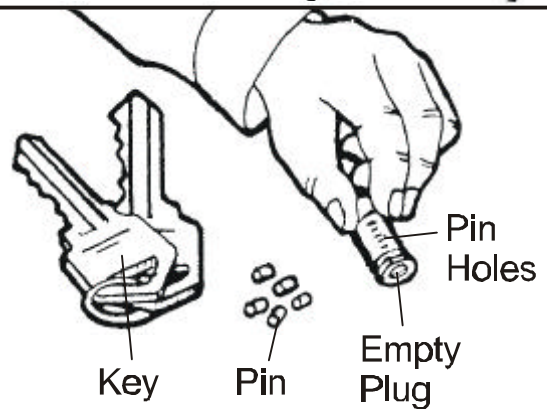

8. Insert new key.
Read the number stamped on key bow, for example, 32533.

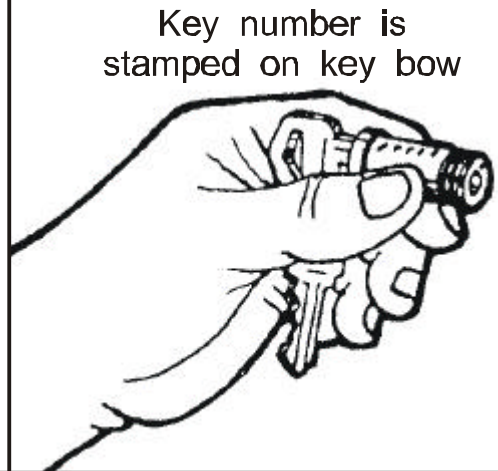

9. Pick bottom pins from keying kit box and load them into plug holes. Follow the same procedure as described in Section 3.1 (pages 13 - 14) for rekeying.

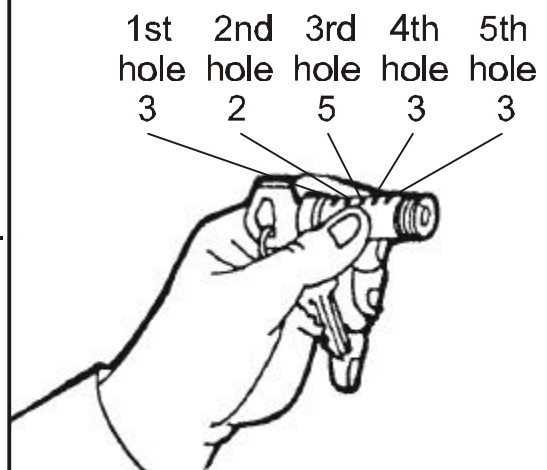

10. Turn key 45° - 90° insert plug back into cylinder housing. (Slots on follower end should always be kept horizontal to avoid pins from being trapped)

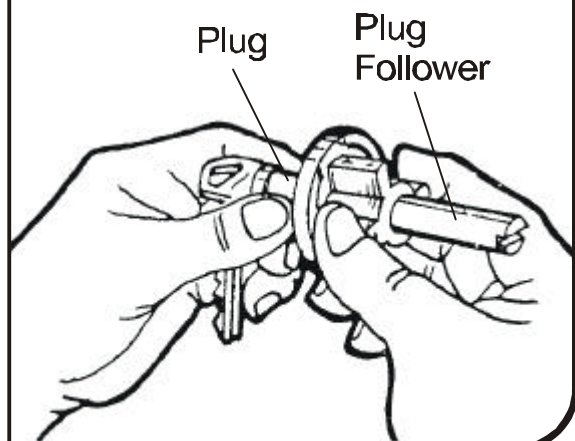

With the pins in place and key in plug, Insert plug back into cylinder housing. Push out plug follower with the plug.

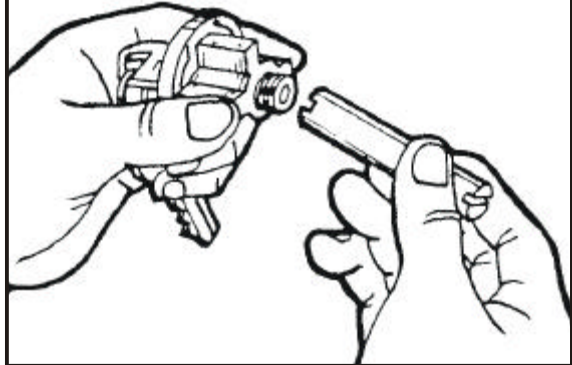

Try new key to see if plug rotates smoothly without interference.

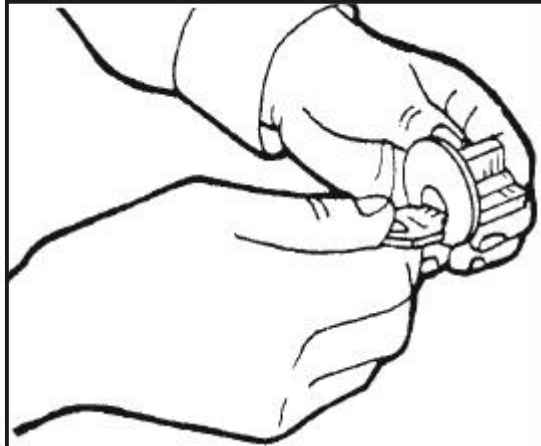

11. Load retaining spring.

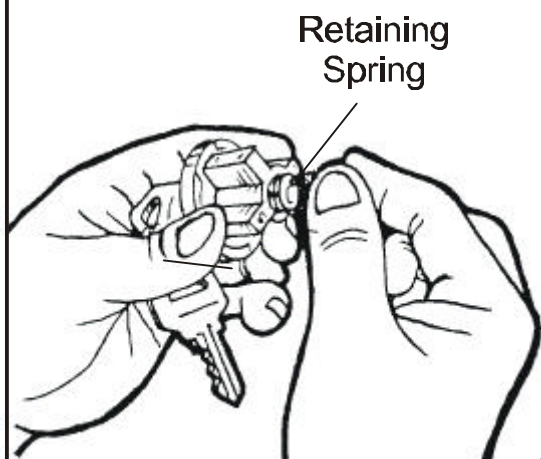

12. Load retaining pin.

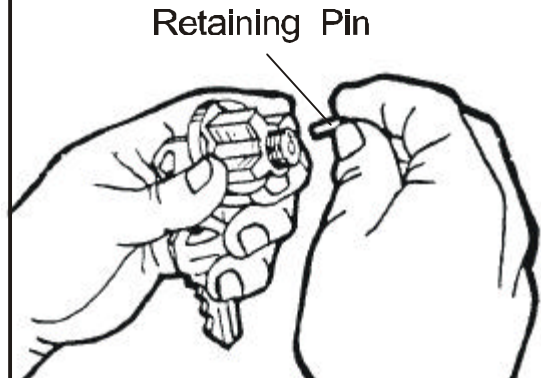

13. Fit locking nut with tail piece.

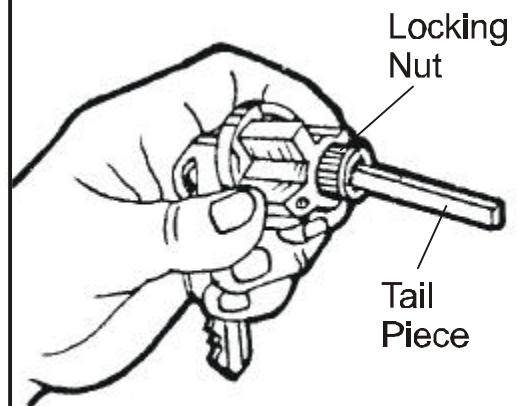

14. Tighten locking nut with tool.

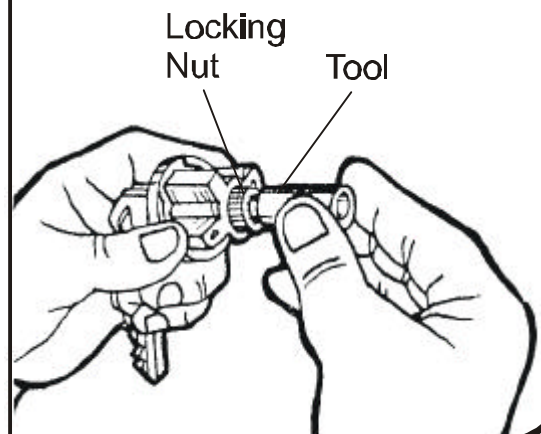

4. PRINCIPLE OF PIN TUMBLER MECHANISM

The construction of pin tumbler locking mechanism is shown as illustrated below

4.1 Regular Lock - one pin break line

4.1.1 Locking

With the key removed, top pins are compressed down by springs across pin break line to block the plug from rotating against cylinder housing.

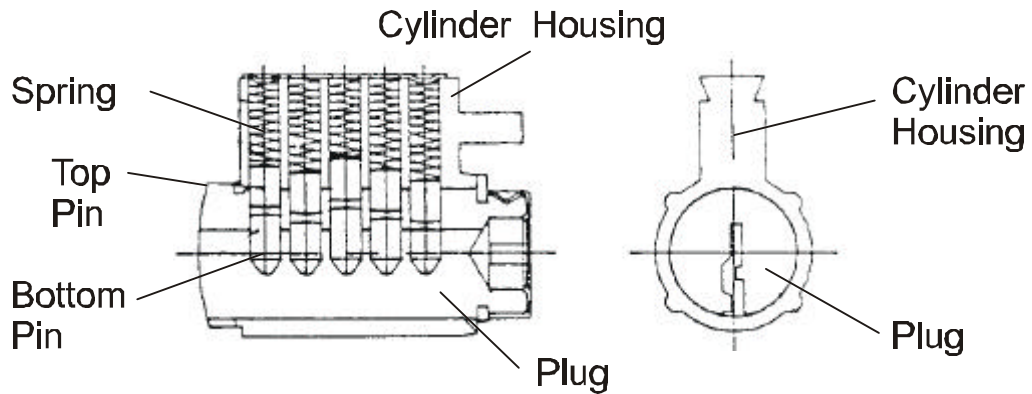

4.1.2 Unlocking

With the correct key inserted into plug, the key will lift bottom pins up to be flush with the surface of plug to create a pin break line.

This will allow the key to turn the plug freely without interference retracting latch for unlocking.

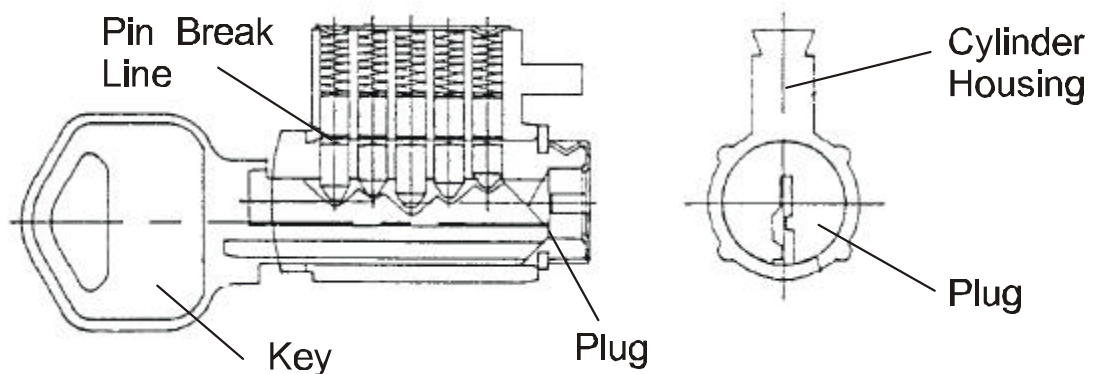

4.2 Master Keyed Lock - two pin break lines

In a master keyed lock pin tumbler, the middle pins are used so that 2 pin break lines are created.

This allows individual key to turn the cylinder through a pin break line and also allows the master key to turn the same cylinder through the other pin break line for unlocking.

4.2.1 Locking

With the key removed, the top pins and middle pins are compressed by springs across pin break line to block the plug from rotating against cylinder housing.

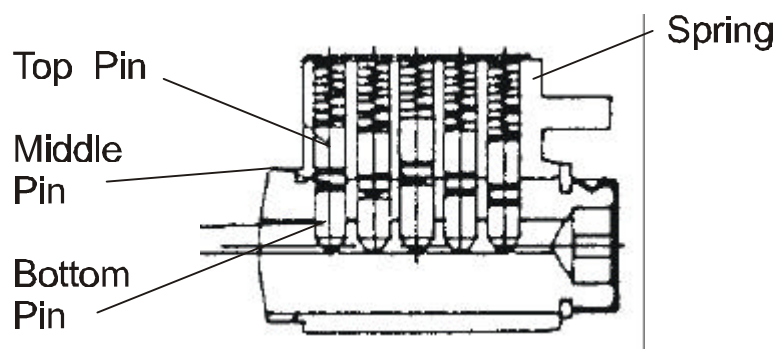

4.2.2 Unlocking

4.2.2.1 Individual key unlocking :

With individual key inserted, the key will lift bottom pins and middle pins up to be flush with the surface of plug to create a pin break line.

This will allow the individual key to turn the plug for unlocking.

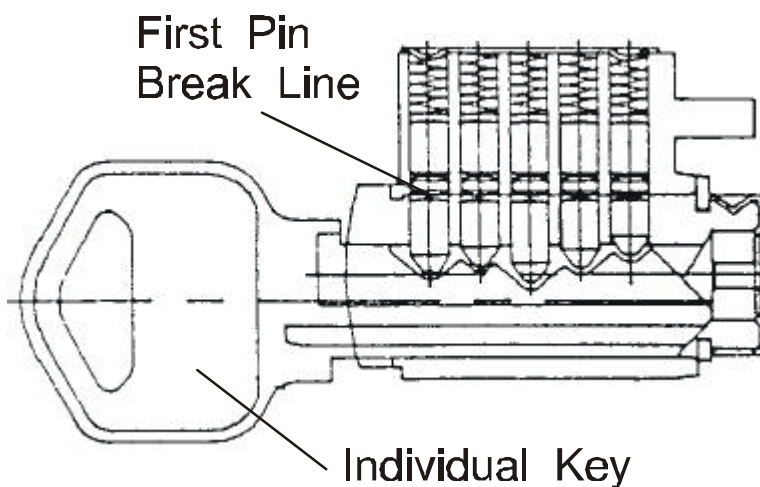

4.2. 2.2 Master Key Unlocking :

With the master key inserted, the key will lift bottom pins and middle pins up to be flush with the surface of plug to create another pin break line.

This will allow master key to turn the plug for unlocking.

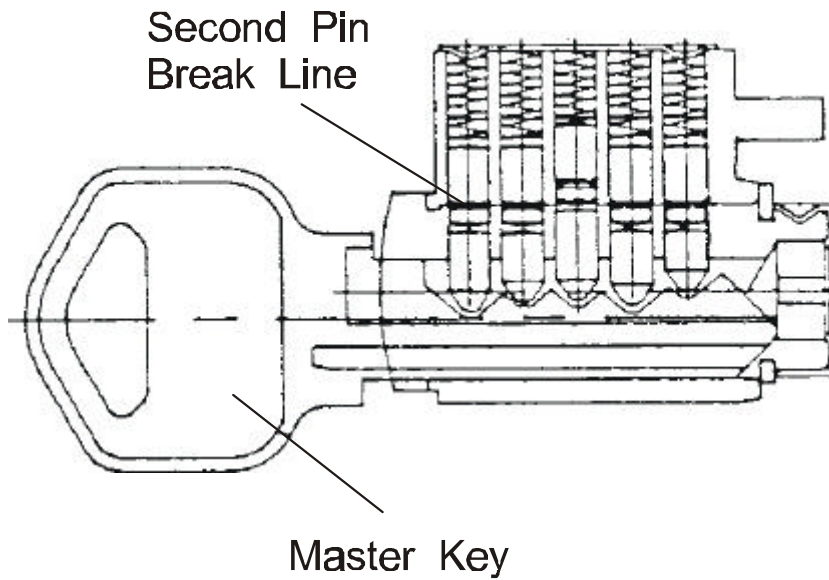

5. KEYING DEVICE

The following pinning system conforms with Kwikset keying system only. Please consult manufacturer for other systems.

Our standard keying kit contains various pins of the following sizes in conformity with Kwikset keying system.

Bottom pin : Diameter : 2.87 - 2.89mm

Length of pin : No.1	4.318mm
No.2	4.902mm
No.3	5.486mm
No.4	6.070mm
No.5	6.654mm
No.6	7.238mm
No.7	7.822mm

Length increment of two consecutive pin numbers is 0.584mm.

Top pin : Diameter : 2.87 - 2.89mm

Only one size of 4.60mm in length.

Middle pin : Diameter : 2.87 - 2.89mm

Length of pin : No.1	0.584mm
No.2	1.168mm
No.3	1.752mm
No.4	2.336mm
No.5	2.920mm
No.6	3.504mm

Length increment of two consecutive pin numbers is 0.584mm.

To achieve better security, it is suggested the following should be observed when practicing rekeying.

- (1) Difference between any two consecutive digits of a key number shall not exceed 4 (exclusive).

For example, key number 16247 is not suggested.
Number 26251 is acceptable.

- (2) No three same consecutive digits are to be applied in a key number.
For example, key number 33364 is not suggested.
Number 22544 is acceptable.

Keyed Different (KD)

The key to an individual lock in a group of locks will operate that particular lock only and no other locks.

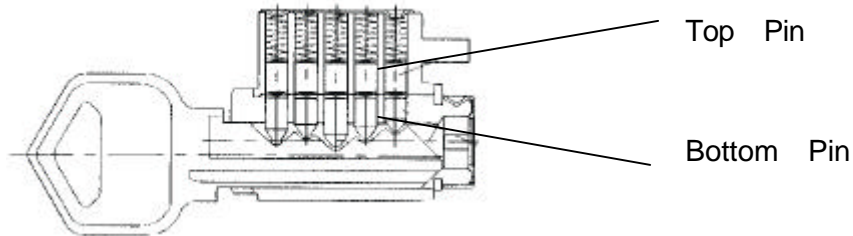

To rekey a KD lock, just follow the procedure described in Section 3.

- a. Remove plug.
- b. Insert new key and replace bottom pins complying with new key number.
- c. Assemble plug with cylinder.

5.2 Master Keyed (MK)

Each lock in the group is keyed different.
A master key opens all locks in that particular group.

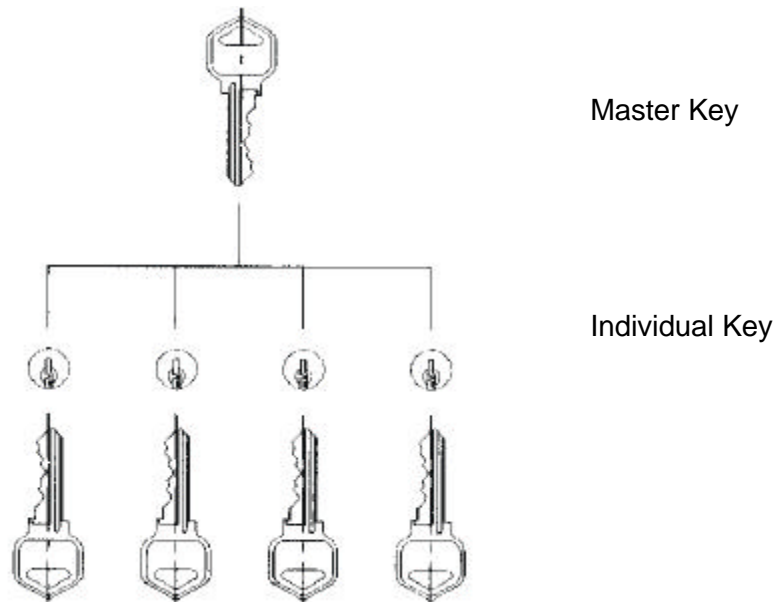

For example, in a hotel, each guest room has an individual key to open its entrance lock. The individual key for this particular room can not open the locks of the other guest rooms.

Each floor of the hotel has a key called master key which can open all entrance locks of all guest rooms of that particular floor.

All locks under the management of a master key are then called master keyed under the same group. To rekey a lock master keyed, follow the procedure described below.

(1) Set up a master key number (high lever) and a group of individual key numbers (Difference of 5 and 2 low level) according to project required. When randomly selecting key numbers, it is suggested numbers of any level should be different from the next lower or higher level by at least 2 in a corresponding digit - of sequence manner. For example, we may choose master key number 32655 to develop a group of individual key numbers such as 54232, 14323, 65473 and others.

(2) Determine the bottom pin number by choosing whichever is a smaller number of master key number and individual key number.

For example : 3 2 6 5 5 - Master key number

5 4 2 3 2 - Individual key number

3 2 2 3 2 - Bottom pin number

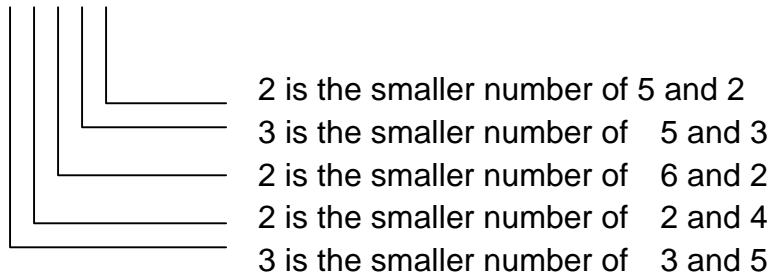

(3) The middle pin number will be the difference of master key number and individual key number.

For example : 32655 - Master key number

5 4 2 3 2 - Individual key number

2 2 4 2 3 - Middle pin number

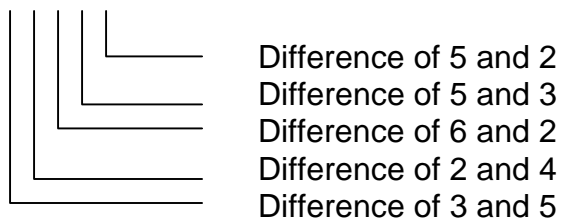

- (4) Now you have 4 numbers.
- 32655 Master key number
 - 54232 Individual key number
 - 32232 Bottom pin number
 - 22423 Master middle pin number
- (5) Remove plug out of cylinder housing by following procedure as described in Section 3.
- (6) Load the bottom pins # 32232 into plug.
- (7) Do not insert any key into plug. Load the middle pins # 22423 on top of the bottom pins in the plug.
- (8) Insert plug fully back into cylinder housing with center line of pin holes of the plug misaligned from center line of pin holes of the cylinder housing by a slight angle. Insert either master or individual key to engage keyway of the plug. Rotate the plug to adjust alignment of pin holes of plug with pin holes of cylinder housing. Then insert key fully.

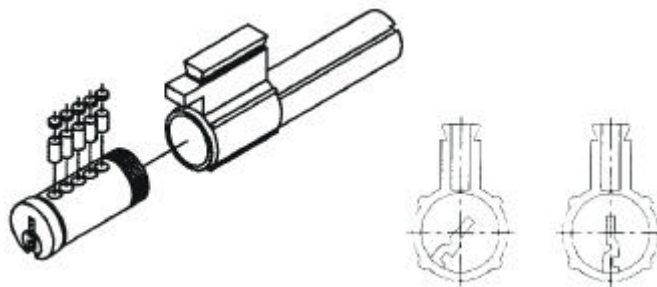

- (9) Complete assembly of the lock by following procedure as described in Section 3.
- (10) Insert both master and individual keys to operate locking and unlocking. If both keys work normally, then the lock is master keyed.

5.3 Construction Keyed (CK) :

Construction keying is used where it is necessary for building contractor to gain entry by operating builder's key during the construction of a building. Homeowner's key, once applied, shuts off builder's key automatically.

To set up a construction keyed system, you need to have your order specified for preparation of the following parts.

- a. Plug drilled with construction hole(s) of 2.4mm diameter and 2.7mm deep.

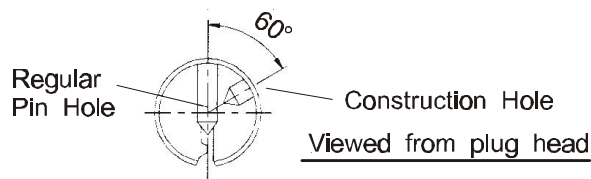

Construction hole(s) is drilled 60 lockwise from center line of regular pin holes viewed from plug head where key is to be inserted.

- b. Construction ball

Construction ball is a steel ball of 2.4mm diameter which is an equivalent to 4 increments of bottom pin length.

- c. Builder's key & Homeowner's key

Builder's key is the same as homeowner's key except one of the key cuts is 2.32mm deeper than homeowner's key.

The extra depth of 2.32mm (an equivalent to 4 increments of bottom pin length) of that specific key cut is to accommodate the construction ball which is retained in that particular pin hole of the plug during construction period.

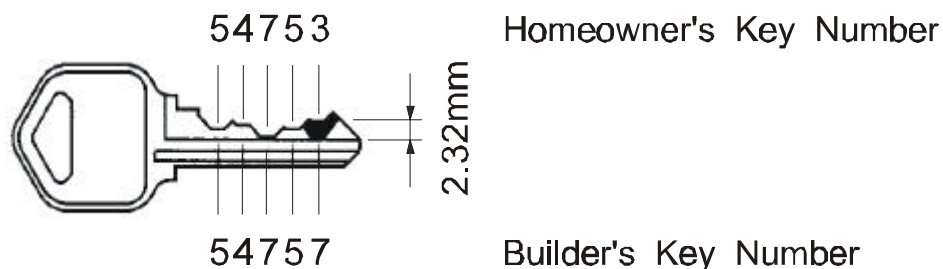

To rekey a lock construction keyed, follow the procedure described below.

(1) Remove plug as described in Section 3.

(2) Set up builder's key number and homeowner's key number.

Determine where the construction ball is to be installed, e. g., the 5th pin hole.

Assign builder's key number, say # 54757 noting the 5th digit (in this case, 7) should always be larger by 4 than the 5th digit of the homeowner's key.

Then we determine homeowner's key number as # 54753.

1st hole	2nd hole	3rd hole	4th hole	5th hole	
5	4	7	5	7	----- Builder's key number
5	4	7	5	3	----- Homeowner's key number

				4	----- Difference of key cut depth in 5th hole to accomodate construction ball

(3) Insert homeowner's key into plug drilled with construction holes.

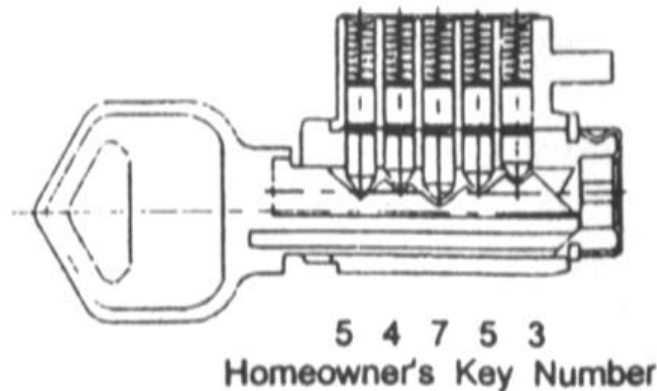

(4) Load bottom pin # 54753 into bottom pin holes. Make sure all pins are flush against plug surface.

- (5) Pull out homeowner's key. Insert builder's Key.
Load a construction ball into 5th hole on top of bottom pin # 3.

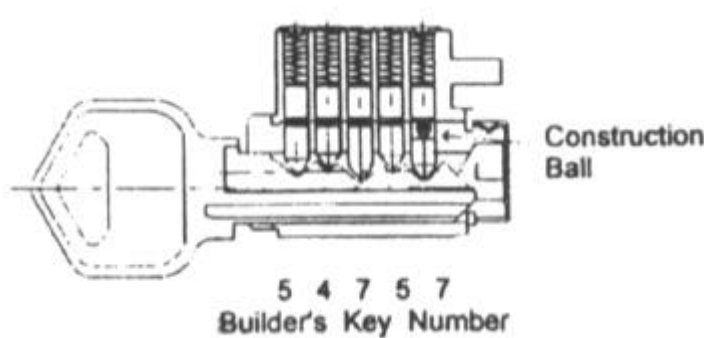

- (5) Make sure the first 4 bottom pins and construction ball in the 5th hole are flush against surface of plug.
- (7) Complete assembly of lock by following procedure of Section 3.
Caution : Never apply homeowner's key during construction period or before the homeowner takes delivery.
- (8) To shut off builder's key, insert homeowner's key into plug and turn counterclockwise over an angle of 60° or turn clockwise over an angle of 300° as construction ball will be lifted up over the plug surface and then drops into the construction hole. If then the builder's key, say #54757, is applied again, the top pin of the 5th hole will fall to sit across the border line of cylinder plug and housing, thus blocking rotation of the plug.

5.4 Keyed Alike (KA)

In a group of keyed alike locks, the same key number is to be applied to each of the locks, i. e., a key of that particular number will operate all locks under the group.

A group of keyed alike locks may have 2, 3, 4 or more locks and thus be designated as KA2, KA3, KA4 etc.

To rekey a group of locks keyed alike, simply follow the procedure as described in Section 3, using the same key for all locks.