

# CRYSTORAMA

LIGHTING THE WAY FOR SIXTY YEARS



Crystorama.com

## ASSEMBLY INSTRUCTION MODEL#2265-AG



All electrical components must be installed by a licensed electrician in accordance with the National Electric Code and the appropriate local electrical codes.



You will need 3-Medium Base Bulb  
60 Watts Recommended 100 Watts Max.  
USE LED BULBS FOR EXTENDED USE  
This fixture is Dry rated

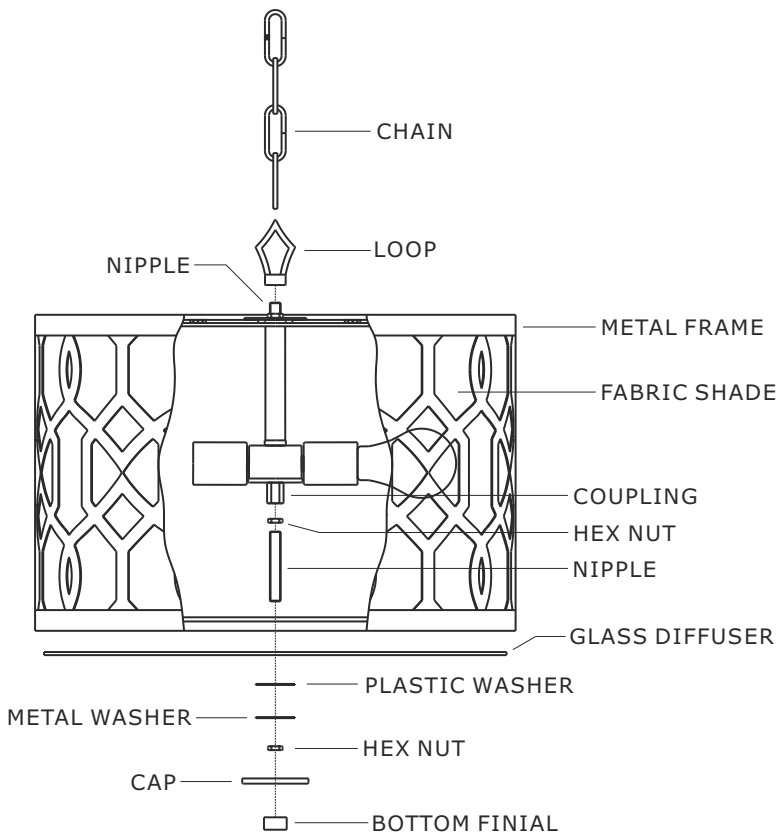

### How to install

1. Slip the loop along wire and thread onto the nipple located on the top of the metal frame.
2. Determine the preferred hanging height and adjust the chain to the length required.
3. Connect fixture wires to supply wires in outlet box.
4. Install the fixture onto the outlet box.
5. Install the bulbs(not included) into the socket.
6. Thread the nipple onto the coupling and adjust the length of nipple to fit with the glass. Tighten it with hex nut.
7. Slide the glass diffuser, the plastic washer and the metal washer over the nipple, then secure with the hex nut.
8. Slide the cap over the nipple, then secure with the bottom finial.

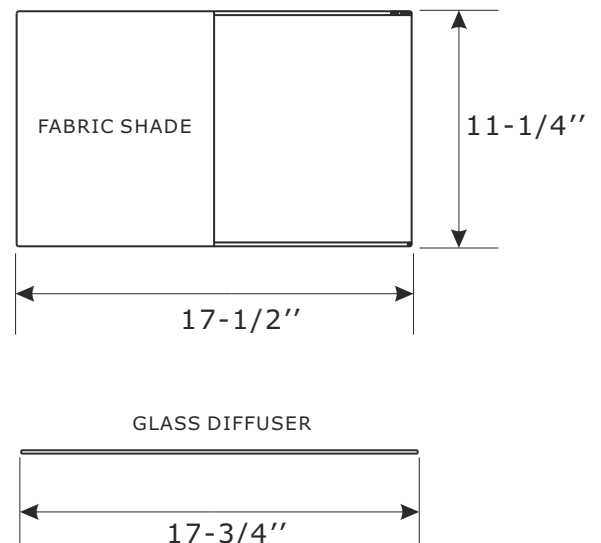
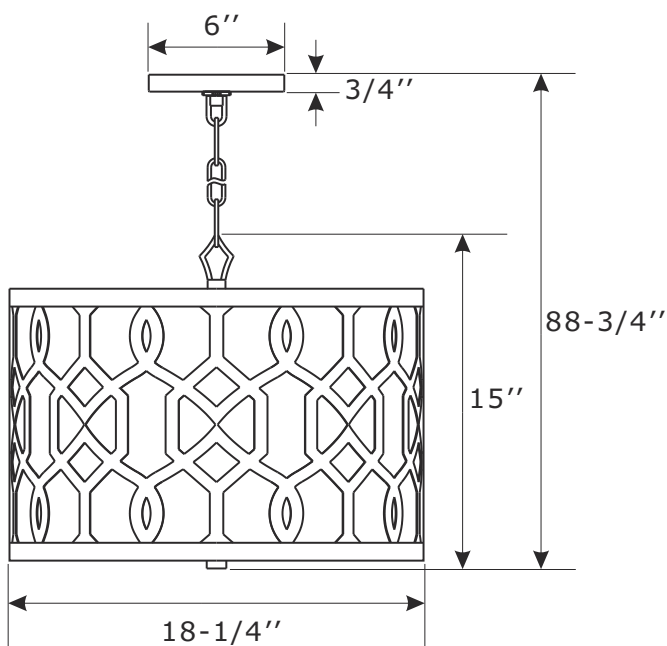

**WARNING:** This product can expose you to Lead which is known to the state of California to cause cancer and/or birth defects or reproductive harm. For more information go to [www.P65Warnings.ca.gov](http://www.P65Warnings.ca.gov)



## ASSEMBLY INSTRUCTION MODEL #2265-AG

### Part Number

#### Part Numbers

- A. (1)-Mounting hardware
- B. (1)-Canopy W6"xH3/4" #XRF2260AGCAN6IN
- C. (1)-Collar ring
- D. (1)-Collar loop #XRF2260AGLOOP
- E. (1)-Chain -72", 4mm thick #XRF2260AGCHA4.0MM
- F. (1)-Loop
- G. (1)-Metal frame
- H. (1)-Fabric shade W17-1/2"xH11-1/4" #XRF2265SHA17.5IN
- I. (2)-Hex nut
- J. (1)-Nipple
- K. (1)-Glass diffuser #XRF2265DIF17.75IN
- L. (1)-Plastic washer
- M. (1)-Metal washer
- N. (1)-Cap #XRF2263AGCAP
- O. (1)-Bottom finial #XRF2263AGFIN

