

ED4000 Series Exit Device

PRODUCT CATALOG



Experience a safer
and more open world

Introduction

TABLE OF CONTENTS

Applications.....	2
Applications and Listings.....	3
Functions.....	5
SecureBolt® Features.....	7
Rim Features.....	9
Surface Vertical Rod Features.....	11
Concealed Vertical Rod Features.....	13
Trims and Functions.....	15
Electrified Exit Devices.....	19
Mullions.....	31
Options and Accessories.....	32
Cylinders.....	34
How to Order.....	35
Quick Codes.....	37
Facts and Figures.....	39
Helpful Terms.....	40
How to Specify.....	41

APPLICATIONS

Designed for applications on narrow stile full glass, aluminum and metal doors in high-use and high-abuse situations, ED4000 Series devices can be teamed with a variety of Corbin Russwin trims to provide desired functions, styles and finishes in new construction and renovations, including:

- Schools and universities
- Health care facilities
- Government and municipal buildings
- Factories and warehouses
- Office and retail complexes
- Transportation facilities
- Hotels and conference centers
- Religious facilities
- Theaters and auditoriums

ADVANTAGES

- Meets ANSI Grade 1 requirements
- Easy-to-use pushpad for quick egress and ADA compliance
- Low projection for barrier-free code compliance
- Heavy-duty construction
- Quiet operation
- Closed on all sides – no projecting parts to inhibit egress
- Devices accommodate various function trims for flexibility
- Through-bolted trims for strength, security, durability, smooth operation and easy installation
- Wide range of designs and finishes to match other Corbin Russwin products
- One-point dogging
- Devices satisfy UL/CUL safety requirements

 **WARNING**

This product can expose you to lead which is known to the state of California to cause cancer and birth defects or other reproductive harm. For more information go to www.P65warnings.ca.gov.

Applications and Listings

Single Door	UL Listing	Maximum Opening (W x H)	Application	
Rim				
ED4200	Panic	4' x *	Surface applied; single-point latching.	
ED4200M	Panic	4' x *	Surface applied single-point latching.	
ED4200MA	3Hr.	4' x 8'	Surface applied single-point latching.	
SecureBolt®				
ED4200S	Panic	4' x *	Surface applied; single-point latching.	
ED4200SM	Panic	4' x *	Surface applied single-point latching.	
ED4200SMA	3Hr.	4' x 8'	Surface applied single-point latching.	
Surface Vertical Rod				
ED4400	Panic	4' x 10'	Surface applied; two-point latching.	
ED4400M	Panic	4' x 10'	Surface applied two-point latching.	
ED4400MA	3Hr.	4' x 10'	Surface applied two-point latching.	
Concealed Vertical Rod				
ED4800	Panic	4' x 10'	Rods concealed in door; two-point latching.	
ED4800M	Panic	4' x 10'	Rods concealed in door two-point latching.	
ED4800MA	3Hr.	4' x 10'	Rods concealed in door two-point latching.	
Pair of Doors with Removable Mullion				
Rim x Rim				
ED4200 x ED4200 x CR808	Panic	8' x 8'	Two independent active doors with removable mullion.	
ED4200M x ED4200M x CR908	Panic	8' x 8'	Two independent active doors with removable mullion.	
ED4200MA x ED4200MA x CR908A	3Hr.	8' x 8'	Two independent active doors with removable mullion.	
SecureBolt® x SecureBolt®				
ED4200S x ED4200S x CR808	Panic	8' x 8'	Two independent active doors with removable mullion.	
ED4200SM x ED4200SM x CR908	Panic	8' x 8'	Two independent active doors with removable mullion.	
ED4200SMA x ED4200SMA x CR908A	3Hr.	8' x 8'	Two independent active doors with removable mullion.	

Note: All ED4000 Series Narrow Stile Pushpad Exit Devices are UL305 panic listed.
 *UL does not set a door height limitation on panic applications.

Applications and Listings

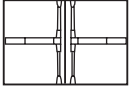
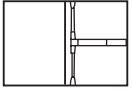
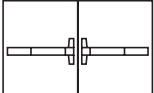
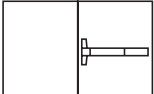
Pair of Doors	UL Listing	Maximum Opening (W x H)	Application	
Surface Vertical Rod				
ED4400 x ED4400	Panic	8' x 10'	Two independent doors with two-point latching, swinging in the same direction.	
ED4400M x ED4400M	Panic	8' x 10'	Two independent doors with two-point latching, swinging in the same direction.	
ED4400MA x ED4400MA	3Hr.	8' x 10'	Two independent doors with two-point latching, swinging in the same direction.	
Surface Vertical Rod (Double Egress)				
ED4400 x ED4400	Panic	8' x 10'	Two independent doors with two-point latching, swinging in opposite directions.	
ED4400M x ED4400M	Panic	8' x 10'	Two independent doors with two-point latching, swinging in the same direction.	
ED4400MA x ED4400MA	3Hr.	8' x 10'	Two independent doors with two-point latching, swinging in the same direction.	
Concealed Vertical Rod				
ED4800 x ED4800	Panic	8' x 10'	Two independent doors with two-point latching, swinging in the same direction.	
ED4800M x ED4800M	Panic	8' x 10'	Two independent doors with two-point latching, swinging in the same direction.	
ED4800MA x ED4800MA	3Hr.	8' x 10'	Two independent doors with two-point latching, swinging in the same direction.	
Concealed Vertical Rod (Double Egress)				
ED4800 x ED4800	Panic	8' x 10'	Two independent doors with two-point latching, swinging in the opposite direction.	
ED4800M x ED4800M	Panic	8' x 10'	Two independent doors with two-point latching, swinging in the same direction.	
ED4800MA x ED4800MA	3Hr.	8' x 10'	Two independent doors with two-point latching, swinging in the same direction.	

Note: All ED4000 Series Narrow Stile Pushpad Exit Devices are UL305 panic listed.
 *UL does not set a door height limitation on panic applications.

Functions

EXIT ONLY, PULL AND THUMBPIECE TRIMS

Rim/SecureBolt® ED4200 ED4200S Inside Outside	Surface Vertical Rod ED4400 Inside Outside	Concealed Vertical Rod ED4800 Inside Outside	Type	ANSI No.	Function Description
			Exit Only	01	Exit only; no trim.
			Dummy	02	Entrance by trim when actuating bar is locked down.
			Nightlatch	03	Entrance by trim when latchbolt is retracted by key. Key removable only when locked.
			Classroom*	05	Entrance by thumbpiece. Key locks or unlocks thumbpiece.
			Passage	15	Entrance by trim when latch is released by thumbpiece. Thumbpiece is always active, no cylinder.
			Storeroom (Thumbpiece Active)	06	Entrance by thumbpiece only when released by key. Key removable only when locked.

*Classroom function trims can be converted to Storeroom function by a simple field adjustment.

Functions

KNOB, LEVER AND THUMBTURN TRIMS

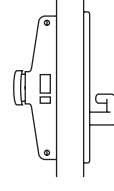
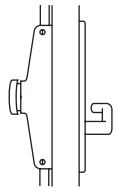
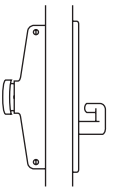
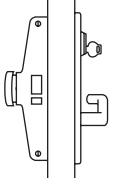
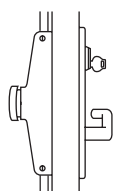
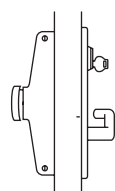
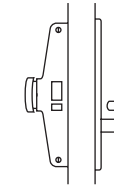
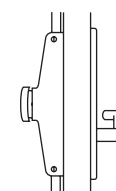
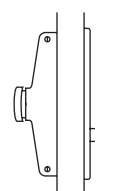
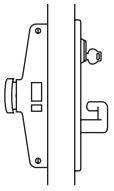
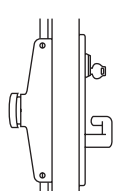
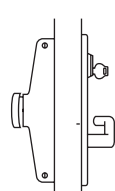
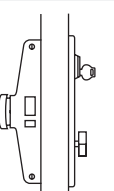
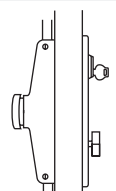
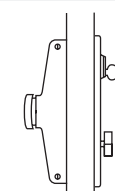
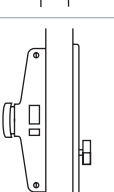
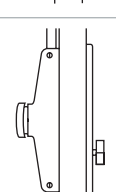
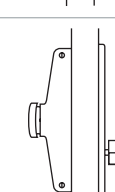
Rim/SecureBolt® ED4200 ED4200S Inside Outside	Surface Vertical Rod ED4400 Inside Outside	Concealed Vertical Rod ED4800 Inside Outside	Type	ANSI No.	Function Description
			Dummy	02	Entrance by trim when actuating bar is locked down.
			Classroom*	08	Entrance by knob or lever. Key locks or unlocks knob or lever.
			Passage	14	Entrance by trim when latchbolt is released by knob or lever. Knob or lever always active, no cylinder.
			Storeroom (Grip Active)	09	Entrance by knob or lever only when released by key. Key removable only when locked.
			Classroom*	11	Entrance by control turn piece. Key locks or unlocks control.
			Passage	16	Latchbolt retracted by thumbturn.

*Classroom function trims can be converted to Storeroom function by a simple field adjustment.

SecureBolt® Features



ED4200S NARROW STILE SECUREBOLT® EXIT DEVICE

Handing

- Device non-handed.
- Trim handed.

Bar Length

- Easily field cut to size.
- Standard: 36" (914mm) bar fits 30" - 36" (762mm-914mm) door.
- Optional: 24" (610mm) bar fits 24" (610mm) door; specify W024.
- Optional: 48" (1219mm) bar fits 36" - 48" (914mm-1219mm) door; specify W048.

Door Thickness

- 1-3/4" (44mm) standard.
- Optional: 2" (51mm); specify D200.
- Optional: 2-1/4" (57mm); specify D214.

Stile

- Minimum width 2" (51mm).

Deadbolt

- Full 3/4" (19mm) projection, 1" (25mm) wide, positive deadlocking by auxiliary bolt.

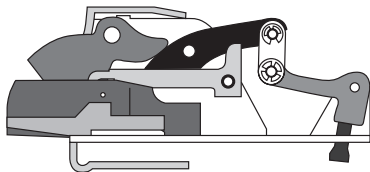

Cutaway Side View

Materials

- High-grade, heat-treated, corrosion-resistant nickel steel alloy. Finished parts are brass, bronze or stainless steel; stainless steel springs; nylon bearings.

Latchbolt

- Stainless steel. Slide action deadbolt with positive deadlocking by auxiliary bolt. Two-piece deadbolt mechanism utilizing a roll-back lever which eliminates any contact (friction) with the strike during relocking.

Projection

- 3-1/4" (83mm) active, 2-3/4" (70mm) dogged.

Dogging

- Standard: single-point 1/4 turn hex key dogging.
- Optional: less dogging; specify M51.
- Optional: cylinder dogging; specify M52.

Fasteners

- Standard: machine screws.
- Optional: sex nuts and bolts; specify M54.

Strike

- Surface mounted 3/8" (10mm) diameter roller strike, complete with positive locking plate and shims, ensuring low-friction relocking for a long, trouble-free life.

Functions and Trims

- Through-bolted lever, knob, pull, thumbturn and thumbpiece trims available with wide range of functions; see Trims and Functions, page 14.

Cylinders

- Cylinder not included unless specified. See Quick Codes, page 37.

Removable Mullion

- See Mullions, page 31.

Shim Kit

- Optional for mounting device over raised vision light molding; specify M58.

Applications and Listings

- See page 3.

Warranty

- Five-year limited.

CERTIFICATION/COMPLIANCE

ANSI

- Meets A156.3, Type 4 or 28, Grade 1.
- Meets A117.1 Accessibility Code.

UL/cUL

- All devices listed for safety as panic hardware; devices comply with UL 305 standards for panic hardware. UL symbol on active case cover indicates listing.

California State Reference Code

- This product has been approved by the California State Fire Marshal pursuant to section 13144.1 of the California Health and Safety Code.

NFPA

- All exit devices comply with NFPA 101 Life Safety Code.

ADA

- Exit devices, lever trims and pulls comply with Americans with Disabilities Act.

FINISHES

BHMA 605	Bright Brass
BHMA 606	Satin Brass
BHMA 611	Bright Bronze
BHMA 612	Satin Bronze
BHMA 613	Oxidized Bronze, oil rubbed, available lacquered
BHMA 613E	Dark Oxidized Satin Bronze Equivalent
BHMA 618	Bright Nickel Plated
BHMA 619	Satin Nickel Plated
BHMA 625	Bright Chromium Plated
BHMA 626 ¹ (Trim Only)	Satin Chromium Plated
626C ²	Satin Chromium Plated with MicroShield®
BHMA 629	Bright Stainless Steel
BHMA 630	Satin Stainless Steel
630C ²	Satin Stainless Steel with MicroShield®
722	Black oxidized bronze, oil rubbed
BSP	Black Suede Powder Coat
WSP	White Suede Powder Coat

1. Contact factory for devices required in BHMA 626.

2. Finish available with MicroShield® antimicrobial coating.

SecureBolt® Features

ED4200S SECUREBOLT® EXIT DEVICE

3/4" (19mm) projection x 1" wide deadbolt-style latchbolt with positive deadlocking by auxiliary bolt

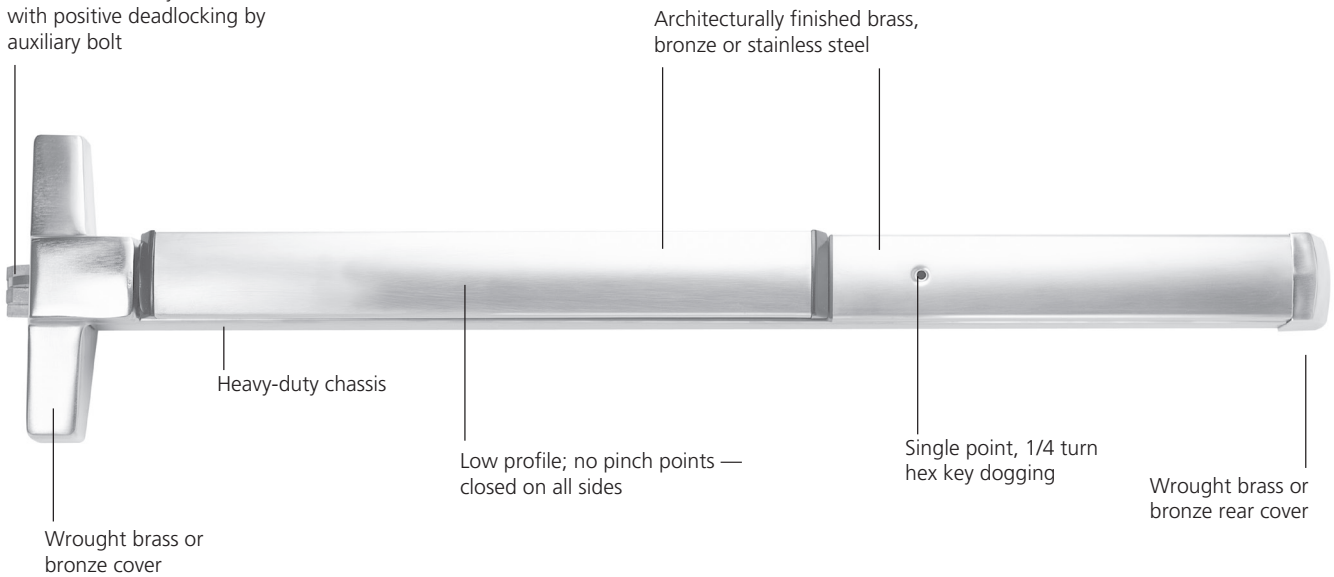

Vector Forces

In terms of an exit device, vector forces mean that pressure applied to the door results in a force against the stop and the frame, resulting in door/frame separation. The standard pullman latchbolt applies 280 pounds of force against the frame from a 400-pound pull on the door.

The SecureBolt® exit device only applies 63 pounds of force against the frame from a 400-pound pull on the door. Less force means the door and frame do not separate, providing a higher level of security, as the door cannot be pulled open.

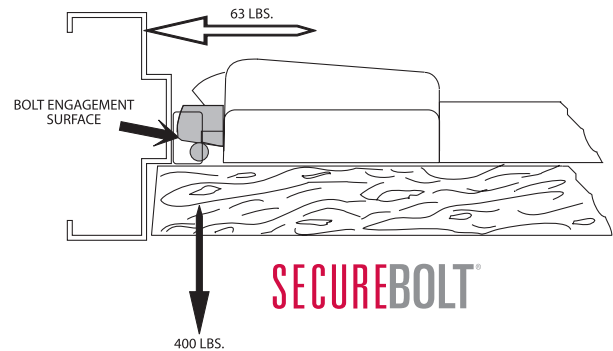
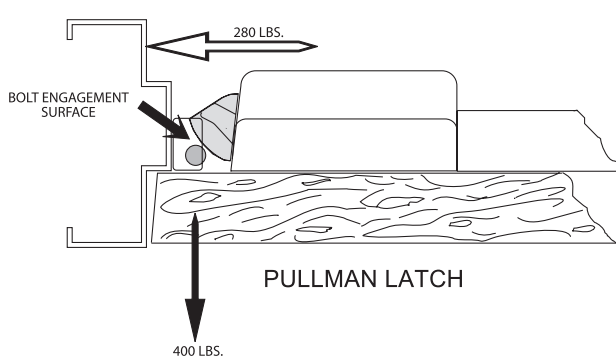

Rim Features



ED4200 NARROW STILE RIM EXIT DEVICE

FEATURES

Handing

- Device non-handed.
- Trim handed.

Bar Length

- Easily field cut to size.
- Standard: 36" (914mm) bar fits 30" - 36" (762mm-914mm) door.
- Optional: 24" (610mm) bar fits 24" (610mm) door; specify W024.
- Optional: 48" (1219mm) bar fits 36" - 48" (914mm-1219mm) door; specify W048.

Door Thickness

- 1-3/4" (44mm) standard.
- Optional: 2" (51mm); specify D200.
- Optional: 2-1/4" (57mm); specify D214.

Stile

- Minimum width 2" (51mm).

Latchbolt

- 3/4" (19mm) throw, pullman type with stainless steel deadlocking latch.

Materials

- Heavy-duty cold-forged steel chassis; heavy-gauge steel mechanisms, electroplated for corrosion resistance; finished parts are brass, bronze or stainless steel; stainless steel springs; nylon bearings.

Projection

- 3-1/4" (83mm) active, 2-3/4" (70mm) dogged.

Dogging

- Standard: single point 1/4 turn hex key dogging.
- Optional: less dogging; specify M51.
- Optional: cylinder dogging; specify M52.

Fasteners

- Standard: machine screws.
- Optional: sex nuts and bolts; specify M54.

Strike

- Surface mounted 3/8" (10mm) diameter roller strike, complete with positive locking plate and shims.

Functions and Trims

- Through-bolted lever, knob, pull, thumbturn and thumbpiece trims available with wide range of functions; see Trims and Functions, page 14.

Cylinders

- Cylinder not included unless specified. See Quick Codes, page 37.

Removable Mullion

- See Mullions, page 31.

Shim Kit

- Optional for mounting device over raised vision light molding; specify M58.

Applications and Listings

- See page 3.

Warranty

- Five-year limited.

CERTIFICATION/COMPLIANCE

ANSI

- Meets A156.3, Type 4, Grade 1.
- Meets A117.1 Accessibility Code.

UL/cUL

- All devices listed for safety as panic hardware; devices comply with UL 305 standards for panic hardware. UL symbol on active case cover indicates listing.

California State Reference Code

- This product has been approved by the California State Fire Marshal pursuant to section 13144.1 of the California Health and Safety Code.

NFPA

- All exit devices comply with NFPA 101 Life Safety Code.

ADA

- Exit devices, lever trims and pulls comply with Americans with Disabilities Act.

ED4200M & ED4200MA

- The ED4200M and ED4200MA rim exit device provides the appearance of a narrow stile rim exit device for use on wide stile or flush doors. Using the ED4200M or ED4200MA with narrow stile trim provides design continuity and pleasing aesthetics when matching exit devices for inside doors to outside narrow stile doors.

FINISHES

BHMA 605	Bright Brass
BHMA 606	Satin Brass
BHMA 611	Bright Bronze
BHMA 612	Satin Bronze
BHMA 613	Oxidized Bronze, oil rubbed, available lacquered
BHMA 613E	Dark Oxidized Satin Bronze Equivalent
BHMA 618	Bright Nickel Plated
BHMA 619	Satin Nickel Plated
BHMA 625	Bright Chromium Plated
BHMA 626* (Trim Only)	Satin Chromium Plated
626C	Satin Chromium Plated with MicroShield®
BHMA 629	Bright Stainless Steel
BHMA 630	Satin Stainless Steel
630C	Satin Stainless Steel with MicroShield®
722	Black oxidized bronze, oil rubbed
BSP	Black Suede Powder Coat
WSP	White Suede Powder Coat

***Contact factory for devices required in BHMA 626**

Rim Features

ED4200 NARROW STILE RIM EXIT DEVICE

3/4" (19mm) throw pullman type
latchbolt with auxiliary deadlocking
latch standard

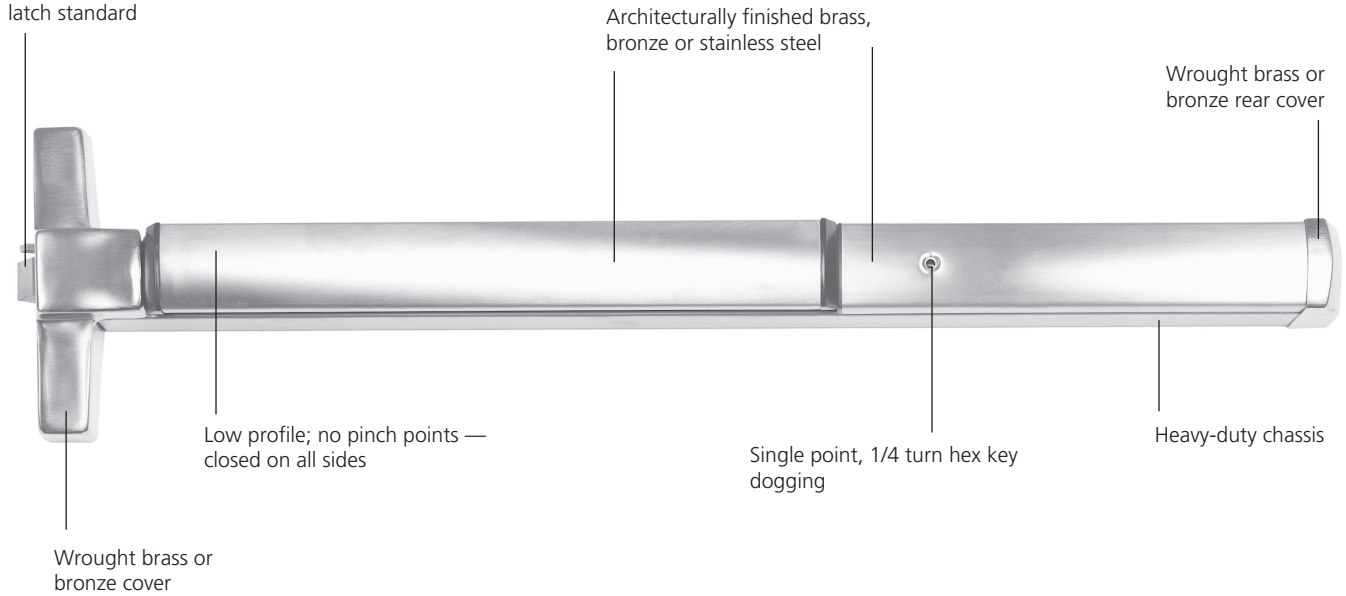

Surface Vertical Rod Features

ED4400 NARROW STILE SURFACE VERTICAL ROD EXIT DEVICE

FEATURES

Handing

- Device is handed but easily field reversible.
- Trim handed.

Bar Length

- Easily field cut to size.
- Standard: 36" (914mm) bar fits 30" - 36" (762mm-914mm) door.
- Optional: 24" (610mm) bar fits 24" (610mm) door; specify W024.
- Optional: 48" (1219mm) bar fits 36" - 48" (914mm-1219mm) door; specify W048.

Door Thickness

- 1-3/4" (44mm) standard.
- Optional: 2" (51mm); specify D200.
- Optional: 2-1/4" (57mm); specify D214.

Stile

- Minimum width 2" (51mm).

Door Height

- Standard: Top rod for 7' door.
- All top rods easily field cut to size.
- Optional door heights available; see Quick Codes, page 37.

Latchbolt

- Top: 3/4" (19mm) throw, pullman type with automatic deadlatching.
- Bottom: 5/8" (16mm) throw deadbolt, held retracted during door swing.

Vertical Rods

- 1/2" O.D. tubular brass, bronze or stainless steel with rod guides.

Materials

- Heavy-duty cold-forged steel chassis; heavy-gauge steel mechanisms, electroplated for corrosion resistance; finished parts are brass, bronze or stainless steel; stainless steel springs; nylon bearings.

Projection

- 3-1/4" (83mm) active, 2-3/4" (70mm) dogged.

Dogging

- Standard: single point 1/4 turn hex key dogging.
- Optional: less dogging; specify M51.
- Optional: cylinder dogging; specify M52.

Fasteners

- Standard: machine screws.
- Optional: sex nuts and bolts; specify M54.

Strike

- Top: Adjustable roller strike with positive locking plate and shims.
- Bottom: flush mounted.
- Optional strikes available; see Options and Accessories, page 33.

Functions and Trims

- Through-bolted lever, knob, pull, thumbturn and thumbpiece trims available with wide range of functions; see Trims and Functions, page 14.

Cylinders

- Cylinder not included unless specified. See Quick Codes, page 37.

Shim Kit

- Optional for mounting device over raised vision light moding; specify M58.

Applications and Listings

- See page 3.

Warranty

- Five-year limited.

CERTIFICATION/COMPLIANCE

ANSI

- Meets A156.3, Type 5, Grade 1.

UL/cUL

- All devices listed for safety as panic hardware; devices comply with UL 305 standards for panic hardware. UL symbol on active case cover indicates listing.

California State Reference Code

- This product has been approved by the California State Fire Marshal pursuant to section 13144.1 of the California Health and Safety Code.



NFPA

- All exit devices comply with NFPA 101 Life Safety Code.

ADA

- Lever trims and pulls comply with Americans with Disabilities Act.

FINISHES

BHMA 605	Bright Brass
BHMA 606	Satin Brass
BHMA 611	Bright Bronze
BHMA 612	Satin Bronze
BHMA 613	Oxidized Bronze, oil rubbed, available lacquered
BHMA 613E	Dark Oxidized Satin Bronze Equivalent
BHMA 618	Bright Nickel Plated
BHMA 619	Satin Nickel Plated
BHMA 625	Bright Chromium Plated
BHMA 626* (Trim only)	Satin Chromium Plated
626C	Satin Chromium Plated with MicroShield® 
BHMA 629	Bright Stainless Steel
BHMA 630	Satin Stainless Steel
630C	Satin Stainless Steel with MicroShield® 
722	Black oxidized bronze, oil rubbed
BSP	Black Suede Powder Coat
WSP	White Suede Powder Coat

***Contact factory for devices required in BHMA 626**

Surface Vertical Rod Features

ED4000 SURFACE VERTICAL ROD EXIT DEVICE

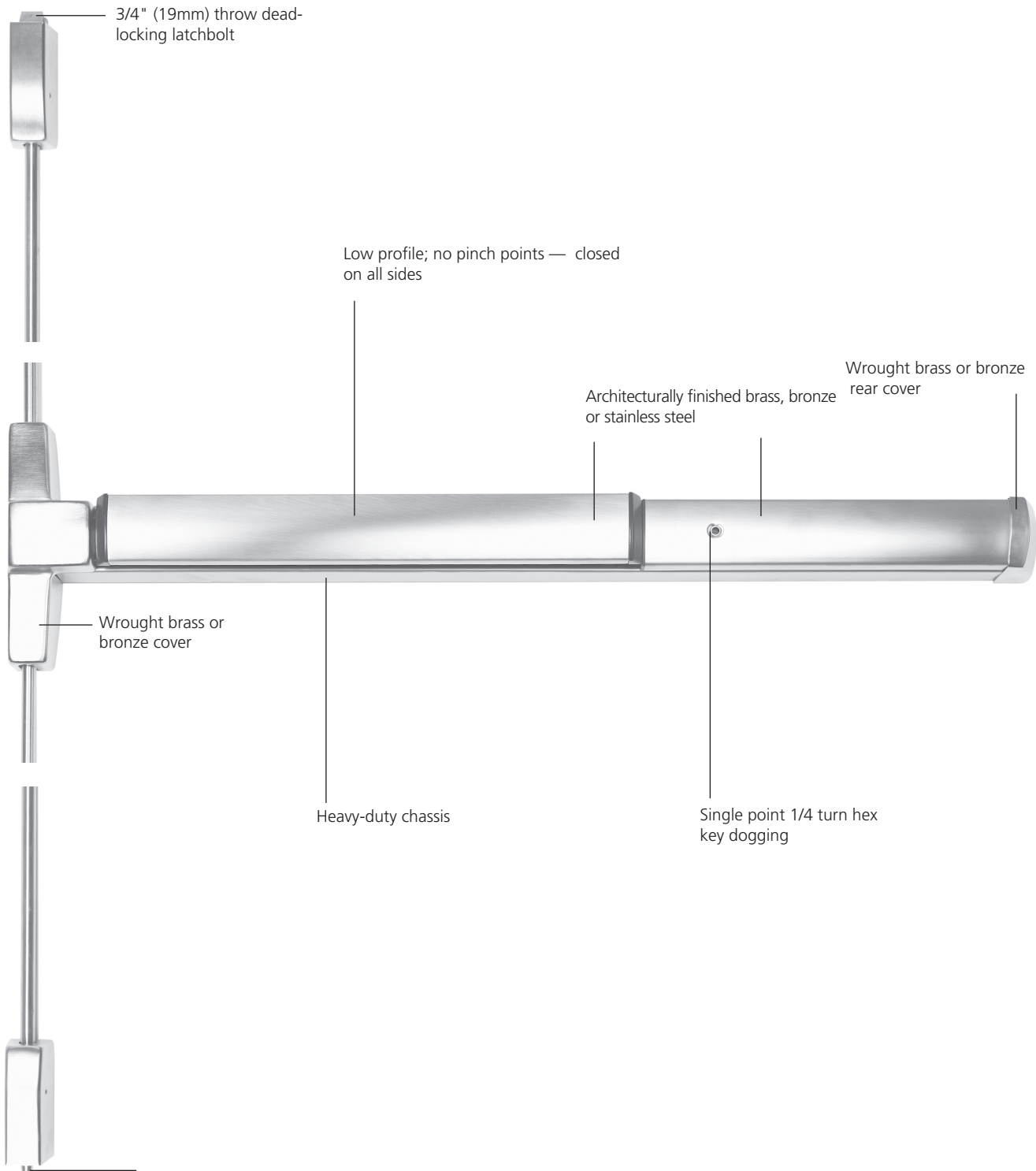

Concealed Vertical Rod Features



ED4800 NARROW STILE CONCEALED VERTICAL ROD EXIT DEVICE FOR USE WITH METAL DOORS ONLY

FEATURES

Handing

- Device handed but easily field reversible.
- Lever trim handed.

Bar Length

- Easily field cut to size.
- Standard: 36" (914mm) bar fits 30"-36" (762mm-914mm) door.
- Optional: 24" (610mm) bar fits 24" (610mm) door; specify W024.
- Optional: 48" (1219mm) bar fits 36"-48" (914mm-1219mm) door; specify W048.

Door Thickness

- 1-3/4" (44mm) standard.
- Optional: 2" (51mm); specify D200.
- Optional: 2-1/4" (57mm); specify D214.

Stile

- Minimum width 2" (51mm).

Door Height

- Standard: Top rod adjustable for 7'-8" door.
- Telescoping rod assembly to accommodate various door heights.
- Optional door heights available; see Quick Codes, page 37.

Latchbolt

- Top: 3/4" (19mm) throw, pullman type with automatic deadlatching.
- Bottom: 5/8" (16mm) throw deadbolt, held retracted during door swing.

Vertical Rods

- 1/2" O.D. tubing, electroplated for corrosion resistance.

Materials

- Heavy-duty cold-forged steel chassis; heavy-gauge steel mechanisms, electroplated for corrosion resistance; finished parts are brass, bronze or stainless steel; stainless steel springs; nylon bearings.

Projection

- 3-1/4" (83mm) active, 2-3/4" (70mm) dogged.

Dogging

- Standard: single point 1/4 turn hex key dogging.
- Optional: less dogging; specify M51.
- Optional: cylinder dogging; specify M52.

Fasteners

- Standard: machine screws.
- Optional: sex nuts and bolts; specify M54.

Strike

- Top: adjustable roller strike with positive locking plate and shims.
- Bottom: flush mounted.
- Optional strikes available; see Options and Accessories, page 33.

Functions and Trims

- Through-bolted lever, knob, pull, thumbturn and thumbpiece trims available with wide range of functions; see Trims and Functions, page 14.

Cylinders

- Cylinder not included unless specified. See Quick Codes, page 37.

Shim Kit

- Optional for mounting device over raised vision light moding; specify M58.

Applications and Listings

- See page 3.

Warranty

- Five-year limited.

CERTIFICATION/COMPLIANCE

ANSI

- Meets A156.3, Type 6, Grade 1.
- Meets A117.1 Accessibility Code.

UL/cUL

- All devices listed for safety as panic hardware; devices comply with UL 305.
- UL symbol on active case cover indicates listing.

California State Reference Code

- This product has been approved by the California State Fire Marshal pursuant to section 13144.1 of the California Health and Safety Code.



NFPA

- All exit devices comply with NFPA 101 Life Safety Code.

ADA

- Exit devices, lever trims and pulls comply with Americans with Disabilities Act.

FINISHES

BHMA 605	Bright Brass
BHMA 606	Satin Brass
BHMA 611	Bright Bronze
BHMA 612	Satin Bronze
BHMA 613	Oxidized Bronze, oil rubbed, available lacquered
BHMA 613E	Dark Oxidized Satin Bronze Equivalent
BHMA 618	Bright Nickel Plated
BHMA 619	Satin Nickel Plated
BHMA 625	Bright Chromium Plated
BHMA 626* (Trim only)	Satin Chromium Plated
626C	Satin Chromium Plated with MicroShield® 
BHMA 629	Bright Stainless Steel
BHMA 630	Satin Stainless Steel
630C	Satin Stainless Steel with MicroShield® 
722	Black oxidized bronze, oil rubbed
BSP	Black Suede Powder Coat
WSP	White Suede Powder Coat

*Contact factory for devices required in BHMA 626

Concealed Vertical Rod Features



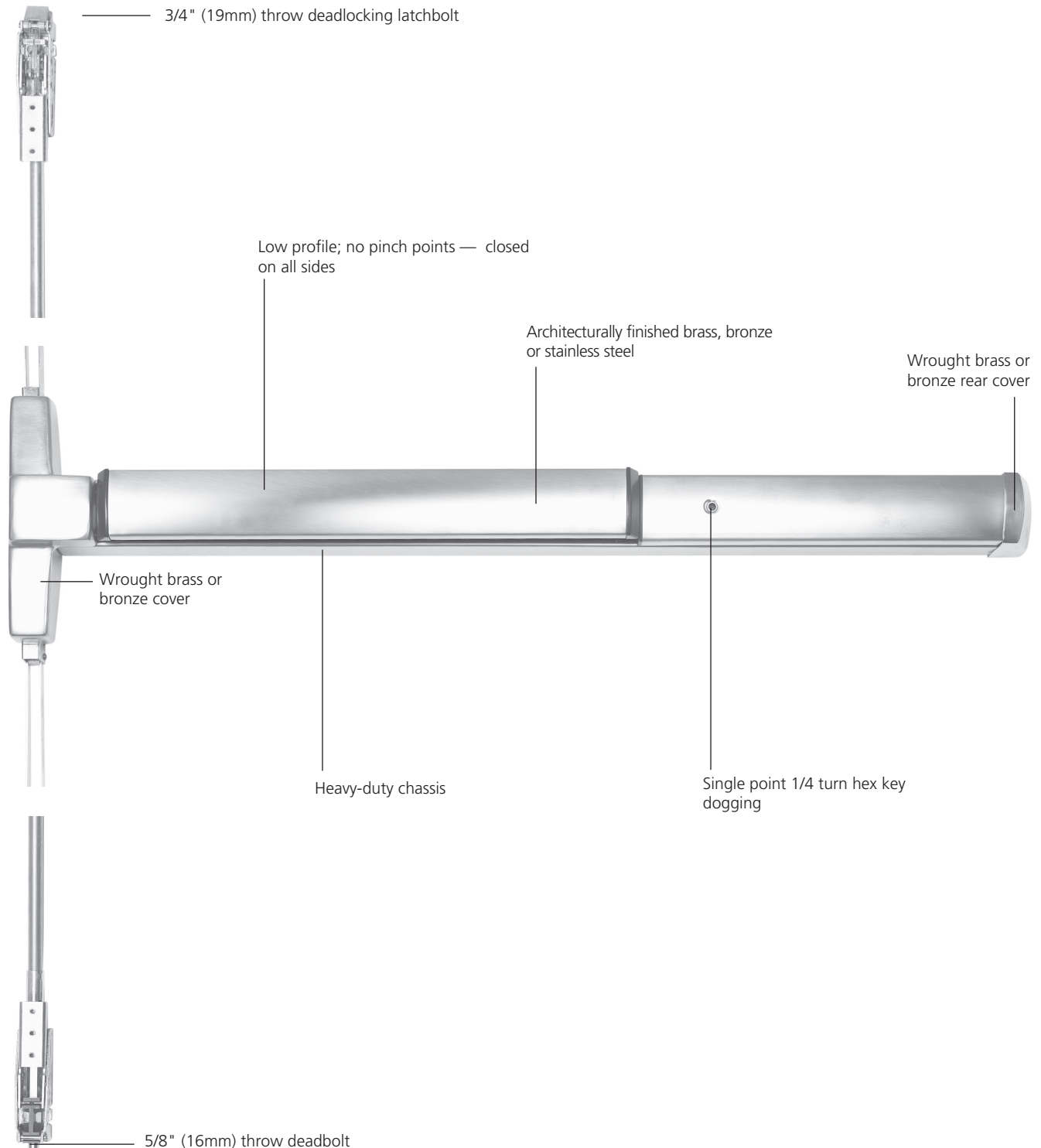









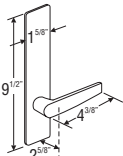

ED4800 CONCEALED VERTICAL ROD PANIC EXIT DEVICE FOR USE WITH METAL DOORS ONLY

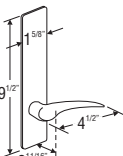

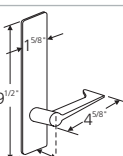
Trims and Functions

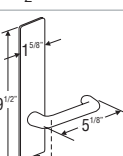
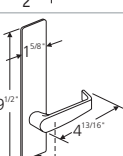
FEATURES:

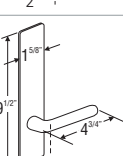

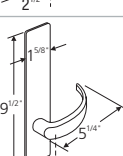







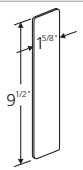

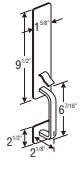
- Fourteen architectural finishes
- Lever designs allow for design continuum with Corbin Russwin line
- 1-year limited warranty

Trim Designs			Passage ANSI No. 14	Dummy ANSI No. 02	Classroom* ANSI No. 08	Storeroom ANSI No. 09
	Armstrong A8 Lever: Cast Escutcheon: Wrought Cylinder: Rim	 	A810ET	A850ET	A855ET	A859ET
	Citation C8 Lever: Cast Escutcheon: Wrought Cylinder: Rim	 	C810ET	C850ET	C855ET	C859ET
	Dirke D8 Lever: Cast Escutcheon: Wrought Cylinder: Rim	 	D810ET	D850ET	D855ET	D859ET
	Essex E8 Lever: Cast Escutcheon: Wrought Cylinder: Rim	 	E810ET	E850ET	E855ET	E859ET
	Lustra L8 Lever: Cast Escutcheon: Wrought Cylinder: Rim	 	L810ET	L850ET	L855ET	L859ET
	Newport N8 Lever: Cast Escutcheon: Wrought Cylinder: Rim	 	N810ET	N850ET	N855ET	N859ET
	Regis R8 Lever: Cast Escutcheon: Wrought Cylinder: Rim	 	R810ET	R850ET	R855ET	R859ET
	Princeton PR8 Lever: Cast Escutcheon: Wrought Cylinder: Rim	 	PR810ET	PR850ET	PR855ET	PR859ET

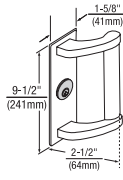
Trims and Functions

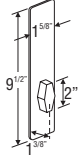
FEATURES:

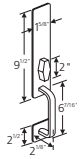
- Fourteen architectural finishes
- Lever designs allow for design continuum with Corbin Russwin line
- 1-year limited warranty

Trim Designs	Passage ANSI No. 14/15/16	Dummy ANSI No. 02	Classroom ANSI No. 05/08/11	Storeroom/ Nightlatch ANSI No. 03/06/09/12
 <p>Plate F4 Plate: Wrought Cylinder: Rim</p> 	N/A	F450ET ²	N/A	F457ET ² (03)
 <p>Pull/Thumbpiece T14 Pull: Cast Escutcheon: Wrought Cylinder: Rim</p> 	T1410ET (15)	 T1450ET ^{1,2}	T1455ET (05)	 T1457ET ^{1,2} (06)
 <p>Pull P10 Pull: Extruded Escutcheon: Wrought Cylinder: Rim</p>  	N/A	P1050ET ²	N/A	P1057ET ² (03)
 <p>Plate x Thumbturn O8 Plate: Wrought Thumbturn: Cast Cylinder: Rim</p> 	O810ET (16)	N/A	O855ET (11)	O859ET (12)
 <p>Pull x Thumbturn O14 Pull: Cast Thumbturn: Cast Cylinder: Rim</p> 	O1410ET (16)	N/A	O1455ET (11)	O1459ET (12)
 <p>Key Only K1 Note: Available with cylinder option only. Ex: K157 x 6P</p> 	N/A	N/A	N/A	K157ET ^{2,3} (03)

Note: Classroom function trims can be converted to Storeroom function by a simple field adjustment.

1. Pull only, no thumbpiece.
2. Not recommended for use with surface or concealed vertical rod exit devices.
3. Not available in 625 or 626 finish. Supplied in 629 or 630 respectively.

Utility Trims and Functions

Offset Pull Trim: P12, P13, P14*



**Offset Pull
P12**
Clearance: 2-1/2"

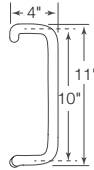

Specify Part Number, 716F50M x Finish¹



**Offset Pull
P13**
Clearance: 2-1/2"



Specify Part Number, 716F51M x Finish¹





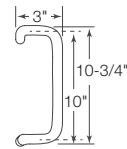











































**Offset Pull
P14**
Clearance: 2-1/2"



Specify Part Number, 716F52M x Finish¹

1. Available in 605, 606, 612, 613, 626, 629 and 630 finishes.
*Available on 1-3/4" thick doors only.

Trims and Functions

Lever Designs (Choose from list below)	Function					How to Order Example: Trim x Function # 102910	
	Passage ANSI No. 14 Function #810	Dummy ANSI No. 02 Function #850	Classroom ANSI No. 08 Function #855	Nightlatch ANSI No. 03 Function #859			
Muséo®							
Georgia							
	102	103	104 ⁴	124 ²	125 ²		
Salvador							
	106	107	108	109	110	123 ²	128 ²
Marc							
	111 ⁴	112 ⁴	114 ⁴	115 ⁴	116 ⁴	131 ^{2,4}	151
Jackson							
	105 ⁴	117 ⁴	119 ⁴	121 ⁴	122 ⁴	126 ^{2,4}	152
Piet*							
	21G	21L	21M	21S	23M	25M	27M
Joseph³							
	133	134 ²	135	136	137 ²	138 ²	
Georges							
	139	140	143				
Laszlo							
	147	148 ²	149	150			

*See pages 35 for how to order the Muséo® Piet Lever Collection.
 1. Classroom function trims can be converted to Storeroom function by a simple field adjustment.
 2. Complies with codes requiring lever to return to within 1/2" (13mm) of door face.
 3. 135-138 contain white or back polycarbonate insert
 4. Not available in 32D or 32 finish

Electrified Exit Devices

ELECTRIFIED EXIT DEVICES

The Corbin Russwin ED4000 series electrified exit devices offer a complete range of options that may be integrated into the monitoring security and alarm systems of most buildings. The continuum of appearance is maintained, as well as the security and function of the ED4000 series mechanical exit device.



List No.	Exit Device Description	Available Options					
		M61	M91	M92	M93	D	MELR
ED4200	Rim Exit Device	x	x	x	x	x	x
ED4200S	Rim SecureBolt® Device	x	x	x	x	x	x
ED4400	Surface Vertical Rod	x	x	x	x	x	x
ED4800	Concealed Vertical Rod	x	x	x	x	x	x

Electrified Hardware Option Descriptions

M61	Alarm Option
M91	Bolt Monitor
M92	Touchbar Monitor
M93	Trim Monitor
D	Delayed Egress
MELR	Motorized Electric Latch Retraction

* Add as suffix to exit device.
Example: ED5400D x 630 x RHR

Notes:

- The following options cannot be ordered together on the same device:

D x M52	M52 x M61
D x M61	M61 x M92
D x M92	ED4400 x M61 with Monitors M91, M92 or M93
D x MELR	MELR x M61
D x MELR	
- When ordering a Surface Vertical Rod exit device with the D option (ED4400D), rod and latch guards (provided by others) must be used.

Electrified Exit Devices

ELECTRIC LATCH RETRACTION - MELR

The Motorized Electric Latch Retraction (MELR) exit device provides remote-controlled latch retraction that delivers quiet, smooth operation for convenient, hassle-free egress. Easily installed in new applications and available as retrofit rail kit assemblies for field updates, the MELR features maintenance-free design with few moving parts using 86% less power consumption during retraction than solenoid devices. Plus, MELR is powered by a standard power supply, simplifying installation and increasing system design flexibility.

Application

SecureBolt® Exit Devices
 Rim Exit Devices
 Surface Vertical Rod Exit Devices
 Concealed Vertical Rod Exit Devices
 Mortise Exit Devices

Listings

UL listed for both Panic and Fire Exit Hardware.

Bar Length

Easily field cut to size.

Standard: 36" (914mm)* bar fits 34"-36" (762mm-914mm) door.

*Bar fits 34"-36" when equipped with MELR Option.

Optional: 48" (1219mm)* bar fits 36"-48" (914mm-1219mm) door; specify W048.

*bar fits 39"-48" when equipped with MELR Option

Electrical Specifications

24VDC (LSP-12-24) regulated/filtered power supply. Requires 1A per device

Motor Driven Latch Retraction

.65 amp max during retraction
 .2 amp holding-continuous duty

Device bolts remain retracted for as long as the device is energized.

Removal of power returns the device to the life safety, self-latching mechanical mode.

Interface with central or local fire alarm system, automatic door operators, access control systems, security alarm systems, and blow open door systems.

Amount of rail retraction is automatically controlled by controller PC board; system actively monitors position and speed and adjusts itself.

Timer

Digital retraction timer (0-20 seconds) or set to power mode for access control systems.

Hinges

Standard electric hinge. No special power transfer required.

Note: This feature is not available with delayed egress (D) on the same device.

Warranty

5 years

How to Order

Specify Quick Code MELR.



MELR Retrofit Device Assembly

Existing solenoid and mechanical exit devices can be retrofit to motorized electric latch retraction (MELR) by purchasing retrofit kits via the following associated part numbers.

List Number	Product Description	Available Options			
		None	M93	M107	M107 & M93
CRMELR-36	ED5000 36" MELR DEVICE ASSY	X	X	X	X
CRMELR-48	ED5000 48" MELR DEVICE ASSY	X	X	X	X

Note:

- For devices that use the M91 option, simply connect the wire from the existing switch to the new rail.
- For devices that use the M92 option, the existing switch needs to be moved and wired to the new rail.
- For a list of replacement parts for existing motorized electric latch retraction devices, contact Technical Product Support at 888-607-5703.
- Recommend LSP-12-24

LATCHHEAD ASSEMBLIES REQUIREMENTS

The MELR retrofit device assemblies can only be added to ED4000 Series exit devices manufactured after April 2015.

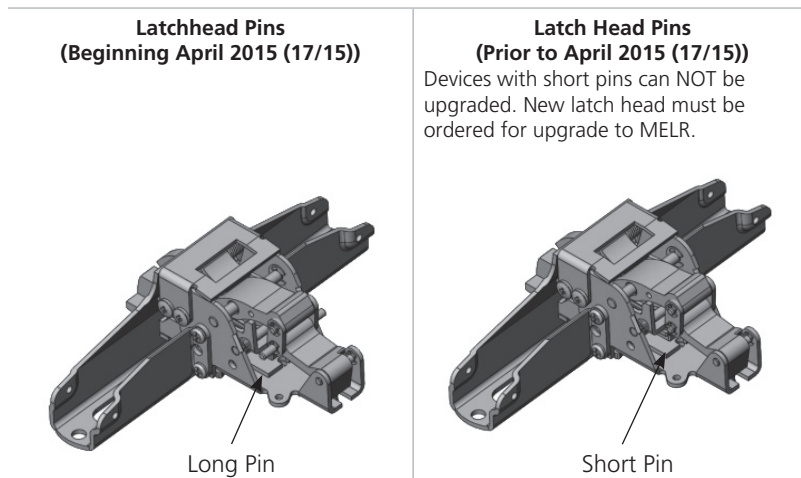

Note: Label with date code is located on front face of latch head.

Electrified Exit Devices

Delayed Egress Exit Device - D

The delayed egress option provides additional security and safety in a strong line of panic hardware. The delayed egress exit device is an electromechanical device used to secure interior or exterior openings. The option is available for rim, SecureBolt® and concealed vertical rod devices in all standard finishes.

Operation

The exit door is normally closed and latched. The Delayed Egress Exit Device "D" secures the door in the locked mode with the solid Red LED indicating locked mode status. Depressing the push pad for less than 3 seconds will sound the nuisance beep without initiating the alarm. Depressing the pushpad for 3 seconds or longer will initiate an irreversible local audible beeping tone and a visual amber indicator until the device releases. The person depressing the exit bar is denied egress for 15 or 30 seconds and security personnel are alerted. After the delay time of 15 or 30 seconds the device releases, the LED changes to Green, and the alarm changes to a steady tone which continues to alarm until manually reset by key. The remote monitoring contact outputs can be used to alert security personnel.

Note: The 15-second time delay is standard. 30-second time delay is optional (may be accepted by local jurisdiction).

Applications

- For use on hollow metal interior or exterior doors.
- Complies with NFPA 101 "Code For Safety To Life From Buildings And Structures" by National Fire Protection Association.
- BOCA options available to comply with National Building Code requirements. BOCA option is not suitable for installations in accordance with NFPA 101.
- 1-3/4" door thickness standard; 2" and 2-1/4" optional; specify D200 or D214 when ordering.
- Standard 36" device fits 36" doors only. Device cannot be cut less than 36".
- Option W048 fits doors 41" – 48". Devices cannot be cut less than 41".

Listing

- UL/CUL Listed
 - Controlled Exit Panic Devices (FULA FULA7)



– Special Locking Arrangements (FWAX/ FWAX7)

- BHMA (ANSI A156.3 and ANSI A156.24) Directory of Certified Exit Devices

Specifications

Input Voltage: 24VDC (+/- 10%)
Regulated and filtered.

Power Consumption

- Standard Device: 500 mA

Standard Features

Key Switch Operation:

- Normal: The system is armed by applying power to the device (solid Red LED). Depressing the pushpad for more than the nuisance delay time starts the exit delay cycle.
- Bypass: Turning the key switch clockwise to the bypass position allows immediate egress without alarming. The bar functions as a standard exit device. (Red LED flashes slow.)
- Reset/Delay: Used to reset device after the factory set 15 or optional 30-second delay cycle has timed out. If the device is armed, turning the key switch counterclockwise to the reset mode will release the device without alarm for egress and will rearm after 5, 10 (default), 20 or 40 seconds. (Red LED flashes quickly.)

Local Visual Status Indicator:

- RED: The exit device is secure and the delayed egress circuitry is energized.
- AMBER: The egress cycle has started, indicated by an irreversible local audible beeping tone.
- GREEN: Exit device is in alarm and has released.

Nuisance Delay Time:

With 3 second (default) setting depressing the push bar for less than 3 seconds sounds an audible beep without activating the irreversible alarm sequence. (Nuisance Delay Times are dip switch selectable to Immediate, 1, 2, or 3 (default) seconds on the control board).

Internal Alarm Siren:

When the exit device is armed, depressing the push pad initiates the internal 85db alarm siren.

Door Position Switch (DPS) Control

Board input: Allows external DPS wiring to control board for higher security. Alarm sounds when the DPS contacts open when the door is forced open.

Remote Control Inputs:

- Remote Reset: Accepts a momentary contact (keyswitch, pushbutton, etc.) to reset the unit during alarm or allows momentary egress selectable 5, 10 (default), 20 or 40 seconds when the unit is armed.
- Remote Bypass: Accepts a momentary contact to put the unit in a maintained bypass operation. The exit device functions as a standard device.

Alarm Outputs:

Contacts change only during alarm status. Alarm Relay Output contacts change state when device delay cycle has started (Alarm). Contacts are selectable for Normally Open (N.O.) or Normally Closed (N.C.) using the 2-pin jumper on the control board. N.O. is default setting. One set of contacts changes when device has released (Secure). Secure Relay Output has two sets of contacts (N.O. and N.C.). The Alarm Relay and Secure Relay contacts are SPDT type, rated 1A @24VDC.

Rearm After Closing (RAC):

Works in conjunction with an external DPS wired to the Control Board. Field Selectable Settings:

Setting 1: If the door is open beyond the momentary egress or remote reset time the device will Alarm.

Setting 2: If the door is open beyond the momentary egress or remote reset time the device will remain in egress mode indefinitely until the door closes (will not Alarm).

Electrified Exit Devices

Door Sign:

Door sign per code included.

Note: This feature is not available with,

- M52 Cylinder Dogging
- M61 Alarm Option
- M92 Touchbar Monitor
- MELR Motorized Electric Latch Retraction

How to Order

Specify "D" suffix after device.
Example: ED4200SD

DELAYED EGRESS OPTIONS

Bolt Position Monitor M91:

SPDT (Single Pole Double Throw) switch that monitors the position of the latchbolt or vertical rods. To order, specify M91.

Outside Trim Monitor M93:

Used when outside trim is desired to be used with an external door position switch (by others) input. This switch will allow Bypass (disarms device) when the trim is used for ingress. The device requires setting after entry by means of the keyswitch on the device or a remote switch. To order, specify M93.

Note: If an external DPS is not used, standard trim will allow entry without affecting the device in an armed mode. The device will only be affected when the touchbar is depressed.

NFPA 101 Requirements:

30 Second Delay M88

Upon depressing the pushpad for 3 seconds or longer, the device will sound an audible beeping tone and allow the door to be opened after 30 seconds. The tone will then change to a continuous alarm until reset. Resetting of the alarm and re-arming of the device is accomplished by manual means only. To order, specify M88.

Note: Where approved by the authority having jurisdiction, a delay not exceeding 30 seconds shall be permitted.

BOCA REQUIREMENTS:

BOCA 15 Second Delay M89

BOCA 30 Second Delay M90

Upon depressing the pushpad for 1 second or longer, the device will sound an audible beeping tone and allow the door to be opened within 15 (or 30) seconds. The tone will then change to a continuous alarm until rest. Resetting of the alarm and re-arming of the device occurs automatically once the door has been returned to the closed position for 30 seconds. The 30-second re-arming timer will re-start if the pushpad is depressed or the door is re-opened before actual re-arming of the device occurs. A DPS (Door Position Switch) is required for the BOCA option. To order, specify M89 (BOCA 15 second) or M90 (BOCA 30 second).

Note: BOCA option is not suitable for installations in accordance with NFPA 101.

REQUIRED ACCESSORIES

Power Supply:

A regulated and filtered power supply with a Fire Alarm interface is required.
1 Amp minimum @ 24VDC per device. Special options will require more amperage. Consult factory.
To order, specify LSP-12-24.

Power Transfer:

Allows the power to make the transition from frame to door without pinching or removal of insulation. Optional power transfer: EPTL – concealed transfer for up to and over 120° swing doors. To order specify Part No. 704F28. Consult catalog for additional recommended power supplies and accessories.

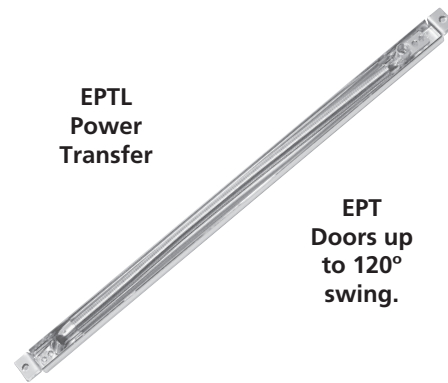

**EPTL
Power
Transfer**

**EPT
Doors up
to 120°
swing.**

Refer to McKinney Power Transfer Device catalog for ElectroLynx options

ElectroLynx® Power Transfer Device Options		
Hinge	External DPS	Options
QC8	Not required	None
QC12	Required	M91 or M93

Trims

See Trims and Functions, pages 14-15.

Cylinders

Utilizes a 1-1/8" mortise cylinder with an A02 cam. Cylinder not included unless specified. See Quick Codes, page 33.

Warranty

Exit devices carry a five-year limited warranty. Electronic components carry a two-year limited warranty. Trim carries a one-year limited warranty.

Electrified Exit Devices

M61 OPTION AND ED40AK ALARM KIT

Activation

Alarm is armed by turning key clockwise. Low audible chirp indicates alarm has been activated. 20-second delay allows egress before alarm is set (selectable, 7, 10, 15 and 20) Alarm will sound when the exit device pushpad is depressed.

Continuous Alarm Mode

Alarm sounds continuously when the exit device pushpad is depressed. Alarm must be manually reset by keyswitch. Dip switch setting allows auto reset from 2, 5 or 10 minutes. LED flashes after device has reset.

Low Battery Warning

Audible chirp every 30 seconds.

Warning Decal

"EMERGENCY EXIT-ALARM WILL SOUND" provided.

REX and Passage Delay

A 7, 10, 15 or 20-second delay (after arming) permits egress (by turning key clockwise).

Alarm Shunt

Shunt alarm input for devices with signal, outside trim monitors (M91 & M93) or card access.

Power Requirements

One 9-volt battery (included).

Alarm Strength

105db @ 10 feet.

Arm/Disarm

Requires one 1-1/8" mortise cylinder with an A02 cam. Clockwise turn arms the alarm, counterclockwise turn disarms or silences the alarm. Low audible chirp indicates alarm has been activated.

Device Status

A Red LED indicator will illuminate every 30 seconds when the alarm is armed. DIP switch allows LED to be changed to green if desired.

Tamper Resistant

Built-in safety monitor sounds alarm when tampering occurs.

Cylinders

Cylinder not included unless specified. See How to Order, page 37.

Door Width

Available for 36"-48" devices only. Not available with devices less than 36". 48" device can be cut to fit 42" door.

Quick Code

M61

Kit

Available in kit form for field retrofit. Order ED40AK.



Hard Wired Option

A hard wired option is available by using a 9VDC output power supply and a remote power harness. Specify 709F989 to order the remote power harness for a 36" device and specify 709F999 to order the remote power harness for a 48" device.

Exceptions

Dogging not available with M61 option and ED40AK alarm kit. The ED40AK for the ED4000 series exit devices cannot be retrofitted in the field to ED4400 series surface vertical rod exit devices.

The alarm option is available for the surface vertical rod devices by factory order only. To order, add the quick code suffix M61 to the device number; for example, ED4400 x M61.

Please note, in accordance with Corbin Russwin's standard limited warranty, any attempt to retrofit the ED40AK to a surface vertical rod exit device will void the warranties for these products.

Surface vertical rod exit devices with M61 alarm option cannot be ordered with M91, M92 or M93 monitors.

M61 alarm option is not available with delayed egress (D).

How to Order

Ordering example for Exit Device

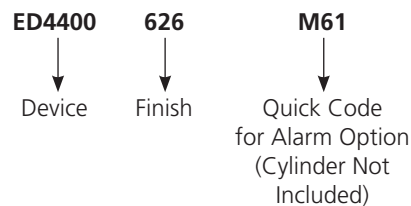

Ordering Example for Alarm Kit Only

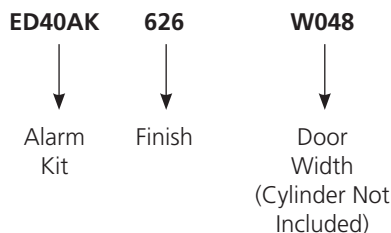

Electrified Exit Devices

EPTL

Concealed power transfer for over 120° swing doors. Installs in door and frame edges. Supports wires up to .25" (6mm) thick, and works with doors hung with butt hinges, continuous hinges and pivots. To order, specify Part No. 704F288.



Electrified Options & Accessories

MONITORS - M91, M92, M93

Operation

Monitors are used to indicate the authorized and unauthorized use of an opening or to signal and control other opening hardware, such as magnetic locks. Each monitoring device is equipped with one internal single-pole double-throw (SPDT) switch per monitor.

Bolt Position Monitoring - M91

Provides indication of the position of the deadlatch or vertical rods. Used with security systems to monitor the deadlatch in rim, SecureBolt® devices and rods in CVR & SVR devices.

Application

See chart on page 19.

Listings

UL listed for Panic Exit Hardware.

Electrical Specifications

2 Amps @ 28VDC
SPDT contacts.

Ordering

Specify quick code M91.

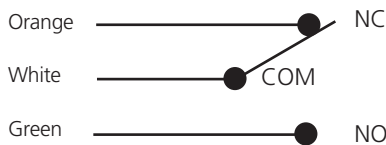

Touchbar Monitoring - M92

Provides indication of the pushpad being depressed. Used as a request to exit to shunt alarm systems, release electromagnetic locks or monitor egress.

Application

See chart on page 19.

Listings

UL listed for Panic Exit Hardware.

Electrical Specifications

2 Amps @ 28 VDC
SPDT contacts.

Ordering

Specify quick code M92.

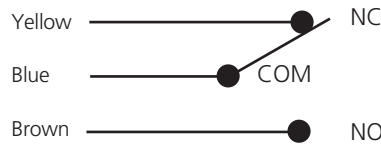

Outside Monitoring or Signaling - M93

Provides indication of the device being operated from the outside. Used as a request to enter signal switch to shunt alarms; also used to monitor entry.

Application

See chart on page 19.

Listings

UL listed for Panic Exit Hardware.

Electrical Specifications

2 Amps @ 28VDC
SPDT contacts.

Ordering

Specify quick code M93.

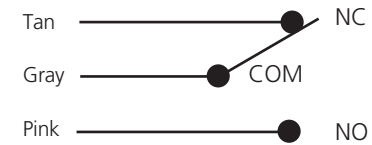

Electrified Options & Accessories

LSP-12-24 POWER SUPPLY

Operation

LifeSafety Power supplies are designed to provide reliable filtered and regulated power for long life to a variety of electrified hardware components. Recommended for the SAF, SEC, MELR, "D" delayed egress exit devices and electric trim.

Features

- Selectable voltage output between 12V and 24V with a single switch
- Internal Back-Up battery charging circuit*
- Regulated and filtered, fuse protected outputs
- Each output can be individually turned on and off via a jumper
- Power status of each output is shown by an LED
- Rugged steel enclosure
- Fire alarm interface included – Dry contacts NO/NC, 9-33VDC, 3-15mA

Electrical Specifications

- Inputs: 120VAC
- Outputs: 12VDC @ 6 Amp or 24VDC @3 Amp
 - 8 Total Outputs

Listings

- UL294, UL603, UL1076
- ULC S318, ULC S319

Applications

- D – Delayed Egress
- SAF / SEC – Fail Safe / Secure mortise device trim control
- 900ET Series Electrified Trim
- MELR – Motorized Electric Latch Retraction

*Note: Batteries are not included with the power supply



Model	Description
LSP-12-24	12V – 6AMP / 24V – 3AMP Power Supply

EXIT CONTROLS AND SWITCHES

Key Switches



MKA - (1) SPDT Maintained
 MK - (1) SPDT Momentary
 MKAN - (1) SPDT Momentary NS
 MK2 - (1) DPDT Momentary
 MKPZ x MKS - (1) SPDT Momentary with audio Double Gang x Additional Switch
 Note: All key switches come standard with 12/24 VDC bi-color LED.

Specifications

- Keyswitch for operation using a standard 1-1/8" mortise cylinder (A02 cam) (cylinder not included).
- Contact Rating 5 Amps @ 12-24VDC
- SPDT 3-position.

Push Buttons

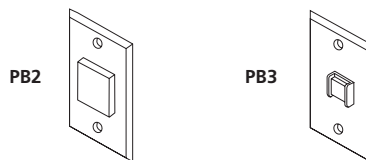

PB2 - (1) SPDT Momentary
 PB2 - (1) DPST Remote Momentary
 PB3 - (1) DPST Momentary
 PB3A - (1) DPST Maintained (Alt. Action)
 PB3EA - (1) DPST Alternate

Specifications

- 3 Amps @ 12-24 VDC

Audible/Visual Annunciators



PZ1 - Sonalert 90db @ 2ft. 12-24VDC. Mounted on one gang stainless steel plate.

Digital Entry

DK-12 - Digital Keypad - 4 User
 DK-26SS - Digital Keypad NS - 59 User - SS Finish
 DK-26BK - Digital Keypad NS - 59 User - Black Finish

Power Transfers

TSB B-C - Door Cord

Electrified Applications

LATCH PULLBACK - MELR OPTION

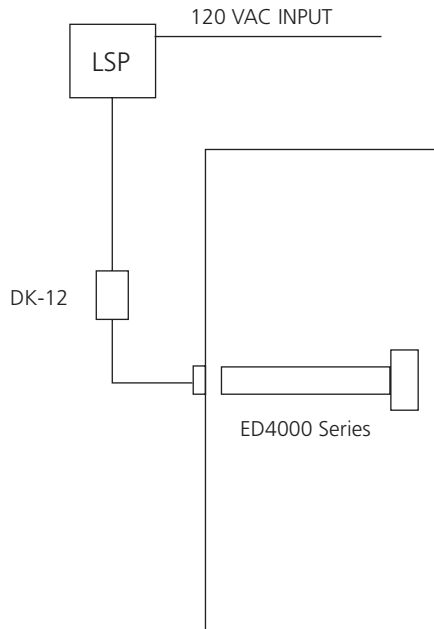

Components

ED4000 Series x MELR Latch Retraction Exit Device - Corbin Russwin
 DK-12 – Digital Keypad
 Power Transfer Hinge

Operation

Operation of DK-12 Digital Keypad will allow keyless entry from the non-protected side of opening. Free exit using the exit device from the protected side of the door.

Electrified Applications

LATCH PULLBACK - MELR OPTION WITH NORTON® AUTOMATIC DOOR OPERATOR

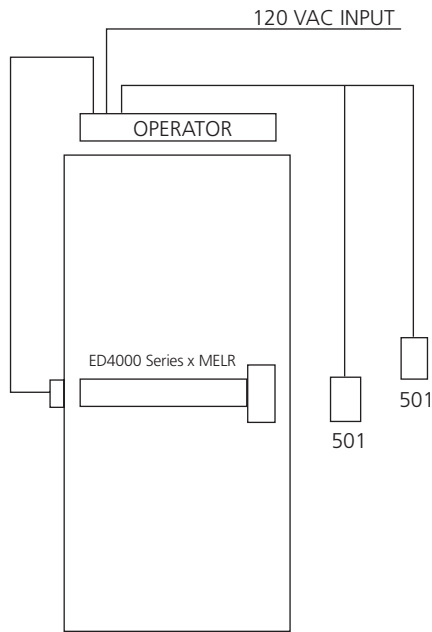

Components

- ED4000 Series x MELR Latch Retraction Exit Device - Corbin Russwin
- Automatic Door Operator - Norton
- 501 Push Switch or 700 Wave to Open Switch - Norton
- Power Transfer Hinge
- Keyswitch - Corbin Russwin

Operation

Activation and operation of Push Switches from either side of door will be controlled by the Maintained Keyswitch. The Push Switches will in turn activate Latch Retraction Exit Device. An internal timer on the 6000 will coordinate and prevent the door from being opened before latch retraction takes place. Standard timers on the 6000 will also provide length of time door is open and latch being retracted. Door operator also acts like standard closer when opened manually.

EXIT DEVICE WITH ELECTRIC STRIKE

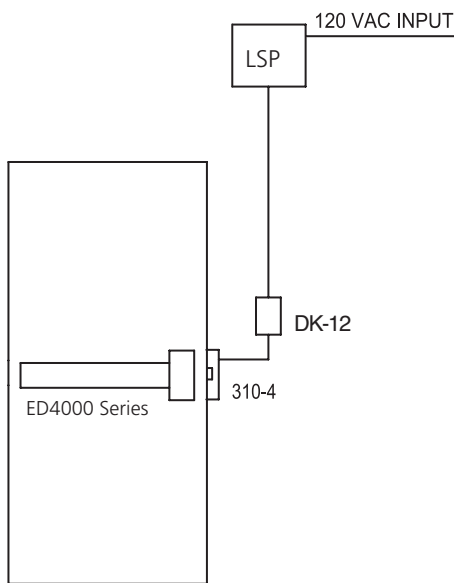

Components

- ED4000 Series Exit Device – Corbin Russwin
- DK-12 – Digital Keypad
- 310-4 Electric Strike – Folger Adam®
- LSP Power Supply – Corbin Russwin

Operation

Operation of DK-12 Digital Keypad will allow keyless entry from the non-protected side of opening. Free exit using the exit device from the protected side of the door.

Electrified Applications

EXIT DEVICE WITH DELAYED EGRESS OPTION ON "EXIT ONLY" DOOR

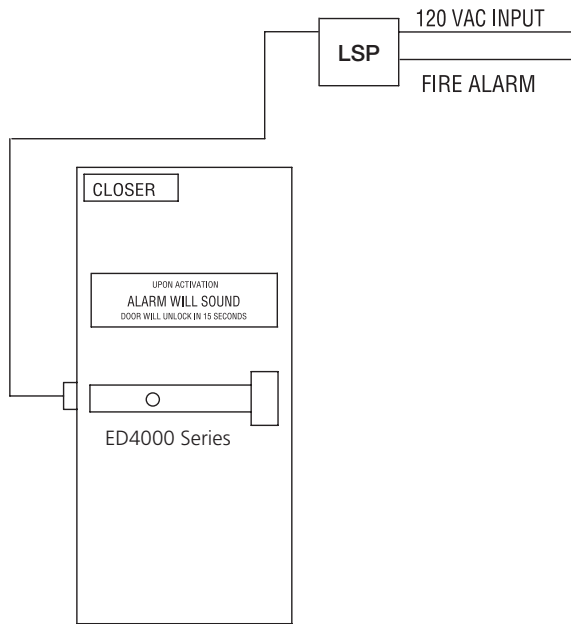

Components

- ED4000 Series Delayed Egress Exit Device – Corbin Russwin
- Power Transfer Hinge
- LSP Power Supply – Corbin Russwin
- Surface Door Closer – Corbin Russwin

Operation

Operation of the ED4000 Series Exit Device will sound an alarm and activate either a 15- or 30-second alarm sequence inside of the exit device. After this time period, the device will release the pushbar, making it active, and egress is possible. When the fire alarm is activated, power to the exit device will be interrupted, allowing free egress and mechanical latching. Authorized alarm bypass and reset is done through the built-in keyswitch located in the exit device.

EXIT DEVICE - HIGH SECURITY APPLICATION

M91, M92 AND M93 MONITORING SWITCH OPTIONS WITH FAMSS-1C DOOR POSITION SWITCH

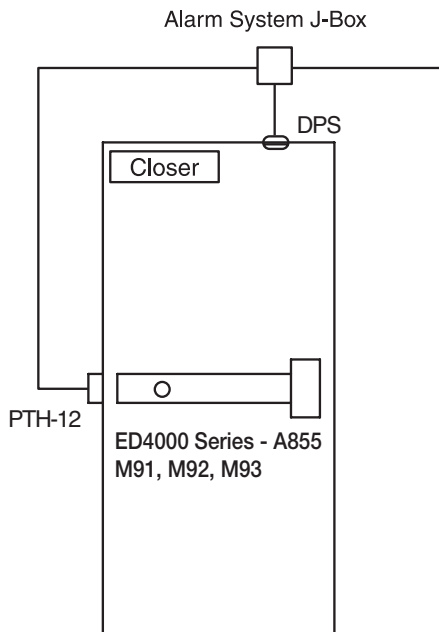

Components

- ED4000 Series - A855 Nightlatch Trim – Corbin Russwin
- M91 Bolt Monitor Switch
- M92 Touchbar Monitor Switch
- M93 Trim Monitor Switch
- Door Position Switch
- Power Transfer Hinge
- Surface Door Closer – Corbin Russwin

Operation

Operation of the ED4000 Series Exit Device with the M91, M92, M93 and a door position switch can be used together or individually to sound an alarm, shunt an alarm, monitor the door's security or as a "Request to Exit" in conjunction with a magnetic lock.

Mullions

CR808 Mullion

Used to install two Rim Exit Devices in a double door opening. May be quickly and easily removed when a full double door opening is temporarily required.

Materials and Finish

Extruded aluminum mullion, 1-1/4" x 3-1/2" x 8'2" (for 8'0" doors), supplied with two integral strikes, top and bottom mounting brackets, two sets of mullion stabilizers, and zinc-plated fasteners for metal frames and concrete floors. May be cut, drilled and tapped in the field for Rim Exit Devices. Available in 628 and 695 finishes.

Ordering

To order, specify Part No. CR808* x Finish.

Mullion Stabilizer Kit

Controls the movement of the mullion. Recommended for openings over 7' high or whenever door movement must be minimized. Available in 628 and 695 finishes. Two sets supplied standard with all CR808 mullions. To order separately, specify Part No. 653F11-1 x Finish.

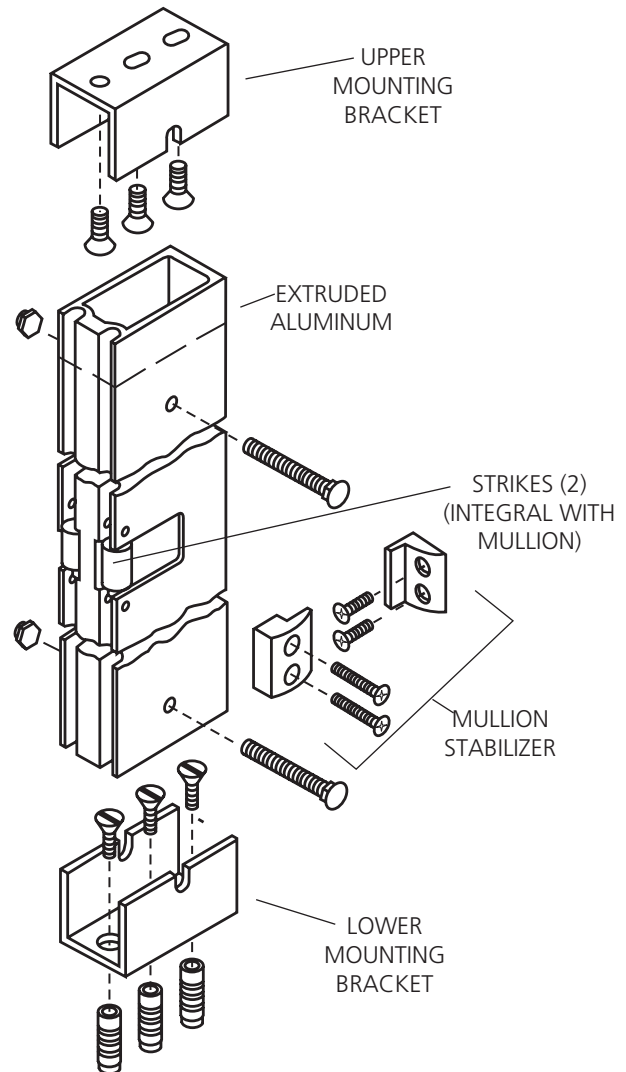

Options and Accessories

Shim Kits

Designed for mounting an exit device over raised vision light molding. Each kit contains two sets of 1/8" thick shims to shim a device 1/8" (3mm) or 1/4" (6mm). Black finish. To order with exit device, specify M58. To order separately, specify Part No.

Exit Device Type	Shim Kit Part No.
ED4200, ED4200S, ED4800	697F35-8
ED4400	697F36-8

Cylinder Dogging Kits

Designed to convert a panic device from hex key dogging to cylinder dogging. To order cylinder dogging kit, specify Part No. x Finish below. Cylinder not included.

Bar Length	Cylinder Dogging Kit Part No.
Standard W036	653F13M x FIN
W048	865F14M x FIN

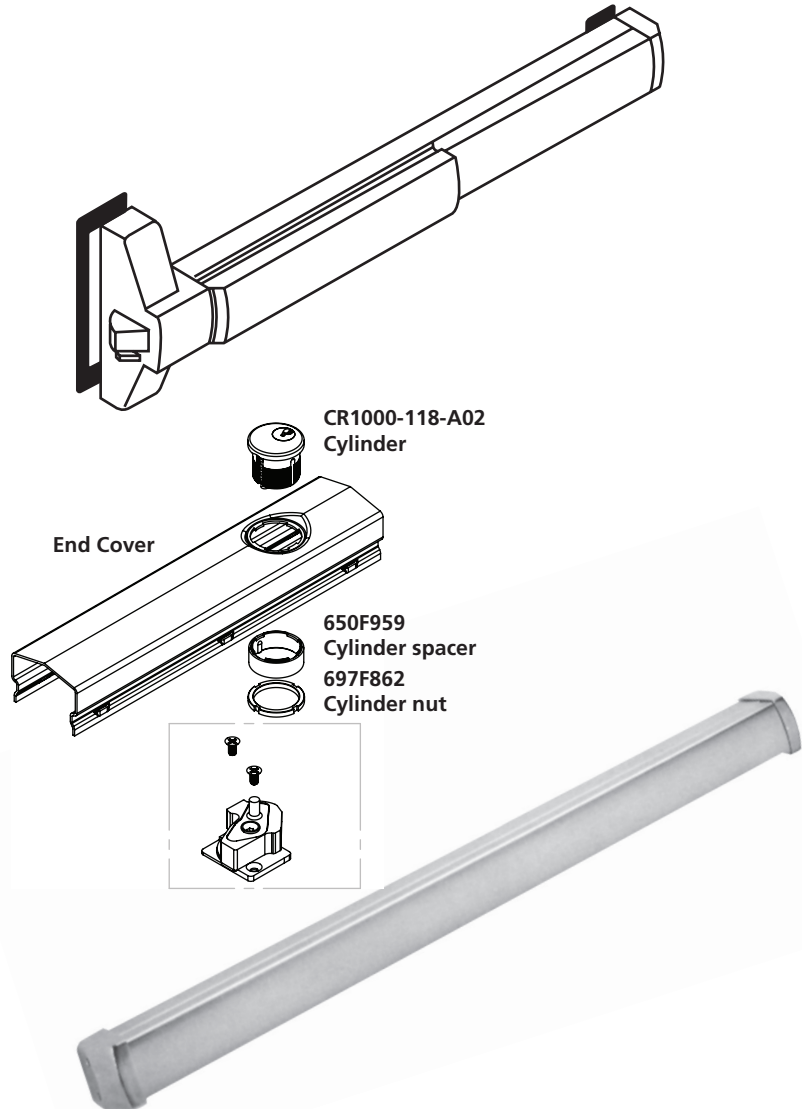

ED5000DB Inactive Bar

Non-operating dummy pushbar available for doors up to 48" wide. May be field cut for narrower doors. To order, specify ED5000DB x Finish.

Surface and Concealed Vertical Rod Extension Kits

Used to extend the height of standard length rods supplied with ED4400 and ED4800 Series exit devices. Available in 2", 6" and 12" sizes. To order with exit device, see How to Order, page 34. To order separately, specify Part No. x Finish.

Rod Extension	Rod Extension Kit Part No.
2" (50mm)	655F15 x Finish
6" (152mm)	655F16 x Finish
12" (305mm)	655F17 x Finish
24" (610mm)	684F42 x Finish

Options and Accessories

Rim Strike (Screws Included)

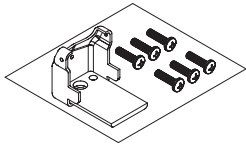

End Cap Reinforcement**
A solid steel plate, welded to the end bracket, evenly distributes impact forces over a larger surface area, eliminating point loading. To order with an exit device, specify M109. To order separately specify 705F09 x finish.



Flush End Cap
Durable heavy-duty cast steel or stainless steel, sits flush on the exit device rail and has a low profile which eliminates catch points. To order with a device, specify M110. To order separately specify 710F00M x finish.

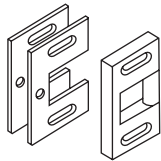

Rim Strike
Standard on ED4200 and ED4200S devices, Supplied with two 1/16" (2mm) shims. For doors with 1/2" (13mm) or 5/8" (16mm) stop. Adjustable to compensate for shrinkage and swelling of door. 3" x 2" (76mm x 51mm). Black finish only. To order separately, specify 650F31-8.

Filler Plates

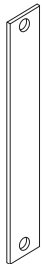

Optional for use on stock metal doors when required. To order, specify Part No. x Finish.

Front: 334F99-8 600

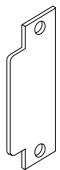

Optional for use on stock metal doors when required. To order, specify Part No. x Finish.

Strike: 236L708018 x Fin

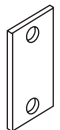

Optional for use on stock metal doors when required. To order, specify Part No. x Finish.

Front: 077F19-8 600

Surface and Concealed Vertical Rod Strikes (Screws Included)

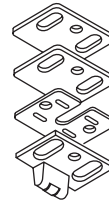

Top Strike
Standard on ED4400 and ED4800 devices. Supplied with two 1/16" (2mm) shims and one 1/16" (2mm) locking plate. Adjustable to compensate for shrinkage and swelling of door. 1-9/16" x 15/16" (40mm x 24mm). Black finish only. To order separately, specify 650F548.



Bottom Strike
Standard on ED4400 and ED4800 devices. 1-1/16" (27mm) diameter x 1/16" (2mm) lip x 1 1/16" (17mm) high. Black finish only.

Both top and bottom strikes are included in the vertical rod parts packet. To order parts packet, specify 650F57-8.

Flush Transom Top Strike Bracket

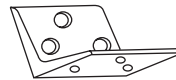

Optional for use with ED4400 devices. Used to mount top strike on openings with flush transom. 2-1/2" x 1-5/8" (64mm x 41mm). Black finish only. To order with exit device, specify M67. To order separately, specify 650F87-8.

Bottom Strike for 1/2" Thresholds

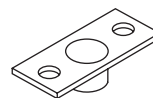

Optional for use with ED4400 and ED4800 devices. Required for 1/2" (13mm) threshold or for flush mount. 2-5/8" x 1-1/16" (67mm x 27mm). Black finish only. To order with exit device, specify S09. To order separately, specify 650F88-8.

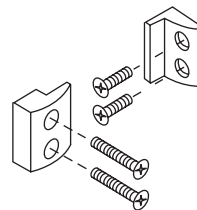

Mullion Stabilizer Kit

Controls the movement of the mullion. Two sets supplied standard with all CR808 mullions. Available in 628 and 695 finishes. To order separately, specify Part No. 653F11-1 x Finish.

PHOTOLUMINESCENT TOUCHPAD COVER

The PathLite™ patent pending technology offers a number of benefits:

- Requires no wiring or maintenance
- Recharges with exposure to ambient light
- Unaffected by heat or cold
- Non-toxic, will not rub or fade
- Vandal resistant

**Note: Six 1/4 x 20 screws come standard with either M109 option or 705F09 kit. Only two screws required to fasten end cap assembly to door for retrofit. Other four screws are used with SecureBolt® Latch Head if ordered as an M109 option with complete device. When the kit is ordered a new end cap is also supplied.

Cylinders

Rim (Trim Only)

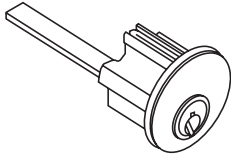

Description	Part Number	Cylinder Ring	Part Number	Cylinder Ring** 57 Function Only
6-pin	CR3000-058	270F15	CR3000-200N*	270F15
7-pin	CR3000-058-7	654F07	CR3000-200-7	654F07
6-pin, LFIC	CR3080-058	654F07	CR3080-178	654F07
7-pin, LFIC	CR3080-058-7	654F08	CR3080-178-7	654F08
6-pin, LFIC, less core	CR3070-058	654F07	CR3070-178	654F07
7-pin, LFIC, less core	CR3070-058-7	654F08	CR3070-178-7	654F08
6-pin, SFIC	CR3050-058	654F07	CR3050-178	654F07
7-pin, SFIC	CR3050-058-7	654F08	CR3050-178-7	654F08
6-pin, SFIC, less core	CR3040-058	654F07	CR3040-178	654F07
7-pin, SFIC, less core	CR3040-058-7	654F08	CR3040-178-7	654F08
6-pin, Security	CR3010-058	654F07	CR3010-200	654F07
6-pin, Security IC	CR3090-058	654F07	CR3090-178	654F07
7-pin, Pyramid	CR3020-058	654F07	CR3020-200	654F07
7-pin, Pyramid IC	CR3030-058	654F07	CR3030-178	654F07

*For K157, substitute -200

**K157 uses the 270F15 cylinder ring

Mortise (Cylinder Dogging Only)

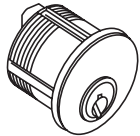

Description	Part Number	Cylinder Ring
6-pin	CR1000-118-A02	N/A
7-pin	CR1000-114-A02-7	270F15
6-pin, LFIC	CR1080-114-A02	270F15
7-pin, LFIC	CR1080-112-A02-7	654F07
6-pin, LFIC, less core	CR1070-114-A02	270F15
7-pin, LFIC, less core	CR1070-112-A02-7	654F07
6-pin, SFIC	CR1050-114-A02	270F15
7-pin, SFIC	CR1050-114-A02-7	654F07
6-pin, SFIC, less core	CR1040-114-A02	270F15
7-pin, SFIC, less core	CR1040-114-A02-7	654F07
6-pin, Security	CR1010-118-A02	270F15
6-pin, Security IC	CR1090-114-A02	270F15
7-pin, Pyramid	CR1020-114-A02	270F15
7-pin, Pyramid IC	CR1030-114-A02	270F15

How to Order the Muséo® Piet Levers

MUSÉO® PIET LEVER COLLECTION TRIM AND FINISH OPTIONS



Grooved Insert
21G



Leather Insert
21L



Polished with Satin Insert
21M



Santoprene™ Insert
21S



With Raised Band
23M



Plain
25M



Plain with Two Grooves
27M

Piet Finish Codes

BHMA/ASSA ABLOY Finish	Piet Code*	Description
630	30	Satin Stainless Steel
629	29	Bright Stainless Steel
613E	3E	Dark Oxidized Satin Bronze, Equivalent
BSP	BS	Black Suede Powder Coat
WSP	WS	White Suede Powder Coat
N/A	BK	Black (Santoprene™ or leather insert)
N/A	BN	Brown (leather insert)
N/A	00	No Insert

*Code used to specify Piet Collection finishes only. Use available finishes list to specify desired finish when ordering.

Piet Lever Descriptions & Available Finishes

Lever Designation	Lever Description	Available Finishes (as ordered)
21G	Grooved Insert	303030, 292929, 3E003E, BS00BS, WS00WS
21L	Leather Insert	30BK30, 30BN30, 29BK29, 29BN29, 3EBK3E, BSBKBS, WSBKWS, 3EBN3E, BSNBBS, WSNBWS
21M	Satin Metal Insert	293029**
21S	Santoprene Insert	30BK30, 29BK29, 3E003E, BS00BS, WS00WS
23M	Raised Band	290030**, 290029, 300030, 300029***, 3E003E, BS00BS, WS00WS
25M	Plain	290029, 300030, 3E003E, BS00BS, WS00WS
27M	Two Grooves	290029, 300030, 3E003E, BS00BS, WS00WS

**Two-tone finish: grip of lever is 630, balance of lever is 629. Rose/escutcheon and lock finish will be 629.

***Two-tone finish: grip of lever is 629, balance of lever is 630. Rose/escutcheon and lock finish will be 630.

Ordering Examples

Trim Only

Quantity	Trim/Function	Lever Finish	Hand
2	21M850	293029	RHR

In this example the escutcheon finish will be supplied in 618.

Exit Device with Trim

Quantity	Exit Device	Trim/Function	Lever Finish	Exit Bar Finish	Hand	Cylinder Option	Door Thickness	Optional Strike	Door Width
2	ED4400M	21G850	303030	630	LHR	6P	D200	SB214	W048

How to Order

ORDERING EXAMPLES

Exit Device Only

Quantity	Series/ Function	Finish	Hand	Misc. Options
24	ED4200S	626	RHR	M51-M54

Removable Mullion

Quantity	Mullion	Finish
12	CR808	695

Where to find ordering information and Quick Codes

Trims and Functions	Page 14
Removable Mullion	Page 28
Handing	Page 33
Door Thickness	Page 33
Strike	Page 33
Door Width	Page 33
Door Height	Page 33
Miscellaneous Options	Page 33
Cylinder and Keying	Page 33

Exit Device with Trim

Quantity	Exit Device	Trim/ Function	Finish	Hand	Door Thickness	Door Width	Door Height	Misc. Options
36	ED4400	N855ET	605	LHR	D200	W048	H0706	M51-M54

Trim Only

Quantity	Trim/ Function	Finish	Hand	Door Thickness	Cylinder Option
24	N855ET	625	RHR	D214	6P

Contract/Detailed Order – Exit Device with Trim

Quantity	Exit Device	Trim/ Function	Finish	Hand	Door Height	Optional Strike	Door Width	Misc. Options	Cylinder/ Key Options	Keyset
36	ED4400	C855ET	626	LHR	H0800	S09	W048	M52-M54	7P - VKC3	AA1

Quick Codes

CYLINDER AND KEYING

Description	Specify
Less cylinder(s)	(standard)
Conventional 6-pin	6P
Conventional 7-pin	7P
LFIC	
LFIC 6-pin ¹	C6
LFIC 6-pin less core	CL6
LFIC 6-pin with temporary construction core (Red)	CT6R
LFIC 6-pin with temporary construction core (Blue)	CT6B
LFIC 6-pin with temporary construction core (Green)	CT6G
LFIC 6-pin with temporary disposable core	CT6D
LFIC 7-pin	C7
LFIC 7-pin less core	CL7
LFIC 7-pin with temporary construction core (Red)	CT7R
LFIC 7-pin with temporary construction core (Blue)	CT7B
LFIC 7-pin with temporary construction core (Green)	CT7G
LFIC 7-pin with temporary disposable core	CT7D
SFIC	
SFIC 6-pin	C6S
SFIC 6-pin with temporary construction core (Blue)	CT6SB
SFIC 6-pin with Less Core	CLS6
SFIC 6-pin with SFIC disposable temporary core	CT6SD
SFIC 7-pin	C7S
SFIC 7-pin with temporary construction core (Blue)	CT7SB
SFIC 7-pin with Less Core	CLS7
SFIC 7-pin with SFIC disposable temporary core	CT7S
Security	
Security	HS
Security IC	CHS
Access 3[®]	
Access 3 [®] - Patented	AP
Access 3 [®] - Security	AS
Access 3 [®] - High Security	AHS
Access 3 [®] IC - Patented	ACP
Access 3 [®] IC - Security	ACS
Access 3 [®] IC - High Security	ACHS
Pyramid	
Pyramid Security fixed core	PS
Pyramid Security IC	PCS
Pyramid High Security fixed core	PHS
Pyramid High Security IC	PCHS
Pyramid IC with temporary construction core	CTP
Pyramid IC with temporary disposable core	CTPD
Pyramid IC less core	CLP
Keying and Keys	
0-bitted with 2 blank keys	(standard)
Keyed random	KR
Construction master keyed	CMK

*Not available with Rim or SVR lever trim - Classroom Function

+Not available with 55 function

FINISH

Description	Specify
US3 Bright Brass	605
US4 Satin Brass	606
US9 Bright Bronze	611
US10 Satin Bronze	612
US10B Dark Oxidized Satin Bronze, oil rubbed	613
US10BE Dark Oxidized Satin Bronze Equivalent	613E
US14 Bright Nickel Plated	618
US15 Satin Nickel Plated	619
US26 Bright Chromium Plated	625
US26D Satin Chromium Plated	626 ¹ (Trim only)
Satin Chromium Plated with MicroShield [®]	626C ²
US32 Bright Stainless Steel	629
US32D Stain Stainless Steel	630
Stain Stainless Steel with MicroShield [®]	630C ²
Satin Aluminum, Clear Anodized (mullions only)	628
Dark Bronze Coated (mullions only)	695
— Black oxidized bronze, oil rubbed	722
— Black Suede Powder Coat	BSP
— White Suede Powder Coat	WSP

1. Contact factory for devices required in BHMA 626

2. Finish available with MicroShield[®] antimicrobial coating.

LOCK/CYLINDER FINISH

Lock	Cylinder/ Core*
605,606,611,612,613,613L,722	606
618,619,625,626,WSP	626
BSP	BSP

*Finish when cylinder provided with lock

DOOR HEIGHT

Door Height	Specify
ED4400 devices	
7'0"	(standard)
7'2"	H0702
7'6"	H0706
8'0"	H0800
9'0"	H0900
10'0"	H1000
ED4800 devices	
8'0"	(standard)
8'2"	H0802
8'6"	H0806
9'0"	H0900
10'0"	H1000

Quick Codes

DOOR WIDTH

Door Width	Specify
24" (610mm)	W024
36" (914mm)	(standard)
48" (1219mm)	W048

HANDING

Hand	Specify
Right Hand Reverse	RHR
Left Hand Reverse	LHR

DOOR THICKNESS

Door	Specify
1-3/4" (44mm)	(standard)
2" (51mm)	D200
2-1/4" (57mm)	D214

STRIKE

Description	Specify
Surface and concealed vertical rod Bottom strike for 1/2" thresholds	S09

REMOVABLE MULLION

Door Height	Specify
Up to 8'0" (ED4200 & ED4200S)	808

MISCELLANEOUS OPTIONS

Description	Specify
Torx® head screws	M04
Knurling outside and inside (embossed touchbar - device side)	M20 ¹
Knurling outside only (trim side)	M21 ^{1,2}
Knurling inside only (embossed touchbar - device side)	M22 ¹
Abrasive coat outside and inside (trim and device)	M23
Abrasive coat inside only (device side)	M24
Abrasive coat outside only (trim side)	M25
24", 36" and 48" PathLite™ Photoluminescent Touchbar Cover	M49
Less dogging	M51
Cylinder dogging	M52
Sex nuts and bolts (SNBs)	M54
Shim kit (for vision light)	M58
High Impact End Clamp	M109
Flush End Cap	M110

1. All levers provided in a powder coat finish will be supplied with an abrasive coating
2. Not available on museo and vineyard levers

ELECTRICAL OPTIONS

Description	Specify
Alarm Option	M61
Bolt Position Monitor	M91
Touchbar Monitor	M92
Trim Monitor	M93
Delayed Egress	D
Motorized Electric Latch Retraction	MELR

Facts and Figures

ED4000 SERIES (ALL VARIABLES)

Series	"A"	"B"
ED4000	34-5/8" (880mm)	18" (457mm)
ED4000 x W024	22-5/8" (575mm)	12" (305mm)
ED4000 x W048	46-5/8" (1184mm)	24" (610mm)

Dimensions are shown in: **inches**
mm

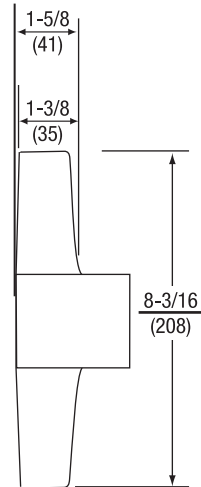

Cover Detail

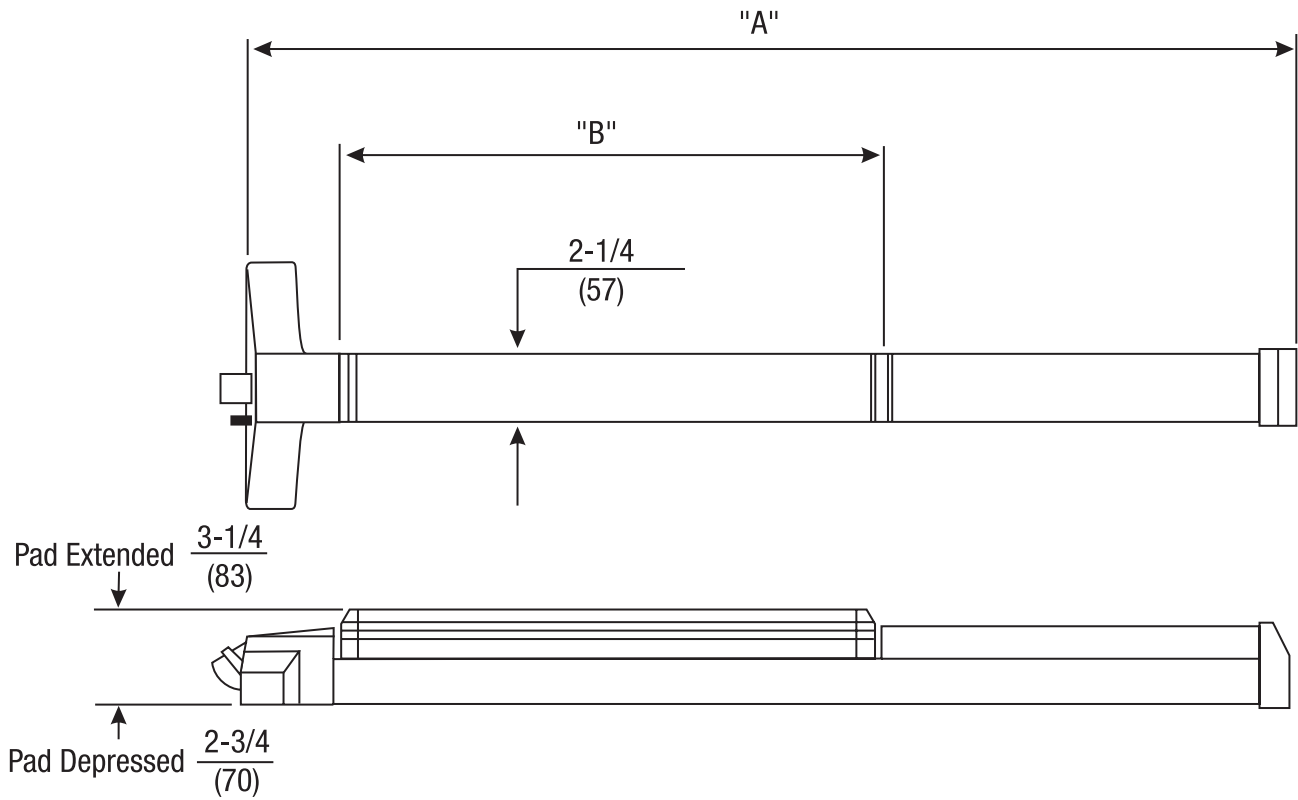

Helpful Terms

Abrasive Coat

Hard granular material applied to provide a non-slip tactile surface for the visually impaired.

Active Door

In a pair of doors, the door that is operable from the trim side.

Astragal

A vertical member applied to one or both sides of a pair of doors at the meeting edges. The astragal closes the gap between the two doors.

Coordinator

A device used on a pair of doors to ensure that the inactive door closes before the active door.

Deadlocking Latch

A supplemental latch that automatically deadlocks the latchbolt when pressure is applied to it.

Dogging

A mechanism that allows the latchbolt to remain retracted, permitting the door to operate as if it were a push-pull; it cannot be used on fire-rated exit devices.

Double Egress

A pair of doors of the same hand that swing in opposite directions, commonly found in corridors.

Dummy Trim

Trim only. Usually used on the inactive door of a pair of doors for design balance.

Exit Device (Panic Hardware)

A door locking device with a pushbar or crossbar which, when pressed, allows instant exit (egress).

Fire Exit Hardware

An exit device listed by an independent testing laboratory as meeting panic, fire and hose stream test standards; used on fire-rated openings.

Hand

The direction a door swings.

Inactive Door

In a pair of doors, the door that is inoperable from the trim side.

Latchbolt

A lock component that has a beveled end and projects into a strike, holding the door in a closed position.

Mullion

A fixed or removable vertical member that divides a door opening and provides a latch surface for a pair of rim exit devices.

Open Back Strike

For mortise exit devices, used on the inactive door (usually the vertical rod door) of a pair of doors that swing in the same direction. It permits the inactive door to open or close independently.

Reversible

Pertains to a product that may be changed in the field to accommodate any hand of the door.

Shim Kit

Pieces of metal that permit mounting of an exit device on a door that has a surface projecting vision light (glass bead) molding.

Split Astragal

An astragal that is split through the middle on a pair of doors, allowing both doors to operate independently.

Threshold

A strip fastened to the floor beneath a door. It serves as a stop, prevents heat loss, and provides a strike location for latching the bottom rod of a vertical rod exit device.

Trim

A knob, lever, pull, or thumbpiece used on the outside of an exit device door to control access to an area.

Universal Exit Device

An exit device that may be used on doors of either hand without any modifications.

KEYING AND CYLINDER TERMS

Concealed Key Control (CKC)

The marking of standard key symbols on a cylinder in a location that is not visible once the cylinder is installed.

Construction Master Keying (CMK)

A cylinder preparation that allows temporary access by construction personnel.

Control key

A key used to remove and install interchangeable cores.

Cylinder

A lock component containing the combination that determines which keys will operate.

Security Cylinder

A cylinder which provides extra resistance to picking and unauthorized duplication of keys.

Interchangeable Core (IC)

A cylinder which can be removed and installed quickly with a control key by non-skilled personnel when rekeying is required.

Key Symbol

A letter/number combination in standard industry format (e.g., 1AA, AA1, etc.) which indicates exactly how a key or cylinder fits into a keying system.

Keyway

The opening in a cylinder plug through which the key enters.

Master Keying

Preparation of a cylinder to operate with keys of different levels of access.

Visual Key Control (VKC)

The marking of standard key symbols on keys and on the visible portion of the front of a cylinder.

Suggested Specification

SUGGESTED SPECIFICATION

Exit devices shall be ED4000 Series Narrow Stile Pushpad Exit Devices.

The exit device chassis shall be cold forged steel, electroplated for corrosion resistance, and shall be architecturally finished brass, bronze or stainless steel. The pushpad mechanism shall be constructed of extruded aluminum and shall be scalped with architecturally finished brass, bronze or stainless steel. The maximum projection shall be 3-1/4" when the pushpad is active and 2-3/4" when the pushpad is dogged down. Nylon bearings and stainless steel springs shall be used for long life and durability; only torsion springs are acceptable. Rear and active case covers shall be wrought brass or bronze and shall be plated to match the exit bar. Plastic or painted covers are not acceptable. Latchbolts shall be steel and shall incorporate a deadlocking latch feature for increased security. Devices without deadlocking latches are not acceptable. Mounting screws shall be concealed to deter tampering. Devices shall be closed on all sides with no pinch points. All exit devices shall be easily field sized to accommodate various door widths.

Exit devices shall have single point, one quarter turn hex key dogging standard. Optional cylinder dogging shall be available. Devices with hex key dogging shall be easily field converted to cylinder dogging. Panic listed devices shall be available less dogging. Trims shall be throughbolted with concealed fasteners. Escutcheon and pull type trims shall be constructed of brass or bronze. All lever trims shall use cast or forged levers. On trims with cylinders, the mechanism that locks and unlocks the trim shall be housed in the trim and not in the active case of the exit device. Lever trims shall match those on Corbin Russwin Mortise and Cylindrical Locksets.

Exit devices and trims shall be furnished in BHMA standard architectural finishes.

Exit devices shall be listed by Underwriters Laboratories (UL) for safety as panic hardware.

Certification:
ANSI/BHMA A156.3, Grade 1

Exit devices, trims and cylinders shall be from one manufacturer.

Trims and electronic components shall carry a two-year limited warranty.

Exit devices shall carry a five-year limited warranty.

The ASSA ABLOY Group is the global leader in access solutions. Every day, we help billions of people experience a more open world.

ASSA ABLOY Opening Solutions leads the development within door openings and products for access solutions in homes, businesses and institutions. Our offering includes doors, frames, door and window hardware, locks, perimeter fencing, access control and service.



For additional information, contact your
ASSA ABLOY Door Security Solutions
sales consultant or
visit www.corbinruswin.com.

In U.S.

Corbin Russwin
Architectural Hardware
225 Episcopal Road
Berlin, CT 06037
Phone: 800-543-3658
Fax: 800-447-6714
www.corbinruswin.com

In Canada

ASSA ABLOY Door
Security Solutions Canada
160 Four Valley Drive
Vaughan, Ontario
Canada L4K 4T9
Phone: 800-461-3007
Fax: 800-461-8989
www.assaabloydss.ca

ASSA ABLOY Group companies offer MicroShield®, an antimicrobial coating for door hardware. MicroShield uses proven silver ion-based technology from Agion®, a leading provider of antimicrobial solutions, to stem the spread of bacteria and other microbes.

MicroShield® is a trademark of ASSA ABLOY Access and Egress Hardware Group, Inc.



The Agion antimicrobial is not intended as a substitute for good hygiene. Coated products must still be cleaned to ensure the surfaces will be free of destructive microbes. ASSA ABLOY makes no representations or warranties, express or implied, as to the efficacy of the Agion antimicrobial. A copy of the Agion warranty is available upon request. Agion is a registered trademark of Agion Technologies, Inc., Wakefield, MA, USA.