

STI STEEL WEB STOPPERS®

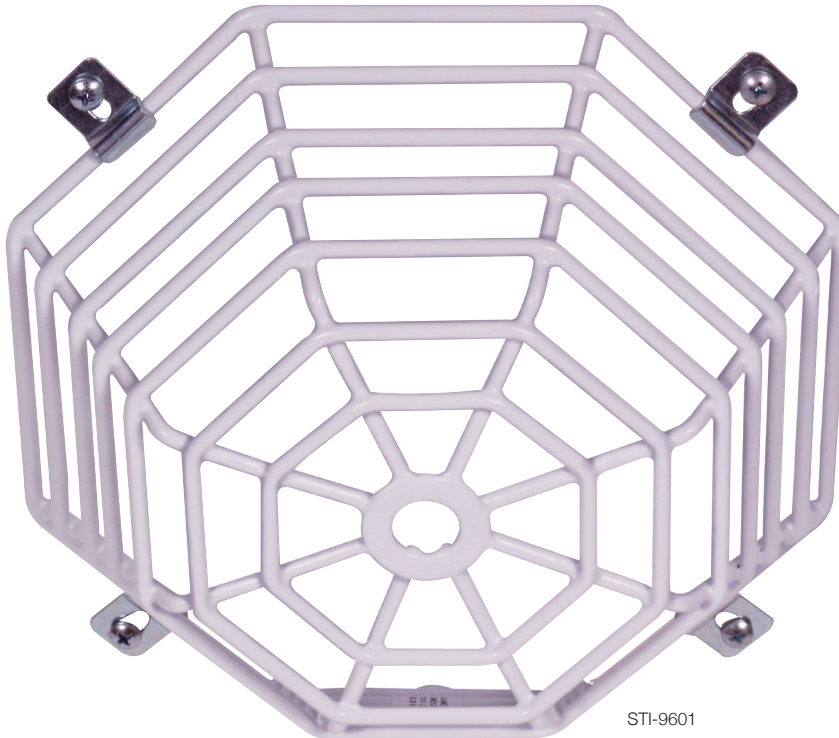

PRODUCT OVERVIEW

STI wire guards provide a reliable solution to help protect smoke detectors against vandalism and accidental impact. Designed with a patented, web-like octagonal structure, these guards are constructed from either corrosion-resistant, coated 9-gauge steel or medical-grade 304 stainless steel, ensuring durability in both standard and sanitary environments. With models to fit virtually all smoke detectors on the market, STI wire guards offer quick installation, easy removal for maintenance, and reliable performance in controlled environments from -40° to 212°F. Approved by UL, CSFM, and MEA, these wire guards deliver high-quality, compliant protection you can trust.

THREE YEAR GUARANTEE

These Steel Web Stoppers are backed by a three year guarantee against breakage in normal use.

KEY FEATURES

General Information

- Helps protect smoke detectors against damage and misuse.
- Universal fit allows models to cover nearly all smoke detectors on the market.
- Suitable for controlled environments from -40° to 212° F (-40° to 100° C) .
- Stainless steel models are ideal for hygienic environments.
- For use in controlled environment (not intended for outdoor use).
- Three year guarantee against breakage in normal use.

Design

- Web-like octagon shape of 9-gauge steel wire makes them extremely difficult to break.

Construction

- Impact-resistant construction protects smoke detectors from vandalism and accidental damage.
- Medical grade 304 stainless steel models are corrosion-resistant with no added coating.
- Steel models feature a corrosion-resistant linear low-density polyethylene (LLDPE) coating.

Installation

- Quick and easy to install.
- Design allows simple removal for routine detector maintenance.

Options

- KIT-82 tamper-resistant hardware available (KIT-19038 recommended if using KIT-82).
- STI-8171 polycarbonate mounting plate recommended for irregular or unstable mounting surfaces, such as drop ceilings and beams.
- Stainless steel versions available for flush mount or surface mount.

STI Steel Web Stoppers®

Dimensions and Technical Information

MODELS AVAILABLE

- STI-9601** Steel Web Stopper, Low Profile - Flush Mount
 - STI-9601-SS** Steel Web Stopper, Low Profile - Flush Mount - Stainless Steel 304
 - STI-9602** Steel Web Stopper, Low Profile - Surface Mount
 - STI-9604** Steel Web Stopper for Mini Smoke Detectors - Flush Mount
 - STI-9604-SS** Steel Web Stopper for Mini Smoke Detectors - Flush Mount - Stainless Steel 304
 - STI-9605** Steel Web Stopper for Mini Smoke Detectors - Surface Mount
 - STI-9605-SS** Steel Web Stopper for Mini Smoke Detectors - Surface Mount - Stainless Steel 304
 - STI-9609** Steel Web Stopper, High Profile - Flush Mount
 - STI-9609-SS** Steel Web Stopper, High Profile - Flush Mount - Stainless Steel 304
 - STI-9610** Steel Web Stopper, High Profile - Surface Mount
 - STI-9712** Steel Web Stopper for Photoelectric Smoke Detector - Surface Mount (not UL Listed)
 - STI-9713** Steel Web Stopper for Photoelectric Smoke Detector - Flush Mount (not UL Listed)
 - KIT-82** Tamper resistant stainless steel screws, #8 X 1 1/2 in. snake eye (quantity 4)
 - KIT-19038** Spanner bit for tamper resistant screws with 5/16 in. hex drive
 - STI-8171*** Polycarbonate mounting backplate for flush and surface mount models. Recommended for irregular and unstable mounting surfaces such as drop ceilings and beams
- *Only used with STI-9601, STI-9601-SS, STI-9602, STI-9609, STI-9609-SS and STI-9610*

APPROVALS & WARRANTY

CERTIFICATIONS AND APPROVALS

- **For Models:** STI-9601, STI-9602, STI-9604, STI-9605, STI-9609 and STI-9610
- **UL 268:** Smoke Detectors for Fire Alarm Systems.
 - UL File Number: S3504
 - Certified for use with UL Listed smoke detectors. Smoke detectors must not be used with detector guards unless the combination has been evaluated and found suitable for that purpose. Refer to the smoke detector installation instructions for compatibility.
- **CSFM:** 7300-1416:0100
- **MEA:** 49-00-E

WARRANTY

Three year guarantee against breakage in normal use.

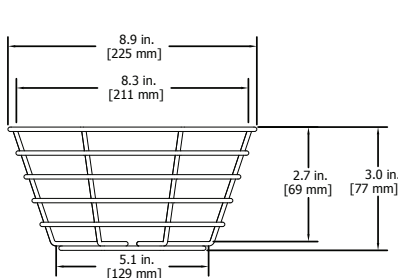

STI-9601
STI-9601-SS

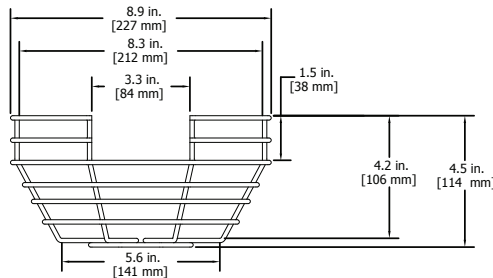

STI-9602

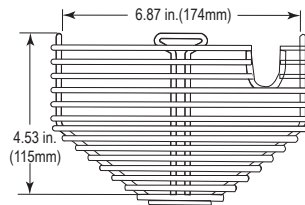

STI-9712

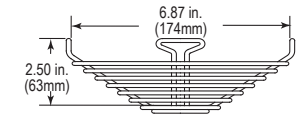

STI-9713

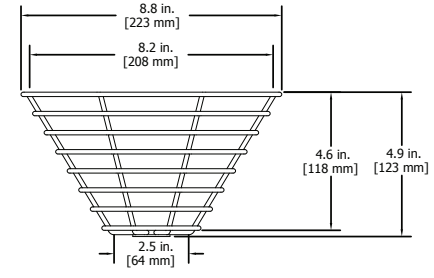

STI-9609
STI-9609-SS

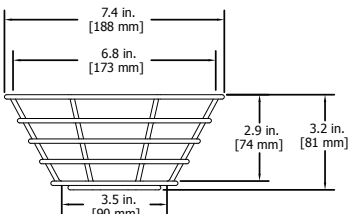

STI-9604
STI-9604-SS

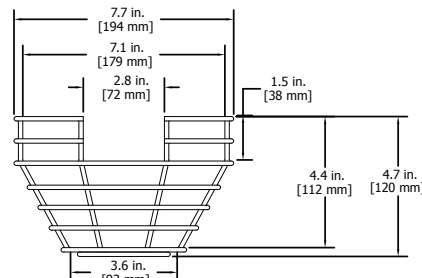

STI-9605
STI-9605-SS

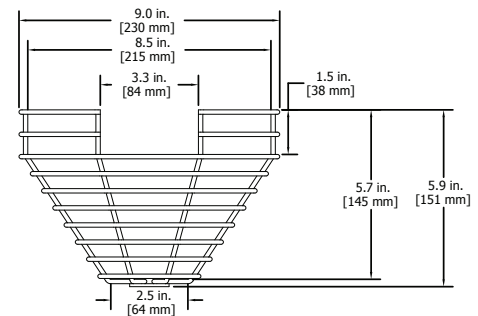

STI-9610



Safety Technology International

2306 Airport Road
Waterford, MI
48327, USA
info@sti-usa.com
www.sti-global.com
Tel: 248-673-9898

Taylor House
34 Sherwood Rd., Bromsgrove,
Worcs., B60 3DR, England

info@sti-emea.com
www.sti-global.com
Tel: +44 (0) 1527 520 999

Unit 7A Lockheed Avenue
Airport Business Park
Waterford X91 HWF2 Ireland