

# 2409/2900 Series

## Fire Guard®



# Table of Contents

## 2409/2900 Series Fire Guard®

Features and Additional Fire Opening Devices . . . . . 3  
 2409 Single-Point Hold Open Applications and Mounting Details. . . . . 4  
 2409 Track Assemblies, Arms and Components . . . . . 5  
 2900 Multi-Point Hold Open Applications. . . . . 6  
 2900 Mounting Details. . . . . 7  
 2900 Hydraulic Hold Open Assemblies, 2900 and 80- Option Adjustable  
 Hold Open Arms and Components . . . . . 8  
 Electrical Accessories . . . . . 9  
 Suggested Architectural Specifications . . . . . 10

### How to Order

Specify	Note	Example
Quantity	Number Ordered	<b>1 Qty.</b>
Series/Function	See Applications	1 Qty. 2991
Voltage	120V or 24V	1 Qty. 2991 <b>24</b>
Hand	Required	1 Qty. 2991 24 <b>RH</b>
Finish	See Finishes	1 Qty. 2991 24 RH <b>EN</b>
Additional Information	Item/Heading Number, Door Number	1 Qty. 2991-24 RH EN X <b>Door 205</b>

### Finishes

US Finish	Descriptions	ANSI/BHMA
EB	Sprayed bronze enamel to match 10B	690
ED	Sprayed black enamel to match 20D	693
EN	Sprayed aluminum enamel	689
EP	Sprayed bronze enamel to match 10	691
EAB	Sprayed brass enamel	696
BSP	Black Suede Powder Coat	—
WSP	White Suede Powder Coat	—

### Application Description & Option Designation

#### Applications:

##### Single Point Hold Open

- 2469 – Pull side, non-handed
- 2479 – Pull side Double Egress, handed
- 2499 – Push side, non-handed

##### Multi-Point Hold Open

- 2960 – Pull side, handed
- 2970 – Pull side Double Egress, handed
- 2980 – Pull side Swing Free, handed
- 2991 – Push side, O arm, handed
- 2992 – Push side, OZ arm, handed
- 2993 – Push side, OZA arm, handed
- 2994 – Push side, OY arm, handed
- 2995 – Push side, OYA arm, handed

#### Options

- Adjustable hold open bypass switch allows hold open from 20° through full door opening. Not available for 2980 units

#### No Option

- Stand Alone unit for use with fire alarm system

Copyright © 2004-2024, SARGENT Manufacturing Company. All rights reserved. Reproduction in whole or in part without the express written permission of SARGENT Manufacturing Company is prohibited. Patent pending and/or patent www.assaabloyds.com/patents.

### On The Cover

2469 Pull Side

# Features

## 2409/2900 Series Fire Guard®

The SARGENT FIRE GUARD® (2409 & 2900) Series of Electromechanical Closer-Holder Release Devices are designed to hold open fire and smoke rated doors until power is interrupted by a fire alarm condition or remote release switch. Designed for durability, ease of installation and aesthetics, each series provides the means to achieve fire and building code compliance without interfering with normal building operation.

Each series includes an ANSI/BHMA A156.4 Grade 1 hydraulic door closer, for proper operation during the opening and closing cycles. They are also applicable for use on non-rated doors such as offices and conference rooms where the convenience of an electrically controlled release device is desirable.

### 2409/2900 Common Features

- Conforms to standards UL 10C Positive Pressure Fire Tests of door assemblies
- UL Listed and cUL Listed to Canadian Safety Standards for use on fire doors
- Available in 5 finishes
- **Holder**
  - Fail safe operation
  - Push or pull or double egress installations
  - Will accommodate concealed or surface wiring standard
- Operating voltages: 24VAC/24VDC, or 120VAC @ .09 Amp.
- Terminal strip for ease of wiring
- Remote release option
- 2 year limited warranty on electromechanical components
- **Closer**
  - ANSI/ BHMA A156.4 Grade 1 Closer
  - Rack and pinion operation
  - Body is cast, one piece high strength aluminum/silicon alloy
  - Full size 1/8" (3mm) brass adjusting valves
  - Adjustable spring power
  - Adjustable closing and latching speeds
  - Adjustable backcheck (Auxiliary door stop required)
  - 10 year limited warranty on 351 closer body

### Additional Fire Opening Release Devices

In addition to the 2409 and 2900 Fire Guard Series, SARGENT offers other alternatives for door holding/releasing devices that may be more appropriate to your application. All are UL Listed for fire door assemblies and readily interconnect with building fire protection systems.

Any retrofit or other field modification to a fire rated opening can potentially impact the fire rating of the opening, and Sargent Manufacturing Company makes no representations or warranties concerning what such impact may be in any specific situation. When retrofitting any portion of an existing fire rated opening, or specifying and installing a new fire-rated opening, please consult with a code specialist or local code official (Authority Having Jurisdiction) to ensure compliance with all applicable codes and ratings.

### 351 EHT Closer-Holder Devices

Designed to hold open fire or smoke doors until released by the fire detection system, the 351 EHT provides a convenient means of meeting fire and building code requirements without interfering with normal building operation. The 351 EHT Closer-Holder combination allows the door to be normally held open, but is self-closing when power is interrupted during an emergency or by switch control. With its rugged track design, the 351 EHT is suitable for multiple manual operations. See 351 EHT Closer-Holder Release catalog for complete application information.



### 1560 Series Electromagnetic Door Holders

The 1560 Series of Electromagnetic Door Holders are Fail Safe devices designed to hold open self closing smoke and fire doors until released by a fire protection or other control system. Holders are available in surface and flush mount designs and are well suited for applications where there is insufficient space for Fire Guards or the 351 EHT Closer-Holder. See Holder and Stops Catalog for complete information.



1561 Flush Mount    1560 Surface Mount

### Overhead Stops

A complete line of Overhead Stops is available to complement the Fire Guard, 351 EHT and 1560 Holders. They limit door opening and prevent damage to the closer-holder, trim or surrounding walls. Full information may be found in the Holder and Stops catalog.



# 2409 Series Single Point Hold Open Applications and Mounting Details

## 2409/2900 Series Fire Guard®



### Features of 2409 Series

- Single point hold open
- Hold open position adjustable from 85° to 110°
- Easy adjustment
- Adjustable holding power
  - Acts like standard door closer until opened to the hold open point
  - Maintains open position until released
- Auxiliary stop required
- Long wearing adjusting rod assembly
- Cover projection only 2-3/16" (81mm)
- High impact, corrosion resistant cover secured by machine screws
- Remote release option
- Holder: Aluminum track will accommodate concealed or surface wiring
- Closer: Cover projection 2-3/16" (56mm) max.

### Applications

- 351-A Mounting Plate may be used for door with narrow top rail (pull application)
- 351-D Drop Bracket may be used for door with narrow top rail (push application)
- Suitable reinforcements required for metal door and frames
- Minimum frame face required 2" (51mm)

### 2469 Pull Side



- Track is mounted to face of frame
- The 351 closer is mounted to hinge side of door
- Use on corridor or stairwell doors when pull side, single-point hold open is required
- Non-handed

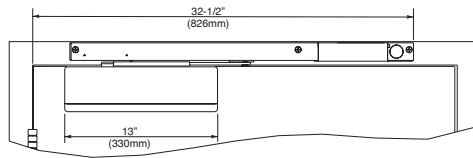

Minimum Door Size
28" (711mm)

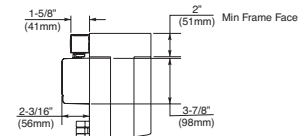

### 2479 Pull Side - Double Egress



- Track is mounted to face of frame
- The 351 closer is mounted to hinge side of door
- Use on double egress openings when pull side hold open is required
- Double egress arm for reveal of 1/8" (3mm) to 3" (76mm) maximum
- Handed

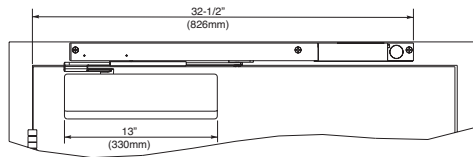

Minimum Door Size
28" (711mm)

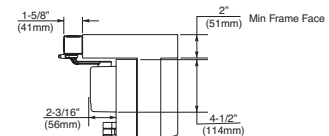

### 2499 Push Side



- Track is mounted to underside of the frame stop
- The 351 closer is mounted to stop side of door
- Use on corridor or stairwell doors where push side, single-point hold open is required
- Non-handed

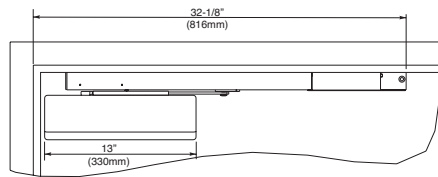

Minimum Door Size
36" (914mm)

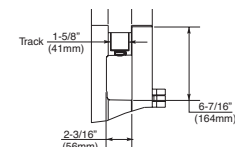

Copyright © 2004-2024, SARGENT Manufacturing Company. All rights reserved. Reproduction in whole or in part without the express written permission of SARGENT Manufacturing Company is prohibited. Patent pending and/or patent www.assaabloyds.com/patents.

90133 03/24

# 2409 Series Single-Point Hold Open Assemblies, Arms & Components

## 2409/2900 Series Fire Guard®

### Assemblies

#### 2409 Series Stand Alone Unit

- Can be installed on a single door or a pair of doors when controlled by compatible UL Listed Fire Detection equipment or non-rated doors with remote release
- Includes electromagnetic hold open mechanism



### Arms & Components

- Regular and double egress telescoping arms
- All applications use track principle
- Powder coated

#### 63-2874\* Link Insert & Extension

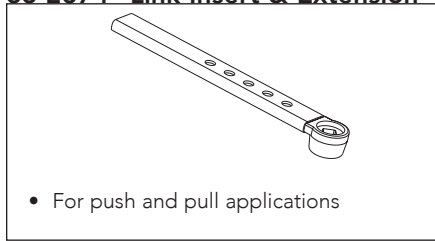

#### 63-0840\* Adjusting Rod Assembly

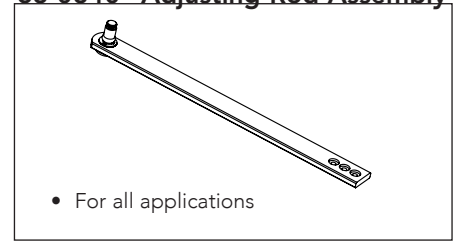

#### 63-3057\* Double Egress Arm and Extension Assembly

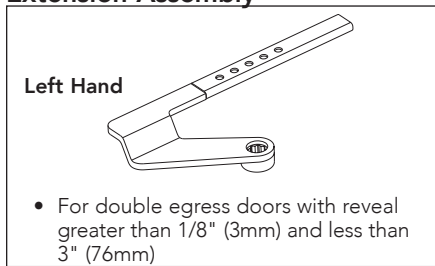

#### 63-3056\* Double Egress Arm and Extension Assembly

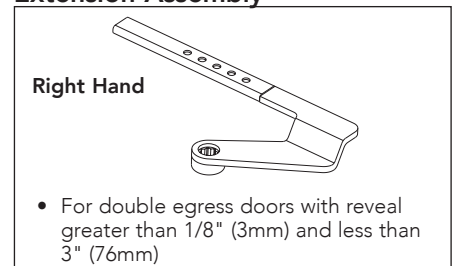

#### 351-A\* Mounting Plate

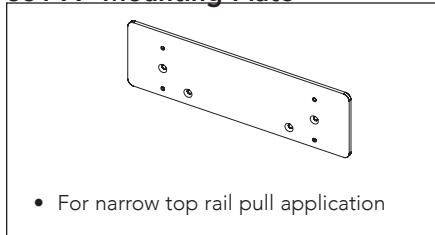

#### 351-D\* Drop Bracket

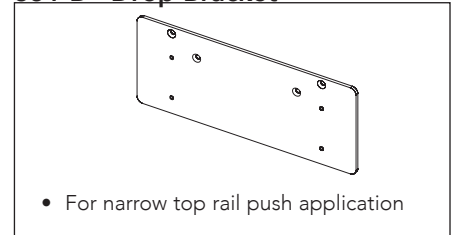

#### 13-351 Closer Body

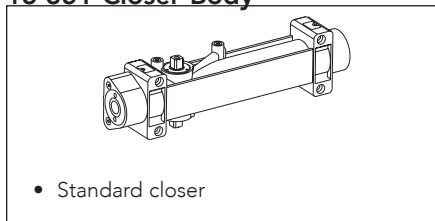

#### 351-C\* Plastic Cover

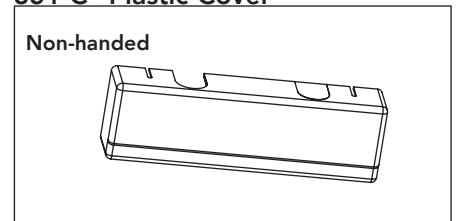

#### Notes:

Screw Pack for all models, 63-3431

Specify finish when ordering arms or components.

\* Finish must be specified: EB, ED, EN, EP and EAB

# 2900 Series Multi-Point Hold Open Applications

## 2409/2900 Series Fire Guard®

**SARGENT**  
**ASSA ABLOY**

### Features of 2900 Series

- Multi position hydraulic hold open
- Delayed, adjustable hold open 80- option
- Hold open positions from 10° to 170° (trim permitting)
- Reveals up to 8-5/8" (219mm) push side
- Swing free application available (pull side)
- Holder Operation
  - Multi-point hold open from 70° to 170°, trim permitting
- Steel mounting plate accommodates surface or concealed wiring
- Handed
- Auxiliary stop required
- Projection 2-9/16" (65mm) from frame face
- Metal cover secured by machine screws
- Steel mounting plate
- Remote release option
- Maintained on/off switch
- Maximum door opening 180°

#### Arms

- Regular type for push side
- Track type for pull side and swing free
- Double Egress, Track type for Pull side

### 2960 Pull Side

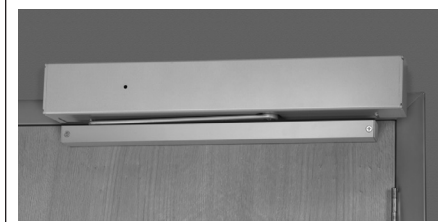

- Closer/Holder is mounted to face of frame
- Track is mounted on surface of door, hinge side
- Use on corridor, stairwell doors and labeled doors which require over 110° opening

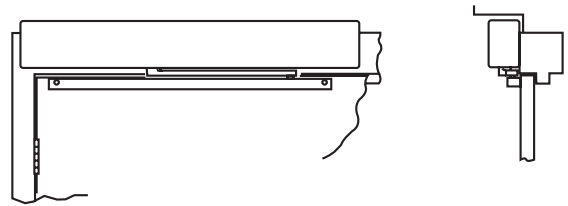

### 2970 Pull Side-Double Egress

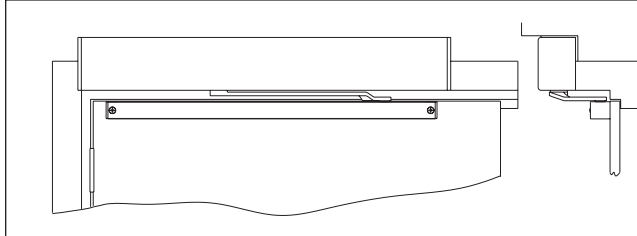

- Closer/Holder is mounted to face of frame
- Track is mounted on hinge side of door
- Double egress arm for reveal of 1/8" (3mm) to 3" (76mm) maximum
- Use on corridor or stairwell doors when pull side, multi-point hold open is required

### 2980 Pull Side - Swing Free

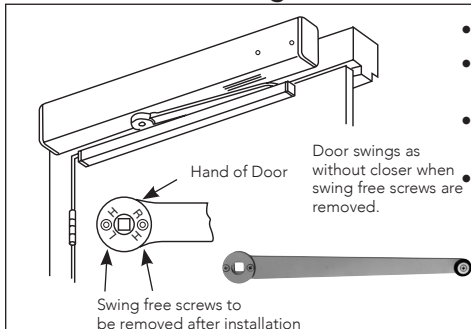

- Closer/Holder is mounted to face of frame
- Track is mounted on surface of door, hinge side
- Door acts as if no closer is installed or swings free until the alarm is activated
- Use on patient room doors in hospitals, nursing homes or anywhere a bedroom-like atmosphere is required



### 2990 Push Side



- Closer/Holder is mounted to face of frame on push side
- Arm is secured to surface of door, stop side
- Use on corridor, stairwell doors and labeled doors which require over 110° opening

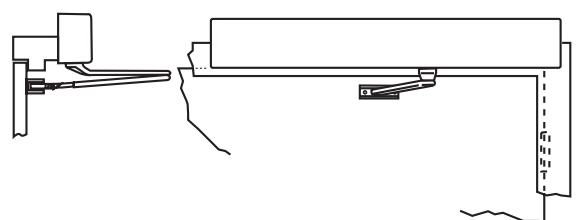

# 2900 Series Multi-Point Hold Open Mounting Details

2409/2900 Series Fire Guard®

**SARGENT**  
**ASSA ABLOY**

## 2960, 2980 Pull Side

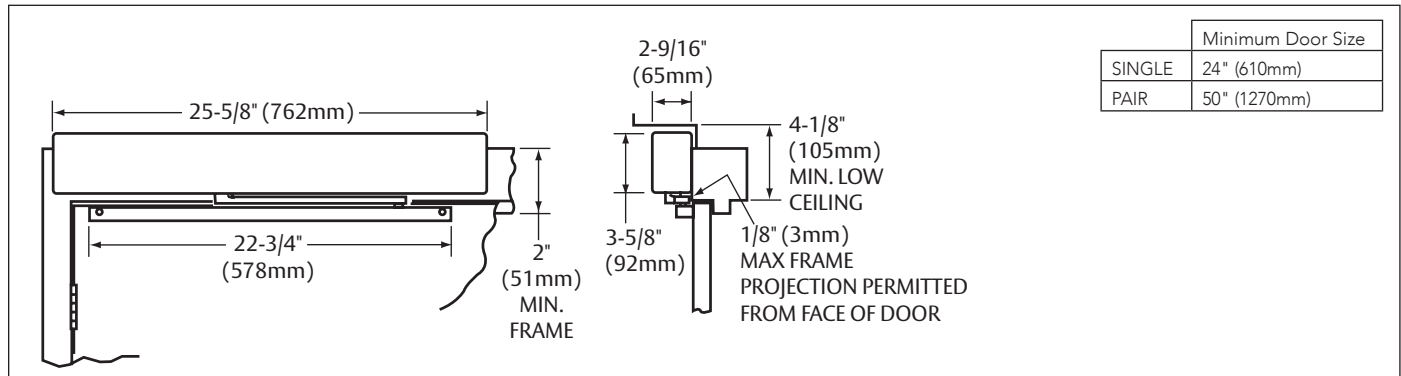

## 2970 Pull Side–Double Egress

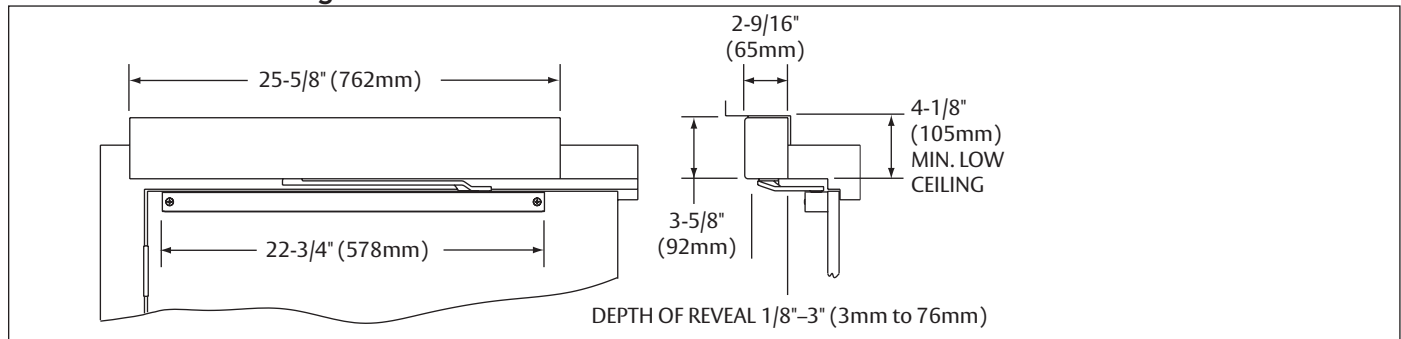

## 2990 Push Side

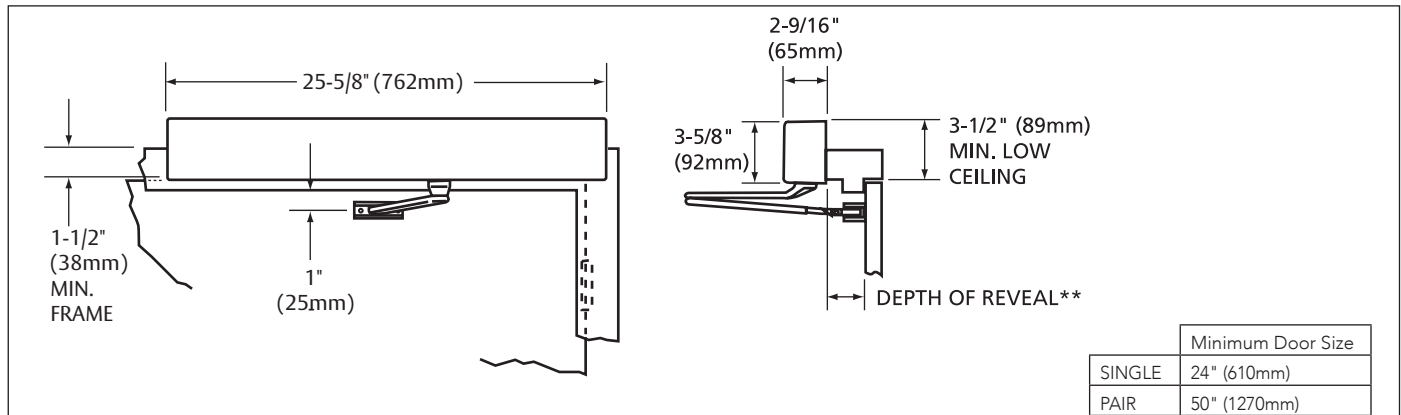

### ARM ASSEMBLY REQUIREMENTS FOR 2990 UNITS

DEPTH OF REVEAL**	CATALOG NUMBER	ARM ASSEMBLY REQUIRED	MAXIMUM	
			DOOR OPENING	RANGE OF HOLD OPEN
0 to 1-3/4" (45mm)	2991	"O" Arm	180°	10° to 170°
1-7/8" (48mm) to 4" (102mm)	2992	"OZ" Arm	180°	10° to 170°
4-1/8" (105mm) to 7" (178mm)	2993	"OZA" Arm	160°	10° to 150°
4-1/8" (105mm) to 7" (178mm)	2994	Heavy duty "OY" Arm	180°	10° to 170°
7-1/8" (203mm) to 8 5/8" (219mm)	2995	Heavy duty "OYA" Arm	180°	10° to 170°

# 2900 Series Multi-Point Hold Open 80- Option Adjustable Hold Open Arms & Components

2409/2900 Series Fire Guard®

**SARGENT**  
**ASSA ABLOY**

## 2900 Series Stand Alone Unit

- Includes hydraulic hold open device.
- Can be installed on a single door or a pair of doors when controlled by compatible UL listed Fire Detection equipment or 120VAC

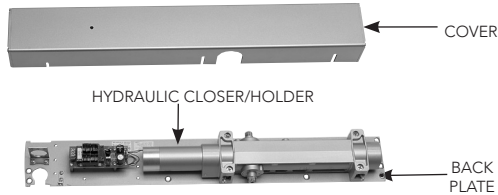

## 80- Option Adjustable Hold Open By-Pass Switch

- Allows initial degree hold open position to be adjusted from 20° through full door opening
- Used on Pull side (2960 or 2970) or Push side (2990) units
- Not available with 2980 Series units

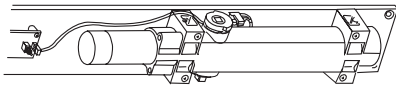

Switch is on opposite spindle from closer arm.

## 63-2216\* O Foot Assembly



- For reveals up to 1-3/4" (44mm)

## 63-3314\* OY Arm Assembly



- Heavy duty for reveals from 4-1/8" to 7" (105 to 178mm)  
180° opening

## 63-2217\* OZ Foot Assembly



- For reveals up to 1-7/8" (102mm) to 4" (102mm)

## 63-3315\* OYA Arm Assembly



- Heavy duty for reveals from 7-1/8" to 8-5/8" (203 to 219mm)  
180° opening

## 63-2218\* OZA Foot Assembly



- For reveals from 4-1/8" to 7" (105-178mm)

## 63-2607\* Main Arm and Link Assembly



- Used with O, OZ and OZA Foot Assemblies

## 63-3688\* Slide Arm Assembly



- 2960 Series rigid arm

## 63-0156\* Track Only



- Used with double Egress arm above  
63-0682 Track Cap,  
2 required

## 63-3689\* Slide Arm Assembly (Swing Free)

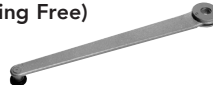

- Allows door to open and close with no closer spring pressure

## 63-3653\* Double Egress Arm



- Left Hand Shown
- Right Hand 63-3654 Not Shown

## 63-3717\* Cover

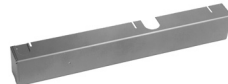

- Cover used with 2900 shown

## Notes:

Screw Pack for 2960 and 2980 models, 63-3700  
Specify finish when ordering arms or components  
Finishes: EB, ED, EN, FP and EAB

\* Finish must be specified: EB, ED, EN, EP and EAB



### Power Input Connections

#### 63-2868 Remote Connector Harness

- Harness for connection to circuit board of remote door release control
- **Required for remote release**

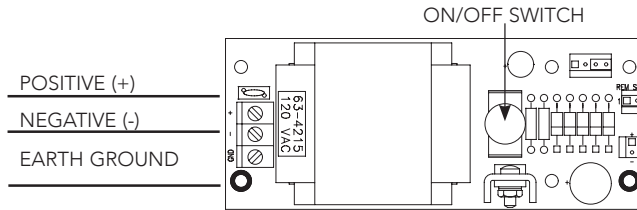

### Switches and Printed Circuit Boards

When remote release is required, SARGENT offers both key and push button switches to interrupt power allowing the door to close. Consult Product System Manual for other switch options.

#### 4370 Key Switch



- Allows remote or local release
- Switch rating: SPDT maintained contact 4 Amp. @ 24VDC
- Size 41 mortise cylinder (1-1/8" [29mm] length of shell)
- Finish: 32D

#### 63-4215 PC Board (2900 only)

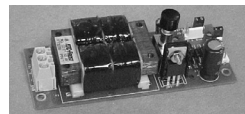

- Replacement 120 Volts AC board assembly

#### 63-0848 PC Board (2409 only)



- Replacement 120 Volts AC board assembly

#### 63-4216 PC Board (2900 only)

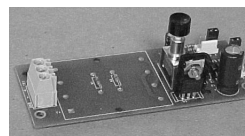

- Replacement 24 Volt AC/DC board assembly

#### 63-0847 PC Board (2409 only)

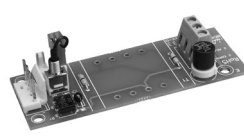

- Replacement 24 Volt AC/DC board assembly

### 12VDC & 24VDC Power Supplies



- UL Class 2 Listed
- Four 12V models and four 24V models available
- Integral battery charging capability keeps sealed lead acid gel/cell at full charge in case of line voltage failure (737-battery sold separately)
- Fused line voltage input with one, four, or eight DC outputs (depending on model)
- Each circuit can be individually turned on and off via a slide switch; the power status of each is shown by an LED.
- In the event of a DC short the problem is confined to the zone of difficulty
- Fire alarm interface standard

SARGENT MODEL No.	DESCRIPTION
3521	12V - 1 AMP POWER SUPPLY
3541	12V - 3 AMP POWER SUPPLY
737	12V - 5 AMP HOUR BACKUP BATTERY

SARGENT MODEL No.	DESCRIPTION
3520	24V - 1 AMP POWER SUPPLY
3540	24V - 2 AMP POWER SUPPLY
3550	24V - 4 AMP POWER SUPPLY
3570	24V - 6 AMP POWER SUPPLY
738	24V - 5 AMP HOUR BACKUP BATTERY

### Architectural Specifications

#### 2.0 SINGLE-POINT CLOSER HOLDER RELEASE DEVICES

- A. Single-point door closer holder release devices shall be 2409 Series as manufactured by SARGENT Manufacturing Company.
- B. Door closer holders shall meet ANSI/BHMA A156.15 requirements.
- C. Provide door closer holders to hold doors open under normal use conditions and to release and close door upon receiving a signal from fire alarm, or manually by pushing or pulling the door.
- D. Door closer holders shall be UL listed (US and Canada) for use on fire doors.
- E. Door closer bodies:
  - 1. One piece door closer body shall be die cast aluminum alloy with 14% silicon minimum content.
  - 2. Door closer body shall meet the requirements of ANSI Grade 1 per ANSI/BHMA A156.4.
  - 3. Door closer body shall be fully closed rack and pinion construction.
- 4. Separate adjustable closing speed, latching speed, and backcheck shall be controlled by key operated valves with no less than one eighth inch hex.
- 5. Valves shall be captivated and non-critical.
- 6. Closer cover shall be constructed of high impact plastic material of flame retardant grade secured by machine screws.
- 7. Door closer body shall meet the requirements of UL 10C positive pressure fire tests.
- 8. Door closer body shall have a ten year limited warranty.
- F. Electro-mechanical holder release track assembly:
  - 1. Devices shall include an integral, fully-adjustable hold-open mechanism.
  - 2. Track assembly will accommodate operating voltages of either 24VAC or 24VDC in the same unit or 120VAC as an option.
- 3. Single-point hold open shall be adjustable from 85 to 110 degree of door opening.
- 4. Track assembly shall include a terminal strip for ease of installation.
- 5. Circuit board shall contain a self-resetting circuit breaker switch.
- 6. Track assembly shall include an on/off switch to control hold-open.
- 7. Two year limited warranty.
- G. Door closer holders shall accommodate concealed or surface wiring standard.
- H. Door closer holders shall have universal push or pull application.

#### 2.0 MULTI-POINT CLOSER HOLDER RELEASE DEVICES

- A. Multi-point door closer holder release devices shall be 2900 Series as manufactured by SARGENT Manufacturing Company.
- B. Door closer holders shall meet ANSI/BHMA A156.15 requirements.
- C. Provide door closer holders to hold doors open under normal use conditions and to release and close door upon receiving a signal from fire alarm, remote release switch, or manually by pushing or pulling the door.
- D. Door closer holders shall be UL listed (US and Canada) for use on fire doors.
- E. Door closer bodies with integrated hydraulic hold open mechanism:
  - 1. One piece door closer body shall be die cast aluminum alloy with 14% silicon minimum content.
- 2. Door closer body shall meet the requirements of ANSI Grade 1 per ANSI/BHMA 156.4.
- 3. Door closer body shall be fully closed rack and pinion construction.
- 4. Separate adjustable closing speed, latching speed, and backcheck shall be controlled by key operated valves with no less than one eighth inch hex.
- 5. Valves shall be captivated and non-critical.
- 6. Cover shall be constructed of aluminum extrusion with plastic end caps secured by machine screws.
- 7. Door closer body shall meet the requirements of UL 10C positive pressure fire tests.
- 8. Devices shall accommodate operating voltages of either 24VAC or 24VDC in the same unit or 120VAC as an option.
- 9. Multi-point hold open shall be adjustable from 10 to 170 degree of door opening.
- 10. Devices shall include a terminal strip for ease of installation.
- 11. Circuit board shall contain a self-resetting fuse.
- 12. Devices shall include an on/off switch to control hold-open.
- 13. Delayed adjustable hold-open shall be available as an option (80-option).
- 14. Two year limited warranty.
- F. Door closer holders shall accommodate concealed or surface wiring standard.
- H. Door closer holders shall be available in push or pull application for regular or double egress type doors.



The ASSA ABLOY Group is the global leader in access solutions. Every day, we help billions of people experience a more open world.

ASSA ABLOY Opening Solutions leads the development within door openings and products for access solutions in homes, businesses and institutions. Our offering includes doors, frames, door and window hardware, mechanical and smart locks, access control and service.

**SARGENT**<sup>®</sup>  
**ASSA ABLOY**

SARGENT Manufacturing Company  
100 Sargent Drive  
New Haven, CT 06511 USA  
800-727-5477  
[www.sargentlock.com](http://www.sargentlock.com)

Founded in the early 1800s, SARGENT<sup>®</sup> is a market leader in locksets, cylinders, door closers, exit devices, electro-mechanical products and access control systems for new construction, renovation, and replacement applications. The company's customer base includes commercial construction, institutional, and industrial markets.

Copyright © 2004-2024, SARGENT Manufacturing Company. All rights reserved. Reproduction in whole or in part without the express written permission of SARGENT Manufacturing Company is prohibited. Patent pending and/or patent [www.assaabloydss.com/patents](http://www.assaabloydss.com/patents).

90133 03/24