

30 Series

Exit Device

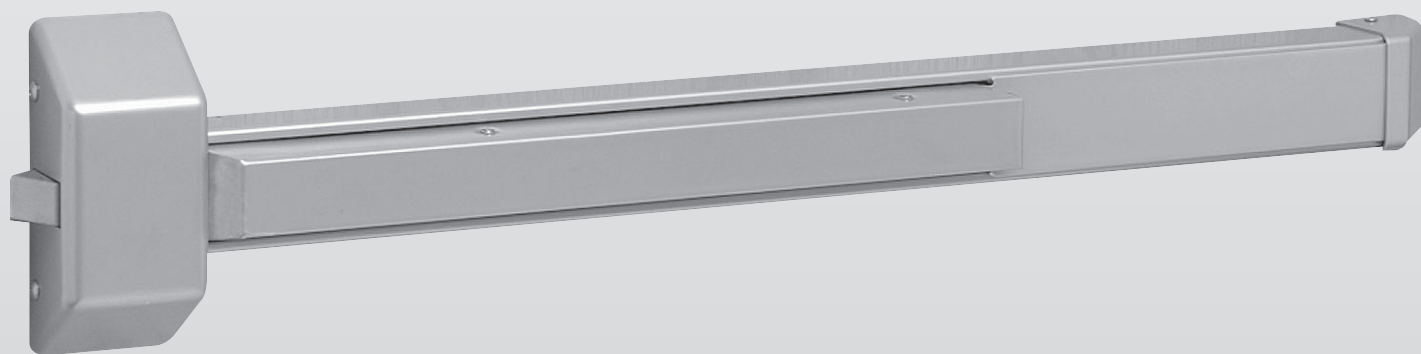

Table of Contents

30 Series Exit Device

Features, Applications and UL Fire Door Ratings	3
3727/ NB3727 Vertical Rod Type Exit Device.	4
3828 Rim Type Exit Device.	5
30 Series Trims	6
Alternate Strikes and Shim Kits.	7
Mullions and Door Kits	8
Mechanical and Cylinder Options	9
Cylinder Options	10
Ordering Information, Rail Sizes and Finishes.	11
Architectural Specifications and How To Order	12

Copyright © 1999-2024, SARGENT Manufacturing Company. All rights reserved. Reproduction in whole or in part without the express written permission of SARGENT Manufacturing Company is prohibited. Patent pending and/or patent www.assaabloydss.com/patents.

On The Cover

- SARGENT 3828 Rim Exit Device with EN Finish

Features, Applications and UL Fire Door Ratings

30 Series Exit Device

Applications

Features

- Rugged exit device in surface vertical rod and rim designs
- Chassis mounted unit construction assures easy installation and maintenance
- Tapered push rail and angled covers
- Steel endcaps and covers
- Up to five functions with a variety of trim
- All exit devices meet ANSI/BHMA Standard 156.3, Grade 1
- UL Listed
- UL Listed to Canadian safety standards
- Available as Fire Exit Hardware (12-)

Single Door

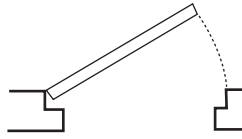

Vertical Rod Type 3727 / NB3727
Surface applied 2 / 1 point lock.
Rim Type 3828
Surface application.

Pairs of Doors without Mullion

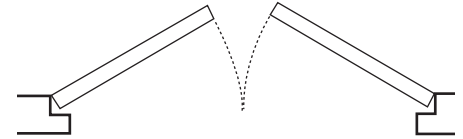

Vertical Rod Type 3727 / NB3727 - 2 Each
Surface applied 2 / 1 point locking both doors. Each door active. Do not use an overlapping astragal.

Pairs of Doors with 980 Mullion

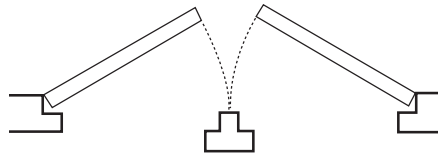

Rim Type 3828 - 2 Each
980 Mullion - 1 Each
Two independent active doors with full double door opening when required.

Pairs of Doors without Mullion

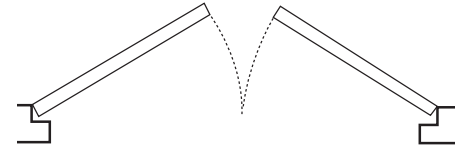

Vertical Rod Type 3727 / NB3727 - 1 Each
Rim Type 3828 - 1 Each
Both devices are surface applied. A coordinator is required.

Maximum Door Openings & UL Fire Door Ratings

For available functions and outside trim, see charts for regular exit devices

Application & Type	Regular Design	Maximum Door Opening	UL Fire Door Rating				
			(A) 3 Hour	(B) 1 1/2 Hour	(B) 1 1/2 Hour	(D) 1/2 Hour	(E) 3/4 Hour
Single Doors Rim Type	12-3828	4'0" X 8'0" (1219mm X 2438mm)	•	•	•	•	•
Pair of Doors Two Surface Mounted Vertical Rod Type - Swinging in same direction	*12-3727 x *12-3727 *12-NB3727 x *12-NB3727	8'0" X 8'0" (2438mm X 2438mm)	•	•	•	•	•
Two Rim Type with 12-980 Mullion	12-3828 x 12-3828	8'0" X 8'0" (2438mm X 2438mm)	•	•	•	•	•
Two Surface Mounted Vertical Rod Type - Swinging in opposite directions	12-3727 x 12-3727	8'0" X 8'0" (2438mm X 2438mm)	•	•	•	•	•
	12-NB3727 x 12-NB3727 [^]		•	•	•	•	•

Note: Please contact door manufacturer for specifications regarding fire door construction

*Limited for fire doors listed by UL for this use. NFPA requires an astragal on 3 hour applications. Vertical rod application will not work with astragal.

[^] Thermal pins required, 2 pins per set, 1 per door.

Any retrofit or other field modification to a fire rated opening can potentially impact the fire rating of the opening, and Sargent Manufacturing Company makes no representations or warranties concerning what such impact may be in any specific situation. When retrofitting any portion of an existing fire rated opening, or specifying and installing a new fire-rated opening, please consult with a code specialist or local code official (Authority Having Jurisdiction) to ensure compliance with all applicable codes and ratings.

3727 / NB3727 Vertical Rod Type Exit Device

30 Series Exit Device

SARGENT
ASSA ABLOY

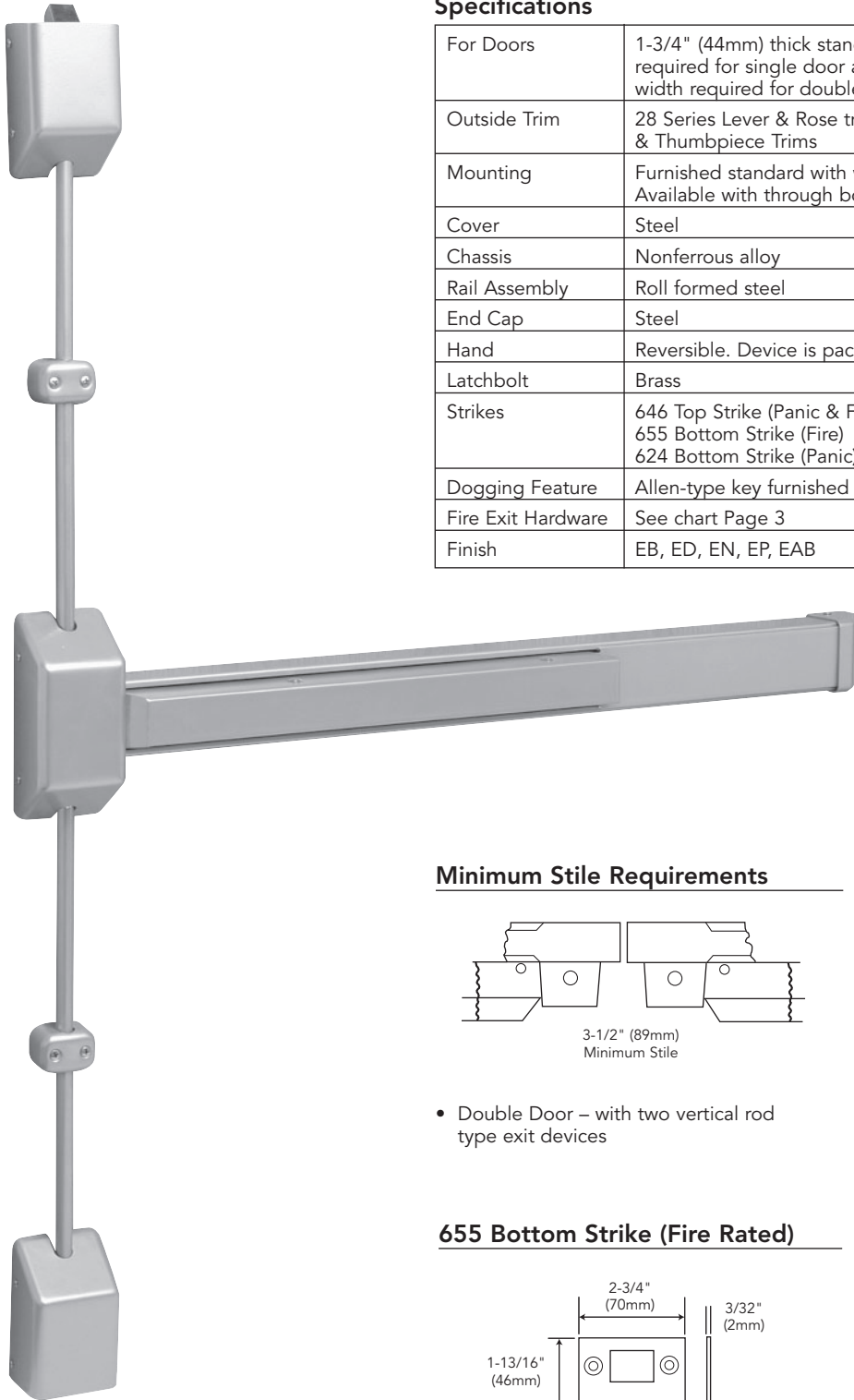

Specifications

For Doors	1-3/4" (44mm) thick standard. 3-3/4" (95mm) minimum stile width required for single door application. 3-1/2" (89mm) minimum stile width required for double door application. Standard AFF is 41"
Outside Trim	28 Series Lever & Rose trims, GTB/HTB Pulls & Plates, OB Knob trims & Thumbpiece Trims
Mounting	Furnished standard with wood and machine screws Available with through bolts and mortise nuts
Cover	Steel
Chassis	Nonferrous alloy
Rail Assembly	Roll formed steel
End Cap	Steel
Hand	Reversible. Device is packed standard LHRB
Latchbolt	Brass
Strikes	646 Top Strike (Panic & Fire) 655 Bottom Strike (Fire) 624 Bottom Strike (Panic)
Dogging Feature	Allen-type key furnished standard (Non Fire Rated Devices Only)
Fire Exit Hardware	See chart Page 3
Finish	EB, ED, EN, EP, EAB

The 3727/NB-3727 Multi-function SVR Exit Device is the perfect stocking device.

- 6 functions determined by trim selected
- Device & trim sold separately; easy to mix and match
- 4 available trim designs

Order as an 3727 followed by rail size, opening, AFF and finish

Minimum Stile Requirements

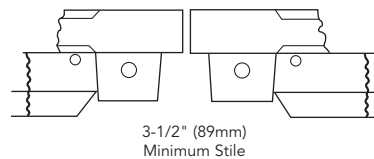

- Double Door – with two vertical rod type exit devices

646 Top Strike

- Standard for both Panic & Fire (12-) Hardware with or without bottom rod
- Surface applied to frame
- Black nylon coated

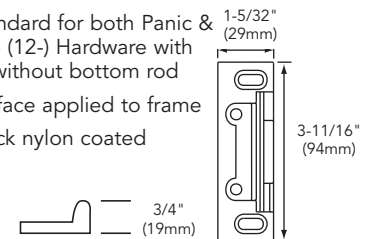

655 Bottom Strike (Fire Rated)

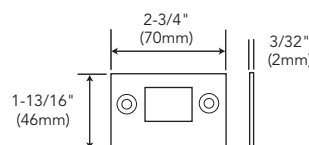

- Standard for 12-
- Stainless steel
- Black nylon coated

624 Bottom Strike (Panic)

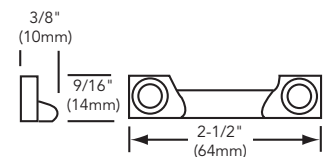

- Standard for 3727
- Applied to surface of floor or to a flat threshold
- Black nylon coated

Copyright © 1999-2024, SARGENT Manufacturing Company. All rights reserved. Reproduction in whole or in part without the express written permission of SARGENT Manufacturing Company is prohibited. Patent pending and/or patent www.assaabloydss.com/patents.

90126 01/24

3828 Rim Type Exit Device

30 Series Exit Device

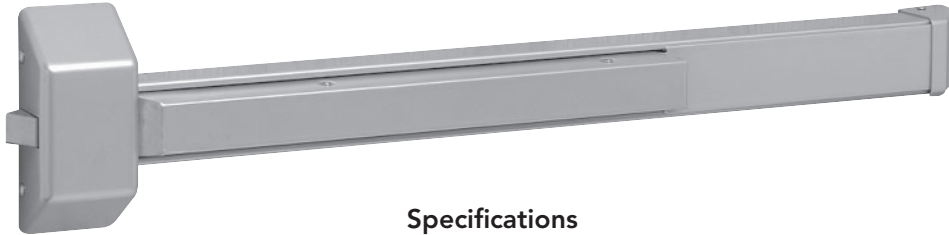

Specifications

For Doors	1-3/4" (44) thick standard. 4-1/2" (114mm) minimum stile width required for single or double door application using standard 649 strike
Outside Trim & Thumbpiece Trims	28 Series Lever & Rose trims, GTB/HTB Pulls & Plates OB Knob trims
Mounting	Furnished standard with wood and machine screws Available with through bolts and mortise nuts
Cover	Steel
Chassis	Nonferrous alloy
Rail Assembly	Roll formed steel
End Cap	Steel
Hand	Non handed
Latchbolt	Stainless steel 3/4" (19mm) throw
Strike	649 packed standard
Dogging Feature	Allen-type key furnished standard (non fire rated devices only)
Fire Exit Hardware	See chart Page 3
Finish	EB, ED, EN, EP, EAB

The 3828 Multi-function Rim Exit Device is the perfect stocking device.

- 7 functions determined by trim selected
- Device & trim sold separately; easy to mix and match
- 4 available trim designs

Order as an 3828 followed by rail size and finish

649 Strike

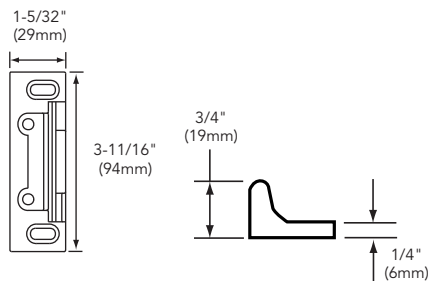

- Surface applied
- Standard & Fire Rated
- Strikes are black nylon coated

Minimum Stile Requirements

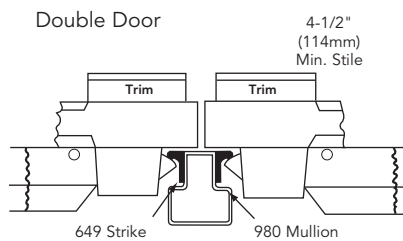

Minimum Stile Requirements

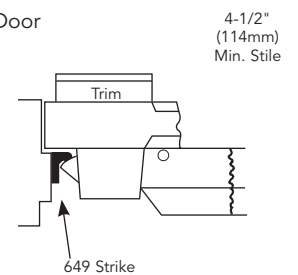

30 Series Trims

30 Series Exit Device

The trim function determines the function of the exit device. All 28 Series trims work with all 30 Series Exit Devices, except where noted.

Note: All trims and exit devices are ordered and packaged separately.

28 Series Lever & Rose Trim for 3727/3828 Series Exit Devices



Lever & Rose Trim

- For 1-3/4" (44mm) doors only
- Functions available for 04, 06, 10, 13 & 15
- Not handed
- Finishes: 03, 04, 10, 10B, 10BE, 20D, 26D, BSP & WSP
- Lever designs available: "L", "B", "P"

To order specify 28 followed by the function Trim will not retrofit on devices purchased prior to 2000. Consult factory.

(K, N, D, C or L), the rose (L), the lever (L, B or P) and finish

Example: 28-K-LL x 26D

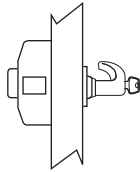

28-K-LL Night Latch

Key in lever retracts latchbolt.

04 Function For 3828 only (ANSI 03)

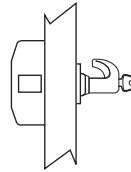

28-N-LL Night Latch

Lever operates only when key is in cylinder and turned.

06 Function (ANSI 09)

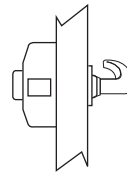

28-D-LL Dummy

Lever rigid at all times & no outside function.

10 Function (ANSI 02)

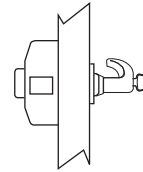

28-C-LL Entrance

Key in lever locks or unlocks lever.

13 Function (ANSI 08)

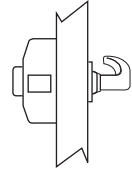

28-L-LL Passage

Latchbolt operated by lever.

No Cylinder 15 Function (ANSI 14)

28 Series GTB/HTB Pulls & Plates for 3727/3828 Series Exit Devices



810-GTB



802-GTB



814-HTB

- For 1-3/4" (44mm) doors standard
- Through-bolted with 3 mortise nuts
- Pulls project 1-1/2" (38mm) from door face
- GTB Design trim will cover a 161 cutout
- Trim ordered separately.
- Finishes: EN, EB, ED, EP & EAB
- For cylinder operation only with no trim (Specify 3828 x 34 rim cylinder x Finish)

To order specify: trim design and finish

Example: 814-HTB x EN

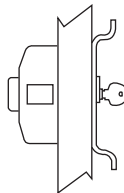

814-HTB Night Latch

Outside by pull and key. (3828 only)

04 Function (ANSI 03)

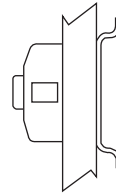

810-GTB Exit Only with Pull

Outside pull when push bar is locked down.

10 Function (ANSI 02)

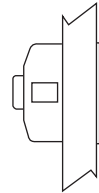

802-GTB Exit Only

Blank plate to cover 161 cutout.

10 Function (ANSI 01)

28 Series Thumbpiece Trim for 3727/3828 Series Exit Devices



- Finishes: EN, EB, ED, EP & EAB
- *1 3/4" Door Only

28 Series OB Knob Trim for 3727/3828 Series Exit Devices



- For 1-3/4" (44mm) doors only
- Functions available for 04, 13 and 15
- Non-handed
- Finishes: 26D

To order specify 28 followed by the function (K, C or L), the rose (O), the knob (B) and finish

Example: 28-K-OB x 26D

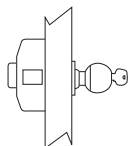

28-K-OB Night Latch

Key in knob retracts latchbolt.

3828 only 04 Function (ANSI 03)

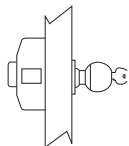

28-C-OB Entrance

Key in knob locks or unlocks knob.

13 Function (ANSI 08)

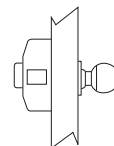

28-L-OB Passage

Latchbolts operated by knob.

No Cylinder 15 Function (ANSI 14)

866-TP

Key locks or unlocks thumbpiece. **(63)**

814-TP

Key retracts latchbolt. (3828 ONLY) **(04)**

To order specify: trim design and finish
Example: 866-TP x EN

Alternate Strikes and Shim Kits

30 Series Exit Device

Alternate Strikes

613 Strike (Alternative for 3828)

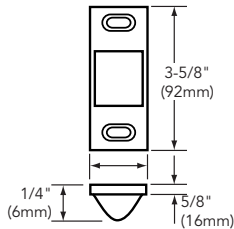

Half mortised. Nylon coating on face plate only. Minimum stile 4". When ordered separately, specify finish.

644 Strike (Alternative for 3828)

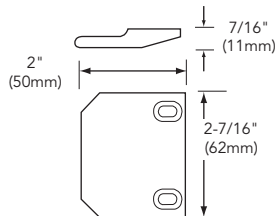

Surface applied. For use on pair of doors without mullion. Specify outside finish when ordered separately.

642 Strike (Alternative for 3828)

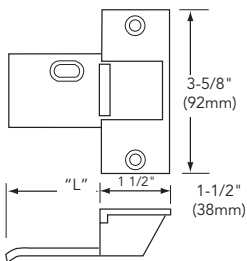

Full mortised Dimension "L" equals door thickness plus 1/2" (13mm).

653 Bottom Strike (Alternate for 12-3727)

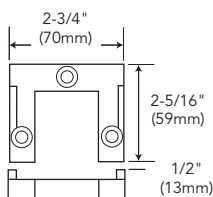

Available on order for 12-3727. For use with 1/2" (13mm) high threshold. Cut threshold to fit strike. Stainless steel. Furnished with expansion shields.

Glass Bead Shim Kits

558 for 3828 and 12-3828 Exit Devices

559 for 3727 and 12-3727 Exit Devices

Note: When ordering shim kits for exits with outside trim, spindle length, thumbpiece length and through bolt length must be increased accordingly.

(2 pieces 1/8" shim supplied. 1/4" total.)

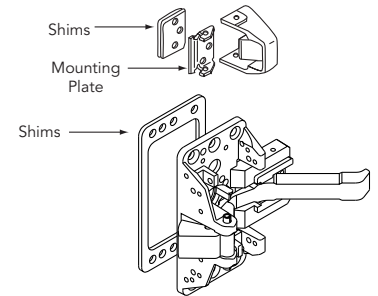

Through Bolt (TB) Applications

Device	Door Thickness	*Ordering Number
3727	1-3/4" (44mm)	28-2031
	2-1/4" (57mm)	28-2032
12-3727	1-3/4" (44mm)	28-2078
	2-1/4" (57mm)	28-2088
3828 & 12-3828	1-3/4" (44mm)	28-2024
	2-1/4" (57mm)	28-2025

*Specify finish

Through bolts and mortise nuts are furnished in a pack along with the appropriate instruction sheet for device ordered.

To order through bolts and mortise nuts with an exit device, add suffix TB to trim pack.

Example: 3727 x TB x EN
Available finishes: EB, EN, ED, EAB

To order through bolts and mortise nut packs separately, see chart above.

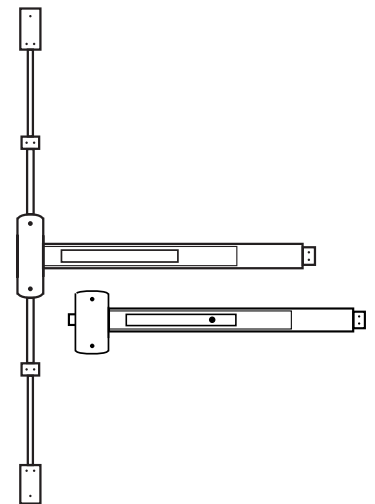

Rod Replacement Kits

Product	Top Rod Kit ++	Bottom Rod Kit +++
3700+	672T	672B

+ Finish Information Required

++ Door Height & Rail Location Required

+++ Rail Location Required

Mullions and Door Kits

30 Series Exit Device

980 Removable Mullion

980 Extruded Aluminum (prime coat)
980A Aluminum (US28)

Consists of:

- Mullion
- 511 Top Retainer
- 502 Bottom Retainer
- 86" (2184mm) stock size; 120" (3000mm) available

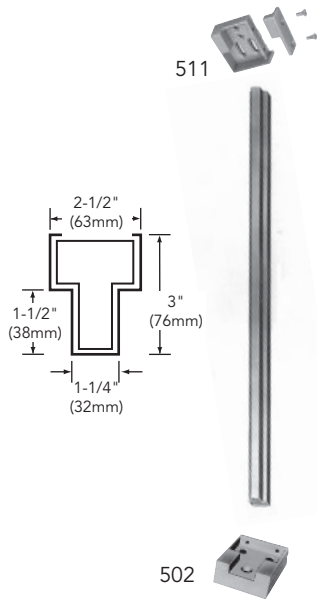

12-980 Mullion (96" maximum)

For 12-3828

2" x 3" Channel Iron. Malleable iron top and bottom retainers.

- 86" (2184mm) stock size; 120" (3000mm) available
- Fire rating is valid only up to 96" (2438mm)
- Mullions longer than 86" (2184mm) must be ordered as 12- option x 120" (3000mm) length and cut to size in the field.

Top Retainer Shim Kit - 601

Top Retainer 98-2190



Bottom Retainer 98-2191



L980 Lockable Mullion

- Aluminum Prime Coat
- Specify: "L980A" Anodized Aluminum
Specify: "L980A x10B" for 313AN to match 10B
- Used for non fire rated applications
- 86" (2184mm) stock size
- 120" (3000mm) available
- Standard #41 cylinder (1-1/8")
- Cylinder options: Signature, XC-, Schlage Keyways SC- & SE- available
- Wall Mount Kit 98-2578
- Top Ret Pack 98-2526
- Bottom Ret Pack 98-2525
- Cylinder Kit must be ordered separately (980C1 - Available in 32D and 10B finish.)

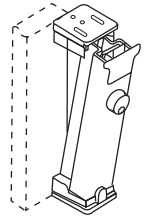

12-L980 Lockable Mullion

- Steel
- Fire rated for 8'0" x 8'0" (2438mm x 2438mm) paired openings
- 86" (2184mm) Stock Size
- Fire rating is valid only up to 96" (2438mm)
- Mullions longer than 86" (2184mm) must be ordered as 12- option x 120" (3000mm) length and cut to size in the field.
- #41 cylinder standard
- Cylinder options: Signature, XC-, Schlage Keyways SC- & SE- available
- Top Retainer Shim Kit - 601
- Cylinder Kit must be ordered separately (980C1 - Available in 32D and 10B finish.)

EL980 Electric Lockable Mullion

- Steel
- For use with monitor or electric strikes
- Quick-Connect wiring supplied
- 86" (2184mm) stock size
- 120" (3000mm) available
- Requires a #46 cylinder
- Top Retainer Shim Kit - 601
- Not available in 12- option
- Cylinder Kit must be ordered separately (980C2 - Available in 32D and 10B finish.)

Mullion Accessories

RK980

Latchbolt assembly retrofit kit with top and bottom retainers for 980 mullion

Retainer Packs

Product #	Description
98-2526	Top Ret. pack for L980
98-2525	Bottom Ret. pack for L980
98-2558	Top Ret. pack for 12-L980
98-2556	Bottom Ret. pack for 12-L980
98-2559	Top Ret. pack for EL980

543 Stock Hollow Metal Door Kit

Kit consists of a 649 Strike Shim, a 161F Lock Front Filler, and a 86S Strike Filler for applying a 3828 Series Exit Device on doors prepared with Fed. Type 161 cutouts, and frames prepared for ANSI A115-2 Strikes.

The 649 strike shim is 1/8" (3mm) thick and is used to obtain the correct distance between the exit device case and the 649 surface applied strike, when the stop is 1/2" (13mm) high.



649 Strike Shim



161 Lock Front Filler



86S Strike Filler

507 Adapter for Narrow Transom Bars

- Available with 980 and 980A
- Required when soffit is 1-1/4" (32mm) to 2" (51mm) wide

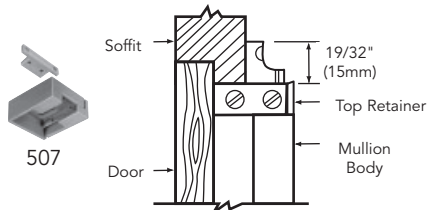

Note: For complete Listing of available mullions, see the 80 Series Catalog

Mechanical and Cylinder Options

30 Series Exit Device

Mechanical Options:

Note: Mechanical Options are available for Exit Devices only

Fire Rated	12-	UL Fire Label Exit hardware (not available with 16- & HK-)
Dogging Options	16-	Cylinder Dogging (Non Fire Rated Devices Only)
	LD-	Less Dogging (Non Fire Rated Devices Only)
Electrical Options	55-	Request to Exit - Signal Switch in Rail
Top Rod Only	NB-	Less Bottom Rod (Available for 3727 Devices)

Cylinder Options:

Note: Cylinder Options are available for 16- Exit Devices and 04, 06 & 13 function trims

	Code	Description	Lever Trim	Knob Trim	GTB-HTG-Thumbpc Trim	Rail - 16-Cyl Dogging
Degree Key System	DG1-	SARGENT Degree Key System Level 1 (bump resistant with patented keys)	X	X	X	X
	DG1-21-	Degree Level 1 Construction Master Keying	X	X	X	X
	DG1-60-	Degree Level 1 Removable Disposable Construction Core	X		X	X
	DG1-63-	Degree Level 1 Removable Core	X		X	X
	DG1-64-	Degree Level 1 Removable Construction Keyed LFIC	X		X	X
	DG2-	SARGENT Degree Key System Level 2 (geographically exclusive; bump and pick resistant)	X	X	X	X
	DG2-21-	Degree Level 2 Construction Master Keying	X	X	X	X
	DG2-60-	Degree Level 2 Removable Disposable Construction Core	X		X	X
	DG2-63-	Degree Level 2 Removable Core	X		X	X
	DG2-64-	Degree Level 2 Removable Construction Keyed LFIC	X		X	X
	DG3-	SARGENT Degree Key System Level 3 (geographically exclusive; UL437 certified; bump and pick resistant)	X	X	X	X
	DG3-21-	Degree Level 3 Construction Master Keying	X	X	X	X
	DG3-60-	Degree Level 3 Removable Disposable Construction Core	X		X	X
	DG3-63-	Degree Level 3 Removable Core	X		X	X
DG3-64-	Degree Level 3 Removable Construction Keyed LFIC	X		X	X	
Signature Key System	10-	SARGENT Signature Key System	X	X	X	X
	10-21-	SARGENT Signature Construction Key System (Lost Ball)	X	X	X	X
	10-63	SARGENT Signature LFIC (Removable Core) Cylinder	X		X	X

Note: For cylinder options not shown, please contact factory for availability

Note: For V-10 Cylinders and information, contact ASSA

Cylinder Options

30 Series Exit Device

	Code	Description	Lever Trim	Knob Trim	GTB-HTG-Thumbpc Trim	Rail - 16-Cyl Dogging
XC- Key System	11-	XC Key System (not available with other key systems unless specified)	X	X	X	X
	11-21-	XC- Construction Key System (Lost Ball)	X	X	X	X
XC- Large Format Interchangeable Core	11-60	Hardware to accept XC- Permanent LFIC (Removable core), Disposable plastic Core- provided	X		X	X
	11-63	Hardware provided with XC- LFIC (Removable core) Cylinder - (includes masterkeying, grand masterkeying)	X		X	X
	11-64	Hardware provided with Keyed construction core to accept XC- LFIC (Removable) Permanent core (ordered separately)	X		X	X
XC- Interchangeable Cores	11-70-7P	Lock to accept XC- SFIC (7-Pin) XC- Permanent cores, plastic disposable core provided	X		X	X
	11-72-7P	Lock to accept XC- SFIC (7-Pin Keyed Construction core provided) cylinder Permanent core ordered separately	X		X	X
	11-73-7P	Lock supplied with XC- Small Format 7-Pin interchangeable core (includes masterkeying, grand masterkeying)	X		X	X
	11-65-73-7P	Lock provided to accept XC- Uncombined 7-Pin SFIC (Permanent) core - (packed loose)	X		X	X
Large Format Interchangeable Core	60	Hardware to accept SARGENT Permanent LFIC (Removable core), Disposable plastic core provided (Permanent cores ordered separately)	X		X	X
	63	Hardware provided with LFIC (Removable core) Cylinder - (includes masterkeying, grand masterkeying)	X		X	X
	64	Hardware provided with Keyed construction core to accept LFIC (Removable) Permanent core (ordered separately)	X		X	X
Interchangeable Cores	70	Lock to accept 6- or 7-Pin SFIC Permanent cores, plastic disposable core provided	X		X	X
	72	Lock to accept 6- or 7-Pin SFIC (Keyed Construction core provided) Cylinder (Permanent core ordered separately)	X		X	X
	73	Lock supplied with 6-Pin SFIC (includes masterkeying, grand masterkeying)	X		X	X
	65-73	Lock provided to accept Uncombined 6-Pin SFIC (Permanent) core - (packed loose for field keying)	X		X	X
	65-73-7P	Lock provided to accept Uncombined 7-Pin SFIC (Permanent) core - (packed loose for field keying)	X		X	X
	73-7P	Lock supplied with Small Format 7-Pin Interchangeable core (includes masterkeying, grand masterkeying)	X		X	X
Keso & Keso F1	80	Lock to accept Keso and Keso F1 cylinders - no cylinders provided			X	X
	81	Cyl to accept Keso and Keso F1 - Removable cores - no core provided			X	X
	82	Lock provided with SARGENT Keso Security Cylinder			X	X
	F1-82	Lock provided with SARGENT Keso F1 Security Cylinder (Patented)			X	X
	83	SARGENT Keso Security Removable Core Cylinder (for existing systems only)			X	X
	84	SARGENT Keso Security Removable Construction Core Cylinder			X	X
Construction Key Systems	21-	SARGENT Lost Ball Construction Keying for Conventional, XC and Signature Series (N/A with 63- or 73-)	X	X	X	X
	22-	SARGENT Construction Split Key System for Conventional Cylinders (for existing systems only) (N/A with 10-, 11-, 63- or 73-)	X	X	X	X
Bump Resistant	BR-	Bump Resistant Cylinder (Available with Conventional & Conventional XC Cylinders Only)	X	X	X	X
Less Cylinder	LC-	Less Cylinder	X	X	X	X
Schlage Keyways	SC-	Schlage C keyway cylinder, 0 bitted	X	X	X	X
	SE-	Schlage E keyway cylinder, 0 bitted	X	X	X	X
	SF-	L lever to accept Schlage large format interchangeable core (supplied less core, tailpiece included)	X			

Note: For cylinder options not shown, please contact factory for availability

Note: For V-10 Cylinders and information, contact ASSA

Copyright © 1999-2024, SARGENT Manufacturing Company. All rights reserved. Reproduction in whole or in part without the express written permission of SARGENT Manufacturing Company is prohibited. Patent pending and/or patent www.assaabloydss.com/patents.

90126 01/24

Ordering Information, Rail Sizes and Finishes

30 Series Exit Device

Check List for Ordering

Indicate the following door and frame information:

- Single doors, or pair of doors with mullion, or pair of doors without mullion
- Door and frame material
- Dimensions:
 - Door opening width
 - Stile width
 - Door thickness
 - Stop height

Example: Single Door x Hollow Metal Frame 36" x 5" x 2-1/4" x 1/2"

- If Vertical Rod Devices also indicate:
 - Mounting height
 - Door opening height
 - Threshold height
 - If no threshold is used, so state
 - Unless threshold information is indicated, exit device will be furnished for use without threshold
- Mullion stock size is 96" (2438mm); 120" (3000mm) available
- In ordering templates for hollow metal doors and/or frames, state job name on template order. Give template order number or template numbers on hardware order

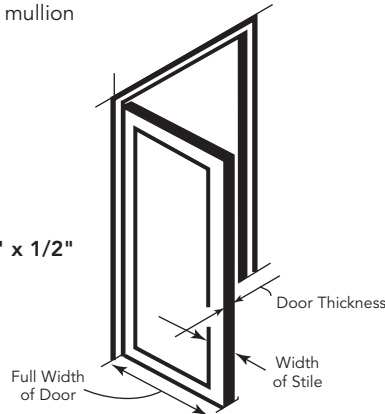

Stock Rail Sizes Available

E	For doors	24" through 32"	61cm through 81cm
F	For doors	33" through 36"	82cm through 91cm
J	For doors	37" through 42"	94cm through 107cm
G	For doors	43" through 48"	109cm through 122cm

Finishes available with Lever & Rose Trim and OB Knob Trim

SARGENT Designation	ANSI/BHMA Designation	Finish Description
03	605	Bright brass, clear coated
04	606	Satin brass, clear coated
10	612	Satin bronze, clear coated
10B	613	Dark oxidized satin bronze, oil rubbed
10BE	613E	Dark oxidized satin bronze, equivalent
20D	624	Statuary bronze dark powder coated
26D	626	Satin chromium plated
BSP	—	Black Suede Powder Coat
WSP	—	White Suede Powder Coat

Finishes available with Exit Devices, GTB Trims & Thumbpiece Trim

SARGENT Designation	ANSI/BHMA Designation	Finish Description	SARGENT Designation
EB	690	Sprayed bronze enamel or polyester powder coated to match finish 10B	
ED	693	Sprayed black enamel or polyester powder coated to match finish 20D	
EN	689	Sprayed aluminum enamel or polyester powder coated	
EP	691	Sprayed bronze enamel or polyester powder coated to match finish 10	
EAB	696	Brass enamel or polyester powder coated to be used with brass finishes	

** AFF: Above Finish Floor or Threshold; Required information for 3727 Devices. Standard mounting height 41" (104mm) above finished floor to centerline of device or 38" (965mm) above finished floor to centerline of device for elementary schools.

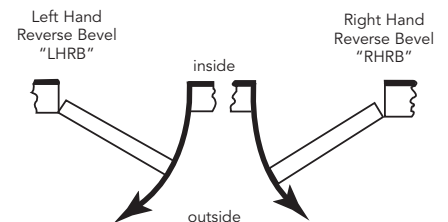
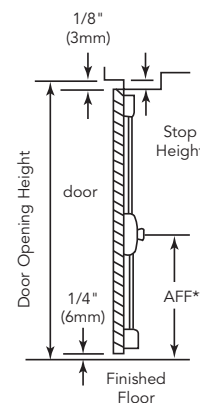

Packaging

Product	Avg. WT	Case
Exit with trim	15 lbs.	1 ea
980 mullion	18 lbs.	1 ea
12-980 mullion	40 lbs.	1 ea

Experience a safer
and more open world

1-800-727-5477 • www.sargentlock.com

Architectural Specifications and How To Order

30 Series Exit Device

How to order 3727/3828 Multi-function Exit Devices:

Specify the following for 3727 Devices:					
Options	Series	Rail	Opening	AFF	Finish
11-NB-	3727	F	84"	41"	EN

Specify the following for 3828 Devices:			
Options	Series	Rail	Finish
11-16-	3828	F	EN

- All trims and functions listed on this page, work with 3727 & 3828 Exit Devices, except where noted
- Available Options listed on Page 9

How to order Trim for 3727 & 3828 Exit Devices (Exit Device Sold Separately)

Example:

11-	28-C-LL	26D	
Options	Available Trim & Function Designation	Available Finishes	
Available Options See Page 9	Lever & Rose Trim		
	28-K-LL (04 Function)	28-C-LL (13 Function)	
	28-N-LL (06 Function)	28-L-LL (15 Function)	
	28-D-LL (10 Function)		
	GTB/HTB Trims & Pulls		
	814-HTB (04 Function)	EN, EB, ED, EP, EAB	
	802-GTB (10 Function) Exit Only		
	810-GTB (10 Function) Pull		
	OB Knob Trim		OB Knob Finish
	28-K-OB (04 Function)	26D	
	28-C-OB (13 Function)		
	28-L-OB (15 Function)		
	Thumbpiece Trim		Thumbpiece Finishes
	814-TP (04 Function)	EN, EB, ED, EP, EAB	
	866-TP (63 Function)		

Suggested Architect's Specifications

- All exit devices shall be of touch bar design and be operative over 2/3 of the door's clear opening width
- All exit devices must be listed under "Panic Hardware" in the Accident Equipment List of Underwriter's Laboratories, Inc. Where labeled doors are used as exits, they must be equipped with labeled Fire Exit Hardware
- All springs shall be of stainless steel
- All exit devices shall be of chassis mounted unit construction with removable cover

The ASSA ABLOY Group is the global leader in access solutions. Every day, we help billions of people experience a more open world.

ASSA ABLOY Opening Solutions leads the development within door openings and products for access solutions in homes, businesses and institutions. Our offering includes doors, frames, door and window hardware, mechanical and smart locks, access control and service.



SARGENT Manufacturing Company
100 Sargent Drive
New Haven, CT 06511 USA
800-727-5477
www.sargentlock.com

Founded in the early 1800s, SARGENT® is a market leader in locksets, cylinders, door closers, exit devices, electro-mechanical products and access control systems for new construction, renovation, and replacement applications. The company's customer base includes commercial construction, institutional, and industrial markets.

Copyright © 1999-2024, SARGENT Manufacturing Company. All rights reserved. Reproduction in whole or in part without the express written permission of SARGENT Manufacturing Company is prohibited. Patent pending and/or patent www.assaabloydss.com/patents.