

# 9200 Series

## High Security Mortise Lock and M-9200 Series MOGUL Institutional Mortise Lock

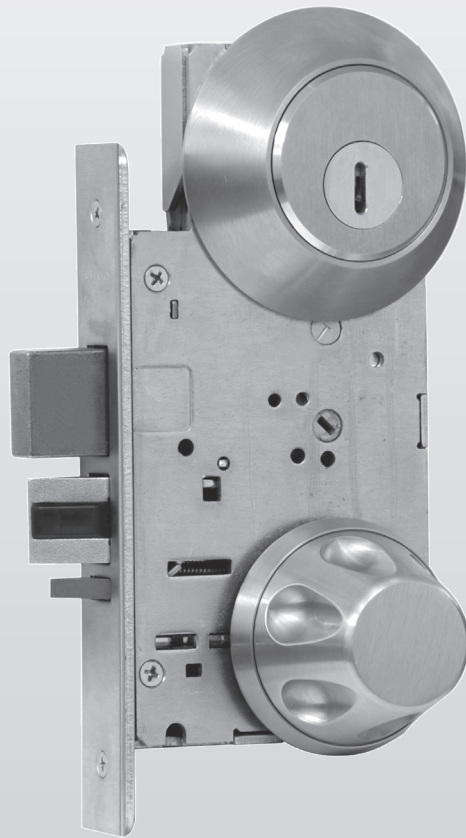

# Table of Contents

## Table of Contents

Features . . . . . 3-4

Lever Designs . . . . . 5

Knob and Rose Designs . . . . . 6

Escutcheons, Collars & Thumb Turns . . . . . 7

Anti-Vandal Trim . . . . . 8

Functions . . . . . 9-14

Electromechanical & Power Supplies . . . . . 15

Strikes . . . . . 16

Mechanical & Cylinder Options . . . . . 17-19

How to Order, Finishes & Architectural Specifications . . . . . 20

### MicroShield®

ASSA ABLOY Group companies offer MicroShield®, an antimicrobial coating for door hardware. MicroShield uses proven silver ion-based technology from Agion®, a leading provider of antimicrobial solutions, to stem the spread of bacteria and other microbes.

MicroShield® is a trademark of ASSA ABLOY Access and Egress Hardware Group, Inc.

### MicroShield® Coating

- Revolutionary finish coating available on all SARGENT product lines, utilizes a silver-based antimicrobial compound from Agion Technologies
- As an integral part of the finish coating, MicroShield lasts for the life of the hardware
- MicroShield coating permanently suppresses the growth of bacteria, algae, fungus, mold and mildew. It is effective against a broad spectrum of bacteria.
- Non-toxic and completely safe. The Agion antimicrobial compound is EPA and NSF approved and FDA listed for use in medical and food preparation equipment.
- Applications: Anywhere there is need for a clean environment (hospitals, laboratories, schools, medical centers, daycare, food processing etc.)



The Agion antimicrobial is not intended as a substitute for good hygiene. Coated products must still be cleaned to ensure the surfaces will be free of destructive microbes. ASSA ABLOY makes no representations or warranties, express or implied, as to the efficacy of the Agion antimicrobial. A copy of the Agion warranty is available upon request. Agion is a registered trademark of Agion Technologies, Inc., Wakefield, MA, USA.

### On the Cover

M-9225 BHD (Detention Knob)

## 9200 High Security Mortise Lock with Builders Hardware Cylinder

The 9200 High Security Mortise Lock is designed for use on openings that withstand extreme abuse, vandalism and malicious impact. It is well-suited for exposed perimeter doors in commercial facilities, such as warehouses, factories and malls. Psychiatric and minimum security detention facilities are also well-served with SARGENT 9200.

- Furnished standard for 1-3/4" thick doors. Available for doors up to 3" thick (For other sizes, consult factory)
- Furnished with standard SARGENT cylinders (Available with High Security Keso F1 or Signature Security Cylinders or interchangeable core cylinders)
- Masterkey, Grand Masterkey and Construction Masterkeying available
- Universal, non-handed curved lip strike
- Tapered security cylinder collar standard
- Security roses & escutcheons available

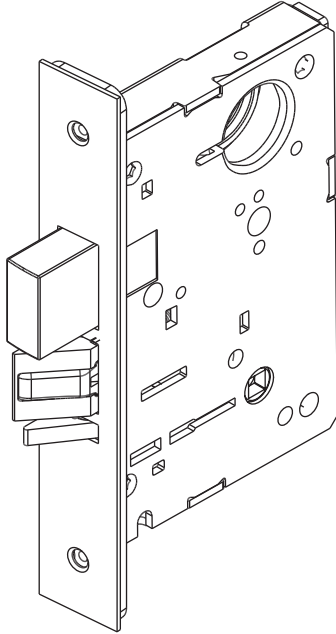

## M-9200 Institutional Mortise Lock with Mogul Cylinder

The M-9200 Institutional Mortise Lock is designed for use in detention facilities, holding areas and psychiatric facilities.

- Lock face and strike fit the standard ANSI door edge and frame preparation
- Furnished standard for 1-3/4" thick doors
- Mogul Cylinders purchased separately through ASSA
- Universal, non-handed curved lip strike
- Tapered security cylinder collar standard
- Security rose trim standard
- 4 lever designs available (B,J, L & P)
- K (standard) knob & D (detention) Knob with security rose are available (specify 67-, 68- or 69-)

**Note: M9200 to be used on metal doors only**

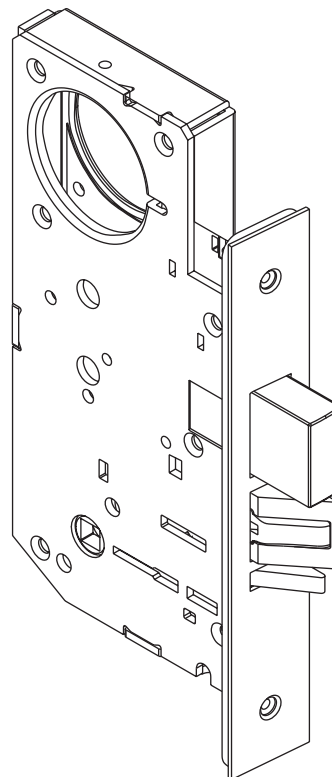

# Features

## Physical Security

High Security Mortise Locks and Institutional SARGENT® Mortise Locks are designed specifically for the commercial and institutional marketplace. High quality components provide high security, optimum performance and exceptional durability.

The 9200 Locks are also available as electromechanical locks in fail safe or fail secure versions. These solenoid operated locks are available with a 12 or 24 volt solenoid and are designed for intermittent and/or continuous duty. Full wave bridge rectification is factory installed, enabling the use of AC or DC power.

## Features of the 9200/M-9200 High Security Mortise Locks:

- Stainless Steel 3/4" one-piece anti-friction latchbolt with hardened alloy steel latchbolt rod
- Reversible non-handed lock
- Stainless Steel non-handed deadlatch
- Hardened Stainless Steel 1" throw investment cast deadbolt
- 12 gauge heavy duty wrought steel case and cap with ZCR plating
- Cold forged hardened alloy steel hubs standard
- Inside front full 1/8" hardened high carbon steel
- All exposed screws are Torx® Security type for SN, SL and LS trims. (Torx® available for other trims, specify 36-option)
- Meets ANSI/BHMA A156.13 Series 1000 Operational Grade 1
- Meets ANSI/BHMA A156.13 Series 1000 Security Grade 1 with all standard trims

**Note: LFIC (Removable) and SFIC Cylinders do not meet Security Grade 1 requirements**

- Complies with **ASTM F1577-95b Detention Locks** for Swinging Doors

**Paragraph 6.2 Level 1 Impact** for deadbolt x latchbolt and deadbolt only

**Paragraph 6.2 Level 3 Impact** for latchbolt only

**Paragraph 6.4 for Cylinder Cycle (ASSA V-10 and ASSA Mogul V-10)**

**Paragraph 6.6 for Mechanical Release Force (ASSA V-10 and ASSA Mogul V-10)**

**Paragraph 6.8 Mechanical Release Operation Cycle (ASSA V-10 and ASSA Mogul V-10)**

- **Complies with ANSI/ASTM F476-84 Grade 40** with concealed mortise cylinder
- Meets UL and CUL Standard 10C Positive Pressure, Fire Test of Door Assemblies; 3 hour for single doors up to 4'0" x 10'0" and ASTM F1577-95b Paragraph 6.3
- Levers meet A117.1 Accessibility Code -ADA
- Easy operation; 30° of rotation to retract latchbolt
- Meets UL 437 for high security cylinders with ASSA V-10 and ASSA V-10 Mogul cylinders only
- Ten year limited warranty

Any retrofit or other field modification to a fire rated opening can potentially impact the fire rating of the opening, and Sargent Manufacturing Company makes no representations or warranties concerning what such impact may be in any specific situation. When retrofitting any portion of an existing fire rated opening, or specifying and installing a new fire-rated opening, please consult with a code specialist or local code official (Authority Having Jurisdiction) to ensure compliance with all applicable codes and ratings.

# Lever Designs

- Designs J, L and P return within 1/2" (13mm) or less off door face and meet ADA Compliance for national codes
- All lever designs can be used with all standard rose and escutcheon designs

## B Lever Design

- Lever: B-Solid forged or cast

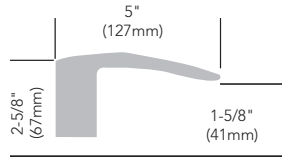

## L Lever Design

- Lever: L-Solid forged or cast

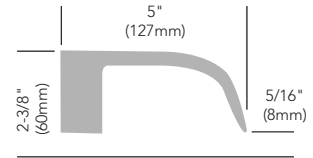

## J Lever Design

- Lever: J-Solid bar stock

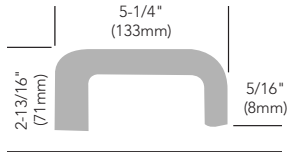

## P Lever Design

- Lever: P-Solid forged or cast

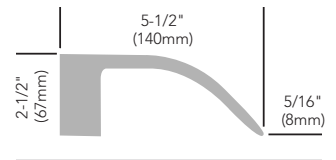

## BHW Trim

- Available in 26 functions - see Specialty Hardware Catalog for list
- Tapered surfaces on all components
- Handed
- ADA Compliant
- Finish: 32D
- Trim only option available with existing sectional and escutcheon trim only
- Trim only kits
  - 694-1 Trim only, non-keyed functions
  - 694-2 Trim only, single cylinder functions
  - 694-3 Trim only, double cylinder functions
- Patent pending and/or patent [www.assaabloydss.com/patents](http://www.assaabloydss.com/patents)



# Knob & Rose Designs

## L Rose Design

- Rose: L-Heavy wrought

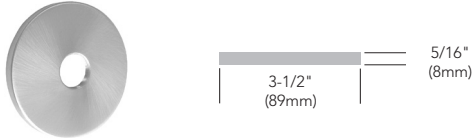

## SL Rose Designs

- Security L Rose (SL) includes Torx® security screw
- Provided with Knurled Security Turn, if required by the function

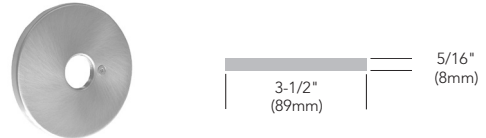

## LN Rose Design

- Rose: LN-Heavy wrought

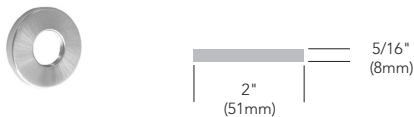

## SN Rose Design

- Security LN Rose (SN) includes Torx® security screw
- Provided with Knurled Security Turn, if required by the function

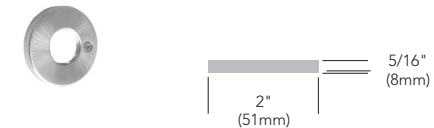

## BH Rose Design

- Rose: BH-Heavy wrought
- Used with Detention Knob only

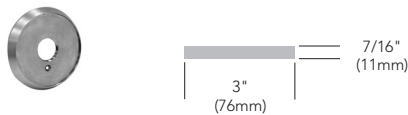

## "K" Knob Design

- Knob: Cast
- Available with SN & SL Roses and LS Escutcheon
- **Must Specify 67-, 68-, & 69- Option when ordering**

**Note: Rotates only in one direction (toward hinge)**

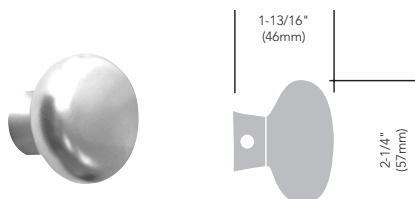

## D Knob

- Available with BH or SL Roses only
- Designed for detention and psychiatric facilities
- Does not meet ADA requirements
- **Must Specify 67-, 68-, & 69- Option when ordering**
- **Only available in 32D**

**Note: Rotates only in one direction (toward hinge)**

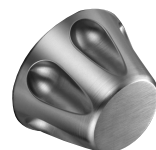

# Escutcheons, Collars & Thumb Turns

## Escutcheons

### LE3/LE4 Escutcheon (shown with B Lever)

- Escutcheon with concealed cylinder, Exposed Barrel Only
- Escutcheon: LE-Forged
- LE3- (2) Exposed thru-bolt screws inside
- LE4- (2) Concealed through-bolt screws
- Not available with Mogul Cylinder (M-Option)
- **Not available with double cylinder functions and 06, 35 & 50 function locks**

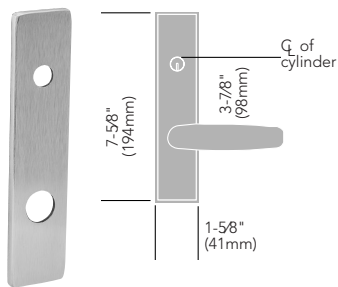

### LS Escutcheon (shown with L Lever)

- Escutcheon: LS-Forged
- Security Trim
- (4) Spanner security through-bolt screws are exposed on inside escutcheon
- Double cylinder functions, cylinders protrude from escutcheon face
- Not available with Mogul Cylinder (M-Option)
- **Not available with electrical functions and 06 & 35 function locks**

**Note: Only available with Cylinder Options: 10-, 11-, 21-, 22- & BR-**

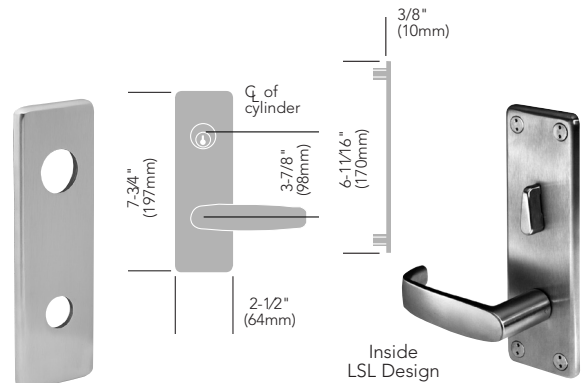

## Thumb Turns and Collars

**130SKB Thumb Turn  
for 9200**

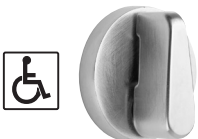

**130SB Thumb Turn  
for M-9200**



**130KBHA Thumb  
Turn for 9200**



**1SB Cylinder Collar  
for 9200**



**1MB Cylinder Collar for  
M-9200 Mogul Cylinders**



# Anti-Vandal Trim

## 9200 Anti-Vandal Option (AV-)

Designed for exterior doors that require extra security or resistance to vandalism. Anti-vandal trim (AV) plates have an extended lip on the active side of the door providing extra protection for the latch, deadbolt and guardbolt. A matte plastic coated grip edge provides a comfortable pull appropriate over a wide temperature range. Fully through-bolted without exposed exterior fasteners for a clean look and increased security.

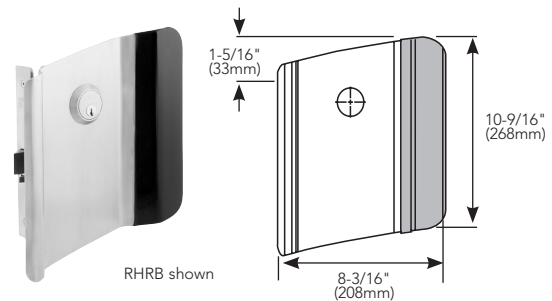

### Features

- Heavy duty 12 gauge stainless steel in 32D finish
- Through-bolted through mortise lock body and door for added strength
- Handed – Specify RHRB or LHRB
- ADA Compliant
- Patent Pending
- Not available with escutcheon trim
- Functions available: See chart to the right
- Available without protective lip for inactive doors
- To order the Anti Vandal Trim with the lock specify: AV- Option  
Example AV-8204 x LNJ x RH x 32D
- Only available in 32D finish
- To order the Anti Vandal Trim as a Kit, specify kit number 667 with suffix as required based on function and hand of the lock as seen in the chart to the right

### 667 AV Kit

Retrofit kits for 7800, 8200 & 9200 mortise locks

667 Kit includes:

- AV Pull (Handed)
- (4) 1/4-20 screws
- (4) Cup washers
- 1SB Rosette
- Instructions & Templates

RHRB	LHRB	Functions
667-1 82-4034	667-2 82-4035	04, 06, 17 and 50 -1 & -2 Trim has an extended lip, cylinder hole and through bolt post for mounting Inside trim
667-3 82-4036	667-4 82-4037	03, 20, 21, 22, & 23 -3 & -4 Trim has an extended lip & cylinder hole for deadbolt functions only
667-5 82-4044	667-6 82-4045	-5 & -6 Trim is designed as a Pull does not have an extended lip or cylinder hole

**Note: The AV trim is not available for the M-9200's**

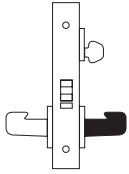
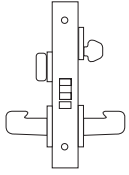
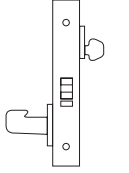
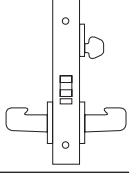
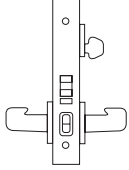

## Single Cylinder without Deadbolt

Inside/Outside	Series/ Function	Type	ANSI No.	Function Description
	9204 M-9204	Storeroom or Closet	F07	<ul style="list-style-type: none"> <li>• Key outside or lever/knob inside retracts latchbolt</li> <li>• Lever/knob outside rigid at all times</li> <li>• Lever/knob inside always retracts latchbolt</li> <li>• Auxiliary deadlatch</li> </ul>
	9205 M-9205	Office or Entry	F04	<ul style="list-style-type: none"> <li>• Key outside retracts latchbolt when outside Lever/knob is locked</li> <li>• Lever/knob inside retracts latchbolt only, outside Lever/knob remains locked</li> <li>• Lever/knob outside is locked/unlocked by thumb turn inside or by key outside</li> <li>• Auxiliary deadlatch</li> </ul>
	9206 M-9206	Storeroom or Service	—	<ul style="list-style-type: none"> <li>• No outside lever/knob, cylinder only</li> <li>• Lever/knob inside or key outside retracts latchbolt</li> <li>• Auxiliary deadlatch</li> <li>• Same as 04 Function without lever/knob outside</li> </ul>
	9237 M-9237	Classroom	F05	<ul style="list-style-type: none"> <li>• Key outside locks and unlocks lever/knob outside</li> <li>• Key outside retracts latchbolt</li> <li>• Lever/knob outside retracts latchbolt, except when outside lever/knob is locked by key</li> <li>• Lever/knob inside always retracts latchbolt</li> <li>• Auxiliary deadlatch</li> </ul>
	9255 M-9255	Office or Entry	—	<ul style="list-style-type: none"> <li>• Key outside retracts latchbolt when outside Lever/knob is locked</li> <li>• Lever/knob inside retracts latchbolt only, outside lever/knob remains locked</li> <li>• Lever/knob outside is locked by toggle only</li> <li>• Auxiliary deadlatch</li> </ul>

♦ **CAUTION:** Not recommended for use on any door used for Life Safety egress

 If shaded, knob or lever rigid at all times

# Functions

## Single Cylinder with Deadbolt

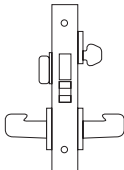
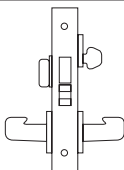
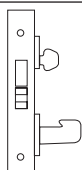
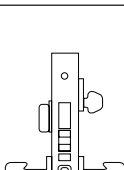
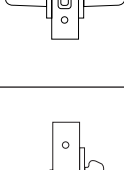
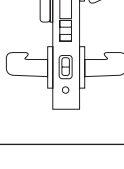
Inside/Outside	Series/ Function	Type	ANSI No.	Function Description
	9224* M-9224*	Storeroom Door	F21	<ul style="list-style-type: none"> <li>• Key outside or thumb turn inside retracts and projects deadbolt</li> <li>• Lever/knob either side retracts latchbolt</li> <li>• Latchbolt and deadbolt are independent of each other</li> </ul>
	9225 M-9225	Dormitory or Exit	F13	<ul style="list-style-type: none"> <li>• Key outside or thumb turn inside retracts and projects deadbolt</li> <li>• Lever/knob from either side retracts latchbolt, when the deadbolt is in the retracted position</li> <li>• Lever/knob outside is locked, when the deadbolt is projected</li> <li>• When deadbolt is projected, lever/knob inside retracts latchbolt and deadbolt simultaneously, unlocking outside lever/knob</li> </ul>
	9235* M-9235*	Storeroom	—	<ul style="list-style-type: none"> <li>• Key outside retracts and projects deadbolt</li> <li>• Lever/Knob outside retracts latchbolt, except when deadbolt is projected</li> <li>• Inside: no lever/knob or cylinder</li> </ul>
	9243 M-9243	Apartment Corridor Door	F20	<ul style="list-style-type: none"> <li>• Key outside or thumb turn inside retracts and projects deadbolt</li> <li>• Key outside retracts both latchbolt and deadbolt, lever/knob outside remains locked</li> <li>• Lever/knob from either side retracts latchbolt, except when lever/knob outside is locked</li> <li>• Lever/knob outside is locked by toggle or projecting deadbolt</li> <li>• Lever/knob outside is unlocked by toggle only</li> <li>• Lever/knob inside (when deadbolt is projected) retracts latchbolt and deadbolt simultaneously, and lever/knob outside remains locked</li> <li>• Auxiliary deadlatch</li> </ul>
	9245 M-9245	Dormitory or Exit	F12	<ul style="list-style-type: none"> <li>• Key outside or thumb turn inside retracts and projects deadbolt</li> <li>• Key outside retracts both latchbolt and deadbolt, lever/knob outside remains locked</li> <li>• Lever/knob from either side retracts latchbolt, except when lever/knob outside is locked</li> <li>• Lever/knob outside is locked by toggle or projecting deadbolt</li> <li>• Lever/knob inside (when deadbolt is projected) retracts latchbolt and deadbolt simultaneously, and lever/knob outside remains locked</li> <li>• Same as 43 function without auxiliary deadlatch</li> </ul>
	9250	Hotel Guest	F15	<ul style="list-style-type: none"> <li>• Hotel Cylinder Required (50 Function Cylinder) with two types of Keys (Standard &amp; Emergency)</li> <li>• Standard Key outside retracts latchbolt only, will not retract or project deadbolt</li> <li>• Emergency Key outside will retract latchbolt and deadbolt and also project deadbolt</li> <li>• Thumb turn inside retracts and projects deadbolt</li> <li>• When the deadbolt is projected, it shuts out all keys except the emergency key</li> <li>• Lever/knob inside retracts both latchbolt and deadbolt simultaneously</li> <li>• Lever/knob outside is always rigid</li> <li>• Auxiliary deadlatch</li> <li>• Not available with Mogul (M-) Option</li> <li>• Not available with certain key systems (See Option Chart)</li> </ul>

♦ **CAUTION:** Not recommended for use on any door used for Life Safety egress

 If shaded, knob or lever rigid at all times

Copyright © 2007-2023, Sargent Manufacturing Company, an ASSA ABLOY Group company. All rights reserved. Reproduction in whole or in part without the express written permission of Sargent Manufacturing Company is prohibited.

## Double Cylinder without Deadbolt

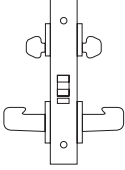
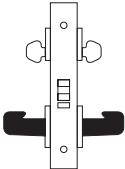
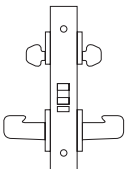
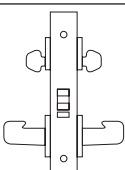
Inside/Outside	Series/ Function	Type	ANSI No.	Function Description
	9216	Apartment, Exit or Public Restroom	F09	<ul style="list-style-type: none"> <li>• Key outside retracts latchbolt, when outside lever/knob is locked</li> <li>• Key inside is required to lock and unlock lever/knob outside</li> <li>• Lever/knob either side retracts latchbolt, unless outside lever/knob is locked by key inside</li> <li>• Lever/knob inside always operable</li> <li>• Auxiliary deadlatch</li> <li>• Special cam required for inside cylinder</li> </ul>
	9217* M-9217*	Asylum or Institutional	F30	<ul style="list-style-type: none"> <li>• Key from either side retracts latchbolt</li> <li>• Lever/knob on both sides rigid at all times</li> <li>• Auxiliary deadlatch</li> </ul>
	9238 M-9238	Classroom Security Intruder Latchbolt	F32	<ul style="list-style-type: none"> <li>• Key from either side locks and unlocks lever/knob outside</li> <li>• Key from either side retracts latchbolt</li> <li>• Lever/knob outside retracts latchbolt, except when outside lever/knob is locked by key</li> <li>• Lever/knob inside always retracts latchbolt</li> <li>• Auxiliary deadlatch</li> <li>• Same as 37 function with two cylinders</li> </ul>
	9259*	School Security	—	<ul style="list-style-type: none"> <li>• Key from either side locks and unlocks inside &amp; outside levers/knobs</li> <li>• Key from either side retracts latchbolt</li> <li>• Key from either side can retract latchbolt without unlocking levers/knobs</li> <li>• Auxiliary deadlatch</li> </ul>

✦ **CAUTION:** Not recommended for use on any door used for Life Safety egress

 If shaded, knob or lever rigid at all times

# Functions

## Double Cylinder with Deadbolt

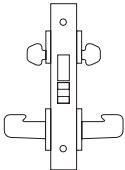
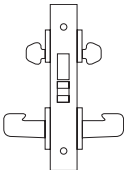
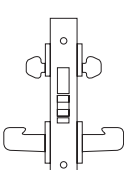
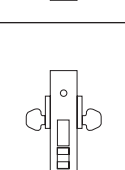
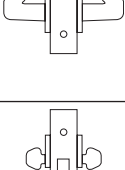
Inside/Outside	Series/ Function	Type	ANSI No.	Function Description
	9226 <sup>+</sup> M-9226 <sup>+</sup>	Store Door	F14	<ul style="list-style-type: none"> <li>• Key from either side retracts and projects deadbolt</li> <li>• Lever/Knob from either side retracts latchbolt</li> <li>• Latchbolt and deadbolt are independent of each other</li> <li>• Same as 24 Function with two cylinder and no thumb turn</li> </ul>
	9239 M-9239	Classroom Security Intruder Deadbolt	F33	<ul style="list-style-type: none"> <li>• Key either side retracts or projects deadbolt to unlock or lock lever/ knob outside</li> <li>• Lever/knob outside retracts latchbolt, except when outside lever/ knob is locked by key</li> <li>• Lever/knob inside retracts both latchbolt and deadbolt simultaneously, and unlocks lever/knob outside</li> <li>• Same as 25 function with a cylinder inside in place of thumb turn</li> </ul>
	9240 M-9240	Classroom Security Intruder Deadbolt	F34	<ul style="list-style-type: none"> <li>• Key either side retracts or projects deadbolt to unlock or lock lever/ knob outside</li> <li>• Lever/knob outside retracts latchbolt, except when outside lever/ knob is locked by key</li> <li>• Lever/knob inside retracts both latchbolt and deadbolt simultaneously, and unlocks lever/knob outside</li> <li>• Auxiliary deadlatch</li> <li>• Same as 39 function with Auxiliary deadlatch</li> </ul>
	9241	Classroom Security	—	<ul style="list-style-type: none"> <li>• Key from either side retracts and projects deadbolt</li> <li>• Key retraction of deadbolt, lever/knob outside remains locked</li> <li>• Key retraction of latchbolt from either side unlocks lever/knob outside</li> <li>• Lever/knob outside retracts latchbolt, except when outside lever/knob is locked by key</li> <li>• Lever/knob outside is locked when the deadbolt is projected</li> <li>• Lever/knob inside (when deadbolt is projected) retracts both latchbolt and deadbolt simultaneously, and lever/knob outside remains locked</li> <li>• Auxiliary deadlatch</li> </ul>
	9249 <sup>+</sup>	Security Deadbolt	—	<ul style="list-style-type: none"> <li>• Key from either side retracts and projects deadbolt</li> <li>• Key from either side retracts latchbolt</li> <li>• Levers/knobs inside &amp; outside are locked only when deadbolt is projected</li> </ul>

✦ **CAUTION:** Not recommended for use on any door used for Life Safety egress

 If shaded, knob or lever rigid at all times

**Non Keyed Functions are available for 9200 Series only**

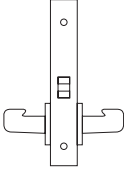
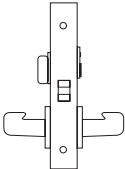
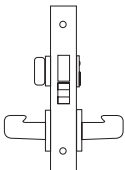
Inside/Outside	Series/ Function	Type	ANSI No.	Function Description
	9215	Passage or Closet	F01	<ul style="list-style-type: none"> <li>Lever/knob from either side retracts latchbolt at all times</li> </ul>
	9265	Privacy Bedroom or Bath	F22	<ul style="list-style-type: none"> <li>Lever/knob outside retracts latchbolt except when locked by thumb turn inside</li> <li>Lever/knob inside retracts latchbolt and unlocks outside lever/knob</li> <li>Emergency Release unlocks lever/knob outside</li> <li>Thumb turn locks and unlocks lever/knob outside</li> <li>Closing the door will unlock lever/knob outside</li> </ul>
	9266	Privacy Bedroom or Bath	F19	<ul style="list-style-type: none"> <li>Lever/knob outside retracts latchbolt except when deadbolt is projected</li> <li>Lever/knob inside retracts both latchbolt and deadbolt simultaneously, and unlocks outside lever/knob</li> <li>Emergency Release retracts and projects deadbolt</li> <li>Thumb turn retracts and projects deadbolt</li> </ul>

# Functions

## Deadbolt Only

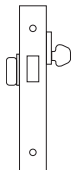
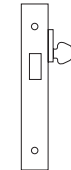
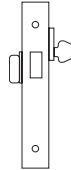
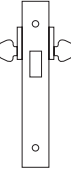
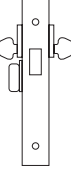
Inside/Outside	Series/ Function	Type	ANSI No.	Function Description
	9203 <sup>+</sup> M-9203 <sup>+</sup>	Classroom Deadlock	F29	<ul style="list-style-type: none"> <li>• Deadbolt operation only</li> <li>• Key outside retracts and projects deadbolt</li> <li>• Thumb turn inside retracts deadbolt only, will not project it</li> </ul>
	9220 <sup>+</sup> M-9220 <sup>+</sup>	Deadlock	F18	<ul style="list-style-type: none"> <li>• Deadbolt operation only</li> <li>• Key outside retracts and projects deadbolt</li> <li>• No inside operation</li> </ul>
	9221 <sup>+</sup> M-9221 <sup>+</sup>	Deadlock	F17	<ul style="list-style-type: none"> <li>• Deadbolt operation only</li> <li>• Key outside retracts and projects deadbolt</li> <li>• Thumb turn inside retracts and projects deadbolt</li> </ul>
	9222 <sup>+</sup> M-9222 <sup>+</sup>	Deadlock	F16	<ul style="list-style-type: none"> <li>• Deadbolt operation only</li> <li>• Key outside or inside retracts and projects deadbolt</li> </ul>
	9223 <sup>+</sup> M-9223 <sup>+</sup>	Classroom Deadlock		<ul style="list-style-type: none"> <li>• Deadbolt only operation</li> <li>• Key outside or inside retracts and projects deadbolt</li> <li>• Thumb turn inside retracts deadbolt, does not project deadbolt</li> <li>• Same as 03 function with an extra cylinder inside</li> </ul>

◆ **CAUTION:** Not recommended for use on any door used for Life Safety egress



If shaded, knob or lever rigid at all times

# Electromechanical & Power Supplies

SARGENT 9200 Electromechanical Mortise locks are designed to handle single openings, stand alone applications or can be readily integrated into sophisticated access control systems. They meet ANSI/BHMA A 156.13 Grade 1 requirements, are UL listed for fire doors, and satisfy industry standards for operating temperature, shock and fire hazard.

**Applications:** Security and restricted access areas in computer rooms, offices, equipment rooms, laboratories and hospitals. Can also be used with fire and alarm controls in buildings and stair tower doors.

## Electrical Requirements:

Voltage: 12VDC or 24VDC Regulated. Full wave rectification installed inside the lockbody.

Current: .25A at 24VDC or .5A at 12VDC

Operating Temp.: Max. 151°F (66°C),

Min -31°F (-35°C)

UL and CUL listed for use on Fire Doors

**Note: Repeated operation at voltage exceeding +/- 10% is not recommended.**

## Warning:

- **Do not** connect locks with a circuit sharing an additional electromagnetic device as the lock may be damaged
- Transient voltage must be suppressed at the source before connecting with the lock
- Varistor rated at 35 volts (peak) may be used for transient voltage protection

**Note: Opening the lockbody or the solenoid replacement in the field by non-authorized personnel voids UL label and lock warranty.**

**Note: Electrical functions are not available with the mogul option (M-9200)**

## Functions

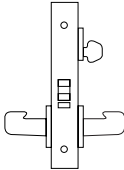
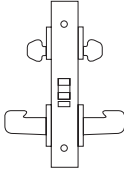
Inside/Outside	Series/ Function	Type	ANSI No.	Function Description
	9270 9271	Electrical Fail Safe Electrical Fail Secure	—	<ul style="list-style-type: none"> <li>• Solenoid activated mortise lock</li> <li>• 70 function - Power ON, locks outside lever (by solenoid)</li> <li>• 71 function - Power OFF, locks outside lever (by solenoid)</li> <li>• Always specify voltage: 12VDC or 24VDC</li> <li>• Key outside retracts latchbolt, when the lever outside is locked</li> <li>• Lever outside retracts latchbolt except when lever outside is lock</li> <li>• Lever outside can only be locked with the solenoid</li> <li>• Lever inside always retracts latchbolt</li> <li>• Supplied with ElectroLynx® connectors</li> <li>• Auxiliary deadlatch</li> </ul>
	9272 9273*	Electrical Fail Safe Electrical Fail Secure	—	<ul style="list-style-type: none"> <li>• Solenoid activated mortise lock</li> <li>• 72 function - Power ON, locks both levers (by solenoid)</li> <li>• 73 function - Power OFF, locks both levers (by solenoid)</li> <li>• Always specify voltage: 12VDC or 24VDC</li> <li>• Key on either side retracts latchbolt, when the lever are locked</li> <li>• Lever from either side retracts latchbolt, except when lever are locked</li> <li>• Lever on both sides can only be locked with the solenoid</li> <li>• Lever can not be locked separately, only together</li> <li>• Supplied with ElectroLynx connectors</li> <li>• Auxiliary deadlatch</li> </ul>

♦ **CAUTION:** Not recommended for use on any door used for Life-safety egress

## 12VDC & 24VDC Power Supplies:



- UL Class 2 Listed
- Four 12V models and four 24V models available
- Integral battery charging capability keeps sealed lead acid gel/cell at full charge in case of line voltage failure (battery sold separately)
- Fused line voltage input with one, four, or eight DC outputs (depending on model)
- Each circuit can be individually turned on and off via a slide switch; the power status of each is shown by an LED.
- In the event of a DC short the problem is confined to the zone of difficulty
- Fire alarm interface standard

SARGENT Model No.	Description
3521	12V - 1 AMP Power Supply
3541	12V - 3 AMP Power Supply
737	12V - 5 AMP Hour Backup Battery
3520	24V - 1 AMP Power Supply
3540	24V - 2 AMP Power Supply
3550	24V - 4 AMP Power Supply
3570	24V - 6 AMP Power Supply
738	24V - 5 AMP Hour Backup Battery

Experience a safer  
and more open world

1-800-727-5477 • [www.sargentlock.com](http://www.sargentlock.com)

# Strikes

- Curved lip strikes: Brass or stainless steel
- To order strikes separately, specify strike part number and finish. Will be furnished with machine screws
- Order strike box 77-1141 separately
- All locks are packed standard with a universal non-handed curved lip ANSI 4-7/8" (124mm) strike

## Curved Lip Strike

Door Thickness	Part No.	Lip Length
1-3/8" (35mm)– 1-1/2" (38mm)	82-0109	1-1/8" (29mm)
1-5/8" (41mm)– 1-3/4" (44mm)	82-0110 Standard	1-1/4" (32mm)
1-7/8" (48mm) – 2" (51mm)	82-0111	1-3/8" (35mm)
2-1/8" (54mm) – 2-1/2" (64mm)	82-0112	1-5/8" (41mm)
2-5/8" (67mm) – 3" (76mm)	82-0113	1-7/8" (48mm)
3-1/8" (79mm) – 3-1/2" (89mm)	82-0114	2-1/8" (54mm)
3-3/8" (86mm) – 4" (101mm)	82-0115	2-3/8" (61mm)
4-1/8" (105mm) – 4-1/2" (114mm)	82-0116	2-5/8" (67mm)
4-5/8" (117mm) – 5" (127mm)	82-0117	2-7/8" (73mm)

### Curved Lip Strike (Standard)

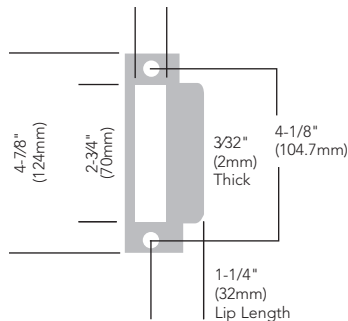

### 78-0034 Deadbolt Strike

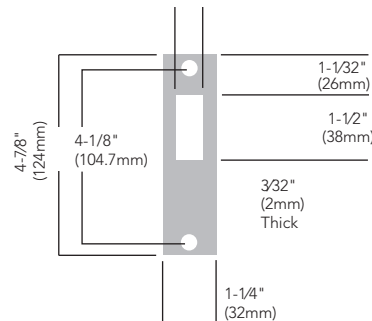

- Provided standard with deadlock functions 03, 20, 21, 22, 23

### 77-1141 Wrought Box Strike



- For both curved and flat lip strikes
- Optional: Specify WBS- when ordering with lock
- If ordering separately, use part # 77-1141



# Mechanical Options

## Mechanical Options:

Add Strength	<b>3-</b>	Stainless steel hubs with in the mortise lock
Strike Option	<b>23-</b>	4-7/8" (124mm) ANSI flat lip strike
	<b>OBS-</b>	Open Back Strike
Thick Doors	<b>31-</b>	For doors 1-7/8" (48mm) to 2-1/4" (57mm) thick – see cylinder options for limitations on door thickness. When ordering the following information is required: Location of lock within the door, door thickness - IF paneled - must specify panel thickness and panel location (inside or outside of the door) For doors thicker than 2-1/4" - consult factory.
Security Fasteners	<b>36-</b>	6 Lobe head security screws (Torx® type)
	<b>37-</b>	Spanner head security screw
Lever/Knob Combination	<b>67-</b>	Lock furnished w/knob both sides (Not available with AV- Option)
	<b>68-</b>	Lock furnished w/lever handle outside x knob inside (Not available with AV- Option)
	<b>69-</b>	Lock furnished w/lever handle inside x knob outside (Not available with AV- Option)
Tactile Warnings	<b>75-</b>	Tactile Warning - Milled levers or knurled knobs. Inside trim only (Not available with D Knobs)
	<b>76-</b>	Tactile Warning - Milled levers or knurled knobs. Outside trim only (Not available with D Knobs)
	<b>77-</b>	Tactile Warning - Milled levers or knurled knobs. Inside & outside trim (Not available with D Knobs)
	<b>85-</b>	Tactile Warning - Abrasive coating inside trim only
	<b>86-</b>	Tactile Warning - Abrasive coating outside trim only
	<b>87-</b>	Tactile Warning - Abrasive coating inside & outside trim
Anti-Vandal Trim	<b>AV</b>	Anti-Vandal Pull Trim (Not available with LS, LE3 or LE4 trim and Options M-, 31-, 68-, 69-, 76-, 77-, 86-, 87- or SG-)
Mogul Cylinder	<b>M-**</b>	Mortise Lock to accept mogul cylinder, mogul cylinder to be ordered separate from ASSA
Finish Protection	<b>CPC-</b>	Clear Powder Coat (Available over 26D & 32D finishes)
	<b>SG-</b>	MicroShield® antimicrobial clear powder coat (Available with 26D and 32D finishes; not available with AV- Option)
Box Strike	<b>WBS-</b>	Wrought Box Strike

**Note:** Cylinder Options on the following pages

\*\* Mortise Locks to accept mogul cylinders are available with these functions: 04, 05, 06, 17, 24, 25, 26, 35, 37, 38, 39, 40, 43, 45 & 55 and these Deadbolt functions: 03, 20, 21, 22 & 23

\*\* Authorized options for Mortise Locks to accept mogul cylinders are 3-, 23-, 67, 68-, 69-, 75-, 76- & 77-

# Cylinder Options

## Cylinder Options:

Categories	How to Specify	Detailed Description
Conventional Cylinder	-	SARGENT Conventional Cylinders Supplied Standard
Degree Key System	<b>DG1-*</b>	SARGENT Degree Key System Level 1 (Bump resistant with patented keys)
	<b>DG1-21-*</b>	Degree Level 1 Construction Master Keying
	<b>DG1-60-*</b>	Degree Level 1 Removable Disposable Construction Core
	<b>DG1-63-*</b>	Degree Level 1 Removable Core
	<b>DG1-64-*</b>	Degree Level 1 Removable Construction Keyed LFIC
	<b>DG1-65-*</b>	Degree Level 1 Unassembled/Uncombined Core
	<b>DG1-78-*</b>	Degree Level 1 Exposed Plug (For use with LE3/LE4 escutcheons only)
	<b>DG2-*</b>	SARGENT Degree Key System Level 2 (Geographically exclusive; bump and pick resistant)
	<b>DG2-21-*</b>	Degree Level 2 Construction Master Keying
	<b>DG2-60-*</b>	Degree Level 2 Removable Disposable Construction Core
	<b>DG2-63-*</b>	Degree Level 2 Removable Core
	<b>DG2-64-*</b>	Degree Level 2 Removable Construction Keyed LFIC
	<b>DG2-65-*</b>	Degree Level 2 Unassembled/Uncombined Core
	<b>DG2-78-*</b>	Degree Level 2 Exposed Plug (For use with LE3/LE4 escutcheons only)
	<b>DG3-*</b>	SARGENT Degree Key System Level 3 (Geographically exclusive; UL437 certified; bump and pick resistant)
	<b>DG3-21-*</b>	Degree Level 3 Construction Master Keying
	<b>DG3-60-*</b>	Degree Level 3 Removable Disposable Construction Core
	<b>DG3-63-*</b>	Degree Level 3 Removable Core
<b>DG3-64-*</b>	Degree Level 3 Removable Construction Keyed LFIC	
<b>DG3-78-*</b>	Degree Level 3 Exposed Plug (F or use with LE3/LE4 escutcheons only)	
Signature Key System	<b>10-*</b>	SARGENT Signature Key System (Not available with other key systems)
	<b>10-21-*</b>	SARGENT Signature Construction Key System (Lost Ball)
Signature Large Format Interchangeable Core (Removable Core)	<b>10-63-*</b>	SARGENT Signature LFIC (Removable) Core Cylinder
XC- Key System	<b>11-*</b>	XC Key System (Not available with other key systems, unless specified)
	<b>11-21-*</b>	XC- Construction Key System (Lost Ball)
XC- Large Format Interchangeable Core (Removable Core)	<b>11-60-*</b>	Hardware to accept XC- Permanent LFIC (Removable core), disposable plastic core provided
	<b>11-63-*</b>	Hardware provided with XC- LFIC (Removable core) cylinder - (Includes masterkeying, grand masterkeying)
	<b>11-64-*</b>	Hardware provided with keyed construction core to accept XC- LFIC (Removable) Permanent core ordered separately
XC- Small Format Interchangeable Cores	<b>11-70-7P-*</b>	Hardware to accept XC- SFIC (7-Pin) XC- Permanent cores, disposable plastic core provided
	<b>11-72-7P-*</b>	Hardware to accept XC- SFIC (7-Pin Keyed construction core provided) cylinder Permanent core ordered separately
	<b>11-73-7P-*</b>	Hardware provided with XC- Small Format 7-Pin Interchangeable core (Includes masterkeying, grand masterkeying)
	<b>11-65-73-7P-*</b>	Hardware provided to accept XC- Uncombined 7-Pin SFIC (Permanent) Core - (Packed loose)
Construction Key System	<b>21-*</b>	SARGENT Lost Ball Construction keying for Conventional, XC and Signature series (N/A with 63- or 73-)
	<b>22-*</b>	SARGENT Construction Split Key System for Conventional cylinders (Existing systems only) (N/A with 10-, 11-, 63- or 73-)

\* Options not available with 50 function lockout cylinder

**NOTE: Interchangeable core and removable core cylinders do not meet Security Grade 1 requirements.**

# Cylinder Options

**Cylinder Options:**

Large Format Interchangeable Core (Removable Core)	<b>60-</b>	Hardware to accept SARGENT Permanent LFIC (Removable core), disposable plastic core provided (Permanent cores ordered separately)
	<b>63-</b>	Hardware provided with LFIC (Removable core) cylinder - (Includes masterkeying, grand masterkeying)
	<b>64-</b>	Hardware provided with Keyed construction core to accept LFIC (Removable) permanent core (Ordered separately)
Small Format Interchangeable Cores	<b>70-*</b>	Hardware to accept 6- or 7-Pin SFIC Permanent Cores, disposable plastic core provided
	<b>72-*</b>	Hardware to accept 6- or 7-Pin SFIC (Keyed construction core provided) cylinder (Permanent core ordered separately)
	<b>73-*</b>	Hardware provided with 6-Pin SFIC (Includes masterkeying, grand masterkeying)
	<b>65-73-*</b>	Hardware provided to accept Uncombined 6-Pin SFIC (Permanent) core - (Packed loose for field keying)
	<b>65-73-7P-*</b>	Hardware provided to accept Uncombined 7-Pin SFIC (Permanent) core - (Packed loose for field keying)
	<b>73-7P-*</b>	Hardware provided with Small Format 7-Pin Interchangeable core (Includes masterkeying, grand masterkeying)
Keso & Keso F1	<b>81-*</b>	Hardware provided with housings to accept Keso (83) & Keso F1 (F1-83-) removable cores (Permanent cores ordered separately)
	<b>82-</b>	Hardware provided with SARGENT Keso Security Cylinder
	<b>F1-82-</b>	Hardware provided with SARGENT Keso F1 Security Cylinder (Patented)
	<b>83-*</b>	Hardware provided with SARGENT Keso Security Removable Core cylinder
	<b>F1-83-*</b>	Hardware provided with SARGENT Keso F1 Security Removable Core cylinder (Patented)
	<b>84-*</b>	Hardware provided with SARGENT Keso Construction Cores (Permanent cores ordered separately)
Additional Security	<b>BR-</b>	Bump Resistant Cylinder (Available with conventional & conventional XC cylinders only)
Less Cylinder	<b>LC-</b>	Less Cylinder - SARGENT supplies standard blocking rings for 1-1/8" cylinders (For longer cylinders order collars/rings separately)
Schlage Keyways	<b>SC-*</b>	Schlage C keyway cylinder, 0 bitted
	<b>SE-*</b>	Schlage E keyway cylinder, 0 bitted

\* Options not available with 50 function lockout cylinder

**NOTE: Interchangeable core and removable core cylinders do not meet Security Grade 1 requirements.**

**Note: For V-10 Cylinders and information, contact ASSA**

## How to Order 9200 Series Mortise Locks

10-	92	71	12VDC	SN	L	32D	RHR
Options*	Series	Function	Voltage	Roses/ Escutcheons	Trim	Finish	Hand
For all available options see page 17-19	92 Mortise Lock	Pages 9-14 for Details	12VDC	Pages 6 & 7	Levers & Knobs Pages 5 & 6	Below	RHR
			24VDC				RH
			Must be specified for Functions 70, 71, 72 & 73				LHR
							LH

\* Multiple options can be selected

**Note:** For M9200 Mogul Cylinder Mortise Locks specify the M- option for Mogul

Finish	Description	ANSI/BHMA
4	Satin Brass	606
26D	Satin Chrome	626
32D	Satin Stainless Steel	630

### Door Handing

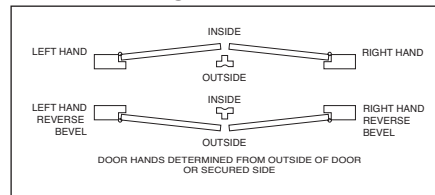

## 2.01 High Security Mortise Locksets

- A. High security mortise locks shall be 9200/M-9200 Series as manufactured by SARGENT Manufacturing Company, New Haven, CT.
- B. Locks shall meet or exceed the requirements of ANSI/BHMA A156.13 Series 1000, Operational Grade 1, and Security Grade 1 with all standard trims.
- C. Meets or exceeds impact requirements of ASTM F1577-95b Detention Locks for Swinging Doors.
  1. Paragraph 6.2 Level 1 Impact for deadbolt x latchbolt and deadbolt only.
  2. Paragraph 6.2 Level 3 Impact for latchbolt only.
  3. Paragraph 6.4 for Cylinder Cycle.
  4. Paragraph 6.6 for Mechanical Release Force.
  5. Paragraph 6.8 Mechanical Release Operation Cycle for Detention Swinging Doors.
- D. Locks shall comply with UL 10C positive pressure requirements.
- E. Locks required for fire doors shall meet UL and CUL Standard 10B, Fire Test of Door Assemblies Class A, 3 hour for single doors up to 4'0" (1.2m) x 10'0".
- F. Construction:
  1. Lock functions shall be manufactured in a single-sized case formed from 12 gauge heavy duty wrought steel.
  2. Lock cases shall be closed on all sides and back.
  3. Locks shall have field adjustable, beveled, armored front, with a .125 inch (3mm) thickness minimum.
  4. Locks shall have a one piece, stainless steel 3/4" (19mm) throw anti-friction stainless steel latchbolt.
  5. Deadbolts, where specified, shall be full one inch (25mm) throw made of hardened stainless steel.
  6. Where required by the Federal Bureau of Prisons, locks can be furnished optionally with stainless steel hubs.
- G. Locks shall have a 2-3/4" (70mm) backset, standard.
- H. Strikes shall be non-handed with a curved lip.
- I. To ensure proper alignment, trim, knobs or levers, shall be through-bolted and fully interchangeable between rose and escutcheon.
- J. Locks shall have brass 6-pin cylinder, standard.
- K. Locks shall have a ten year limited warranty.



The ASSA ABLOY Group is the global leader in access solutions. Every day, we help billions of people experience a more open world.

ASSA ABLOY Opening Solutions leads the development within door openings and products for access solutions in homes, businesses and institutions. Our offering includes doors, frames, door and window hardware, mechanical and smart locks, access control and service.

**SARGENT**<sup>®</sup>  
**ASSA ABLOY**

SARGENT Manufacturing Company  
100 Sargent Drive  
New Haven, CT 06511 USA  
800-727-5477  
[www.sargentlock.com](http://www.sargentlock.com)

Founded in the early 1800s, SARGENT<sup>®</sup> is a market leader in locksets, cylinders, door closers, exit devices, electro-mechanical products and access control systems for new construction, renovation, and replacement applications. The company's customer base includes commercial construction, institutional, and industrial markets.

Copyright © 2007-2023, Sargent Manufacturing Company, an ASSA ABLOY Group company. All rights reserved. Reproduction in whole or in part without the express written permission of Sargent Manufacturing Company is prohibited. Patent pending and/or patent [www.assaabloydss.com/patents](http://www.assaabloydss.com/patents).