

# Holders/Stops

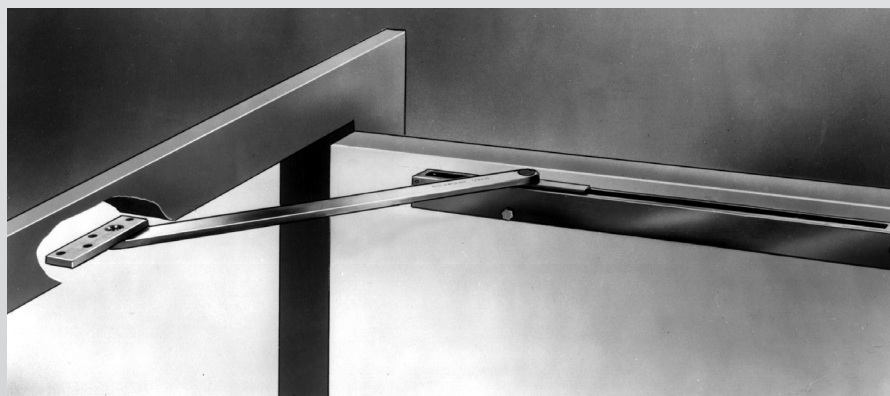

## Holders/Stops

---

Overview . . . . .	3
General Information . . . . .	4
Features and Details . . . . .	5
590 Series Heavy Duty Overhead Surface Mount . . . . .	6
690 Series Heavy Duty Overhead Concealed Mount . . . . .	7
1540 Series Standard Duty Overhead Surface Mount . . . . .	8
1530 Series Standard Duty Overhead Concealed Mount . . . . .	9
1560 Series Electromagnetic Door Holders . . . . .	10
Overhead Holders/Stops Installations . . . . .	11
Finishes & Door Closer Compatibility Chart . . . . .	12

Copyright © 2003-2024, Sargent Manufacturing Company, an ASSA ABLOY Group company. All rights reserved.  
Reproduction in whole or in part without the express written permission of Sargent Manufacturing Company is prohibited.

### On the Cover

---

590 Series Heavy Duty Surface Mount Overhead Holder  
1561 Electromagnetic Wall Mount Door Holder

# Overview

## Holders/Stops

### Introduction to SARGENT Overhead Holders/Stops

SARGENT overhead holders/stops are designed to protect the door and hardware from the abuse commonly found in commercial and institutional applications. With different series that include surface or concealed, standard or heavy duty, SARGENT has a holder/stop for every application.

Overhead holders/stops are the most robust method of stopping a door while eliminating unsightly wall stops and floor stops. An overhead door stop protects the opening by effectively distributing abusive forces. Some door closers are available with holders/stops incorporated into them and work well in most cases, but continuous abuse can lead to frame and hinge failure. SARGENT overhead holders/stops are designed and manufactured for many years of service. The 590, 690, 1530 and 1540 series come with a 5 year warranty.

### Applications

- Office Buildings
- Assisted Living Facilities
- Hotel Guest Rooms
- Public Housing
- Retail Establishments

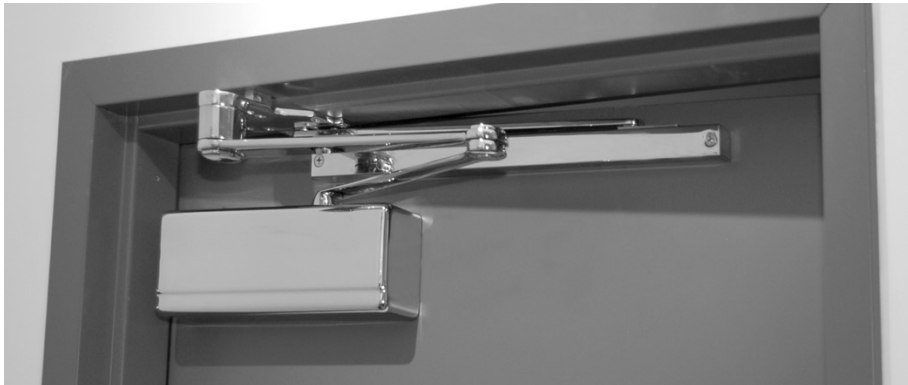

281 PD10 with 590 Series stop in a 26 finish

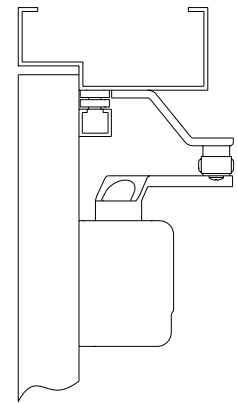

1431 P3 Shown with 1548 Stop

# SARGENT Traditional Holders/Stops General Information

## Holders/Stops

**SARGENT**  
ASSA ABLOY

### Selecting an Overhead Holder/Stop

The traditional line of Sargent Overhead Holders/Stops is unsurpassed in the industry in regards to aesthetic details and quality. The 590 heavy-duty surface applied and 690 concealed heavy-duty series are designed for use on exterior doors and highly abused interior doors. The 1530 concealed series and the 1540 surface applied series are designed for use on interior doors.

All holders/stops are templated and installed for a particular degree of opening ranging between 85° to 110°. All SARGENT overhead holders/stops include a heavy duty spring designed to gradually absorb impact forces over a 3° to 9° of opening. When using holders and stops on doors opening against a wall or back to back, they should be templated/installed to eliminate the trim from coming into contact with the walls or each other.

**When using vertical rod exit devices and or surface/flush bolts, use caution in choosing the proper size to ensure compatibility.**

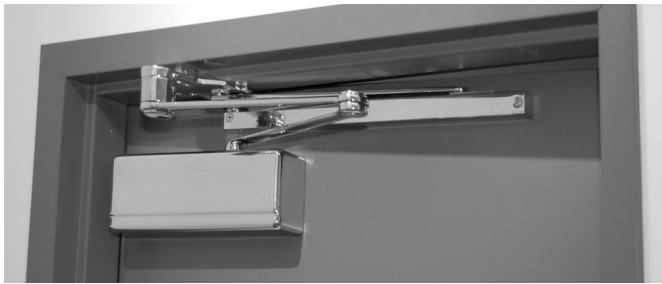

**281 PD10 with 590 Series stop in a 26 finish**

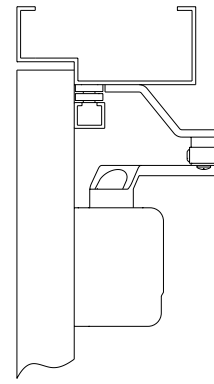

**1431 P3 Shown with 1548 Stop**

### Warranty

All 590, 690, 1530 and 1540 Series Holders and Stops carry a 5 year limited warranty for defects.

# SARGENT Traditional Holders/Stops Features and Details

**SARGENT**  
**ASSA ABLOY**

## Holders/Stops

Attention to detail and rugged design has made the SARGENT line of overhead stops and holders the premier door control products in the industry today. Our finely finished holders and stops are built from heavy gauge materials with attention to every detail. This produces a product that is strong and aesthetically pleasing.



Finished pivots



Decorative turn knob  
finished same as track



Finished end caps recessed in channel

### Features

- ANSI/BHMA Certified: All 590, 690, 1530 and 1540 series Holders/Stops are ANSI/BHMA Grade 1 Certified
- Heavy duty architectural bronze construction
- UL Classified: The 590, 690, 1530 and 1540 stops are UL 10B and UL 10C classified as a miscellaneous fire door accessories
- Corrosion resistance: Metal construction provides corrosion resistance in a variety of conditions
- Holder Selector: 590 and 690 series holders are equipped with a turn knob to activate and deactivate the hold open function
- Zinc end caps
- Through-bolts capture channel and end caps
- Heavy duty shock spring absorbs load and gradually stops door

### Aesthetics:

- Metal construction provides superior quality plated finishes
- Finished End Caps: End caps recessed into channel and finished same as channel
- Finished Rivets: Fasteners used to secure the arm to the slide and the jamb bracket are polished and finished the same as the rest of the holder
- Finished holder turn lever: SARGENT 590 and 690 holders are built with a finished holder turn knob without any exposed screws
- Finished channel corners: Corners of the channels are polished to match the rest of the arm and channel

### Convenience:

- Minimal number of sizes required to cover all door widths
- Standard holder sizes based on standard door widths
- Non-handed

# 590 Series Heavy Duty Overhead Surface Mount

Holders/Stops

**SARGENT**  
ASSA ABLOY

## Interior or Exterior – High Traffic Doors

### 590 Series

- Surface application for exterior and interior single acting doors
- Two types to choose from:
  - “H” Holder; Stops and Holds doors open
  - “S” Stop; Stops door only
- All holders/stops are installed for a particular degree of hold open or stop ranging from 85° – 110°

### ANSI/BHMA A156.8 Grade 1

590H Series BHMA Certified to CO2511  
590S Series BHMA Certified to CO2541

### UL Classified

- SARGENT 590 Series stops are UL 10B & 10C classified by Underwriter Laboratories as Miscellaneous Fire Door Accessories

**Note:** Door stops are not fire rated. The door and frame carry the fire rating

### Hold-Open Models

- Convenient knob provides simple “on-off” control of hold-open feature
- Adjustable release tension

### Accessories

#### Shims

- Optional 1/4" thick jamb bracket shims for use with frames with blade stops
- Order as required by 21-0104 x finish with screws listed below

#### Machine Screws

- Used with above 590 shims up to 3/4" thick. 01-3454 x finish, 4 required (1/4-20 x 1-1/4")
- Standard screw pack for 1-3/4" – 2" door. 21-2302 x finish

### No. 195 Angle Bracket

#### For Flush Door and Frames

590 Series holders can be mounted on flush door and frame assemblies through the use of the SARGENT 195 Angle Bracket. This handed bracket allows the mounting of the Jamb bracket to the top casing.

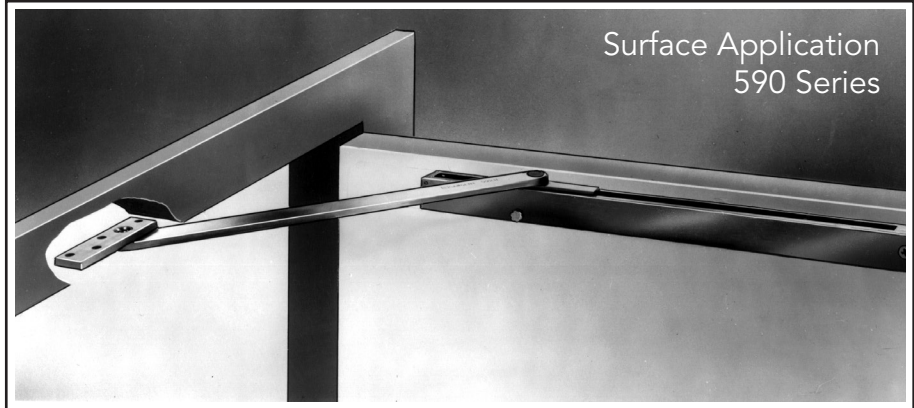

597H shown

### Specifications

<b>For Doors</b>	Exterior and interior doors from 24" – 60" wide* and for doors 1-3/4" – 2" thick standard, Available for doors up to 3-1/4" thick, use 31- option and specify thickness
<b>Finishes</b>	03, 04, 9, 10, 10B, 10BE, 10BL, 14, 15, 20D, 26, 26D EN, EB, ED, EP, EAB, and BSP
<b>Fasteners</b>	Wood screws, machine screws, through-bolts, Mortise nuts supplied as standard for 1-3/4" – 2" thick doors. For doors more than 2" and less than 3-1/4", use 31- option and specify thickness
<b>Options</b>	<b>31-</b> Doors 2-1/4" – 3-1/4" thick, specify door thickness <b>36-</b> Torx security machine screws for exposed screws on doors up to 2" thick. 6 per holder/stop <b>CPC-</b> Clear Powder Coat

\* When using vertical rod exit devices and/or surface/flush bolts, use caution in choosing the proper size to ensure compatibility

### How to Order

Specify options, number, letter designation, finish and door thickness as required.

**Example:** 31-SG-597H x 04 x 2-1/2" door

Actual Width of Door	Sizing Chart	
	Stop with Hold-open	Stop Only
24" – 32-1/2"	597H	597S
32-5/8" – 39-1/8"	598H	598S
39-1/4" and over	599H	599S

# 690 Series Heavy Duty Overhead Concealed Mount

Holders/Stops

**SARGENT**  
ASSA ABLOY

## Interior or Exterior – High Traffic Doors

### 690 Series

- Concealed application for exterior and interior single or double acting doors
- Two types to choose from:
  - “H” Holder; Stops and Holds doors open
  - “S” Stop; Stops door only
- Both series can be mounted to stop the door at any angle from 85° – 110°
- Non-handed (Reversible)

### ANSI/BHMA A156.8 Grade 1

690H Series BHMA Certified to CO1511  
690 S Series BHMA Certified to CO1541

### UL Classified

- SARGENT 690 Series stops are UL 10B & 10C classified by Underwriter Laboratories as Miscellaneous Fire Door Accessories

### Hold-Open Feature

- Convenient knob provides simple “on-off” control of hold-open feature
- Adjustable release tension

### Accessories

- Standard screw packs
  - 690H Series 21-2263 x finish
  - 690S Series 21-2267 x finish

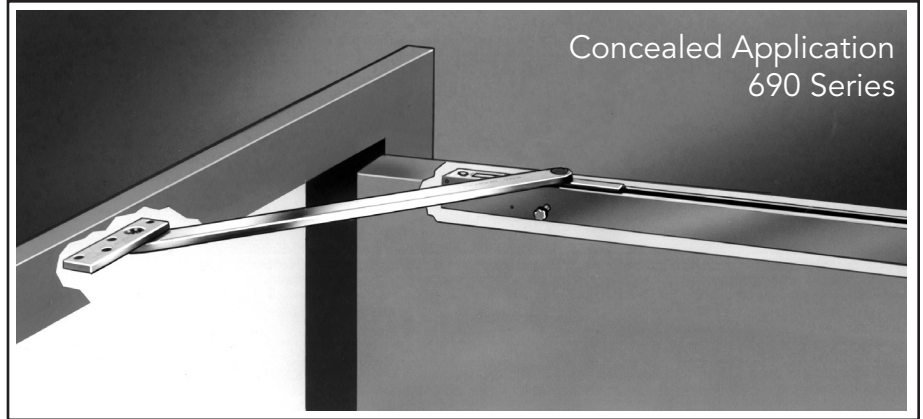

697H shown

### Specifications

<b>For Doors</b>	Exterior and interior doors from 24" – 60" wide*. For doors 1-3/8" – 1-3/4" thick standard, Available for doors up to 3-1/4" thick, use 31- option and specify thickness
<b>Finishes</b>	03, 04, 9, 10, 10B, 10BE, 10BL, 14, 15, 20D, 26, 26D, EN, EB, ED, EP, EAB, and BSP
<b>Fasteners</b>	Wood screws and machine screws provided and specify thickness
<b>Options</b>	<b>31-</b> Doors 2" – 3-1/4" thick, specify door thickness <b>36-</b> Torx Security machine screws. 8 required <b>CPC-</b> Clear Powder Coat

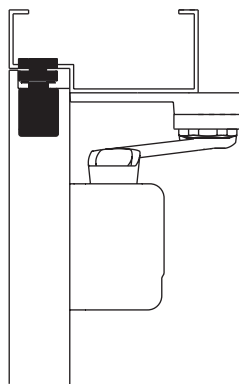

351-P10 shown with 697S on a single acting door

### How to Order

Specify options, number, letter designation, finish and door thickness as required.

**Example:** 31-CPC-697H x 03 x 2" door

Actual Width of Door	Sizing Chart	
	Stop with Hold-open	Stop Only
24" – 32-1/2"	697H	697S
32-5/8" – 39-1/8"	698H	698S
39-1/4" and over	699H	699S

\* When using vertical rod exit devices and/or surface/flush bolts, use caution in choosing the proper size to ensure compatibility

# 1540 Series Standard Duty Overhead Surface Mount

Holders/Stops

**SARGENT**  
ASSA ABLOY

## Interior – Medium Traffic Doors

### 1540 Series

- Surface application for interior single acting doors. Three types to choose from:
  - "H" Holder; Stops and Holds doors open
  - "S" Stop; Stops door only
  - "F" Friction Type; Holds door open
- Holder/Stop is surface mounted with arm and bracket attached to top jamb

### Hold Open With Stop Type:

- Holds door open for a particular degree from 85° – 110°
- Hold-open feature engages and releases easily by a push or pull action
- Release tension is easily adjustable

### Stop Only Type:

- Used to stop door with shock absorber spring
- Protects wall and door
- Maximum door opening 110°

### Friction Type:

- Prevents unwanted movement of door
- Not for use with a door closer
- Can be held in any position up to 110°
- Friction unit is made of heavy duty brake lining type material
- Adjustable friction control

### ANSI/BHMA A156.8 Grade 1

- 1540F Series BHMA Certified to C05531
- 1540H Series BHMA Certified to C05511
- 1540S Series BHMA Certified to C05541

### UL Classified

- SARGENT 1540 Series stops are UL 10B & 10C classified by Underwriter Laboratories as Miscellaneous Fire Door Accessories

**Note:** Stops are not rated. The door and frame carry the fire rating

### Accessories

#### Shims

- Optional 1/4" thick jamb bracket shims for use with frames with blade stops.

#### Machine Screws

- Order as required by 21-0198 x finish
- Used with above shims up to 3/4" thick. Four required per overhead. Order by 01-3436 x finish (12-24 x 1-1/4")
- Standard screw pack 21-2031 x finish



1548S Shown

### Specifications

<b>For Doors</b>	Interior doors 18-1/2" up to 48" wide*, 1-3/8" to 1-3/4" thick standard, Available for doors up to 2-1/4" thick, use 31- option and specify thickness
<b>Finishes</b>	03, 04, 9, 10, 10B, 10BE, 10BL, 14, 15, 20D, 26, 26D, EN, EB, ED, EAB, EP and BSP
<b>Options</b>	<b>31-</b> Doors 1-7/8" – 2-1/4" thick, specify door thickness <b>36-</b> Torx Security machine screws. 6 required <b>CPC-</b> Clear Powder Coat

### How to Order

Specify options, number, letter designation, finish and door thickness as required

**Example:** 31-CPC-1537F x 26D x 2" door

1540 Series furnished with through-bolt and grommet nut for mounting on doors, 1-3/8" – 1-3/4" thick only. For other doors up to 2-1/4" thick, specify thickness when ordering. For center hung pivots, consult factory.

Actual Width of Door	Sizing Chart		
	Hold-Open with Stop	Stop Only	Friction Holder/Stop
18-1/2" – 25"	1546H	1546S	1546F
25-1/8" – 32-1/2"	1547H	1547S	1547F
32-5/8" – 40"	1548H	1548S	1548F
40-1/8" – 48"	1549H	1549S	1549F

### No. 145 Angle Bracket

#### For Flush Door and Frames

Series 1540 Overhead Door Holders can be mounted on flush doors and frames using the No. 145 Angle Bracket. This bracket allows the mounting of the arm to the top casing. Bracket is not handed.

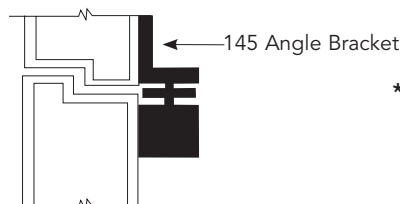

**\* When using vertical rod exit devices and or surface/flush bolts, use caution in choosing the proper size to ensure compatibility**

145 ANGLE BRACKET SHOWN WITH 1540 WITH FLUSH TRANSOM OR RABBETED DOORS



# 1530 Series Standard Duty Overhead Concealed Mount

## Holders/Stops

### Interior – Medium Traffic Doors

#### 1530 Series

- Concealed application for interior single or double acting doors opening to 110°
- Three types to choose from:
  - “H” Holder; Stops and Holds doors open
  - “S” Stop; Stops door only
  - “F” Friction Type; Holds door open
- Holder/Stop is concealed with arm and bracket mortised into jamb

#### Hold-Open With Stop:

- Holds door open for a particular degree from 85° to 110°
- Hold-open feature engages and releases easily by a push or pull action
- Release tension is easily adjustable

#### Stop Only Type:

- Used to stop door with shock absorber spring
- Protects wall and door
- Maximum door opening 110°

#### Friction Type:

- Prevents unwanted movement of door
- Not for use with a door closer
- Can be held in any position up to 110°
- Friction unit is made of heavy duty brake lining type material
- Adjustable friction control for varying conditions

#### ANSI/BHMA A156.8 Grade 1

- 1530F Series BHMA Certified to C04531
- 1530H Series BHMA Certified to C04511
- 1530S Series BHMA Certified to C04541

#### UL Classified

- SARGENT 1530 Series stops are UL 10B & 10C classified by Underwriter Laboratories as Miscellaneous Fire Door Accessories

**Note:** Stops are not rated. The door and frame carry the fire rating

#### Accessories

- Standard screw pack 21-2019 x finish

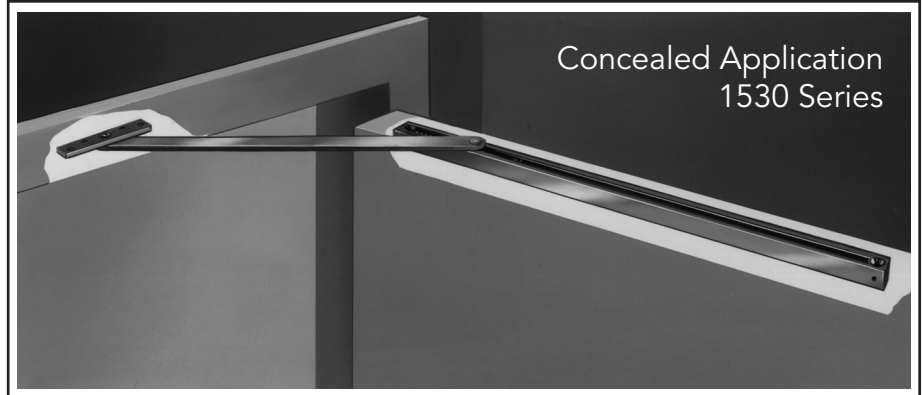

1538 S shown

#### Specifications

<b>For Doors</b>	Interior doors 19" up to 48" wide*, 1-3/8" – 1-3/4" thick, as standard. Available for doors up to 2" thick, use 31- option and specify thickness
<b>Finishes</b>	03, 04, 9, 10, 10B, 10BE, 10BL, 14, 15, 20D, 26, 26D, and EN, EB, ED EAB, EP, and BSP
<b>Fasteners</b>	Wood screws, machine screws provided as standard
<b>Options</b>	<b>31-</b> Doors 1-7/8" – 2-1/4" thick, specify door thickness <b>36-</b> Torx Security machine screws. 6 required <b>CPC-</b> Clear Powder Coat

\* When using vertical rod exit devices and or surface/flush bolts, use caution in choosing the proper size to ensure compatibility

Actual Width of Door	Sizing Chart		
	Hold-Open with Stop	Stop Only	Friction Holder/Stop
19" – 25"	1536H	1536S	1536F
25-1/8" – 32-1/2"	1537H	1537S	1537F
32-5/8" – 40"	1538H	1538S	1538F
40-1/8" – 48"	1539H	1539S	1539F

Actual Width of Door	Sizing Chart For Center Hung Pivots Only		
	Hold-Open with Stop	Stop Only	Friction Holder/Stop
21-1/4" – 26-5/8"	1536H	1536S	1536F
26-3/4" – 32-1/2"	1537H	1537S	1537F
32-5/8" – 40"	1538H	1538S	1538F
40-1/8" – 48"	1539H	1539S	1539F

#### How to Order

Specify options, number, letter designation, finish and door thickness as required.

**Example:** 31-CPC-1537F x 26D x 2" door

# 1560 Series Electromagnetic Door Holders

Holders/Stops

**SARGENT**  
ASSA ABLOY

## Electromagnetic Door Holder

- Designed for use with self-closing fire and smoke barrier doors
- Use independently or with any fire or smoke detector system
- When de-activated, helps control the spread of fire and smoke by automatically releasing doors from an open position for simultaneous closing
- Fail-safe device: When electrical power fails, doors will release to close automatically
- Conforms to devices outlined in National Fire Protection Agency Standards Nos. 80 and 101
- Designed to work with SARGENT door closers
- Recommended vertical location is on top rail of door – within 6" of lock stile edge
- When applications will not allow wall or floor magnets, consult SARGENT's FireGuard catalog for our line of Electronic Closer Holders
- Fits standard outlet box
- Holding force – 35 lbs typical
- Voltage and Current:  
120 VAC, 60 Hz., .020 amp  
24 VAC/DC, 60 Hz., .020 amp  
12 VDC, .040 amp
- Finish – EN
- Meets ANSI/BHMA A156.15
- UL Listed to U.S. and Canadian safety standards
- 1" (25mm) extension p/n 52-2573 included standard to increase armature projection to 2-5/8" (67mm)
- Order as:  
1561 for Flush Mount  
1560 for Surface Mount  
1562 for Single Floor Mount  
1563 for Double Floor Mount

## Wall Mount

### 1561 Flush Mount

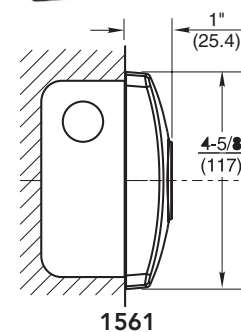

### 1560 Surface Mount

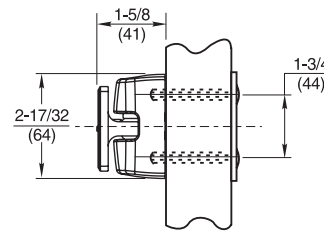
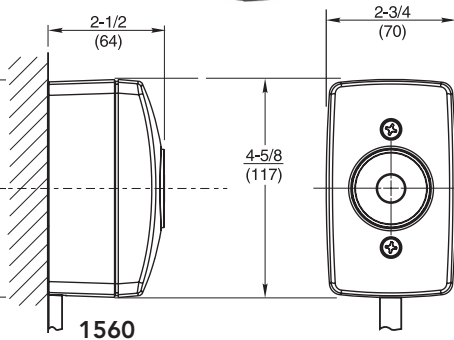

## Floor Mount

### 1562 Single Floor Mount

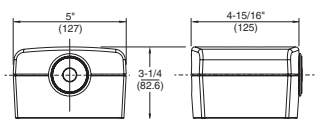

1562

### 1563 Double Floor Mount

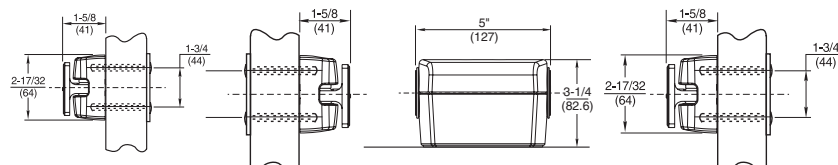

1563

Copyright © 2003-2024, Sargent Manufacturing Company, an ASSA ABLOY Group company. All rights reserved. Reproduction in whole or in part without the express written permission of Sargent Manufacturing Company is prohibited.

90124 04/24

10

1-800-727-5477 • www.sargentlock.com

Experience a safer  
and more open world

# Overhead Holders/Stops Installations

## Holders/Stops

### Concealed Mounting (690 or 1530 Series)

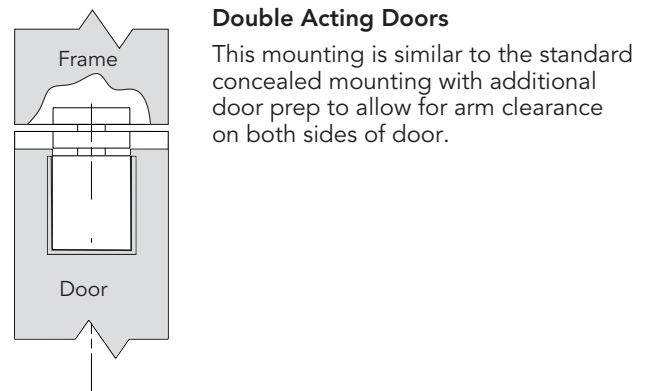
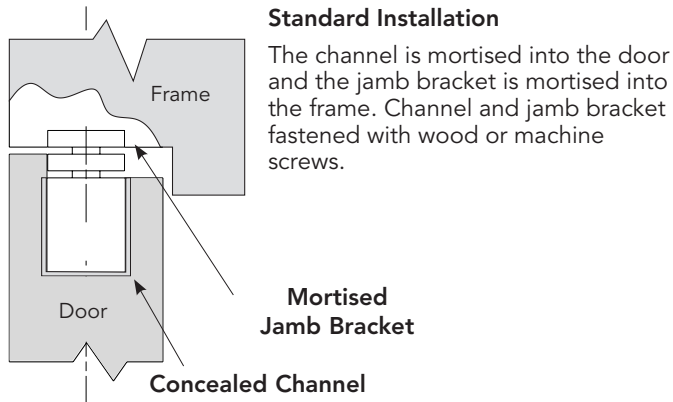

### Surface Mounting (590 or 1540 Series)

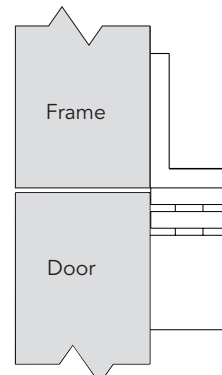
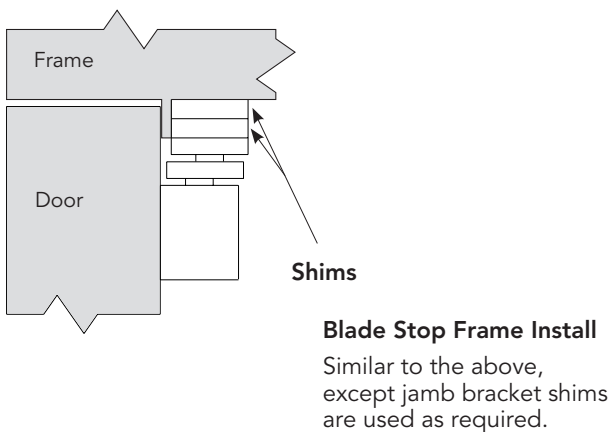
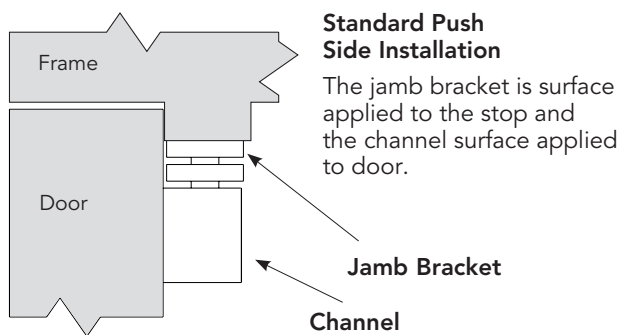

**Flush Frame Push Side Installation**

Use the 145 angle bracket for the 1540 series or 195 angle bracket for the 590 series.

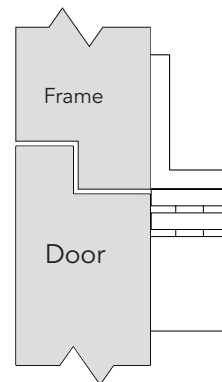

**Flush Frame Pull Side Application**

Use the 145 angle bracket for the 1540 series.

# Finishes & Door Closer Compatibility Chart

## Holders/Stops

**SARGENT**  
ASSA ABLOY

Note: EN Finish standard for 1560 Series, consult factory for other painted colors

### Frequently Used SARGENT Door Closers with Overhead Holders and Stops

- **Standard Door Closer Applications (PULL SIDE MOUNT)**

590 Series with 281, 351, 1431 Series with "O" Arm  
690 Series with 281, 351, 1431 Series with "O" Arm  
1530 Series with 281, 351, 1431 Series with "O" Arm  
1540 Series with 281, 351, 1431 Series with "O" Arm

- **Parallel Arm Door Closer Applications (PUSH SIDE MOUNT)**

590 Series with 281, 351, 1431 Series with "P3" Arm  
690 Series with 281, 351, 1431 Series with "P9" Arm  
690 Series with 281, 351, 1431 Series with "P10" Arm  
1530 Series with 281, 351, 1431 Series with "P9" Arm  
530 Series with 281, 351, 1431 Series "P10"  
1540 Series with 281, 351, 1431 Series with "P3" Arm

- **Parallel Arm Door Closer Applications Used with a Flush Frame**

590 Series with 281, 351, 1431 Series with "P4" ARM  
690 Series with 281, 351, 1431 Series with "P4" ARM  
1530 Series with 281, 351, 1431 Series with "P4" ARM  
540 Series with 281, 351, 1431 Series with "P4" ARM

- **Inverted Top Jamb Applications**

590, 690, 1530, 1540 Series with 281, 351, 1431 Series and "O" OZ, OZA arm

**Note:** This chart is only a quick reference. Some applications may require the use of 145 or 195 angle bracket

**Contact factory for special applications.**

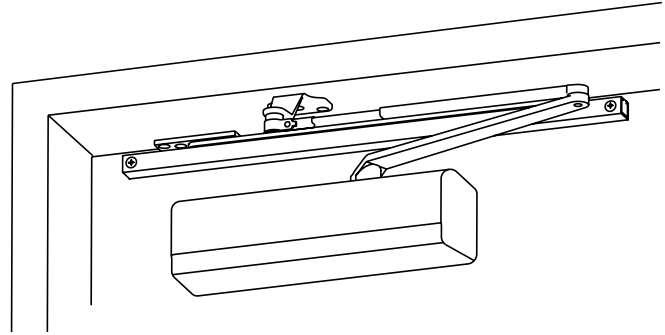

1430-P3 Shown w/1548S

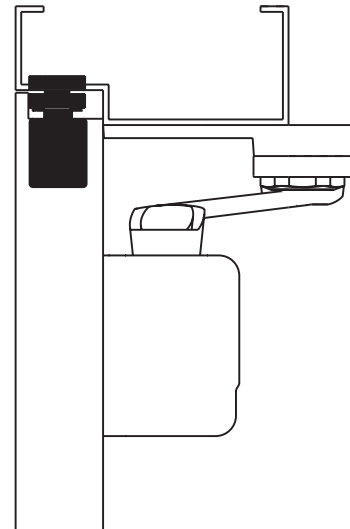

351 P10 Shown w/697S



The ASSA ABLOY Group is the global leader in access solutions. Every day, we help billions of people experience a more open world.

ASSA ABLOY Opening Solutions leads the development within door openings and products for access solutions in homes, businesses and institutions. Our offering includes doors, frames, door and window hardware, mechanical and smart locks. access control and service.



SARGENT Manufacturing Company  
100 Sargent Drive  
New Haven, CT 06511 USA  
800-727-5477  
[www.sargentlock.com](http://www.sargentlock.com)

Founded in the early 1800s, SARGENT® is a market leader in locksets, cylinders, door closers, exit devices, electro-mechanical products and access control systems for new construction, renovation, and replacement applications. The company's customer base includes commercial construction, institutional, and industrial markets.  
Copyright © 2003-2024, Sargent Manufacturing Company, an ASSA ABLOY Group company. All rights reserved. Reproduction in whole or in part without the express written permission of Sargent Manufacturing Company is prohibited. Patent pending and/or patent [www.assaabloydss.com/patents](http://www.assaabloydss.com/patents).