

XC Series Cylinders



Table of Contents

SimpleK Master Key System and Key Management Software..... 3
SimpleK Software Order Form 4
Features, Benefits & Components 5
Bored & Auxiliary Lock Cylinders 6
Mortise/Rim Cylinders, Rosettes & Blocking Rings..... 7
11-6300 Series Large Format Interchangeable Cores (Removable) 8
11-6300 Cylinder/Lock Conversion Parts, Tools & Accessories 9
11-7P-7300B Small Format Interchangeable Cores..... 10
Construction Master Keying 11
Key Control Comparison & Key Blanks..... 12
Cylinders & Components 13
Architectural Specifications & How to Order..... 14

SARGENT Cylinder & Key Control Products

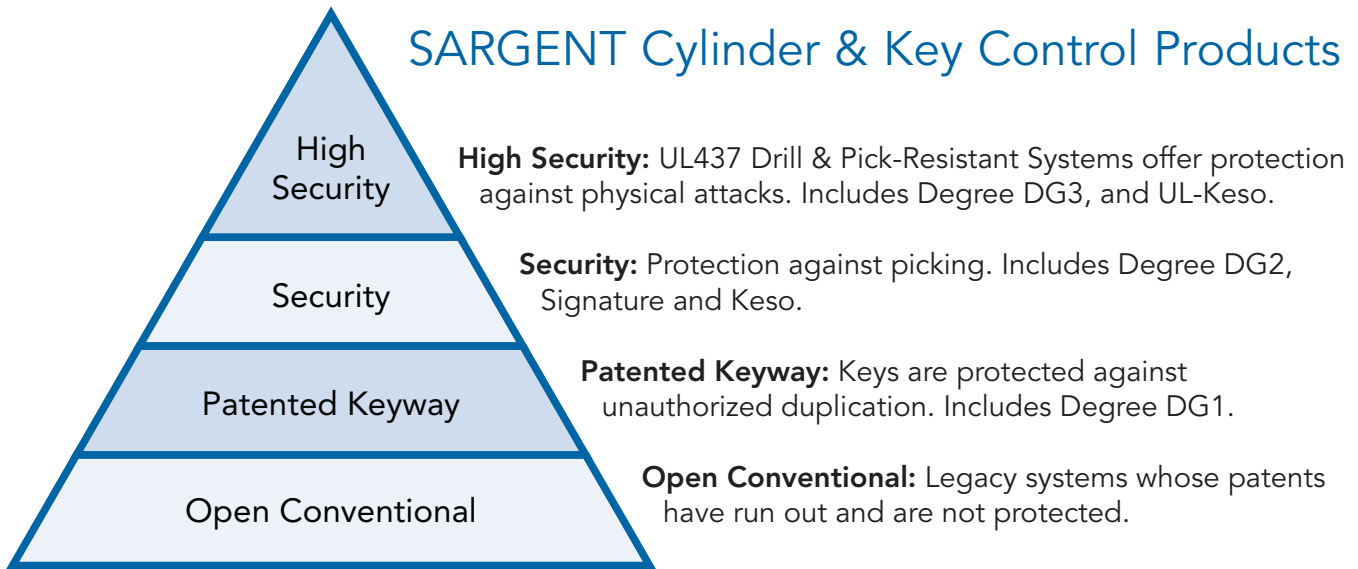

See product catalogs for more information

On the Cover

- XC 41 Mortise Cylinder
- XC 7P-7300B Small Format Interchangeable Core
- XC 10 Line Cylinder

SimpleK Master Key System and Key Management Software

XC Series

SARGENT
ASSA ABLOY

SimpleK

SimpleK is a flexible and intuitive software program that streamlines and simplifies the complexities of managing master key systems, keys, and facilities. It combines all tools needed by locksmiths, facility managers, security officers, and anyone else involved in the key management processes.

The software provides total key control with audit trails, outstanding keys, overdue keys, tools for the rekeying process, and more. SimpleK software allows you to import maps and floor plans to see who has access to each individual door, the associated keys, and hardware on the opening.

SimpleK allows you to manage keys and keying systems of all sizes and types. This includes: Medeco, Corbin Russwin, ASSA ABLOY ACCENTRA™, SARGENT, ASSA, ABLOY, Schlage®, Best®, and many others.

Features:

- Advanced tools for locksmithing and key control
- Manage all key systems (unlimited number of records)
- Robust import tools to bring current data into SimpleK
- Interactive floor plans
- Master key system design and expansion
- Key requests, approvals, issuances, and returns workflow
- Cylinders and core pinning (verifies key interchange)
- Door-Key association visualization and rekeying solution
- Easily identify keys, access, and hardware on openings
- Visibility to audit trails and outstanding/overdue keys

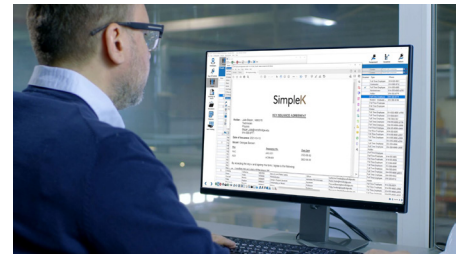

SimpleK – Standard Edition	
Description	Part Number
Primary License (3 users)	SMK040-30
Updates & Support Plan on Primary License, 1 year	SMK040-31

SimpleK – Professional Edition	
Description	Part Number
Primary License (3 users)	SMK042-30
Additional license	SMK042-32
Updates & Support Plan on Primary License, 1 year	SMK042-35
Updates & Support Plan on Additional License, 1 year (per Add. Lic.)	SMK042-33

Add-On Modules	
Description	Part Number
Item Tracking	SMK032-31
Web Interface	SMK032-33
Room Management	SMK032-35
Mobile Applications	SMK032-37

For more information, customer service or technical support, please call SimpleK at 800-315-0454 or visit www.simplek.com.

SimpleK Software Order Form

XC Series

Form is required for all SimpleK Software orders.

Brand*	
Distributor Purchase Order Number*	
Distributor Account Number*	
Part Number*:	<p>Standard Edition</p> <p><input type="checkbox"/> SMK040-30 Primary License (3 users)</p> <p><input type="checkbox"/> SMK040-31 Updates & Support Plan on Primary License, 1 year</p> <p>Professional Edition</p> <p><input type="checkbox"/> SMK042-30 Primary License (3 users)</p> <p><input type="checkbox"/> SMK042-32 Additional license</p> <p><input type="checkbox"/> SMK042-35 Updates & Support Plan on Primary License, 1 year</p> <p><input type="checkbox"/> SMK042-33 Updates & Support Plan on Additional License, 1 year (per Add. Lic.)</p> <p>Add-On Modules</p> <p><input type="checkbox"/> SMK032-31 Item Tracking</p> <p><input type="checkbox"/> SMK032-33 Web Interface</p> <p><input type="checkbox"/> SMK032-35 Room Management</p> <p><input type="checkbox"/> SMK032-37 Mobile Applications</p>
<p>To receive your SimpleK license and download link with instructions for your new software package, the following End User Information is required:</p>	
Company/Institution Name*	
Mailing Address*	
City*	
State/Province*	
Zip/Postal Code*	
Country*	
Primary Point of Contact*	
Telephone*	
Email Address where license and download link will be sent*	

*Required field

Features, Benefits & Components

XC Series

The XC Series offers a new dimension in higher security cylinders and key control. The system features specially designed keys which operate XC Cylinders and Conventional cylinders in one key system. XC Series cylinders can be integrated into most existing SARGENT systems (contact key records for compatibility) or as a new system. Multiple security levels are available to provide key control, convenience and service that meet the demands of each installation.

SARGENT offers bump resistant cylinders that employ specially engineered patent pending pinning components designed to resist bumping while maintaining the cylinder's strength.

The bump resistant feature is available for the following cylinders (6 pin only).

- Mortise, Rim & Bored Cylinders: Conventional and XC (11-)

Features

- Protected XC- 6 pin conventional cylinders, XC- large format interchangeable core cylinders and XC- 7 pin small format interchangeable core cylinders in 4A keyway along with key blanks are sold only through authorized SARGENT distributors
- Precision built to extremely close tolerances and the highest standards of quality
- Captive independent locking mechanisms are controlled by the XC key
- Standard cylinder pins are complemented by the independent XC Locking Slide Pin and activated only by the XC Key
- Available in finished locks, complete cylinder assemblies and shell/plug components
- Available in standard SARGENT keyways L and R families only
- XC keys can be cut to operate non-XC conventional cylinders
- XC key blanks can easily be cut on standard key duplicating machines
- XC Cylinders are available with Bump Resistant Pins by specifying BR- Option
- XC Cylinders can be upgraded in the field with Bump Resistant Pins with the Bump Resistant Re-pinning Kit (437BR Kit)
- Available with and for most SARGENT products in conventional, construction, SFIC and LFIC cylinders
- Consult individual product catalogs for availability

Benefits

- 7 Pin Small Format Interchangeable Cores in SARGENT 4A & 4B keyways only
- Increased security and key control by limiting unauthorized duplication
- Versatile design for new systems; retrofits most existing key systems. Consult factory for compatibility. Easily field keyed and maintained. Ideal for new construction.
- Cost effective method to increase security of existing systems without having to install a completely new system
- Security of a system can be increased where needed without having to issue all new keys
- Maintain and expand existing key systems using similar SARGENT products
- The interchangeable core option allows for fast and easy keying without having to disassemble the lock from the door or cylinder from knob/lever
- XC also available in 6300 (LFIC) removable cores for fast, easy rekeying without disassembling the hardware. Not available with all existing hardware. Some mortise locks and rim cylinders may require modification. Only 8 Line and bored locks that use removable tail pieces will require new tail pieces. See page 9 for compatibility.
- Easily field keyed with standard pinning kits

Components

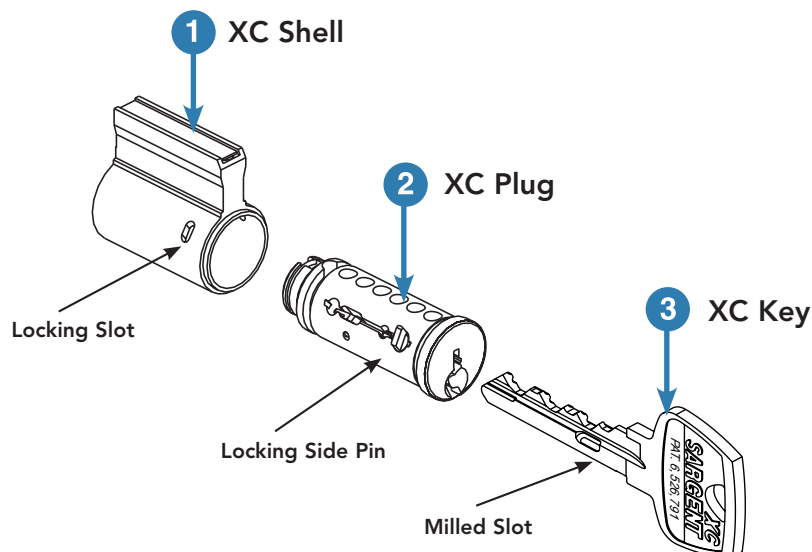

1 XC Shell*

The locking slot in the XC shell accepts the plug's locking side pin preventing the plug from rotating when engaged. The XC key with the properly cut and side mill inserted into the plug allows the plug to rotate freely in the shell.

2 XC Plug*

The XC plug is factory loaded with captive locking side pin mechanism which extends into the XC shell, preventing rotation until a properly milled key is inserted.

3 XC Keys*

The XC key has a side milled slot to activate the locking side pin mechanism in the XC plug. The key's milled slot location is determined by keyway use. Standard key cutting can be done in the field on XC keys. The XC keys will operate standard SARGENT, non-XC cylinders. Two keys are provided standard with each cylinder.

Cylinders supplied to existing keys systems are not supplied with control, emergency of master keys unless specified on the order.

Experience a safer
and more open world

Bored & Auxiliary Lock Cylinders

XC Series

SARGENT
ASSA ABLOY

Shell & Slide Assembly

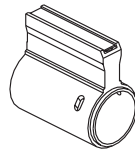

Plug Assembly

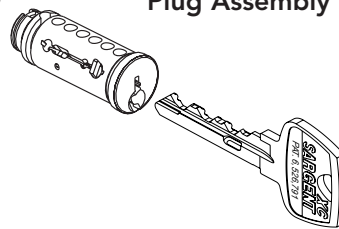

Bored Locks

Locks	Complete 6 pin Assembly	Plug Assembly	Shell & Slide Assembly
T-Zone (11 Line)	11-C11-1	13-4332	13-4334
10X Line	11-C10X-1	13-4332	13-4334
10 Line	11-C10-1	13-4332	13-4334
9 Knobs***	11-C8-1	13-4331	13-4335
8 Knobs***	11-C8-1	13-4331	13-4335
8L ***	11-C10-1	13-4332	13-4334
7600 ***	11-C7600-1	13-4312	13-4339
7 Knobs***	11-C8-1	13-4331	13-4335
7 Line	11-C10-1	13-4332	13-4334
6500	11-C10-1	13-4332	13-4334
6 "B" Knob	11-C6-1B	13-4332	13-4336
6 "S", "N" Knobs	11-C6-1	13-4332	13-4336
5500	11-C5500-1	13-4328	13-4338
8X Line	11-C8X-1	13-4328	13-4338

*** Discontinued Product Line

- Available for all functions except 50 function
- Plug finishes: 4, 15, BSP

Note: Use SARGENT 437 C pinning kit for field rekeying

For masterkeyed orders include Keyed Order Leadsheets with keying details as found in General Information section of price book. Parts shown on this page are unique to the XC feature. These plugs and shells cannot be used with non-XC components.

For all other cylinder components, refer to the standard Cylinder & Components section.

XC 11- option not available with 10-, 22-, 51-, 52-, 82-, 83-, 84-, SC- or SE- options.

11 758/858 Padlock Features

- 758-Key Retaining. Key can only be removed when padlock is in locked position.
- 858-Non-Key Retaining. Key can be removed when padlock is unlocked. Key not required to relock padlock (snap locking).
- Cylinder easily removed while in the unlocked position for rekeying
- 6 pin cylinder standard
- Shackle locked by dual ball bearings
- All shackles 5/16" (8m) diameter
- Optional 11-63 XC LFIC (removable) core available

Complete Padlock	11-758/858 x Shackle height
Shackle Height (closed)	1" (25mm) standard, 2" (51mm) (-2 suffix) and 4" (102mm) (-4 suffix)
Shackle Material	Stainless steel -standard Boron hardened steel (-HS suffix) Brass chain 9" (228mm) long (-C suffix)
Cylinder assembly with tail piece	13-4584
Plug assembly	13-4332
Shell & Slide assembly	13-4334
Tail piece only	13-1230

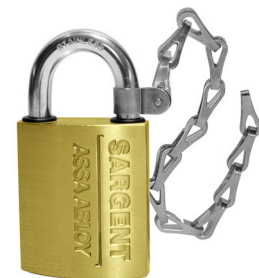

11-758-C Shown
(Optional chain shown)

Note: XC 11- option not available with 10-, 22-, 51-, 52-, 82-, F1-82-, 83-, F1-83-, 84-, SC- or SE- options.

Mortise/Rim Cylinders Rosettes & Blocking Rings

XC Series

SARGENT
ASSA ABLOY

11-40 Series Mortise Cylinders

Complete 6 pin Assembly	Dim. X Length Under Cylinder Head	Plug Assembly	Shell & Slide Assembly
11-41	1-1/8" (29mm)	13-4314	13-4301
11-42	1-1/4" (32mm)	13-4315	13-4302
11-43	1-3/8" (35mm)	13-4316	13-4303
11-44	1-1/2" (38mm)	13-4317	13-4304
11-46	1-3/4" (44mm)	13-4318	13-4305
11-48	2" (51mm)	13-4319	13-4306
11-50	2-1/4" (57mm)	13-4320	13-4307
11-52	2-1/2" (64mm)	13-4321	13-4308
11-54	2-3/4" (70mm)	13-4322	13-4309
11-56	3" (76mm)	13-4323	13-4310

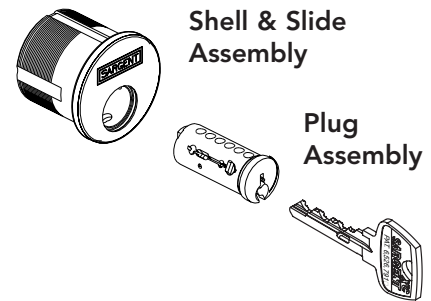

- Cylinder: Solid brass, 1-5/32" (29mm) diameter
- Cap: Brass, bronze or stainless steel
- Available for all functions, except 50 function
- Optional Collars/Spacers available and ordered separately, refer to product catalogs for additional information
- Mortise cylinder assemblies that are ordered without hardware are supplied with standard SARGENT offset cam 13-0664
- Cylinder finishes: 3, 4, 9, 10, 10B, 10BE, 10BL, 14, 15, 20D, 32, 32D, BSP, WSP
- Plug finishes: 4, 15, BSP

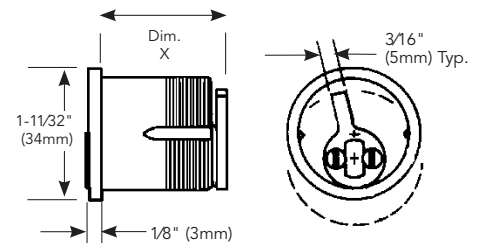

Note: Use SARGENT 437C pinning kit for rekeying

For masterkeyed orders include Keyed Order Leadsheets with keying details as found in General Information section of price book Parts shown on this page are unique to the XC feature. These plugs and shells cannot be used with non-XC components.

For all other cylinder components, refer to the standard Cylinder & Components section.

XC 11- option not available with 10-, 22-, 51-, 52-, 82-, 83-, 84-, SC- or SE- options.

Optional Cams for 11-40 Series Mortise Cylinders*



Standard Cam
(13-0664)

Standard Cam
11-41 thru 11-56



#105
(13-0665)

Short cam for 8292
and 8216 functions
inside only



#101
(13-0512)

Adams Rite
1850, 4700



#113
(13-0921)

SARGENT 4370 Series
key switches



#106
(13-0938)

"Open" Schlage "L"

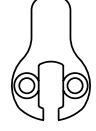

#112
(13-0097)

"Open" Misc.

* Two screws are used to attach cam, if needed order P/N 01-1121

11-34 Rim Type Cylinders

- Complete assembly (6 pin), specify 11-34
- Plug assembly, specify 13-4312
- Shell & slide assembly, specify 13-4299
- 27/32" (21mm) screw pattern for through-bolted SARGENT exit devices
- Cylinder: Solid brass
- Cap: Brass, bronze or stainless steel
- Cylinder finishes: 3, 4, 9, 10, 10B, 10BE, 10BL, 15, 20D, 32, 32D, BSP, WSP
- Plug finishes: 4, 15, BSP

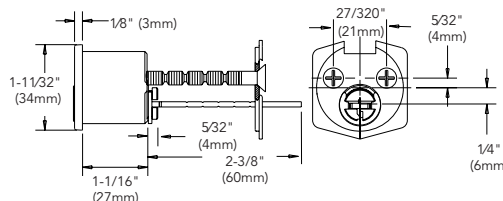

432 RC - Large Format Interchangeable Core Installation Tool

432 IC - Small Format Interchangeable Core Installation Tool



The 437BR Kit is used to convert existing cylinders into bump resistant cylinders. Simply replace the drivers and springs in all chambers. Each kit includes 300 pins for use in mortise/rim cylinders, 300 pins for use in KIK/KIL cylinders and 600 springs.

- Assists in the installation of Interchangeable Core cylinder bodies
- Assists in threading the cylinder body into the mortise lock
- Used to check the function of the cylinder in the lock before installing the cylinder core

Experience a safer
and more open world

1-800-727-5477 • www.sargentlock.com

7

11- 6300 Series

Large Format Interchangeable Cores (Removable)

XC Series

SARGENT
ASSA ABLOY

SARGENT XC 6300 Large Format Interchangeable Core (Removable) Cylinders offer a quick and easy method to change cylinders for increased security. The lock does not need to be removed from the door to rekey the opening. The XC core offers a cylinder option for full size LFIC (removable) core SARGENT cylinders.

Note: The XC cores will only work in SARGENT hardware ordered to accept them with the 11-60 or 11-63- or will need to be upgraded in the field. Mortise and rim cylinder housings made with shorter version posts to accept the 11-6300 core can be used without modification. Not all lever style bored locks will accept this 11-6300 core. Only products with removable tail pieces that insert in the back of the core are compatible by using with new tail pieces. Existing 480 Deadbolt Series will require conversion. See page 9 for compatibility and parts needed to upgrade existing hardware to accept the 11-6300 core.

11-63- Option Permanent LFIC (Removable) Core Cylinders

- SARGENT XC LFIC (Removable) Core Cylinders and Master Key Systems are available for a quick change of cylinders for increased security. It is not necessary to remove the lock from a door to rekey the opening.

This XC core offers a cylinder option for full size removable core SARGENT cylinders. These XC cores will only work in hardware ordered to accept them with the 11-60 or 11-63- or will need to be upgraded in the field. See the next page for parts needed and SARGENT hardware available for upgrading to XC 6300s.

- Special "control key" (catalog P/N X6272 CTL) is used to release a locking cam allowing immediate removal of the core
- Available for use in many SARGENT products (Exit Devices, Mortise locks, Bored locks and padlocks)
- Can be master or grandmaster keyed
- 6-Pin only
- 1 bitted available for field keying
- 1 bitted cylinders supplied with 2 key blanks, pins and springs in chambers in 3 and 4 only
- Wide variety of master key systems available
- Permanent (keyed removable) cores supplied with hardware unless specified otherwise



- Available in the following SARGENT keyway families: L & R families only.
- Finishes: 4, 15, BSP
- When ordering, use Cat # 11-6300; include finish.
- For masterkeyed orders include Keyed Order Leadsheets with keying details as found in General Information section of price book
- Request Control Key (X6272CTL) if required
- 1 bitted cylinders only pinned with pins and springs in the 3rd and 4th chambers. Two key blanks provided

11- 60- Option Disposable Plastic Core



- During the construction phase in non restricted areas, disposable plastic cores can be used, eliminating use and distribution of the actual keys
- Order hardware with 11-60 to accept 11-6300 permanent cores ordered separately
- Once construction is near completion, the permanent keyed cores will be installed and the building secured; permanent keyed cores are ordered separately
- Disposable cores are typically used on interior doors
- Operate with coin or flat screw driver
- One piece design allows for easy installation
- To order plastic temp. core separately: Use p/n 13-5177

11- 64 Option Construction Keyed LFIC Keyed Cylinders

- The SARGENT 11-6400 LFIC brass construction core (order 11-64- Option with SARGENT products) enables doors to be locked during project construction period
- Using 11-6400 cores prevents keys for the permanent key system from becoming available during the construction process
- After construction is completed, the 11-6400 brass cores are removed and replaced with 11-6300 keyed permanent LFIC cores
- A special control key releases the locking sleeve of the cylinder core allowing immediate removal of the core
- Construction cores are all keyed alike in one KA keyset
- Furnished with 6 keys and 1 control as standard
- Plug face dimpled for easy identification

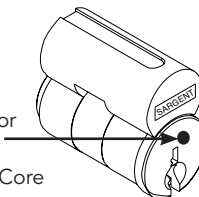

6400 Brass Core

11-6300 Series Parts Only

- 13-4326 Plug, Finishes: 4, 15, BSP
- 13-5175 Inner Shell & Slide Assy, Finishes: 4, 15, BSP
- 13-0796 Control Sleeve
- 01-0660 Plug retaining ring
- 13-1341 Slide for Cylinders WITHOUT a box around the word SARGENT (Mfg after 3/06)

Uses the same pins and principles of 6300 cores, For pins, springs and keying kits see page 17 and 18 of conventional catalog pages 17 & 18.

11- 63-34 Rim Cylinder

- Housing: Solid brass
- Cap: Brass, bronze or stainless steel
- Optional collars are offered and to be ordered separately, consult individual catalogs for more details
- Includes the same tailpiece and screw hole pattern as the #34 cylinder
- Finishes: 3, 4, 9, 10, 10B, 10BE, 10BL, 14, 15, 20D, 32, 32D, BSP, WSP

11-63-40 Series Mortise Cylinders

- Cylinder: Solid brass 1-5/32" (29mm) diameter
- Cap: Brass, bronze and stainless steel
- See 11-6300 cam options on page 9
- Available in the following lengths:

Cylinder #	11-63-42	11-63-43	11-63-44	11-63-46
Length	1-1/4" (32mm)	1-3/8" (35mm)	1-1/2" (38mm)	1-3/4" (44mm)



- Optional Collars/ Spacers available and ordered separately, refer to product catalogs for additional information
- Other SARGENT keyways available
- Finishes: 3, 4, 9, 10, 10B, 10BE, 10BL, 14, 15, 20D, 32, 32D, BSP, WSP

11-60- Mortise Cylinders

- 11-60-42- up to size 46 same as above, but supplied with plastic disposable plastic core

11-6300 Cylinder/Lock Conversion Parts Tools and Accessories

XC Series

SARGENT
ASSA ABLOY

60-34 Rim, 8-Line and 480 Series Conversion Parts

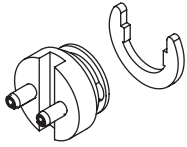

Kit # 13-5178
for 11-63-34 Rim Cylinders

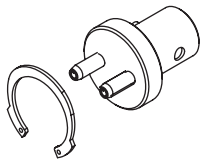

Kit # 08-5265
for 11-63-8-Line Knobs

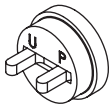

Kit # 16-2519 for
Cam Assembly
for 11-63-Deadbolts

Cams for 11-6300 Large Format Interchangeable (Removable) Core Mortise Cylinders (Factory assembled to housing)

- 6300 Cams are factory installed and are not removable
- 6300 Cams are not sold separately
- Specify required Cam as a suffix: 63-44-105 cam
- For Standard Cam: No Suffix is required



Standard

6300 Series
Cam



#105

Cam for
6300 Series
16 & 92
mortise
function
locks



#115

Cam for
6300 Series
50 function
locks



#101

ADAMS
RITE
1850 4710



#104

ADAMS
RITE 4050,
4150, 4250,
4350,
4070, 4516



#113

4370 Series
key switch



#106

Schlage
"L"



#112

Wide
Straight

Experience a safer
and more open world

758/858 Padlocks, 11 Line (T-Zone), 10, 7, 6500 Line

Note: Only locks with removable Tail Pieces can be upgraded to 11-6300 Cores

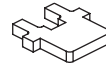

Kit # 17-2632
for Padlock

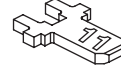
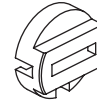

Kit # 11-5003
for 11-Line

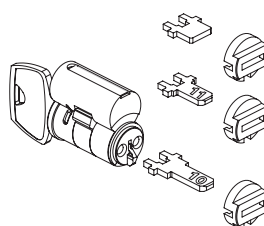
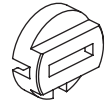

Kit # 10-3429 for
10 Line and 7 Line. 05-3125
for 6500 Series (Cylinder
Not Included)

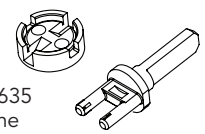

Kit # 10-3635
for 10X Line
1-3/8" - 2" Doors

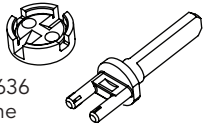

Kit # 10-3636
for 10X Line
2-1/4" Doors

436-1 Slide Block Kit

- Includes fixture and staking tool for use only with the 11- (10)- 6300 Series Cylinders manufactured after March 2006 for the ease of top loading in the field.
- The kit includes 100 each slides p/n 13-1341, Staking Block and Staking Tool.
- Cylinders manufactured after March 2006 will not include the box around the Sargent logo and can be used with this kit.

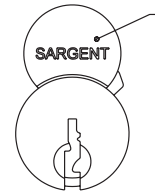
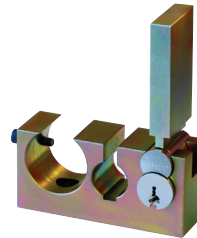

Cores
without
a box
around
the word
"SARGENT"

431-6 Shear Tool

- Tool for preparing SARGENT 60-/63- mortise cylinders to accept 11-6300 XC cores
- Use Kit # 13-5178 for upgrading rim cylinders

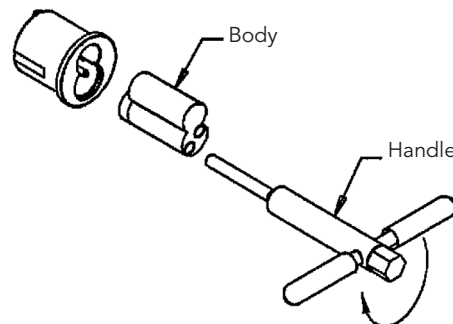

1-800-727-5477 • www.sargentlock.com

9

11-7P-7300B

Small Format Interchangeable Cores

XC Series

SARGENT
ASSA ABLOY

11-7P-7300B Series Small Format Interchangeable Core (SFIC) Cylinders: 7 Pin Only

- SARGENT XC SFIC Cylinders are protected keys and cylinders for increased security. With a control key, these cylinders can be easily removed for rekeying. It is unnecessary to remove the lock from a door to rekey the opening. For use in SARGENT hardware only. Consult individual catalogs for product availability.
 - SARGENT 11-7P Interchangeable Cores are available in SARGENT 4A and restricted 4B keyways
 - 4A Keyway will be supplied standard on new systems
 - A2 or A4 systems available
 - Existing SARGENT mortise cylinders may require core mounting pin modification, use SFIC pin shear tool (p/n: 431-7)
 - Existing SARGENT bored locks require new tail pieces to accept XC SFIC cores
- | | |
|------------------|---------|
| T-Zone (11 Line) | 11-0276 |
| 10 Line | 10-3138 |
| 7 Line | 10-3138 |
| 6500 Line | 10-3138 |
- XC 11- option not available with 10-, 22-, 51-, 82-, 83-, 84-, SC- or SE- options

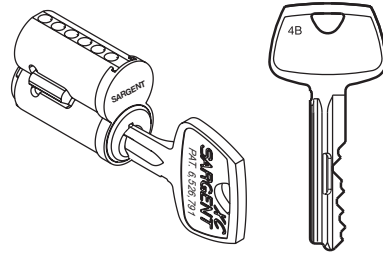

11-70- Option Disposable Plastic Construction Core For SFIC

- Used for those doors that do not require key locking during construction but will be using permanent 11-7300 B cores
- Offered in 11-70-34 Rim, 11-70-43 & 11-70-46 Mortise Cylinders and many bored locks, consult product catalogs for availability
- Operate with coin or flat screw driver
- Two piece design allows for easy installation
- To order Disposable Plastic Construction Core only, specify: 13-5174

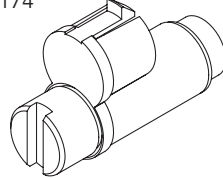

Key Blanks/Cut Keys (Nickel Silver)

- Available in quantities of 100 each
- Packed 50 per box
- SARGENT Keyways: 4A, Restricted 4B
- Order 11-X7285B x Keyway
- Cut Master key 11-X7285 BMK x Reg. # Control key 11-X7282B CTL x Reg #

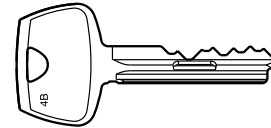

11-73-7P-34 Rim Cylinder

- Brass cylinder and housing
- Furnished with break off screws and back plate
- Housing accepts 7 pin core only
- Mounting holes located to match SARGENT hardware
- Finishes: 3, 4, 9, 10, 10B, 10BE, 10BL, 14, 15, 20, 26, 26D, BSP, WSP



11-7P-7300B Keyed Small Format Interchangeable Core

- Supplied with two nickel silver keys as standard
- Face includes SARGENT logo
- For use in SARGENT hardware only, consult individual catalogs for availability
- 11-7P-7300B (7 pin)
- If Control 11X7272 CTL or Master key 11X7282BMK is required order separately
- Finishes: 4, 15, BSP

11-65-7300B Uncombined Small Format Interchangeable Core

- Cores for field keying
- No pins, springs or key blanks provided
- No logo on face
- 11-65-7P-7300B (7 pin)
- Finishes: 4, 15, BSP
- Easily field keyed with SFIC keying kits in either the A2 or A4 pinning systems

431-7 Shear Tool

- Tool for preparing SARGENT 70-/73- mortise or rim cylinders to accept 11-7300B 7 pin XC core

11-72-7P Option Brass Small Format Interchangeable Construction Core

- SARGENT 7200 Interchangeable 7 pin brass construction core (order 11-72- option with SARGENT products) enables doors to be locked during construction
- Using 11-7200 cores prevents permanent key system keys from becoming available during construction process
- After construction is completed, 11-7200 brass cores remove and replace with 11-7P-7300 keyed-permanent interchangeable cores
- Plug face is blue for easy identification
- Special Control key (7254B CTL) releases locking sleeve of the construction core allowing for immediate removal of the core
- Construction cores are 7 pin and keyed alike
- Six (6) construction master keys (p/n 7254B CMK) and one (1) Control key included
- Cores shipped with hardware

11-73-7P-40 Series Mortise Cylinders

- Two cylinder sizes
- 11-73-7P-43, 1-3/8" (35mm) length under cylinder head (including cam)
11-73-7P-43 (7 pin)
11-70-43 (shell less core)
- 11-73-7P-46, 1-3/4" (44mm) length under cylinder head (including cam)
11-73-7P-46 (7 pin)
11-70-46 (shell less core)
- 1-5/32" (29mm) diameter housing
- Optional Collars/Spacers available and ordered separately, refer to product catalogs for additional information
- Cam is permanently staked to housing
- Housing accepts 7 pin core only
- Mortise cylinder cams operate current SARGENT hardware
- Offered with SARGENT standard offset cam only
- Hotel Function not available
- Finishes: 3, 4, 9, 10, 10B, 10BL, 14, 15, 20, 20D, 26, 26D, BSP, WSP



Copyright © 2004-2024, SARGENT Manufacturing Company. All rights reserved. Reproduction in whole or in part without the express written permission of SARGENT Manufacturing Company is prohibited. Patent pending and/or patent www.assaabloy.com/patents.

90106 05/24

10

1-800-727-5477 • www.sargentlock.com

Experience a safer and more open world

Construction Master Keying

XC Series

Cylinders ordered with construction keying will receive the 21- option Lost Ball feature. With this option, construction keying is obtained without the nuisance of going back to each cylinder and removing the construction split key when the building is turned over. The 21- cylinder is master keyed with small ball bearings in one of the chambers. The 21- plug is drilled in two places on each side of the chamber containing the balls. While the building is under construction, the master key to be used, the balls remain in the chamber above the plug.

Voiding the construction master key is accomplished by simply using the Change key, which allow the balls to fall into one of the holes on either side of the chamber. The construction master key will no longer operate the cylinder.

To Void Construction Key

Note: Ball bearings shown are for illustration purposes only. They do not stack, they align next to each other and lay flat.

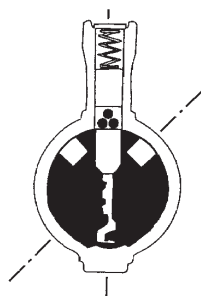

In this view, the Change Key is inserted into the cylinder's plug to void the Construction Master Key. The Change Key raises the three balls above the plug.

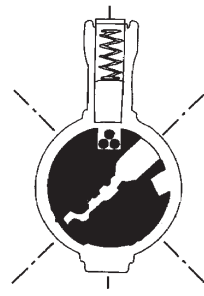

As the Change Key is rotated, the three construction balls fall into one of the holes in the plug

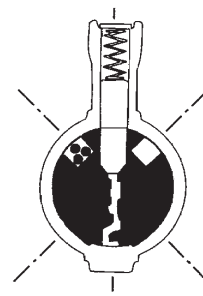

The Change Key is then rotated to the vertical position for extraction

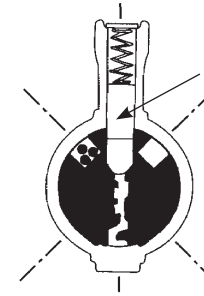

If the Construction Master Key is inserted (as shown) after being voided, it will not rotate because Driver pin now extends into the plug chamber. This prevents it from rotating and voids the Construction Master Key.

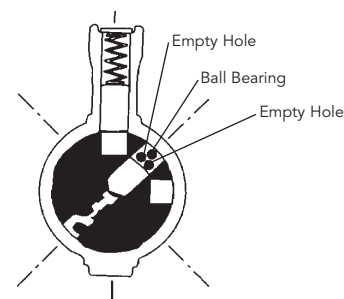

Shown above is a cross section of a 21-Option Lost Ball Cylinder with the Construction Master Key inserted and rotated.

The ball bearings lie flat with one positioned behind the other. They are not stacked.

Orders with 21- will have all change keys shipped separately from hardware.

- 21- is not available with removable core (5100, 6300 or 7300)
- Use 11-72 option for construction keying for 11-7300 cores
- 21- replaces the 22- split key, which is only available as an addition to existing 22- master keyed systems
- Use 11- 64- option cores for XC- removable core cylinders
- #439 Lost Ball Rekeying Kit allows for Field construction of 21- lost ball keying
- #439 kit includes a drilling block, knurled pin, 500 balls and drill with collar

No. 1KB Rosette



- KB Series Rosette - supplied standard with 8200 Mortise Locks and are used with mortise cylinders and No. 90 blocking rings when cylinders project from door
- Optional Collars/Spacers available and ordered separately, refer to product catalogs for additional information
- 1-1/2" (38mm) diameter (includes compression spring)
- Projection from door:

1KB-1	5/16" (8mm)
1KB-2	7/16" (11mm)
1KB-3	9/16" (14mm)
1KB-4	11/16" 16mm

No. 90 Blocking Ring



- No. 97 Rosette - supplied standard with 7900 Mortise Locks, Exit Device with pulls and cylinders ordered separately from hardware
- Optional Collars/Spacers available and ordered separately, refer to product catalogs for additional information
- 1-11/16" diameter (43mm), 9/32" (7mm) projection (includes compression spring)

Note:

Parts shown on this page are unique to the XC feature. These plugs and shells cannot be used with non-XC components. For all other cylinder components, refer to the standard Cylinder & Components section. XC 11- option not available with 10-, 22-, 51-, 52-, 82-, 83-, 84-, SC- or SE- options.

No. 97 Rosette



- 1-11/16" diameter (43mm), 9/32" (7mm) projection (includes compression spring)

Key Control Comparison & Key Blanks

XC Series

SARGENT
ASSA ABLOY

XC vs. Standard Keyway Control

NOTE: XC keys and master keys will operate non-XC cylinders.
Chart shows how XC key is fully compatible with non-XC cylinders

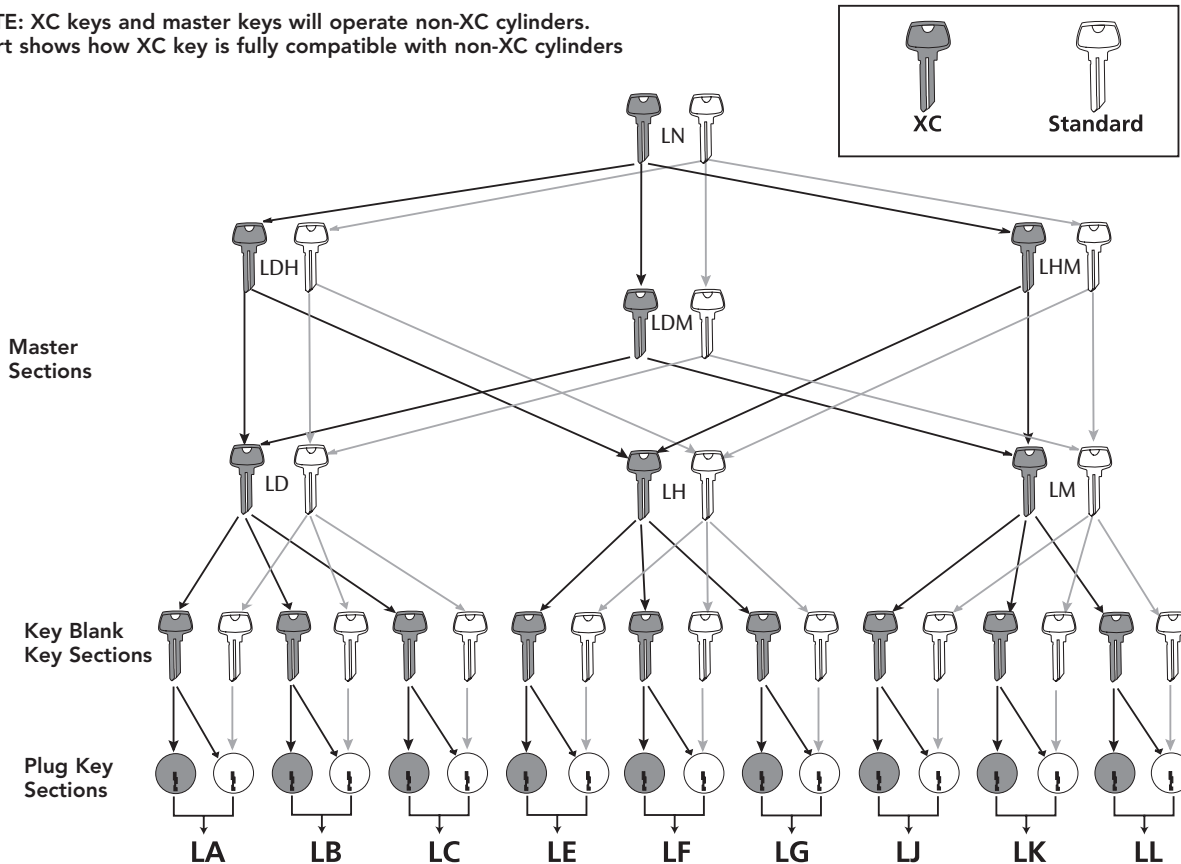

LA family shown above (also available in SARGENT R Multiplex family).

SARGENT Key Blanks

Master Key Section (6 Pin)	Day or Change Key (6 Pin)	
Catalog Number 11-X6270	Catalog Number 11-X6275	
LD	LA	RA
LH	LB	RB
LM	LC	RC
LDH	LE	RE
LHM	LF	RF
LN	LG	RG
RD	LJ	RJ
RH	LK	RK
RM		
RDH		
RDM		
RHM		
RN		

Small Format Interchangeable Core Keyways

Master/Day/Change Key (7 Pin only)
Catalog Number 11-X7285B x keyway
SARGENT 4A
SARGENT 4B (Restricted)*
* Pre approval required by SARGENT key record department

- Packed 50 per box
- Order by Catalog Number x Keyway

Visual Key Control (Stamping)

To allow for easier key and cylinder identification, SARGENT offers the option for permanent stamping of keys and/or cylinder with industry standard alpha-numeric keyset symbols.

Non-visual key control stamped change (day) keys include bitting numbers as standard, (Item A) unless specified in keying order lead sheet submitted with order requesting to be omitted and key set substituted.

SFIC and Signature change keys are stamped with key set symbols as standard.

Master level keys do not include bitting numbers. Master level keys include system register numbers stamped on the first line, and the standard visual key control designations on the second line (Item B).

Up to 7 characters available for permanent stamping for Visual Key Control

- Key and cylinder identified by industry standard alpha-numeric keyset symbols
- Concealed stamping on mortise and rim cylinders and bored lock cylinders available on the slide only (Item D or I)
- Cylinder-slide stamping available on 5100 and 6300 SARGENT LFIC (removable) cores, bored lock, mortise/rim cylinders (Item E, I D)
- Core side engraving available for 7300B Series up to 7 characters (Item F)
- Special key stampings available, such as "DO NOT DUPLICATE" or "CITY OF PHOENIX"
- XC and Signature cylinders not available with visual plug stamping
- XC and Signature cylinders available with only concealed slide stamping (Item D, E and I) only
- Signature LFIC 10-6300 available with cylinder slide stamping (Item E)

Note: SARGENT will stamp alternate identity codes on cylinders and/or keys whenever requested. This alternate stamping can not be different if both are to be stamped. Master Level Keys can also be stamped with a single alternate code

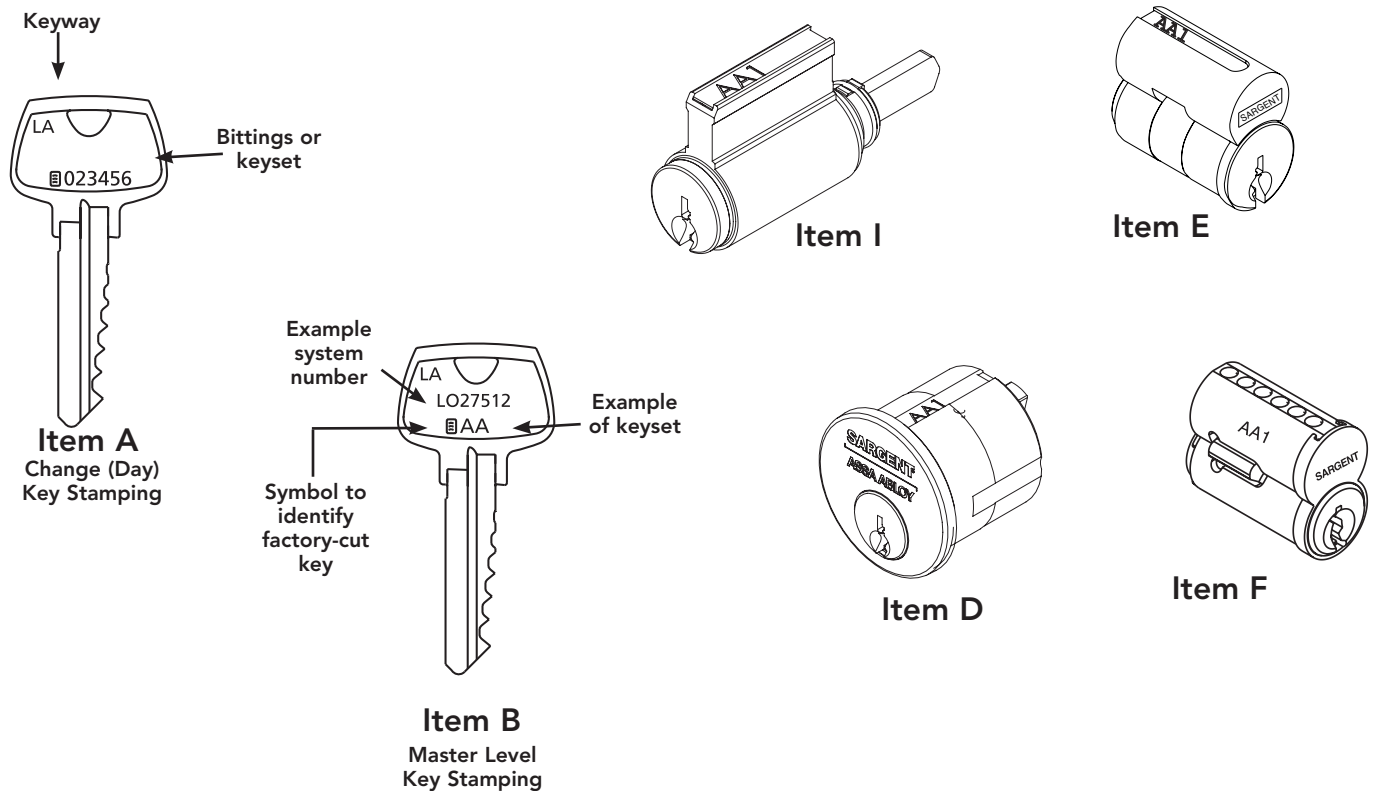

Tamper Proof Packaging

For the highest level of security for the end user, Tamper Proof Packaging is used on all Master Keys, Signature key blanks and all restricted key blanks. This heat sealed shrink wrap identified with "SARGENT Sealed For Your Security" provides assurance of the integrity of the factory generated key system.

Architectural Specifications

2.0 Cylinders, Key, and Keying – Standard Cylinders and 6300 Large Format Interchangeable Core (Removable)

A. Acceptable Manufacturer and Series (No Substitutions):

Manufacturer	Series
SARGENT	XC

B. Provide cylinders and LFIC cores that require a key which are protected from unauthorized manufacture and distribution.

C. The key design and tolerances shall permit the cutting of keys with standard code or duplicating machines. The requirement for a single-purpose or keyway-specific cutting or duplicating machine shall not be allowed.

D. The key design and tolerances shall permit the use of keys and cylinders in existing key systems having similar keyways and sections.

E. Provide 6 masterkeys for each masterkey set. Provide 2 change keys for each lock. Stamp keys "DO NOT DUPLICATE".

F. Key blanks shall only be shipped to end-user locations upon written documentation from authorized purchasing personnel and for specified number of keys only.

G. Submit proposed keying schedule to Architect. If requested, meet with Owner and Architect to review schedule.

H. Deliver all permanent key blanks and other security keys direct to Owner's representative from SARGENT Manufacturing via secure courier, return receipt requested. Failure to properly comply with these requirements may be cause to require replacement of all or any part of the cylinders and keys involved as deemed necessary at no additional cost to the Owner.

2.1 Cylinders, Key, and Keying – 7300 Small Format Interchangeable Core

A. Acceptable Manufacturer and Series (No Substitutions):

Manufacturer	Series
SARGENT	XC

B. Provide 7-pin small format interchangeable core (SFIC) cylinders.

C. Provide cylinders and keys protected from unauthorized manufacture and distribution.

D. The key design and tolerances shall permit the cutting of keys with standard code or duplicating machines. The requirement for a single-purpose or keyway-specific cutting or duplicating machine shall not be allowed.

E. The key design and tolerances shall permit the use of keys and cylinders in existing key systems having similar keyways and sections.

F. Provide 6 masterkeys for each masterkey set. Provide 2 change keys for each lock. Provide 2 control keys for core removal. Stamp keys "DO NOT DUPLICATE".

G. Key blanks shall only be shipped to end-user locations upon written documentation from authorized purchasing personnel and for specified number of keys only.

H. Submit proposed keying schedule to Architect. If requested, meet with Owner and Architect to review schedule.

I. Deliver all permanent key blanks and other security keys direct to Owner's representative from SARGENT Manufacturing via secure courier, return receipt requested. Failure to properly comply with these requirements may be cause to require replacement of all or any part of the cylinders and keys involved as deemed necessary at no additional cost to the Owner.

Finish Ordered	Plug/Shell	Cylinder Housing (Mortise/Rim)
03	04	03
04		04
09		09
10		10
10B		10B
10BE		10BE
722		722
14	15	14
15		15
26		26
26D		26D
32		32
32D		32D
WSP		WSP
BSP		BSP

How to Order

Options are used to identify optional features which are added or part of a SARGENT product.

XC Cylinders are available by specifying 11- prior to the product description. Mortise example: 11-8226 LNL x 32D and 10 Line example: 11-10G05 LL x 32D, etc.

XC- Cylinders are also available as Bump Resistant by specifying BR-11-. Mortise example: BR-11-8237 LNL x 32D and 10 Line example: BR-11-10G05 LL x 32D, etc.

If other options are being ordered, list options in numerical order: 11-73-7P-10G05, 11-21-8226 x 32D, etc.

The ASSA ABLOY Group is the global leader in access solutions. Every day, we help billions of people experience a more open world.

ASSA ABLOY Opening Solutions leads the development within door openings and products for access solutions in homes, businesses and institutions. Our offering includes doors, frames, door and window hardware, mechanical and smart locks, access control and service.

SARGENT[®]

ASSA ABLOY

SARGENT Manufacturing Company
100 Sargent Drive
New Haven, CT 06511 USA
800-727-5477
www.sargentlock.com

Founded in the early 1800s, SARGENT[®] is a market leader in locksets, cylinders, door closers, exit devices, electro-mechanical products and access control systems for new construction, renovation, and replacement applications. The company's customer base includes commercial construction, institutional, and industrial markets.

Copyright © 2004-2024, SARGENT Manufacturing Company. All rights reserved. Reproduction in whole or in part without the express written permission of SARGENT Manufacturing Company is prohibited. Patent pending and/or patent www.assaabloydss.com/patents.