

SAVOY HOUSE



MASTER LIGHTING CATALOG
2024





Founded in 1965, Savoy House is an attainable luxury lighting brand with stellar customer service.

Our commitment to quality and style makes us the go-to choice for interior designers, builders and lighting enthusiasts alike.

Our 2024 master catalog showcases our premier designs, from chandeliers and bath lights to pendants and outdoor lanterns. You will find a wonderful selection of styles, sizes and finishes to fit any space.

We are also thrilled to debut an exciting new collection from Breegan Jane. Breegan is an award-winning interior designer and TV host who is renowned for her modern, approachable luxury style. Her designs draw inspiration from world travels and the beauty of nature. The collection features styles that are certain to stun and delight.

Also included is our Essentials collection, designed with modern American home decor style in mind. These fixtures effortlessly mix and match, allowing you to create a refined look. Crafted with our signature high quality and attention to detail, you can choose confidently with Essentials.

We are delighted to bring you our complete collections and thank you for being a part of our continued growth.

CONTENTS

ALPHABETICAL LISTING BY FAMILY:









INTERIOR

Abel.....	476, 559, 568
Adams.....	40, 588
Addison.....	596
Akron.....	462
Albany.....	624
Alberta.....	529
Alberti.....	670
Alden.....	424
Alhambra.....	564
Alvara.....	528
Amani.....	272
Anholt.....	86
Archway.....	282, 557
Ariel.....	288
Aries.....	248
Arlon.....	26, 372
Arondale.....	502
Ashbourne.....	536
Ashburn.....	322
Ashe.....	324
Ashmont.....	430
Ashor.....	250
Atlas.....	122
Aster.....	438
Austin.....	436
Avalon.....	678
Avon.....	508
Avondale.....	160
Azores.....	112
Baker.....	164, 386
Bali.....	348
Ballas.....	612
Bally.....	466
Barclay.....	512
Beacon.....	308, 556
Becker.....	450
Bennington.....	24, 376, 438, 556, 598
Benson.....	494, 681
Berg.....	428, 677
Birch.....	334
Birone.....	639
Boa.....	142, 554
Boca.....	110
Bowdin.....	420
Bozeman.....	350
Brandon.....	456
Brannon.....	642
Breur.....	566
Brewster.....	398
Brickell.....	592
Bristo.....	457
Bristol.....	440
Brody.....	188, 528
Brookstone.....	488
Bryant.....	442
Burgess.....	357, 650
Byron.....	50
Caldwell.....	572
Calgary.....	260, 385
Calhoun.....	222, 470, 610, 676
Callaway.....	452, 527
Cameo.....	342
Cameron.....	180, 532, 586
Camille.....	12
Candler.....	600
Cannon.....	327
Capra.....	576
Carlton.....	220, 475
Carlyle.....	416
Carson.....	563, 632
Carver.....	516
Chantilly.....	464, 608
Charter.....	326
Chartwell.....	432
Chaucher.....	351
Chival.....	431
Claiborne.....	106
Clifton.....	521
Colton.....	562, 652
Como.....	504
Concord.....	606
Corning.....	418, 547
Couplet.....	280, 559
Crawford.....	458, 525, 672
Crestwood.....	509
Cristofer.....	230
Crosby.....	636
Cyperas.....	320
Dahlia.....	10, 556
Daintree.....	100
Dakota.....	550
Daniels.....	328
Darby.....	578
Deandre.....	390
Del Mar.....	148, 373, 555
Delphi.....	412
Denton.....	214
Destin.....	530
Devon.....	531
Diplomat.....	490
Director.....	380
Drake.....	468, 551, 614
Dryden.....	116, 371, 557
Dunbar.....	474, 558
Eastover.....	510
Eaton.....	246, 558, 570, 670
Eden.....	361
Edgewood.....	184
Elise.....	563, 655
Eman.....	316
Encino.....	513
Enclave.....	480
Ensley.....	656
Estrella Del Mar.....	126
Fairchild.....	20, 554
Fallon.....	234
Falster.....	302
Farrell.....	486
Folsom.....	296, 522
Foster.....	460, 524
Franklin.....	466
Fremont.....	540
Fulton.....	558
Galea.....	290
Garnet.....	602
Garvey.....	454
Gavin.....	414, 547, 666
Genry.....	70, 594
Gideon.....	44, 438, 558
Giselle.....	102
Glenn.....	546
Glenwood.....	68, 671
Gordon.....	618
Grecian.....	136
Halifax.....	651
Hampton.....	562, 638
Hartford.....	523
Hasting.....	358
Haynes.....	240
Hayward.....	252, 558, 670
Heiress.....	132
Helen.....	18
Hendren.....	344
Herndon.....	475, 562, 654
Hudson.....	66
Idlewild.....	658
Inman.....	360
Iris.....	52
Isla Blanca.....	146, 555
Jasmine.....	170
Jaylar.....	561
Jefferson.....	538
Joffree.....	514
Joliet.....	346
Kaden.....	580
Kahn.....	118, 557
Kameron.....	368
Kane.....	655
Kearney.....	270, 559
Kelvin.....	411
Kent.....	492, 680
Kian.....	410
Killiam.....	396
Kirkland.....	268
Kole.....	478
Lakewood.....	292, 465, 620
Lamar.....	415
Lambert.....	643
Lanai.....	314
Landon.....	76, 374
Lansing.....	649
Laramie.....	354, 406
Legacy.....	144
Leighton.....	8
Lexington.....	482
Lio.....	154
Livorno.....	84
Longfellow.....	256, 526
Longleaf.....	312
Lorraine.....	560
Lucerne.....	674
Luna.....	80, 364
Lyrique.....	298, 668
Macauley.....	477, 558, 648, 698
Macra.....	318
Mallory.....	356
Manor.....	446
Mansfield.....	434
Marco.....	664
Marcy.....	315
Marias.....	278
Mariposa.....	362
Marquise.....	108
Marshall.....	644
Mason.....	634
Maya.....	333
Mayfair.....	14, 366
Medlock.....	310
Melrose.....	582, 562
Middleton.....	192
Midland.....	244, 559
Monarch.....	134
Monroe.....	542
Moreno.....	604
Morland.....	548
Muse.....	140, 377
Myers.....	444
Newell.....	306, 555
Newport.....	238
Nouvel.....	4, 367
Oakhurst.....	36
Oakmont.....	332
Oberyn.....	559
Octave.....	226, 467, 563, 626, 678
Orion.....	394
Orleans.....	30
Owen.....	549
Pacha.....	138
Palladian.....	212
Pampas.....	319
Pearl.....	411
Pendleton.....	472, 677
Penrose.....	496, 676
Pharos.....	156
Pike.....	520
Polson.....	515
Portia.....	98, 556
Portinatx.....	128
Powell.....	186, 534
Preserve.....	378
Pyramid.....	96
Quatrain.....	42, 556
Quincy.....	54, 557
Radcliffe.....	392
Redmond.....	641
Reid.....	662

OUTDOOR

Barrett.....	737
Belmont.....	734
Boone.....	722
Brennan.....	730
Brooke.....	732
Brookline.....	710
Dansk.....	735
Denver.....	704
Dunnmore.....	720
Dunston DS.....	735
Ellijay.....	714
Englewood.....	690
Ericson.....	688
Glendale.....	696
Hamilton.....	689
Hancock.....	718
Jackson.....	712
Kensington.....	736
Kingsley.....	694
Macauley.....	698
Millford.....	706
Milton.....	708
Monte Grande.....	724
Montpelier.....	692
Palmer.....	728
Peninsula.....	700
Raeburn.....	686
Raleigh.....	735
Scout.....	737
Woodstock.....	702
Renzo.....	90
Rhodes.....	506
Rochester.....	402
Rohe.....	94
Rosedale.....	484
Rotterdam.....	28
Roxbury.....	511
Sacramento.....	622
Salem.....	352, 384
Salerno.....	168
Santiago.....	58, 370, 555
Scout.....	671, 737
Seagram.....	422
Selby.....	311
Seneca.....	409
Sheffield.....	262
Shelby.....	400
Shellbourne.....	22, 557
Shields.....	382
Sidney.....	590
Snowden.....	62, 527
Sommerton.....	404
Sorrento.....	174
Southerby.....	560
Stirling.....	455
Stockton.....	660
Stonecrest.....	178
Sullivan.....	38, 556
Talamanca.....	152, 555
Talbot.....	500
Tartan.....	408
Thornhill.....	448
Tivoli.....	56, 559
Townsend.....	200
Travis.....	517
Tulsa.....	522
Turaco.....	130
Vale.....	646
Vasare.....	120
Vaughan.....	640
Venice.....	124
Ventura.....	338
Vintage.....	475
Vista.....	388
Washburn.....	533
Watkins.....	675
Waverly.....	535
Westbourne.....	455
Whitney.....	574
Willis.....	426
Willmar.....	518
Windham.....	88
Windsung.....	501
Winfield.....	216
Woodbury.....	649
Wright.....	284, 453, 630
Wynwood.....	34
Yates.....	654
York.....	552
Ascott.....	684

CONTENTS

	New Traditional4
	Renaissance Guild.....76
	Breegan Jane122
	Essentials.....160
	Today's Classic Style 244
	Mid-Century272
	Lighting Organics310
	Casual Sophistication 338
	Architectural..... 362
	Pendants / Lanterns 396
	Wall Lighting..... 502
	Pour Le Bain / Vanity 564
	Ceiling..... 656
	Outdoor 684
	Stem Info / Finish Guide / Index..... 738

NOUVEL

NEW TRADITIONAL



Includes 12" & 6" extensions - additional stems available - 7-EXTLG

NOUVEL

NEW TRADITIONAL



Dual Mount Hanging System

1-5504-12-322

12-Light Chandelier

Warm Brass Finish

45"W x 34"H

Adj H 34" - 88"

12C 60W

Handmade Strie Glass

NOUVEL

NEW TRADITIONAL



Includes 12" & 6" extensions - additional stems available - **7-EXT**

A.



Dual Mount Hanging System

A. 1-5500-6-322
6-Light Chandelier
Warm Brass Finish
27"W x 24"H
Adj H 24" - 78"
6C 60W
Handmade Striae Glass

B.



B. 1-5502-8-322
8-Light Chandelier
Warm Brass Finish
31"W x 27"H
Adj H 27" - 81"
8C 60W
Handmade Striae Glass

LEIGHTON

NEW TRADITIONAL



*Includes 12" & 6" extensions - additional stems available - **7-EXT**

Includes 12" & 6" extensions - additional stems available - **7-EXTLG



Dual Mount Hanging System

A. 1-2216-6-322

6-Light Chandelier
Warm Brass Finish
28"W x 19-1/2"H
Adj H 19-1/2" - 73-1/2"
6C 60W
Clear Crystal

B. 1-2218-8-322

8-Light Chandelier
Warm Brass Finish
36"W x 24"H
Adj H 24" - 78"
8C 60W
Clear Crystal

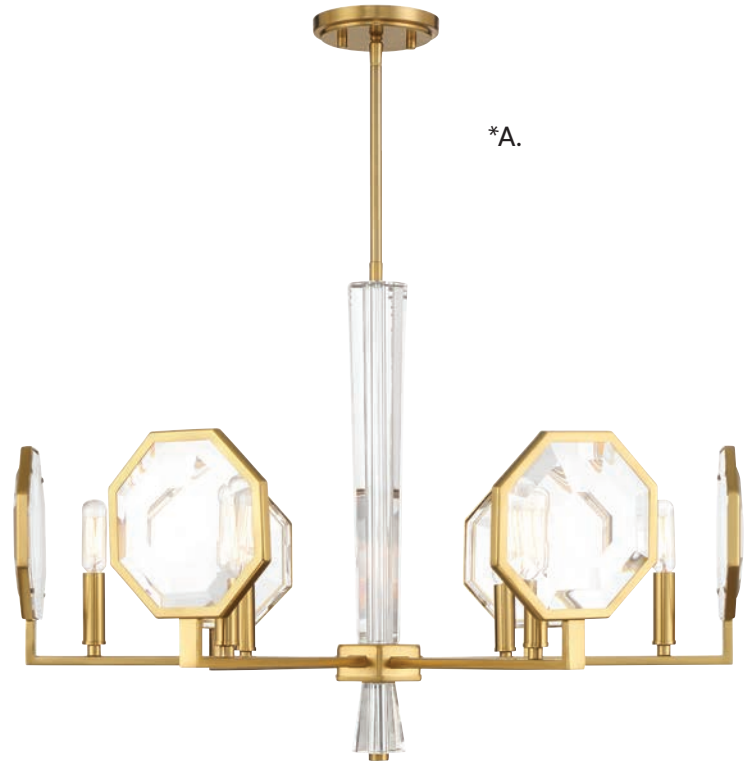

DAHLIA

NEW TRADITIONAL



*Includes 120" chain & 144" wire

DAHLIA

NEW TRADITIONAL

A.



*B.



A. 9-4364-1-322

1-Light Sconce
Warm Brass Finish
9"W x 9-1/4"H x 5" E
1C 60W
White Fabric Shade
Clear Crystal

B. 7-4366-4-322

4-Light Pendant
Warm Brass Finish
21"W x 14"H
4C 60W
White Fabric Shade
Clear Crystal

C. 7-4368-6-322

6-Light Pendant
Warm Brass Finish
30"W x 16-1/2"H
6C 60W
White Fabric Shade
Clear Crystal

*C.



CAMILLE

NEW TRADITIONAL



1-1727-5-322
5-Light Chandelier
Warm Brass Finish
24"W x 24"H
5C 60W
Clear Glass Flowers



Includes 120" chain & 144" wire



CAMILLE

NEW TRADITIONAL



MAYFAIR

NEW TRADITIONAL



Includes 120" chain & 144" wire

MAYFAIR

NEW TRADITIONAL

A. 7-7714-4-195

4-Light Lantern
Warm Brass w/ Chrome Finish
18"W x 33"H
4C 60W
Clear Acrylic
Clear Crystal

A.



B. 1-7712-10-195

10-Light Chandelier
Warm Brass w/ Chrome Finish
45"W x 34"H
10C 60W
Clear Acrylic
Clear Crystal

B.



MAYFAIR

NEW TRADITIONAL

A.

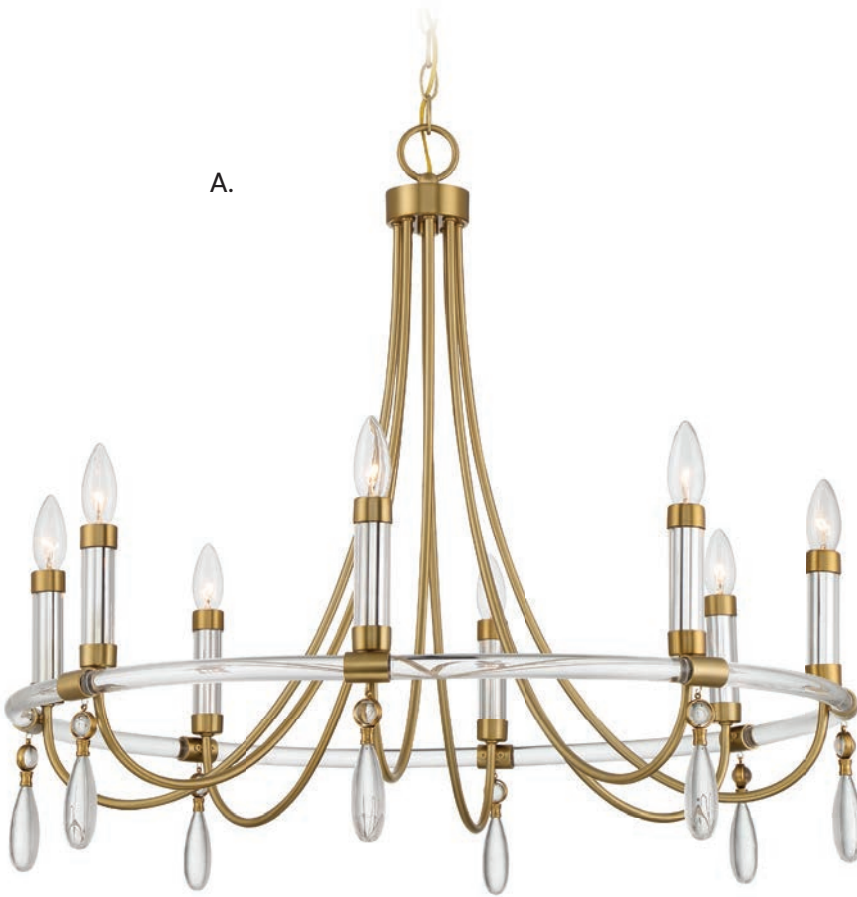

- A. 1-7718-8-195**
8-Light Chandelier
Warm Brass w/
Chrome Finish
30\"W x 27\"H
8C 60W
Clear Acrylic
Clear Crystal

B.

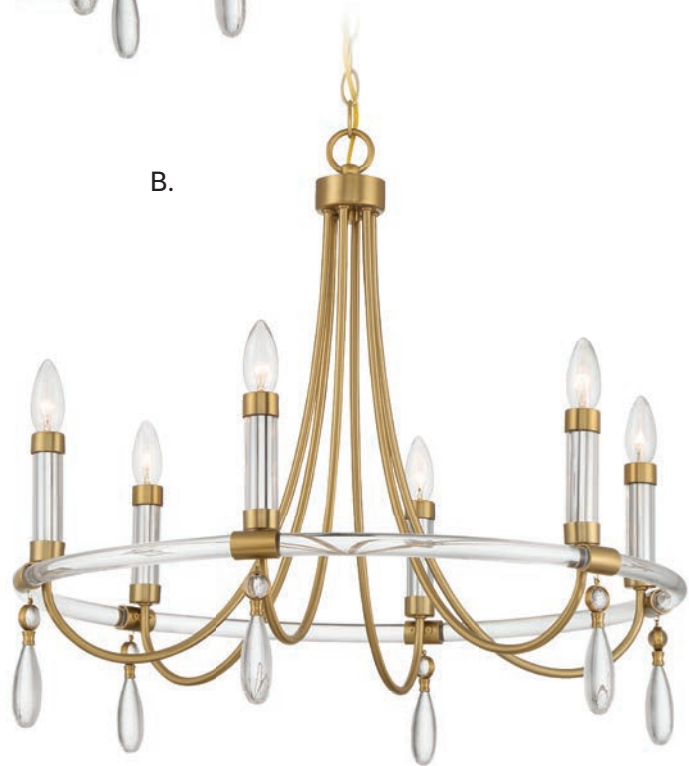

- B. 1-7716-6-195**
6-Light Chandelier
Warm Brass w/
Chrome Finish
25-1/2\"W x 23-1/2\"H
6C 60W
Clear Acrylic
Clear Crystal

MAYFAIR

NEW TRADITIONAL



Includes 120" chain & 144" wire

HELEN

NEW TRADITIONAL

*A.



Dual Mount Hanging System

**B.

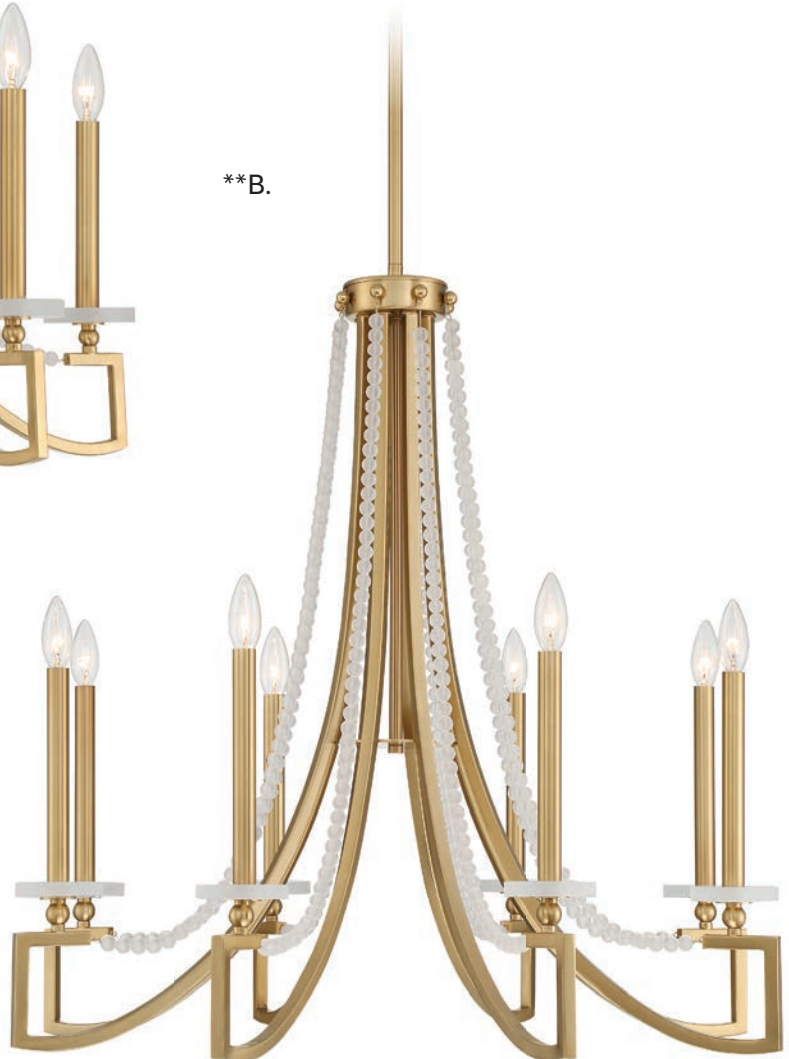

- A. 1-8803-5-322**
5-Light Chandelier
Warm Brass Finish
27"W x 26-1/4"H
Adj H 26-1/4" - 80-1/4"
5C 60W
Frosted Glass Accents

- B. 1-8804-8-322**
8-Light Chandelier
Warm Brass Finish
32"W x 31-3/4"H
Adj H 31-3/4" - 85-3/4"
8C 60W
Frosted Glass Accents

HELEN

NEW TRADITIONAL



*Includes 12" & 6" extensions - additional stems available - 7-EXT

**Includes 12" & 6" extensions - additional stems available - 7-EXTLG

FAIRCHILD

NEW TRADITIONAL



A. 9-2704-2-322
2-Light Sconce
Warm Brass Finish
12"W x 19-1/2"H x 5-1/4"E
2C 60W
Faux Rock Crystal

B. 1-2700-6-322
6-Light Chandelier
Warm Brass Finish
31"W x 26"H
6C 60W
Faux Rock Crystal

C. 1-2702-8-322
8-Light Chandelier
Warm Brass Finish
42"W x 35"H
8C 60W
Faux Rock Crystal

FAIRCHILD

NEW TRADITIONAL

A.



*B.



*C.



*Includes 120" chain & 144" wire

SHELLBOURNE

NEW TRADITIONAL



*Includes 12" & 6" extensions - additional stems available - 7-EXT

SHELLBOURNE

NEW TRADITIONAL



Dual Mount Hanging System

- A. 1-2106-5-322**
5-Light Chandelier
Warm Brass Finish
26"W x 14"H
Adj H 14" - 68"
5C 60W
Handmade Piastra Glass

- B. 9-2104-1-322**
1-Light Sconce
Warm Brass Finish
5"W x 16-1/2"H x 6-1/2"E
1C 60W
Handmade Piastra Glass

B.



BENNINGTON

NEW TRADITIONAL



Dual Mount Hanging System



- A. 1-9705-16-322**
16-Light Chandelier
Warm Brass Finish
45"W x 24"H
Adj H 24" - 78"
16C 60W
Clear Ribbed Glass

- B. 1-9704-10-322**
10-Light Chandelier
Warm Brass Finish
30-1/2"W x 18"H
Adj H 18" - 72"
10C 60W
Clear Ribbed Glass



Includes 12" & 6" extensions - additional stems available - **7-EXTLG**

BENNINGTON

NEW TRADITIONAL



Pendant, Page 439



Bath, Page 599



Sconce, Page 556, 599

ARLON

NEW TRADITIONAL



A. 7-1732-10-322

10-Light Pendant
Warm Brass Finish
26"W x 23"H
Adj H 23" - 77"
2.5W Integrated Dimmable LED
800 Lumens, 3000K, 90+CRI
Bubble Glass

B. 1-1733-12-322

12-Light Chandelier
Warm Brass Finish
38"L x 20"W x 26"H
Adj H 26" - 80"
2.5W Integrated Dimmable LED
950 Lumens, 3000K, 90+CRI
Bubble Glass

C. 1-1734-24-322

24-Light Chandelier
Warm Brass Finish
44"W x 36"H
Adj H 36" - 90"
2.5W Integrated Dimmable LED
1950 Lumens, 3000K, 90+CRI
Bubble Glass



ARLON

NEW TRADITIONAL



*A.

Dual Mount Hanging System

*B.

**C.

*Includes 12" & 6" extensions - additional stems available - **7-EXT**

Includes 12" & 6" extensions - additional stems available - **7-EXTLG

ROTTERDAM

NEW TRADITIONAL



*Includes 12" & 6" extensions - additional stems available - **7-EXTLG**

Includes 12" & 6" extensions - additional stems available - **7-EXT

The rings of the Rotterdam Collection are adjustable and can rotate into different positions.

ROTTERDAM

NEW TRADITIONAL



- A. 7-1660-6-322**
6-Light Pendant
Warm Brass Finish
31-1/2"L x 24-3/4"W x 20-1/2"H
Adj H 20-1/2" - 74-1/2"
6C 60W
30° Swivel
Optic Acrylic

- B. 6-1662-4-322**
4-Light Convertible
Semi-Flush/Pendant
Warm Brass Finish
20"W x 18"H
Adj H 18" - 72"
4C 60W
30° Swivel
Optic Acrylic



Convertible: Semi-Flush/Pendant



ORLEANS

NEW TRADITIONAL

A.



B.



Dual Mount Hanging System

A. 1-2332-8-50
8-Light Linear Chandelier
Black Cashmere Finish
58-1/2" L x 8" W x 11" H
Adj H 11" - 65"
8C 60W
Natural Alabaster Stone

B. 1-2332-8-60
8-Light Linear Chandelier
Distressed Gold Finish
58-1/2" L x 8" W x 11" H
Adj H 11" - 65"
8C 60W
Natural Alabaster Stone

ORLEANS

NEW TRADITIONAL



Includes 12" & 6" extensions - additional stems available - **7-EXTLG**

ORLEANS

NEW TRADITIONAL



Includes 12" & 6" extensions - additional stems available - **7-EXTLG**

ORLEANS

NEW TRADITIONAL

A.



B.



Dual Mount Hanging System

A. 1-2330-5-60
5-Light Linear Chandelier
Distressed Gold Finish
44-1/2"L x 8"W x 11"H
Adj H 11" - 65"
5C 60W
Natural Alabaster Stone

B. 1-2330-5-50
5-Light Linear Chandelier
Black Cashmere Finish
44-1/2"L x 8"W x 11"H
Adj H 11" - 65"
5C 60W
Natural Alabaster Stone

WYNWOOD

NEW TRADITIONAL

*A.



Dual Mount Hanging System

*B.



A. 1-7751-5-322

5-Light Chandelier
Warm Brass Finish
24"W x 17-1/2"H
Adj H 17-1/2" - 71-1/2"
5C 60W
Soft White String Shade

B. 1-7750-4-322

4-Light Chandelier
Warm Brass Finish
16"W x 32"H
Adj H 32" - 86"
4C 60W
Soft White String Shade

**C.



C. 1-7752-6-322

6-Light Chandelier
Warm Brass Finish
30"W x 20"H
Adj H 20" - 74"
6C 60W
Soft White String Shade

WYNWOOD

NEW TRADITIONAL



*Includes 12" & 6" extensions - additional stems available - **7-EXT**

Includes 12" & 6" extensions - additional stems available - **7-EXTLG

OAKHURST

NEW TRADITIONAL



Includes 12" & 6" extensions - additional stems available - **7-EXTLG**

OAKHURST

NEW TRADITIONAL



Dual Mount Hanging System

A.



- A. 1-2294-12-262**
12-Light Chandelier
Antique Gold Finish
30"W x 25"H
Adj H" 25" - 79"
12C 60W
Natural Travertine Stone

B.



- B. 1-2296-16-262**
16-Light Chandelier
Antique Gold Finish
36"W x 26"H
Adj H" 26" - 80"
16C 60W
Natural Travertine Stone

SULLIVAN

NEW TRADITIONAL



*Includes 120" chain & 144" wire



A.



*B.

- A. 9-2204-2-322**
2-Light Sconce
Warm Brass Finish
10"W x 9"H x 5"E
2C 60W

- B. 1-2206-8-322**
8-Light Chandelier
Warm Brass Finish
32"W x 27-1/4"H
8C 60W

- C. 1-2208-10-322**
10-Light Chandelier
Warm Brass Finish
40"W x 35-1/2"H
10C 60W



*C.

ADAMS

NEW TRADITIONAL



A. 9-4417-1-322

1-Light Sconce
Warm Brass Finish
7"W x 11"H x 7-1/2"E
1E 60W
White Strie Glass

B. 1-4418-3-322

3-Light Chandelier
Warm Brass Finish
21"W x 13-1/2"H
Adj H 13-1/2" - 67-1/2"
3E 60W
White Strie Glass

C. 1-4419-5-322

5-Light Chandelier
Warm Brass Finish
25"W x 14-1/2"H
Adj H 14-1/2" - 68-1/2"
5E 60W
White Strie Glass



Bath, Page 589

A.



*B.



Dual Mount Hanging System

*C.



*Includes 12" & 6" extensions - additional stems available - 7-EXT

QUATRRAIN

NEW TRADITIONAL



A. 7-2303-4-260
4-Light Pendant
True Gold Finish
22-3/4"W x 20"H
Adj H 20" - 74"
4E 60W
White Fabric Shade
Glass Diffuser

B. 1-2304-6-260
6-Light Chandelier
True Gold Finish
30"W x 23"H
Adj H 23" - 77"
6E 60W
White Opal Glass

C. 1-2305-8-260
8-Light Linear Chandelier
True Gold Finish
41-1/4"L x 15-1/2"W x 21"H
Adj H 21" - 75"
8E 60W
White Opal Glass



Scence, Page 556

QUATRRAIN

NEW TRADITIONAL

A.

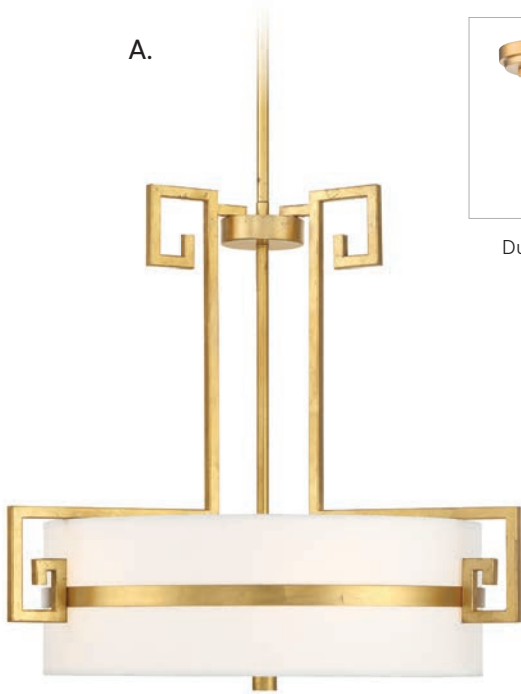

Dual Mount Hanging System

B.

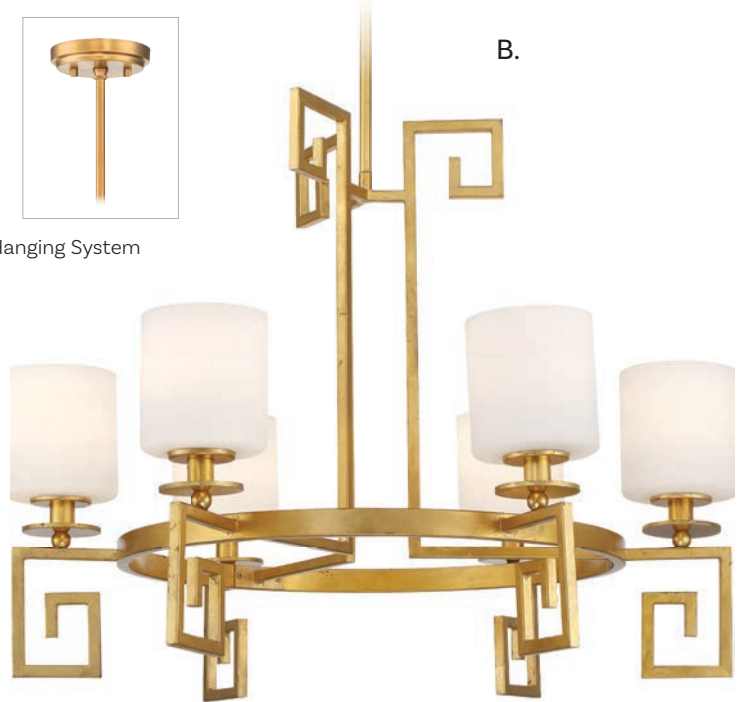

C.

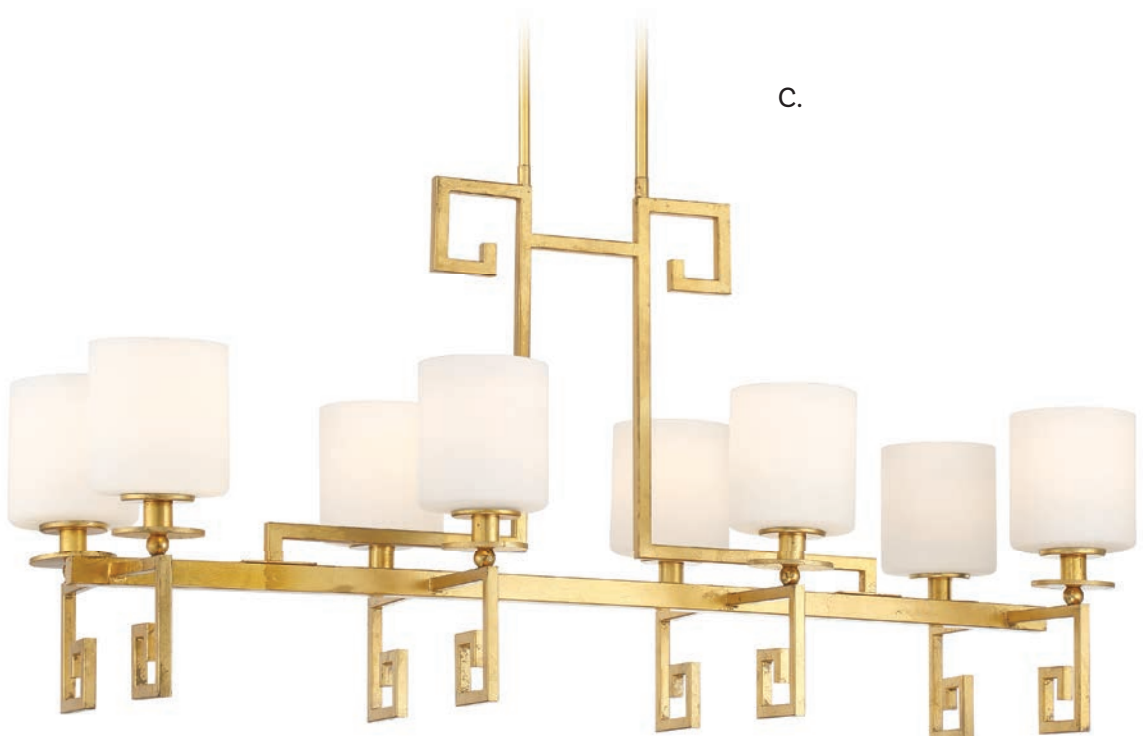

Includes 12" & 6" extensions - additional stems available - 7-EXT

GIDEON

NEW TRADITIONAL

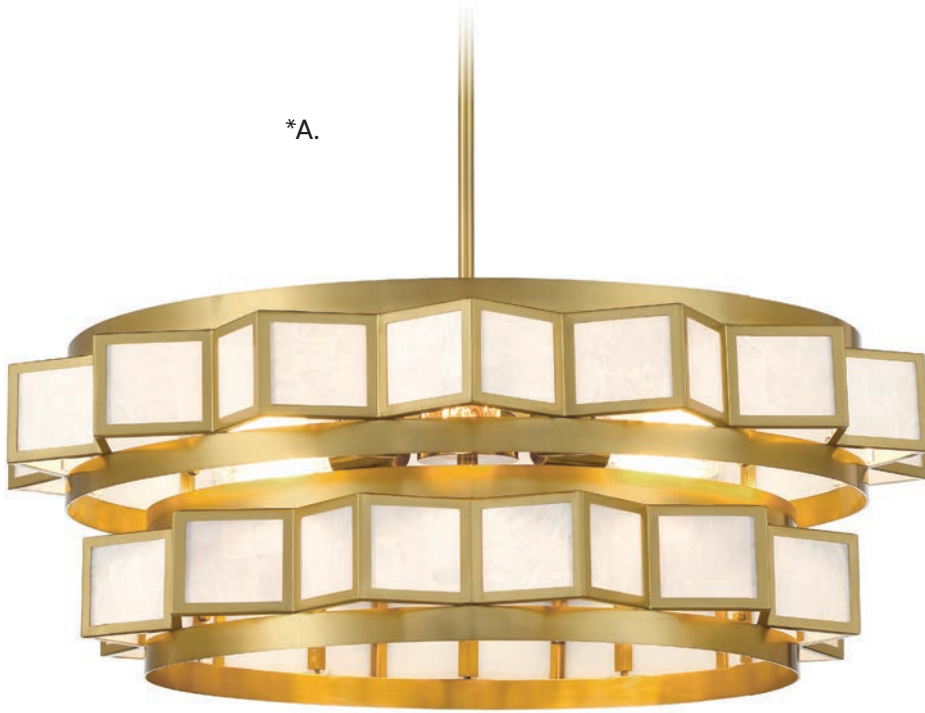

Dual Mount Hanging System

- A. 1-3166-6-322**
6-Light Chandelier
Warm Brass Finish
29"W x 10"H
Adj H 10" - 64"
6E 60W
Capiz Shell

- B. 1-3165-8-322**
8-Light Linear Chandelier
Warm Brass Finish
47-3/4"L x 14-1/2"W x 5-1/4"H
Adj H 5-1/4" - 59-1/4"
8C 60W
Capiz Shell

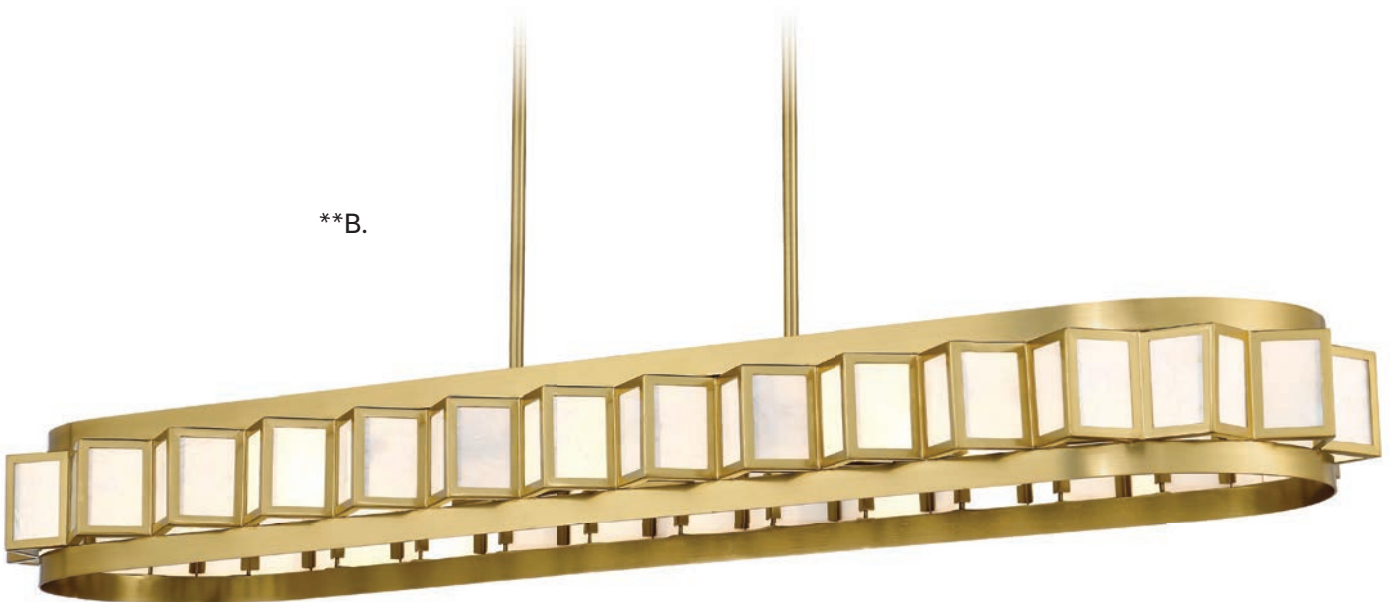



*Includes 12" & 6" extensions - additional stems available - **7-EXTLG**

Includes 12" & 6" extensions - additional stems available - **7-EXT

GIDEON

NEW TRADITIONAL



*Includes 12" & 6" extensions - additional stems available - 7-EXT

*A.



Dual Mount Hanging System

B.



Sconce

- A. 7-3168-3-322**
3-Light Pendant
Warm Brass Finish
16"W x 17-1/2"H
Adj H 17-1/2" - 71-1/2"
3C 60W
Capiz Shell

*C.

- B. 9-3164-2-322**
2-Light Sconce
Warm Brass Finish
10"W x 11"H x 4-1/2" E
2C 60W
Capiz Shell

- C. 1-3167-4-322**
4-Light Chandelier
Warm Brass Finish
24"W x 5"H
Adj H 5" - 59"
4E 60W
Capiz Shell

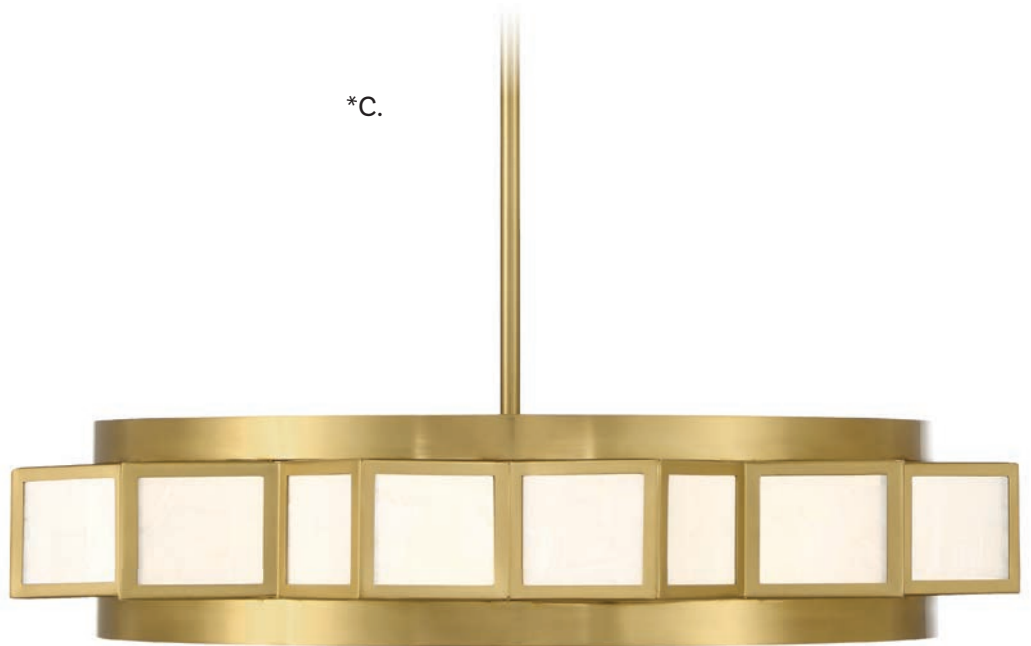

FAN D'LIER® GIDEON

NEW TRADITIONAL



FAN NUMBER 28-FD-690-322

MOTOR FINISH Warm Brass

BLADE FINISH Gold

SHADE FINISH Capiz Shell

ENERGY USE AT HIGH SPEED

Airflow Use	Electricity Use	Airflow Efficiency
922	25W	36.88
Cu Ft/Min	Excludes Lights	Cu Ft/Min/W

Compare: 36" to 48" ceiling fans have airflow efficiencies ranging from approximately 71 to 86 cu. ft. per min. per watt at high speed.

- Motor Size 104mm x 114mm
- 14" Blade Span
- 26"W x 27-3/4"H (Cage Only)
- 15° Blade Pitch
- 18" Downrod Included
- Additional Downrod Lengths Sold Separately
- 4E 6W Dimmable LED (600 Lumens per bulb, 3000K, 90+ CRI)
- Not Hugger Kit Adaptable
- Handheld Remote Included (RMT-AC-UNIVERSAL) with D Receiver Included
- Not Hugger Kit Adaptable
- Fan & Blades are ETL Damp Location
- Lamp Included



Handheld Remote Control Included
RMT-AC-UNIVERSAL





BYRON

NEW TRADITIONAL



Includes 120" chain & 144" wire



A.

- A. 7-3362-6-322**
6-Light Pendant
Warm Brass Finish
16"W x 34-1/2"H
6C 60W
Frosted Glass



B.

- B. 1-3364-6-322**
6-Light Chandelier
Warm Brass Finish
24"W x 29"H
6C 60W
Frosted Glass

IRIS

NEW TRADITIONAL



Includes 120" chain & 144" wire



A.

A. 1-3804-6-143
6-Light Chandelier
Warm Brass w/
Matte Black Finish
31-1/2"W x 29"H
6C 60W
Clear Crystal

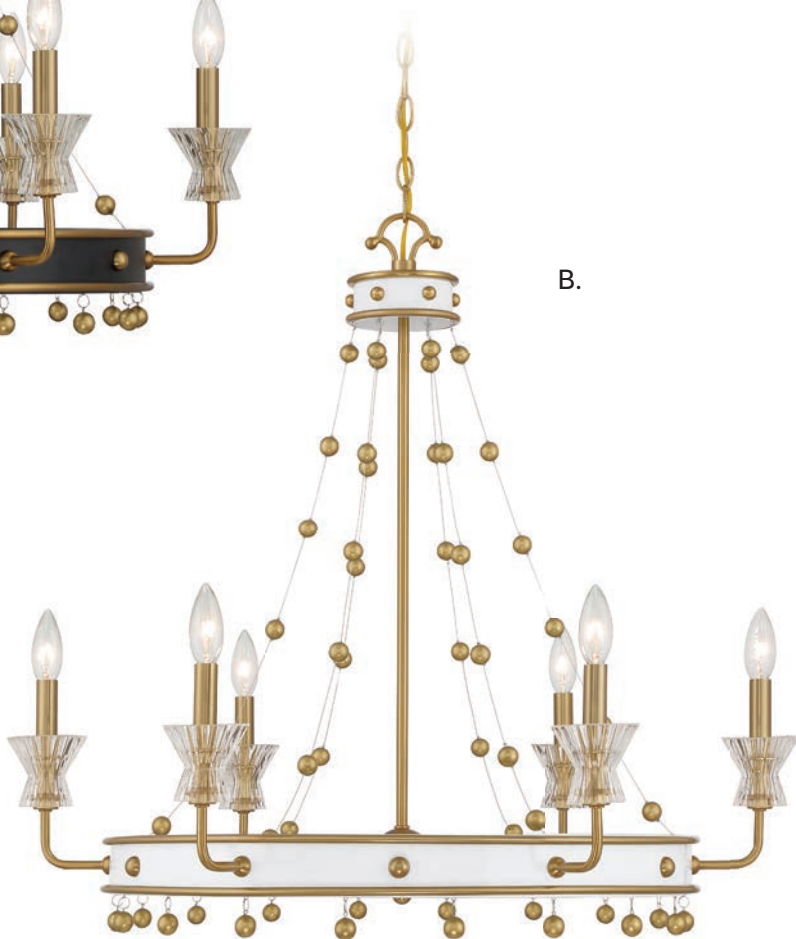

B.

B. 1-3804-6-142
6-Light Chandelier
Warm Brass w/
White Finish
31-1/2"W x 29"H
6C 60W
Clear Crystal

QUINCY

NEW TRADITIONAL

*A.



B.



Dual Mount Hanging System

A. 1-9945-5-143

5-Light Chandelier
Warm Brass w/ Matte Black Finish
27"W x 14-1/4"H
Adj H 14-1/4" - 68-1/4"
5C 60W
Metal Shade

B. 9-9944-1-143

1-Light Sconce
Warm Brass w/ Matte Black Finish
5-1/4"W x 18-1/2"H x 7"E
1C 60W
Metal Shade

QUINCY

NEW TRADITIONAL



*Includes 12" & 6" extensions - additional stems available - 7-EXT

TIVOLI

NEW TRADITIONAL



Dual Mount Hanging System

A. 1-1893-6-143

6-Light Chandelier
Matte Black w/ Warm Brass
28"W x 24"H
Adj H 24" - 78"
6C 60W
White Fabric Shades
Clear Crystal

B. 1-1887-6-143

6-Light Chandelier
Matte Black w/ Warm Brass
28"W x 20"H
Adj H 20" - 74"
6C 60W
White Fabric Shades
Clear Crystal

C. 1-1889-8-143

8-Light Linear Chandelier
Matte Black w/ Warm Brass
42"L x 16"W x 16"H
Adj H 16" - 70"
8C 60W
White Fabric Shades
Clear Crystal



Includes 12" & 6" extensions - additional stems available - 7-EXT



Sconce, Page 559

SANTIAGO

NEW TRADITIONAL



Includes 120" chain & 144" wire

SANTIAGO

NEW TRADITIONAL

1-1934-12-143
12-Light Chandelier
Matte Black w/ Warm Brass
45"W x 41"H
12E 60W
Clear Crystal



SANTIAGO

NEW TRADITIONAL



A. 9-1935-2-143
2-Light Sconce
Matte Black w/ Warm Brass
8"W x 13-1/4"H x 4-1/2"E
2E 60W
Clear Crystal

B. 3-1936-6-143
6-Light Lantern
Matte Black w/ Warm Brass
20"W x 42-1/2"H
6E 60W
Clear Crystal

C. 7-1937-8-143
8-Light Pendant
Matte Black w/ Warm Brass
30"W x 30-1/2"H
8E 60W
Clear Crystal

SANTIAGO

NEW TRADITIONAL

A.



*B.



*C.



*Includes 120" chain & 144" wire

SNOWDEN

NEW TRADITIONAL



A. 9-2006-1-171

1-Light Sconce
Burnished Brass Finish
4-3/4"W x 14"H x 4"E
1C 60W
Hammered Water Glass

B. 7-2004-8-171

8-Light Lantern
Burnished Brass Finish
18"W x 30"H
8C 60W
Hammered Water Glass

C. 7-2004-8-89

8-Light Lantern
Matte Black Finish
18"W x 30"H
8C 60W
Hammered Water Glass

D. 9-2006-1-89

1-Light Sconce
Matte Black Finish
4-3/4"W x 14"H x 4"E
1C 60W
Hammered Water Glass

SNOWDEN

NEW TRADITIONAL

A.



*B.



*C.



D.



*Includes 120" chain & 144" wire

SNOWDEN

NEW TRADITIONAL



24-FD-2008-171



24-FD-2008-89



FAN NUMBER	24-FD-2008-171	24-FD-2008-89
MOTOR FINISH	Burnished Brass	Matte Black
BLADE FINISH	Gold	Black
SHADE FINISH	Hammered Water Glass	Hammered Water Glass
DOWNROD FINISH	171	FB

- Motor Size 104mm x 114mm
- 14" Blade Span
- 24"W x 29"H
- 15° Blade Pitch
- 3-Speed Reversible Motor
- 4" & 18" Downrods Included
- Additional Downrod Lengths Sold Separately
- 5C 6W LED Dimmable LED (500 Lumens per bulb, 3000K, 90+ CRI)
- Handheld Remote with E Receiver Included (RMT-AC-UNIVERSAL)
- Not Hugger Kit Adaptable
- Fan & Blades are ETL Damp Location
- Lamp Included

SNOWDEN

NEW TRADITIONAL



ENERGY USE AT HIGH SPEED

Airflow Use	Electricity Use	Airflow Efficiency
1,230 Cu Ft/Min	36W Excludes Lights	34.17 Cu Ft/Min/W

Compare: 49" to 60" ceiling fans have airflow efficiencies ranging from approximately 51 to 176 cu. ft. per min per watt at high speed.



HUDSON

NEW TRADITIONAL



A. 7-1851-12-89

12-Light Pendant
Matte Black Finish
36"W x 31"H
12C 60W
Clear Water Piastra Glass

B. 7-1850-8-89

8-Light Pendant
Matte Black Finish
28"W x 23"H
8C 60W
Clear Water Piastra Glass

C. 1-1852-10-89

10-Light Oval Chandelier
Matte Black Finish
48"L x 16"W x 24-1/2"H
10C 60W
Clear Water Piastra Glass

HUDSON

NEW TRADITIONAL



Includes 120" chain & 144" wire

GLENWOOD

NEW TRADITIONAL



- A. 1-3043-5-13**
- 5-Light Linear Chandelier
- English Bronze Finish
- 45-1/8" L x 7" W x 30-1/4" H
- 5E 60W
- Clear Water Piastra Glass



*Includes 120" chain & 144" wire

GLENWOOD

NEW TRADITIONAL



B.



C.



*D.



*E.

B. 6-3042-4-13
 4-Light Semi-Flush
 English Bronze Finish
 14"W x 13-3/4"H
 4C 60W
 Clear Water Piastra Glass

C. 9-3045-1-13
 1-Light Sconce
 English Bronze Finish
 8"W x 11"H x 4-1/4"E
 1C 60W
 Clear Water Piastra Glass

D. 7-3040-6-13
 6-Light Pendant
 English Bronze Finish
 27"W x 27-1/8"H
 6C 60W
 Clear Water Piastra Glass

E. 3-3041-4-13
 4-Light Lantern
 English Bronze Finish
 14"W x 30-1/8"H
 4C 60W
 Clear Water Piastra Glass

GENRY

NEW TRADITIONAL



Includes 120" chain & 144" wire

Bath, Page 594



A. 1-8200-5-109
5-Light Pendant
Polished Nickel Finish
26"W x 25-1/2"H
5E 60W
Handmade Water Glass

B. 1-8200-5-322
5-Light Pendant
Warm Brass Finish
26"W x 25-1/2"H
5E 60W
Handmade Water Glass

C. 1-8200-5-89
5-Light Pendant
Matte Black Finish
26"W x 25-1/2"H
5E 60W
Handmade Water Glass



GENRY

NEW TRADITIONAL



Includes 120" chain & 144" wire



A. 1-8203-3-109
3-Light Linear Chandelier
Polished Nickel Finish
41"L x 13"W x 31-1/2"H
3E 60W
Handmade Water Glass

B. 1-8203-3-322
3-Light Linear Chandelier
Warm Brass Finish
41"L x 13"W x 31-1/2"H
3E 60W
Handmade Water Glass

C. 1-8203-3-89
3-Light Linear Chandelier
Matte Black Finish
41"L x 13"W x 31-1/2"H
3E 60W
Handmade Water Glass

GENRY

NEW TRADITIONAL



FAN NUMBER	27-FD-8201-109	27-FD-8201-322	27-FD-8201-89
MOTOR FINISH	Polished Nickel	Warm Brass	Matte Black
SHADE GLASS	Handmade Water Glass	Handmade Water Glass	Handmade Water Glass
DOWNROD FINISH	109	322	FB

- Motor Size 104mm x 114mm
- 14" Blade Span
- 26-1/2"W x 8-1/8"H
- 13° Blade Pitch
- 3-Speed Reversible Motor
- 4" & 18" Downrods Included
- Additional Downrod Lengths Sold Separately
- 5E 8W Dimmable LED Bulbs (600 Lumens per bulb, 3000K, 90+ CRI)
- Handheld Remote with E Receiver Included (RMT-AC-UNIVERSAL)
- Not Hugger Kit Adaptable
- Fan & Blades are ETL Damp Location
- Lamp Included



ENERGY USE AT HIGH SPEED

Airflow Use	Electricity Use	Airflow Efficiency
1,395	35W	39.86
Cu Ft/Min	Excludes Lights	Cu Ft/Min/W

Compare: 49" to 60" ceiling fans have airflow efficiencies ranging from approximately 51 to 176 cu. ft. per min per watt at high speed.



LANDON

RENAISSANCE GUILD



Dual Mount Hanging System

7-1622-117-322

LED Pendant

Warm Brass Finish

45"W x 29"H

Adj H 29" - 83"

117W Integrated Dimmable LED

3900 Lumens, 3000K, 90+ CRI

Natural Calcite Elements

LED



Includes 12" & 6" extensions - additional stems available - **7-EXTLG**

LANDON

RENAISSANCE GUILD



LANDON

RENAISSANCE GUILD



Includes 12" & 6" extensions - additional stems available - **7-EXTLG**

LANDON

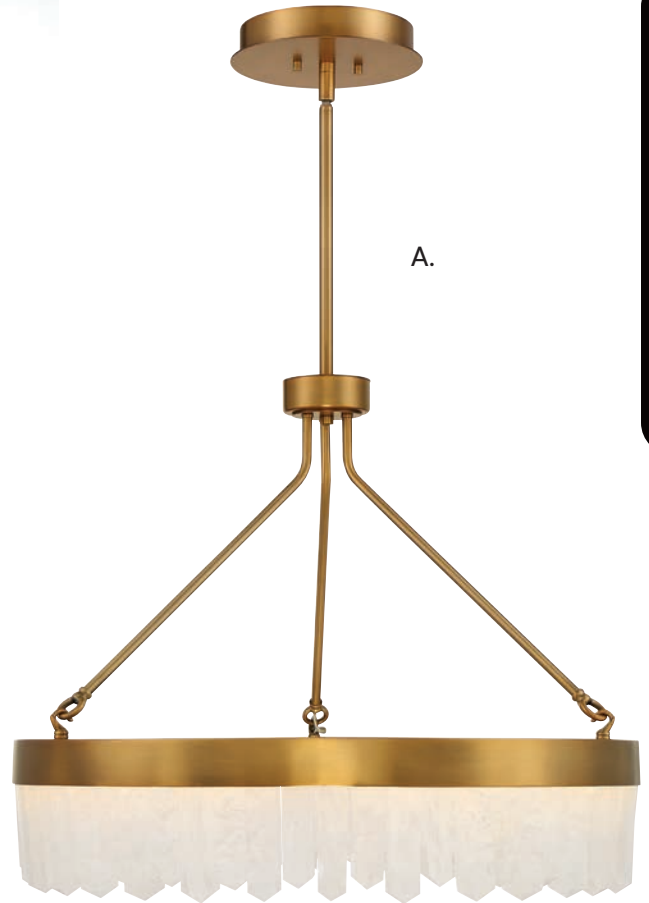

A.



Dual Mount Hanging System

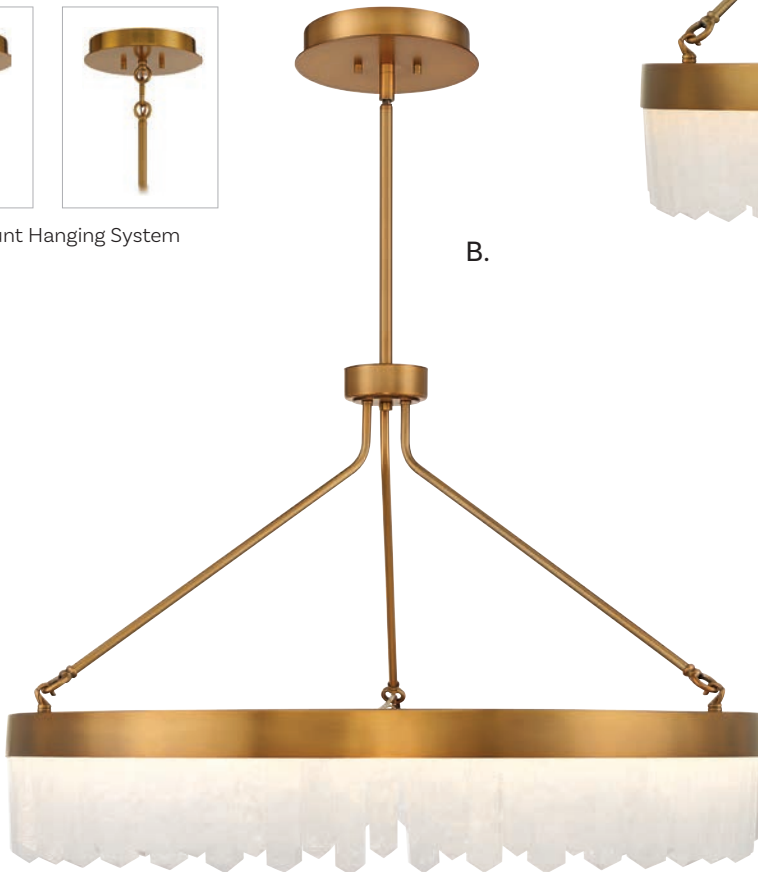

B.

A. 7-1620-43-322

LED Pendant
Warm Brass Finish
27"W x 22"H
Adj H 22" - 76"
43W Integrated Dimmable LED
1450 Lumens, 3000K, 90+ CRI
Natural Calcite Elements

B. 7-1621-53-322

LED Pendant
Warm Brass Finish
34"W x 22"H
Adj H 22" - 76"
53W Integrated Dimmable LED
1800 Lumens, 3000K, 90+ CRI
Natural Calcite Elements



LUNA

RENAISSANCE GUILD



Includes 120" chain & 144" wire

A.



- A. 1-1868-15-89**
15-Light Chandelier
Matte Black Finish
45"W x 54"H
15C 60W
Frosted Crystal

B.



- B. 1-1868-15-322**
15-Light Chandelier
Warm Brass Finish
45"W x 54"H
15C 60W
Clear Crystal

LUNA

RENAISSANCE GUILD



Includes 120" chain & 144" wire

A.



B.



C.



A. 1-1865-3-322
3-Light Mini-Chandelier
Warm Brass Finish
16"W x 19"H
3C 60W
Clear Crystal

B. 1-1866-4-322
4-Light Chandelier
Warm Brass Finish
20"W x 20"H
4C 60W
Clear Crystal

C. 1-1867-10-322
10-Light Chandelier
Warm Brass Finish
36"L x 17"W x 20"H
10C 60W
Clear Crystal

LIVORNO

- A. 1-1846-4-127**
4-Light Chandelier
Noble Brass Finish
21"W x 19"H
Adj H 19" - 73"
4C 60W
30° Swivel
Clear Crystal

- B. 1-1847-8-127**
8-Light Oval Chandelier
Noble Brass Finish
36"L x 15"W x 15"H
Adj H 15" - 69"
8C 60W
30° Swivel
Clear Crystal



A.



B.

LIVORNO

RENAISSANCE GUILD



Includes 12" & 6" extensions - additional stems available - 7-EXT

ANHOLT

RENAISSANCE GUILD



*Includes 12" & 6" extensions - additional stems available - 7-EXT

**Includes 120" chain & 144" wire

*A.



Convertible: Semi-Flush/Pendant

**B.



**C.



Dual Mount Hanging System

A. 6-6684-4-127
 4-Light Convertible
 Semi-Flush Mount
 Noble Brass Finish
 16-1/2"W x 15-1/2"H
 Adj H 15-1/2" - 69-1/2"
 4C 60W
 Clear Crystal

B. 1-6686-6-127
 6-Light Chandelier
 Noble Brass Finish
 22-3/4"W x 28-1/4"H
 6C 60W
 Clear Crystal

C. 1-6688-8-127
 8-Light Chandelier
 Noble Brass Finish
 32"W x 35-1/2"H
 8C 60W
 Clear Crystal

WINDHAM

RENAISSANCE GUILD



Includes 120" chain & 144" wire

WINDHAM



A. 7-8700-4-322
4-Light Pendant
Warm Brass Finish
20"W x 22"H
4C 60W
Clear Crystal

B. 7-8701-6-322
6-Light Pendant
Warm Brass Finish
28"W x 28"H
6C 60W
Clear Crystal

C. 1-8702-8-322
8-Light Linear Chandelier
Warm Brass Finish
38"L x 16"W x 26"H
8C 60W
Clear Crystal

RENZO

RENAISSANCE GUILD



Includes 12" & 6" extensions - additional stems available - 7-EXT



Dual Mount Hanging System

A.



B.



A. 7-9048-6-89
6-Light Pendant
Matte Black Finish
28"W x 12"H
Adj H 12" - 66"
6E 60W
Clear Crystal

B. 7-9048-6-322
6-Light Pendant
Warm Brass Finish
28"W x 12"H
Adj H 12" - 66"
6E 60W
Clear Crystal

RENZO

RENAISSANCE GUILD



Includes 12" & 6" extensions - additional stems available - 7-EXT

RENZO

RENAISSANCE GUILD



Dual Mount Hanging System

A. 7-9044-3-89
 3-Light Pendant
 Matte Black Finish
 16"W x 12"H
 Adj H 12" - 66"
 3E 60W
 Clear Crystal

B. 7-9046-4-89
 4-Light Pendant
 Matte Black Finish
 22"W x 12"H
 Adj H 12" - 66"
 4E 60W
 Clear Crystal

C. 7-9046-4-322
 4-Light Pendant
 Warm Brass Finish
 22"W x 12"H
 Adj H 12" - 66"
 4E 60W
 Clear Crystal

D. 7-9044-3-322
 3-Light Pendant
 Warm Brass Finish
 16"W x 12"H
 Adj H 12" - 66"
 3E 60W
 Clear Crystal

ROHE

RENAISSANCE GUILD

A.



B.



C.



D.



Includes 12" & 6" extensions - additional stems available - **7-EXTLG**



Dual Mount Hanging System

A. 7-2224-5-89
 5-Light Pendant
 Matte Black Finish
 26"W x 19-1/4"H
 Adj H 19-1/4" - 73-1/4"
 5C 60W
 Clear Crystal

B. 3-2226-8-89
 8-Light Lantern
 Matte Black Finish
 15-3/4"W x 31"H
 Adj H 31" - 85"
 8C 60W
 Clear Crystal

C. 3-2226-8-322
 8-Light Lantern
 Warm Brass Finish
 15-3/4"W x 31"H
 Adj H 31" - 85"
 8C 60W
 Clear Crystal

D. 7-2224-5-322
 5-Light Pendant
 Warm Brass Finish
 26"W x 19-1/4"H
 Adj H 19-1/4" - 73-1/4"
 5C 60W
 Clear Crystal

PYRAMID

RENAISSANCE GUILD



PYRAMID



Dual Mount Hanging System

A.



B.



A. 7-1610-6-322

6-Light Pendant
Warm Brass Finish
29"W x 16"H
Adj H 16" - 70"
6C 60W
Clear Crystal

B. 7-1610-6-89

6-Light Pendant
Matte Black Finish
29"W x 16"H
Adj H 16" - 70"
6C 60W
Clear Crystal

Includes 12" & 6" extensions - additional stems available - **7-EXTLG**

PORTIA

RENAISSANCE GUILD



*Includes 12" & 6" extensions - additional stems available - **7-EXTLG**

Includes 12" & 6" extensions - additional stems available - **7-EXT

PORTIA

RENAISSANCE GUILD

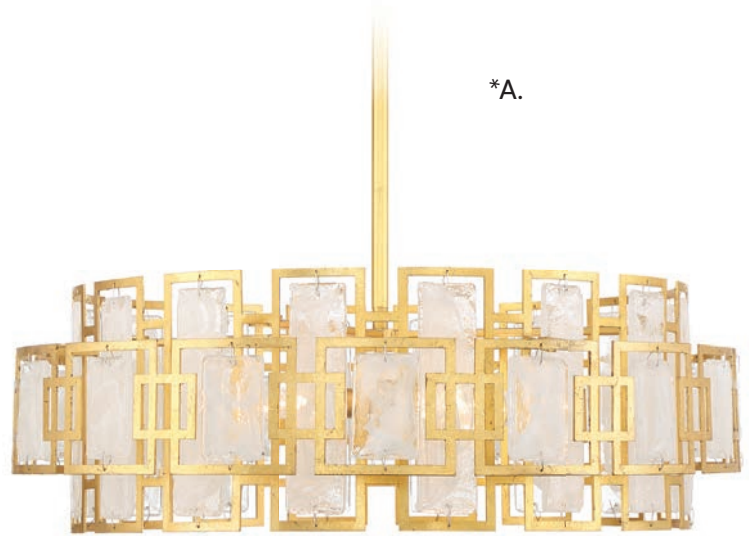

*A.



**B.



Dual Mount Hanging System

A. 1-2031-5-260
 5-Light Chandelier
 True Gold Finish
 26"W x 8-1/2"H
 Adj H 8-1/2" - 62-1/2"
 5C 60W
 Strie Piastra Glass

B. 1-2032-6-260
 6-Light Linear Chandelier
 True Gold Finish
 42"L x 12"W x 11"H
 Adj H 11" - 65"
 6C 60W
 Strie Piastra Glass



Sconce, Page 556

DAINTREE

RENAISSANCE GUILD



Includes 120" chain & 144" wire

DAINTREE



A.



B.

A. 7-1947-8-260
8-Light Pendant
True Gold Finish
30"W x 30"H
8E 60W
Clear Crystal

B. 1-1946-10-260
10-Light Chandelier
True Gold Finish
45"W x 39"H
10E 60W
Clear Crystal

GISELLE

RENAISSANCE GUILD



Includes 12" & 6" extensions - additional stems available - 7-EXTLG

GISELLE



A.



B.

- A. 1-1961-16-18**
16-Light Chandelier
Delphine Finish
33"W x 25-1/2"H
Adj H 25-1/2" - 79-1/2"
16C 60W
Clear Crystal

- B. 1-1962-24-18**
24-Light Chandelier
Delphine Finish
46"W x 26-1/2"H
Adj H 26-1/2" - 80-1/2"
24C 60W
Clear Crystal

GISELLE

RENAISSANCE GUILD



*Includes 12" & 6" extensions - additional stems available - 7-EXTLG

GISELLE



A. 1-1963-10-18
10-Light Linear Chandelier
Delphine Finish
48"L x 10-1/2"W x 12-3/4"H
Adj H 12-3/4" - 66-3/4"
10C 60W
Clear Crystal

B. 9-1964-3-18
3-Light Sconce
Delphine Finish
8-3/4"W x 18-1/4"H x 4-1/2"E
3C 60W
Clear Crystal



CLAIBORNE

RENAISSANCE GUILD



Includes 120" chain & 144" wire

1-3060-6-60
6-Light Chandelier
Avalite Finish
33"W x 35"H
6C 60W
Clear Crystal



MARQUISE

RENAISSANCE GUILD



Includes 120" chain & 144" wire

MARQUISE



A. 1-1669-4-143
4-Light Chandelier
Matte Black w/ Warm Brass
24"W x 23"H
4E 60W
Optic Acrylic Elements

B. 1-1668-9-143
9-Light Chandelier
Matte Black w/ Warm Brass
30"W x 27"H
9E 60W
Optic Acrylic Elements

BOCA

RENAISSANCE GUILD



Includes 12" & 6" extensions - additional stems available - **7-EXTLG**



Dual Mount Hanging System

- A. 1-3720-6-89**
6-Light Chandelier
Matte Black Finish
27-1/2"W x 18"H
Adj H 18" - 72"
6C 60W
Strie Piastra Glass

- B. 1-3722-10-89**
10-Light Chandelier
Matte Black Finish
35-1/2"W x 25"H
Adj H 25" - 79"
10C 60W
Strie Piastra Glass

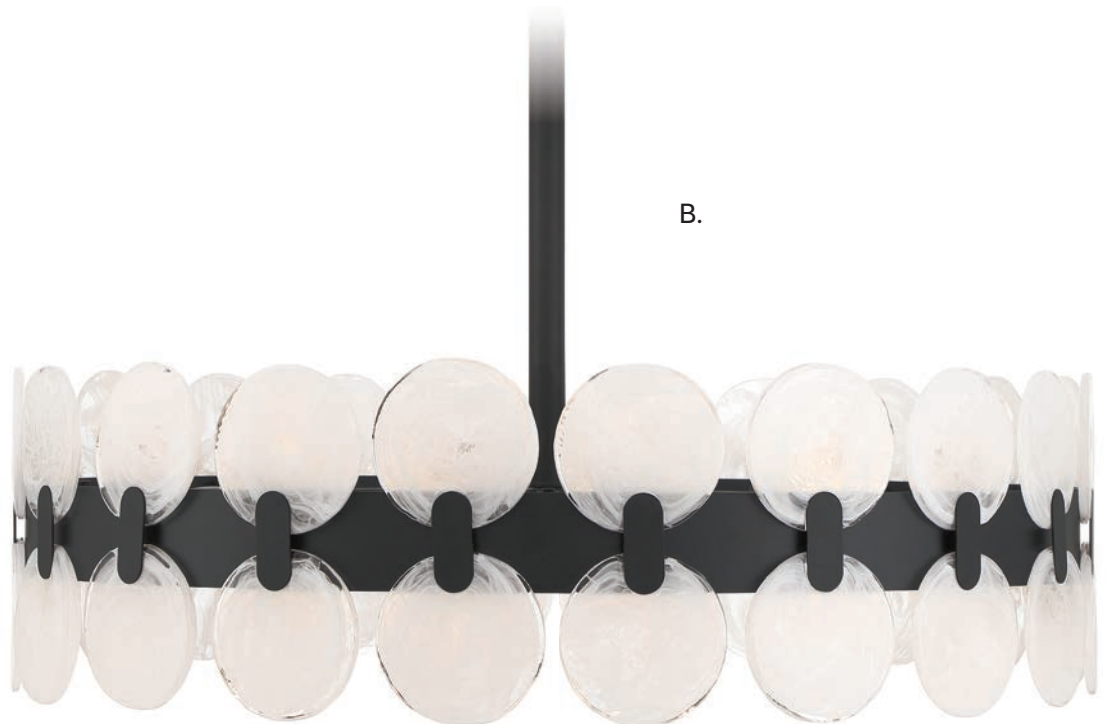
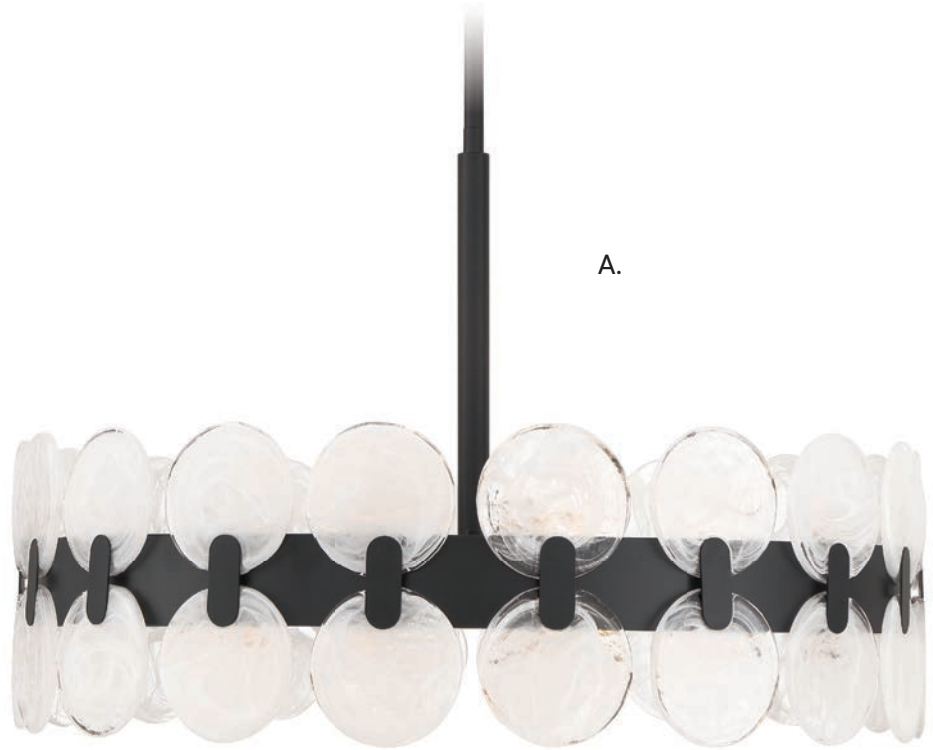

AZORES

RENAISSANCE GUILD



Includes 12" & 6" extensions - additional stems available - **7-EXTLG**

AZORES

RENAISSANCE GUILD



Dual Mount Hanging System

1-1270-6-50

6-Light Linear Chandelier
Black Cashmere Finish
48" L x 18" W x 6" H
Adj H 6" - 60"
6C 60W
Clear Crystal

AZORES

RENAISSANCE GUILD



Includes 12" & 6" extensions - additional stems available - **7-EXTLG**

AZORES

RENAISSANCE GUILD



Convertible: Semi-Flush/Pendant

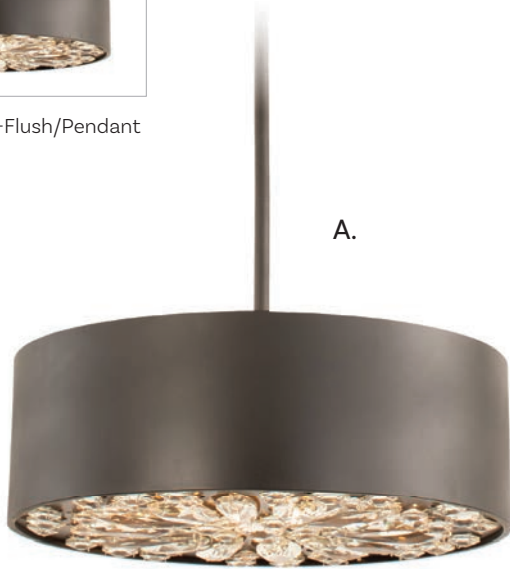

A.



B.



Dual Mount Hanging System

A. 6-1272-4-50
4-Light Convertible Semi-Flush
Black Cashmere Finish
18"W x 6"H
Adj H 6" - 60"
4C 60W
Clear Crystal

B. 7-1271-6-50
6-Light Pendant
Black Cashmere Finish
28"W x 6"H
Adj H 6" - 60"
6C 60W
Clear Crystal

DRYDEN

RENAISSANCE GUILD



*Includes 120" chain & 144" wire

DRYDEN

- A. 1-1938-36-89**
36-Light Chandelier
Matte Black Finish
60"W x 52"H
4W Integrated
Dimmable LED
400 Lumens,
3000K, 90+ CRI
Clear Crystal
LED G9 Bulbs Included

- B. 1-1939-12-89**
12-Light Chandelier
Matte Black Finish
32"W x 30"H
4W Integrated
Dimmable LED
400 Lumens,
3000K, 90+ CRI
Clear Crystal
LED G9 Bulbs Included

- C. 9-1940-2-89**
2-Light Sconce
Matte Black Finish
4-1/2"W x 12"H x 5-1/2"E
4W Integrated
Dimmable LED
400 Lumens,
3000K, 90+ CRI
Clear Crystal
LED G9 Bulbs Included



LED



KAHN

RENAISSANCE GUILD



*Includes 12" & 6" extensions - additional stems available - 7-EXTLG

- A. 1-6622-9-89**
 9-Light Chandelier (8+1)
 Matte Black Finish
 40"W x 26"H
 Adj H 26" - 80"
 5W Integrated
 Dimmable LED
 2158 Lumens,
 3000K, 90+ CRI
 Water Glass

- B. 1-6620-6-89**
 6-Light Chandelier (5+1)
 Matte Black Finish
 30"W x 20"H
 Adj H 20" - 74"
 5W Integrated
 Dimmable LED
 1548 Lumens,
 3000K, 90+ CRI
 Water Glass

- C. 9-6624-1-89**
 1-Light Sconce
 Matte Black Finish
 5"W x 9"H x 4" E
 5W Integrated
 Dimmable LED
 342 Lumens,
 3000K, 90+ CRI
 Water Glass

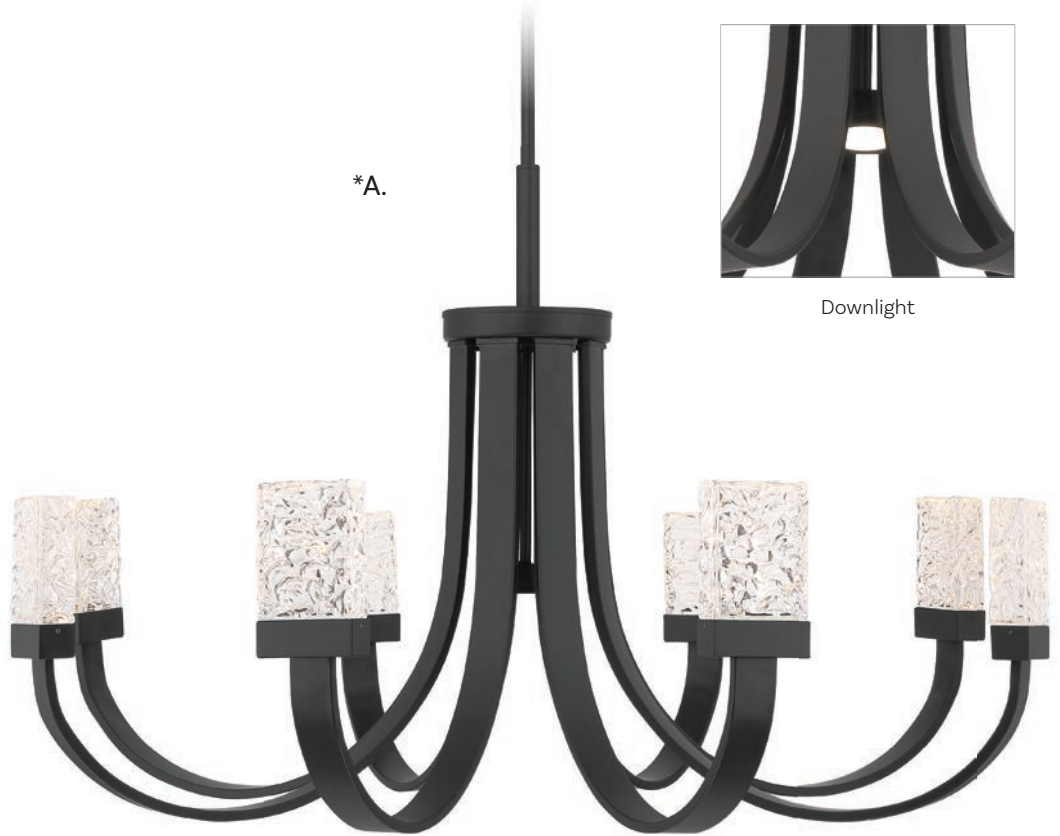

Downlight

*A.

LED



Downlight

*B.



C.



Dual Mount Hanging System

VASARE

RENAISSANCE GUILD



7-2351-12-11
12-Light Pendant
Chrome Finish
38"W x 31"H
Adj H 31" - 85"
12G9 40W
30° Swivel
Hand Made Marble Glass



Includes 12" & 6" extensions - additional stems available - **7-EXTLG**

ATLAS

BREEGAN JANE



Includes 120" chain & 144" wire



A.

A. 7-4001-6-31
6-Light Pendant
Grecian Gold Finish
24"W x 30"H
6C 60W



B.

B. 1-4000-6-31
6-Light Chandelier
Grecian Gold Finish
28-1/2"W x 30-3/4"H
6C 60W

VENICE

BREEGAN JANE



Includes 120" chain & 144" wire

VENICE

BREEGAN JANE



1-2493-6-104
6-Light Chandelier
Metropolis Black w/
Gold Finish
30"W x 6-1/2"H
6C 60W

ESTRELLA DEL MAR

BREEGAN JANE



Includes 12" & 6" extensions - additional stems available - **7-EXTLG**

ESTRELLA DEL MAR



Dual Mount Hanging System



1-5148-14-24

14-Light Chandelier

Centura w/ Burnished Gold

36"W x 26"H

Adj H 26" - 80"

14C 60W

BREEGAN JANE

PORTINATX

BREEGAN JANE



Includes 120" lamp cord

PORTINATX

BREEGAN JANE



1-2185-9-103
9-Light Linear Chandelier
Satin Black w/
Hammered Gold Finish
40"L x 9-1/4"W x 54-3/4"H
9E 60W

TURACO

BREEGAN JANE



Includes 12" & 6" extensions - additional stems available - **7-EXTLG**

TURACO

BREEGAN JANE

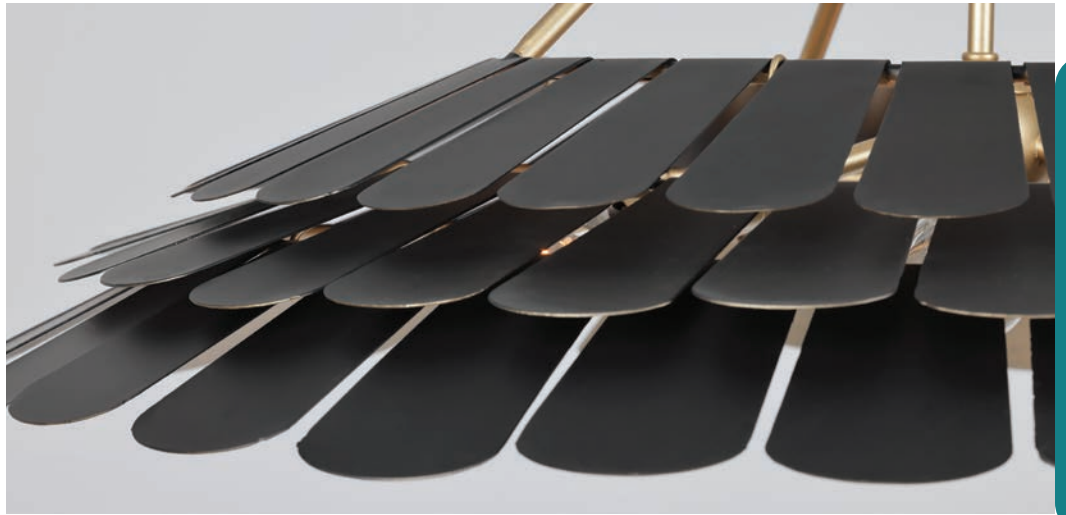

Dual Mount Hanging System

7-9012-6-58
6-Light Pendant
Midnight Finish
30"W x 13"H
Adj H 13" - 67"
6C 60W



HEIRESS

BREEGAN JANE



Includes 120" chain & 144" wire

HEIRESS

BREEGAN JANE

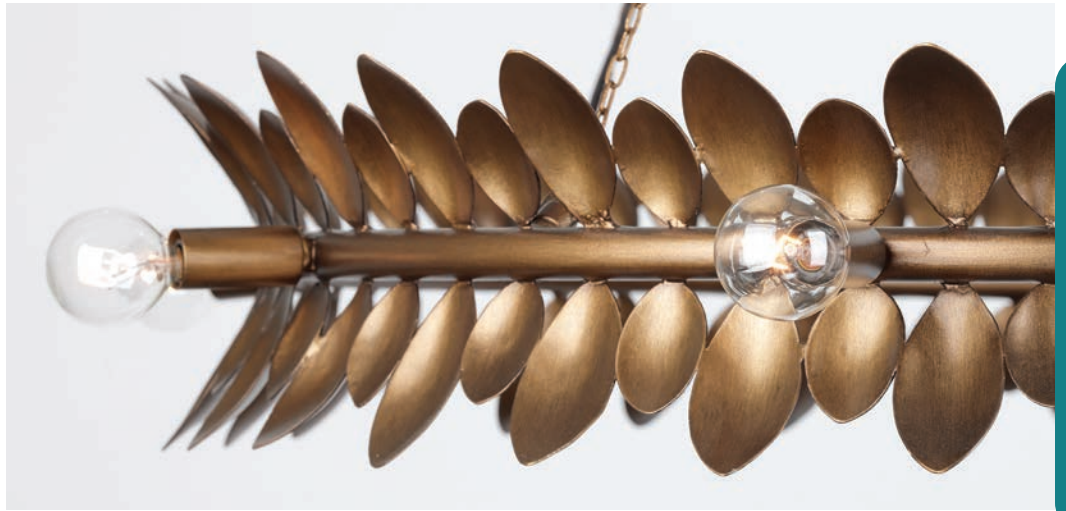

1-4681-8-102
8-Light Chandelier
Patinated Bronze Finish
36"W x 31-3/4"H
8C 60W



MONARCH

BREEGAN JANE



Includes 120" chain & 144" wire

MONARCH

BREEGAN JANE



1-8124-8-26
8-Light Pendant
Champagne Mist w/
Coconut Shell Finish
36"W x 35-1/4"H
8C 60W
Natural Coco Shell

GRECIAN

BREEGAN JANE



Includes 12" & 6" extensions - additional stems available - **7-EXTLG**

GRECIAN

BREGAN JANE



1-2579-6-26
6-Light Chandelier
Champagne Mist w/
Coconut Shell Finish
30"W x 18"H
Adj H 18" - 72"
6C 60W
Natural Coco Shell



PACHA

BREEGAN JANE



Includes 120" lamp cord

PACHA

BREEGAN JANE

1-6914-10-47
10-Light Chandelier
White Cashmere Finish
25"W x 54"H
Adj H 54" - 174"
10E 60W



MUSE

BREEGAN JANE



Includes 120" chain & 144" wire



1-5186-12-59
12-Light Chandelier
French Gold w/
White Cashmere Finish
52-1/2"W x 32"H
12C 60W

BOA

BREEGAN JANE



*Includes 120" chain & 144" wire

*A.



A. 1-3505-15-322
15-Light Chandelier
Warm Brass Finish
34"W x 30"H
15C 60W
Frosted Feather Glass

B. 9-3506-3-322
3-Light Sconce
Warm Brass Finish
10-1/2"W x 14"H x 6"E
3C 60W
Frosted Feather Glass

C. 1-3504-9-322
9-Light Chandelier
Warm Brass Finish
27"W x 25"H
9C 60W
Frosted Feather Glass

B.



*C.



LEGACY

BREEGAN JANE



Includes 12" & 6" extensions - additional stems available - **7-EXT**

LEGACY

BREEGAN JANE

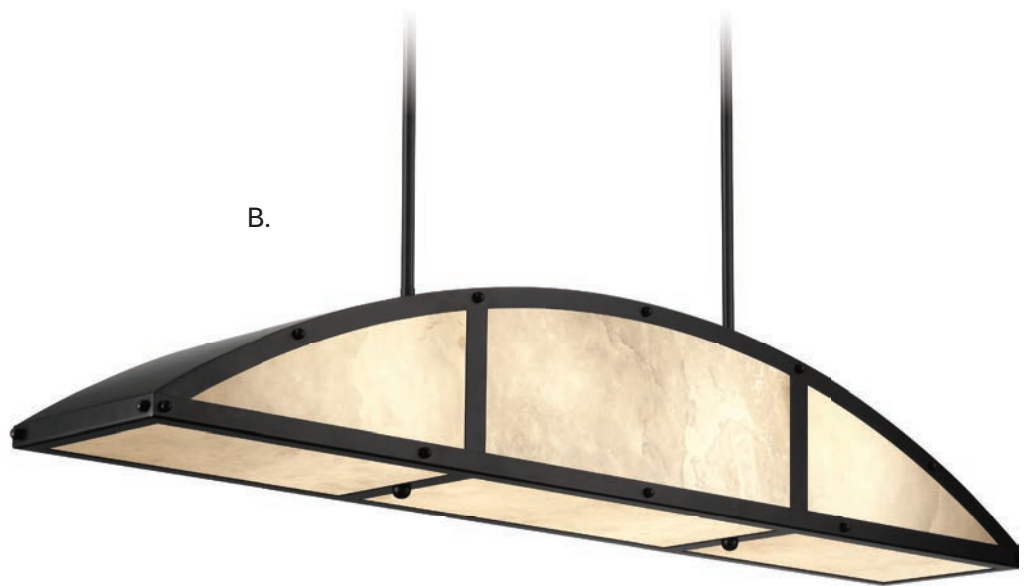
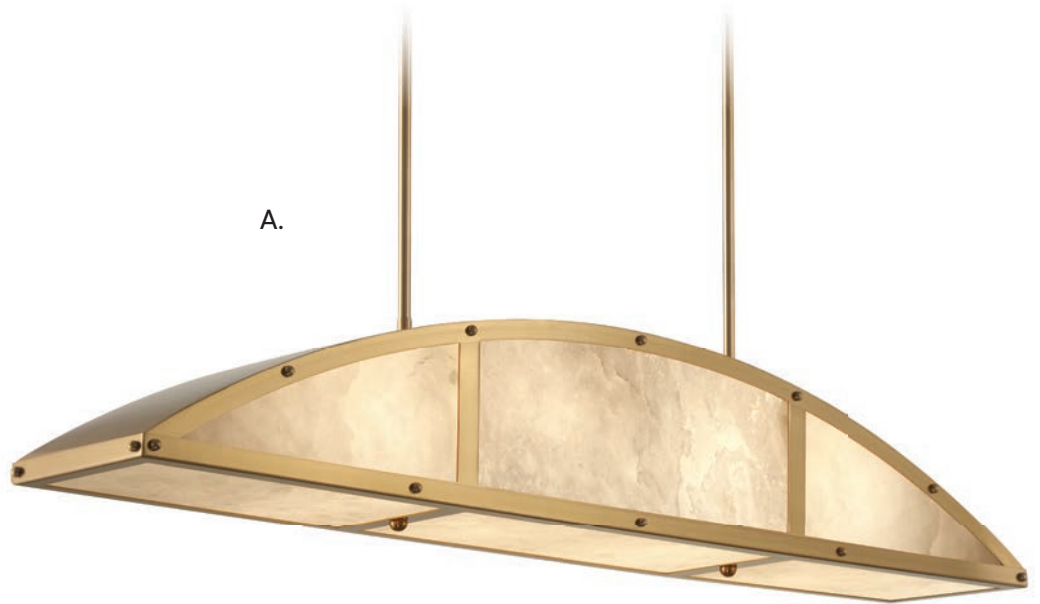

Dual Mount Hanging System

A. 1-6219-4-322
 4-Light Linear Chandelier
 Warm Brass Finish
 46" L x 8" W x 8" H
 Adj H 8" - 62"
 4C 60W
 Natural Alabaster Stone

B. 1-6219-4-89
 4-Light Linear Chandelier
 Matte Black Finish
 46" L x 8" W x 8" H
 Adj H 8" - 62"
 4C 60W
 Natural Alabaster Stone

ISLA BLANCA

BREEGAN JANE



A. 7-3171-1-322

1-Light Pendant
Warm Brass Finish
8"W x 15"H
Adj H 15" - 71"
1E 60W
White Porcelain Shades

B. 1-3173-8-322

8-Light Chandelier
Warm Brass Finish
40"W x 26"H
8E 60W
White Porcelain Shades

C. 1-3170-6-322

6-Light Chandelier
Warm Brass Finish
32"W x 22"H
6E 60W
White Porcelain Shades

D. 9-3172-1-322

1-Light Sconce
Warm Brass Finish
5"W x 9"H x 6-1/2"E
1E 60W
White Porcelain Shades

ISLA BLANCA

BREEGAN JANE

*A.



**B.



**C.



D.



*Includes 12" & 6" extensions - additional stems available - 7-EXT

**Includes 120" lamp cord

DEL MAR

BREEGAN JANE



*Includes 12" & 6" extensions - additional stems available - 7-EXTLG



Dual Mount Hanging System



- A. 1-2507-8-322**
8-Light Chandelier
Warm Brass Finish
48"W x 11-1/4"H
Adj H 11-1/4"H - 65-1/4"
5W Integrated Dimmable LED
2320 Lumens, 3000K, 90+ CRI
Clear Seeded Acrylic

- B. 9-2509-1-322**
1-Light Sconce
Warm Brass Finish
5-1/4"W x 13-1/4"H x 4-3/4"E
5W Integrated Dimmable LED
290 Lumens, 3000K, 90+ CRI
Clear Seeded Acrylic



DEL MAR

BREEGAN JANE



Includes 12" & 6" extensions - additional stems available - 7-EXT



Dual Mount Hanging System

A. 1-2508-4-322

4-Light Chandelier
Warm Brass Finish
30"W x 11-1/4"H
Adj H 11-1/4" - 65-1/4"
5W Integrated Dimmable LED
1160 Lumens, 3000K, 90+ CRI
Clear Seeded Acrylic

B. 1-8951-8-322

8-Light Linear Chandelier
Warm Brass Finish
48"L x 7-1/2"W x 11"H
Adj H 11" - 65"
5W Integrated Dimmable LED
2320 Lumens, 3000K, 90+ CRI
Clear Seeded Acrylic

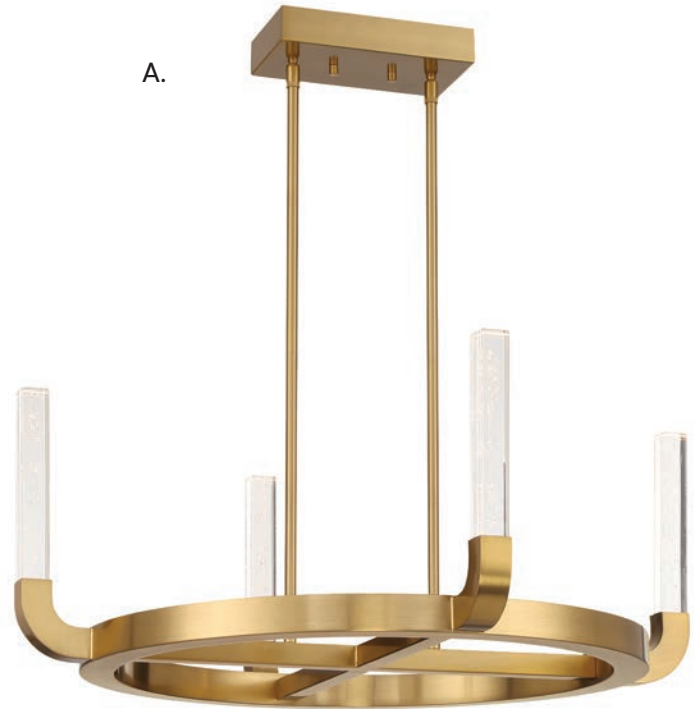

LED

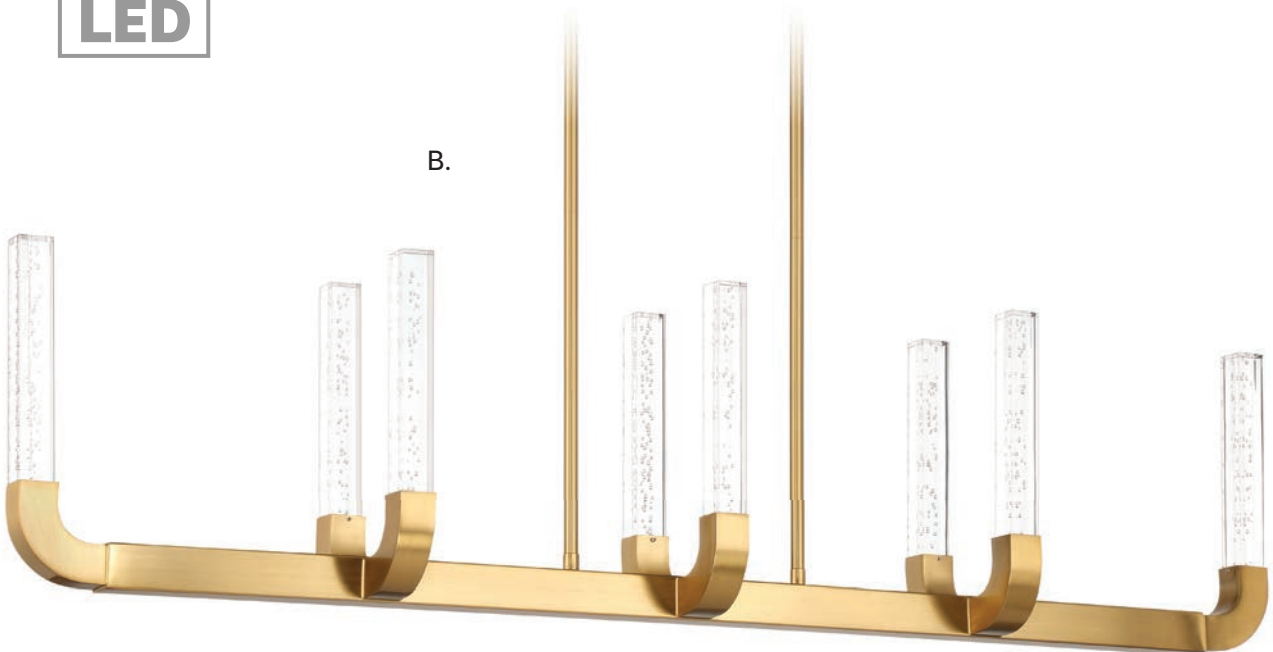

TALAMANCA

BREEGAN JANE - MODERNE



*Includes 12" & 6" extensions - additional stems available - 7-EXT

TALAMANCA

BREGAN JANE - MODERNE



Dual Mount Hanging System



- A. 1-7508-9-127**
9-Light Chandelier
Noble Brass Finish
32"W x 4"H
Adj H 4" - 58"
5W Integrated Dimmable LED
4500 Lumens, 3000K, 90+ CRI

- B. 9-7506-1-127**
1-Light Sconce
Noble Brass Finish
8"W x 4-3/4"H x 8-1/4"E
5W Integrated Dimmable LED
500 Lumens, 3000K, 90+ CRI

B.

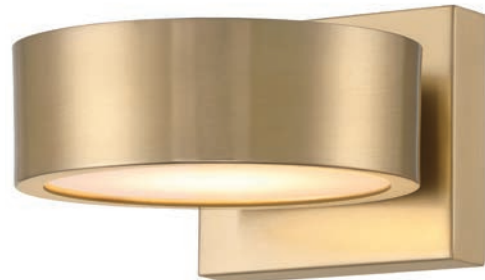

LED

LIO

BREEGAN JANE - MODERNE



Dual Mount Hanging System

A. 1-6508-5-127
5-Light Chandelier
Noble Brass Finish
28"W x 13"H
Adj H 13" - 67"
5E 60W

B. 9-6506-1-127
1-Light Sconce
Noble Brass Finish
5"W x 12"H x 5-1/2"E
1E 60W
UL Damp Rated

C. 1-4180-8-127
8-Light Chandelier
Noble Brass Finish
31"W x 11-1/2"H
Adj H 11-1/2" - 65-1/2"
8C 60W

LIO

BREGAN JANE - MODERNE

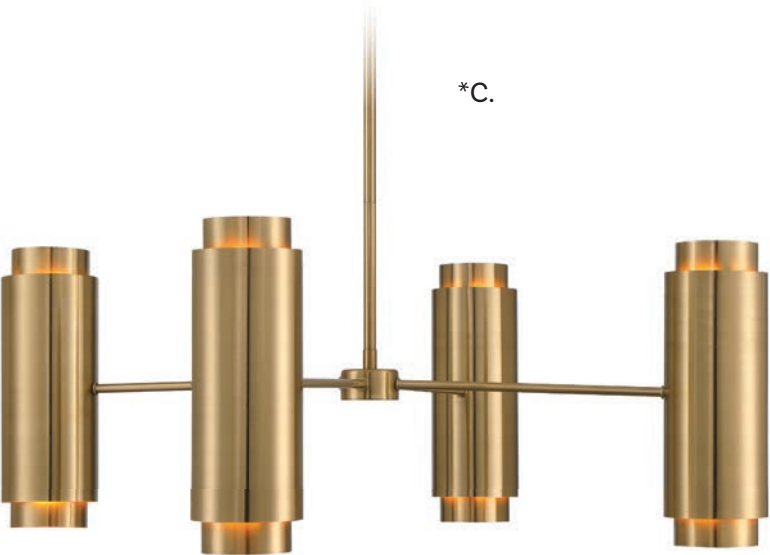
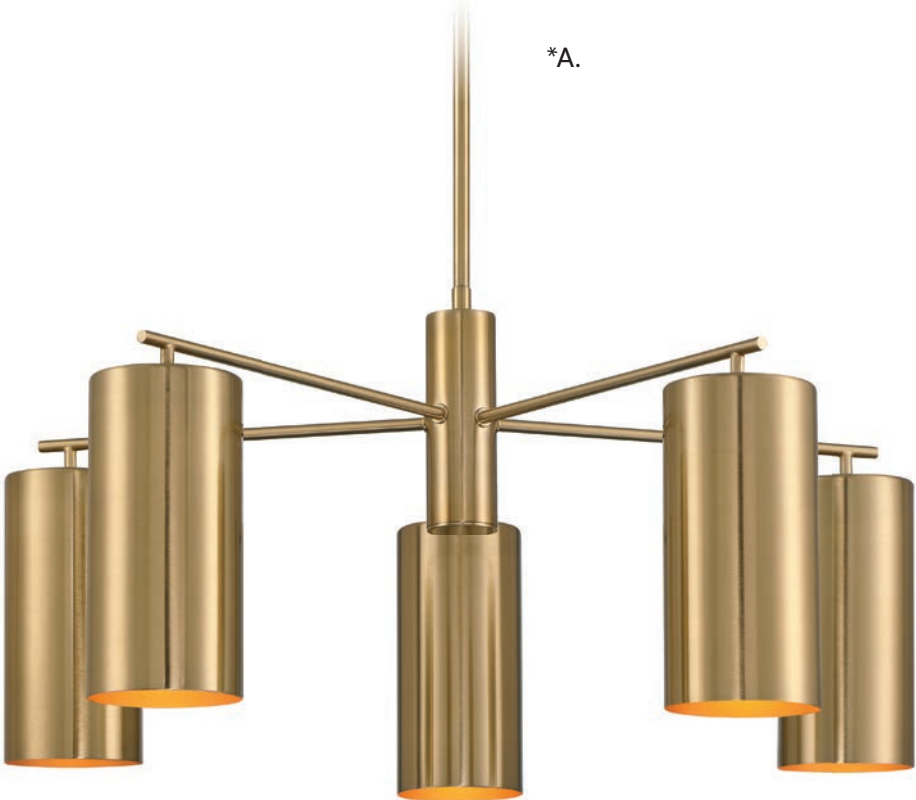

*Includes 12" & 6" extensions - additional stems available - 7-EXT

PHAROS

BREEGAN JANE - MODERNE



*Includes 12" & 6" extensions - additional stems available - **7-EXT**

**Includes cord, plug, and hardwire hardware

The arms of the Chandeliers are adjustable and can rotate into different positions

PHAROS

BREGAN JANE - MODERNE



Dual Mount Hanging System



- A. 1-8003-6-127**
6-Light Chandelier
Noble Brass Finish
38"W x 16-1/2"H
Adj H 16-1/2" - 70-1/2"
6C 60W

- B. 9-8006CP-1-127**
1-Light Adjustable Sconce
Noble Brass Finish
8"W x 18-1/2"H x 10"E
Adj E 10" - 32"
1C 60W

- C. 9-8002CP-1-127**
1-Light Adjustable Sconce
Noble Brass Finish
8"W x 11"H x 11"E
1C 60W



PHAROS

BREEGAN JANE

A.



B.



C.

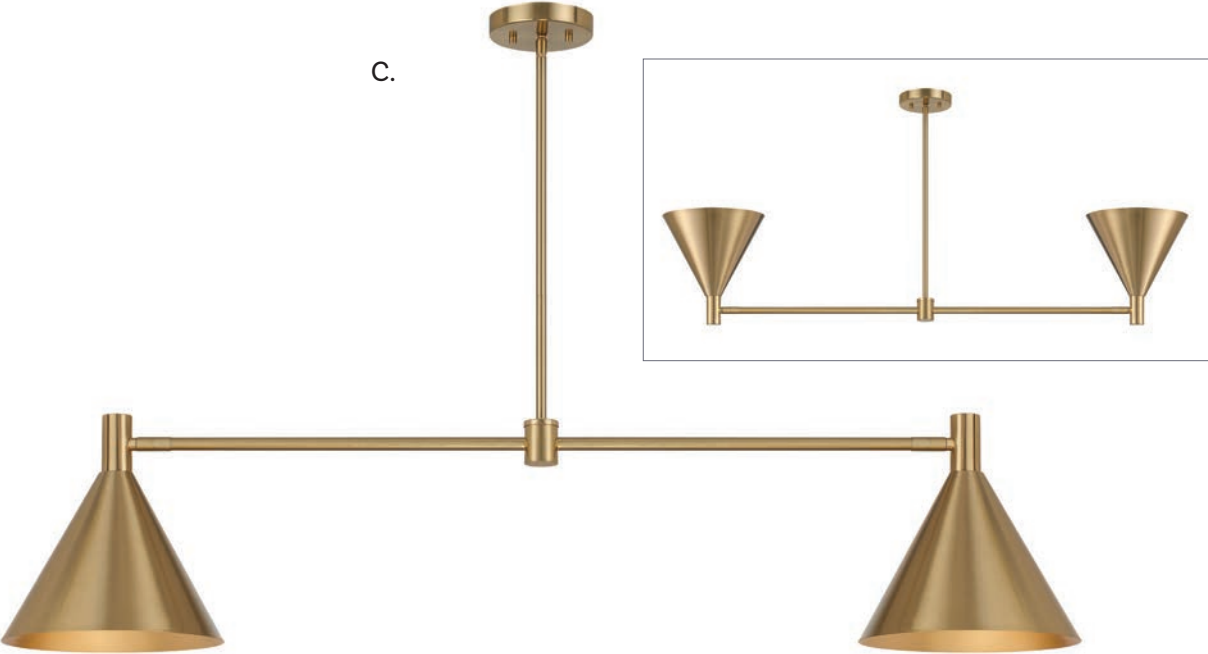

Includes 12" & 6" extensions – additional stems available – **7-EXT**
The Shades of the Chandeliers are adjustable and can swivel up and down

PHAROS

BREEGAN JANE



Dual Mount Hanging System

A. 1-8004-5-127
5-Light Chandelier
Noble Brass Finish
30"W x 11"H
Adj H 11" - 65"
5C 60W

B. 7-8001-1-127
1-Light Pendant
Noble Brass Finish
13"W x 13-1/4"H
Adj H 13-1/4" - 67-1/4"
1E 60W

C. 1-8005-2-127
2-Light Linear Chandelier
Noble Brass Finish
50"L x 10"W x 11"H
Adj H 11" - 65"
2C 60W

AVONDALE

ESSENTIALS



*Includes 120" chain & 144" wire

AVONDALE

*A.



A. 1-4046-12-322
12-Light Chandelier
Warm Brass Finish
34"W x 33-3/4"H
12C 60W

B. 9-4044-2-322
2-Light Sconce
Warm Brass Finish
7"W x 12"H x 4"E
2C 60W

B.



AVONDALE

ESSENTIALS

A. 1-4046-12-83
12-Light Chandelier
Bisque White Finish
34"W x 33-3/4"H
12C 60W

B. 9-4044-2-83
2-Light Sconce
Bisque White Finish
7"W x 12"H x 4"E
2C 60W



AVONDALE

*C.



C. 1-4046-12-89
12-Light Chandelier
Matte Black Finish
34"W x 33-3/4"H
12C 60W

D. 9-4044-2-89
2-Light Sconce
Matte Black Finish
7"W x 12"H x 4"E
2C 60W

D.



*Includes 120" chain & 144" wire

BAKER

ESSENTIALS



Includes 12" & 6" extensions - additional stems available - **7-EXT**

BAKER

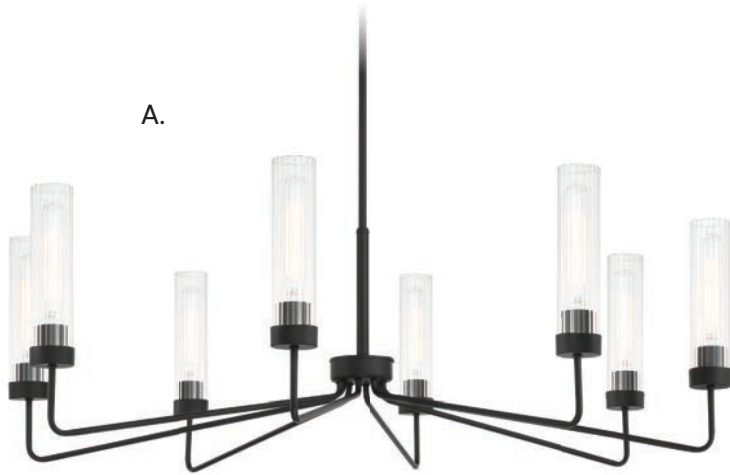

A.

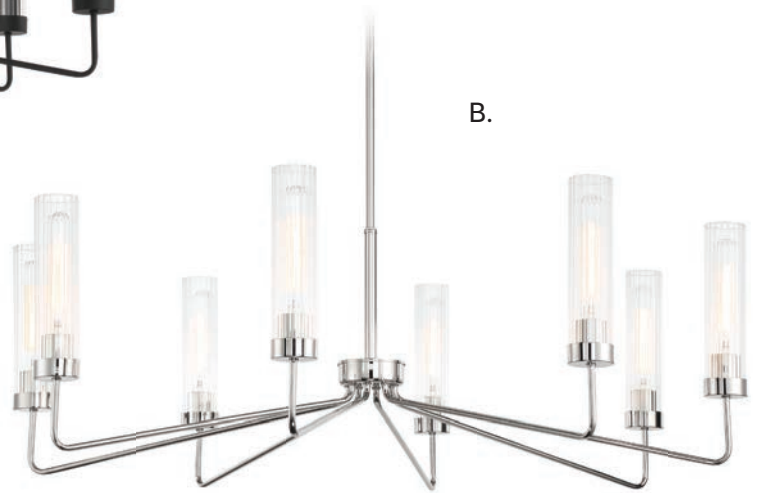

B.



C.



Dual Mount Hanging System

A. 1-8860-8-89
8-Light Chandelier
Matte Black Finish
44"W x 14"H
Adj H 14" - 68"
8E 60W
Clear Ribbed Glass

B. 1-8860-8-109
8-Light Chandelier
Polished Nickel Finish
44"W x 14"H
Adj H 14" - 68"
8E 60W
Clear Ribbed Glass

C. 1-8860-8-322
8-Light Chandelier
Warm Brass Finish
44"W x 14"H
Adj H 14" - 68"
8E 60W
Clear Ribbed Glass

BAKER

ESSENTIALS



A.



Dual Mount Hanging System



Includes 12" & 6" extensions - additional stems available - 7-EXT

BAKER

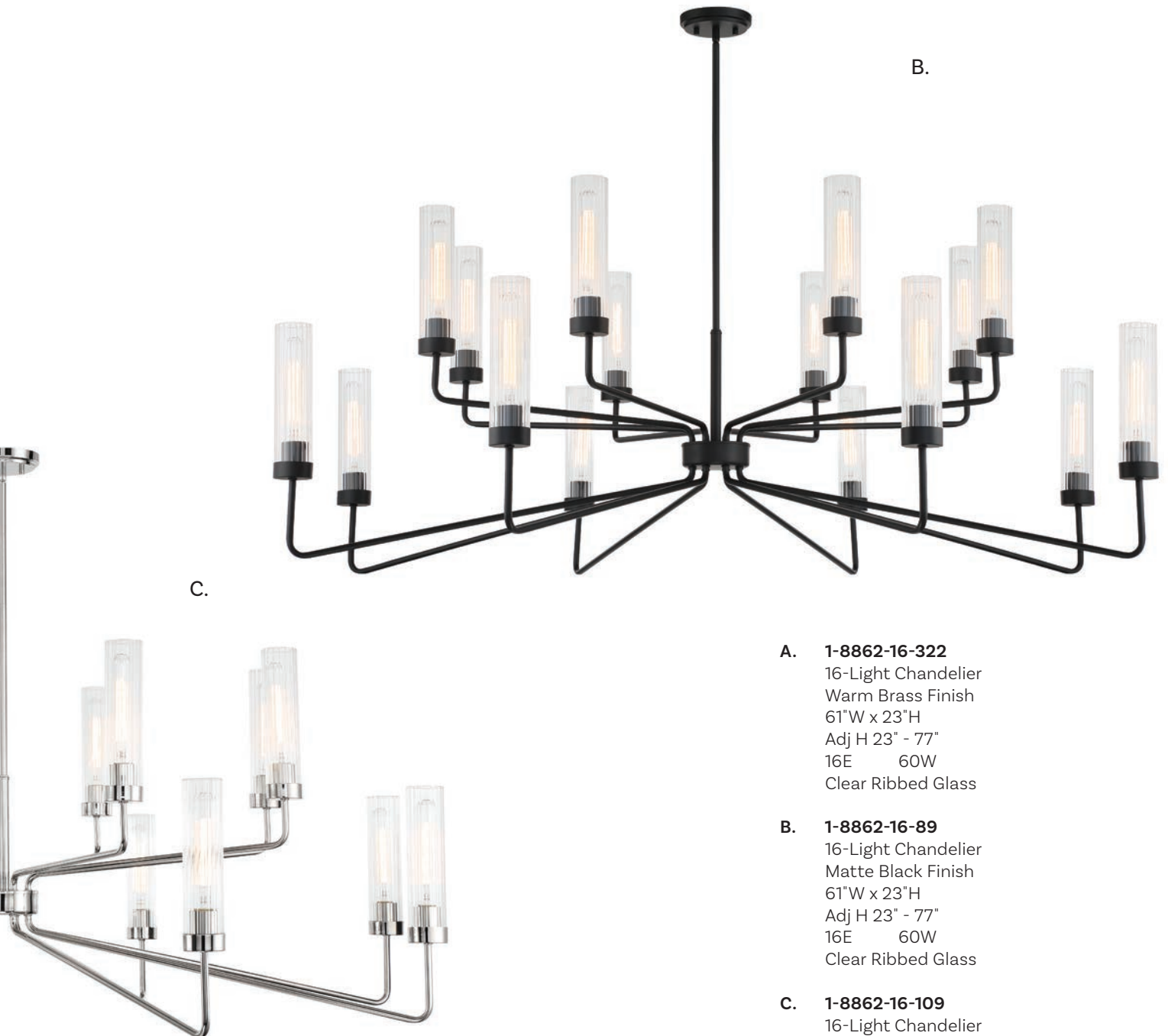

A. 1-8862-16-322
16-Light Chandelier
Warm Brass Finish
61"W x 23"H
Adj H 23" - 77"
16E 60W
Clear Ribbed Glass

B. 1-8862-16-89
16-Light Chandelier
Matte Black Finish
61"W x 23"H
Adj H 23" - 77"
16E 60W
Clear Ribbed Glass

C. 1-8862-16-109
16-Light Chandelier
Polished Nickel Finish
61"W x 23"H
Adj H 23" - 77"
16E 60W
Clear Ribbed Glass

SALERNO

ESSENTIALS



A. 1-2221-6-109
6-Light Chandelier
Polished Nickel Finish
42"W x 25"H
6C 60W

B. 1-2221-6-89
6-Light Chandelier
Matte Black Finish
42"W x 25"H
6C 60W

C. 1-2221-6-83
6-Light Chandelier
Bisque White Finish
42"W x 25"H
6C 60W

D. 1-2221-6-322
6-Light Chandelier
Warm Brass Finish
42"W x 25"H
6C 60W

SALERNO

A.

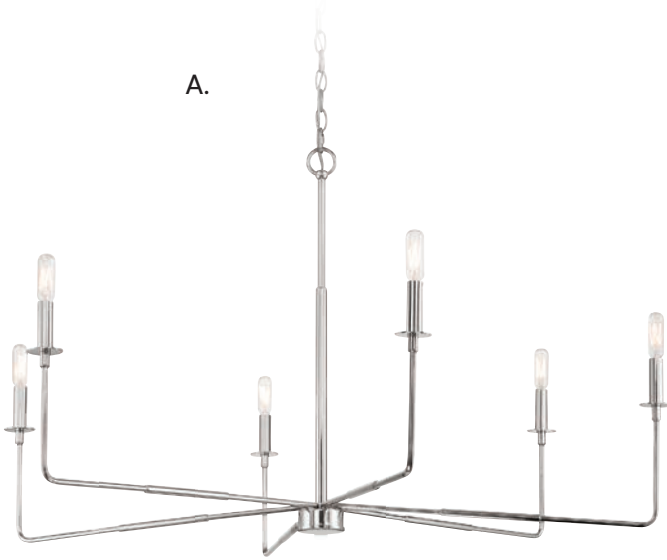

B.

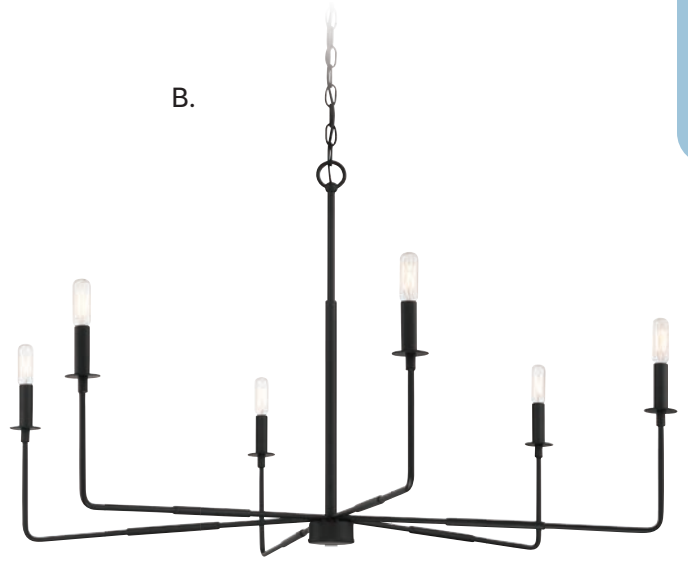

C.

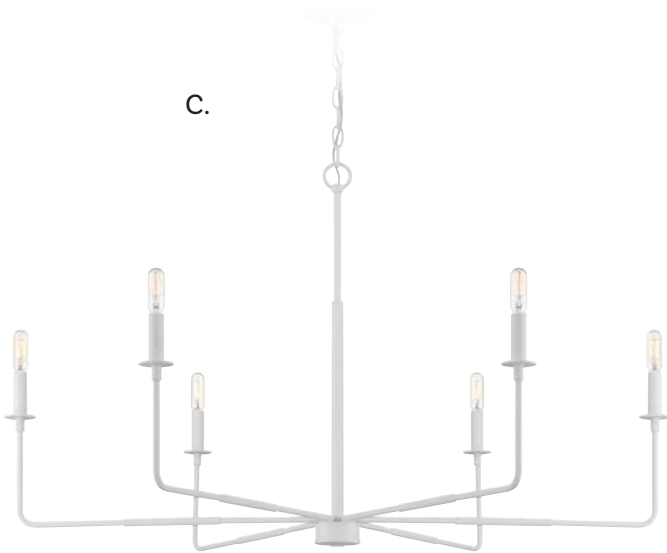

D.

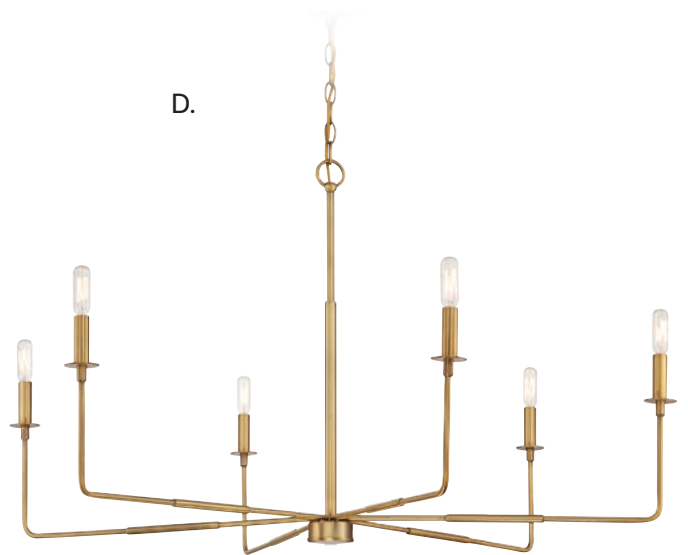

Includes 120" chain & 144" wire

JASMINE

ESSENTIALS

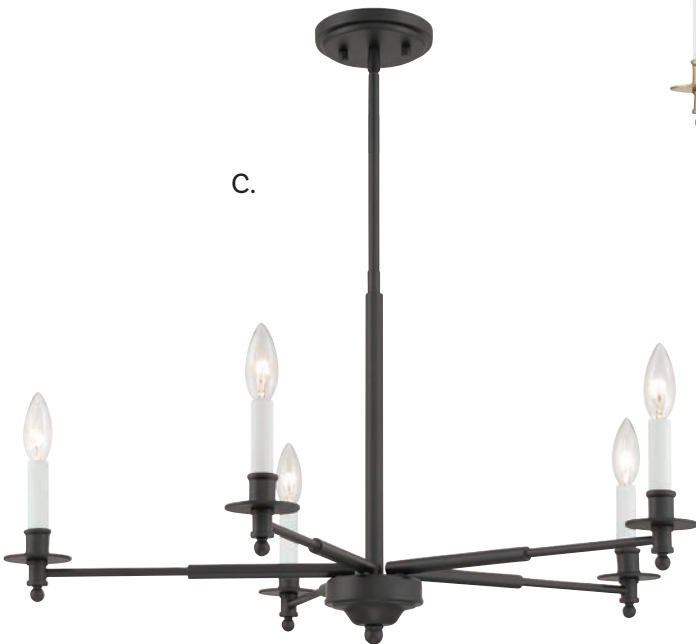
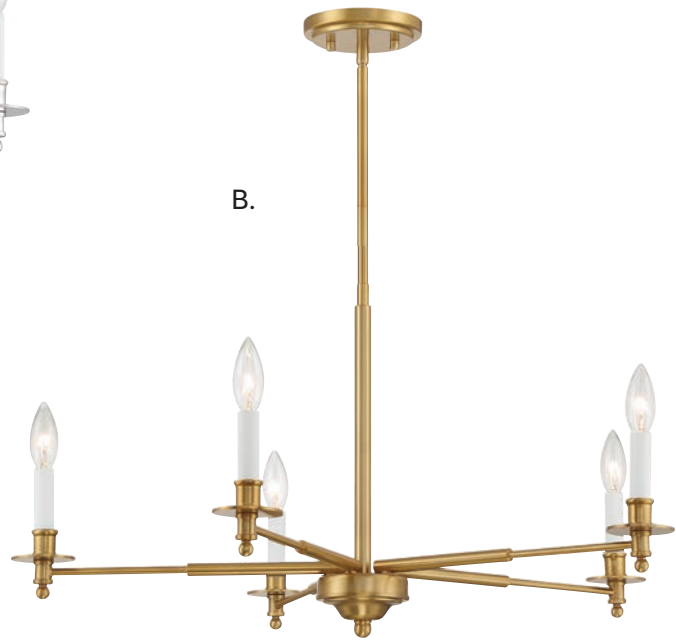
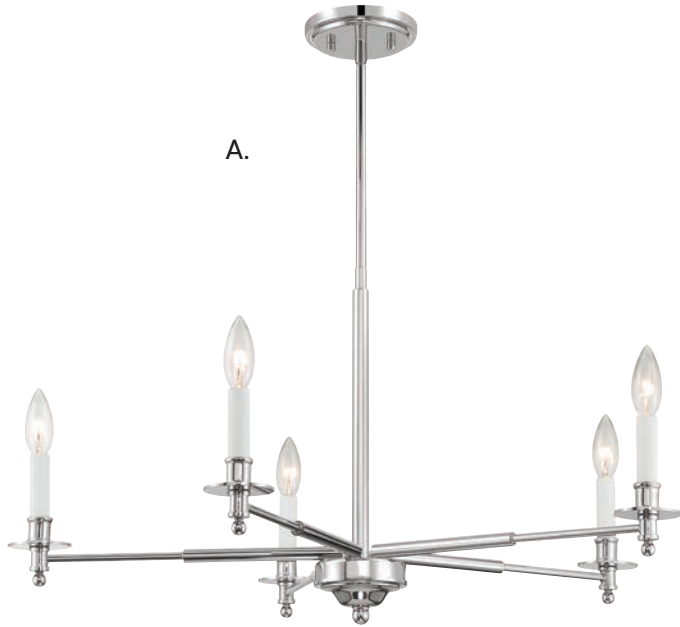

Includes 12" & 6" extensions - additional stems available - **7-EXT**

JASMINE

ESSENTIALS



Dual Mount Hanging System



A. 1-4410-5-109
5-Light Chandelier
Polished Nickel Finish
30"W x 15-1/2"H
Adj H 15-1/2" - 69-1/2"
5C 60W

B. 1-4410-5-322
5-Light Chandelier
Warm Brass Finish
30"W x 15-1/2"H
Adj H 15-1/2" - 69-1/2"
5C 60W

C. 1-4410-5-89
5-Light Chandelier
Matte Black Finish
30"W x 15-1/2"H
Adj H 15-1/2" - 69-1/2"
5C 60W

JASMINE

ESSENTIALS

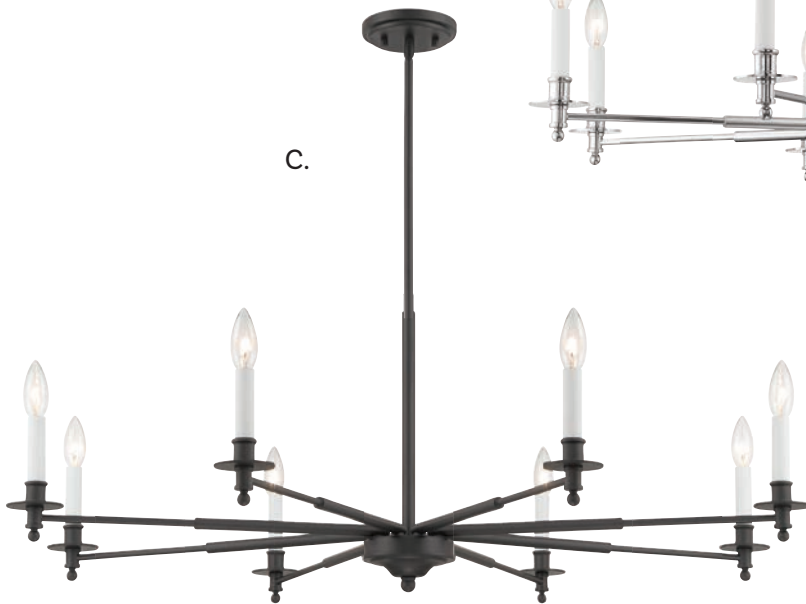
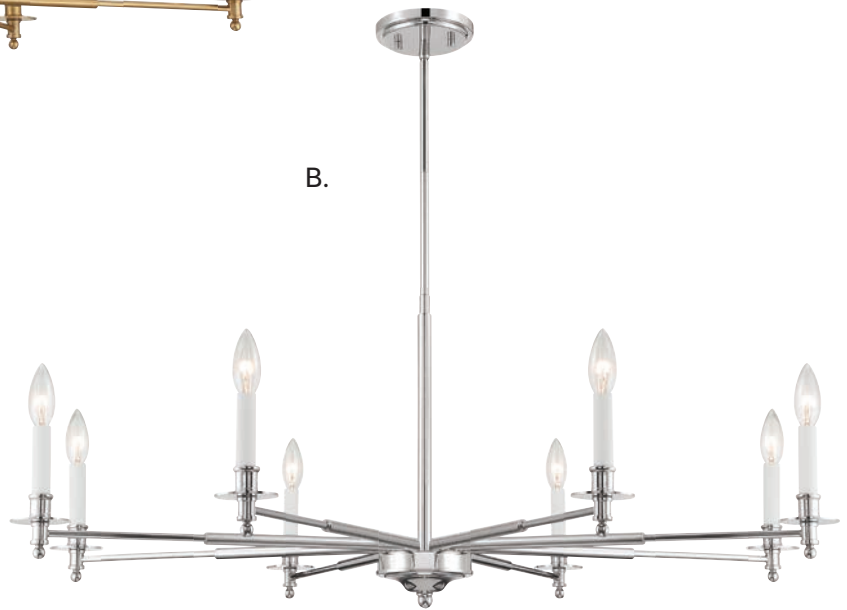
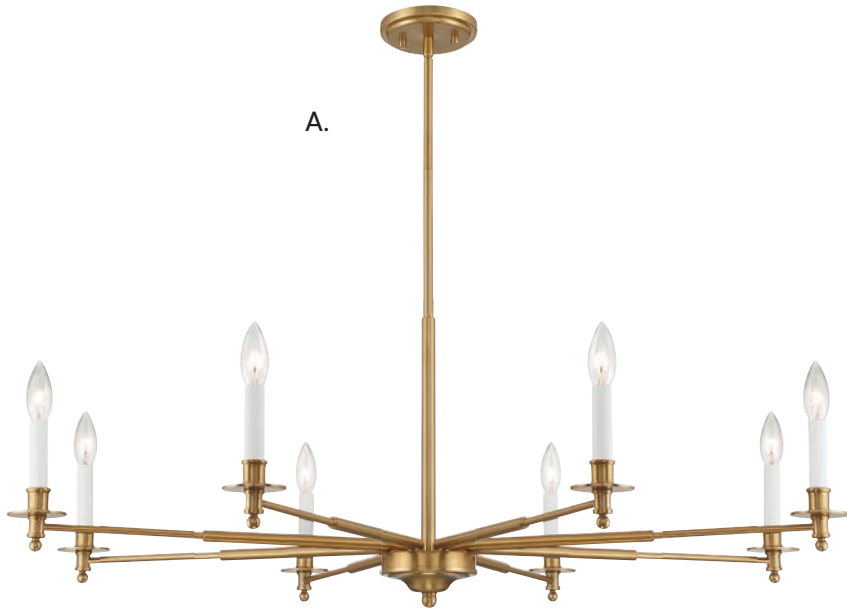

Includes 12" & 6" extensions - additional stems available - 7-EXT

JASMINE

ESSENTIALS



Dual Mount Hanging System

A. 1-4412-8-322
8-Light Chandelier
Warm Brass Finish
42"W x 15-1/2"H
Adj H 15-1/2" - 69-1/2"
8C 60W

B. 1-4412-8-109
8-Light Chandelier
Polished Nickel Finish
42"W x 15-1/2"H
Adj H 15-1/2" - 69-1/2"
8C 60W

C. 1-4412-8-89
8-Light Chandelier
Matte Black Finish
42"W x 15-1/2"H
Adj H 15-1/2" - 69-1/2"
8C 60W

SORRENTO

ESSENTIALS



Includes 12" & 6" extensions - additional stems available - 7-EXTLG

SORRENTO



Dual Mount Hanging System

- A. 1-6680-8-89**
8-Light Chandelier
Matte Black Finish
34"W x 21"H
Adj H 21" - 75"
8C 60W

- B. 1-6682-15-89**
15-Light Chandelier
Matte Black Finish
42"W x 29"H
Adj H 29" - 83"
15C 60W

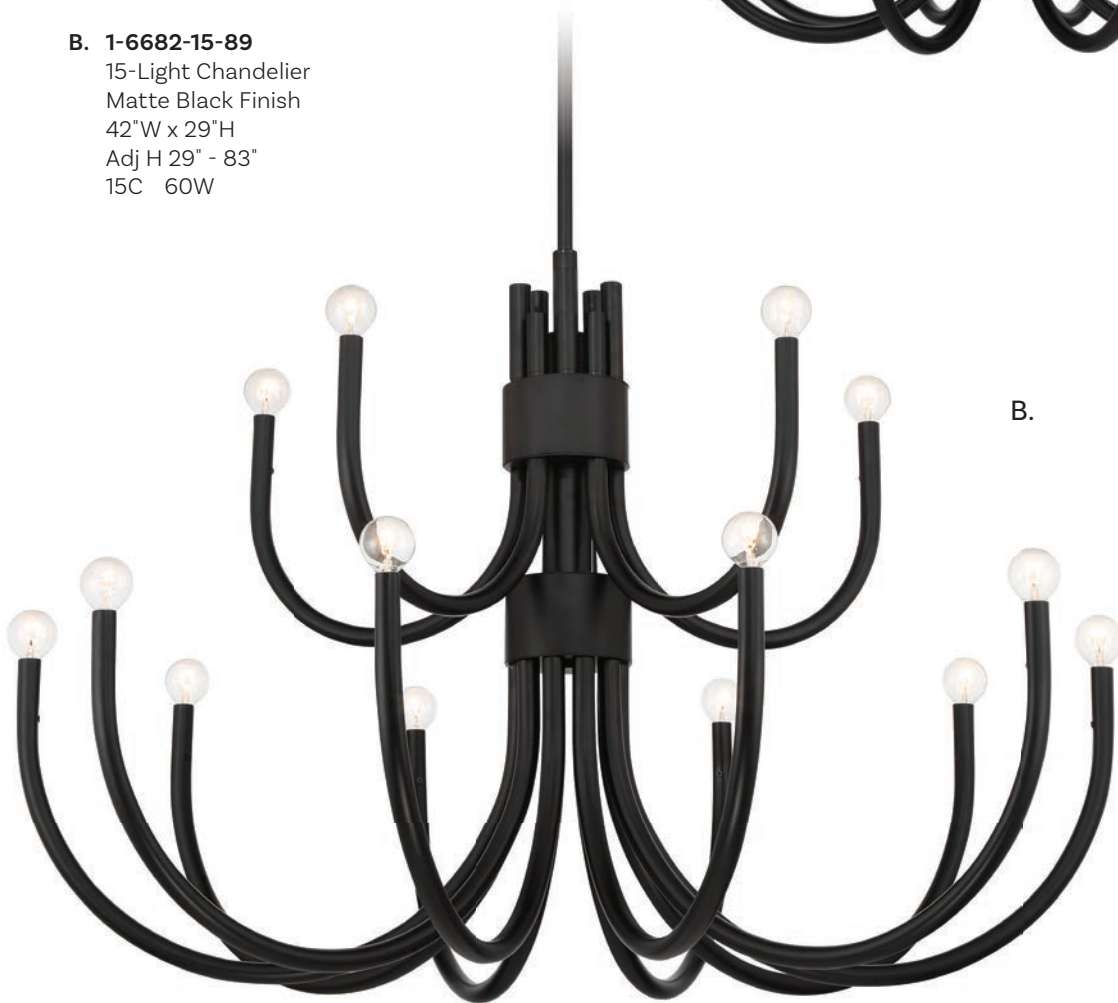
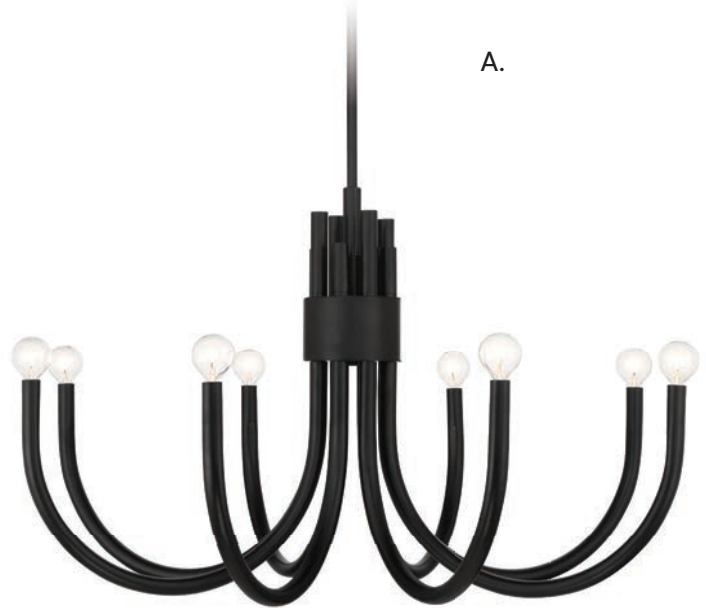

SORRENTO

ESSENTIALS

A.

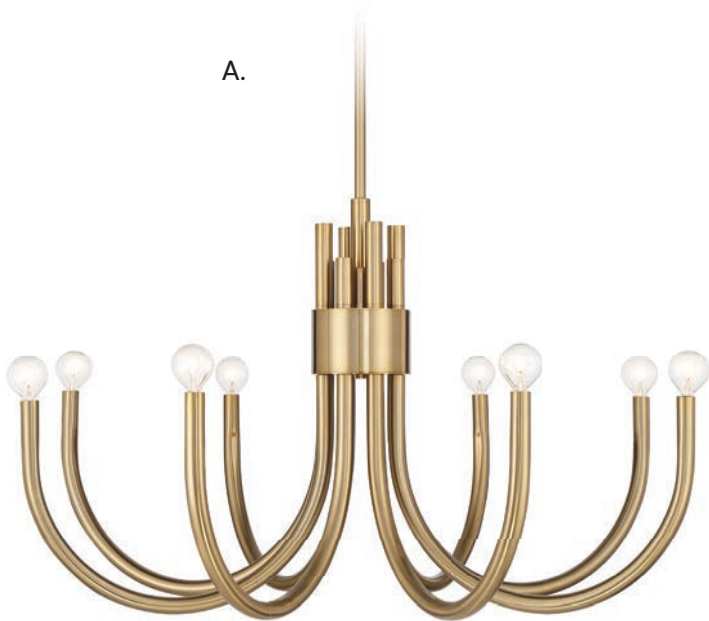

Dual Mount Hanging System

A. 1-6680-8-127

8-Light Chandelier
Noble Brass Finish
34"W x 21"H
Adj H 21" - 75"
8C 60W

B. 1-6682-15-127

15-Light Chandelier
Noble Brass Finish
42"W x 29"H
Adj H 29" - 83"
15C 60W

B.

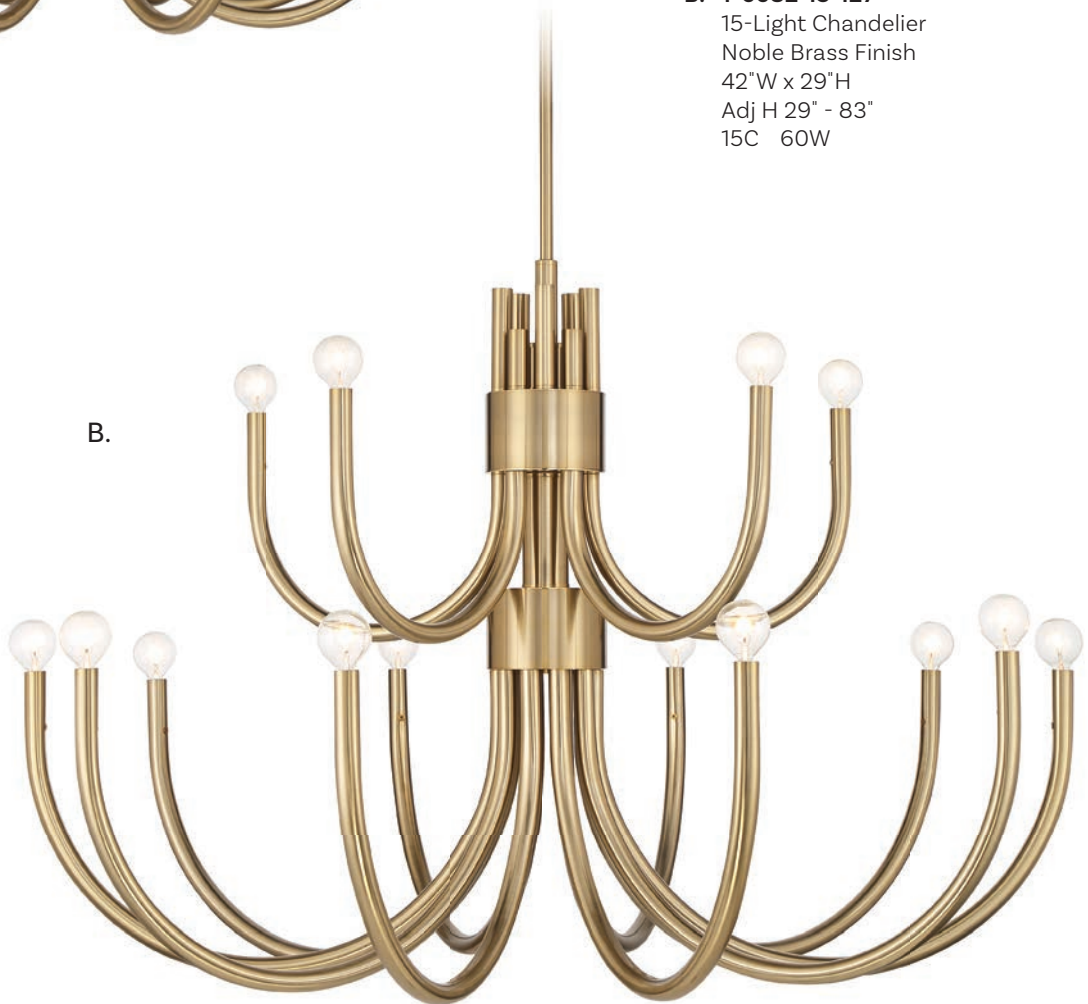

Includes 12" & 6" extensions - additional stems available - **7-EXTLG**

SORRENTO



Dual Mount Hanging System

C. 1-6680-8-SN
8-Light Chandelier
Satin Nickel Finish
34"W x 21"H
Adj H 21" - 75"
8C 60W

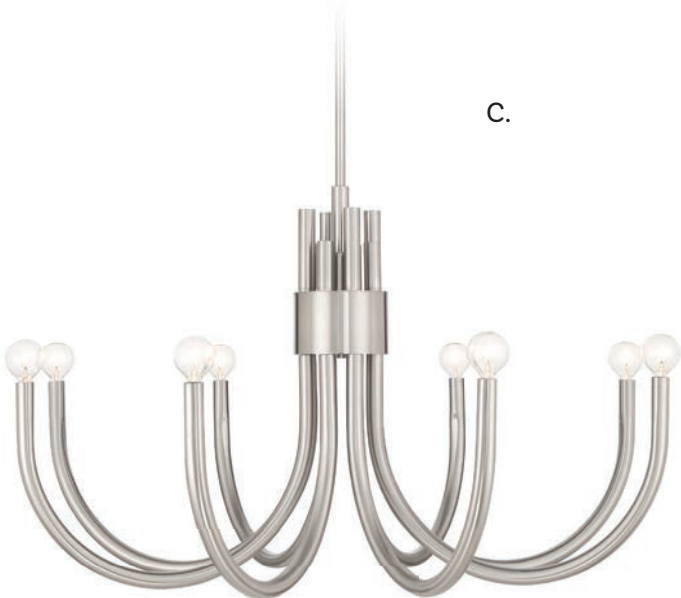

C.

D. 1-6682-15-SN
15-Light Chandelier
Satin Nickel Finish
42"W x 29"H
Adj H 29" - 83"
15C 60W

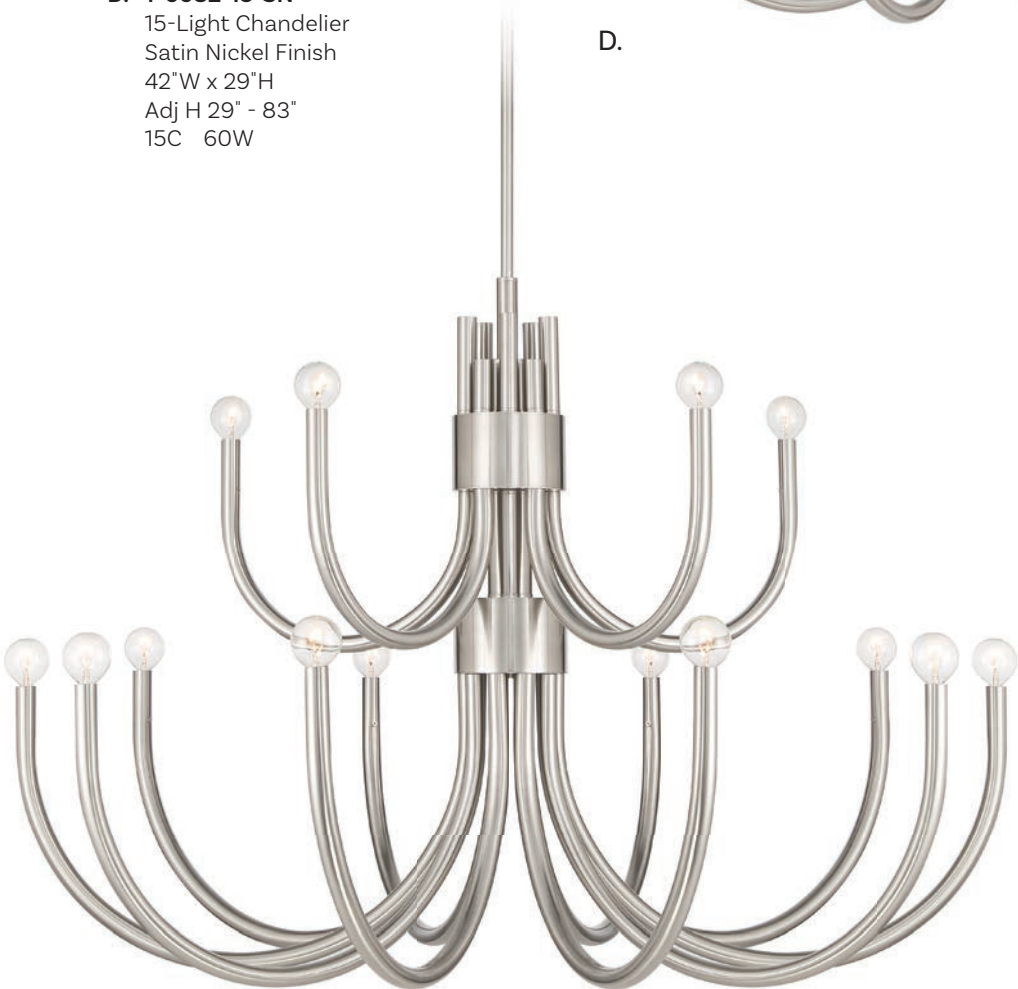

D.

STONECREST

ESSENTIALS



A. 1-1202-8-186
8-Light Chandelier
French Gold Finish
42"W x 28"H
8C 60W

B. 1-1202-8-83
8-Light Chandelier
Bisque White Finish
42"W x 28"H
8C 60W

C. 1-1202-8-89
8-Light Chandelier
Matte Black Finish
42"W x 28"H
8C 60W

STONECREST

ESSENTIALS

A.

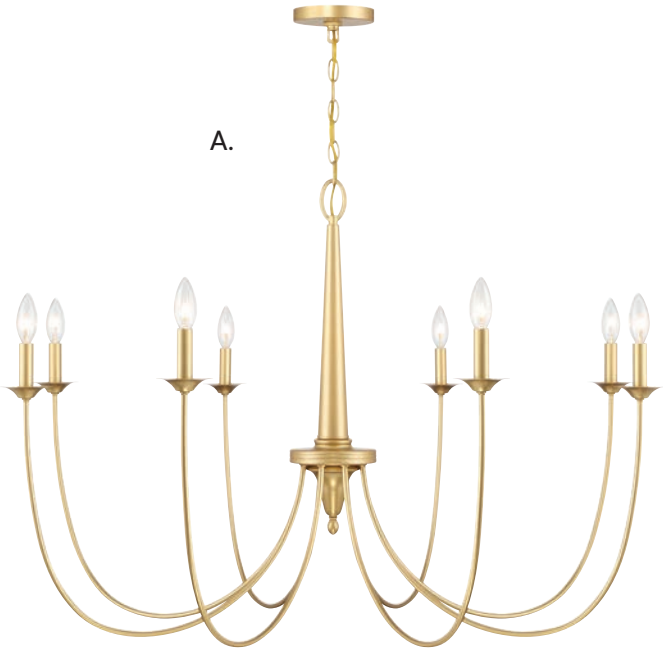

B.

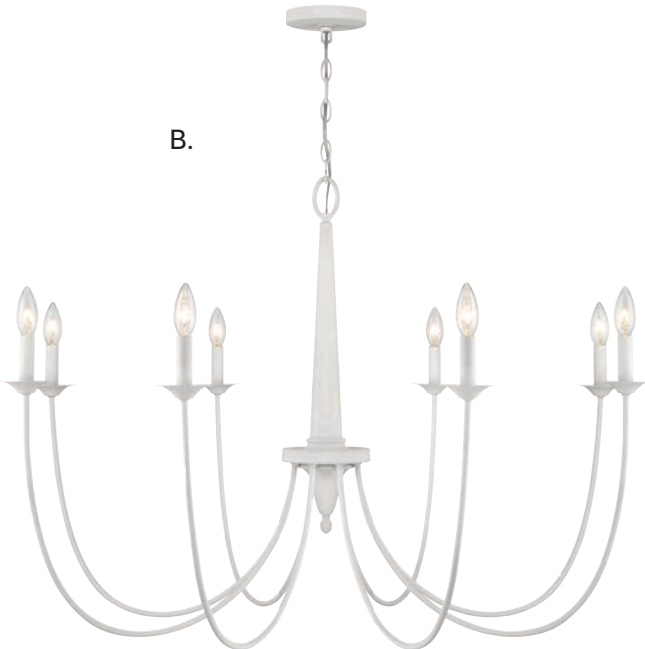

C.

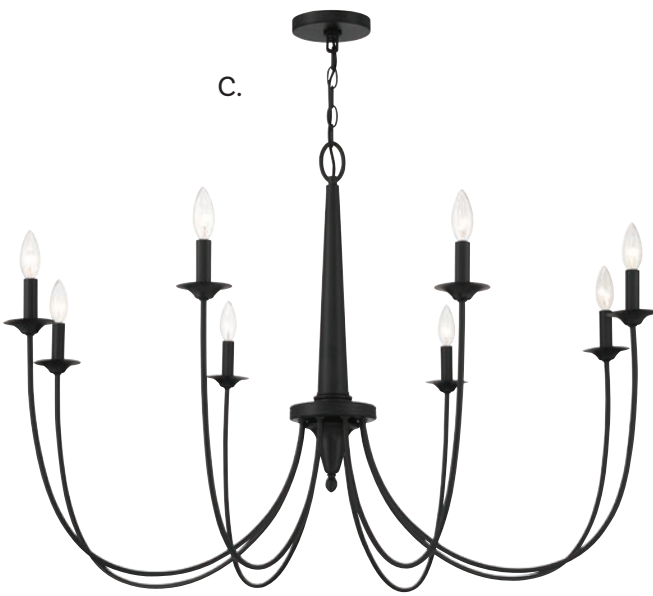

Includes 120" chain & 144" wire

CAMERON

ESSENTIALS



Includes 12" & 6" extensions - additional stems available - 7-EXT

CAMERON



A.



B.

A. 1-2541-9-89
9-Light Chandelier
Matte Black Finish
35"W x 24"H
Adj H 24" - 78"
9C 40W
30° Swivel
White Fabric Shade

B. 1-2541-9-322
9-Light Chandelier
Warm Brass Finish
35"W x 24"H
Adj H 24" - 78"
9C 40W
30° Swivel
White Fabric Shade

C. 1-2541-9-109
9-Light Chandelier
Polished Nickel Finish
35"W x 24"H
Adj H 24" - 78"
9C 40W
30° Swivel
White Fabric Shade



C.

CAMERON

ESSENTIALS



A.

- A. 1-2540-5-89**
5-Light Chandelier
Matte Black Finish
29"W x 13"H
Adj H 13" - 67"
5C 40W
30° Swivel
White Fabric Shade



B.

- B. 1-2540-5-322**
5-Light Chandelier
Warm Brass Finish
29"W x 13"H
Adj H 13" - 67"
5C 40W
30° Swivel
White Fabric Shade



Bath, Page 586



Sconce, Page 532

Includes 12" & 6" extensions - additional stems available - **7-EXT**

CAMERON

ESSENTIALS



EDGEWOOD

ESSENTIALS



Includes 12" & 6" extensions - additional stems available - 7-EXT

EDGEWOOD



A. 1-1785-6-322
 6-Light Linear Chandelier
 Warm Brass Finish
 35"L X 16-1/8"W x 10"H
 Adj H 10" - 64"
 6C 60W
 Black Fabric Shade

B. 1-1786-5-322
 5-Light Chandelier
 Warm Brass Finish
 32"W x 10"H
 Adj H 10" - 64"
 5C 60W
 Black Fabric Shade

C. 1-1786-5-89
 5-Light Chandelier
 Matte Black Finish
 32"W x 10"H
 Adj H 10" - 64"
 5C 60W
 Oatmeal Fabric Shade

D. 1-1785-6-89
 6-Light Linear Chandelier
 Matte Black Finish
 35"L X 16-1/8"W x 10"H
 Adj H 10" - 64"
 6C 60W
 Oatmeal Fabric Shade

POWELL

ESSENTIALS

A.



B.



C.

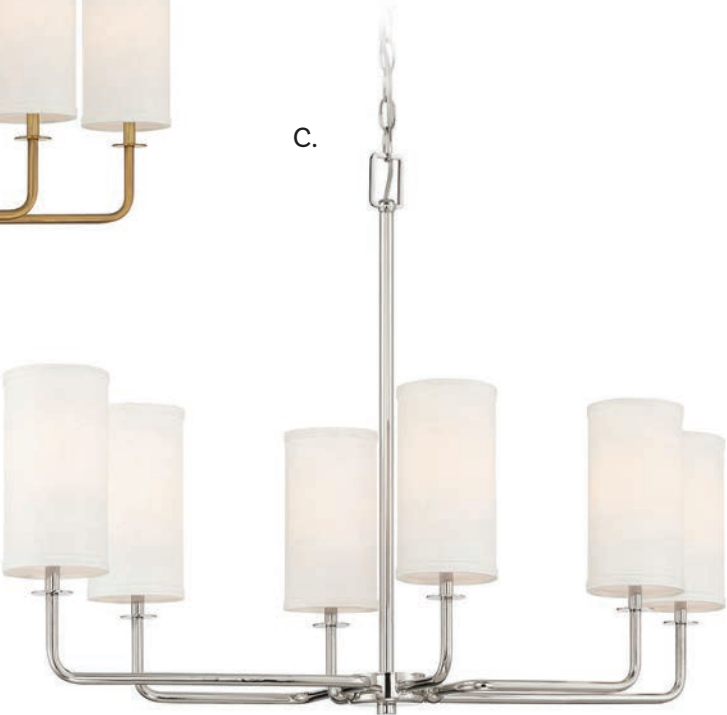

Includes 120" chain & 144" wire



A. 1-1756-6-89

6-Light Linear Chandelier
Matte Black Finish
35"L x 15"W x 23"H
6C 60W
White Fabric Shade

B. 1-1756-6-322

6-Light Linear Chandelier
Warm Brass Finish
35"L x 15"W x 23"H
6C 60W
White Fabric Shade

C. 1-1756-6-109

6-Light Linear Chandelier
Polished Nickel Finish
35"L x 15"W x 23"H
6C 60W
White Fabric Shade



Sconce, Page 534

BRODY

ESSENTIALS



*Includes 12" & 6" extensions - additional stems available - 7-EXT



Dual Mount Hanging System

A. 1-1630-5-173
 5-Light Chandelier
 Matte Black w/
 Polished Nickel
 28"W x 18"H
 Adj H 18" - 72"
 5C 60W
 White Fabric Shade

B. 1-1630-5-143
 5-Light Chandelier
 Matte Black w/
 Warm Brass
 28"W x 18"H
 Adj H 18" - 72"
 5C 60W
 White Fabric Shade



Sconce, Page 528

BRODY

A.



Dual Mount Hanging System

A. 1-1631-6-143

6-Light Linear Chandelier
Matte Black w/
Warm Brass
41"L x 18"W x 18"H
Adj H 18" - 72"
6C 60W
White Fabric Shade

B. 1-1631-6-173

6-Light Linear Chandelier
Matte Black w/
Polished Nickel
41"L x 18"W x 18"H
Adj H 18" - 72"
6C 60W
White Fabric Shade

B.



BRODY

ESSENTIALS



Includes 12" & 6" extensions - additional stems available - **7-EXT**

MIDDLETON

ESSENTIALS



Includes 120" chain & 144" wire

MIDDLETON

A.



B.



A. 1-307-6-89

6-Light Chandelier
Matte Black Finish
25"W x 23"H
6C 60W

B. 1-307-6-322

6-Light Chandelier
Warm Brass Finish
25"W x 23"H
6C 60W

MIDDLETON

ESSENTIALS

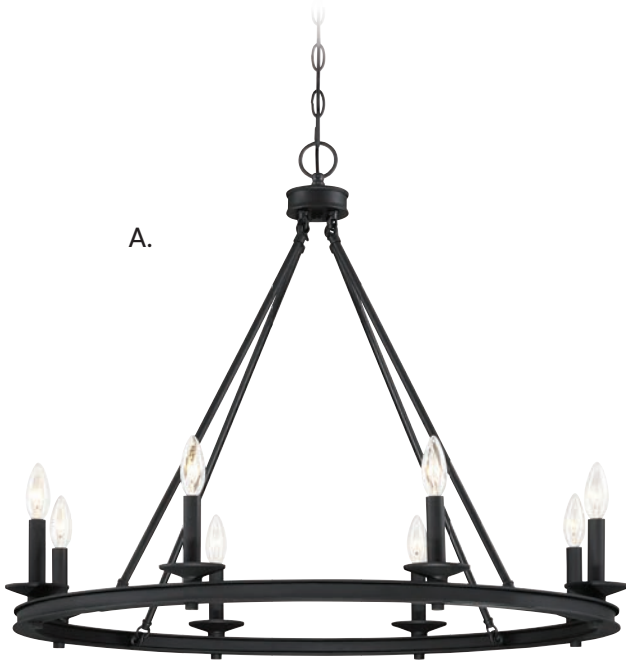

A.



B.

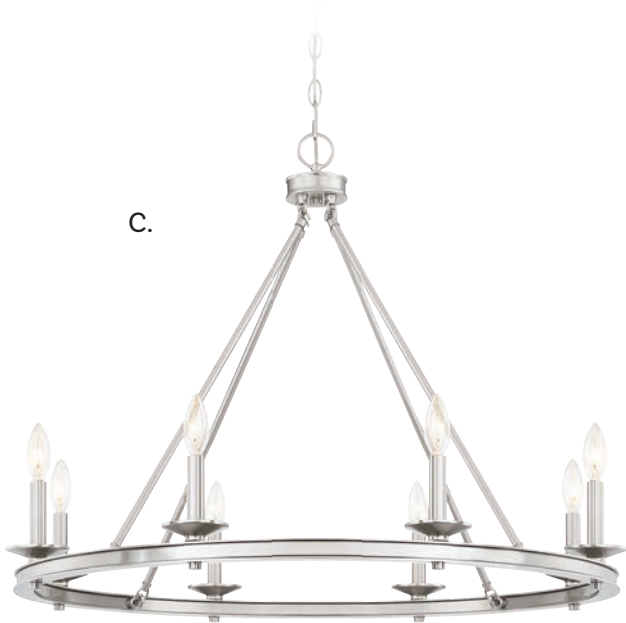

C.

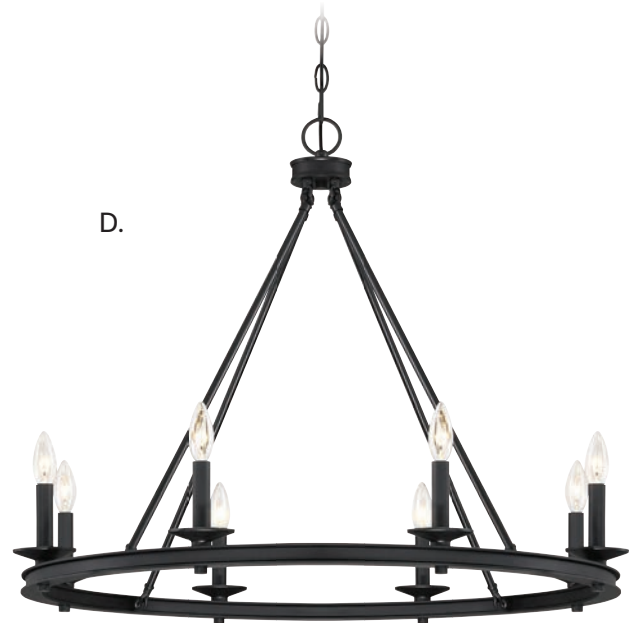

D.

A. 1-308-8-89
8-Light Chandelier
Matte Black Finish
33"W x 25"H
8C 60W

B. 1-308-8-322
8-Light Chandelier
Warm Brass Finish
33"W x 25"H
8C 60W

C. 1-308-8-SN
8-Light Chandelier
Satin Nickel Finish
33"W x 25"H
8C 60W

D. 1-308-8-44
8-Light Chandelier
Classic Bronze Finish
33"W x 25"H
8C 60W

MIDDLETON

ESSENTIALS



Includes 120" chain & 144" wire

MIDDLETON

ESSENTIALS



Includes 120" chain & 144" wire

MIDDLETON

- A. 1-310-10-322**
10-Light Chandelier
Warm Brass Finish
45"W x 32-1/4"H
10C 60W

- B. 1-310-10-89**
10-Light Chandelier
Matte Black Finish
45"W x 32-1/4"H
10C 60W

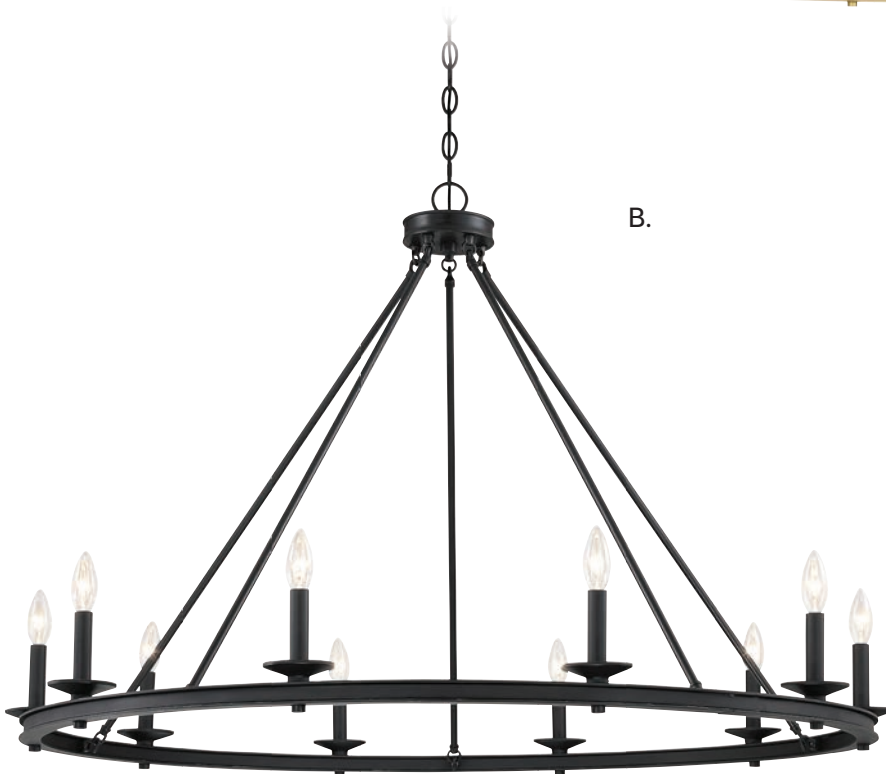
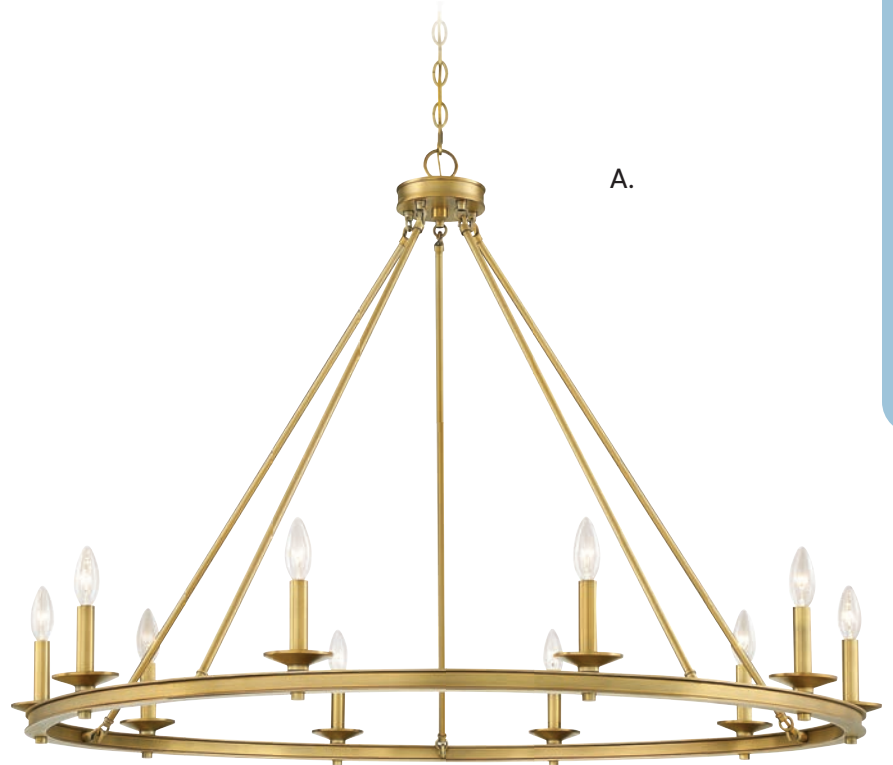

MIDDLETON

ESSENTIALS



Includes 120" chain & 144" wire

MIDDLETON

A.



B.

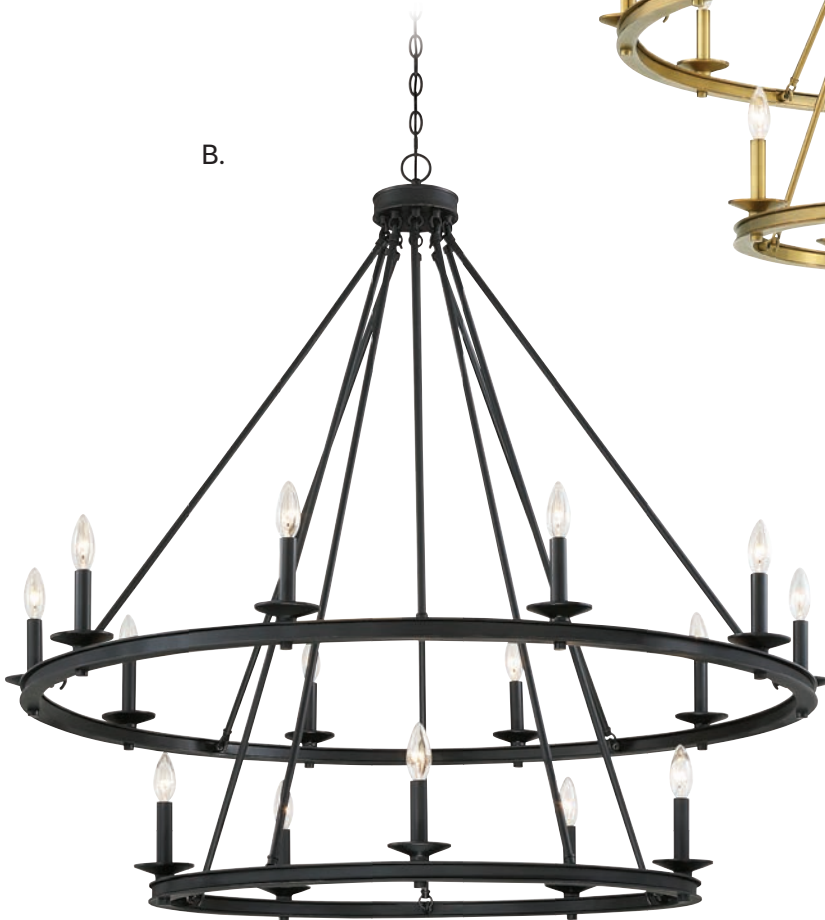

A. 1-312-15-322
15-Light Chandelier
Warm Brass Finish
45"W x 42"H
15C 60W

B. 1-312-15-89
15-Light Chandelier
Matte Black Finish
45"W x 42"H
15C 60W

TOWNSEND

ESSENTIALS



A. 3-420-3-44

3-Light Lantern
Classic Bronze Finish
10"W x 15"H
3C 60W

B. 3-420-3-SN

3-Light Lantern
Satin Nickel Finish
10"W x 15"H
3C 60W

C. 3-420-3-322

3-Light Lantern
Warm Brass Finish
10"W x 15"H
3C 60W

D. 3-420-3-109

3-Light Lantern
Polished Nickel Finish
10"W x 15"H
3C 60W

E. 3-420-3-89

3-Light Lantern
Matte Black Finish
10"W x 15"H
3C 60W

TOWNSEND

A.



B.

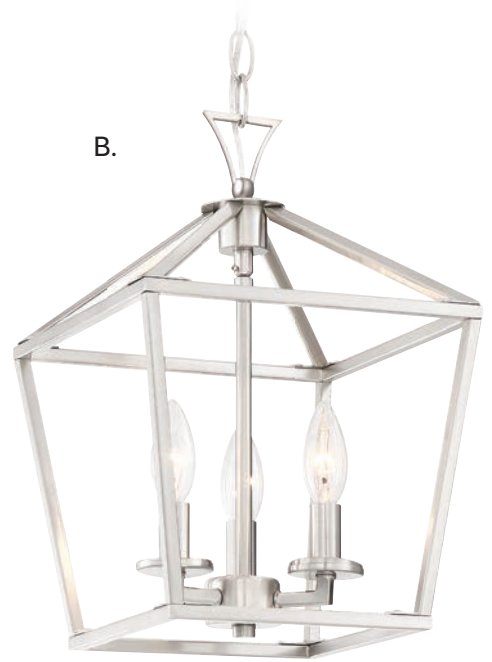

C.



D.



E.



Includes 120" chain & 144" wire

TOWNSEND

ESSENTIALS

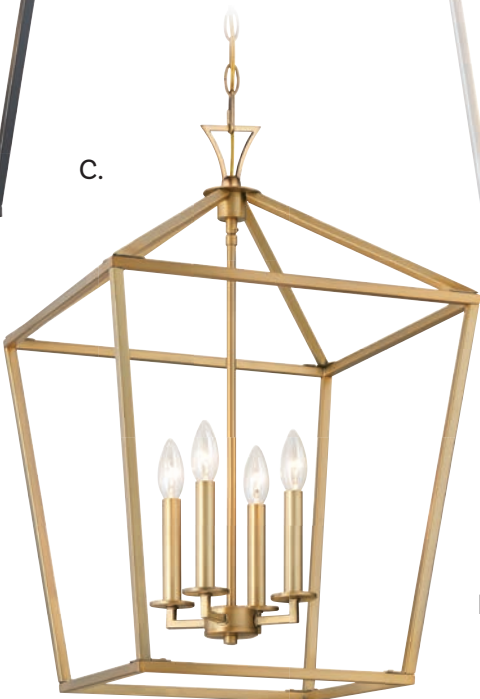
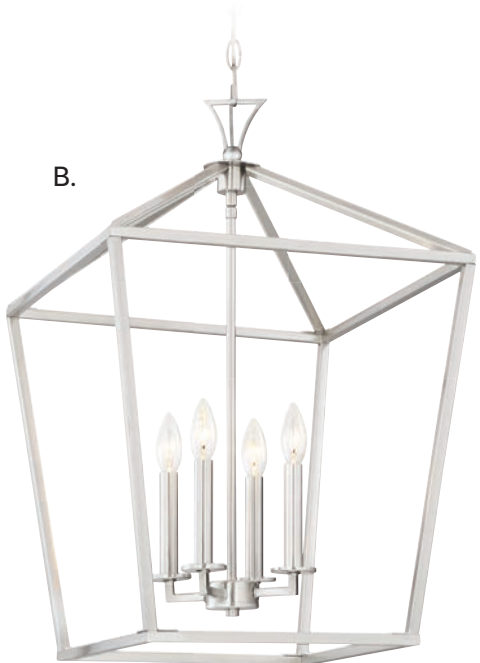
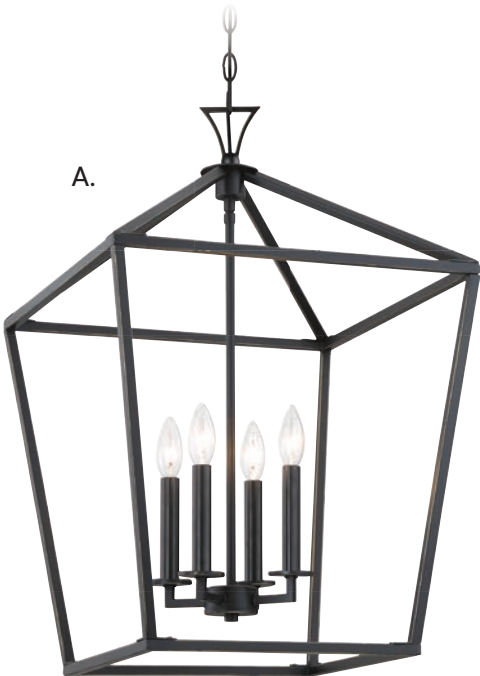

Includes 120" chain & 144" wire

TOWNSEND



A. 3-421-4-44
4-Light Lantern
Classic Bronze Finish
17"W x 26"H
4C 60W

B. 3-421-4-SN
4-Light Lantern
Satin Nickel Finish
17"W x 26"H
4C 60W

C. 3-421-4-322
4-Light Lantern
Warm Brass Finish
17"W x 26"H
4C 60W

D. 3-421-4-109
4-Light Lantern
Polished Nickel Finish
17"W x 26"H
4C 60W

E. 3-421-4-89
4-Light Lantern
Matte Black Finish
17"W x 26"H
4C 60W

TOWNSEND

ESSENTIALS



Includes 120" chain & 144" wire

TOWNSEND

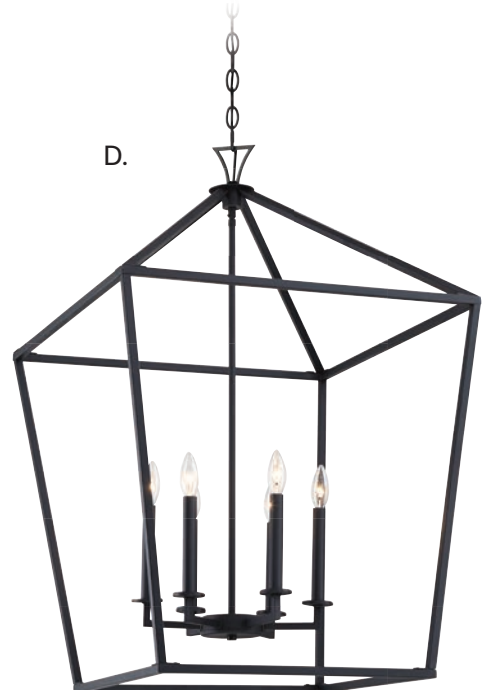
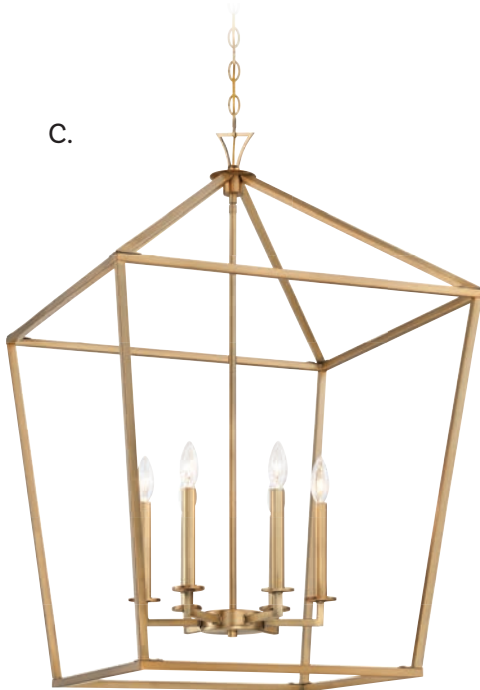
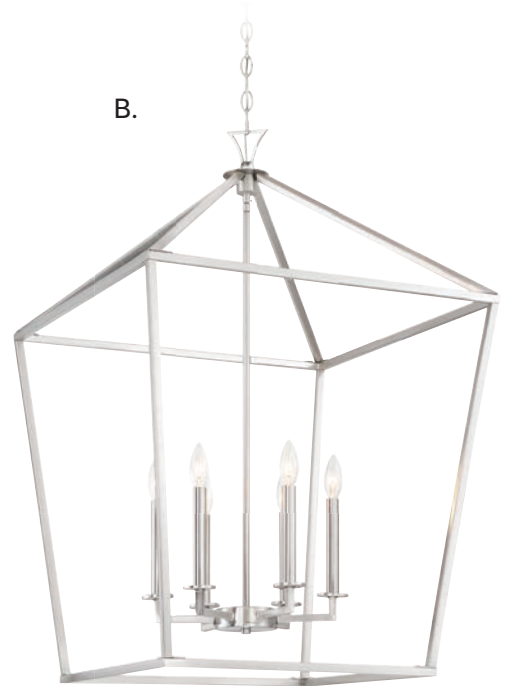

A. 3-422-6-44
6-Light Lantern
Classic Bronze Finish
24"W x 36-1/2"H
6C 60W

B. 3-422-6-SN
6-Light Lantern
Satin Nickel Finish
24"W x 36-1/2"H
6C 60W

C. 3-422-6-322
6-Light Lantern
Warm Brass Finish
24"W x 36-1/2"H
6C 60W

D. 3-422-6-89
6-Light Lantern
Matte Black Finish
24"W x 36-1/2"H
6C 60W

TOWNSEND

ESSENTIALS

A.



B.



C.



D.



E.



TOWNSEND



A. 6-328-4-44

4-Light Semi-Flush
Classic Bronze Finish
13"W x 13"H
4C 60W

B. 6-328-4-SN

4-Light Semi-Flush
Satin Nickel Finish
13"W x 13"H
4C 60W

C. 6-328-4-322

4-Light Semi-Flush
Warm Brass Finish
13"W x 13"H
4C 60W

D. 6-328-4-109

4-Light Semi-Flush
Polished Nickel Finish
13"W x 13"H
4C 60W

E. 6-328-4-89

4-Light Semi-Flush
Matte Black Finish
13"W x 13"H
4C 60W

TOWNSEND

ESSENTIALS



Includes 120" chain & 144" wire

A.

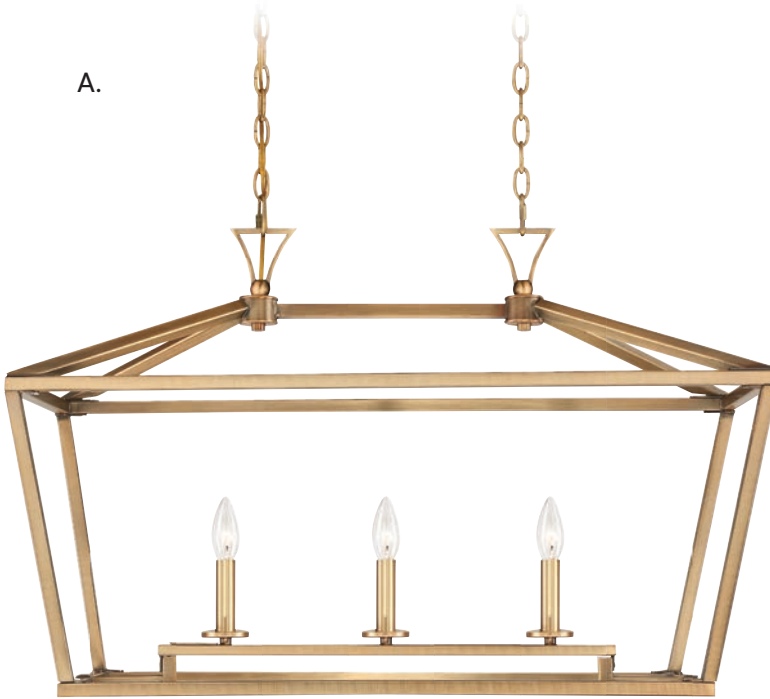

B.

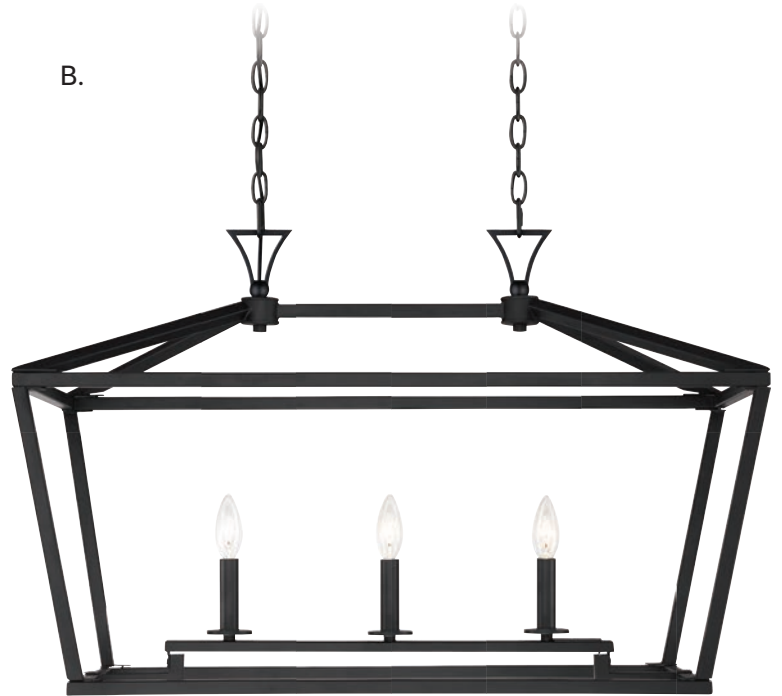

A. 1-423-3-322
3-Light Linear
Chandelier
Warm Brass Finish
32"L x 16"W x 21"H
3C 60W

B. 1-423-3-89
3-Light Linear
Chandelier
Matte Black Finish
32"L x 16"W x 21"H
3C 60W

TOWNSEND

ESSENTIALS

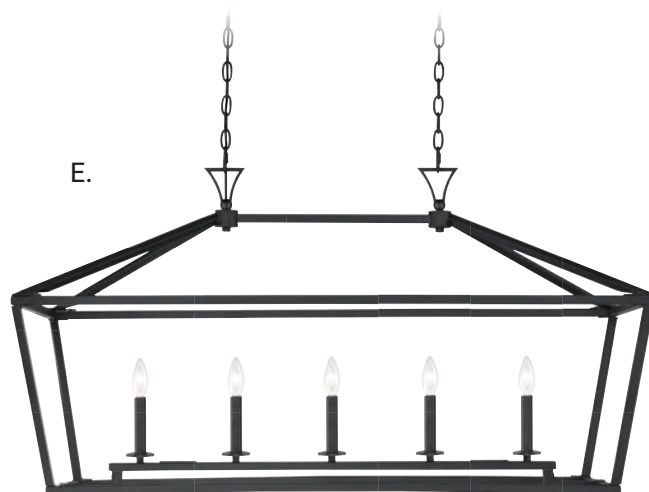
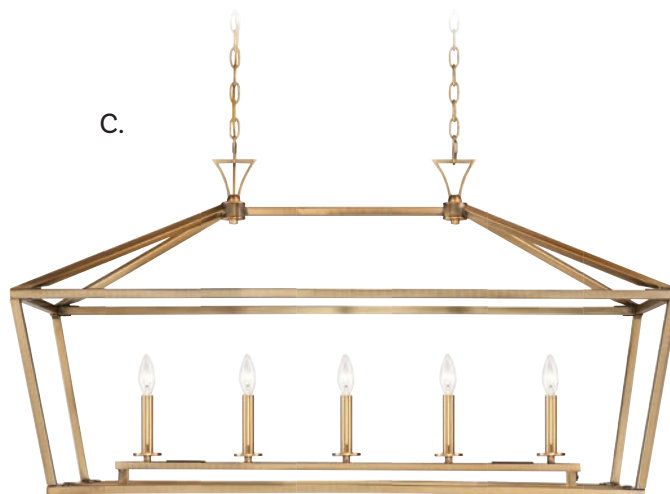
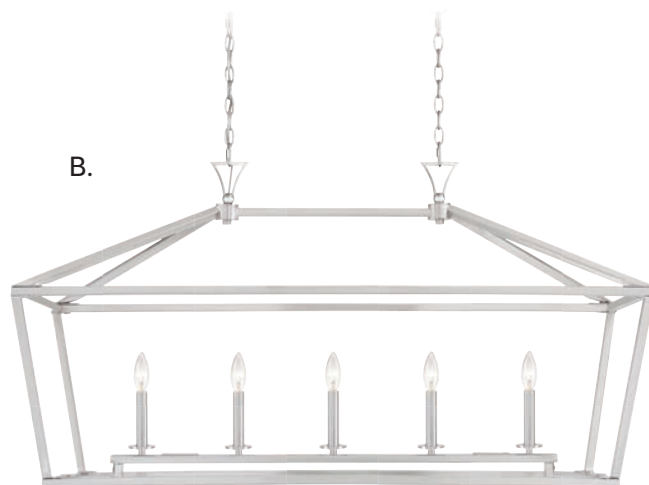
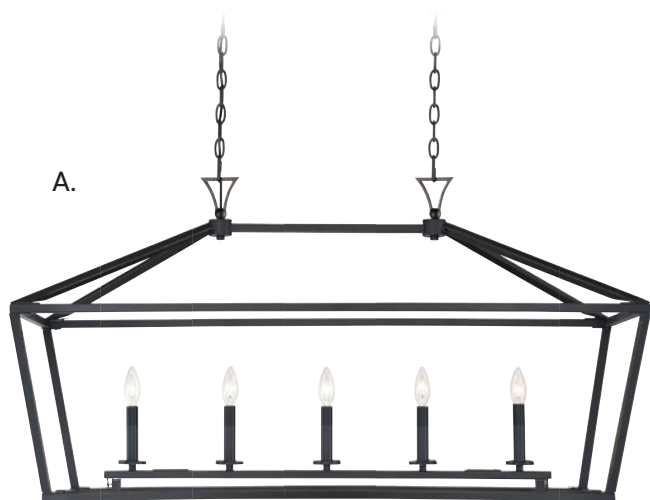

Includes 120" chain & 144" wire

TOWNSEND



A. 1-424-5-44
5-Light Linear
Chandelier
Classic Bronze Finish
44"L x 16"W x 23-1/2"H
5C 60W

B. 1-424-5-SN
5-Light Linear
Chandelier
Satin Nickel Finish
44"L x 16"W x 23-1/2"H
5C 60W

C. 1-424-5-322
5-Light Linear
Chandelier
Warm Brass Finish
44"L x 16"W x 23-1/2"H
5C 60W

D. 1-424-5-109
5-Light Linear
Chandelier
Polished Nickel Finish
44"L x 16"W x 23-1/2"H
5C 60W

E. 1-424-5-89
5-Light Linear
Chandelier
Matte Black Finish
44"L x 16"W x 23-1/2"H
5C 60W

PALLADIAN

ESSENTIALS

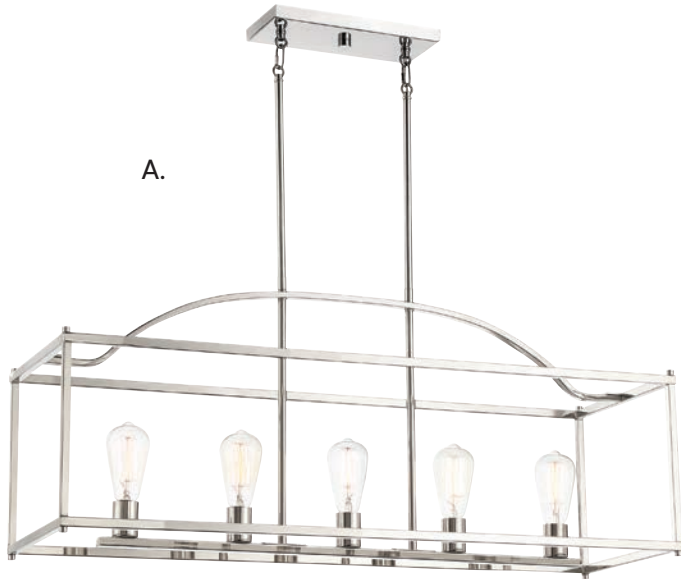

Dual Mount Hanging System

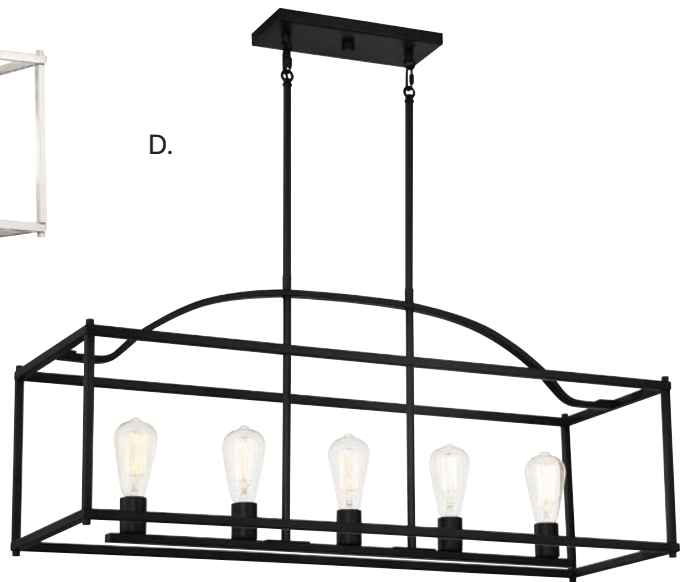
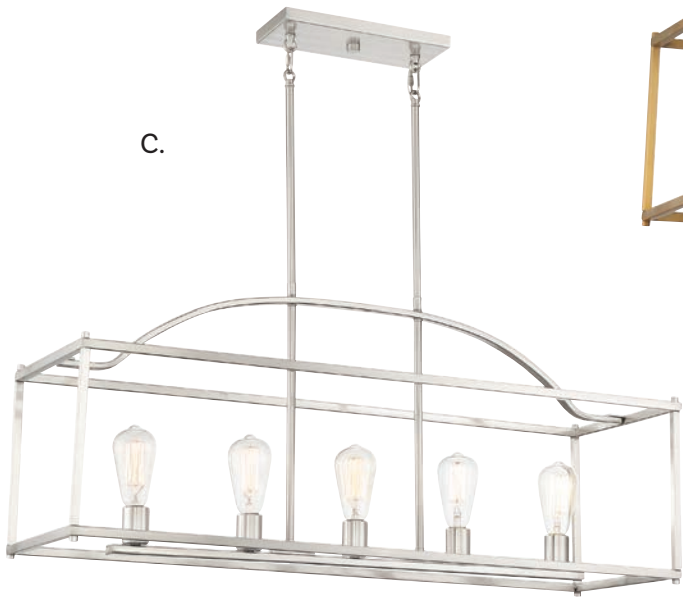
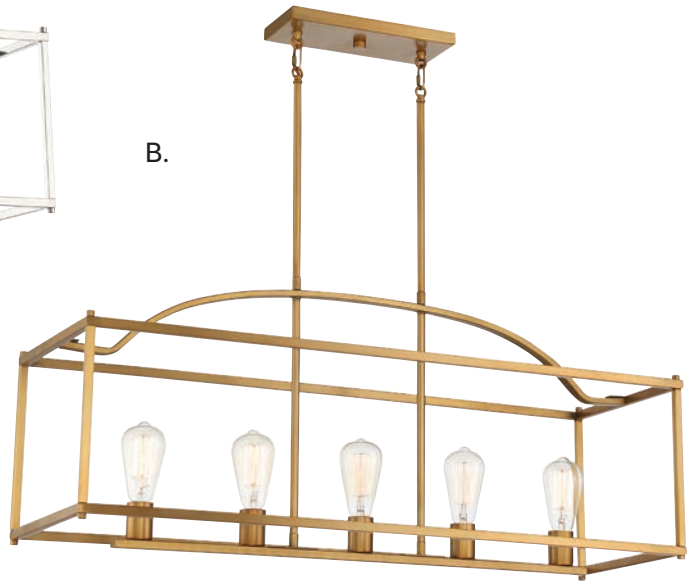

Includes 12" & 6" extensions - additional stems available - 7-EXT

PALLADIAN



A. 1-190-5-109

5-Light Linear Chandelier
Polished Nickel Finish
38"L x 12"W x 16"H
Adj H 16" - 70"
5E 60W

B. 1-190-5-322

5-Light Linear Chandelier
Warm Brass Finish
38"L x 12"W x 16"H
Adj H 16" - 70"
5E 60W

C. 1-190-5-SN

5-Light Linear Chandelier
Satin Nickel Finish
38"L x 12"W x 16"H
Adj H 16" - 70"
5E 60W

D. 1-190-5-89

5-Light Linear Chandelier
Matte Black Finish
38"L x 12"W x 16"H
Adj H 16" - 70"
5E 60W

A. 1-326-3-322

3-Light Linear Chandelier
Warm Brass Finish
32"L x 12"W x 10-1/2"H
Adj H 10-1/2" - 65-1/2"
3E 60W
30° Swivel

B. 1-326-3-44

3-Light Linear Chandelier
Classic Bronze Finish
32"L x 12"W x 10-1/2"H
Adj H 10-1/2" - 65-1/2"
3E 60W
30° Swivel

C. 1-327-5-322

5-Light Linear Chandelier
Warm Brass Finish
44"L x 12"W x 10-1/2"H
Adj H 10-1/2" - 65-1/2"
5E 60W
30° Swivel

D. 1-327-5-44

5-Light Linear Chandelier
Classic Bronze Finish
44"L x 12"W x 10-1/2"H
Adj H 10-1/2" - 65-1/2"
5E 60W
30° Swivel





Includes 12" & 6" extensions - additional stems available - **7-EXT**

WINFIELD

ESSENTIALS



*Includes (3) 9-1/2" extensions - additional stems available - 7-EXT

**Includes 12" & 6" extensions - additional stems available - 7-EXT

WINFIELD



A. 9-9771-2-89
2-Light Sconce
Matte Black Finish
4-1/2"W x 15-1/2"H x 5-1/2"E
2C 60W
Clear Glass

B. 7-9770-1-89
1-Light Mini-Pendant
Matte Black Finish
5-1/8"W x 15-3/4"H
Adj H 15-3/4" - 47-1/4"
1E 60W
90° Swivel
Clear Glass

C. 1-9772-10-89
10-Light Chandelier
Matte Black Finish
25"W x 18-1/2"H
Adj H 18-1/2" - 75-1/2"
10C 60W
30° Swivel
Clear Glass

D. 1-9773-12-89
12-Light Linear Chandelier
Matte Black Finish
38"L x 14"W x 17-1/4"H
Adj H 17-1/4" - 74-1/4"
12C 60W
30° Swivel
Clear Glass

WINFIELD

ESSENTIALS



A. 9-9771-2-322
2-Light Sconce
Warm Brass Finish
4-1/2"W x 15-1/2"H x 5-1/2"E
2C 60W
Clear Glass

B. 7-9770-1-322
1-Light Mini-Pendant
Warm Brass Finish
5-1/8"W x 15-3/4"H
Adj H 15-3/4" - 47-1/4"
1E 60W
90° Swivel
Clear Glass

C. 1-9772-10-322
10-Light Chandelier
Warm Brass Finish
25"W x 18-1/2"H
Adj H 18-1/2" - 75-1/2"
10C 60W
30° Swivel
Clear Glass

D. 1-9773-12-322
12-Light Linear Chandelier
Warm Brass Finish
38"L x 14"W x 17-1/4"H
Adj H 17-1/4" - 74-1/4"
12C 60W
30° Swivel
Clear Glass

WINFIELD



*Includes (3) 9-1/2" extensions - additional stems available - 7-EXT

**Includes 12" & 6" extensions - additional stems available - 7-EXT

CARLTON

ESSENTIALS



A. 1-3392-4-89

4-Light Chandelier
Matte Black Finish
24"W x 25"H
4C 60W
Clear Ribbed Glass

B. 1-3394-8-89

8-Light Chandelier
Matte Black Finish
36"W x 32-1/2"H
8C 60W
Clear Ribbed Glass

C. 1-3394-8-322

8-Light Chandelier
Warm Brass Finish
36"W x 32-1/2"H
8C 60W
Clear Ribbed Glass

D. 1-3392-4-322

4-Light Chandelier
Warm Brass Finish
24"W x 25"H
4C 60W
Clear Ribbed Glass



Pendant, Page 475

CARLTON

A.



B.



C.



D.

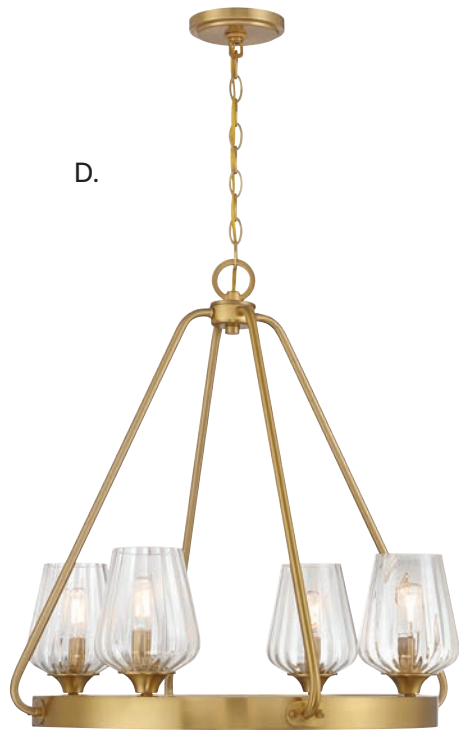

Includes 120" chain & 144" wire

CALHOUN

ESSENTIALS



*Includes 120" chain & 144" wire

Includes 12" & 6" extensions - additional stems available - **7-EXT

CALHOUN



Dual Mount Hanging System



- A. 1-1021-5-89**
5-Light Chandelier
Matte Black Finish
25"W x 23"H
5E 60W
Clear Glass

- B. 7-1025-3-89**
3-Light Pendant
Matte Black Finish
15"W x 18"H
3E 60W
Clear Glass

- C. 1-1023-5-89**
5-Light Linear Chandelier
Matte Black Finish
40"L x 5"W x 10"H
Adj H 10" - 62"
5E 60W
Clear Glass



Mini-Pendant, Page 471



Pendant, Page 471



Bath, Page 611



Ceiling, Page 676

CALHOUN

ESSENTIALS

*A.



*B.



Dual Mount Hanging System

**C.



A. 7-1025-3-SN

3-Light Pendant
Satin Nickel Finish
15"W x 18"H
3E 60W
Clear Glass

B. 1-1021-5-SN

5-Light Chandelier
Satin Nickel Finish
25"W x 22"H
5E 60W
Clear Glass

C. 1-1023-5-SN

5-Light Linear Chandelier
Satin Nickel Finish
40"L x 5"W x 10"H
Adj H 10" - 62"
5E 60W
Clear Glass

*Includes 120" chain & 144" wire.



Mini-Pendant, Page 471



Pendant, Page 471



Bath, Page 611



Ceiling, Page 676

CALHOUN



Dual Mount Hanging System



*D.



*E.

- D. 1-1021-5-322**
5-Light Chandelier
Warm Brass Finish
25"W x 22"H
5E 60W
Clear Glass

- E. 7-1025-3-322**
3-Light Pendant
Warm Brass Finish
15"W x 18"H
3E 60W
Clear Glass

- F. 1-1023-5-322**
5-Light Linear Chandelier
Warm Brass Finish
40"L x 5"W x 10"H
Adj H 10" - 62"
5E 60W
Clear Glass



**F.

**Includes 12" & 6" extensions - additional stems available - 7-EXT



Mini-Pendant, Page 471



Pendant, Page 471



Bath, Page 611



Ceiling, Page 676

OCTAVE

ESSENTIALS



Pendant, Page 467



Ceiling, Page 678



Ceiling, Page 679



Bath, Page 627-629



Sconce, Page 563

OCTAVE



A. 1-4032-5-322
5-Light Chandelier
Warm Brass Finish
23"W x 18-1/2"H
5E 60W
Clear Glass

B. 1-4032-5-BK
5-Light Chandelier
Matte Black Finish
23"W x 18-1/2"H
5E 60W
Clear Glass

C. 1-4032-5-SN
5-Light Chandelier
Satin Nickel Finish
23"W x 18-1/2"H
5E 60W
Clear Glass

D. 1-4032-5-13
5-Light Chandelier
English Bronze Finish
23"W x 18-1/2"H
5E 60W
Clear Glass

Includes 120" chain & 144" wire

OCTAVE

ESSENTIALS



Pendant, Page 467



Ceiling, Page 678



Ceiling, Page 679



Bath, Page 627-629



Sconce, Page 563

OCTAVE



A.



B.



C.

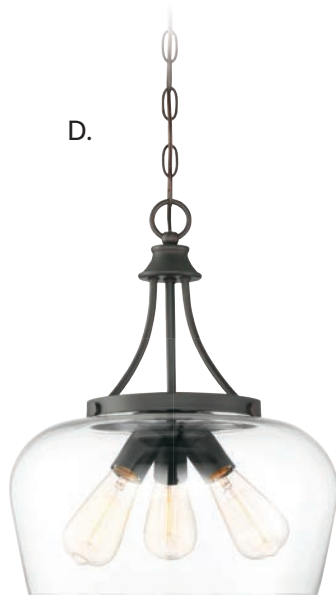

D.

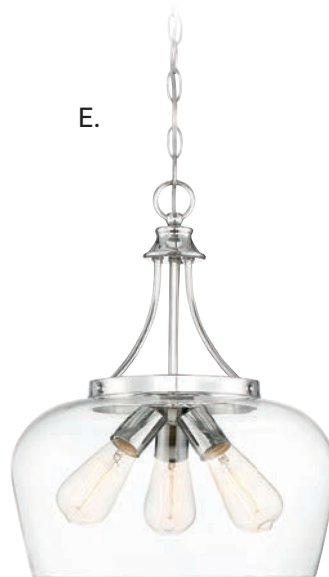

E.

A. 7-4034-3-BK
3-Light Pendant
Matte Black Finish
15"W x 18"H
3E 60W
Clear Glass

B. 7-4034-3-322
3-Light Pendant
Warm Brass Finish
15"W x 18"H
3E 60W
Clear Glass

C. 7-4034-3-SN
3-Light Pendant
Satin Nickel Finish
15"W x 18"H
3E 60W
Clear Glass

D. 7-4034-3-13
3-Light Pendant
English Bronze Finish
15"W x 18"H
3E 60W
Clear Glass

E. 7-4034-3-11
3-Light Pendant
Polished Chrome Finish
15"W x 18"H
3E 60W
Clear Glass

Includes 120" chain & 144" wire

CRISTOFER

ESSENTIALS



Includes 12" & 6" extensions - additional stems available - **7-EXT**



Dual Mount Hanging System



A.

- A. 1-1624-8-89**
8-Light Linear Chandelier
Matte Black Finish
36" L x 21" W x 8" H
Adj H 8" - 62"
8C 60W

- B. 1-1624-8-322**
8-Light Linear Chandelier
Warm Brass Finish
36" L x 21" W x 8" H
Adj H 8" - 62"
8C 60W

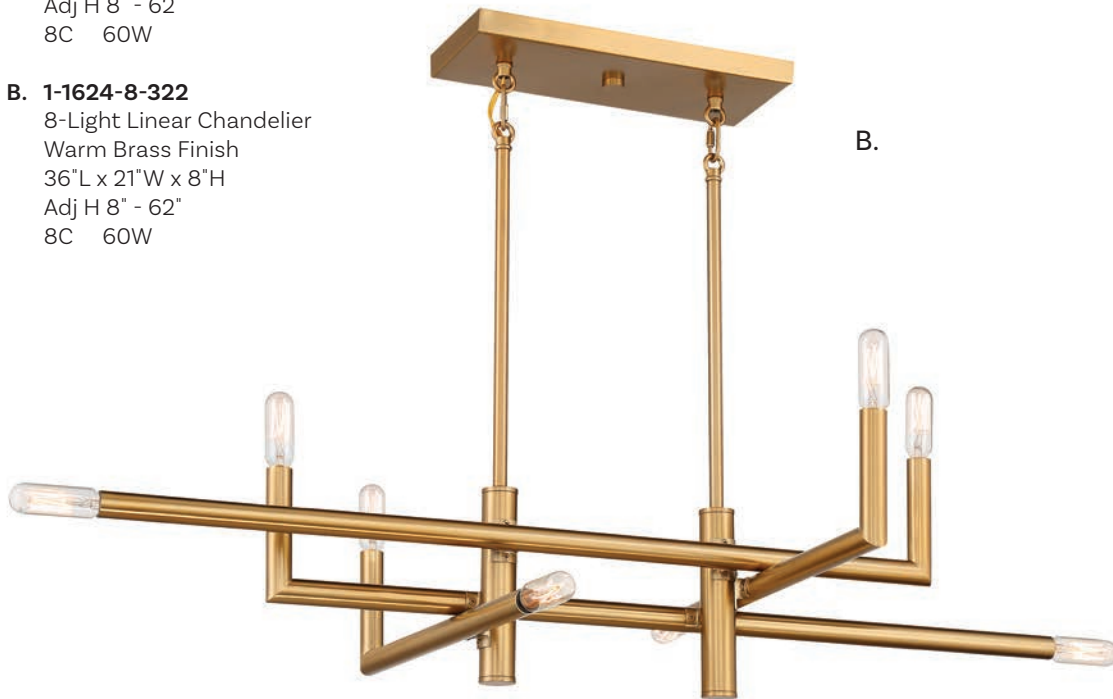

B.

CRISTOFER

ESSENTIALS



Includes 12" & 6" extensions - additional stems available - **7-EXT**

CRISTOFER



Dual Mount Hanging System

A.

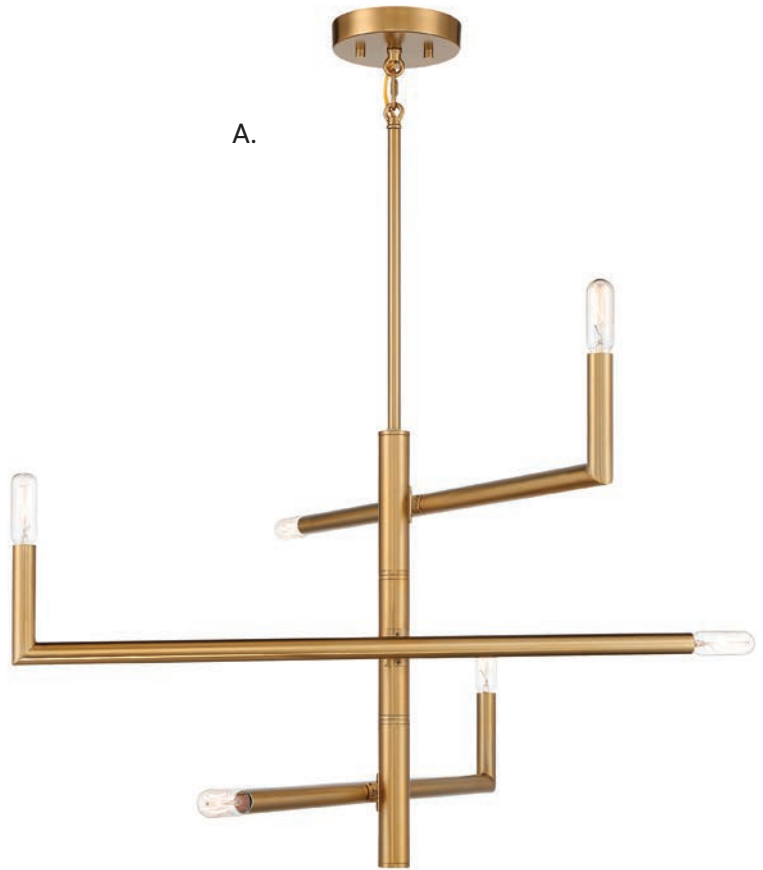

B.

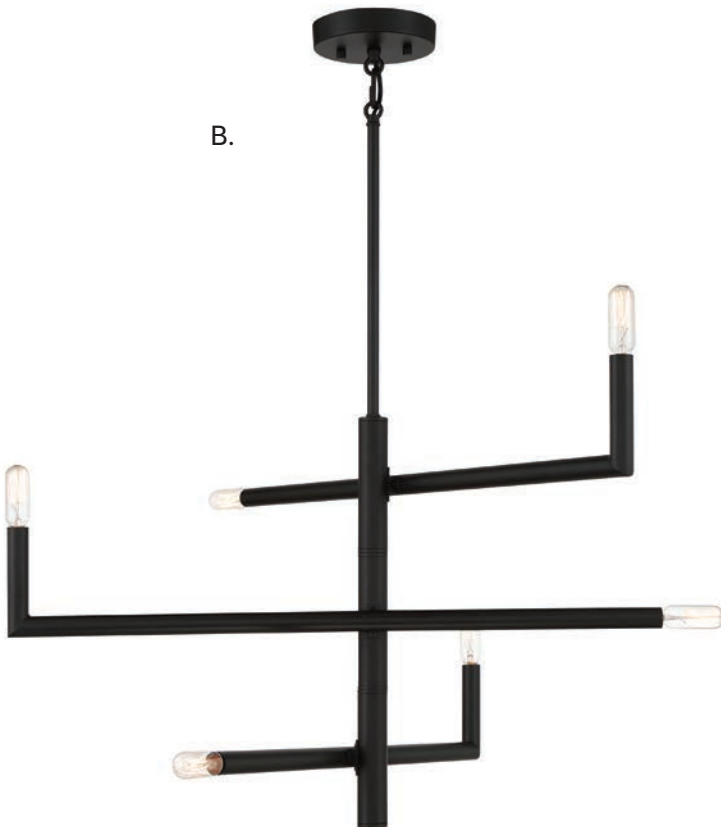

A. 1-1623-6-322
6-Light Chandelier
Warm Brass Finish
30"W x 17"H
Adj H 17" - 71"
6C 60W

B. 1-1623-6-89
6-Light Chandelier
Matte Black Finish
30"W x 17"H
Adj H 17" - 71"
6C 60W

FALLON

ESSENTIALS



*Includes 12" & 6" extensions - additional stems available - 7-EXT

FALLON

ESSENTIALS



*A.



B.



*C.



D.



Dual Mount Hanging System

A. 1-1613-4-89
4-Light Chandelier
Matte Black Finish
30"W x 11"H
Adj H 11" - 65"
4G9 60W
White Opal Glass

B. 9-1615-1-89
1-Light Sconce
Matte Black Finish
10"W x 15"H x 5-1/2"E
1G9 60W
White Opal Glass

C. 1-1613-4-322
4-Light Chandelier
Warm Brass Finish
30"W x 11"H
Adj H 11" - 65"
4G9 60W
White Opal Glass

D. 9-1615-1-322
1-Light Sconce
Warm Brass Finish
10"W x 15"H x 5-1/2"E
1G9 60W
White Opal Glass

FALLON

ESSENTIALS



Includes 12" & 6" extensions - additional stems available - **7-EXT**

A.



B.



A. 1-1614-3-322

3-Light Linear Chandelier
Warm Brass Finish
45"L x 10"W x 4-1/2"H
Adj H 4-1/2" - 58-1/2"
3G9 60W
White Opal Glass

B. 1-1614-3-89

3-Light Linear Chandelier
Matte Black Finish
45"L x 10"W x 4-1/2"H
Adj H 4-1/2" - 58-1/2"
3G9 60W
White Opal Glass

NEWPORT

ESSENTIALS



Dual Mount Hanging System

A. 7-2521-4-322
 4-Light Pendant
 Warm Brass Finish
 18"W x 26"H
 Adj H 26" - 80"
 4C 60W
 Soft White
 Fabric Shade

B. 1-2520-6-322
 6-Light Oval Chandelier
 Warm Brass Finish
 42"L x 16"W x 23"H
 Adj H 23" - 77"
 6C 60W
 Soft White
 Fabric Shade

C. 1-2520-6-89
 6-Light Oval Chandelier
 Matte Black Finish
 42"L x 16"W x 23"H
 Adj H 23" - 77"
 6C 60W
 Soft White
 Fabric Shade

D. 7-2521-4-89
 4-Light Pendant
 Matte Black Finish
 18"W x 26"H
 Adj H 26" - 80"
 4C 60W
 Soft White
 Fabric Shade

NEWPORT

ESSENTIALS

A.



B.

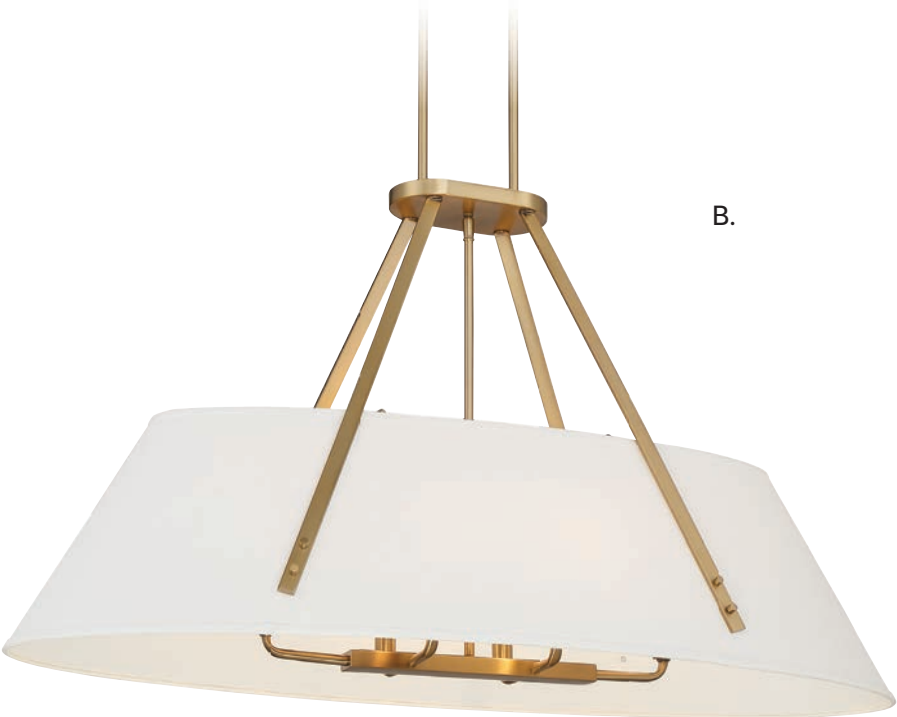

C.



D.



Includes 12" & 6" extensions - additional stems available - 7-EXT

HAYNES

ESSENTIALS



*Includes 12" & 6" extensions - additional stems available - 7-EXT



Dual Mount Hanging System

A. 1-2803-5-89
 5-Light Linear Chandelier
 Matte Black Finish
 48"L x 4"W x 16"H
 Adj H 16" - 70"
 5C 60W
 White Opal Glass

B. 1-2802-6-89
 6-Light Chandelier
 Matte Black Finish
 30"W x 16"H
 Adj H 16" - 70"
 6C 60W
 White Opal Glass

C. 9-2801-1-89
 1-Light Sconce
 Matte Black Finish
 5"W x 16"H x 7"E
 1C 60W
 White Opal Glass

HAYNES

ESSENTIALS



Dual Mount Hanging System

A. 1-2803-5-322

5-Light Linear Chandelier
Warm Brass Finish
48"L x 4"W x 16"H
Adj H 16" - 70"
5C 60W
White Opal Glass

B. 1-2802-6-322

6-Light Chandelier
Warm Brass Finish
30"W x 16"H
Adj H 16" - 70"
6C 60W
White Opal Glass

C. 9-2801-1-322

1-Light Sconce
Warm Brass Finish
5"W x 16"H x 7"E
1C 60W
White Opal Glass



*A.



*B.



C.

*Includes 12" & 6" extensions - additional stems available - 7-EXT

MIDLAND

TODAY'S CLASSIC STYLE



Dual Mount Hanging System

A. 9-1905-2-143
2-Light Sconce
Matte Black w/
Warm Brass
10-1/2"W x 20"H x 5"E
2C 60W
Clear Ribbed Glass

B. 1-1906-6-143
6-Light Chandelier
Matte Black w/
Warm Brass
28"W x 21"H
Adj H 21" - 75"
6C 60W
Clear Ribbed Glass

C. 1-1907-8-143
8-Light Linear Chandelier
Matte Black w/
Warm Brass
40"L x 16"W x 14"H
Adj H 14" - 70"
8C 60W
Clear Ribbed Glass

MIDLAND

TODAY'S CLASSIC STYLE



*Includes 12" & 6" extensions - additional stems available - 7-EXT

EATON

TODAY'S CLASSIC STYLE



Ceiling, Page 670



Bath, Page 571



Sconce, Page 571, 558



Dual Mount Hanging System

A. 7-1983-1-143

1-Light Pendant
 Matte Black w/ Warm Brass
 17"W x 9"H
 Adj H 9" - 63"
 1E 60W
 Clear Outer Glass
 White Opal Chimney



B. 1-1982-4-143

4-Light Linear Chandelier
 Matte Black w/ Warm Brass
 48"L x 7"W x 7-1/2"H
 Adj H 7-1/2" - 61-1/2"
 4E 60W
 Clear Outer Glass
 White Opal Chimney



Includes 12" & 6" extensions - additional stems available - **7-EXT**

ARIES

TODAY'S CLASSIC STYLE



Includes 120" of cable

ARIES

TODAY'S CLASSIC STYLE

A.



B.

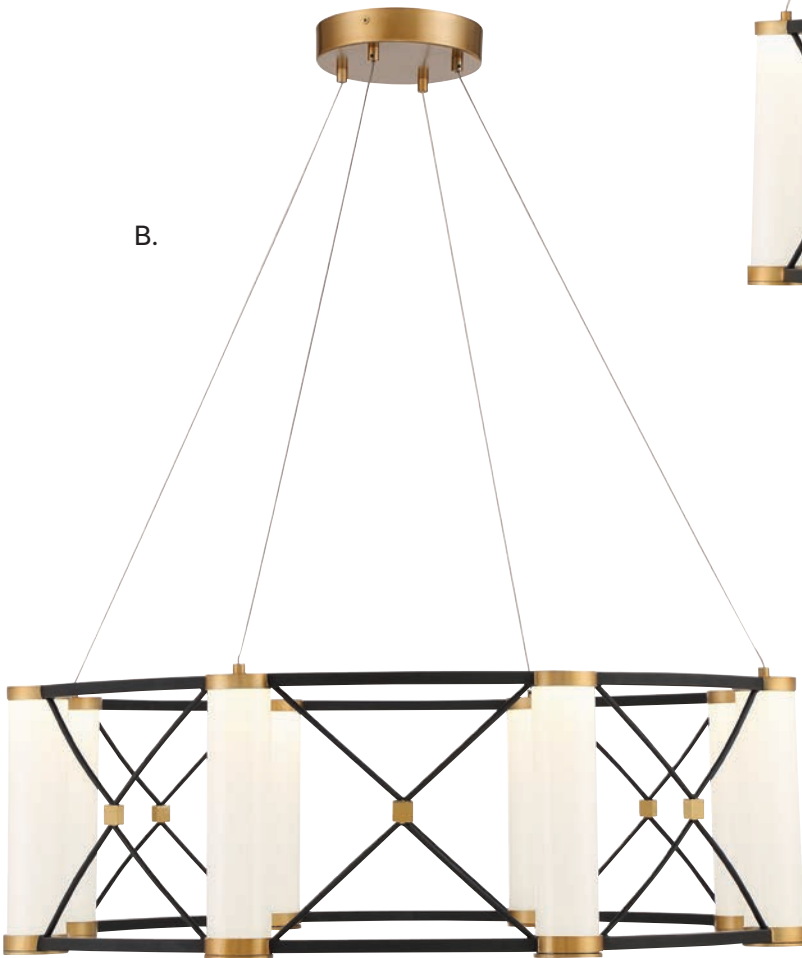

A. 7-1639-6-144

6-Light Pendant

Matte Black w/ Burnished Brass

26"W x 10"H

7W Integrated Dimmable LED

1600 Lumens, 3000K, 90+ CRI

White Opal Glass

B. 7-1640-8-144

8-Light Pendant

Matte Black w/ Burnished Brass

34"W x 10"H

7W Integrated Dimmable LED

2150 Lumens, 3000K, 90+ CRI

White Opal Glass



ASHOR

TODAY'S CLASSIC STYLE



Dual Mount Hanging System



A. 1-1636-8-143

8-Light Linear Chandelier
Matte Black w/ Warm Brass
60"L x 18"W x 23"H
Adj H 23" - 77"
11W Dimmable LED
800 Lumens, 3000K,
90+ CRI
Crushed Crystal Diffuser

B. 1-1635-5-143

5-Light Chandelier
Matte Black w/ Warm Brass
34"W x 16"H
Adj H 16" - 70"
11W Dimmable LED
800 Lumens, 3000K,
90+ CRI
Crushed Crystal Diffuser

C. 1-1637-8-143

8-Light Chandelier
Matte Black w/ Warm Brass
42"W x 15"H
Adj H 15" - 69"
7W Dimmable LED
800 Lumens, 3000K,
90+ CRI
Crushed Crystal Diffuser

ASHOR

TODAY'S CLASSIC STYLE



LED

*Includes 12" & 6" extensions - additional stems available - 7-EXT

**Includes 12" & 6" extensions - additional stems available - 7-EXTLG

HAYWARD

TODAY'S CLASSIC STYLE



A.



*B.



*C.



D.

*Includes 12" & 6" extensions - additional stems available - 7-EXTLG



A. 6-1695-4-143
 4-Light Semi-Flush
 Matte Black w/
 Warm Brass
 24"W x 8"H
 4E 60W
 Strie Piastra Glass

B. 7-1699-3-143
 3-Light Pendant
 Matte Black w/
 Warm Brass
 16"W x 20"H
 Adj H 20" - 74"
 3E 60W
 Strie Piastra Glass

C. 7-1696-5-143
 5-Light Pendant
 Matte Black w/
 Warm Brass
 28"W x 17"H
 Adj H 17" x 71"
 5E 60W
 Strie Piastra Glass

D. 9-1697-1-143
 1-Light Sconce
 Matte Black w/
 Warm Brass
 6"W x 12"H x 4-1/2"E
 1E 60W
 Strie Piastra Glass

FAN D'LIER® HAYWARD

TODAY'S CLASSIC STYLE



FAN NUMBER	24-FD-1698-143
MOTOR FINISH	Matte Black
BLADE FINISH	Black
SHADE FINISH	Strie Piastra Glass

ENERGY USE AT HIGH SPEED

Airflow Use 1,079 Cu Ft/Min	Electricity Use 28W Excludes Lights	Airflow Efficiency 38.54 Cu Ft/Min/W
--	--	---

Compare: 36" to 48" ceiling fans have airflow efficiencies ranging from approximately 71 to 86 cu. ft. per min. per watt at high speed.

- Motor Size 104mm x 114mm
- 12" Blade Span
- 31"W x 5-3/8"H (Cage Only)
- 16° Blade Pitch
- 4" & 18" Downrods Included
- Additional Downrod Lengths Sold Separately
- ABS Blades & Integrated Fan Light Included
- 4E 8W Dimmable LED (870 Lumens per bulb, 3000K, 90+ CRI)
- Not Hugger Kit Adaptable
- Handheld Remote with E Receiver Included (RMT-AC-UNIVERSAL)
- Lamp Included



Handheld Remote Control Included
RMT-AC-UNIVERSAL

LED



FAN D'LIER®
HAYWARD

TODAY'S CLASSIC STYLE



LONGFELLOW

TODAY'S CLASSIC STYLE

*A.



Dual Mount Hanging System

B.



*C.

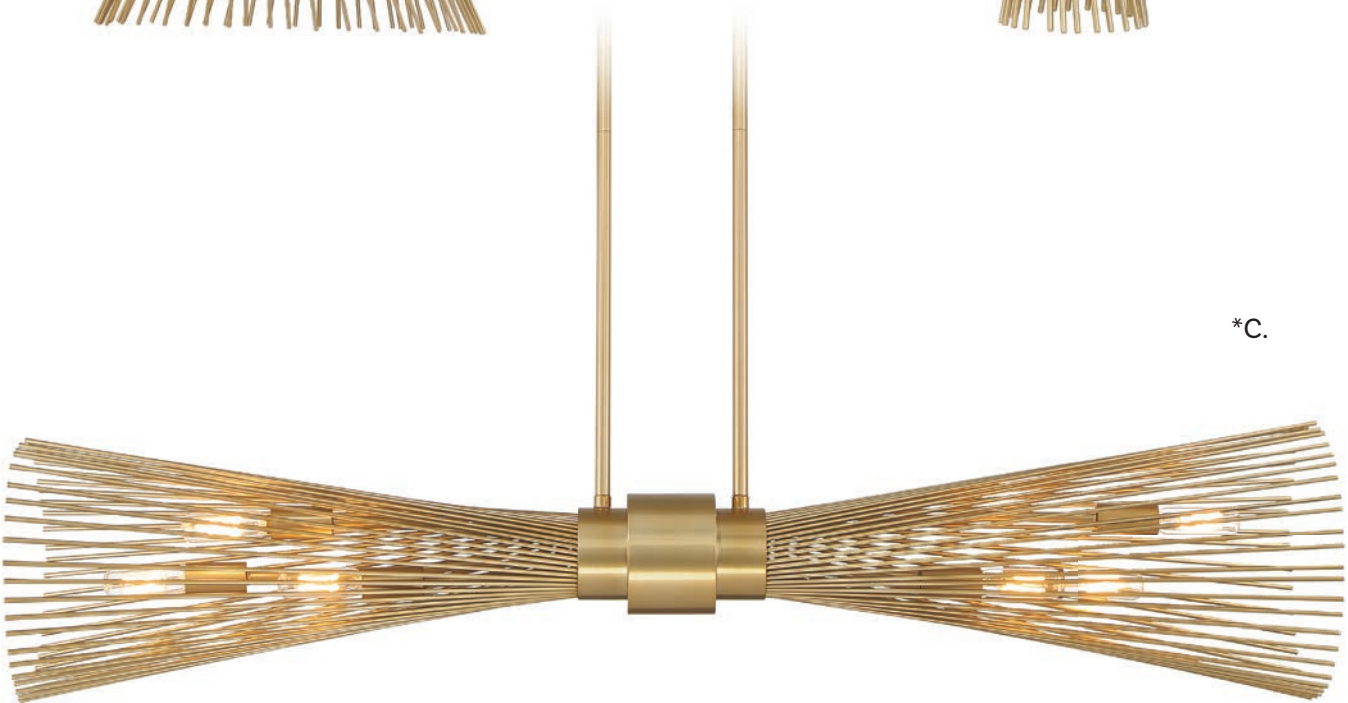

*Includes 12" & 6" extensions - additional stems available - 7-EXT

LONGFELLOW

TODAY'S CLASSIC STYLE



A. 7-9602-1-171

1-Light Pendant
Burnished Brass Finish
16"W x 24"H
Adj H 24" - 78"
1E 60W

B. 9-9603-2-171

2-Light Sconce
Burnished Brass Finish
5-1/4"W x 20"H x 6"E
2C 60W

C. 1-9601-6-171

6-Light Linear Chandelier
Burnished Brass Finish
42"L x 9"W x 9"H
Adj H 9" - 63"
6C 60W

LONGFELLOW

TODAY'S CLASSIC STYLE



A. 9-9603-2-89
2-Light Sconce
Matte Black Finish
5-1/5"W x 20"H x 6"E
2C 60W

B. 7-9602-1-89
1-Light Pendant
Matte Black Finish
16"W x 24"H
Adj H 24" - 78"
1E 60W

C. 1-9601-6-89
6-Light Linear Chandelier
Matte Black Finish
42"L x 9"W x 9"H
Adj H 9" - 63"
6C 60W

LONGFELLOW

TODAY'S CLASSIC STYLE

A.



Dual Mount Hanging System

*B.



*C.



*Includes 12" & 6" extensions - additional stems available - 7-EXT

CALGARY

TODAY'S CLASSIC STYLE



Includes 12" & 6" extensions - additional stems available - 7-EXTLG

CALGARY

TODAY'S CLASSIC STYLE



A. 1-4571-6-89
6-Light Oval Chandelier
Matte Black Finish
48"L x 25"W x 24"H
Adj H 24" - 78"
6C 60W
Clear Hammered Glass

B. 1-4570-8-89
8-Light Chandelier
Matte Black Finish
48"W x 26-1/2"H
Adj H 26-1/2" - 80-1/2"
8C 60W
Clear Hammered Glass

B.



Dual Mount Hanging System

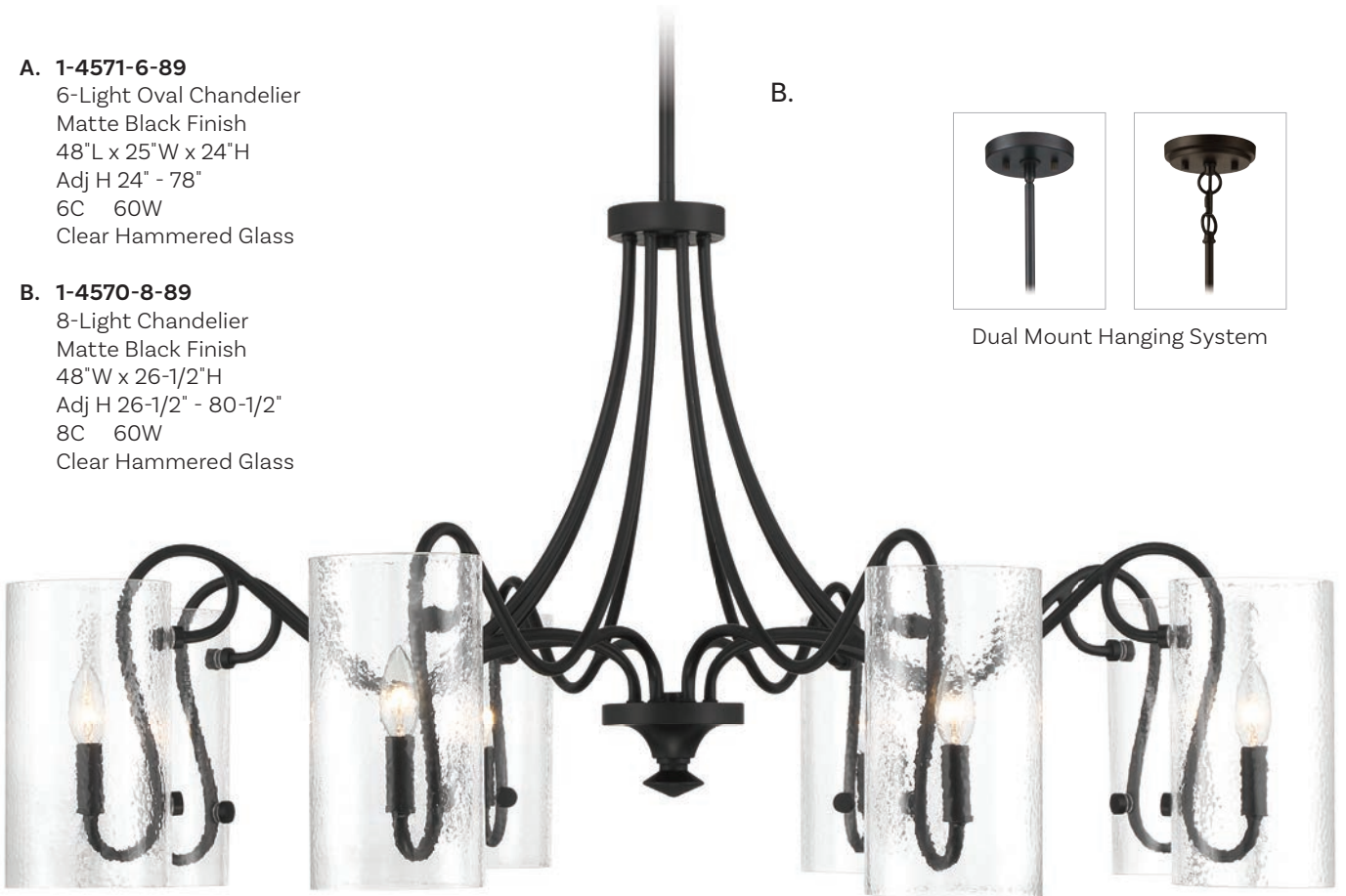

SHEFFIELD

TODAY'S CLASSIC STYLE



A. 7-7802-4-143

4-Light Lantern
Matte Black w/ Warm Brass
15"W x 32"H
4C 60W

B. 7-7800-8-143

8-Light Lantern
Matte Black w/ Warm Brass
23-1/2"W x 41-1/2"H
8C 60W

C. 1-7804-5-143

5-Light Linear Chandelier
Matte Black w/ Warm Brass
46"L x 15"W x 18-1/2"H
Adj H 18-1/2" - 72-1/2"
5C 60W



Fan D'Lier, Page 266

SHEFFIELD

TODAY'S CLASSIC STYLE

*A.



*B.



**C.

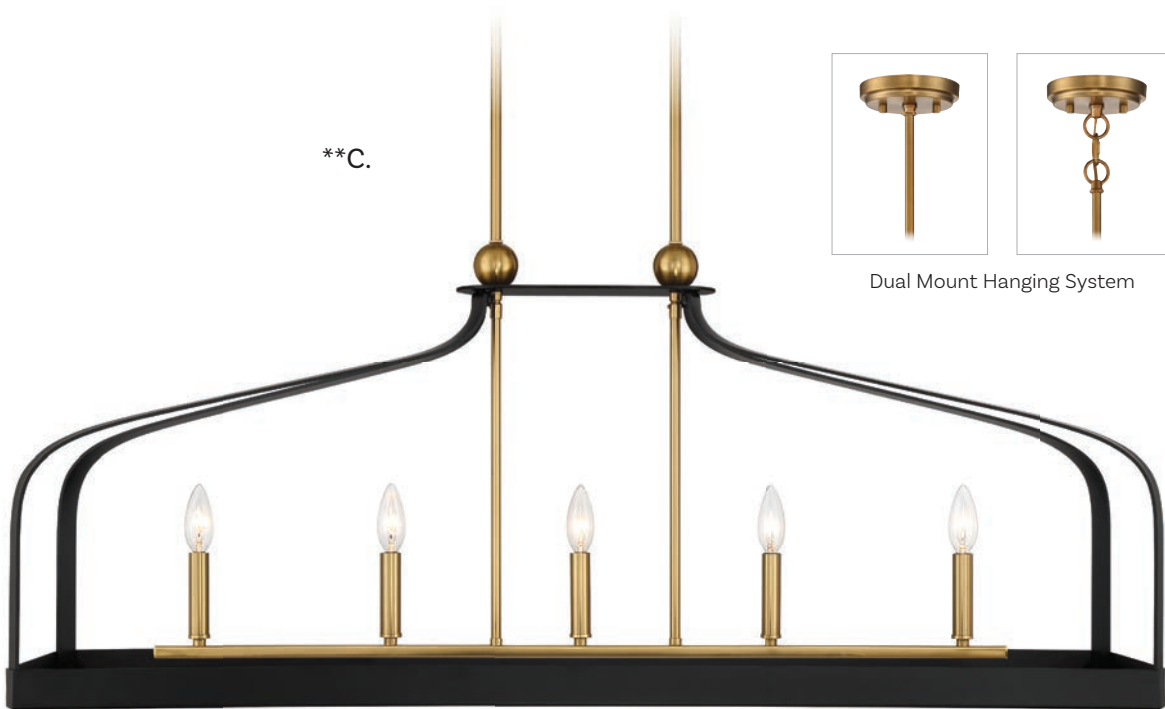

Dual Mount Hanging System

*Includes 120" chain & 144" wire

**Includes 12" & 6" extensions - additional stems available - 7-EXT

SHEFFIELD

TODAY'S CLASSIC STYLE



A. 7-7802-4-142
4-Light Lantern
White w/ Warm Brass
15"W x 32"H
4C 60W

B. 7-7800-8-142
8-Light Lantern
White w/ Warm Brass
23-1/2"W x 41-1/2"H
8C 60W

C. 1-7804-5-142
5-Light Linear Chandelier
White w/ Warm Brass
46"L x 15"W x 18-1/2"H
Adj H 18-1/2" - 72-1/2"
5C 60W



Fan D'Lier, Page 266

SHEFFIELD

TODAY'S CLASSIC STYLE

*A.



*B.



**C.

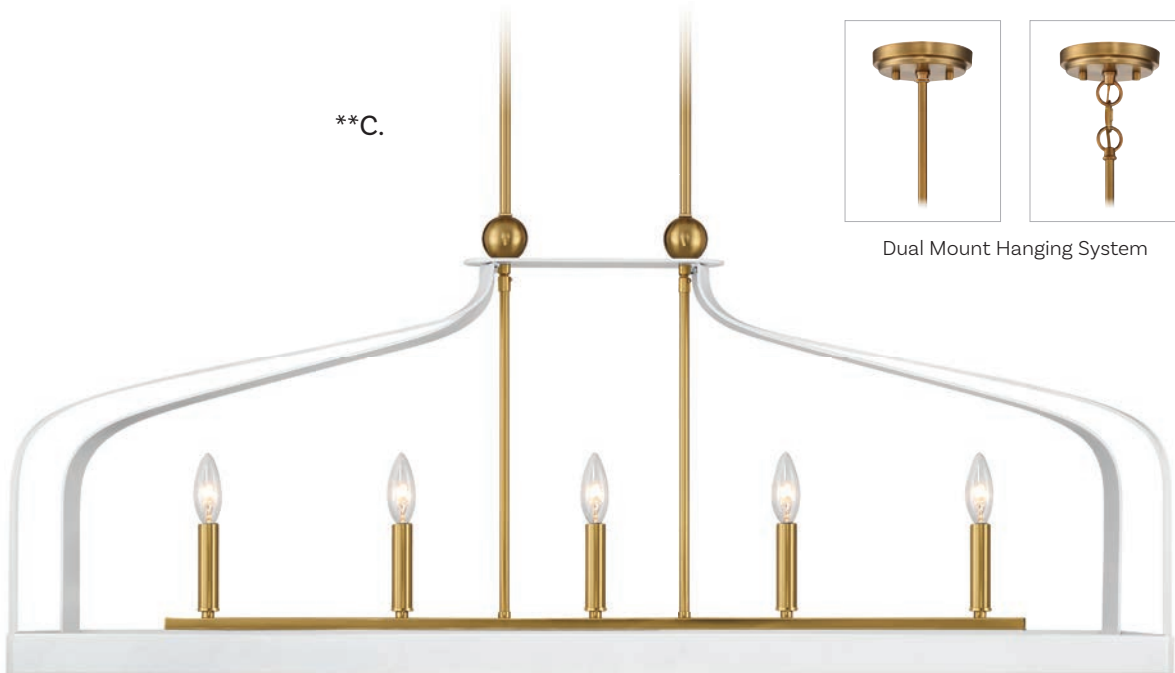

Dual Mount Hanging System

*Includes 120" chain & 144" wire

**Includes 12" & 6" extensions - additional stems available - 7-EXT

SHEFFIELD

TODAY'S CLASSIC STYLE



FAN NUMBER	26-FD-7806-142
MOTOR FINISH	White w/ Warm Brass
BLADE FINISH	Gold

FAN NUMBER	26-FD-7806-143
MOTOR FINISH	Matte Black w/ Warm Brass
BLADE FINISH	Gold

- Motor Size 104mm x 114mm
- 14" Blade Span
- 26"W x 27-3/4"H (Cage Only)
- 15° Blade Pitch
- 18" Downrod Included
- Additional Downrod Lengths Sold Separately
- ABS Blades & Integrated Fan Light Included

- 6C 6W Dimmable LED (500 Lumens per bulb, 3000K, 90+ CRI)
- Handheld Remote with E Receiver Included (RMT-AC-UNIVERSAL)
- Not Hugger Kit Adaptable
- Fan & Blades are ETL Damp Location
- Lamp Included

ENERGY USE AT HIGH SPEED

Airflow Use	Electricity Use	Airflow Efficiency
1,230	36W	34.17
Cu Ft/Min	Excludes Lights	Cu Ft/Min/W

Compare: 36" to 48" ceiling fans have airflow efficiencies ranging from approximately 71 to 86 cu. ft. per min. per watt at high speed.



Handheld Remote Control Included
RMT-AC-UNIVERSAL



SHEFFIELD

TODAY'S CLASSIC STYLE



KIRKLAND

TODAY'S CLASSIC STYLE



Includes 12" & 6" extensions - additional stems available - **7-EXTLG**



A.

A. 1-8042-6-79

6-Light Linear Chandelier
English Bronze w/ Warm Brass
32"L x 14-3/4"W x 20-3/4"H
Adj H 20-3/4" - 74-3/4"
6C 60W
30° Swivel
Clear Glass



B.

B. 7-8041-5-79

5-Light Pendant
English Bronze w/ Warm Brass
24"W x 14-3/4"H
Adj H 14-3/4" - 68-3/4"
5C 60W
30° Swivel
Clear Glass

KEARNEY

TODAY'S CLASSIC STYLE



*Includes 12" & 6" extensions - additional stems available - 7-EXT

A.



A. 9-8073-2-51
 2-Light Sconce
 Vintage Black w/ Warm Brass
 12"W x 15"H x 6"E
 2C 60W
 Clear Glass

*B.



B. 1-8070-8-51
 8-Light Chandelier
 Vintage Black w/ Warm Brass
 32"W x 24"H
 Adj H 24" - 78"
 8C 60W
 30° Swivel
 Clear Glass

*C.



C. 3-8072-4-51
 4-Light Lantern
 Vintage Black w/ Warm Brass
 17-1/4"W x 23-1/4"H
 Adj H 23-1/4" - 77-1/4"
 4C 60W
 30° Swivel
 Clear Glass

AMANI

MID-CENTURY



Includes 12" & 6" extensions - additional stems available - **7-EXTLG**

A.



B.



Dual Mount Hanging System

A. 1-1592-15-38
 15-Light Chandelier
 Royal Gold Finish
 30"W x 40"H
 Adj H 40" - 94"
 15C 60W
 Natural Alabaster Stone

B. 1-1592-15-50
 15-Light Chandelier
 Black Cashmere Finish
 30"W x 40"H
 Adj H 40" - 94"
 15C 60W
 Natural Alabaster Stone

AMANI

MID-CENTURY



Includes 12" & 6" extensions - additional stems available - **7-EXTLG**



Dual Mount Hanging System

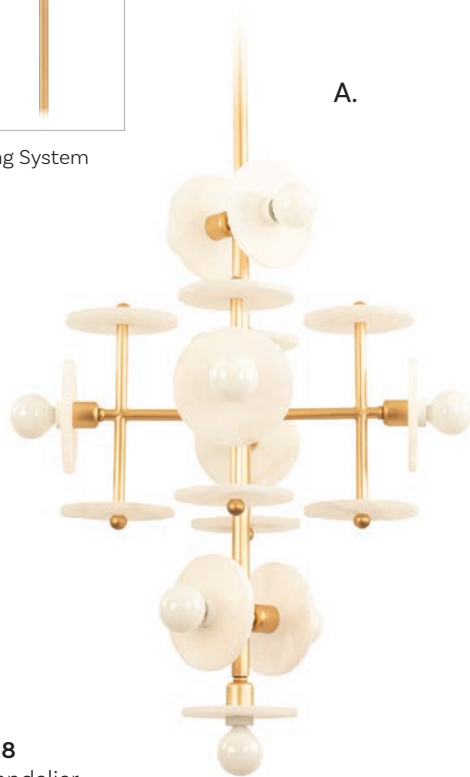

A.

- A. 1-1590-9-38**
 9-Light Chandelier
 Royal Gold Finish
 20"W x 26-1/2"H
 Adj H 26-1/2" - 80-1/2"
 9C 60W
 Natural Alabaster Stone



- B. 1-1591-14-38**
 14-Light Linear Chandelier
 Royal Gold Finish
 48"L x 10"W x 10-1/4"H
 Adj H 10-1/4" - 64-1/4"
 14C 60W
 Natural Alabaster Stone

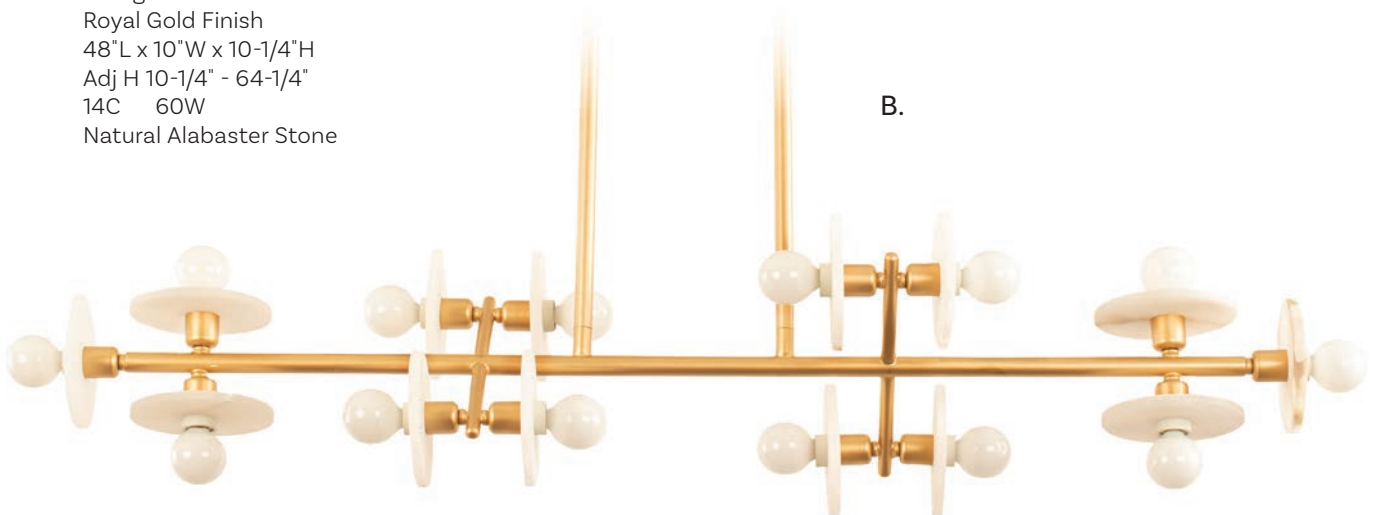

B.

AMANI

MID-CENTURY



Includes 12" & 6" extensions - additional stems available - **7-EXTLG**



Dual Mount Hanging System

A.



- A. 1-1590-9-50**
 9-Light Chandelier
 Black Cashmere Finish
 20"W x 26-1/2"H
 Adj H 26-1/2" - 80-1/2"
 9C 60W
 Natural Alabaster Stone



MID-CENTURY

- B. 1-1591-14-50**
 14-Light Linear Chandelier
 Black Cashmere Finish
 48"L x 10"W x 10-1/4"H
 Adj H 10-1/4" - 64-1/4"
 14C 60W
 Natural Alabaster Stone

B.

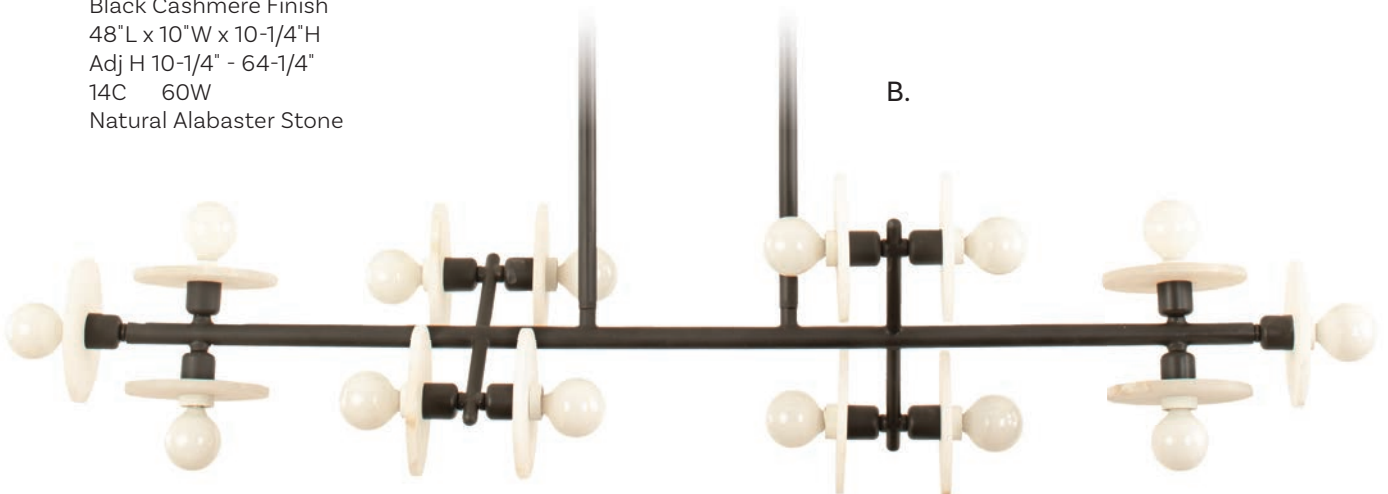

MARIAS

MID-CENTURY



Includes 12" & 6" extensions – additional stems available – **7-EXT**
The arms of the Chandeliers are adjustable and can rotate into different positions

MARIAS

MID-CENTURY



Dual Mount Hanging System

A. 1-3319-7-11
7-Light Chandelier
Polished Chrome Finish
32"W x 22"H
Adj H 22" - 76"
7C 60W
Strie Glass

B. 1-3319-7-89
7-Light Chandelier
Matte Black Finish
32"W x 22"H
Adj H 22" - 76"
7C 60W
Strie Glass

C. 1-3319-7-322
7-Light Chandelier
Warm Brass Finish
32"W x 22"H
Adj H 22" - 76"
7C 60W
Strie Glass

COUplet

MID-CENTURY



Dual Mount Hanging System



A. 1-6697-4-143
 4-Light Chandelier
 Matte Black w/
 Warm Brass Finish
 16"W x 22"H
 Adj H 22" - 76"
 4G9 60W
 Frosted Glass

B. 1-6698-8-143
 8-Light Chandelier
 Matte Black w/
 Warm Brass Finish
 25"W x 21"H
 Adj H 21" - 75"
 8G9 60W
 Frosted Glass

C. 1-6699-8-143
 8-Light Linear Chandelier
 Matte Black w/
 Warm Brass Finish
 38"L x 10"W x 13"H
 Adj H 13" - 67"
 8G9 60W
 Frosted Glass



Sconce, Page 559

COUPLER

MID-CENTURY

A.



B.



C.



Includes 12" & 6" extensions - additional stems available - 7-EXT

ARCHWAY

MID-CENTURY



Dual Mount Hanging System

A. 9-5531-2-143
2-Light Sconce
Warm Brass w/
Matte Black Finish
9"W x 12-1/2"H x 4"E
2C 60W

B. 7-5532-4-143
4-Light Chandelier
Warm Brass w/
Matte Black Finish
14"W x 18"H
Adj H 18" - 72"
4C 60W

C. 1-5533-8-143
8-Light Linear Chandelier
Warm Brass w/
Matte Black Finish
38"L x 10"W x 12-1/2"H
Adj H 12-1/2" - 66-1/2"
8C 60W

ARCHWAY

MID-CENTURY

A.



*B.



*C.



*Includes 12" & 6" extensions - additional stems available - 7-EXT

WRIGHT

MID-CENTURY



*Includes 12" & 6" extensions - additional stems available - **7-EXTLG**

Includes 12" & 6" extensions - additional stems available - **7-EXT



Dual Mount Hanging System

*A.



**B.



A. 1-3074-8-89
8-Light Chandelier
Matte Black Finish
40"W x 10"H
Adj H 10" - 64"
8E 60W
Clear Glass

B. 1-3073-5-89
5-Light Chandelier
Matte Black Finish
28"W x 10"H
Adj H 10" - 64"
5E 60W
Clear Glass



Pendant, Page 453



Bath, Page 631



Sconce, Page 630

WRIGHT

MID-CENTURY

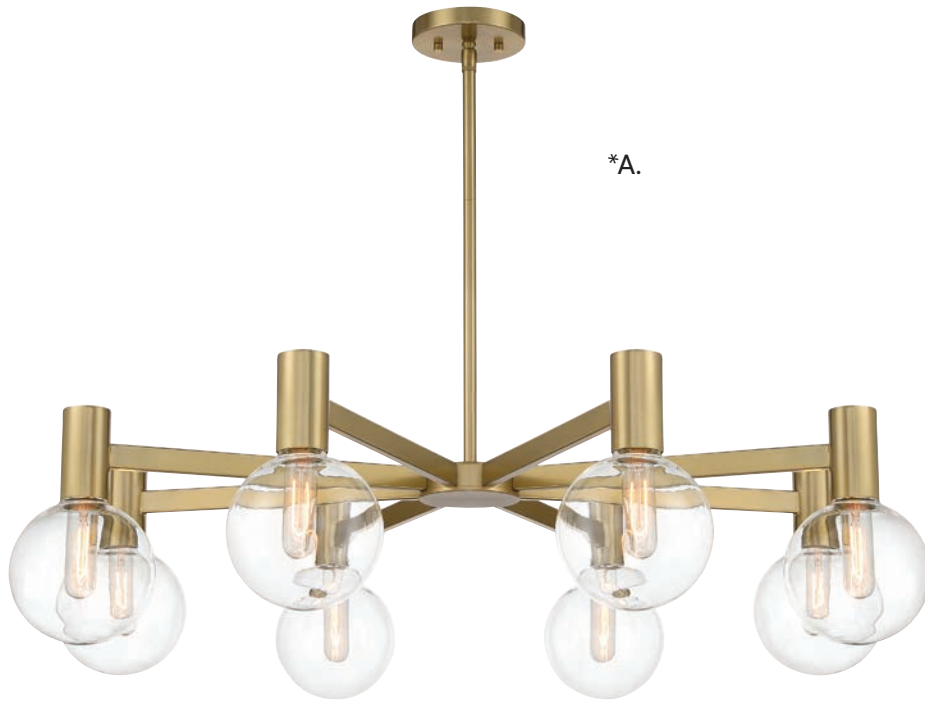

*A.



Dual Mount Hanging System

A. 1-3074-8-322
8-Light Chandelier
Warm Brass Finish
40"W x 10"H
Adj H 10" - 64"
8E 60W
Clear Glass

B. 1-3073-5-322
5-Light Chandelier
Warm Brass Finish
28"W x 10"H
Adj H 10" - 64"
5E 60W
Clear Glass



**B.



Sconce, Page 630



Bath, Page 631



Pendant, Page 453

*Includes 12" & 6" extensions - additional stems available - **7-EXTLG**

Includes 12" & 6" extensions - additional stems available - **7-EXT



Dual Mount Hanging System

*C.



**D.



C. 1-3074-8-11
8-Light Chandelier
Polished Chrome Finish
40"W x 10"H
Adj H 10" - 64"
8E 60W
Clear Glass

D. 1-3073-5-11
5-Light Chandelier
Polished Chrome Finish
28"W x 10"H
Adj H 10" - 64"
5E 60W
Clear Glass



Pendant, Page 453



Bath, Page 631



Sconce, Page 630

ARIEL

MID-CENTURY



*Includes 12" & 6" extensions - additional stems available - **7-EXT**

Includes 12" & 6" extensions - additional stems available - **7-EXTLG

ARIEL

MID-CENTURY

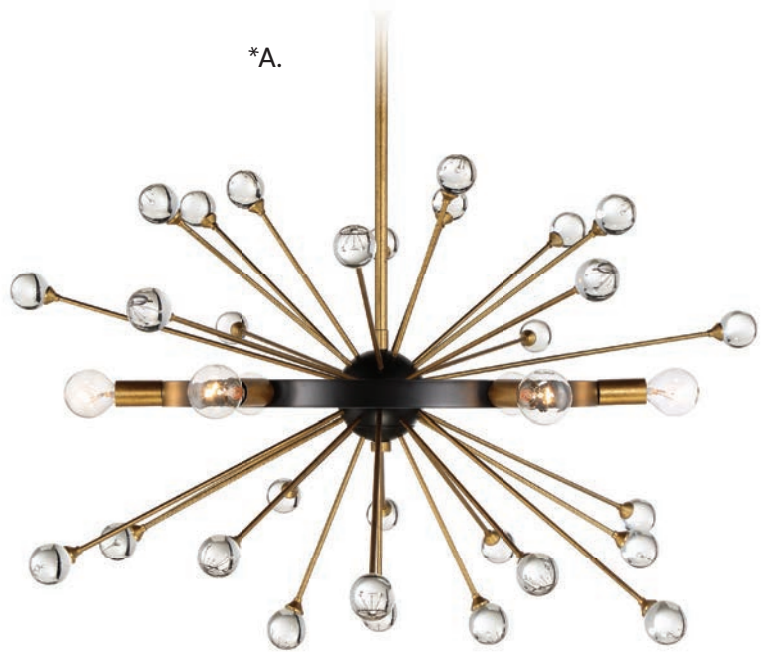

*A.



Dual Mount Hanging System

A. 1-1857-6-62

6-Light Chandelier
Como Black w/ Gold
25"W x 18"H
Adj H 18" - 72"
6C 60W
Clear Crystal

B. 1-1858-6-62

6-Light Oval Chandelier
Como Black w/ Gold
37"L x 18"W x 21"H
Adj H 21" - 75"
6C 60W
Clear Crystal

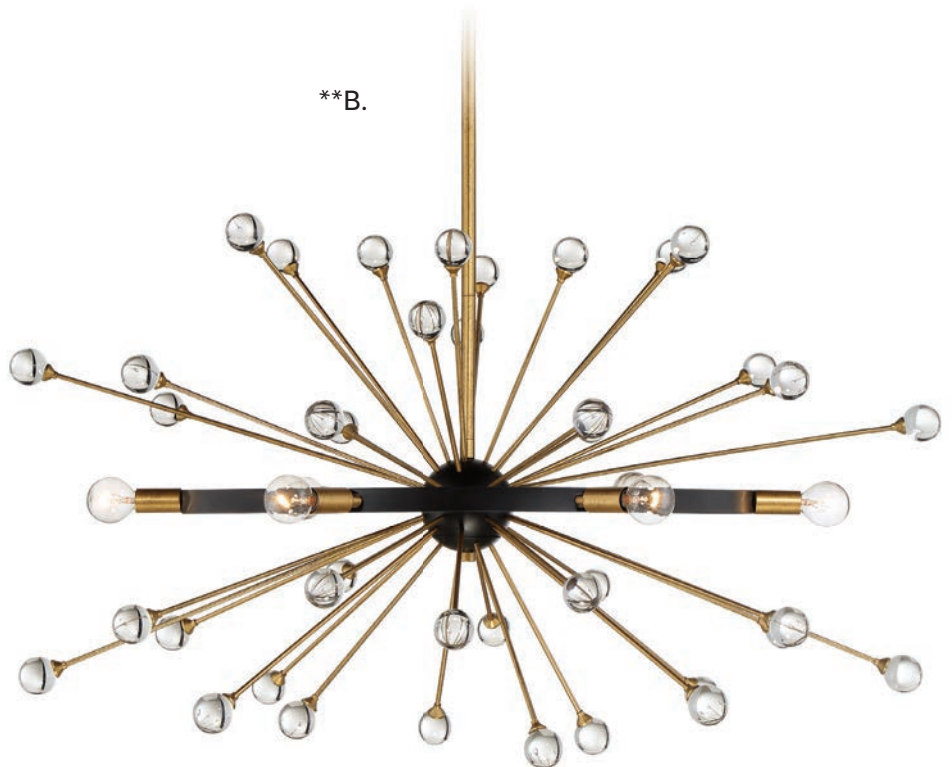

**B.

GALEA

MID-CENTURY

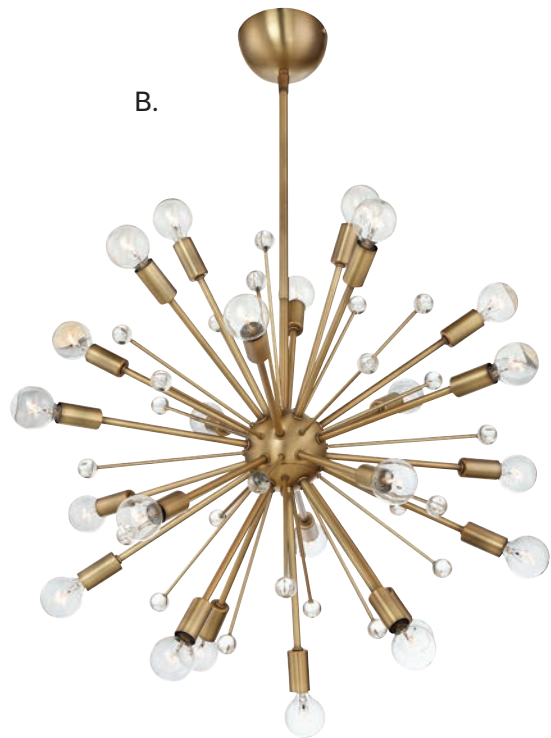

A. 7-6099-24-109
24-Light Pendant
Polished Nickel Finish
23"W x 23"H
Adj H 23" - 71-1/2"
24C 25W
30° Swivel
K9 Crystal

B. 7-6099-24-322
24-Light Pendant
Warm Brass Finish
23"W x 23"H
Adj H 23" - 71-1/2"
24C 25W
30° Swivel
K9 Crystal

C. 7-6099-24-89
24-Light Pendant
Matte Black Finish
23"W x 23"H
Adj H 23" - 71-1/2"
24C 25W
30° Swivel
K9 Crystal

GALEA

MID-CENTURY



Includes 12" & 6" extensions - additional stems available - 7-EXT

LAKEWOOD

MID-CENTURY



Dual Mount Hanging System

A. 7-1831-1-322

1-Light Mini-Pendant
Warm Brass Finish
8"W x 22"H
Adj H 22" - 50-1/2"
1E 60W
Clear Glass

B. 1-1832-5-322

5-Light Chandelier
Warm Brass Finish
28"W x 20"H
Adj H 20" - 74"
5E 60W
Clear Glass

C. 1-1833-6-322

6-Light Linear Chandelier
Warm Brass Finish
40"L x 17-1/2"W x 17"H
Adj H 17" - 71"
6E 60W
Clear Glass

LAKEWOOD

MID-CENTURY



*Includes (3) 9-1/2" extensions - additional stems available - **7-EXT**

Includes 12" & 6" extensions - additional stems available - **7-EXT

Bath & Sconce, Page 621

LAKEWOOD

MID-CENTURY



Dual Mount Hanging System

A. 7-1831-1-89
1-Light Mini-Pendant
Matte Black Finish
8"W x 22"H
Adj H 22" - 50-1/2"
1E 60W
Clear Glass

B. 1-1832-5-89
5-Light Chandelier
Matte Black Finish
28"W x 20"H
Adj H 20" - 74"
5E 60W
Clear Glass

C. 1-1833-6-89
6-Light Linear Chandelier
Matte Black Finish
40"L x 17-1/2"W x 17"H
Adj H 17" - 71"
6E 60W
Clear Glass

LAKEWOOD

MID-CENTURY

*A.



**B.



**C.



*Includes (3) 9-1/2" extensions - additional stems available - **7-EXT**

Includes 12" & 6" extensions - additional stems available - **7-EXT

Bath & Sconce, Page 621

FOLSOM

MID-CENTURY



FOLSOM

MID-CENTURY



A.

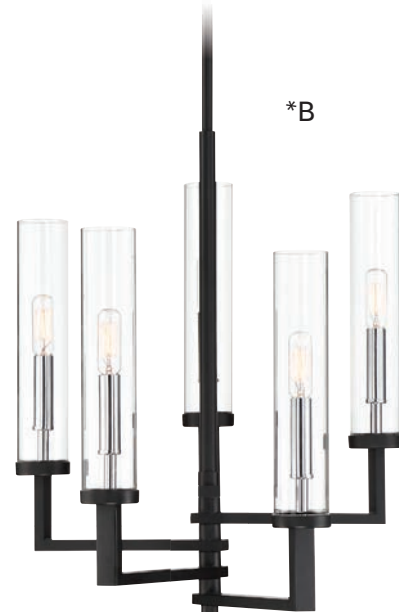
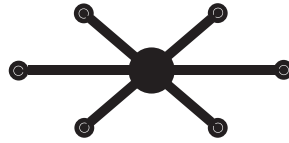

*B

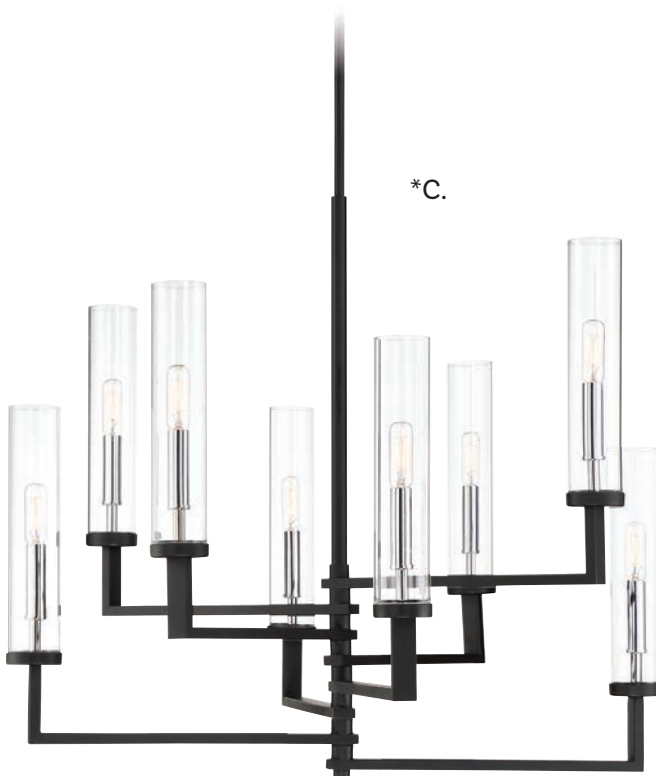

*C.

A. 9-2134-2-67

2-Light Adjustable Sconce
Matte Black w/
Polished Chrome
8"W x 17"H x 3-1/2"E
Adj E 3-1/2" - 6-3/4"
2C 60W
Clear Glass

B. 1-2135-5-67

5-Light Adjustable Chandelier
Matte Black w/
Polished Chrome
18"W x 21"H
Adj H 21" - 75"
5C 60W
30° Swivel
Clear Glass

C. 1-2139-8-67

8-Light Adjustable Chandelier
Matte Black w/
Polished Chrome
30"W x 25"H
Adj H 25" - 79"
8C 60W
30° Swivel
Clear Glass

*Includes 12" & 6" extensions - additional stems available - 7-EXT

LYRIQUE

MID-CENTURY

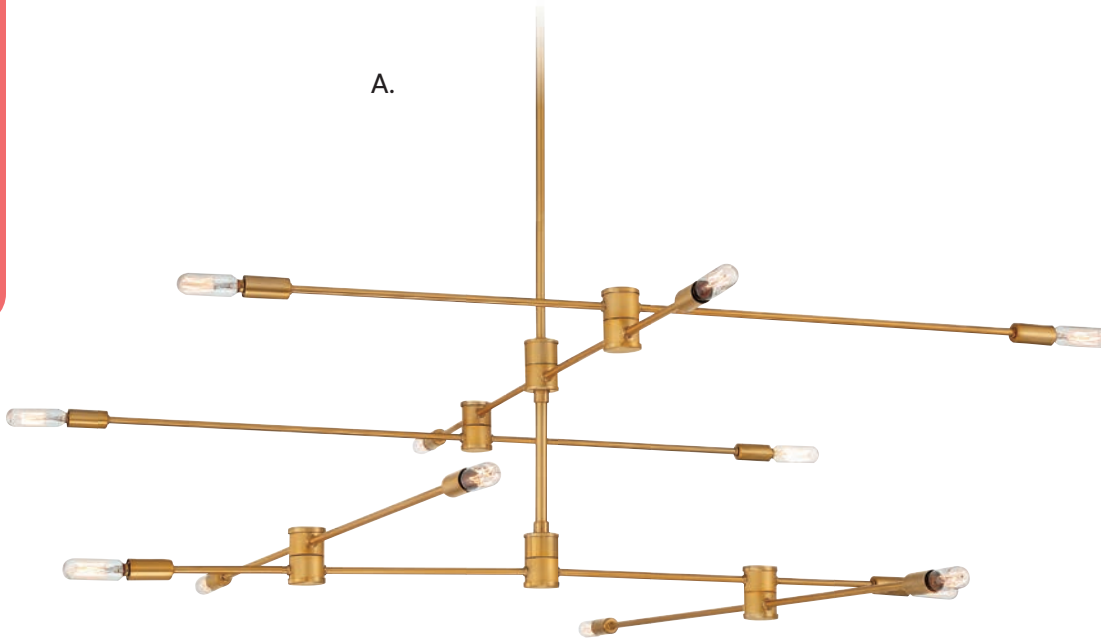

A. 1-7001-12-322
Adjustable
12-Light Chandelier
Warm Brass Finish
54-1/4"W x 15"H
Adj H 15" - 69"
12C 60W
30° Swivel

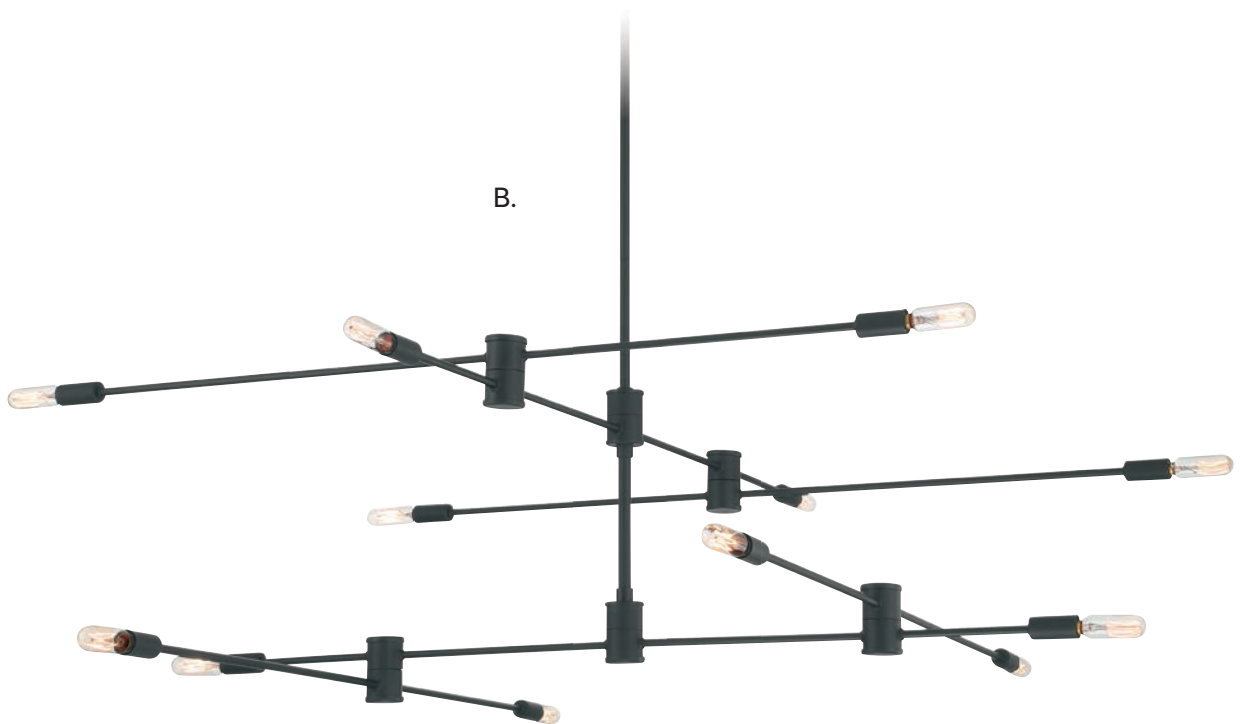

B. 1-7001-12-89
Adjustable
12-Light Chandelier
Matte Black Finish
54-1/4"W x 15"H
Adj H 15" - 69"
12C 60W
30° Swivel

Includes 12" & 6" extensions - additional stems available - **7-EXT**
The arms of the Chandeliers are adjustable and can rotate into different positions

LYRIQUE

MID-CENTURY

C. 1-7001-12-109

Adjustable
12-Light Chandelier
Polished Nickel Finish
54-1/4"W x 15"H
Adj H 15" - 69"
12C 60W
30° Swivel

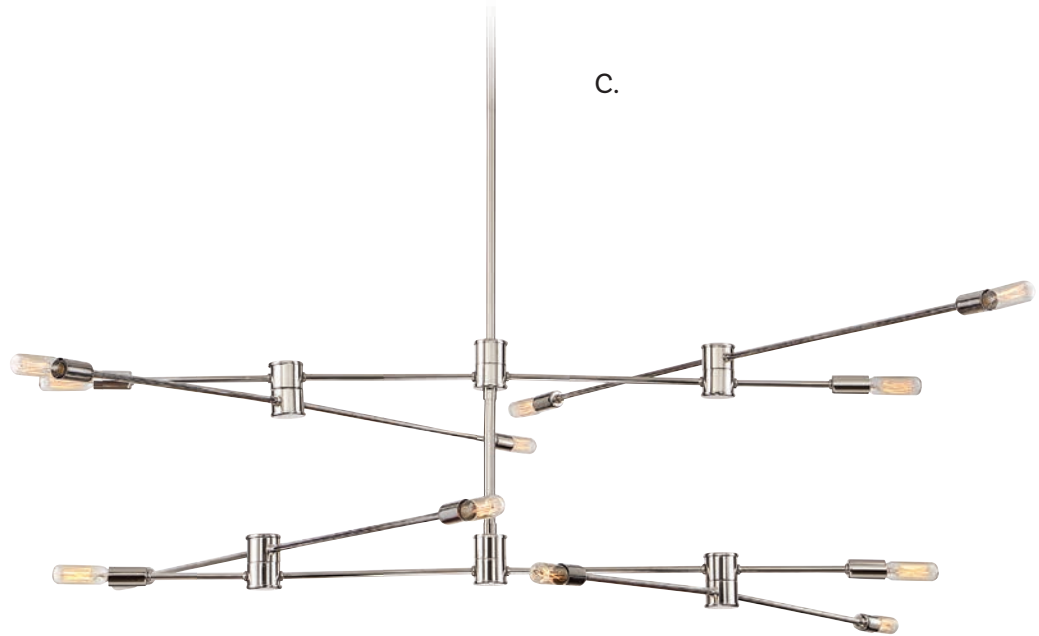

D. 1-7001-12-77

Adjustable
12-Light Chandelier
Bronze w/ Brass Finish
54-1/4"W x 15"H
Adj H 15" - 69"
12C 60W
30° Swivel

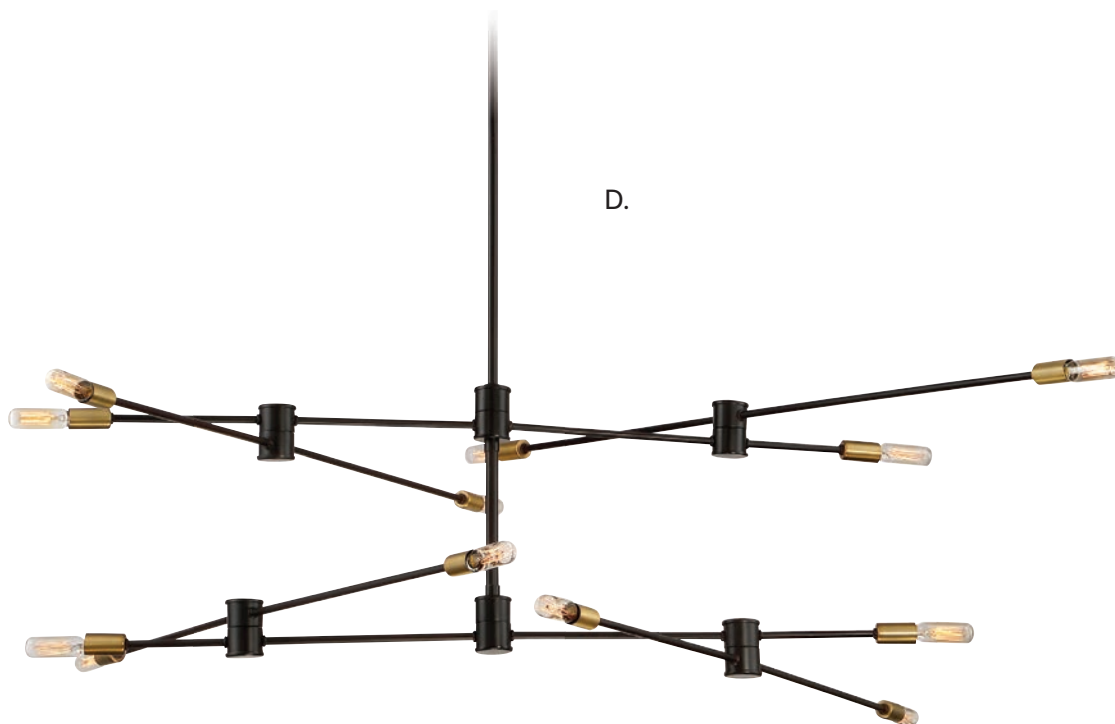

LYRIQUE

MID-CENTURY

A.

A. 1-7000-6-322

Adjustable 6-Light Chandelier
Warm Brass Finish
21-3/4"W x 7"H
Adj H 7" - 61"
6C 60W
30° Swivel

B. 1-7000-6-89

Adjustable 6-Light Chandelier
Matte Black Finish
21-3/4"W x 7"H
Adj H 7" - 61"
6C 60W
30° Swivel

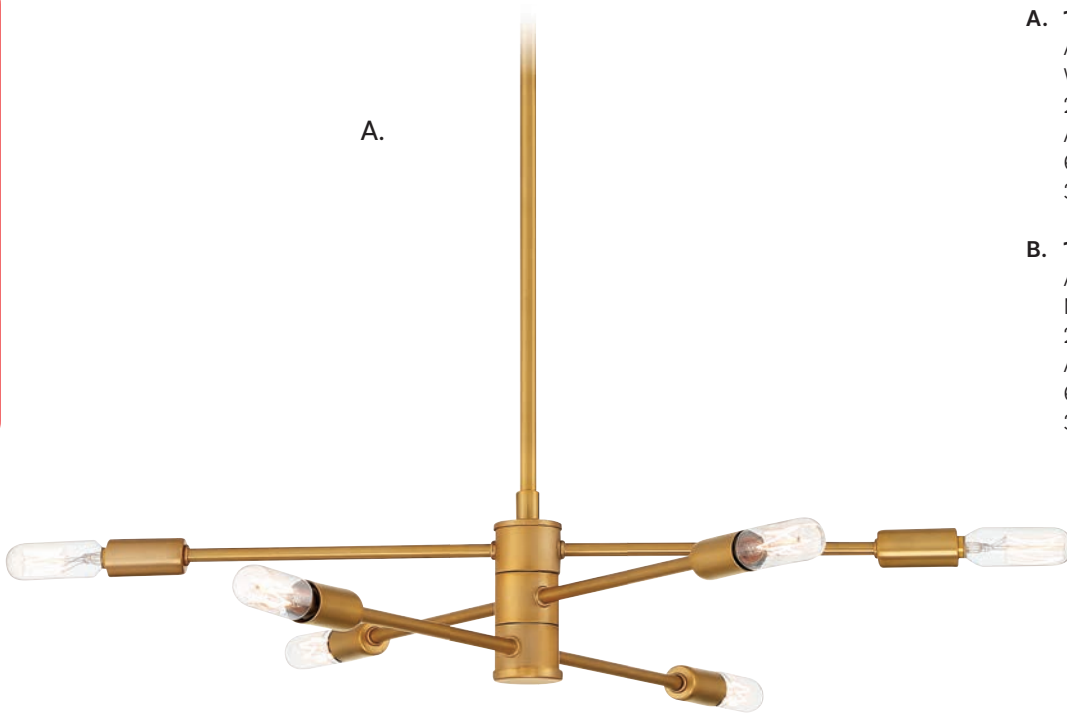

B.

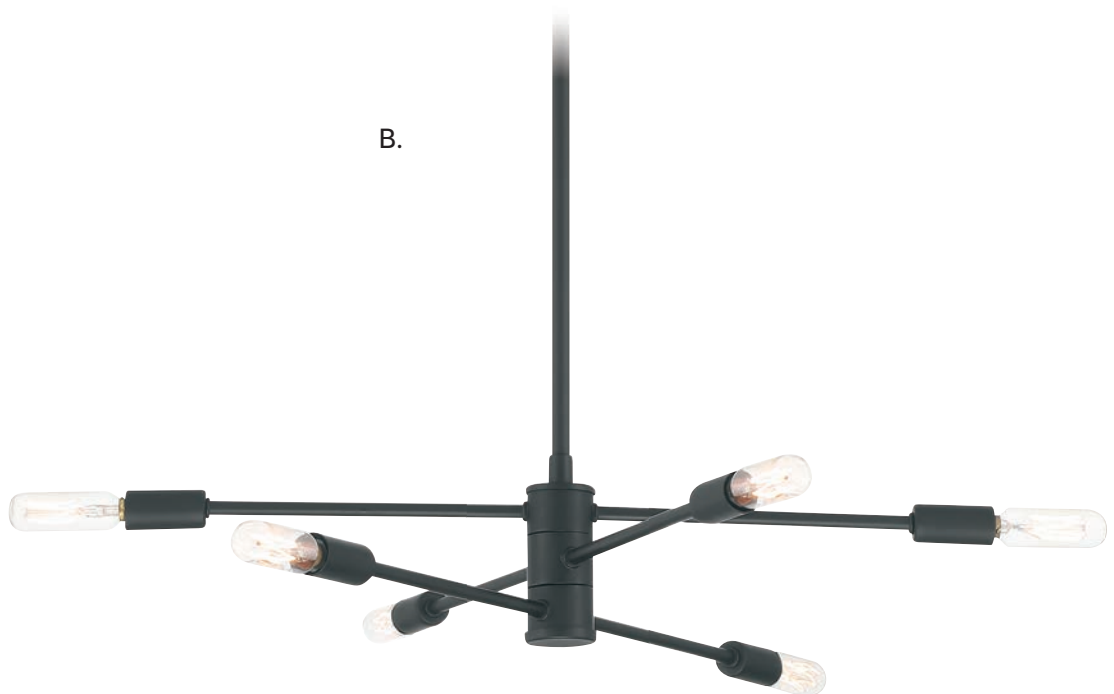

Includes 12" & 6" extensions - additional stems available - **7-EXT**

The arms of the Chandeliers are adjustable and can rotate into different positions

LYRIQUE

MID-CENTURY

C. 1-7000-6-77

Adjustable 6-Light Chandelier
Bronze w/ Brass Finish
21-3/4"W x 7"H
Adj H 7" - 61"
6C 60W
30° Swivel

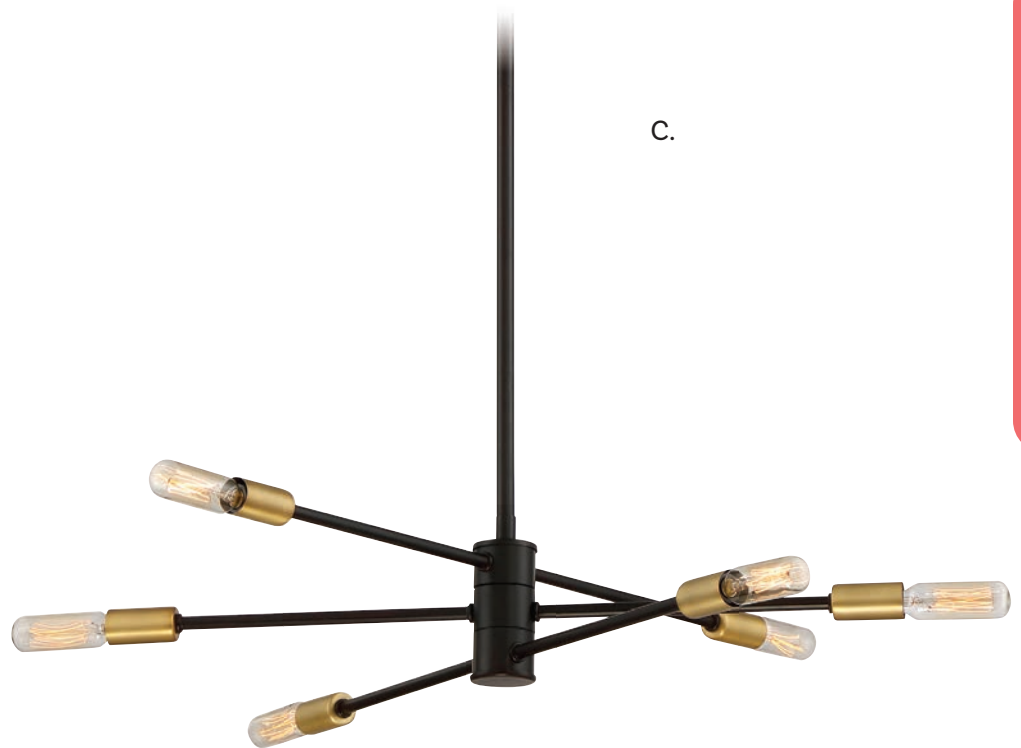

D. 1-7000-6-109

Adjustable 6-Light Chandelier
Polished Nickel Finish
21-3/4"W x 7"H
Adj H 7" - 61"
6C 60W
30° Swivel

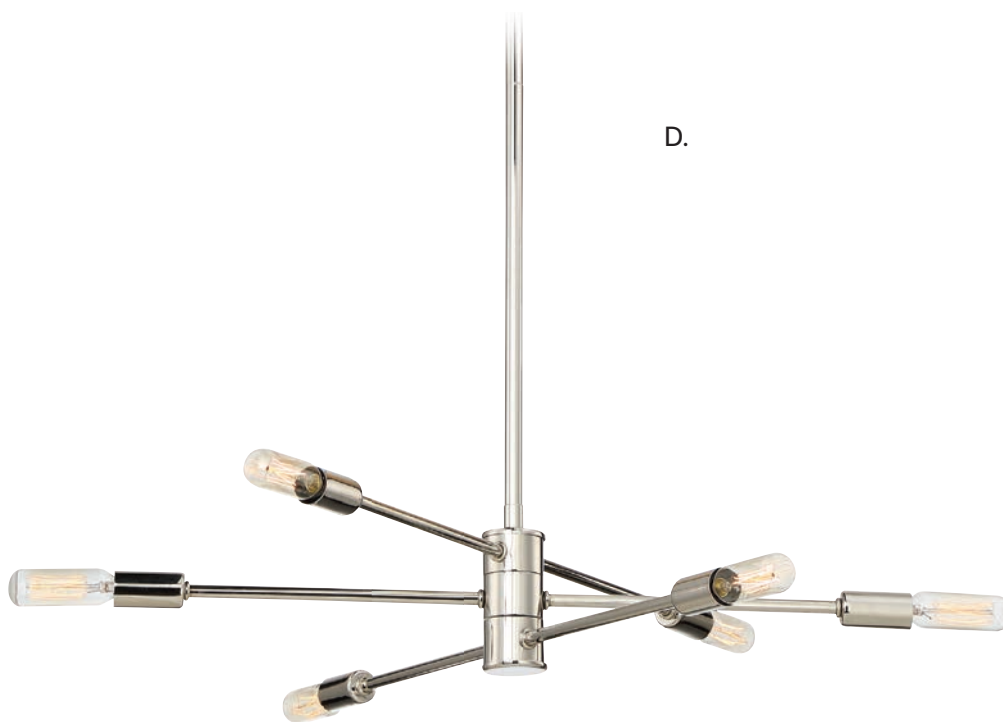

FALSTER

MID-CENTURY

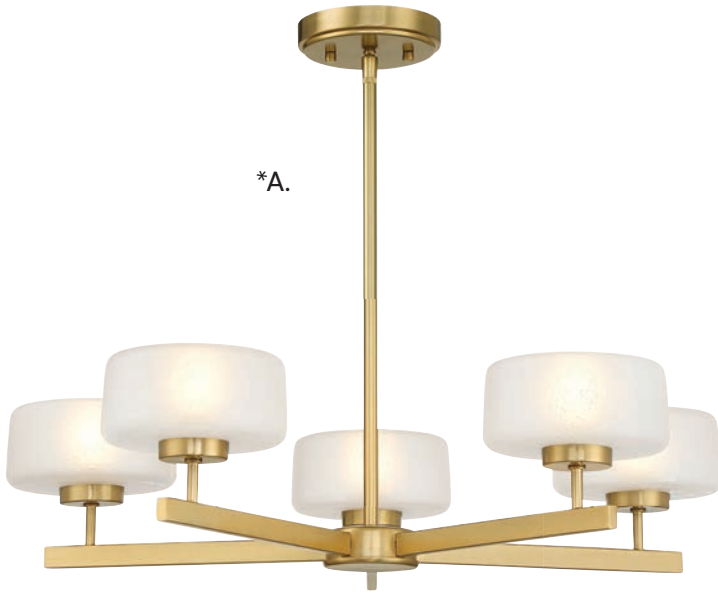

LED



*Includes 12" & 6" extensions - additional stems available - 7-EXT

FALSTER

MID-CENTURY



Dual Mount Hanging System



A. 1-5409-5-322
 5-Light Chandelier
 Warm Brass Finish
 26"W x 5-1/2"H
 Adj H 5-1/2" - 59-1/2"
 5G9 3W LED
 810 Lumens, 3000K, 90+ CRI
 Frosted Seeded Glass
G9 Bulbs Included

B. 9-5405-1-322
 1-Light Sconce
 Warm Brass Finish
 5-3/4"W x 7"H x 8-1/2"E
 1G9 3W LED
 160 Lumens, 3000K, 90+ CRI
 Frosted Seeded Glass
G9 Bulb Included

C. 1-5407-5-322
 5-Light Linear Chandelier
 Warm Brass Finish
 42"L x 5-3/4"W x 9-1/2"H
 Adj H 9-1/2" - 63-1/2"
 5G9 3W LED
 810 Lumens, 3000K, 90+ CRI
 Frosted Seeded Glass
G9 Bulbs Included

FALSTER

MID-CENTURY



Dual Mount Hanging System



A. 9-5405-1-89

1-Light Sconce
Matte Black Finish
5-3/4"W x 7"H x 8-1/2"E
1G9 3W LED
160 Lumens, 3000K, 90+ CRI
Frosted Seeded Glass
G9 Bulb Included

B. 1-5409-5-89

5-Light Chandelier
Matte Black Finish
26"W x 5-1/2"H
Adj H 5-1/2" - 59-1/2"
5G9 3W LED
810 Lumens, 3000K, 90+ CRI
Frosted Seeded Glass
G9 Bulbs Included

C. 1-5407-5-89

5-Light Linear Chandelier
Matte Black Finish
42"L x 5-3/4"W x 9-1/2"H
Adj H 9-1/2" - 63-1/2"
5G9 3W LED
810 Lumens, 3000K, 90+ CRI
Frosted Seeded Glass
G9 Bulbs Included

FALSTER

MID-CENTURY



A.

LED



*B.



*C.

*Includes 12" & 6" extensions - additional stems available - 7-EXT

NEWELL

MID-CENTURY



Dual Mount Hanging System

A. 6-8602-1-322
 1-Light Semi Flush
 Warm Brass Finish
 16"W x 7"H
 1E 60W
 Clear Glass
 White Opal Chimney

B. 9-8606-2-322
 2-Light Sconce
 Warm Brass Finish
 10-1/4"W x 12"H x 6-1/4"E
 2C 60W
 Clear Glass
 White Opal Chimney

C. 7-8604-1-322
 1-Light Pendant
 Warm Brass Finish
 20"W x 6-3/4"H
 Adj H 6-3/4" - 60-3/4"
 1E 60W
 Clear Glass
 White Opal Chimney

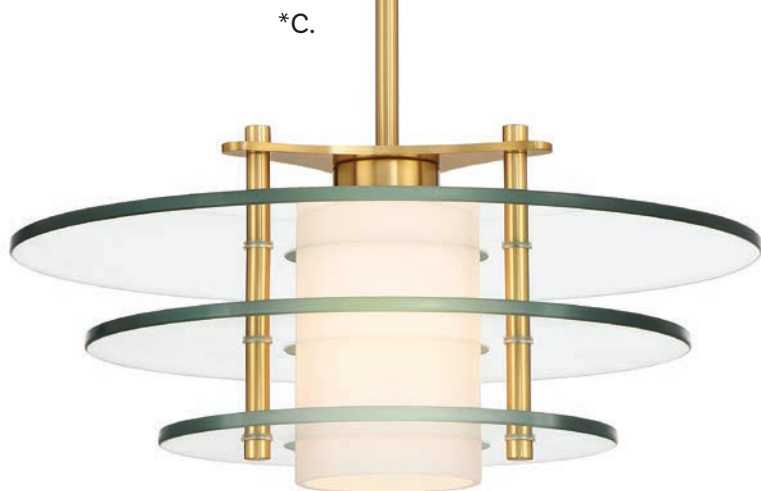

*Includes 12" & 6" extensions - additional stems available - 7-EXT

BEACON

MID-CENTURY



Dual Mount Hanging System

A. 9-183-2-171
2-Light Sconce
Burnished Brass Finish
8"W x 16"H x 4"E
2C 60W
Frosted White Glass

B. 7-182-3-171
3-Light Pendant
Burnished Brass Finish
12"W x 24"H
Adj H 24" - 78"
3C 60W
Frosted White Glass

C. 1-181-4-171
4-Light Pendant
Burnished Brass Finish
20"W x 16"H
Adj H 16" - 70"
4E 60W
Frosted White Glass

BEACON

MID-CENTURY



*Includes 12" & 6" extensions - additional stems available - **7-EXTLG**

Includes 12" & 6" extensions - additional stems available - **7-EXT

MEDLOCK

LIGHTING ORGANICS



*Includes 120" chain & 144" wire

** Includes 12" & 6" extensions - additional stems available - 7-EXT

SELBY / MEDLOCK



Dual Mount Hanging System

*A.



**B.



A. SELBY

7-5106-5-177

5-Light Pendant

Burnished Brass w/ Rattan Finish

25"W x 32-1/2"H

5E 60W

Rattan Resin Shade

UL Damp Rated

B. MEDLOCK

7-9906-8-171

8-Light Garden Chandelier

Burnished Brass Finish

32"W x 22"H

Adj H 22" - 76"

8C 40W

Rattan Resin Shade

UL Damp Rated



LONGLEAF

LIGHTING ORGANICS



LONGLEAF



A.

- A. 7-6192-4-89**
4-Light Pendant
Matte Black Finish
28"W x 40"H
4E 60W
Rattan Resin Shade
UL Damp Rated



B.

- B. 7-6192-4-171**
4-Light Pendant
Burnished Brass Finish
28"W x 40"H
4E 60W
Rattan Resin Shade
UL Damp Rated



LANAI

LIGHTING ORGANICS



Includes 12" & 6" extensions - additional stems available - **7-EXTLG**

MARCY / LANAI



Dual Mount Hanging System

A. MARCY

7-1429-1-89

1-Light Pendant

Matte Black Finish

30"W x 13-3/4"H

Adj H 13-3/4"- 67-3/4"

1E 60W

Rattan Resin Shade

Clear Seeded Glass

UL Damp Rated

B. LANAI

7-6427-1-322

1-Light Pendant

Warm Brass Finish

32"W x 15"H

Adj H 15"- 69"

1E 60W

Rattan Resin Shade

Clear Seeded Glass

UL Damp Rated



A.

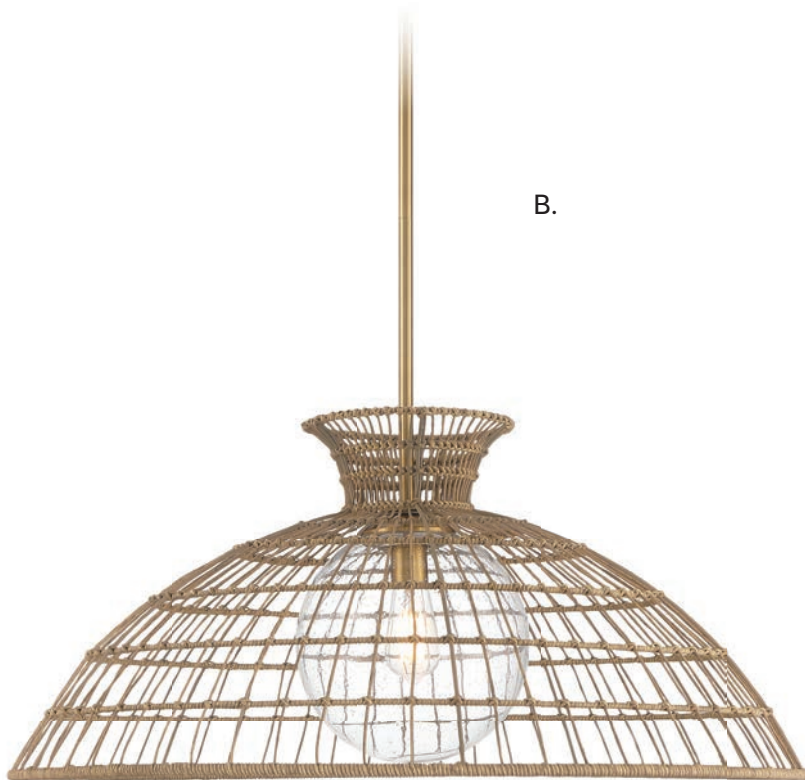

B.



EMAN

LIGHTING ORGANICS



7-7772-6-180

6-Light Pendant
Matte Black w/ Dark Rattan Finish
30"W x 14-5/8"H
6C 60W
Metal Candle Covers



Includes 120" chain & 144" wire



MACRA

LIGHTING ORGANICS



Includes 120" lamp cord

MACRA / PAMPAS

A.

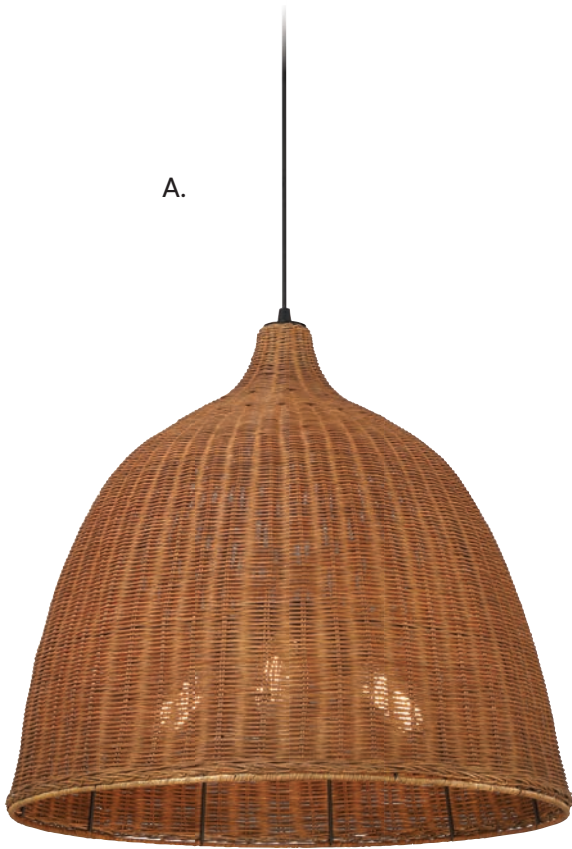

A. MACRA
7-1656-3-128
3-Light Pendant
Café Finish
23"W x 21"H
3E 60W
Wicker Shade

B.



B. PAMPAS
7-1657-3-89
3-Light Pendant
Matte Black Finish
30"W x 26"H
3E 60W
Wicker Shade

CYPERAS

LIGHTING ORGANICS



7-1825-5-320
5-Light Pendant
Warm Brass & Rope Finish
30"W x 22"H
5C 60W



Includes 120" chain & 144" wire



CYPERAS

LIGHTING ORGANICS



ASHBURN

LIGHTING ORGANICS



Includes 12" & 6" extensions - additional stems available - **7-EXTLG**

ASHBURN

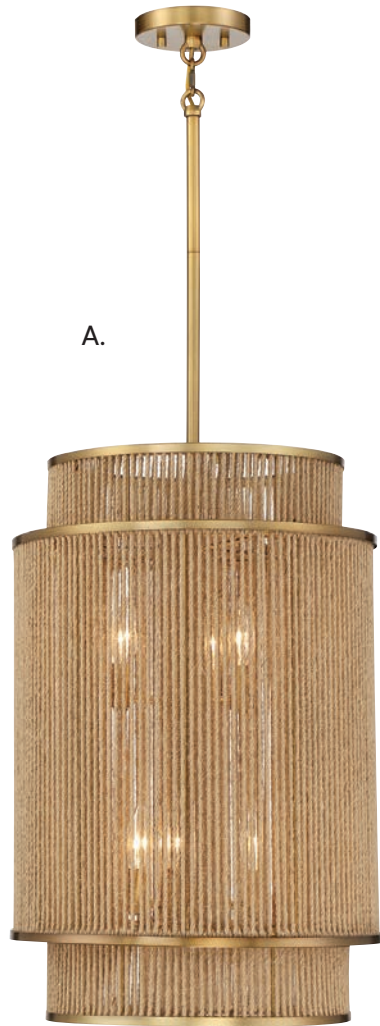

Dual Mount Hanging System

A. 3-1773-6-320
6-Light Lantern
Warm Brass & Rope Finish
16"W x 24-1/2"H
Adj H 24-1/2" - 78-1/2"
6C 60W

B. 7-1774-6-320
6-Light Pendant
Warm Brass & Rope Finish
28"W x 12"H
Adj H 12" - 66"
6C 60W

ASHE

LIGHTING ORGANICS



A.



B.

A. 6-1682-5-320
5-Light Semi-Flush
Warm Brass & Rope Finish
24"W x 8"H
5E 60W

B. 9-1826-1-320
1-Light Sconce
Warm Brass & Rope Finish
8-1/2"W x 16"H x 8-1/2"E
1C 60W
Clear Glass

ASHE

LIGHTING ORGANICS



Dual Mount Hanging System

C. 7-1739-4-320
4-Light Pendant
Warm Brass & Rope Finish
20"W x 8"H
Adj H 8" - 62"
4E 60W

D. 1-1738-5-320
5-Light Oval Chandelier
Warm Brass & Rope Finish
42"L x 14"W x 9"H
Adj H 9" - 63"
5E 60W

*Includes 12" & 6" extensions - additional stems available - 7-EXTLG

CHARTER

LIGHTING ORGANICS



*Includes 120" chain & 144" wire

**Includes 12" & 6" extensions - additional stems available - 7-EXT

CHARTER / CANNON

*A.



Dual Mount Hanging System

**B.

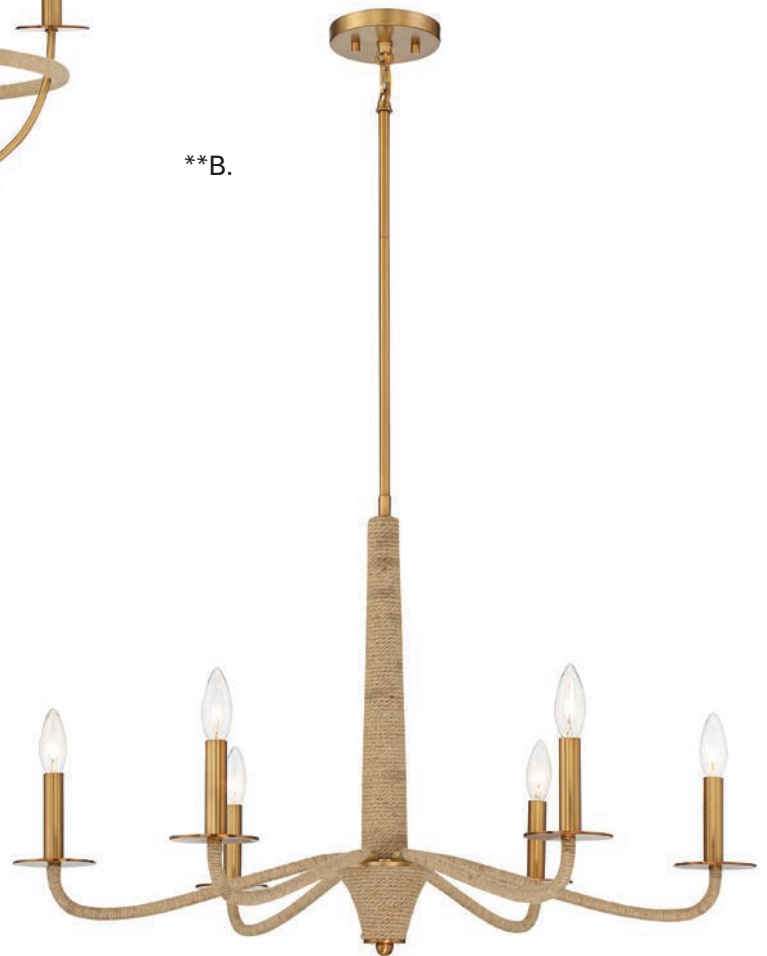

A. CHARTER

1-1823-6-320

6-Light Chandelier

Warm Brass & Rope Finish

32"W x 28"H

6C 60W

B. CANNON

1-1824-6-320

6-Light Chandelier

Warm Brass & Rope Finish

32"W x 19"H

Adj H 19" - 73"

6C 60W

DANIELS

LIGHTING ORGANICS



Includes 12" & 6" extensions - additional stems available - **7-EXTLG**

A. 1-1760-8-198
8-Light Chandelier
Natural Antler Finish
40"W x 38"H
Adj H 38" - 92"
8C 60W

B. 1-1760-8-80
8-Light Chandelier
Matte White Finish
40"W x 38"H
Adj H 38" - 92"
8C 60W

A.



B.



Dual Mount Hanging System

DANIELS



A. 1-1761-6-198
6-Light Chandelier
Natural Antler Finish
24"W x 17"H
6C 60W



B. 1-1761-6-80
6-Light Chandelier
Matte White Finish
24"W x 17H
6C 60W

Includes 120" chain & 144" wire



OAKMONT

LIGHTING ORGANICS



*Includes 120" chain & 144" wire

**Includes 12" & 6" extensions - additional stems available - 7-EXT

OAKMONT / MAYA

A. OAKMONT
7-4618-6-83
6-Light Pendant
Bisque White Finish
29"W x 27"H
6C 60W

B. MAYA
7-7681-1-83
1-Light Pendant
Bisque White Finish
20"W x 21-1/2"H
Adj H 21-1/2" - 75-1/2"
1E 60W
Resin Wicker Shade



BIRCH

*A.



Dual Mount Hanging System

B.



A. 3-4197-4-322
4-Light Lantern
Warm Brass Finish
12"W x 17"H
Adj H 17" - 71"
4C 60W
Clear Glass

B. 6-4198-3-171
3-Light Semi-flush
Burnished Brass Finish
20"W x 11"H
3C 60W

BIRCH



*C.



D.



Dual Mount Hanging System

C. 3-4197-4-83
 4-Light Lantern
 Bisque White Finish
 12" W x 17" H
 Adj H 17" - 71"
 4C 60W
 Clear Glass

D. 6-4198-3-83
 3-Light Semi-flush
 Bisque White Finish
 20" W x 11" H
 3C 60W

*Includes 12" & 6" extensions - additional stems available - 7-EXT

BIRCH

LIGHTING ORGANICS



Includes 120" chain & 144" wire

BIRCH



A.

- A. 7-4199-6-83**
6-Light Pendant
Bisque White Finish
28"W x 23-1/4"H
6C 60W



B.

- B. 7-4199-6-171**
6-Light Pendant
Burnished Brass Finish
28"W x 23-1/4"H
6C 60W

VENTURA

CASUAL SOPHISTICATION



*Includes 120" chain & 144" wire

VENTURA

CASUAL SOPHISTICATION

A.

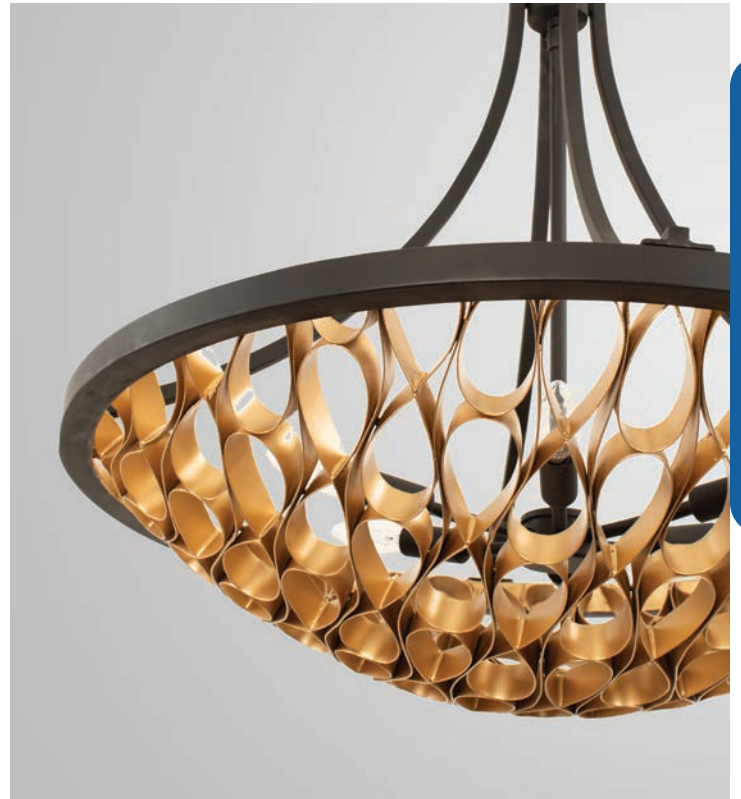

*B.



*C.

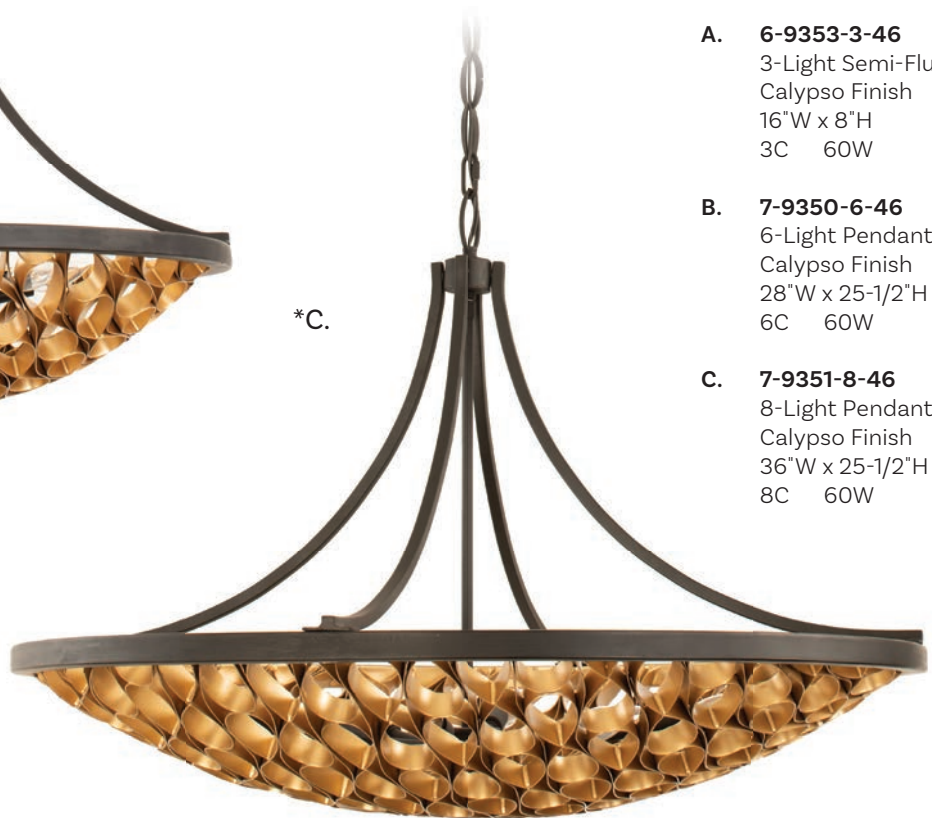

- A. 6-9353-3-46**
3-Light Semi-Flush
Calypso Finish
16"W x 8"H
3C 60W
- B. 7-9350-6-46**
6-Light Pendant
Calypso Finish
28"W x 25-1/2"H
6C 60W
- C. 7-9351-8-46**
8-Light Pendant
Calypso Finish
36"W x 25-1/2"H
8C 60W

VENTURA

CASUAL SOPHISTICATION



Includes 120" chain & 144" wire

VENTURA

CASUAL SOPHISTICATION

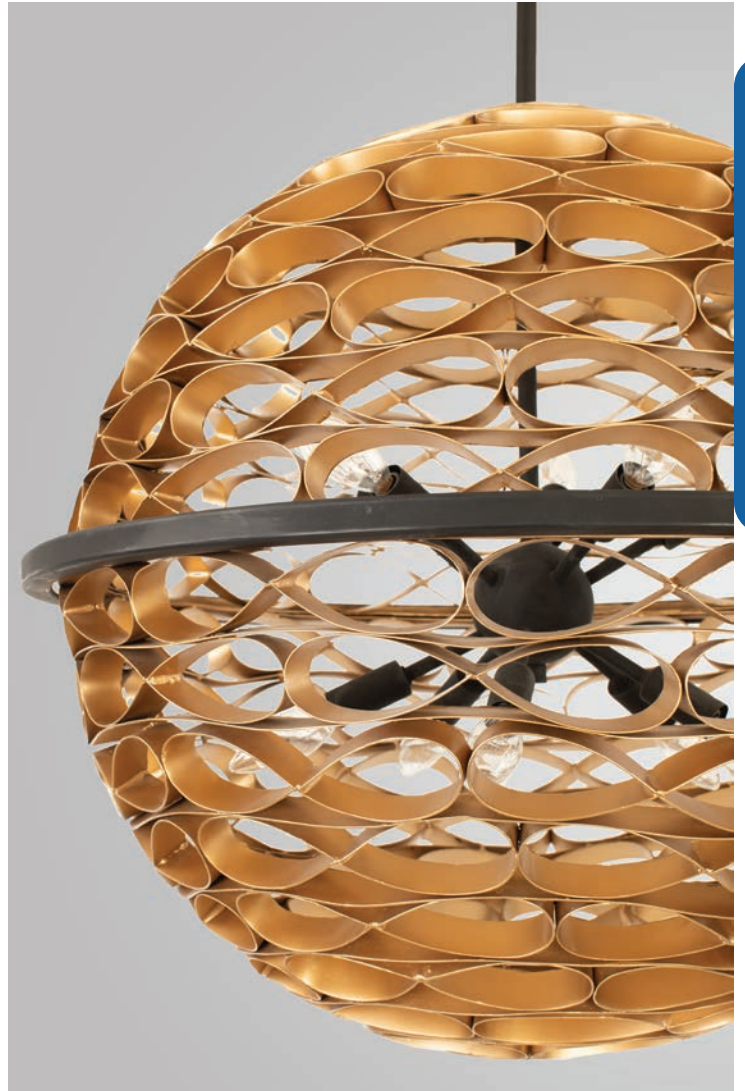

7-9352-10-46
10-Light Orb Pendant
Calypso Finish
26"W x 24-1/4"H
10C 60W

CAMEO

CASUAL SOPHISTICATION



A.

A. 9-1068-1-10
 1-Light Sconce
 Champagne Luxe Finish
 9"W x 21"H x 5"E
 1C 60W
 White Linen Shade

B. 6-1067-4-10
 4-Light Convertible
 Semi-Flush
 Champagne Luxe Finish
 20"W x 8-1/2"H
 Adj H 8-1/2" - 62-1/2"
 4C 60W
 White Linen Shade

C. 7-1066-6-10
 6-Light Pendant
 Champagne Luxe Finish
 28"W x 12-1/2"H
 Adj H 12-1/2" - 66-1/2"
 6C 60W
 White Linen Shade

D. 1-1065-4-10
 4-Light Linear Chandelier
 Champagne Luxe Finish
 44"L x 14"W x 12-1/8" H
 Adj H 12-1/8" - 66-1/8"
 4E 60W
 White Linen Shade

CAMEO

CASUAL SOPHISTICATION

*B.



Convertible Semi-Flush

*C.



*D.



Dual Mount Hanging System

*Includes 12" & 6" extensions - additional stems available - 7-EXTLG

HENDREN

CASUAL SOPHISTICATION



Includes 120" chain & 144" wire

Includes (1) 12" extension - additional stems available - **7-EXTLG**

HENDREN

CASUAL SOPHISTICATION



7-2244-6-10
6-Light Pendant
Champagne Luxe Finish
28"W x 28"H
6C 60W



JOLIET

CASUAL SOPHISTICATION

*A.



*B.

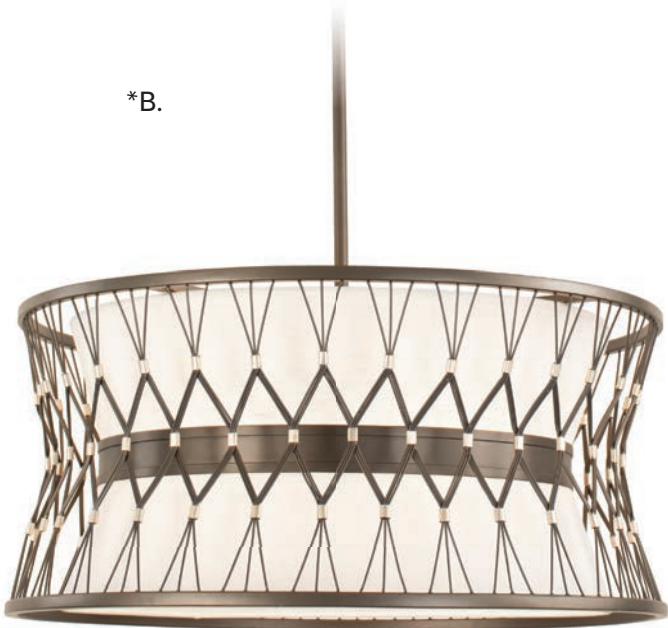

C.



*Includes 12" & 6" extensions - additional stems available - 7-EXTLG

JOLIET

CASUAL SOPHISTICATION



Dual Mount Hanging System

A. 3-8811-6-92
6-Light Lantern
Rumba Finish
16"W x 28"H
Adj H 28" - 82"
6C 60W
White Fabric Shade

B. 7-8810-6-92
6-Light Pendant
Rumba Finish
22"W x 12"H
Adj H 12" - 66"
6C 60W
White Fabric Shade

C. 9-8812-2-92
2-Light Sconce
Rumba Finish
6"W x 14"H x 5-1/4"E
2C 60W
White Fabric Shade

BALI

CASUAL SOPHISTICATION



Includes 12" & 6" extensions - additional stems available - **7-EXTLG**

BALI

CASUAL SOPHISTICATION



Dual Mount Hanging System

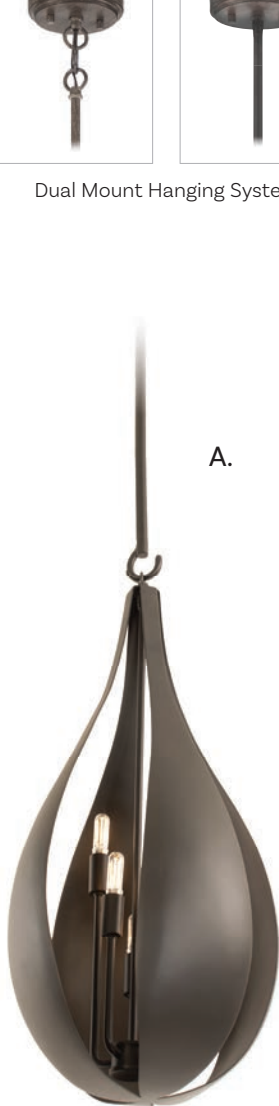

A.



B.

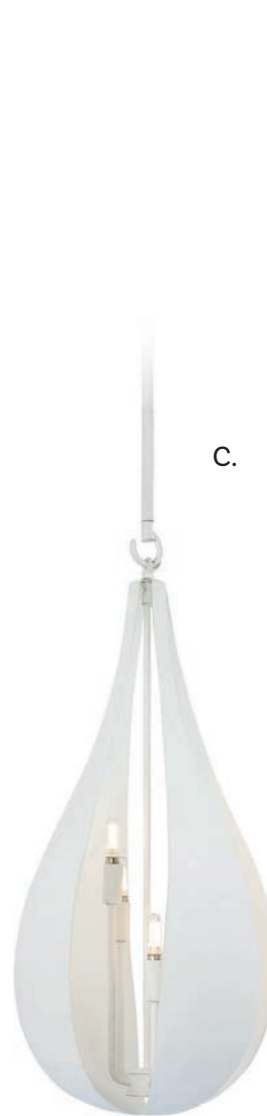

C.



D.

A. 3-4390-5-50
 5-Light Pendant
 Black Cashmere Finish
 12"W x 31"H
 Adj H 31" - 85"
 5C 60W

B. 3-4391-6-50
 6-Light Pendant
 Black Cashmere Finish
 16"W x 36"H
 Adj H 36" - 90"
 6C 60W

C. 3-4390-5-47
 5-Light Pendant
 White Cashmere Finish
 12"W x 31"H
 Adj H 31" - 85"
 5C 60W

D. 3-4391-6-47
 6-Light Pendant
 White Cashmere Finish
 16"W x 36"H
 Adj H 36" - 90"
 6C 60W

BOZEMAN

CASUAL SOPHISTICATION



A. BOZEMAN
1-1838-6-322
6-Light Chandelier
Warm Brass Finish
29"W x 27"H
6E 60W
Seeded Glass
Chocolate Leather

B. CHAUCER
1-1716-8-322
8-Light Chandelier
Warm Brass Finish
30"W x 15"H
Adj H 15" - 69"
8C 60W
Chocolate Leather

C. BOZEMAN
7-1836-4-322
4-Light Pendant
Warm Brass Finish
18"W x 32-1/2"H
4C 60W
Seeded Glass
Chocolate Leather

D. BOZEMAN
7-1837-3-322
3-Light Pendant
Warm Brass Finish
14"W x 25"H
3C 60W
Seeded Glass
Chocolate Leather

BOZEMAN / CHAUCHER

CASUAL SOPHISTICATION

*A.



Dual Mount Hanging System

**B.



*C.



*D.



*Includes 120" chain & 144" wire

**Includes 12" & 6" extensions - additional stems available - 7-EXT

SALEM

CASUAL SOPHISTICATION



*Includes 12" decorative linked stem, plus 120" chain

**Includes 14-1/2" decorative linked stem, plus 120" chain

SALEM

*A.

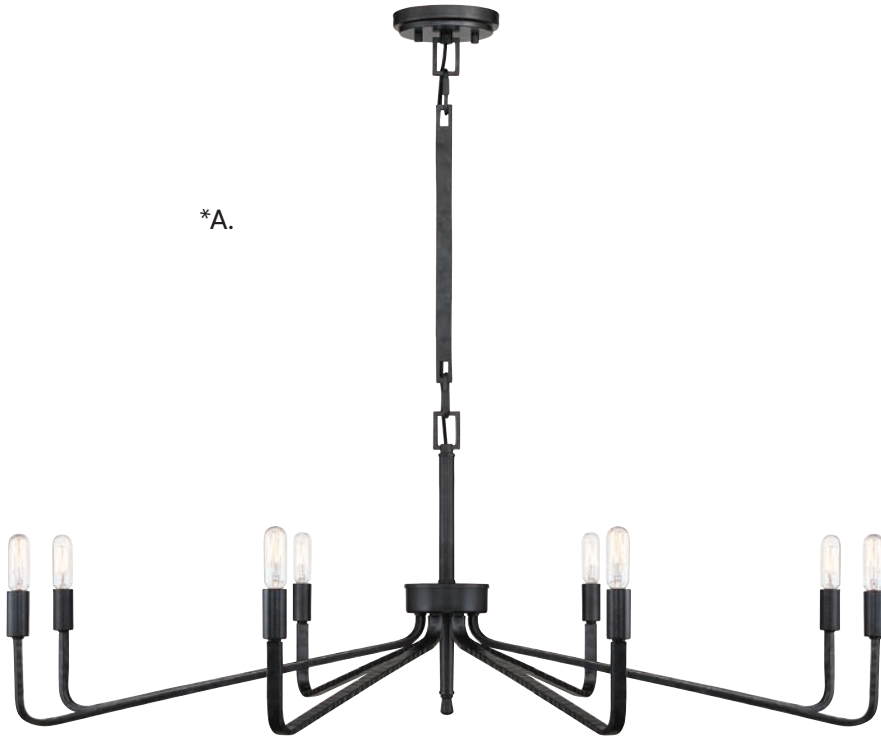

A. 1-6400-8-190
8-Light Chandelier
Forged Iron Finish
40"W x 14"H
8C 60W

B. 1-6402-16-190
16-Light Chandelier
Forged Iron Finish
57"W x 18"H
16C 60W

**B.



LARAMIE

CASUAL SOPHISTICATION



*Includes 12" & 6" extensions - additional stems available - 7-EXT

LARAMIE



Dual Mount Hanging System

A. 1-1099-5-182

5-Light Chandelier
Chelsea Gold Finish
43"W x 12"H
Adj H 12" - 66"
5C 60W
Frosted Crystal



B. 1-1099-5-183

5-Light Chandelier
Chelsea Walnut Finish
43"W x 12"H
Adj H 12" - 66"
5C 60W
Frosted Crystal



Pendant, Page 406

BURGESS / MALLORY

CASUAL SOPHISTICATION



A. BURGESS

1-990-8-41

8-Light Linear Chandelier

Durango Finish

42" L x 5" W x 38-1/4" H

8E 60W

B. MALLORY

7-7406-5-39

5-Light Pendant

Fossil Stone Finish

30" W x 30" H

5C 60W

Wood Beads / Glass Beads



*Includes 120" chain & 144" wire

BURGESS

CASUAL SOPHISTICATION



HASTING

CASUAL SOPHISTICATION



*Includes 12" & 6" extensions - additional stems available - 7-EXT

**Includes 120" chain & 144" wire

HASTING



Dual Mount Hanging System

A. 7-8893-4-101
4-Light Pendant
Noblewood w/ Iron Finish
14"W x 19"H
4C 60W

B. 1-8892-5-101
5-Light Linear Chandelier
Noblewood w/ Iron Finish
42"L x 10"W x 12"H
Adj H 12" - 66"
5E 60W

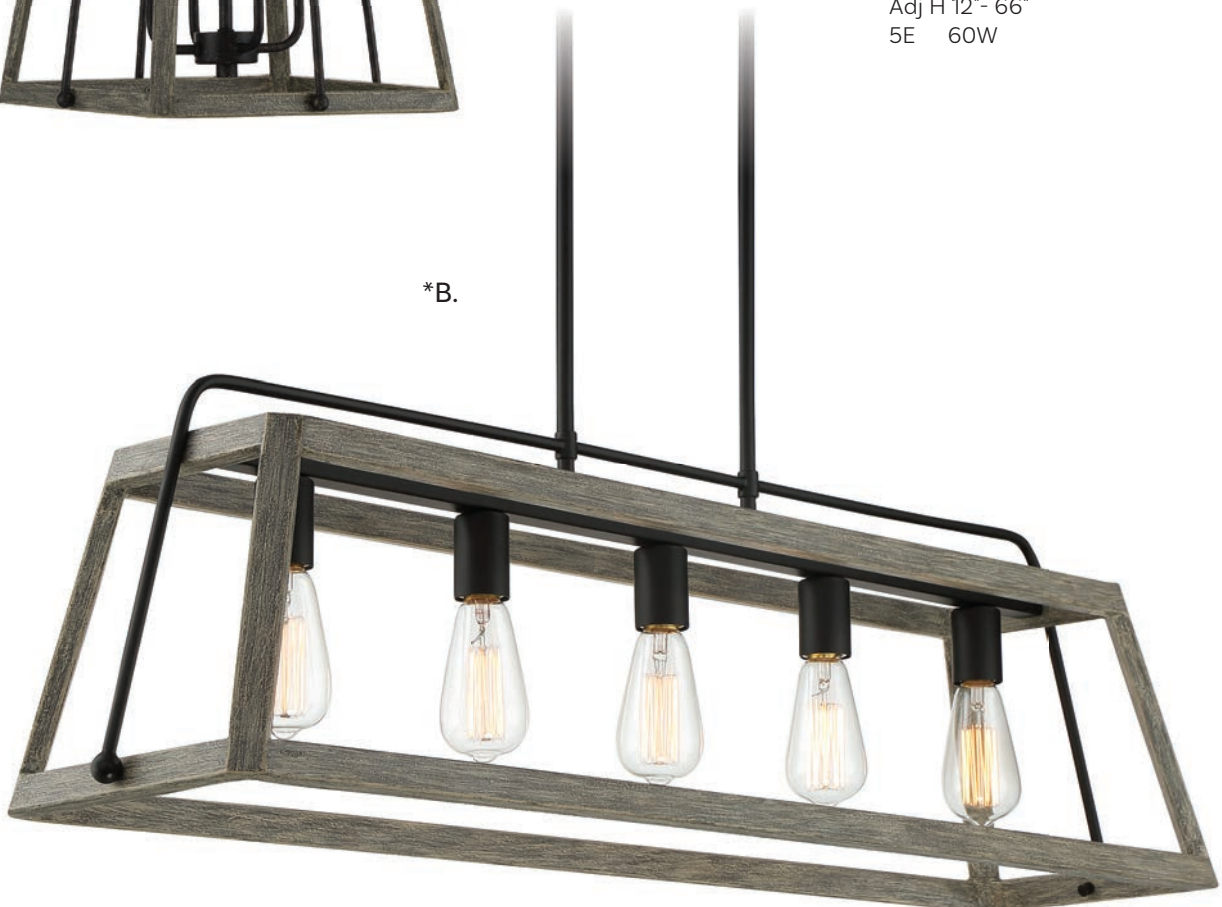

INMAN

CASUAL SOPHISTICATION



1-1130-8-13
8-Light Garden Chandelier
English Bronze Finish
32"W x 27-5/8"H
8E 60W
Clear Glass
UL Damp Rated



Includes 120" chain & 144" wire

EDEN

CASUAL SOPHISTICATION



1-2100-6-70
6-Light Garden Chandelier
Weathervane Finish
29"W x 30-1/2"H
6C 60W
Clear Glass
UL Damp Rated



MARIPOSA

ARCHITECTURAL

1-7504-10-322

10-Light Chandelier

Warm Brass Finish

60"W x 21-1/2"H

Adj H" 21-1/2" - 75-1/2"

10C 60W

Clear Crystal



Includes 12" & 6" extensions - additional stems available - **7-EXTLG**

MARIPOSA

ARCHITECTURAL



LUNA

ARCHITECTURAL



Includes 120" chain & 144" wire

A.



- A. 1-1868-15-89**
15-Light Chandelier
Matte Black Finish
45"W x 54"H
15C 60W
Frosted Crystal

B.



- B. 1-1868-15-322**
15-Light Chandelier
Warm Brass Finish
45"W x 54"H
15C 60W
Clear Crystal

MAYFAIR

ARCHITECTURAL

1-7712-10-195

10-Light Chandelier

Warm Brass w/ Chrome Finish

45"W x 34"H

10C 60W

Clear Acrylic

Clear Crystal



Includes 120" chain & 144" wire

NOUVEL



Dual Mount Hanging System

1-5504-12-322

12-Light Chandelier

Warm Brass Finish

45"W x 34"H

Adj H 34" - 88"

12C 60W

Handmade Strie Glass



Includes 12" & 6" extensions - additional stems available - **7-EXTLG**

KAMERON

ARCHITECTURAL



Dual Mount Hanging System

A. 1-1805-10-109
10-Light Chandelier
Polished Nickel Finish
60-1/2"W x 32"H
Adj H 32" - 86"
10C 60W
Clear Crystal

B. 1-1805-10-322
10-Light Chandelier
Warm Brass Finish
60-1/2"W x 32"H
Adj H 32" - 86"
10C 60W
Clear Crystal

C. 1-1805-10-89
10-Light Chandelier
Matte Black Finish
60-1/2"W x 32"H
Adj H 32" - 86"
10C 60W
Clear Crystal

KAMERON

ARCHITECTURAL

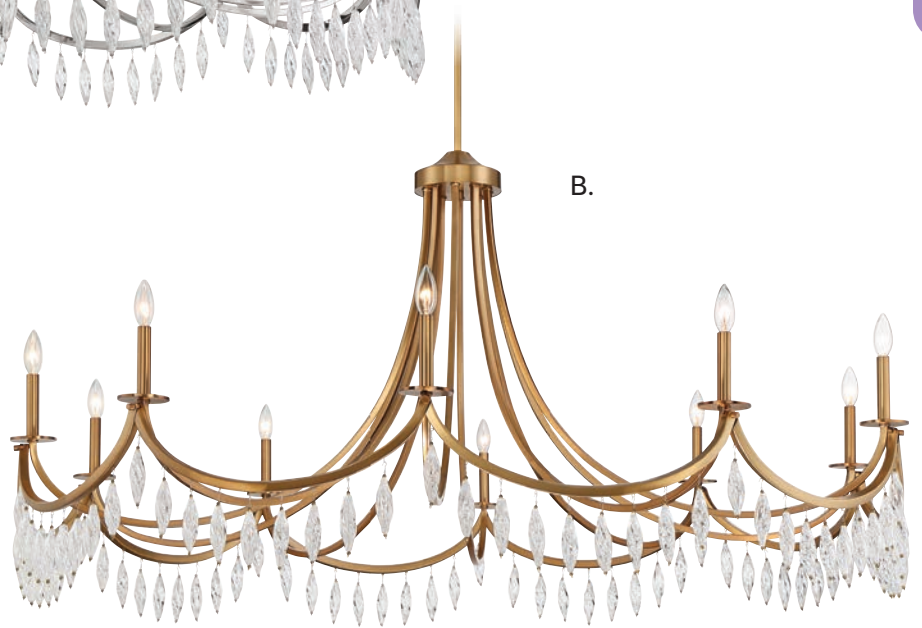
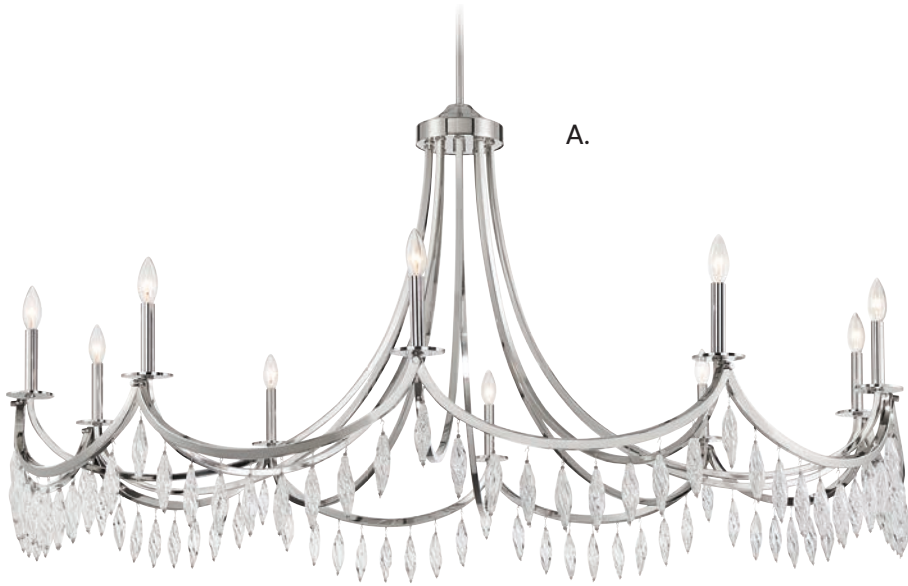

Includes 12" & 6" extensions - additional stems available - 7-EXTLG

SANTIAGO

ARCHITECTURAL

1-1934-12-143
12-Light Chandelier
Matte Black w/ Warm Brass
45"W x 41"H
12E 60W
Clear Crystal



Includes 120" chain & 144" wire

DRYDEN

ARCHITECTURAL

1-1938-36-89
36-Light Chandelier
Matte Black Finish
60"W x 52"H
4W Integrated
Dimmable LED
400 Lumens,
3000K, 90+ CRI
Clear Crystal
LED G9 Bulbs Included

LED



ARLON

ARCHITECTURAL

1-1734-24-322
24-Light Chandelier
Warm Brass Finish
44"W x 36"H
Adj H 36" - 90"
2.5W Integrated Dimmable LED
1950 Lumens, 3000K, 90+CRI
Bubble Glass

LED



Dual Mount Hanging System



Includes 12" & 6" extensions - additional stems available - **7-EXT**

DEL MAR

1-2507-8-322

8-Light Chandelier

Warm Brass Finish

48"W x 11-1/4"H

Adj H 11-1/4"H - 65-1/4"

5W Integrated Dimmable LED

2320 Lumens, 3000K, 90+ CRI

Clear Seeded Acrylic

LED



Dual Mount Hanging System

ARCHITECTURAL

Includes 12" & 6" extensions - additional stems available - **7-EXTLG**

LANDON

ARCHITECTURAL



Dual Mount Hanging System

7-1622-117-322

LED Pendant

Warm Brass Finish

45"W x 29"H

Adj H 29" - 83"

117W Integrated Dimmable LED

3900 Lumens, 3000K, 90+ CRI

Natural Calcite Elements

LED



Includes 12" & 6" extensions - additional stems available - **7-EXTLG**

LANDON

ARCHITECTURAL



BENNINGTON

ARCHITECTURAL

1-9705-16-322
16-Light Chandelier
Warm Brass Finish
45"W x 24"H
Adj H 24" - 78"
16C 60W
Clear Ribbed Glass



Includes 12" & 6" extensions - additional stems available - **7-EXTLG**

1-5186-12-59
12-Light Chandelier
French Gold w/
Cashmere White Finish
52-1/2"W x 32"H
12C 60W



Includes 120" chain & 144" wire

PRESERVE

ARCHITECTURAL



Includes 12" & 6" extensions - additional stems available - 7-EXT



Dual Mount Hanging System

A. 1-6415-8-322
8-Light Chandelier
Warm Brass Finish
50"W x 30"H
Adj H 30" - 84"
8C 60W

B. 1-6415-8-89
8-Light Chandelier
Matte Black Finish
50"W x 30"H
Adj H 30" - 84"
8C 60W



DIRECTOR

ARCHITECTURAL



Includes 120" chain & 144" wire

A. 1-1672-12-322

12-Light Chandelier
Warm Brass Finish
50"W x 51"H
12C 60W
Natural Stone Candle Covers



B. 1-1672-12-89

12-Light Chandelier
Matte Black Finish
50"W x 51"H
12C 60W
Natural Stone Candle Covers



SHIELDS

ARCHITECTURAL



SHIELDS

ARCHITECTURAL

1-9084-12-13
12-Light Chandelier
English Bronze Finish
48"W x 50-1/2"H
12C 60W



Includes 120" chain & 144" wire

SALEM

ARCHITECTURAL

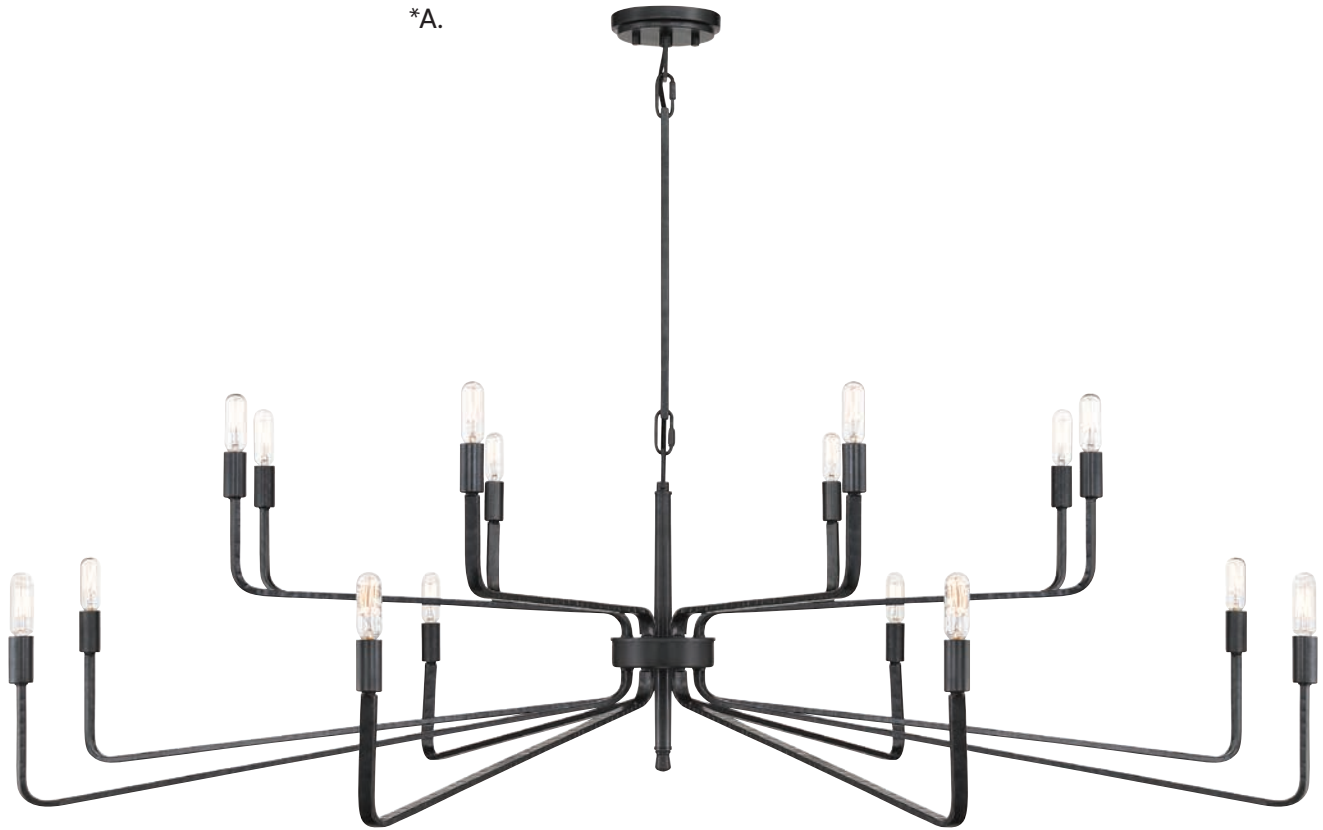

A. 1-6402-16-190
16-Light Chandelier
Forged Iron Finish
57"W x 18"H
16C 60W
Metal Candle Covers

*Includes 14-1/2" decorative linked stem, plus 120" chain

CALGARY



Dual Mount Hanging System



**B.

B. 1-4570-8-89

8-Light Chandelier
Matte Black Finish
48"W x 26-1/2"H
Adj H 26-1/2" - 80-1/2"
8C 60W
Clear Hammered Glass

**Includes 12" & 6" extensions - additional stems available - 7-EXTLG

BAKER

ARCHITECTURAL



Dual Mount Hanging System



Includes 12" & 6" extensions - additional stems available - **7-EXT**

BAKER

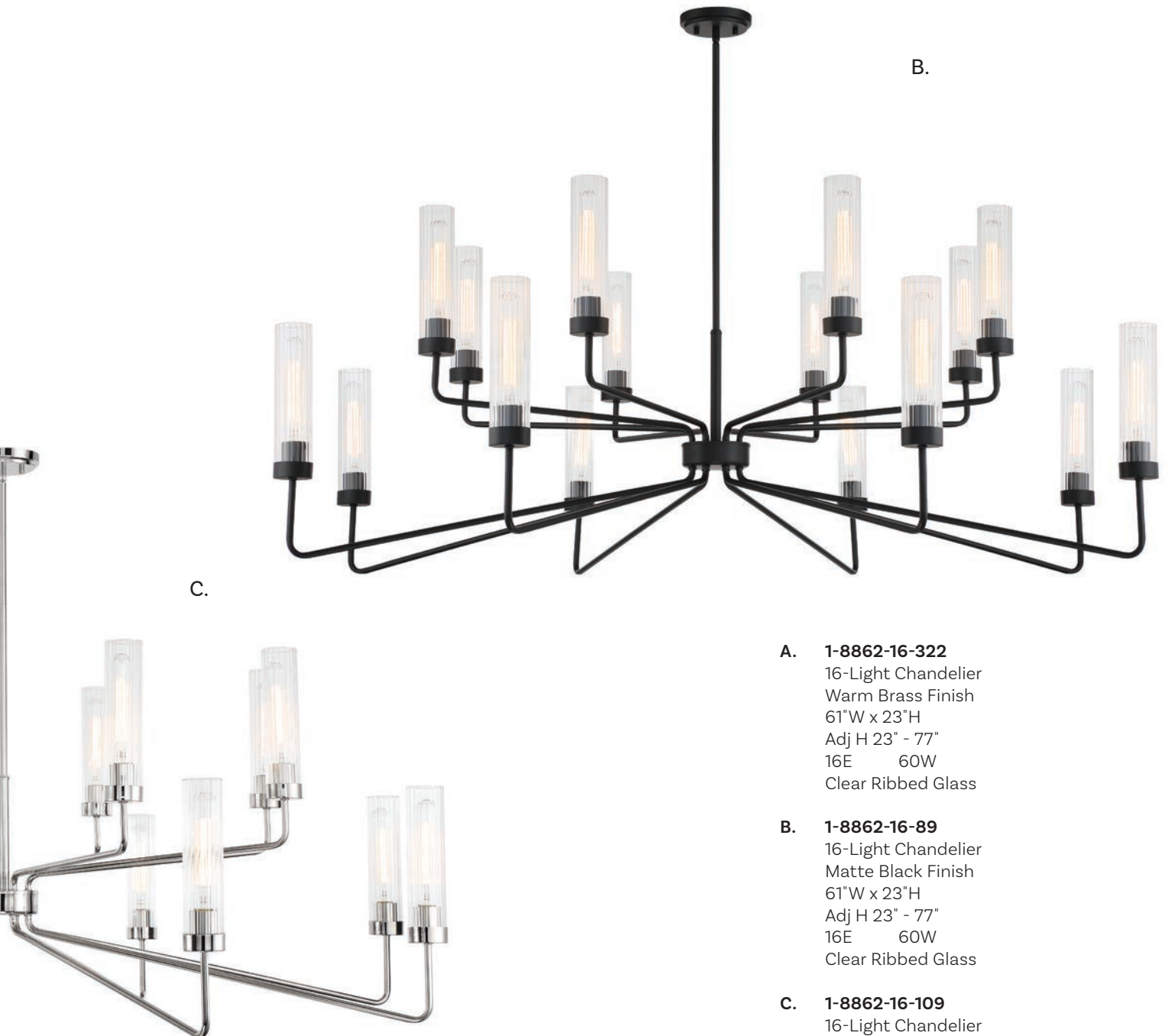

B.

C.

A. 1-8862-16-322
16-Light Chandelier
Warm Brass Finish
61"W x 23"H
Adj H 23" - 77"
16E 60W
Clear Ribbed Glass

B. 1-8862-16-89
16-Light Chandelier
Matte Black Finish
61"W x 23"H
Adj H 23" - 77"
16E 60W
Clear Ribbed Glass

C. 1-8862-16-109
16-Light Chandelier
Polished Nickel Finish
61"W x 23"H
Adj H 23" - 77"
16E 60W
Clear Ribbed Glass

VISTA

ARCHITECTURAL

A.



B.



Includes 12" & 6" extensions - additional stems available - **7-EXTLG**



Dual Mount Hanging System

A. 1-1800-16-171
 16-Light Chandelier
 Burnished Brass Finish
 60"W x 15-1/2"H
 Adj H 15-1/2" - 69-1/2"
 16E 60W
 Clear Glass

B. 1-1800-16-89
 16-Light Chandelier
 Matte Black Finish
 60"W x 15-1/2"H
 Adj H 15-1/2" - 69-1/2"
 16E 60W
 Clear Glass

DEANDRE

ARCHITECTURAL



DEANDRE

ARCHITECTURAL



1-1943-10-89
10-Light Chandelier
Matte Black Finish
45"W x 38"H
10E 60W
Clear Water Glass

Includes 120" chain & 144" wire

RADCLIFFE

ARCHITECTURAL



RADCLIFFE

ARCHITECTURAL

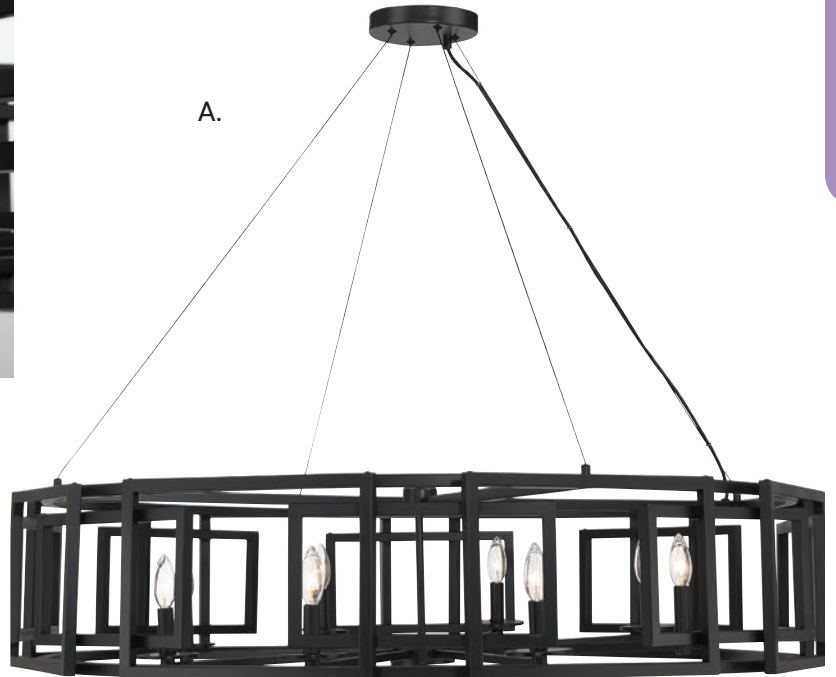

A.



B.

A. 1-1675-8-89
8-Light Chandelier
Matte Black Finish
45"W x 10"H
Adj H 10" - 130"
8C 60W

B. 1-1675-8-171
8-Light Chandelier
Burnished Brass Finish
45"W x 10"H
Adj H 10" - 130"
8C 60W

Includes 120" of cable

ORION

ARCHITECTURAL



1-1932-15-322
15-Light Chandelier
Warm Brass Finish
45"W x 37"H
15C 60W
Clear Glass

Includes 120" chain & 144" wire



KILLIAM

PENDANTS / LANTERNS



Includes 12" & 6" extensions - additional stems available - **7-EXTLG**

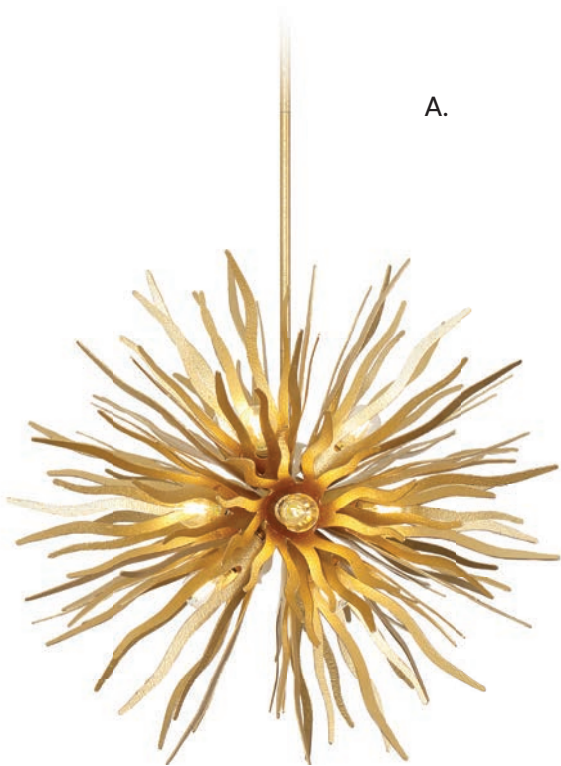

A.

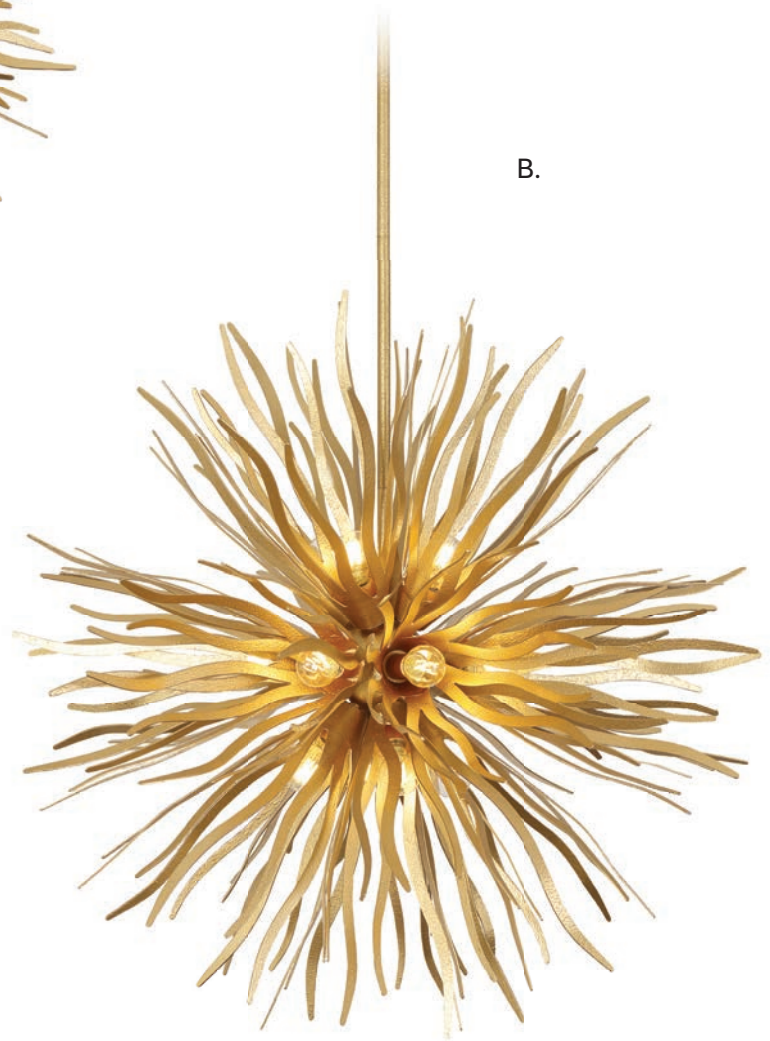

B.



Dual Mount Hanging System

- A. 7-1957-12-37**
12-Light Pendant
Cavalier Gold Finish
28"W x 28"H
Adj H 28" - 82"
12C 60W

- B. 7-1956-16-37**
16-Light Pendant
Cavalier Gold Finish
36"W x 36"H
Adj H 36" - 90"
16C 60W

BREWSTER

PENDANTS / LANTERNS



Includes 12" & 6" extensions - additional stems available - **7-EXTLG**

BREWSTER

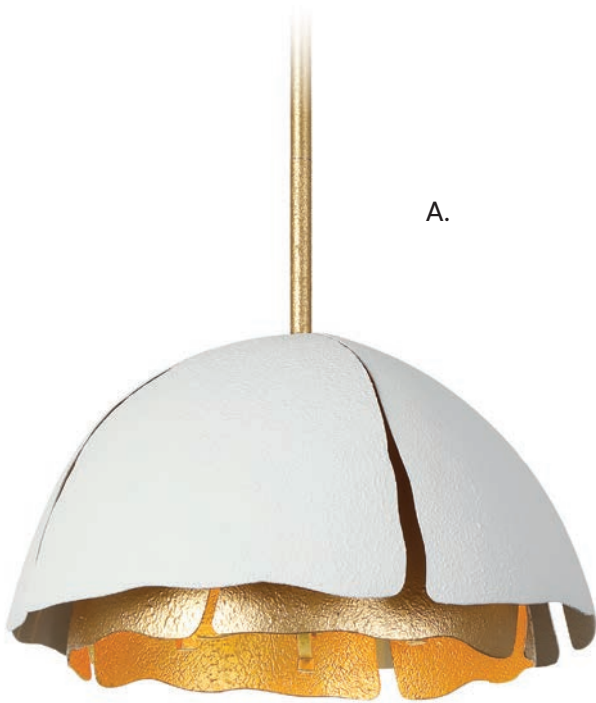

A.



Dual Mount Hanging System

- A. 7-1398-3-14**
3-Light Pendant
Cavalier Gold w/ Royal
White Finish
16"W x 9-1/4"H
Adj H 9-1/4" - 63-1/4"
3C 60W

- B. 7-1399-5-14**
5-Light Pendant
Cavalier Gold w/ Royal
White Finish
26"W x 14-1/2"H
Adj H 14-1/2" - 68-1/2"
5C 60W



B.

SHELBY

PENDANTS / LANTERNS



Includes 120" chain & 144" wire

A.

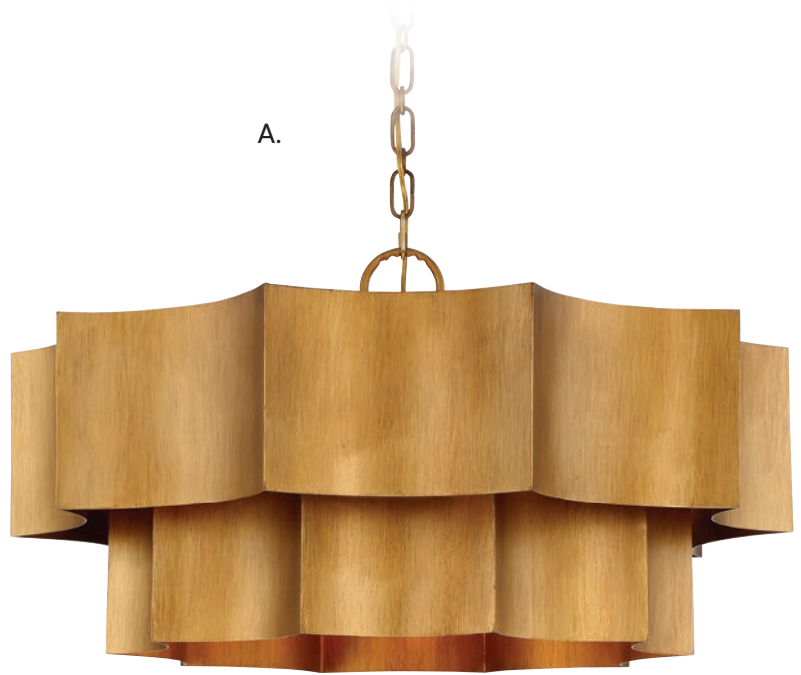

B.

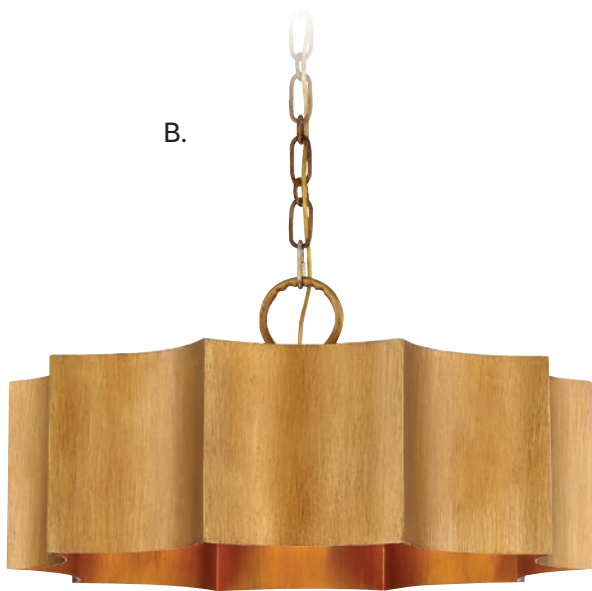

A. 7-101-6-54

6-Light Pendant
Gold Patina Finish
30"W x 16"H
6E 60W

B. 7-100-3-54

3-Light Pendant
Gold Patina Finish
22-1/2"W x 11-1/2"H
3E 60W

ROCHESTER

PENDANTS / LANTERNS



Includes 120" chain & 144" wire

ROCHESTER

A.

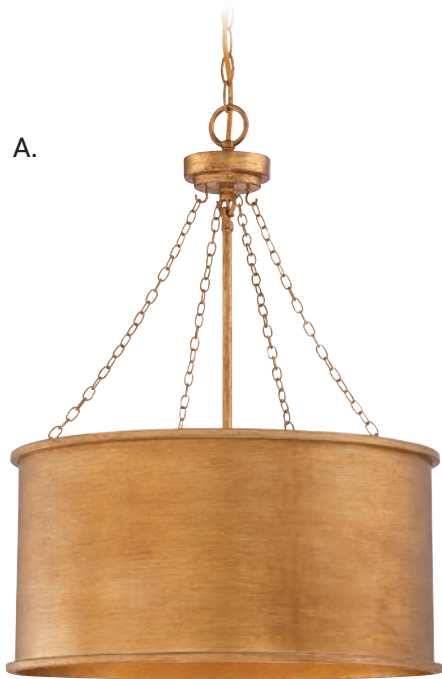

B.

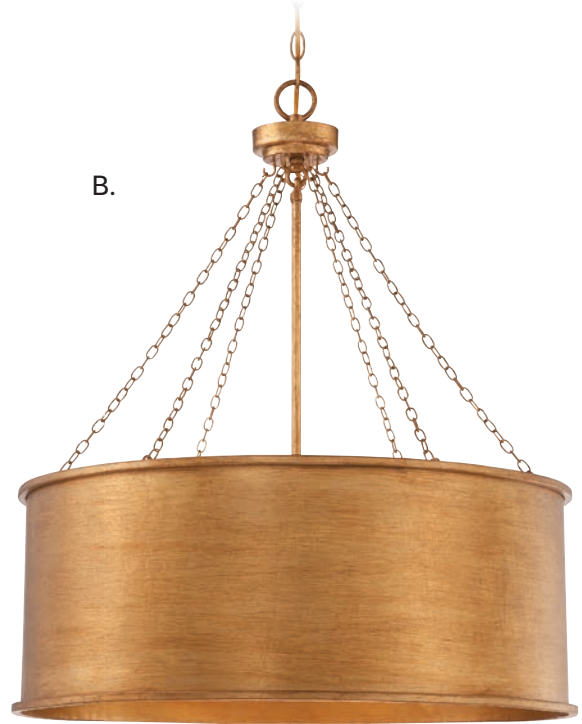

C.



D.



A. 7-487-4-54
4-Light Pendant
Gold Patina Finish
19"W x 26-1/2"H
4E 60W

B. 7-488-6-54
6-Light Pendant
Gold Patina Finish
25"W x 29"H
6E 60W

C. 7-488-6-53
6-Light Pendant
Silver Patina Finish
25"W x 29"H
6E 60W

D. 7-487-4-53
4-Light Pendant
Silver Patina Finish
19"W x 26-1/2"H
4E 60W

SOMMERTON

PENDANTS / LANTERNS



SOMMERTON

A.

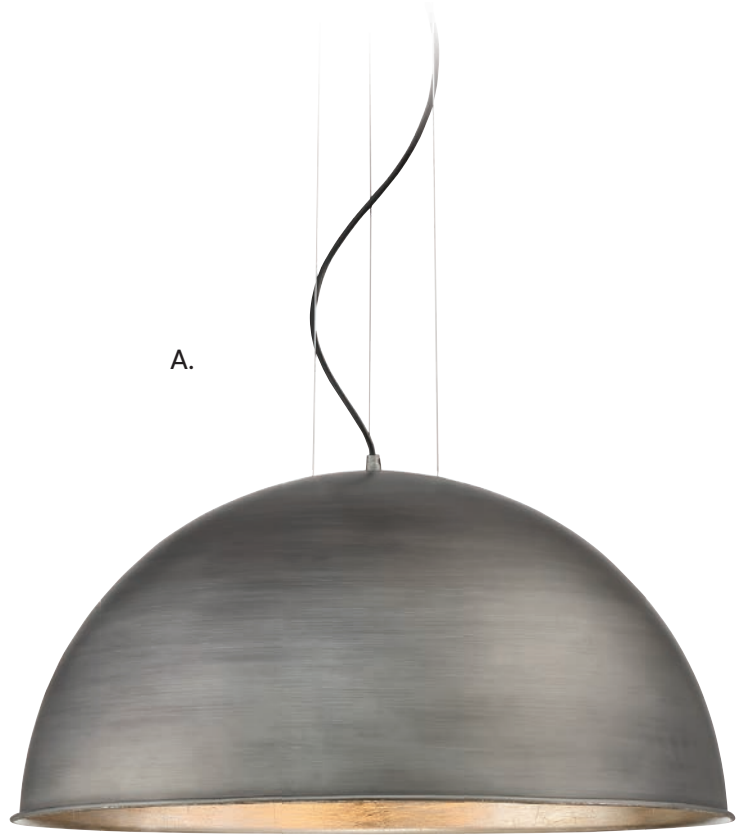

B.



A. 7-5014-3-85

3-Light Pendant
Rubbed Zinc w/
Silver Leaf Finish
24"W x 15"H
3E 60W

B. 7-5014-3-84

3-Light Pendant
Rubbed Bronze w/
Gold Leaf Finish
24"W x 15"H
3E 60W

Includes 120" lamp cord

LARAMIE

PENDANTS / LANTERNS

A.



B.



C.



D.



A. 7-885-1-182

1-Light Pendant
Chelsea Gold Finish
18"W x 13"H
1E 60W

B. 7-885-1-183

1-Light Pendant
Chelsea Walnut Finish
18"W x 13"H
1E 60W

C. 7-886-3-182

3-Light Pendant
Chelsea Gold Finish
23"W x 16"H
3E 60W

D. 7-886-3-183

3-Light Pendant
Chelsea Walnut Finish
23"W x 16"H
3E 60W



Chandelier, Page 355

LARAMIE

PENDANTS / LANTERNS



Includes 120" chain & 144" wire

TARTAN

PENDANTS / LANTERNS



Includes 120" chain & 144" wire

SENECA

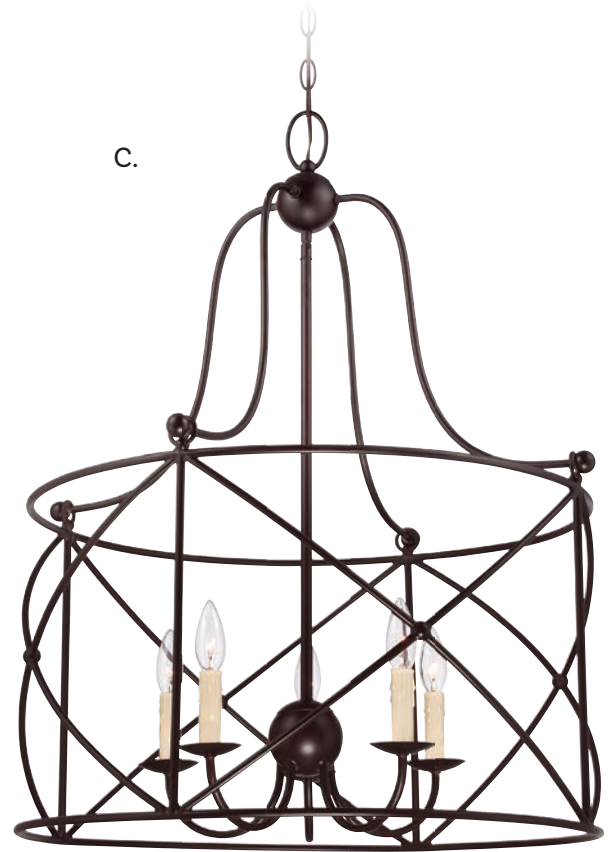

C.

- A. 7-9009-5-28**
5-Light Pendant
Oiled Burnished Bronze Finish
28"W x 34"H
5E 60W
Mercury Glass
- B. 7-9008-4-28**
4-Light Pendant
Oiled Burnished Bronze Finish
20-3/8"W x 25-3/8"H
4E 60W
Mercury Glass
- C. 1-4072-5-13**
5-Light Pendant
English Bronze Finish
25-1/2"W x 32-3/8"H
5C 60W

KIAN

PENDANTS / LANTERNS



*A.

- A. KIAN**
7-1920-3-261
3-Light Pendant
Matte Black w/ True Gold
22"W x 26"H
3E 60W
White Fabric Shade



*Includes 120" chain & 144" wire

Includes 12" & 6" extensions - additional stems available - **7-EXT

PEARL / KELVIN

*B.



**C.



Dual Mount Hanging System

B. PEARL
7-1872-3-322
3-Light Pendant
Warm Brass Finish
21"W x 24"H
3C 60W
Mercury Glass

B. KELVIN
7-1927-6-143
6-Light Pendant
Matte Black w/ Warm Brass
20"W x 16"H
Adj H 16" - 70"
6C 60W

DELPHI

PENDANTS / LANTERNS



Includes 120" chain & 144" wire

A.



- A. 7-188-6-172**
6-Light Pendant
White w/ Polished Nickel
19"W x 25"H
6C 60W
Metal Shade

B.



- B. 7-188-6-143**
6-Light Pendant
Matte Black w/ Warm Brass
19"W x 25"H
6C 60W
Metal Shade

GAVIN

PENDANTS / LANTERNS



Sconce, Page 547



Ceiling, Page 667

*Includes 12" & 6" extensions - additional stems available - **7-EXTLG**

Includes 12" & 6" extensions - additional stems available - **7-EXT

GAVIN / LAMAR



*A.

*B.

**C.

**D.



Dual Mount Hanging System

A. 7-1690-1-143
 1-Light Pendant
 Matte Black w/
 Warm Brass Finish
 20"W x 8"H
 Adj H 8" - 62"
 1E 60W
 White Opal Glass

B. 7-1690-1-142
 1-Light Pendant
 White w/ Warm Brass Finish
 20"W x 8"H
 Adj H 8" - 62"
 1E 60W
 White Opal Glass

C. 7-2416-3-160
 3-Light Pendant
 White w/ Warm Brass Finish
 18"W x 11"H
 Adj H 11"x 65"
 3E 60W
 30° Swivel

D. 7-2416-3-143
 3-Light Pendant
 Matte Black w/
 Warm Brass Finish
 18"W x 11"H
 Adj H 11"x 65"
 3E 60W
 30° Swivel

CARLYSLE

PENDANTS / LANTERNS



A. 6-4602-1-143

1-Light Flush Mount
Matte Black w/
Warm Brass Finish
15"W x 14-1/4"H
1E 60W
White Opal Glass

B. 6-4602-1-142

1-Light Flush Mount
White w/
Warm Brass Finish
15"W x 14-1/4"H
1E 60W
White Opal Glass

C. 7-4600-1-143

1-Light Pendant
Matte Black w/
Warm Brass Finish
15"W x 17"H
Adj H 17" - 71"
1E 60W
White Opal Glass

D. 7-4600-1-142

1-Light Pendant
White w/
Warm Brass Finish
15"W x 17"H
Adj H 17" - 71"
1E 60W
White Opal Glass

CARLYSLE



A.



B.



Dual Mount Hanging System



*C.



*D.

*Includes 12" & 6" extensions - additional stems available - 7-EXT

CORNING

PENDANTS / LANTERNS



Includes (2) 10" decorative linked stems, plus 120" chain & wire

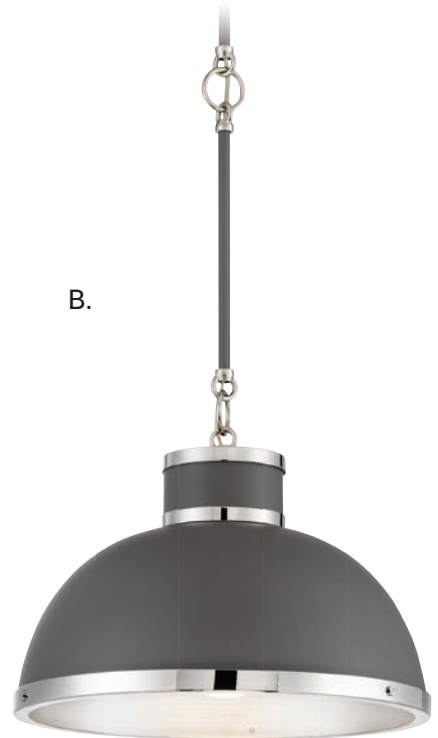
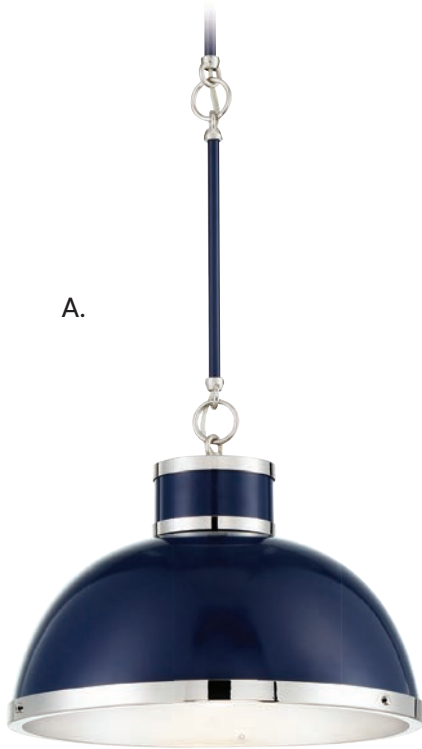

A. 7-8882-1-174
1-Light Pendant
Navy Blue w/ Polished Nickel
16"W x 11"H
1E 60W

B. 7-8882-1-175
1-Light Pendant
Gray w/ Polished Nickel
16"W x 11"H
1E 60W

C. 7-8882-1-173
1-Light Pendant
Black w/ Polished Nickel
16"W x 11"H
1E 60W



Sconce, Page 547

BOWDIN

PENDANTS / LANTERNS



Includes 12" & 6" extensions - additional stems available - **7-EXT**

BOWDIN



Dual Mount Hanging System

A. 7-7639-1-322
 1-Light Pendant
 Warm Brass Finish
 24"W x 11-1/4"H
 Adj H 11-1/4" - 65-1/4"
 1E 60W

B. 7-7639-1-89
 1-Light Pendant
 Matte Black Finish
 24"W x 11-1/4"H
 Adj H 11-1/4" - 65-1/4"
 1E 60W

C. 7-7639-1-11
 1-Light Pendant
 Polished Chrome
 Finish
 24"W x 11-1/4"H
 Adj H 11-1/4" - 65-1/4"
 1E 60W

D. 7-7639-1-83
 1-Light Pendant
 Bisque White
 Finish
 24"W x 11-1/4"H
 Adj H 11-1/4" - 65-1/4"
 1E 60W

SEAGRAM

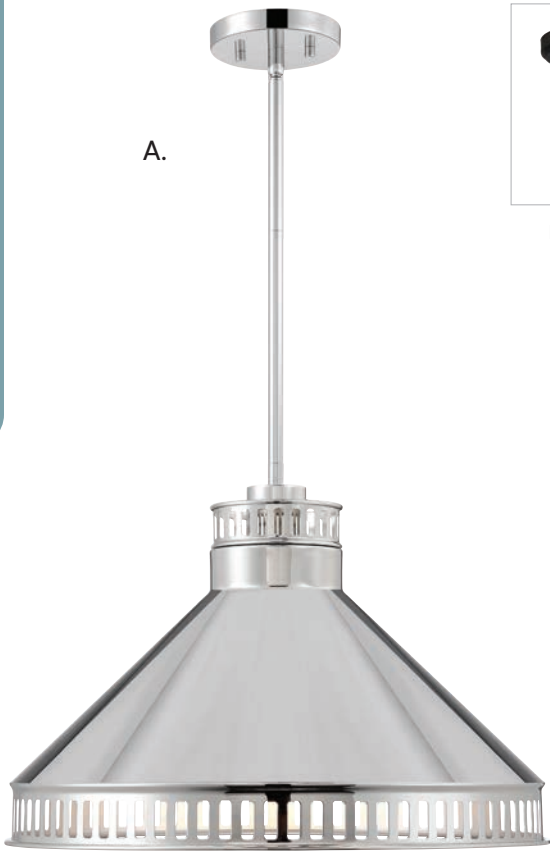

A.



Dual Mount Hanging System

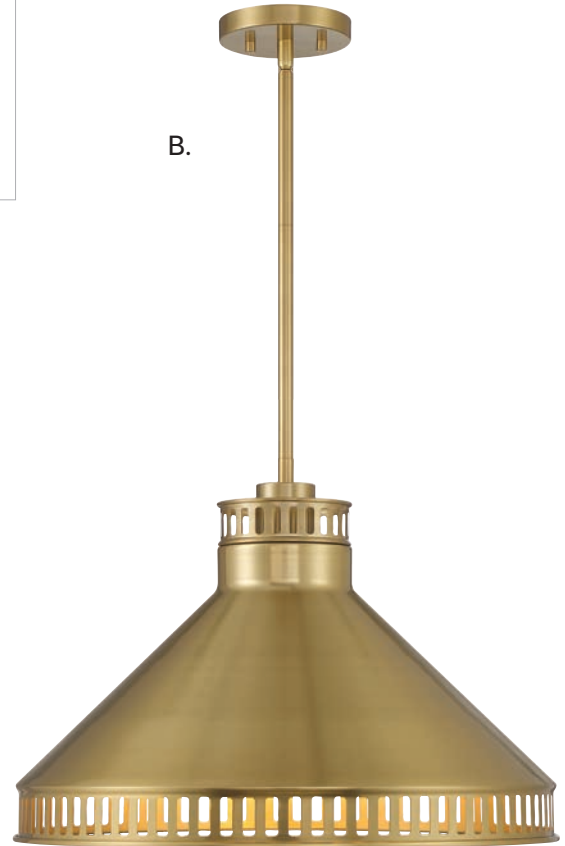

B.



C.

A. 7-8801-3-109
3-Light Pendant
Polished Nickel Finish
20"W x 14"H
Adj. H 14" - 68"
3E 60W
Metal Shade

B. 7-8801-3-322
3-Light Pendant
Warm Brass Finish
20"W x 14"H
Adj. H 14" - 68"
3E 60W
Metal Shade

C. 7-8801-3-89
3-Light Pendant
Matte Black Finish
20"W x 14"H
Adj. H 14" - 68"
3E 60W
Metal Shade

SEAGRAM

PENDANTS / LANTERNS



Includes 12" & 6" extensions - additional stems available - 7-EXTLG

ALDEN

PENDANTS / LANTERNS



Includes (2) sections of 9-1/2" decorative linked stems, plus 120" chain & wire.

A. 7-232-1-109

1-Light Pendant
Polished Nickel Finish
12"W x 8-1/2"H
Adj H 8-1/2" - 30"
1E 60W



B.

B. 7-232-1-323

1-Light Pendant
Old Bronze Finish
12"W x 8-1/2"H
Adj H 8-1/2" - 30"
1E 60W

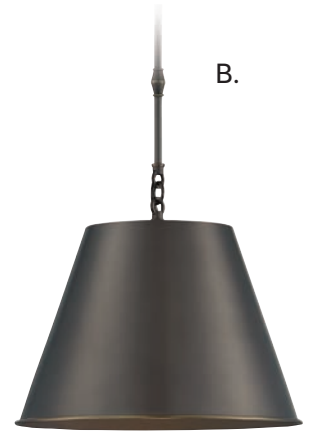

C. 7-231-1-109

1-Light Pendant
Polished Nickel Finish
18-1/4"W x 12-1/2"H
Adj H 12-1/2" - 33-3/4"
1E 60W



D.

D. 7-231-1-323

1-Light Pendant
Old Bronze Finish
18-1/4"W x 12-1/2"H
Adj H 12-1/2" - 33-3/4"
1E 60W



E. 7-232-1-322

1-Light Pendant
Warm Brass Finish
12"W x 8-1/2"H
Adj H 8-1/2" - 30"
1E 60W



E.

F.

F. 7-232-1-89

1-Light Pendant
Matte Black Finish
12"W x 8-1/2"H
Adj H 8-1/2" - 30"
1E 60W



G. 7-231-1-322

1-Light Pendant
Warm Brass Finish
18-1/4"W x 12-1/2"H
Adj H 12-1/2" - 33-3/4"
1E 60W



G.

H.

H. 7-231-1-89

1-Light Pendant
Matte Black Finish
18-1/4"W x 12-1/2"H
Adj H 12-1/2" - 33-3/4"
1E 60W



WILLIS

A.



Dual Mount Hanging System

B.



C.



A. 7-4499-1-322
1-Light Pendant
Warm Brass Finish
14"W x 15-1/2"H
Adj. H 15-1/2" - 69-1/2"
1E 60W
Metal Shade

B. 7-4499-1-109
1-Light Pendant
Polished Nickel Finish
14"W x 15-1/2"H
Adj. H 15-1/2" - 69-1/2"
1E 60W
Metal Shade

C. 7-4499-1-89
1-Light Pendant
Matte Black Finish
14"W x 15-1/2"H
Adj. H 15-1/2" - 69-1/2"
1E 60W
Metal Shade

WILLIS

PENDANTS / LANTERNS



Includes 12" & 6" extensions - additional stems available - **7-EXT**

BERG

PENDANTS / LANTERNS



*Includes 9-1/2" extensions - additional stems available - 7-EXT

A.



B.

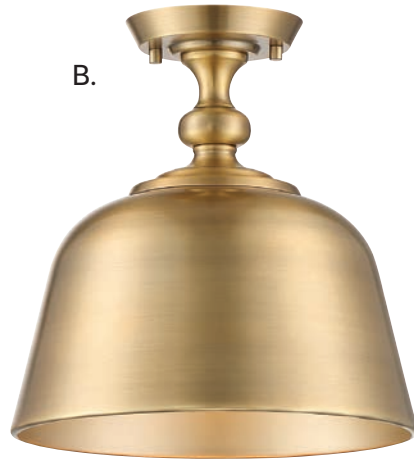

*C.



*D.

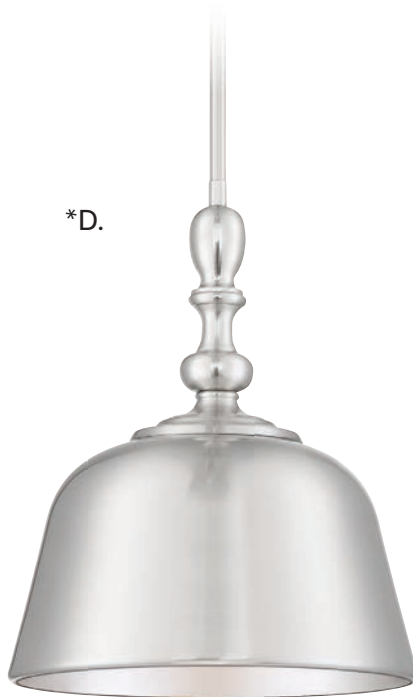

*E.



A. 6-3750-1-89

1-Light Semi-Flush
Matte Black Finish
12"W x 12"H
1E 60W

B. 6-3750-1-322

1-Light Semi-Flush
Warm Brass Finish
12"W x 12"H
1E 60W

C. 7-3751-1-89

1-Light Pendant
Matte Black Finish
12"W x 14"H
Adj H 14" - 45-1/2"
1E 60W
90° Swivel

D. 7-3751-1-SN

1-Light Pendant
Satin Nickel Finish
12"W x 14"H
Adj H 14" - 45-1/2"
1E 60W
90° Swivel

E. 7-3751-1-322

1-Light Pendant
Warm Brass Finish
12"W x 14"H
Adj H 14" - 45-1/2"
1E 60W
90° Swivel

ASHMONT

PENDANTS / LANTERNS



Includes 9-1/2" extensions - additional stems available - 7-EXT

ASHMONT / CHIVAL

A.



C.



B.



D.



A. ASHMONT
7-130-1-63
1-Light Pendant
Warm Brass Lustre Finish
13"W x 21-1/4"H
Adj H 21-1/4" - 49-3/4"
1E 60W
White Opal Glass

B. ASHMONT
7-130-1-SN
1-Light Pendant
Satin Nickel Finish
13"W x 21-1/4"H
Adj H 21-1/4" - 49-3/4"
1E 60W
White Opal Glass

C. ASHMONT
7-130-1-44
1-Light Pendant
Classic Bronze Finish
13"W x 21-1/4"H
Adj H 21-1/4" - 49-3/4"
1E 60W
White Opal Glass

D. CHIVAL
7-730-1-109
1-Light Pendant
Polished Nickel Finish
11"W x 17"H
Adj H 17" - 48-1/2"
1E 60W
White Opal Etched Glass

CHARTWELL

PENDANTS / LANTERNS



Includes 12" & 6" extensions - additional stems available - 7-EXT

CHARTWELL

A.



Dual Mount Hanging System

B.



A. 7-6304-4-89

4-Light Pendant
Matte Black Finish
16-3/4"W x 22-1/2"H
Adj 22-1/2" - 76-1/2"
4C 60W
White Fabric Shade

B. 7-6304-4-322

4-Light Pendant
Warm Brass Finish
16-3/4"W x 22-1/2"H
Adj 22-1/2" - 76-1/2"
4C 60W
White Fabric Shade

MANSFIELD

PENDANTS / LANTERNS

A.



B.



C.



Includes 120" chain & 144" wire

MANSFIELD

PENDANTS / LANTERNS



A. 7-1875-3-13
3-Light Pendant
English Bronze Finish
18"W x 21"H
3E 60W
White Fabric Shade

B. 7-1875-3-322
3-Light Pendant
Warm Brass Finish
18"W x 21"H
3E 60W
White Fabric Shade

C. 7-1875-3-89
3-Light Pendant
Matte Black Finish
18"W x 21"H
3E 60W
White Fabric Shade

AUSTIN

PENDANTS / LANTERNS



Includes 120" chain & 144" wire



A.

A. 7-2201-4-13
4-Light Pendant
English Bronze Finish
18"W x 32-1/2"H
4C 60W
White Fabric Shade



C.

B. 7-2201-4-322
4-Light Pendant
Warm Brass Finish
18"W x 32-1/2"H
4C 60W
White Fabric Shade



B.

C. 7-2201-4-SN
4-Light Pendant
Satin Nickel Finish
18"W x 32-1/2"H
4C 60W
White Fabric Shade

PENDANTS

PENDANTS / LANTERNS



Dual Mount Hanging System

A. GIDEON
7-3168-3-322
 3-Light Pendant
 Warm Brass Finish
 16"W x 17-1/2"H
 Adj H 17-1/2" - 71-1/2"
 3C 60W
 Capiz Shell

C. ASTER
7-3398-1-322
 1-Light Pendant
 Warm Brass Finish
 16"W x 14-3/4"H
 Adj H 14-3/4" - 68-3/4"
 1E 60W
 White Vegan Leather

E. BENNINGTON
7-9703-2-322
 2-Light Pendant
 Warm Brass Finish
 8-3/4"W x 22"H
 Adj H 22" - 76"
 2C 60W
 Clear Ribbed Glass

PENDANTS

PENDANTS / LANTERNS



*Includes 12" & 6" extensions - additional stems available - **7-EXTLG**

Includes 12" & 6" extensions - additional stems available - **7-EXT

BRISTOL

PENDANTS / LANTERNS



Includes 12" & 6" extensions - additional stems available - **7-EXT**

BRISTOL

PENDANTS / LANTERNS

A.



B.



C.



Dual Mount Hanging System

A. 7-8840-1-89

1-Light Pendant
Matte Black Finish
9"W x 15"H
Adj H 15" - 69"
1E 60W
Fluted White Opal Glass

B. 7-8840-1-SN

1-Light Pendant
Satin Nickel Finish
9"W x 15"H
Adj H 15" - 69"
1E 60W
Fluted White Opal Glass

C. 7-8840-1-322

1-Light Pendant
Warm Brass Finish
9"W x 15"H
Adj H 15" - 69"
1E 60W
Fluted White Opal Glass

BRYANT



A. 7-6025-3-SN
3-Light Pendant
Satin Nickel Finish
9"W x 24-3/4"H
3E 60W
Strie Glass



B. 7-6025-3-89
3-Light Pendant
Matte Black Finish
9"W x 24-3/4"H
3E 60W
Strie Glass



C. 7-6025-3-322
3-Light Pendant
Warm Brass Finish
9"W x 24-3/4"H
3E 60W
Strie Glass

BRYANT

PENDANTS / LANTERNS



Includes 120" chain & 144" wire

MYERS

PENDANTS / LANTERNS



Includes 120" chain & 144" wire



A.

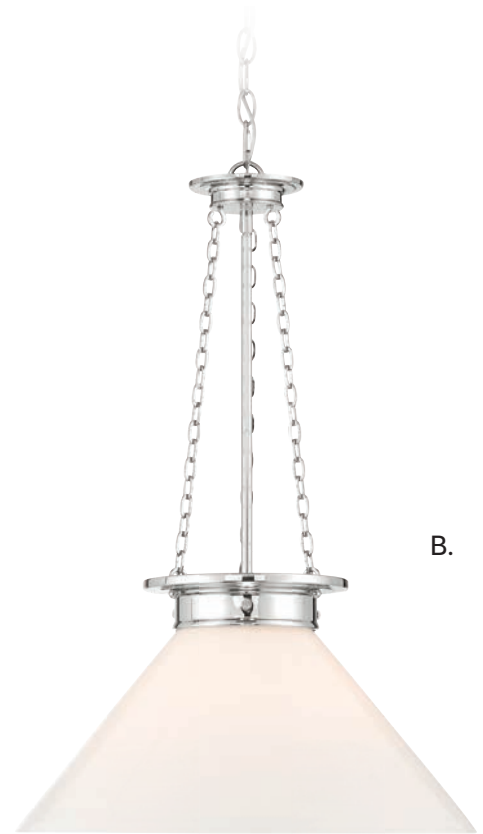

B.

- A. 7-1011-1-89**
1-Light Pendant
Matte Black Finish
18"W x 27"H
1E 60W
White Cased Glass

- B. 7-1011-1-109**
1-Light Pendant
Polished Nickel Finish
18"W x 27"H
1E 60W
White Cased Glass



C.

- C. 7-1011-1-322**
1-Light Pendant
Warm Brass Finish
18"W x 27"H
1E 60W
White Cased Glass

MANOR

PENDANTS / LANTERNS



A. 7-3901-3-89
3-Light Pendant
Matte Black Finish
13-1/2"W x 31"H
3C 60W
White Opal Glass

B. 7-3901-3-109
3-Light Pendant
Polished Nickel Finish
13-1/2"W x 31"H
3C 60W
White Opal Glass

C. 7-3901-3-322
3-Light Pendant
Warm Brass Finish
13-1/2"W x 31"H
3C 60W
White Opal Glass

MANOR

PENDANTS / LANTERNS



Includes 120" chain & 144" wire

THORNHILL

PENDANTS / LANTERNS



Includes 12" & 6" extensions - additional stems available - 7-EXT

THORNHILL



Dual Mount Hanging System

- A. 7-6407-3-89**
3-Light Pendant
Matte Black Finish
20"W x 21-1/2"H
Adj H 21-1/2" - 75-1/2"
3C 60W
Strie Glass

- B. 7-6407-3-322**
3-Light Pendant
Warm Brass Finish
20"W x 21-1/2"H
Adj H 21-1/2" - 75-1/2"
3C 60W
Strie Glass



BECKER

PENDANTS / LANTERNS

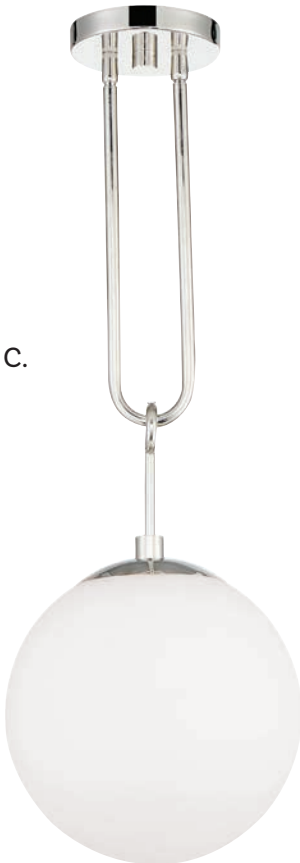
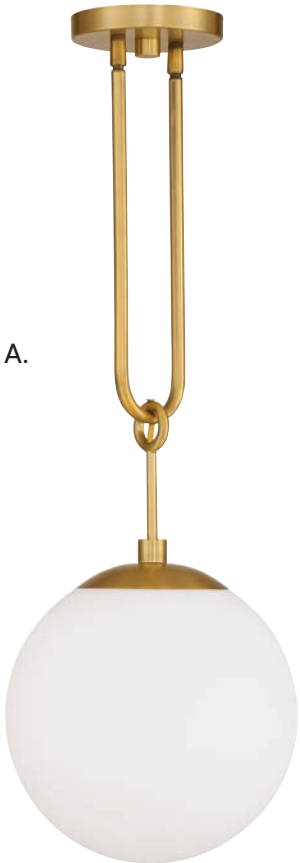

Includes (2) 9-1/2" extensions - additional stems available - 7-EXT

BECKER

PENDANTS / LANTERNS



Dual Mount Hanging System



A. 7-180-1-322
1-Light Pendant
Warm Brass Finish
10"W x 27-1/2"H
Adj H 27-1/2" - 37"
1E 60W
White Glass

B. 7-180-1-SN
1-Light Pendant
Satin Nickel Finish
10"W x 27-1/2"H
Adj H 27-1/2" - 37"
1E 60W
White Glass

C. 7-180-1-109
1-Light Pendant
Polished Nickel Finish
10"W x 27-1/2"H
Adj H 27-1/2" - 37"
1E 60W
White Glass

D. 7-180-1-89
1-Light Pendant
Matte Black Finish
10"W x 27-1/2"H
Adj H 27-1/2" - 37"
1E 60W
White Glass

CALLAWAY

PENDANTS / LANTERNS



*Includes 120" lamp cord

Includes (3) 9-1/2" extensions - additional stems available - **7-EXT

Sconce, Page 527

CALLAWAY / WRIGHT



A. CALLAWAY
7-2902-1-264
 1-Light Pendant
 White Marble w/
 Warm Brass
 10"W x 22"H
 Adj H 22" - 142"
 1E 60W
 White Glass

B. CALLAWAY
7-2902-1-263
 1-Light Pendant
 Black Marble w/
 Warm Brass
 10"W x 22"H
 Adj H 22" - 142"
 1E 60W
 White Glass

C. WRIGHT
7-3075-1-89
 1-Light Mini-Pendant
 Matte Black Finish
 5-3/4"W x 9-3/4"H
 Adj H 9-3/4" - 38-1/4"
 1E 60W
 Clear Glass

D. WRIGHT
7-3075-1-322
 1-Light Mini-Pendant
 Warm Brass Finish
 5-3/4"W x 9-3/4"H
 Adj H 9-3/4" - 38-1/4"
 1E 60W
 Clear Glass

E. WRIGHT
7-3075-1-11
 1-Light Mini-Pendant
 Polished Chrome Finish
 5-3/4"W x 9-3/4"H
 Adj H 9-3/4" - 38-1/4"
 1E 60W
 Clear Glass

GARVEY

PENDANTS / LANTERNS



A. 7-5012-1-13

1-Light Pendant
English Bronze Finish
14"W x 16-1/2"H
Adj H 16-1/2" - 48"
1E 60W
Clear Glass

B. 7-5012-1-109

1-Light Pendant
Polished Nickel Finish
14"W x 16-1/2"H
Adj H 16-1/2" - 48"
1E 60W
Clear Glass

*Includes 9-1/2" extensions - additional stems available - **7-EXT**

WESTBOURNE / STIRLING



C. WESTBOURNE
7-3102-1-322
 1-Light Pendant
 Warm Brass Finish
 12-3/4"W x 16-1/2"H
 Adj H 16-1/2" - 73-1/2"
 1E 60W
 White Opal Glass

D. WESTBOURNE
7-3100-1-322
 1-Light Pendant
 Warm Brass Finish
 8-3/4"W x 11-1/2"H
 Adj H 11-1/2" - 43"
 1E 60W
 White Opal Glass

E. STIRLING
7-200-3-322
 3-Light Pendant
 Warm Brass Finish
 12"W x 13"H
 Adj H 13"H - 70"
 3C 60W
 Cracked Glass

Includes 12" & 6" extensions - additional stems available - **7-EXT

BRANDON

PENDANTS / LANTERNS



A.



Dual Mount Hanging System



B.



A. 7-2255-1-322
1-Light Pendant
Warm Brass Finish
14"W x 22"H
Adj H 22" - 76"
1E 60W
Clear Fluted Glass

B. 7-2255-1-89
1-Light Pendant
Matte Black Finish
14"W x 22"H
Adj H 22" - 76"
1E 60W
Clear Fluted Glass

Includes 12" & 6" extensions - additional stems available - **7-EXT**

BRISTO



Dual Mount Hanging System



C.



D.

C. 7-2265-1-322
1-Light Pendant
Warm Brass Finish
14"W x 20"H
Adj H 20" - 74"
1E 60W
Clear Fluted Glass

D. 7-2265-1-89
1-Light Pendant
Matte Black Finish
14"W x 20"H
Adj H 20" - 74"
1E 60W
Clear Fluted Glass

CRAWFORD

PENDANTS / LANTERNS



Includes 120" chain & 144" wire

CRAWFORD



A. 7-1803-3-322
3-Light Pendant
Warm Brass Finish
12"W x 25-1/2"H
3C 60W
Clear Water Glass

B. 7-1803-3-SN
3-Light Pendant
Satin Nickel Finish
12"W x 25-1/2"H
3C 60W
Clear Water Glass

C. 7-1803-3-89
3-Light Pendant
Matte Black Finish
12"W x 25-1/2"H
3C 60W
Clear Water Glass



D. 7-1804-4-322
4-Light Pendant
Warm Brass Finish
18"W x 39-1/2"H
4C 60W
Clear Water Glass

E. 7-1804-4-SN
4-Light Pendant
Satin Nickel Finish
18"W x 39-1/2"H
4C 60W
Clear Water Glass

F. 7-1804-4-89
4-Light Pendant
Matte Black Finish
18"W x 39-1/2"H
4C 60W
Clear Water Glass



Sconce, Page 235

FOSTER

PENDANTS / LANTERNS



Dual Mount Hanging System



Includes 12" & 6" extensions - additional stems available - **7-EXT**



A. 7-7006-1-89

1-Light Pendant
 Matte Black Finish
 14"W x 25-1/2"H
 Adj H 25-1/2" - 79-1/2"
 1E 60W
 Clear Seeded Glass

B. 7-7006-1-322

1-Light Pendant
 Warm Brass Finish
 14"W x 25-1/2"H
 Adj H 25-1/2" - 79-1/2"
 1E 60W
 Clear Seeded Glass

C. 7-7006-1-SN

1-Light Pendant
 Satin Nickel Finish
 14"W x 25-1/2"H
 Adj H 25-1/2" - 79-1/2"
 1E 60W
 Clear Seeded Glass



Sconce, Page 234

AKRON



Includes 120" chain & 144" wire.

AKRON

PENDANTS / LANTERNS



A. 7-9006-3-89
3-Light Pendant
Matte Black Finish
12"W x 24"H
3C 60W
Clear Glass

B. 7-9006-3-SN
3-Light Pendant
Satin Nickel Finish
12"W x 24"H
3C 60W
Clear Glass

C. 7-9006-3-322
3-Light Pendant
Warm Brass Finish
12"W x 24"H
3C 60W
Clear Glass

D. 7-9006-3-13
3-Light Pendant
English Bronze Finish
12"W x 24"H
3C 60W
Clear Glass

CHANTILLY

PENDANTS / LANTERNS



A. 7-1742-1-322
1-Light Pendant
Warm Brass Finish
8"W x 13"H
Adj H 13" - 41-1/2"
1E 60W
Clear Ribbed Glass

B. 7-1742-1-89
1-Light Pendant
Matte Black Finish
8"W x 13"H
Adj H 13" - 41-1/2"
1E 60W
Clear Ribbed Glass

C. 7-1742-1-109
1-Light Pendant
Polished Nickel Finish
8"W x 13"H
Adj H 13" - 41-1/2"
1E 60W
Clear Ribbed Glass

Includes 9-1/2" extensions - additional stems available - **7-EXT**



LAKEWOOD



D.



Dual Mount Hanging System

E.



D. 7-1831-1-322
1-Light Pendant
Warm Brass Finish
8"W x 22"H
Adj H 22" - 50-1/2"
1E 60W
Clear Glass

E. 7-1831-1-89
1-Light Pendant
Matte Black Finish
8"W x 22"H
Adj H 22" - 50-1/2"
1E 60W
Clear Glass

FRANKLIN / BALLY

PENDANTS / LANTERNS



A. FRANKLIN
7-702-1-13
1-Light Pendant
English Bronze Finish
10"W x 20"H
1E 60W
Clear Glass

B. FRANKLIN
7-703-1-SN
1-Light Pendant
Satin Nickel Finish
10"W x 20"H
1E 60W
Silver Mercury Glass

C. FRANKLIN
7-702-1-109
1-Light Pendant
Polished Nickel Finish
10"W x 20"H
1E 60W
Clear Glass

D. BALLY
7-700-1-109
1-Light Pendant
Polished Nickel Finish
6-1/2"W x 12"H
1E 60W
Clear Glass

E. BALLY
7-701-1-SN
1-Light Pendant
Satin Nickel Finish
6-1/2"W x 12"H
1E 60W
Silver Mercury Glass

Includes 120" chain & 144" wire.

OCTAVE



F. 7-4036-1-SN
1-Light Pendant
Satin Nickel Finish
8"W x 10-1/2H
Adj H 10-1/2" - 42"
1E 60W
Clear Glass

G. 7-4036-1-BK
1-Light Pendant
Matte Black Finish
8"W x 10-1/2H
Adj H 10-1/2" - 42"
1E 60W
Clear Glass

H. 7-4036-1-11
1-Light Pendant
Polished Chrome Finish
8"W x 10-1/2H
Adj H 10-1/2" - 42"
1E 60W
Clear Glass

I. 7-4036-1-322
1-Light Pendant
Warm Brass Finish
8"W x 10-1/2H
Adj H 10-1/2" - 42"
1E 60W
Clear Glass

J. 7-4036-1-13
1-Light Pendant
English Bronze Finish
8"W x 10-1/2H
Adj H 10-1/2" - 42"
1E 60W
Clear Glass

Includes 9-1/2" extensions - additional stems available - **7-EXT**

DRAKE

PENDANTS / LANTERNS



A. 7-9132-1-109

1-Light Pendant
Polished Nickel Finish
10"W x 10-1/4"H
Adj H 10-1/4" - 43"
1E 60W
Clear Glass

B. 7-9132-1-89

1-Light Pendant
Matte Black Finish
10"W x 10-1/4"H
Adj H 10-1/4" - 43"
1E 60W
Clear Glass

C. 7-9132-1-322

1-Light Pendant
Warm Brass Finish
10"W x 10-1/4"H
Adj H 10-1/4" - 43"
1E 60W
Clear Glass

D. 7-9132-1-13

1-Light Pendant
English Bronze Finish
10"W x 10-1/4"H
Adj H 10-1/4" - 43"
1E 60W
Clear Glass

E. 7-9132-1-SN

1-Light Pendant
Satin Nickel Finish
10"W x 10-1/4"H
Adj H 10-1/4" - 43"
1E 60W
Clear Glass

DRAKE



Dual Mount Hanging System

A.



B.



C.



D.



E.

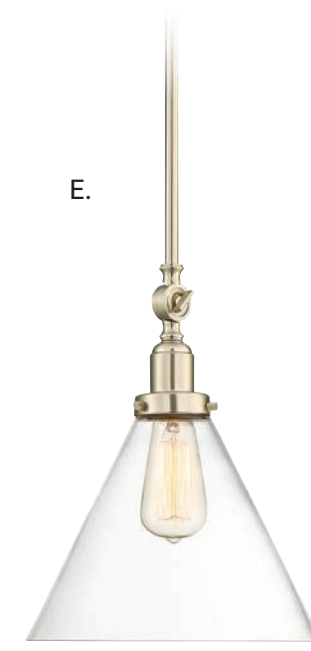

Includes 9-1/2" extensions - additional stems available - **7-EXT**

CALHOUN

PENDANTS / LANTERNS



Includes 9-1/2" extensions - additional stems available - 7-EXT



Dual Mount Hanging System

A. 7-1026-1-SN

1-Light Mini-Pendant
Satin Nickel Finish
5"W x 7"H
Adj H 7" - 35.5"
1E 60W
Clear Glass

A.



B.



C.



B. 7-1026-1-89

1-Light Mini-Pendant
Matte Black Finish
5"W x 7"H
Adj H 7" - 35.5"
1E 60W
Clear Glass

C. 7-1026-1-322

1-Light Mini-Pendant
Warm Brass Finish
5"W x 7"H
Adj H 7" - 35.5"
1E 60W
Clear Glass

D.



E.



F.



D. 7-1027-1-SN

1-Light Pendant
Satin Nickel Finish
8"W x 11"H
Adj H 11" - 65"
1E 60W
Clear Glass

E. 7-1027-1-89

1-Light Pendant
Matte Black Finish
8"W x 11"H
Adj H 11" - 65"
1E 60W
Clear Glass

F. 7-1027-1-322

1-Light Pendant
Warm Brass Finish
8"W x 11"H
Adj H 11" - 65"
1E 60W
Clear Glass

PENDLETON

PENDANTS / LANTERNS



*Includes 9-1/2" extensions - additional stems available - 7-EXT

PENDLETON

PENDANTS / LANTERNS



A.



B.



C.



*D



*E.



*F.

- | | | | | | |
|--|--|---|---|---|--|
| <p>A. 6-7200-1-89
 1-Light Semi-Flush
 Matte Black Finish
 9-3/8"W x 9-3/4"H
 1E 60W
 Clear Glass</p> | <p>B. 6-7200-1-322
 1-Light Semi-Flush
 Warm Brass Finish
 9-3/8"W x 9-3/4"H
 1E 60W
 Clear Glass</p> | <p>C. 6-7200-1-SN
 1-Light Semi-Flush
 Satin Nickel Finish
 9-3/8"W x 9-3/4"H
 1E 60W
 Clear Glass</p> | <p>D. 7-7201-1-89
 1-Light Pendant
 Matte Black Finish
 14"W x 14"H
 Adj H 14"- 45-1/2"
 1E 60W
 Clear Glass</p> | <p>E. 7-7201-1-322
 1-Light Pendant
 Warm Brass Finish
 14"W x 14"H
 Adj H 14"- 45-1/2"
 1E 60W
 Clear Glass</p> | <p>F. 7-7201-1-SN
 1-Light Pendant
 Satin Nickel Finish
 14"W x 14"H
 Adj H 14"- 45-1/2"
 1E 60W
 Clear Glass</p> |
|--|--|---|---|---|--|

DUNBAR

PENDANTS / LANTERNS

*A.



**B.



A. DUNBAR
7-9064-1-95
1-Light Mini Pendant
Warm Brass w/ Bronze
4-3/4"W x 7"H
Adj H 7" - 35-1/2"
1E 60W
Clear Glass

B. DUNBAR
7-9063-1-95
1-Light Pendant
Warm Brass w/ Bronze
12"W x 28-1/2"H
Adj H 28-1/2" - 82-1/2"
1E 60W
Clear Glass

PENDANTS



Dual Mount Hanging System

C. CARLTON
7-3390-1-89
 1-Light Pendant
 Matte Black Finish
 11"W x 20"H
 Adj H 20" - 74"
 1E 60W
 Ribbed Glass

D. CARLTON
7-3390-1-322
 1-Light Pendant
 Warm Brass Finish
 11"W x 20"H
 Adj H 20" - 74"
 1E 60W
 Ribbed Glass

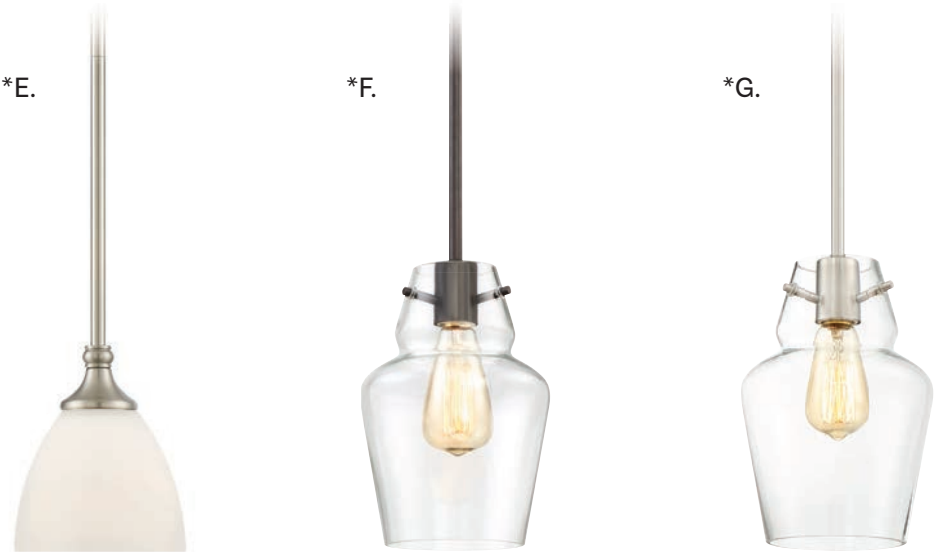

E. HERNDON
7-1010-1-SN
 1-Light Mini-Pendant
 Satin Nickel Finish
 5-1/2"W x 9-1/2"H
 Adj H 9-1/2" - 38"
 1E 60W
 Frosted White Glass

F. VINTAGE
7-4134-1-13
 1-Light Mini-Pendant
 English Bronze Finish
 7"W x 10-1/2"H
 Adj H 10-1/2" - 42"
 1E 60W
 Clear Glass

G. VINTAGE
7-4134-1-SN
 1-Light Mini-Pendant
 Satin Nickel Finish
 7"W x 10-1/2"H
 Adj H 10-1/2" - 42"
 1E 60W
 Clear Glass

*Includes (3) 9-1/2" extensions - additional stems available - **7-EXT**
 Includes 12" & 6" extensions - additional stems available - **7-EXTLG

ABEL

PENDANTS / LANTERNS



*Includes 12" & 6" extensions - additional stems available - **7-EXT**

**Includes 120" lamp cord

ABEL / MACAULEY



*A.

A. ABEL
7-1643-1-143
1-Light Mini Pendant
Matte Black w/ Warm Brass
8-1/4"W x 13-3/4"H
Adj H 13-3/4" - 67-3/4"
8W Integrated Dimmable LED
300 Lumens, 3000K, 90+ CRI
White Opal Glass



**B.

B. MACAULEY
7-2064-1-51
1-Light Mini-Pendant
Vintage Black w/
Warm Brass Finish
4-3/4"W x 13"H
1E 60W
Clear Glass

KOLE

PENDANTS / LANTERNS



Dual Mount Hanging System

A. 3-1617-4-11
4-Light Lantern
Polished Chrome Finish
14"W x 21"H
Adj H 21" - 75"
4C 60W
Laser Cut Glass

B. 3-1617-4-322
4-Light Lantern
Warm Brass Finish
14"W x 21"H
Adj H 21" - 75"
4C 60W
Laser Cut Glass

C. 3-1617-4-89
4-Light Lantern
Matte Black Finish
14"W x 21"H
Adj H 21" - 75"
4C 60W
Laser Cut Glass

KOLE

PENDANTS / LANTERNS



Includes 12" & 6" extensions - additional stems available - 7-EXT

ENCLAVE

PENDANTS / LANTERNS



Includes 120" chain & 144" wire

ENCLAVE



A. 3-6802-6-127
6-Light Lantern
Noble Brass Finish
21"W x 35"H
6C 60W
Clear Glass

B. 3-6802-6-188
6-Light Lantern
Black Tourmaline Finish
21"W x 35"H
6C 60W
Clear Glass

LEXINGTON

PENDANTS / LANTERNS



Includes 120" chain & 144" wire

LEXINGTON



A. 3-6599-5-171
5-Light Lantern
Burnished Brass Finish
26"W x 37"H
5E 60W

B. 3-6599-5-89
5-Light Lantern
Matte Black Finish
26"W x 37"H
5E 60W

ROSEDALE

PENDANTS / LANTERNS



Includes 12" & 6" extensions - additional stems available - **7-EXT**

ROSEDALE



Dual Mount Hanging System

A.



B.



A. 3-2406-4-89
4-Light Lantern
Matte Black Finish
23"W x 37"H
Adj H 37" - 91"
4C 60W
Clear Glass

B. 3-2406-4-322
4-Light Lantern
Warm Brass Finish
23"W x 37"H
Adj H 37" - 91"
4C 60W
Clear Glass

FARELL

PENDANTS / LANTERNS



Includes 12" & 6" extensions - additional stems available - 7-EXT

FARELL



Dual Mount Hanging System

A.



B.



A. 3-9950-4-322
4-Light Lantern
Warm Brass Finish
21"W x 36"H
Adj H 36" - 90"
4C 60W
Clear Beveled Glass

B. 3-9950-4-89
4-Light Lantern
Matte Black Finish
21"W x 36"H
Adj H 36" - 90"
4C 60W
Clear Beveled Glass

BROOKSTONE

PENDANTS / LANTERNS



A. 3-7388-6-83
6-Light Lantern
Bisque White Finish
26"W x 40"H
6C 60W

B. 3-7388-6-89
6-Light Lantern
Matte Black Finish
26"W x 40"H
6C 60W

C. 3-7388-6-SN
6-Light Lantern
Satin Nickel Finish
26"W x 40"H
6C 60W

D. 3-7388-6-322
6-Light Lantern
Warm Brass Finish
26"W x 40"H
6C 60W

BROOKSTONE

PENDANTS / LANTERNS

A.



B.



C.



D.



Includes 120" chain & 144" wire

DIPLOMAT

PENDANTS / LANTERNS



Includes 12" & 6" extensions - additional stems available - **7-EXT**

DIPLOMAT



Dual Mount Hanging System



A. 3-6612-4-89
4-Light Lantern
Matte Black Finish
20"W x 25"H
Adj. H 25" - 79"
4C 60W

B. 3-6612-4-322
4-Light Lantern
Warm Brass Finish
20"W x 25"H
Adj. H 25" - 79"
4C 60W

C. 3-6612-4-SN
4-Light Lantern
Satin Nickel Finish
20"W x 25"H
Adj. H 25" - 79"
4C 60W

KENT

PENDANTS / LANTERNS



A. 3-4901-4-89
4-Light Lantern
Matte Black Finish
16"W x 24"H
Adj H 24" - 78"
4C 60W
30° Swivel

B. 6-4900-4-322
4-Light Semi-Flush
Warm Brass Finish
20"W x 25"H
Adj. H 25" - 79"
4E 60W

C. 6-4900-4-89
4-Light Semi-Flush
Matte Black Finish
16"W x 14-3/4"H
4E 60W

D. 3-4901-4-322
4-Light Lantern
Warm Brass Finish
16"W x 24"H
Adj H 24" - 78"
4C 60W
30° Swivel

*A.



B.

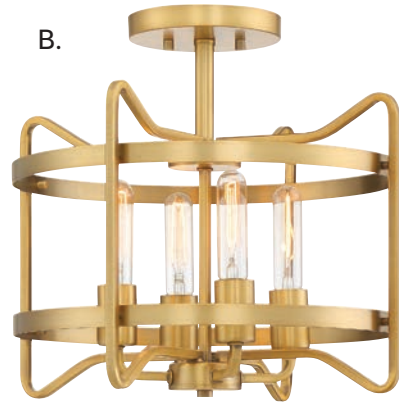

C.



*D.



Includes 12" & 6" extensions - additional stems available - 7-EXT

BENSON

PENDANTS / LANTERNS



Dual Mount Hanging System

- A. 6-7702-3-89**
3-Light Semi-Flush
Matte Black Finish
13"W x 12"H
3C 60W
- B. 6-7702-3-322**
3-Light Semi-Flush
Warm Brass Finish
13"W x 12"H
3C 60W
- C. 6-7702-3-SN**
3-Light Semi-Flush
Satin Nickel Finish
13"W x 12"H
3C 60W
- D. 3-7700-3-89**
3-Light Lantern
Matte Black Finish
13"W x 16-1/2"H
Adj H 16-1/2" - 70-1/2"
3C 60W
- E. 3-7700-3-322**
3-Light Lantern
Warm Brass Finish
13"W x 16-1/2"H
Adj H 16-1/2" - 70-1/2"
3C 60W
- F. 3-7700-3-SN**
3-Light Lantern
Satin Nickel Finish
13"W x 16-1/2"H
Adj H 16-1/2" - 70-1/2"
3C 60W
- G. 3-7701-5-89**
5-Light Lantern
Matte Black Finish
16"W x 20-1/2"H
Adj H 20-1/2" - 74-1/2"
5C 60W
- H. 3-7701-5-322**
5-Light Lantern
Warm Brass Finish
16"W x 20-1/2"H
Adj H 20-1/2" - 74-1/2"
5C 60W
- I. 3-7701-5-SN**
5-Light Lantern
Satin Nickel Finish
16"W x 20-1/2"H
Adj H 20-1/2" - 74-1/2"
5C 60W

BENSON

PENDANTS / LANTERNS



A.



B.



C.



*D.



*E.



*F.



*G.



*H.



*I.

*Includes 12" & 6" extensions - additional stems available - 7-EXT

PENROSE

PENDANTS / LANTERNS



*Includes 120" chain & 144" wire

PENROSE



A.



B.



C.



D.

A. 7-1041-6-109
6-Light Lantern
Polished Nickel Finish
16"W x 34"H
6C 60W
Clear Glass

B. 7-1041-6-SN
6-Light Lantern
Satin Nickel Finish
16"W x 34"H
6C 60W
Clear Glass

C. 7-1041-6-BK
6-Light Lantern
Matte Black Finish
16"W x 34"H
6C 60W
Clear Glass

D. 7-1041-6-13
6-Light Lantern
English Bronze Finish
16"W x 34"H
6C 60W
Clear Glass

PENROSE

PENDANTS / LANTERNS

A.



B.



C.



*D.



*E.



*F.



A. 6-1043-3-13
3-Light Semi-Flush
English Bronze Finish
12-1/2"W x 14"H
3C 60W
Clear Glass

B. 6-1043-3-109
3-Light Semi-Flush
Polished Nickel Finish
12-1/2"W x 14"H
3C 60W
Clear Glass

C. 6-1043-3-BK
3-Light Semi-Flush
Matte Black Finish
12-1/2"W x 14"H
3C 60W
Clear Glass

D. 7-1040-3-13
3-Light Lantern
English Bronze Finish
12"W x 26"H
3C 60W
Clear Glass

E. 7-1040-3-109
3-Light Lantern
Polished Nickel Finish
12"W x 26"H
3C 60W
Clear Glass

PENROSE

PENDANTS / LANTERNS

G.



*H.



F. 7-1040-3-BK
 3-Light Lantern
 Matte Black Finish
 12"W x 26"H
 3C 60W
 Clear Glass

G. 6-1043-3-SN
 3-Light Semi-Flush
 Satin Nickel Finish
 12-1/2"W x 14"H
 3C 60W
 Clear Glass

H. 7-1040-3-SN
 3-Light Lantern
 Satin Nickel Finish
 12"W x 26"H
 3C 60W
 Clear Glass

*Includes 120" chain & 144" wire

TALBOT

PENDANTS / LANTERNS



Includes 120" chain & 144" wire

TALBOT / WINDSUNG



A.



B.



C.

A. TALBOT
3-4081-4-79
4-Light Lantern
English Bronze w/
Warm Brass Finish
14"W x 28"H
4C 60W

B. TALBOT
3-4080-4-79
4-Light Lantern
English Bronze w/
Warm Brass Finish
10"W x 18"H
4C 60W

C. WINDSUNG
3-6821-4-13
4-Light Lantern
English Bronze
16"W x 33"H
4C 40W

ARONDALE

WALL LIGHTING



ARONDALE

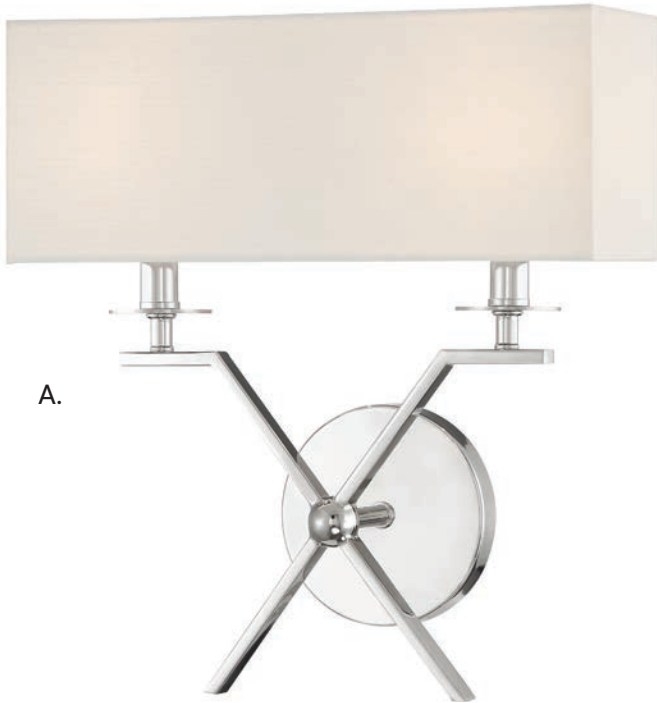

A.

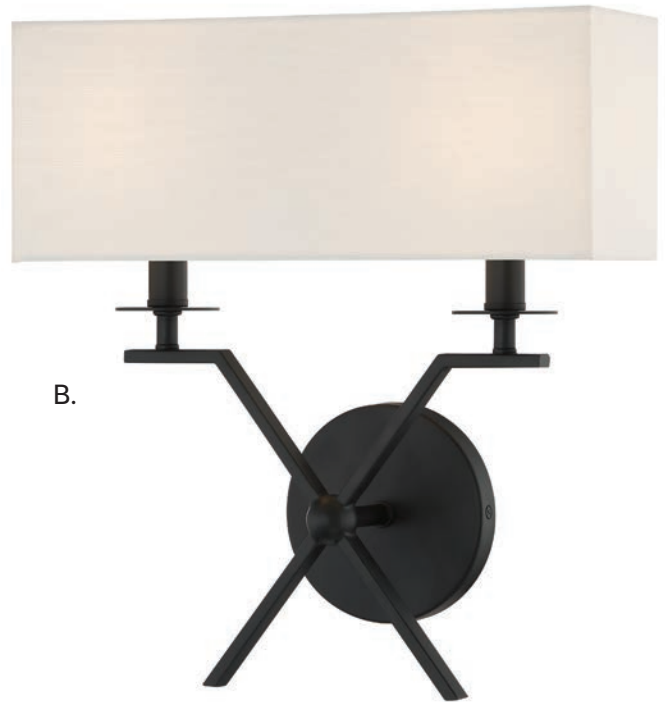

B.

A. 9-3305-2-109
2-Light Sconce
Polished Nickel Finish
14"W x 15"H x 5-3/4"E
2C 60W
White Fabric Shade

B. 9-3305-2-89
2-Light Sconce
Matte Black Finish
14"W x 15"H x 5-3/4"E
2C 60W
White Fabric Shade

C. 9-3305-2-322
2-Light Sconce
Warm Brass Finish
14"W x 15"H x 5-3/4"E
2C 60W
White Fabric Shade

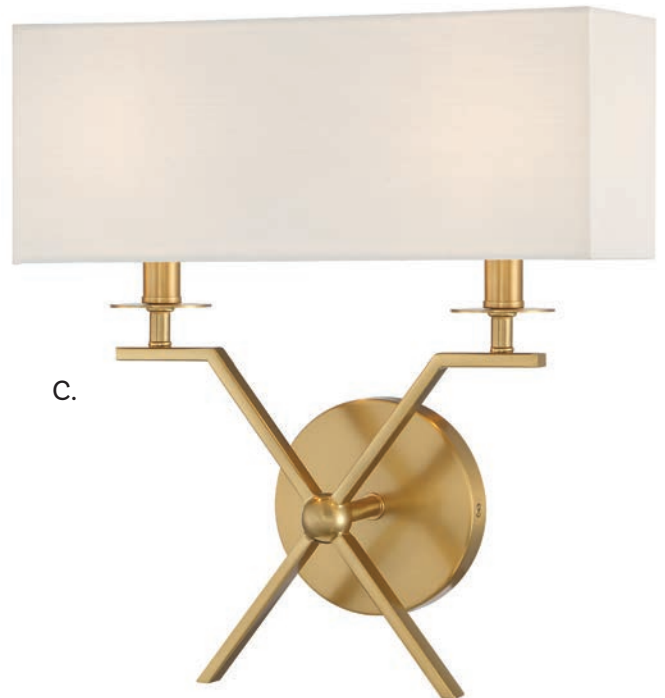

C.

COMO

WALL LIGHTING





A.

- A. 9-6520-1-89**
 LED Sconce
 Matte Black Finish
 11"W x 20"H x 4"E
 14W Dimmable LED
 300 Lumens, 3000K, 90+ CRI

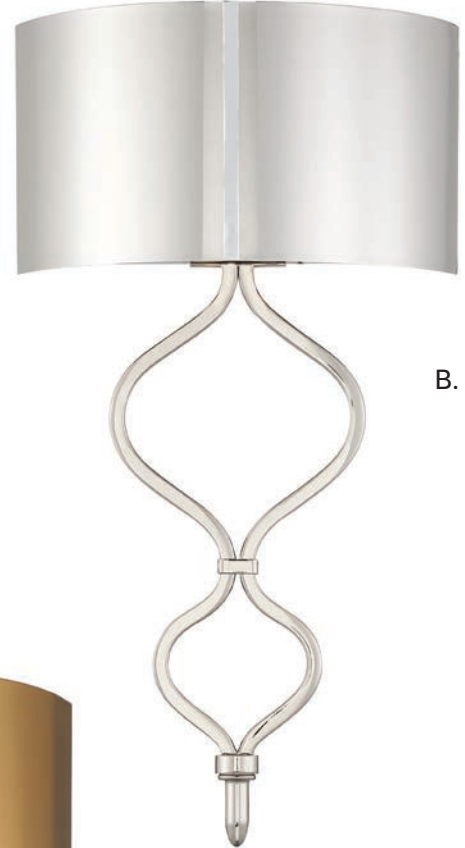

B.

- B. 9-6520-1-109**
 LED Sconce
 Polished Nickel Finish
 11"W x 20"H x 4"E
 14W Dimmable LED
 300 Lumens, 3000K, 90+ CRI

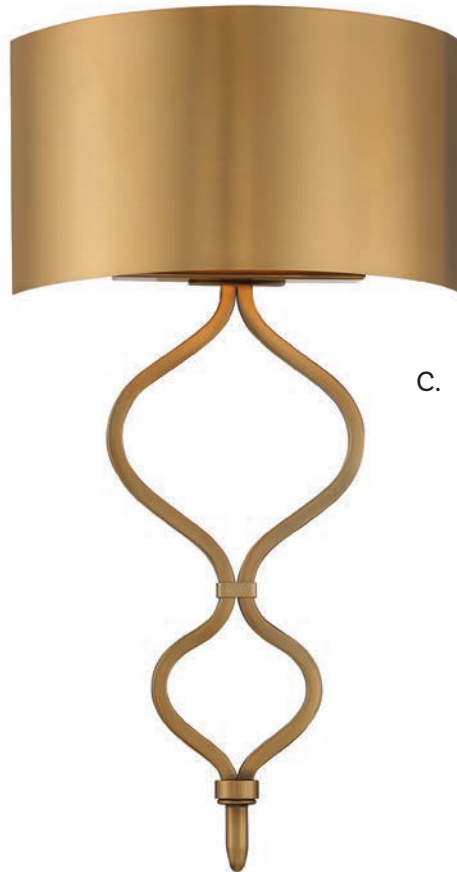

C.

- C. 9-6520-1-322**
 LED Sconce
 Warm Brass Finish
 11"W x 20"H x 4"E
 14W Dimmable LED
 300 Lumens, 3000K, 90+ CRI



RHODES

WALL LIGHTING



A. 9-998-2-SN
2-Light Sconce
Satin Nickel Finish
14"W x 12"H x 4"E
2C 60W
White Linen Shade

B. 9-998-2-44
2-Light Sconce
Classic Bronze Finish
14"W x 12"H x 4"E
2C 60W
White Linen Shade

C. 9-998-2-109
2-Light Sconce
Polished Nickel Finish
14"W x 12"H x 4"E
2C 60W
White Linen Shade

D. 9-998-2-89
2-Light Sconce
Matte Black Finish
14"W x 12"H x 4"E
2C 60W
White Linen Shade

E. 9-998-2-322
2-Light Sconce
Warm Brass Finish
14"W x 12"H x 4"E
2C 60W
White Linen Shade

RHODES

WALL LIGHTING





A. 9-6608-1-322

1-Light Sconce
Warm Brass Finish
9"W x 17-1/2"H x 10"E
1C 60W
White Linen Shade

A.



B.



B. 9-6608-1-188

1-Light Sconce
Black Tourmaline Finish
9"W x 17-1/2"H x 10"E
1C 60W
White Linen Shade

CRESTWOOD

C. 9-4408-1-322

1-Light Sconce
Warm Brass Finish
8"W x 15-3/4"H x 9-1/2"E
1C 60W
White Pleated Shade

D. 9-4408-1-188

1-Light Sconce
Black Tourmaline Finish
8"W x 15-3/4"H x 9-1/2"E
1C 60W
White Pleated Shade



WALL LIGHTING



EASTOVER

WALL LIGHTING



A.



ROXBURY



B.



WALL LIGHTING

C.



A. 9-6512-1-322
1-Light Sconce
Warm Brass Finish
6-1/2"W x 22"H x 6-1/4"E
1C 60W
White Linen Shade

B. 9-2866-2-89
2-Light Sconce
Matte Black Finish
9-1/2"W x 31-1/2"H x 6"E
2C 60W
White Linen Shade

C. 9-2866-2-322
2-Light Sconce
Warm Brass Finish
9-1/2"W x 31-1/2"H x 6"E
2C 60W
White Linen Shade

BARCLAY

WALL LIGHTING

A. 9-4928-2-89
2-Light Sconce
Matte Black Finish
15-1/2"W x 23"H x 7"E
2C 60W
White Linen Shade



A.

B. 9-4928-2-322
2-Light Sconce
Warm Brass Finish
15-1/2"W x 23"H x 7"E
2C 60W
White Linen Shade



B.



ENCINO

WALL LIGHTING



C. 9-7193-1-89
1-Light Sconce
Matte Black Finish
8"W x 20"H x 7-1/2"E
1C 60W
Clear Seeded Glass

D. 9-7193-1-11
1-Light Sconce
Polished Chrome Finish
8"W x 20"H x 7-1/2"E
1C 60W
Clear Seeded Glass

E. 9-7193-1-322
1-Light Sconce
Warm Brass Finish
8"W x 20"H x 7-1/2"E
1C 60W
Clear Seeded Glass



C.



D.



E.

JOFFREE

WALL LIGHTING



A.

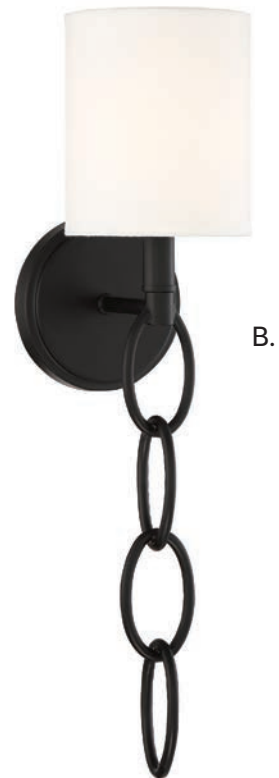

B.

A. 9-1914-1-322

1-Light Sconce
Warm Brass Finish
5"W x 20-3/8"H x 6-1/2"E
1C 60W
White Fabric Shade

B. 9-1914-1-89

1-Light Sconce
Matte Black Finish
5"W x 20-3/8"H x 6-1/2"E
1C 60W
White Fabric Shade

POLSON



C.



D.



E.



WALL LIGHTING

C. 9-1911-1-322

1-Light Sconce
Warm Brass Finish
8"W x 15-1/2"H x 8"E
1E 60W
Opal Etched Glass

D. 9-1911-1-89

1-Light Sconce
Matte Black Finish
8"W x 15-1/2"H x 8"E
1E 60W
Opal Etched Glass

E. 9-1911-1-11

1-Light Sconce
Polished Chrome Finish
8"W x 15-1/2"H x 8"E
1E 60W
Opal Etched Glass

CARVER

WALL LIGHTING



A. 9-8257-2-89
2-Light Sconce
Matte Black Finish
4-1/2"W x 22"H x 4"E
2C 40W
White Fabric Shade

B. 9-8257-2-322
2-Light Sconce
Warm Brass Finish
4-1/2"W x 22"H x 4"E
2C 40W
White Fabric Shade



A.



B.

TRAVIS

WALL LIGHTING



C. 9-1968-1-322

1-Light Sconce
Warm Brass Finish
7-1/2"W x 22"H x 8-1/2"E
1C 60W
White Fabric Shade
Marble Ball

D. 9-1968-1-89

1-Light Sconce
Matte Black Finish
7-1/2"W x 22"H x 8-1/2"E
1C 60W
White Fabric Shade
Marble Ball

E. 9-1968-1-11

1-Light Sconce
Polished Chrome Finish
7-1/2"W x 22"H x 8-1/2"E
1C 60W
White Fabric Shade
Marble Ball



WILLMAR

WALL LIGHTING



A. 9-996-1-89

1-Light Sconce
Matte Black Finish
4-1/2"W x 16"H x 3-3/4"E
1E 60W
Clear Reeded Glass

B. 9-996-1-SN

1-Light Sconce
Satin Nickel Finish
4-1/2"W x 16"H x 3-3/4"E
1E 60W
Clear Reeded Glass

C. 9-996-1-109

1-Light Sconce
Polished Nickel Finish
4-1/2"W x 16"H x 3-3/4"E
1E 60W
Clear Reeded Glass

D. 9-996-1-322

1-Light Sconce
Warm Brass Finish
4-1/2"W x 16"H x 3-3/4"E
1E 60W
Clear Reeded Glass

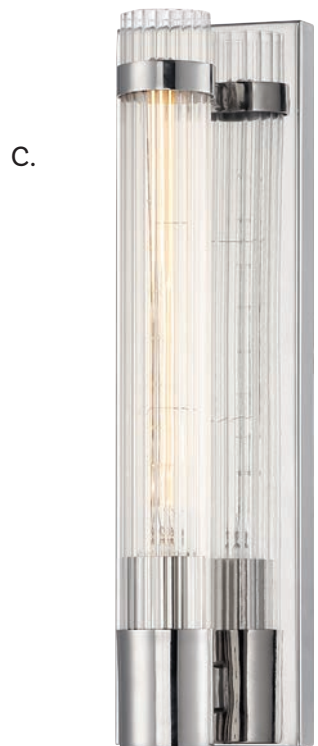

WALL LIGHTING

PIKE

WALL LIGHTING



A.



B.



C.

- A. 9-16000-1-322**
1-Light Sconce
Warm Brass Finish
4-1/2"W x 17-3/4"H x 6-1/2"E
1E 60W
Clear Ribbed Glass
- B. 9-16000-1-109**
1-Light Sconce
Polished Nickel Finish
4-1/2"W x 17-3/4"H x 6-1/2"E
1E 60W
Clear Ribbed Glass
- C. 9-16000-1-44**
1-Light Sconce
Classic Bronze Finish
4-1/2"W x 17-3/4"H x 6-1/2"E
1E 60W
Clear Ribbed Glass



CLIFTON

WALL LIGHTING



D.



E.



F.

- D. 9-900-1-109**
1-Light Sconce
Polished Nickel Finish
4-1/2"W x 15-1/4"H x 4-1/2"E
1E 60W
- E. 9-900-1-322**
1-Light Sconce
Warm Brass Finish
4-1/2"W x 15-1/4"H x 4-1/2"E
1E 60W
- F. 9-900-1-44**
1-Light Sconce
Classic Bronze Finish
4-1/2"W x 15-1/4"H x 4-1/2"E
1E 60W

TULSA / FOLSOM

WALL LIGHTING



A.



B.

A. TULSA
9-6054-1-13
1-Light Sconce
English Bronze Finish
4-3/4"W x 13-3/4"H x
6-1/4"E
1C 60W
Clear Glass

B. FOLSOM
9-2134-2-67
2-Light Adjustable Sconce
Matte Black w/
Polished Chrome
8"W x 17"H x 3-1/2"E
Adj E 3-1/2" - 6-3/4"
2C 60W
Clear Glass

HARTFORD

WALL LIGHTING



C. 9-100-1-109
1-Light Sconce
Polished Nickel Finish
4-1/2"W x 14"H x 4-1/2"E
1E 60W
Clear Glass

D. 9-100-1-44
1-Light Sconce
Classic Bronze Finish
4-1/2"W x 14"H x 4-1/2"E
1E 60W
Clear Glass

FOSTER

WALL LIGHTING



A. 9-7005-1-89
1-Light Sconce
Matte Black Finish
8"W x 14"H x 10"E
1E 60W
Clear Seeded Glass

B. 9-7005-1-322
1-Light Pendant
Warm Brass Finish
8"W x 14"H x 10"E
1E 60W
Clear Seeded Glass

C. 9-7005-1-SN
1-Light Pendant
Satin Nickel Finish
8"W x 14"H x 10"E
1E 60W
Clear Seeded Glass

CRAWFORD



D. 9-1801-1-322
1-Light Sconce
Warm Brass Finish
10"W x 17-1/4"H x 9-1/4"E
1E 60W
Clear Water Glass

E. 9-1801-1-89
1-Light Sconce
Matte Black Finish
10"W x 17-1/4"H x 9-1/4"E
1E 60W
Clear Water Glass

F. 9-1801-1-SN
1-Light Sconce
Satin Nickel Finish
10"W x 17-1/4"H x 9-1/4"E
1E 60W
Clear Water Glass

LONGFELLOW

WALL LIGHTING



A.



B.



A. 9-9603-2-171
2-Light Sconce
Burnished Brass Finish
5-1/4"W x 20"H x 6"E
2C 60W

B. 9-9603-2-89
2-Light Sconce
Matte Black Finish
5-1/4"W x 20"H x 6"E
2C 60W

SNOWDEN / CALLAWAY



C. SNOWDEN
9-2006-1-171
1-Light Sconce
Burnished Brass Finish
4-3/4"W x 14"H x 4"E
1C 60W
Glacier Glass

D. SNOWDEN
9-2006-1-89
1-Light Sconce
Matte Black Finish
4-3/4"W x 14"H x 4"E
1C 60W
Glacier Glass

E. CALLAWAY
9-2901-2-264
2-Light Sconce
White Marble w/
Warm Brass
5"W x 26"H x 4-1/2"E
2C 60W

F. CALLAWAY
9-2901-2-263
2-Light Sconce
Black Marble w/
Warm Brass
5"W x 26"H x 4-1/2"E
2C 60W

ALVARA / BRODY

WALL LIGHTING



A. ALVARA
9-1645-1-143
1-Light Sconce
Matte Black w/ Warm Brass
5-1/2"W x 22-1/2"H x 7-1/2"E
1E 60W
White Opal Glass

B. BRODY
9-1632-1-143
1-Light Sconce
Matte Black w/ Warm Brass
5-3/4"W x 16"H x 8"E
1C 60W
White Fabric Shade



A.



B.

ALBERTA

WALL LIGHTING

C.



D.

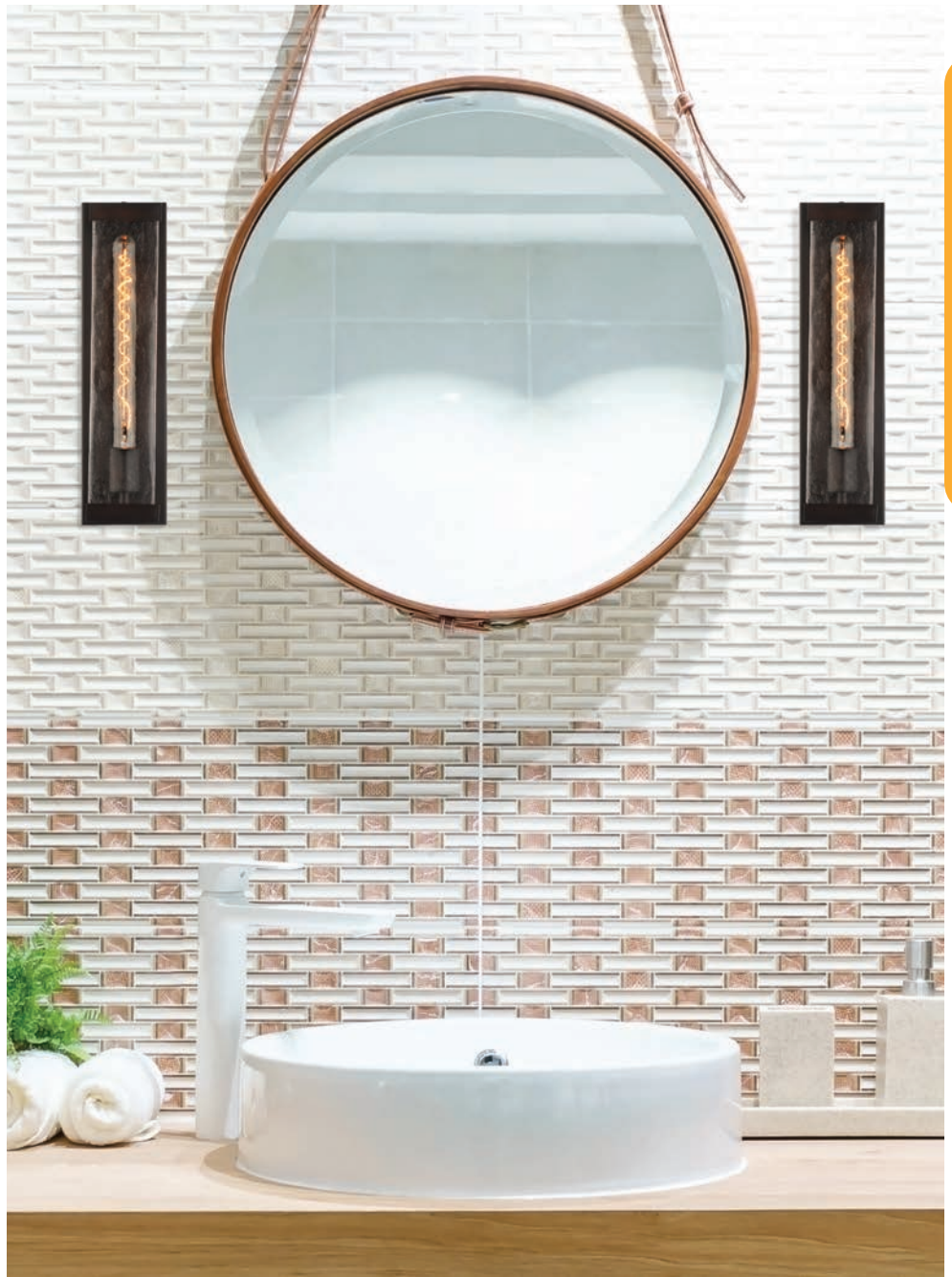

C. ALBERTA
9-1902-1-322
1-Light Sconce
Warm Brass Finish
4-1/2"W x 17-1/2"H x 4"E
1E 60W
Piastra Glass

D. ALBERTA
9-1902-1-13
1-Light Sconce
English Bronze Finish
4-1/2"W x 17-1/2"H x 4"E
1E 60W
Piastra Glass

DESTIN

WALL LIGHTING



A. 9-0902-1-322
1-Light Sconce
Warm Brass Finish
6"W x 25"H x 6-7/8"E
1C 60W
White Opal Glass

B. 9-0902-1-89
1-Light Sconce
Matte Black Finish
6"W x 25"H x 6-7/8"E
1C 60W
White Opal Glass

C. 9-0902-1-109
1-Light Sconce
Polished Nickel Finish
6"W x 25"H x 6-7/8"E
1C 60W
White Opal Glass

DEVON

WALL LIGHTING



D.



E.

D. 9-7140-1-322
1-Light Sconce
Warm Brass Finish
7-1/2"W x 26-1/2"H x 5-1/2"E
1C 60W
White Fabric Shade

E. 9-7140-1-SN
1-Light Sconce
Satin Nickel Finish
7-1/2"W x 26-1/2"H x 5-1/2"E
1C 60W
White Fabric Shade

CAMERON

WALL LIGHTING



A.



B.



C.

A. 9-2542-1-322

1-Light Sconce
Warm Brass Finish
5"W x 13"H x 8"E
1C 40W
White Fabric Shade

B. 9-2542-1-89

1-Light Sconce
Matte Black Finish
5"W x 13"H x 8"E
1C 40W
White Fabric Shade

C. 9-2542-1-109

1-Light Sconce
Polished Nickel Finish
5"W x 13"H x 8"E
1C 40W
White Fabric Shade

WASHBURN

WALL LIGHTING



D.



E.



F.

D. 9-0700-1-322

1-Light Sconce
Warm Brass Finish
7"W x 15"H x 9"E
1C 60W
White Fabric Shade

E. 9-0700-1-SN

1-Light Sconce
Satin Nickel Finish
7"W x 15"H x 9"E
1C 60W
White Fabric Shade

F. 9-0700-1-109

1-Light Sconce
Polished Nickel Finish
7"W x 15"H x 9"E
1C 60W
White Fabric Shade

POWELL

WALL LIGHTING



A.



B.



C.



A. 9-1755-1-89
1-Light Sconce
Matte Black Finish
5"W x 15"H x 5-1/2"E
1C 60W
White Fabric Shade

B. 9-1755-1-322
1-Light Sconce
Warm Brass Finish
5"W x 15"H x 5-1/2"E
1C 60W
White Fabric Shade

C. 9-1755-1-109
1-Light Sconce
Polished Nickel Finish
5"W x 15"H x 5-1/2"E
1C 60W
White Fabric Shade

WAVERLY

WALL LIGHTING



D.



E.



F.



G.

D. 9-1200-1-SN
1-Light Sconce
Satin Nickel Finish
5"W x 11"H x 6-1/2"E
1C 60W
White Fabric Shade

E. 9-1200-1-89
1-Light Sconce
Matte Black Finish
5"W x 11"H x 6-1/2"E
1C 60W
White Fabric Shade

F. 9-1200-1-322
1-Light Sconce
Warm Brass Finish
5"W x 11"H x 6-1/2"E
1C 60W
White Fabric Shade

G. 9-1200-1-109
1-Light Sconce
Polished Nickel Finish
5"W x 11"H x 6-1/2"E
1C 60W
White Fabric Shade

ASHBOURNE

WALL LIGHTING



ASHBOURNE

WALL LIGHTING



A.

A. 9-400-1-121
1-Light Sconce
Mohican Bronze Finish
6-1/2" W x 26"H x 8"E
1C 60W
Clear Crystal

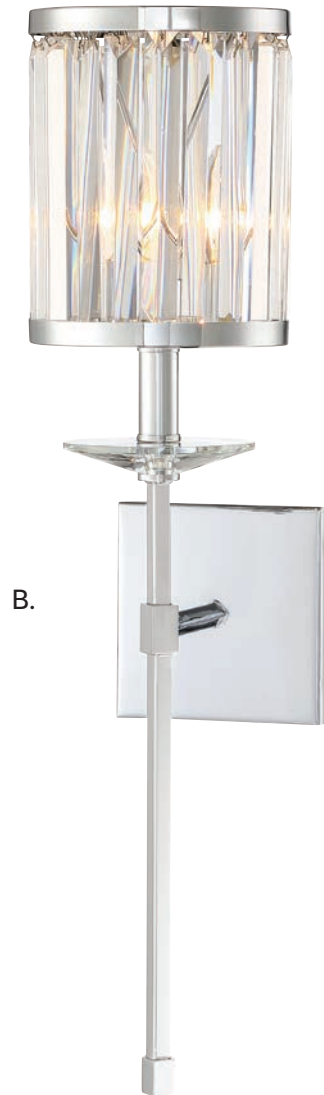

B.

B. 9-400-1-11
1-Light Sconce
Polished Chrome Finish
6-1/2" W x 26"H x 8"E
1C 60W
Clear Crystal

JEFFERSON

WALL LIGHTING



JEFFERSON

WALL LIGHTING

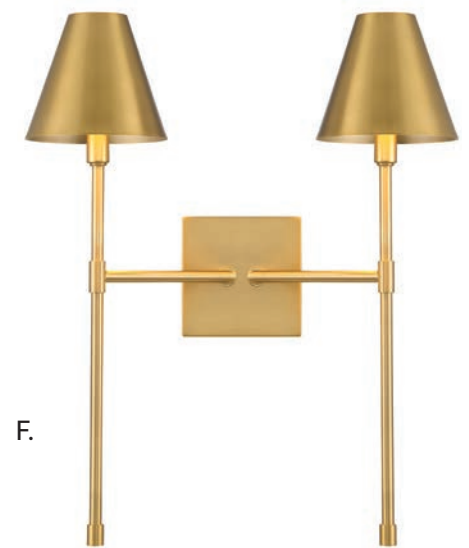
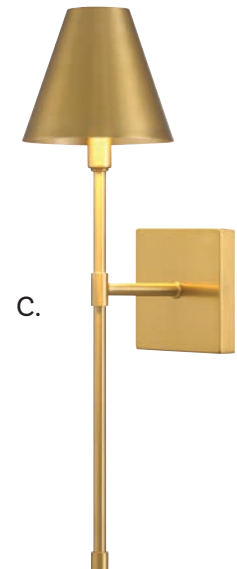
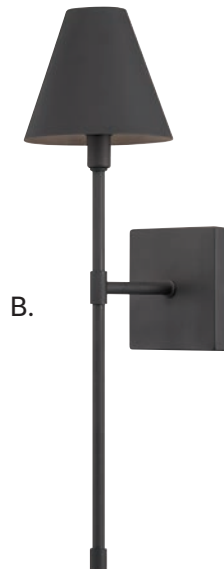
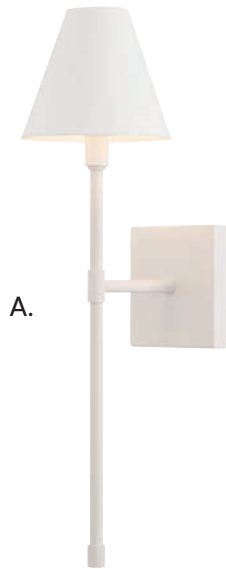

A. 9-5201-1-83
1-Light Sconce
Bisque White
Finish
5-1/2"W x 20"H x 7"E
1C 60W
Metal Shade

B. 9-5201-1-89
1-Light Sconce
Matte Black Finish
5-1/2"W x 20"H x 7"E
1C 60W
Metal Shade

C. 9-5201-1-322
1-Light Sconce
Warm Brass Finish
5-1/2"W x 20"H x 7"E
1C 60W
Metal Shade

D. 9-5202-2-83
2-Light Sconce
Bisque White
Finish
16"W x 20"H x 7"E
2C 60W
Metal Shade

E. 9-5202-2-89
2-Light Sconce
Matte Black Finish
16"W x 20"H x 7"E
2C 60W
Metal Shade

F. 9-5202-2-322
2-Light Sconce
Warm Brass Finish
16"W x 20"H x 7"E
2C 60W
Metal Shade

FREMONT

WALL LIGHTING



A.



B.

A. 9-103-2-SN
2-Light Sconce
Satin Nickel Finish
13"W x 21"H x 6-1/4"E
2C 60W
Soft White Shade

B. 9-101-1-SN
1-Light Sconce
Satin Nickel Finish
5"W x 21"H x 7"E
1C 60W
Soft White Shade

C. 9-103-2-322
2-Light Sconce
Warm Brass Finish
13"W x 21"H x 6-1/4"E
2C 60W
Soft White Shades

D. 9-101-1-89
1-Light Sconce
Matte Black Finish
5"W x 21"H x 7"E
1C 60W
Soft White Shade

FREMONT

WALL LIGHTING



C.



D.



E.



F.



G.



H.

E. 9-103-2-109
2-Light Sconce
Polished Nickel Finish
13"W x 21"H x 6-1/4"E
2C 60W
Soft White Shades

F. 9-101-1-322
1-Light Sconce
Warm Brass Finish
5"W x 21"H x 7"E
1C 60W
Soft White Shade

G. 9-103-2-89
2-Light Sconce
Matte Black Finish
13"W x 21"H x 6-1/4"E
2C 60W
Soft White Shades

H. 9-101-1-109
1-Light Sconce
Polished Nickel Finish
5"W x 21"H x 7"E
1C 60W
Soft White Shade

MONROE

WALL LIGHTING



MONROE

A. 9-302-1-SN
1-Light Sconce
Satin Nickel Finish
5"W x 20"H x 6"E
1C 60W
White Fabric Shade

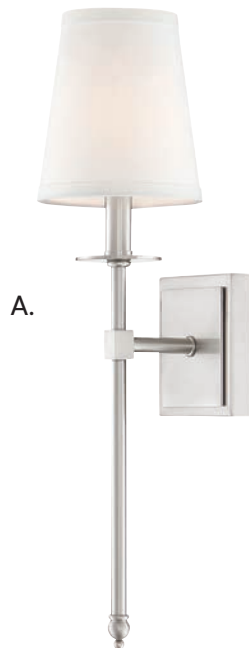

B. 9-303-1-SN
1-Light Sconce
Satin Nickel Finish
5"W x 24"H x 6-1/2"E
1C 60W
White Fabric Shade

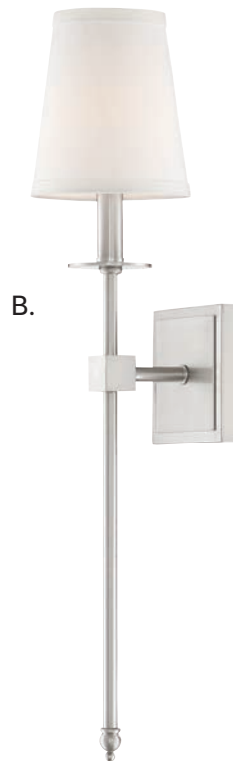

C. 9-7144-1-SN
1-Light Sconce
Satin Nickel Finish
6-3/4"W x 33-1/2"H x 8"E
1C 60W
White Fabric Shade

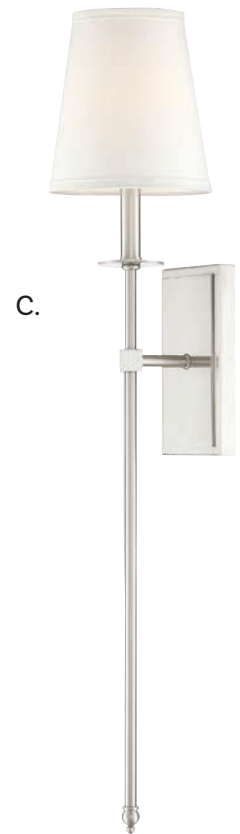

D. 9-7144-1-89
1-Light Sconce
Matte Black Finish
6-3/4"W x 33-1/2"H x 8"E
1C 60W
White Fabric Shade



E. 9-303-1-89
1-Light Sconce
Matte Black Finish
5"W x 24"H x 6-1/2"E
1C 60W
White Fabric Shade

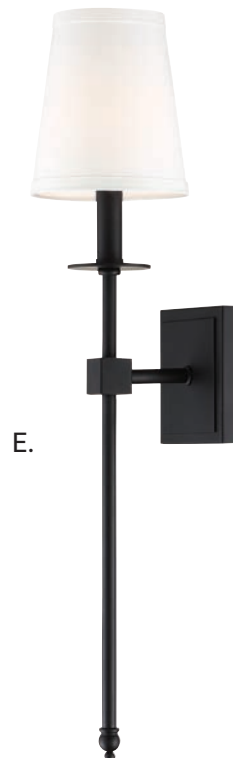

F. 9-302-1-89
1-Light Sconce
Matte Black Finish
5"W x 20"H x 6"E
1C 60W
White Fabric Shade



MONROE

WALL LIGHTING



MONROE

WALL LIGHTING



- G. 9-7144-1-109**
1-Light Sconce
Polished Nickel Finish
6-3/4"W x 33-1/2"H x 8"E
1C 60W
White Fabric Shade

- H. 9-303-1-109**
1-Light Sconce
Polished Nickel Finish
5"W x 24"H x 6-1/2"E
1C 60W
White Fabric Shade

- I. 9-302-1-109**
1-Light Sconce
Polished Nickel Finish
5"W x 20"H x 6"E
1C 60W
White Fabric Shade



G.



H.



I.

GLENN

WALL LIGHTING



A.



B.



C.



D.



E.

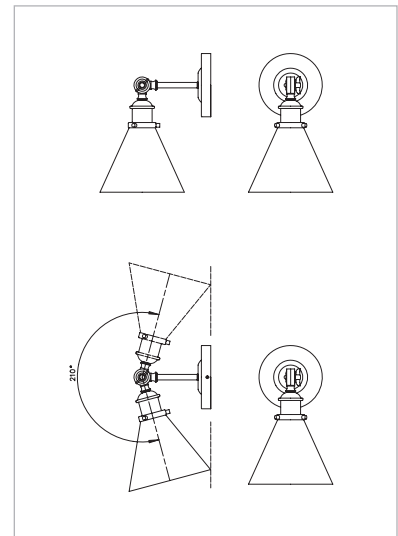

A. 9-0901-1-SN
 1-Light Adjustable
 Sconce
 Satin Nickel Finish
 7"W x 12"H x 9"E
 1E 60W

B. 9-0901-1-44
 1-Light Adjustable
 Sconce
 Classic Bronze Finish
 7"W x 12"H x 9"E
 1E 60W

C. 9-0901-1-109
 1-Light Adjustable
 Sconce
 Polished Nickel Finish
 7"W x 12"H x 9"E
 1E 60W

D. 9-0901-1-322
 1-Light Adjustable
 Sconce
 Warm Brass Finish
 7"W x 12"H x 9"E
 1E 60W

E. 9-0901-1-89
 1-Light Adjustable
 Sconce
 Matte Black Finish
 7"W x 12"H x 9"E
 1E 60W

CORNING / GAVIN

WALL LIGHTING



F.



G.



H.



I.



J.

F. CORNING
9-8884-1-173
 1-Light Sconce
 Matte Black w/ Polished
 Nickel
 8"W x 10-1/2"H x 9-1/2" E
 1E 60W

G. CORNING
9-8884-1-174
 1-Light Sconce
 Navy Blue w/ Polished
 Nickel
 8"W x 10-1/2"H x 9-1/2" E
 1E 60W

H. CORNING
9-8884-1-175
 1-Light Sconce
 Gray w/ Polished
 Nickel
 8"W x 10-1/2"H x 9-1/2" E
 1E 60W

I. GAVIN
9-1686-1-142
 1-Light Sconce
 White w/Warm Brass
 9"W x 8"H x 10"E
 1G9 3.5W

J. GAVIN
9-1686-1-143
 1-Light Sconce
 Matte Black w/
 Warm Brass
 9"W x 8"H x 10"E
 1G9 3.5W

MORLAND

WALL LIGHTING



A.



B.

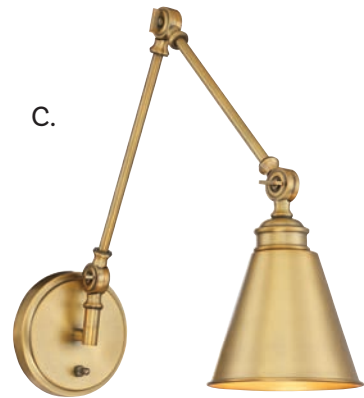

C.

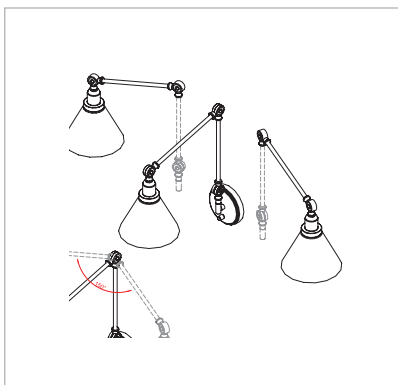

D.



E.

A. 9-961CP-1-89
1-Light Adjustable
Sconce
Matte Black Finish
6"W x 16"H x 13"E
Adj E 13" - 33-3/4"
1E 60W

B. 9-961CP-1-13
1-Light Adjustable
Sconce
English Bronze Finish
6"W x 16"H x 13"E
Adj E 13" - 33-3/4"
1E 60W

C. 9-961CP-1-322
1-Light Adjustable
Sconce
Warm Brass Finish
6"W x 16"H x 13"E
Adj E 13" - 33-3/4"
1E 60W

D. 9-961CP-1-109
1-Light Adjustable
Sconce
Polished Nickel Finish
6"W x 16"H x 13"E
Adj E 13" - 33-3/4"
1E 60W

E. 9-961CP-1-SN
1-Light Adjustable
Sconce
Satin Nickel Finish
6"W x 16"H x 13"E
Adj E 13" - 33-3/4"
1E 60W

Includes cord, plug, and hardware hardware



F.



G.



H.



I.



J.

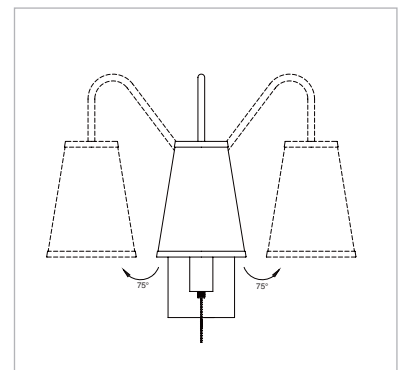

F. 9-0900CP-1-322
 1-Light Adjustable
 Sconce
 Warm Brass Finish
 6-1/8"W x 12-3/8"H x 6"E
 Adj E 6" - 12"
 1E 60W
 White Fabric Shade
 Decorative Pull-Chain

G. 9-0900CP-1-13
 1-Light Adjustable
 Sconce
 English Bronze Finish
 6-1/8"W x 12-3/8"H x 6"E
 Adj E 6" - 12"
 1E 60W
 White Fabric Shade
 Decorative Pull-Chain

H. 9-0900CP-1-89
 1-Light Adjustable
 Sconce
 Matte Black Finish
 6-1/8"W x 12-3/8"H x 6"E
 Adj E 6" - 12"
 1E 60W
 White Fabric Shade
 Decorative Pull-Chain

I. 9-0900CP-1-109
 1-Light Adjustable
 Sconce
 Polished Nickel Finish
 6-1/8"W x 12-3/8"H x 6"E
 Adj E 6" - 12"
 1E 60W
 White Fabric Shade
 Decorative Pull-Chain

J. 9-0900CP-1-SN
 1-Light Adjustable
 Sconce
 Satin Nickel Finish
 6-1/8"W x 12-3/8"H x 6"E
 Adj E 6" - 12"
 1E 60W
 White Fabric Shade
 Decorative Pull-Chain

DAKOTA

WALL LIGHTING

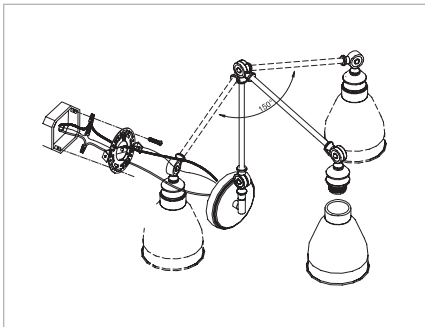
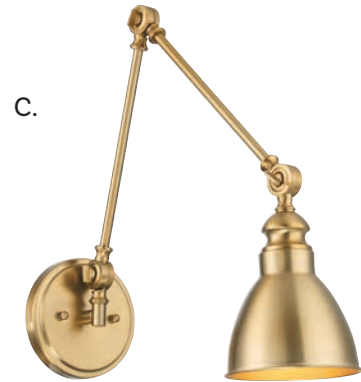

A. 9-960-1-89
1-Light Adjustable Sconce
Matte Black Finish
5-1/2"W x 17"H x 13"E
Adj E 13" - 33-3/4"
1E 60W

B. 9-960-1-13
1-Light Adjustable Sconce
English Bronze Finish
5-1/2"W x 17"H x 13"E
Adj E 13" - 33-3/4"
1E 60W

C. 9-960-1-322
1-Light Adjustable Sconce
Warm Brass Finish
5-1/2"W x 17"H x 13"E
Adj E 13" - 33-3/4"
1E 60W

DRAKE

WALL LIGHTING



D.



E.



F.



G.



H.

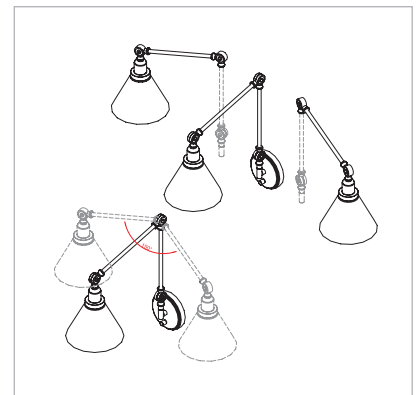

D. 9-9131CP-1-13
 1-Light Adjustable
 Sconce
 English Bronze Finish
 7-1/2"W x 17-1/2"H x 14"E
 Adj E 14" - 34-1/2"
 1E 60W
 Clear Glass

E. 9-9131CP-1-89
 1-Light Adjustable
 Sconce
 Matte Black Finish
 7-1/2"W x 17-1/2"H x 14"E
 Adj E 14" - 34-1/2"
 1E 60W
 Clear Glass

F. 9-9131CP-1-322
 1-Light Adjustable
 Sconce
 Warm Brass Finish
 7-1/2"W x 17-1/2"H x 14"E
 Adj E 14" - 34-1/2"
 1E 60W
 Clear Glass

G. 9-9131CP-1-109
 1-Light Adjustable
 Sconce
 Polished Nickel Finish
 7-1/2"W x 17-1/2"H x 14"E
 Adj E 14" - 34-1/2"
 1E 60W
 Clear Glass

H. 9-9131CP-1-SN
 1-Light Adjustable
 Sconce
 Satin Nickel Finish
 7-1/2"W x 17-1/2"H x 14"E
 Adj E 14" - 34-1/2"
 1E 60W
 Clear Glass

Includes cord, plug, and hardwire hardware

YORK

WALL LIGHTING

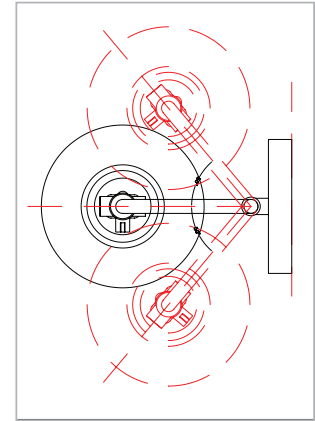

A. 9-108-1-SN
1-Light Adjustable Sconce
Satin Nickel Finish
5-1/2"W x 16"H x 8-1/2"E
1E 60W
Clear Seeded Glass

B. 9-108-1-89
1-Light Adjustable Sconce
Matte Black Finish
5-1/2"W x 16"H x 8-1/2"E
1E 60W
Clear Seeded Glass

C. 9-108-1-322
1-Light Adjustable Sconce
Warm Brass Finish
5-1/2"W x 16"H x 8-1/2"E
1E 60W
Clear Seeded Glass

YORK

WALL LIGHTING



WALL LIGHTING

WALL LIGHTING



A.



B.



A. FAIRCHILD
9-2704-2-322
2-Light Sconce
Warm Brass Finish
12"W x 19-1/2"H
x 5-1/4"E
2C 60W
Faux Crystal

B. BOA
9-3506-3-322
3-Light Sconce
Warm Brass Finish
10-1/2"W x 14"H x 6"E
3C 60W
Frosted Feather Glass

WALL LIGHTING

WALL LIGHTING



C.



D.



E.

LED



F.



G.

LED



H.

C. ISLA BLANCA

9-3172-1-322
1-Light Sconce
Warm Brass Finish
5"W x 9"H x
6-1/2"E
1E 60W
Porcelain Shade

D. LIO

9-6506-1-127
1-Light Sconce
Noble Brass Finish
5"W x 12"H x 5-1/2"E
1E 60W

E. DEL MAR

9-2509-1-322
1-Light Sconce
Warm Brass Finish
5-1/4"W x 13-1/4"H x
4-3/4"E
1.5W Integrated
Dimmable LED
290 Lumens,
3000K, 90+ CRI
Clear Seeded
Acrylic

F. NEWELL

9-8606-2-322
2-Light Sconce
Warm Brass Finish
10-1/4"W x 12"H x
6-1/4"E
2C 60W
Clear Glass
Opal Chimney

G. TALAMANCA

9-7506-1-127
1-Light Sconce
Noble Brass Finish
8"W x 4-3/4"H x
8-1/4"E
5W Integrated
Dimmable LED
500 Lumens,
3000K, 90+ CRI

H. SANTIAGO

9-1935-2-143
2-Light Sconce
Matte Black w/
Warm Brass
8"W x 13-1/4"H x
4-1/2"E
2E 60W
Clear Crystal

WALL LIGHTING

A. BEACON
9-183-2-171
2-Light Sconce
Burnished Brass Finish
8"W x 16"H x 4"E
2C 60W
Frosted White Glass



A.

B. PORTIA
9-2030-2-260
2-Light Sconce
True Gold Finish
8" W x 16"H x 4-3/4"E
2C 60W
Strie Piastra Glass



B.

C. QUATRIN
9-2302-1-260
1-Light Sconce
True Gold Finish
4-3/4"W x 16-1/4"H x 6-1/4"E
1E 60W
White Opal Glass



C.

D. DAHLIA
9-4364-1-322
1-Light Sconce
Warm Brass Finish
9"W x 9-1/4"H x 5" E
1C 60W
White Fabric Shade
Clear Crystal



D.

E. BENNINGTON
9-9702-2-322
2-Light Sconce
Warm Brass Finish
6-1/4"W x 15"H x 6-1/2" E
2C 60W
Clear Ribbed Glass



E.

F. SULLIVAN
9-2204-2-322
2-Light Sconce
Warm Brass Finish
10"W x 9"H x 10" E
2C 60W



F.

WALL LIGHTING

G.



H.



G. ARCHWAY
9-5531-2-143
 2-Light Sconce
 Warm Brass w/
 Matte Black Finish
 9"W x 12-1/2"H x 4"E
 2C 60W

H. QUINCY
9-9944-1-143
 1-Light Sconce
 Warm Brass w/
 Matte Black Finish
 5-1/4"W x 18-1/2"H x 7"E
 1C 60W
 Metal Shade

I.



J.



I. SHELLBOURNE
9-2104-1-322
 1-Light Sconce
 Warm Brass Finish
 5"W x 16-1/2"H x 6-1/2"E
 1C 60W
 Handmade Piastra Glass

J. KAHN
9-6624-1-89
 1-Light Sconce
 Matte Black Finish
 5"W x 9"H x 4" E
 5W Integrated
 Dimmable LED
 342 Lumens,
 3000K, 90+ CRI
 Water Glass

K.



K. DRYDEN
9-1940-2-89
 2-Light Sconce
 Matte Black Finish
 4-1/2"W x 12"H x 5-1/2"E
 4W Integrated
 Dimmable LED
 400 Lumens,
 3000K, 90+ CRI
 Clear Crystal
LED G9 Bulbs Included



WALL LIGHTING

WALL LIGHTING

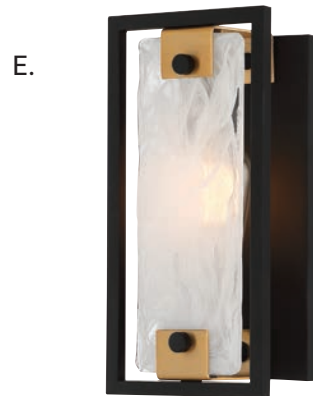

A. MACAULEY
9-2065-1-51
 1-Light Sconce
 Vintage Black w/
 Warm Brass
 4-3/4"W x 20"H x
 7"E
 1E 60W
 Clear Glass

B. DUNBAR
9-9065-1-95
 1-Light Sconce
 Warm Brass w/
 Bronze
 4-3/4"W x 16"H x
 6-3/4"E
 1C 60W
 Clear Glass

C. FULTON
9-5005-1-79
 1-Light Sconce
 English Bronze &
 Warm Brass Finish
 5-1/2"W x 24-1/2"H
 x 7"E
 1C 60W
 Clear Glass

D. GIDEON
9-3164-2-322
 2-Light Sconce
 Warm Brass
 10"W x 11"H x
 4-1/2" E
 2C 60W
 Capiz Shell

E. HAYWARD
9-1697-1-143
 1-Light Sconce
 Matte Black w/
 Warm Brass
 6"W x 12"H x
 4-1/4"E
 1E 60W
 Strie Piastra Glass

F. EATON
9-1977-1-143
 1-Light Sconce
 Matte Black w/
 Warm Brass
 6"W x 8-1/4"H x 7"E
 1E 60W
 Clear Outer Glass
 White Opal
 Chimney

WALL LIGHTING



G. ABEL
9-1638-1-143
 1-Light Sconce
 Matte Black w/
 Warm Brass
 5"W x 19-1/2"H x 4"E
 8W Integrated
 Dimmable LED
 300 Lumens,
 3000K, 90+ CRI
 White Opal Glass

H. KEARNEY
9-8073-2-51
 2-Light Sconce
 Vintage Black w/
 Warm Brass
 12"W x 15"H x 6"E
 2C 60W
 Clear Glass

I. TIVOLI
9-1888-1-143
 1-Light Sconce
 Matte Black w/
 Warm Brass
 5"W x 19"H x 6"E
 1C 60W
 White Fabric Shade
 Clear Crystal
 Accents

J. COUPLET
9-6696-2-143
 2-Light Sconce
 Matte Black w/
 Warm Brass Finish
 10-3/4"W x 20"H x
 4-3/4"E
 2G9 60W
 Frosted Glass

K. OBERYN
9-9157-1-51
 1-Light Sconce
 Vintage Black w/
 Warm Brass
 5-1/2"W x 21-1/2"H
 x 5-1/2"E
 1C 60W
 Clear Seeded
 Glass

L. MIDLAND
9-1905-2-143
 2-Light Sconce
 Matte Black w/
 Warm Brass
 10-1/2"W x 20"H x
 5"E
 2C 60W
 Clear Ribbed
 Glass

LORAINNE / SOUTHERBY

A. LORAINNE
9-9004-1-88
1-Light Sconce
Oxidized Black Finish
4-3/4"W x 17-1/2"H x 5"E
1C 60W
Soft White Fabric Shade



B. LORAINNE
9-9004-2-88
2-Light Sconce
Oxidized Black Finish
12-1/2"W x 17-1/2"H x 6"E
2C 60W
Soft White Fabric Shade



C. SOUTHERBY
9-0159-2-76
2-Light Sconce
Florentian Bronze Finish
13-1/2"W x 19"H x 6"E
2C 60W

D. JAYLAR
9-1649-1-89
1-Light Sconce
Matte Black Finish
5"W x 20"H x 6"E
1C 60W
Natural Cane Shade

E. JAYLAR
9-1648-1-89
1-Light Sconce
Matte Black Finish
5"W x 9"H x 7"E
1E 60W
Natural Cane Shade



JAYLAR



D.



E.



WALL LIGHTING

WALL LIGHTING

A. MELROSE

9-6836-1-11
 1-Light Sconce
 Polished Chrome Finish
 5"W x 7-3/4"H x 6-3/4"E
 1E 60W
 White Opal Etched Glass



A.

B. MELROSE

9-6836-1-13
 1-Light Sconce
 English Bronze Finish
 5"W x 7-3/4"H x 6-3/4"E
 1E 60W
 White Opal Etched Glass



B.



C.

C. MELROSE

9-6836-1-SN
 1-Light Sconce
 Satin Nickel Finish
 5"W x 7-3/4"H x 6-3/4"E
 1E 60W
 White Opal Etched Glass

D. MELROSE

9-6836-1-322
 1-Light Sconce
 Warm Brass Finish
 5"W x 7-3/4"H x 6-3/4"E
 1E 60W
 White Opal Etched Glass



D.



E.



F.

E. HERNDON

9-1007-1-SN
 1-Light Sconce
 Satin Nickel Finish
 5-1/2"W x 10-3/4"H x 7-1/2"E
 1E 60W
 Frosted White Glass

F. HAMPTON

9-1972-1-322
 1-Light Sconce
 Warm Brass Finish
 4-3/4"W x 9-7/8"H x 6-1/2"E
 1E 60W
 Clear Crackled Glass

G. COLTON

9-337-1-13
 1-Light Sconce
 English Bronze Finish
 4-3/4"W x 10"H x 6"E
 1E 60W
 White Opal Glass



G.

H. COLTON

9-337-1-SN
 1-Light Sconce
 Satin Nickel Finish
 4-3/4"W x 10"H x 6"E
 1E 60W
 White Opal Glass



H.

WALL LIGHTING



I.



J.



K.



L.



M.



N.



O.



P.



Q.

- I. CARSON**
9-4050-1-322
1-Light Sconce
Warm Brass Finish
5-1/2"W x 8-1/2"H x 7"E
1E 60W
Clear Glass
- J. CARSON**
9-4050-1-BK
1-Light Sconce
Matte Black Finish
5-1/2"W x 8-1/2"H x 7"E
1E 60W
Clear Glass
- K. CARSON**
9-4050-1-SN
1-Light Sconce
Satin Nickel Finish
5-1/2"W x 8-1/2"H x 7"E
1E 60W
Clear Glass
- L. OCTAVE**
9-4030-1-322
1-Light Sconce
Warm Brass Finish
5"W x 9-1/2"H x 6"E
1E 60W
Clear Glass
- M. OCTAVE**
9-4030-1-BK
1-Light Sconce
Matte Black Finish
5"W x 9-1/2"H x 6"E
1E 60W
Clear Glass
- N. OCTAVE**
9-4030-1-SN
1-Light Sconce
Satin Nickel Finish
5"W x 9-1/2"H x 6"E
1E 60W
Clear Glass
- O. OCTAVE**
9-4030-1-13
1-Light Sconce
English Bronze Finish
5"W x 9-1/2"H x 6"E
1E 60W
Clear Glass
- P. OCTAVE**
9-4030-1-11
1-Light Sconce
Polished Chrome Finish
5"W x 9-1/2"H x 6"E
1E 60W
Clear Glass
- Q. ELISE**
8-9127-1-SN
1-Light Sconce
Satin Nickel Finish
4-1/2"W x 10-1/2"H x 6-1/2"E
1E 60W
Frosted Opal Glass

ALHAMBRA

POUR LE BAIN



ALHAMBRA

POUR LE BAIN



A. 9-6180-1-143

1-Light Sconce
Matte Black w/ Warm Brass
7-3/4"W x 10-1/4"H x 7"E
1C 60W
White Glass

B. 8-6180-2-143

2-Light Bath Bar
Matte Black w/ Warm Brass
16"W x 7-3/4"H x 7"E
2C 60W
White Glass

C. 8-6180-3-143

3-Light Bath Bar
Matte Black w/ Warm Brass
24-1/2"W x 7-3/4"H x 7"E
3C 60W
White Glass

D. 8-6180-4-143

4-Light Bath Bar
Matte Black w/ Warm Brass
32-1/2"W x 7-3/4"H x 7"E
4C 60W
White Glass

BREUR

POUR LE BAIN



BREUR

POUR LE BAIN



A.

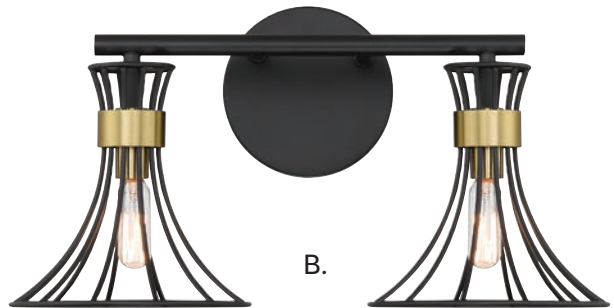

B.



C.



D.

A. 9-6080-1-143
1-Light Sconce
Matte Black w/ Warm Brass
7"W x 9"H x 7-1/2"E
1C 60W

B. 8-6080-2-143
2-Light Bath Bar
Matte Black w/ Warm Brass
17-1/4"W x 9"H x 7-1/2"E
2C 60W

C. 8-6080-3-143
3-Light Bath Bar
Matte Black w/ Warm Brass
28"W x 9"H x 7-1/2"E
3C 60W

D. 8-6080-4-143
4-Light Bath Bar
Matte Black w/ Warm Brass
38"W x 9"H x 7-1/2"E
4C 60W

ABEL

POUR LE BAIN



LED

ABEL

POUR LE BAIN



A.



B.



C.



D.

A. 9-1638-1-143

1-Light Sconce
Matte Black w/ Warm Brass
5"W x 19-1/2"H x 4"E
8W Integrated Dimmable LED
300 Lumens, 3000K, 90+ CRI
White Opal Glass

B. 8-1638-3-143

3-Light Bath Bar
Matte Black w/ Warm Brass
21"W x 10"H x 5"E
8W Integrated Dimmable LED
790 Lumens, 3000K, 90+ CRI
White Opal Glass

C. 8-1638-4-143

4-Light Bath Bar
Matte Black w/ Warm Brass
30"W x 10"H x 5"E
8W Integrated Dimmable LED
1050 Lumens, 3000K, 90+ CRI
White Opal Glass

D. 8-1638-5-143

5-Light Bath Bar
Matte Black w/ Warm Brass
39"W x 10"H x 5"E
8W Integrated Dimmable LED
1200 Lumens, 3000K, 90+ CRI
White Opal Glass

EATON

POUR LE BAIN





A. 9-1977-1-143

1-Light Sconce
Matte Black w/ Warm Brass
6"W x 8-1/4"H x 7"E
1E 60W
Clear Glass
White Opal Chimney

B. 8-1977-2-143

2-Light Bath Bar
Matte Black w/ Warm Brass
15"W x 7-1/2"H x 7-1/2"E
2E 60W
Clear Glass
White Opal Chimney

C. 8-1977-3-143

3-Light Bath Bar
Matte Black w/ Warm Brass
24"W x 7-1/2"H x 7-1/2"E
3E 60W
Clear Glass
White Opal Chimney

D. 8-1977-4-143

4-Light Bath Bar
Matte Black w/ Warm Brass
33"W x 7-1/2"H x 7-1/2"E
4E 60W
Clear Glass
White Opal Chimney

CALDWELL

POUR LE BAIN



A. 8-4128-2-BK
 2-Light Bath Bar
 Matte Black Finish
 14-3/4"W x 8-1/2"H x 5-1/2"E
 2C 60W
 Etched White Opal Glass



B.



A.

B. 9-4128-1-BK
 1-Light Bath Bar
 Matte Black Finish
 4-3/4"W x 9-1/2"H x 5-1/2"E
 1C 60W
 Etched White Opal Glass



C.

C. 8-4128-3-BK
 3-Light Bath Bar
 Matte Black Finish
 24"W x 8-1/2"H x 5-1/2"E
 3C 60W
 Etched White Opal Glass



D.

D. 8-4128-4-BK
 4-Light Bath Bar
 Matte Black Finish
 32"W x 8-1/2"H x 5-1/2"E
 4C 60W
 Etched White Opal Glass

CALDWELL

POUR LE BAIN

E.



E. 8-4128-4-322
4-Light Bath Bar
Warm Brass Finish
32"W x 8-1/2"H x 5-1/2"E
4C 60W
Etched White Opal Glass

F.



F. 8-4128-3-322
3-Light Bath Bar
Warm Brass Finish
24"W x 8-1/2"H x 5-1/2"E
3C 60W
Etched White Opal Glass

H.



H. 8-4128-2-322
2-Light Bath Bar
Warm Brass Finish
14-3/4"W x 8-1/2"H x 5-1/2"E
2C 60W
Etched White Opal Glass

G.



G. 9-4128-1-322
1-Light Bath Bar
Warm Brass Finish
4-3/4"W x 9-1/2"H x 5-1/2"E
1C 60W
Etched White Opal Glass

I.



I. 8-4128-2-SN
2-Light Bath Bar
Satin Nickel Finish
14-3/4"W x 8-1/2"H x 5-1/2"E
2C 60W
Etched White Opal Glass

J.



J. 9-4128-1-SN
1-Light Bath Bar
Satin Nickel Finish
4-3/4"W x 9-1/2"H x 5-1/2"E
1C 60W
Etched White Opal Glass

K.



K. 8-4128-3-SN
3-Light Bath Bar
Satin Nickel Finish
24"W x 8-1/2"H x 5-1/2"E
3C 60W
Etched White Opal Glass

L.



L. 8-4128-4-SN
4-Light Bath Bar
Satin Nickel Finish
32"W x 8-1/2"H x 5-1/2"E
4C 60W
Etched White Opal Glass

Fixtures may be mounted either upright or downlight

WHITNEY

POUR LE BAIN



Fixtures may be mounted either uplight or downlight

WHITNEY



A.



B.



C.

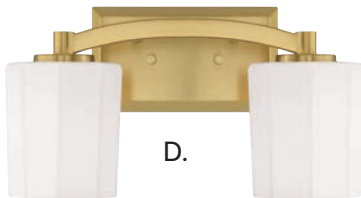

D.



E.



F.



G.



H.



I.

- A. 8-7710-4-BK**
4-Light Bath Bar
Matte Black Finish
33"W x 8"H x 6-1/2"E
4E 60W
Fluted Opal Etched Glass
- B. 8-7710-3-BK**
3-Light Bath Bar
Matte Black Finish
24"W x 8"H x 6-1/2"E
3E 60W
Fluted Opal Etched Glass
- C. 8-7710-2-BK**
2-Light Bath Bar
Matte Black Finish
14"W x 8"H x 6-1/2"E
2E 60W
Fluted Opal Etched Glass
- D. 8-7710-2-322**
2-Light Bath Bar
Warm Brass Finish
14"W x 8"H x 6-1/2"E
2E 60W
Fluted Opal Etched Glass
- E. 8-7710-3-322**
3-Light Bath Bar
Warm Brass Finish
24"W x 8"H x 6-1/2"E
3E 60W
Fluted Opal Etched Glass
- F. 8-7710-4-322**
4-Light Bath Bar
Warm Brass Finish
33"W x 8"H x 6-1/2"E
4E 60W
Fluted Opal Etched Glass
- G. 8-7710-3-SN**
3-Light Bath Bar
Satin Nickel Finish
24"W x 8"H x 6-1/2"E
3E 60W
Fluted Opal Etched Glass
- H. 8-7710-2-SN**
2-Light Bath Bar
Satin Nickel Finish
14"W x 8"H x 6-1/2"E
2E 60W
Fluted Opal Etched Glass
- I. 8-7710-4-SN**
4-Light Bath Bar
Satin Nickel Finish
33"W x 8"H x 6-1/2"E
4E 60W
Fluted Opal Etched Glass

CAPRA

POUR LE BAIN

- A. 8-4090-4-109**
4-Light Bath Bar
Polished Nickel Finish
31"W x 9"H x 6-1/2"E
4E 60W
White Opal Glass



A.

- B. 8-4090-3-109**
3-Light Bath Bar
Polished Nickel Finish
22"W x 9"H x 6-1/2"E
3E 60W
White Opal Glass



B.

- C. 8-4090-2-109**
2-Light Bath Bar
Polished Nickel Finish
15"W x 9"H x 6-1/2"E
2E 60W
White Opal Glass



C.

- D. 8-4090-4-322**
4-Light Bath Bar
Warm Brass Finish
31"W x 9"H x 6-1/2"E
4E 60W
White Opal Glass



D.

- E. 8-4090-3-322**
3-Light Bath Bar
Warm Brass Finish
22"W x 9"H x 6-1/2"E
3E 60W
White Opal Glass



E.

- F. 8-4090-2-322**
2-Light Bath Bar
Warm Brass Finish
15"W x 9"H x 6-1/2"E
2E 60W
White Opal Glass



F.

CAPRA

POUR LE BAIN



Fixtures may be mounted either upright or downlight.

DARBY

POUR LE BAIN



Fixtures may be mounted either uplight or downlight



A. 8-6901-2-322
2-Light Bath Bar
Warm Brass Finish
15-1/4"W x 8"H x 7"E
2E 60W
White Opal Glass

B. 8-6901-3-322
3-Light Bath Bar
Warm Brass Finish
25-1/4"W x 8"H x 7"E
3E 60W
White Opal Glass

C. 8-6901-4-322
4-Light Bath Bar
Warm Brass Finish
34"W x 8"H x 7"E
4E 60W
White Opal Glass

KADEN

POUR LE BAIN



Fixtures may be mounted either uplight or downlight

KADEN



A.



B.

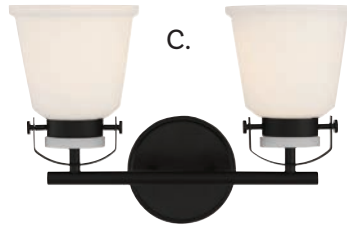

C.

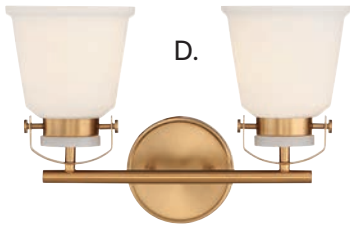

D.



E.



F.



G.

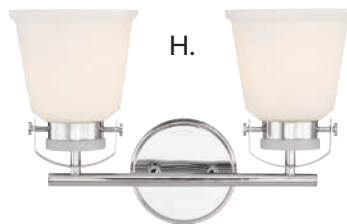

H.

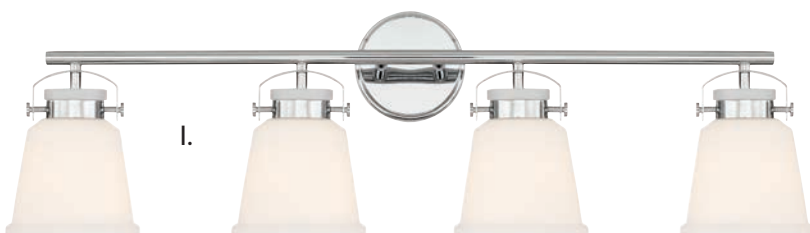

I.

- A. 8-1627-4-BK**
4-Light Bath Bar
Matte Black Finish
34"W x 10-1/2"H x 7"E
4E 60W
White Opal Glass
- B. 8-1627-3-BK**
3-Light Bath Bar
Matte Black Finish
26"W x 10-1/2"H x 7"E
3E 60W
White Opal Glass
- C. 8-1627-2-BK**
2-Light Bath Bar
Matte Black Finish
16"W x 10-1/2"H x 7"E
2E 60W
White Opal Glass
- D. 8-1627-2-322**
2-Light Bath Bar
Warm Bath Bar
16"W x 10-1/2"H x 7"E
2E 60W
White Opal Glass
- E. 8-1627-3-322**
3-Light Bath Bar
Warm Brass Finish
26"W x 10-1/2"H x 7"E
3E 60W
White Opal Glass
- F. 8-1627-4-322**
4-Light Bath Bar
Warm Brass Finish
34"W x 10-1/2"H x 7"E
4E 60W
White Opal Glass
- G. 8-1627-3-11**
3-Light Bath Bar
Polished Chrome Finish
26"W x 10-1/2"H x 7"E
3E 60W
White Opal Glass
- H. 8-1627-2-11**
2-Light Bath Bar
Polished Chrome Finish
16"W x 10-1/2"H x 7"E
2E 60W
White Opal Glass
- I. 8-1627-4-11**
4-Light Bath Bar
Polished Chrome Finish
34"W x 10-1/2"H x 7"E
4E 60W
White Opal Glass

MELROSE

POUR LE BAIN



A. 8-6836-2-322

2-Light Bath Bar
Warm Brass Finish
14-1/2"W x 7-3/4"H x 6-3/4"E
2E 60W
White Opal Etched Glass

B. 8-6836-3-322

3-Light Bath Bar
Warm Brass Finish
24"W x 7-3/4"H x 6-3/4"E
3E 60W
White Opal Etched Glass

C. 8-6836-4-322

4-Light Bath Bar
Warm Brass Finish
33-1/2"W x 7-3/4"H x 6-3/4"E
4E 60W
White Opal Etched Glass

D. 9-6836-1-322

1-Light Sconce
Warm Brass Finish
5"W x 7-3/4"H x 6-3/4"E
1E 60W
White Opal Etched Glass

MELROSE

POUR LE BAIN

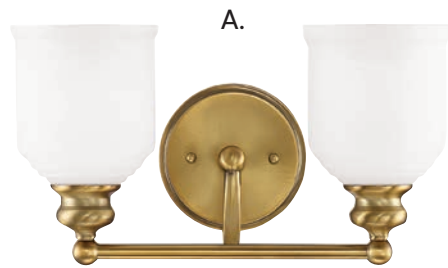

A.



B.



C.



D.



E.



F.



G.



H.

E. 8-6836-2-SN
2-Light Bath Bar
Satin Nickel Finish
14-1/2"W x 7-3/4"H x
6-3/4"E
2E 60W
White Opal Etched Glass

F. 8-6836-3-SN
3-Light Bath Bar
Satin Nickel Finish
24"W x 7-3/4"H x 6-3/4"E
3E 60W
White Opal Etched Glass

G. 8-6836-4-SN
4-Light Bath Bar
Satin Nickel Finish
33-1/2"W x 7-3/4"H x
6-3/4"E
4E 60W
White Opal Etched Glass

H. 9-6836-1-SN
1-Light Sconce
Satin Nickel Finish
5"W x 7-3/4"H x 6-3/4"E
1E 60W
White Opal Etched Glass

Fixtures may be mounted either uplight or downlight.

MELROSE

POUR LE BAIN

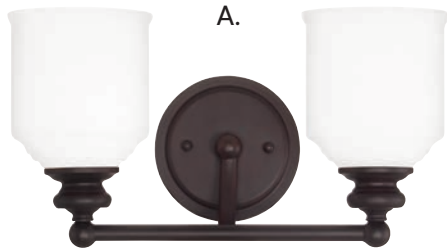

A.



B.



C.



D.

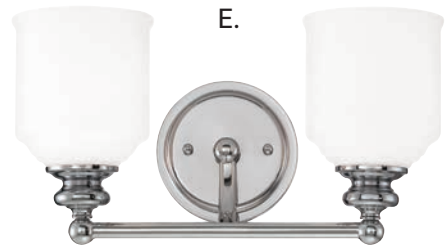

E.



F.



G.



H.

A. 8-6836-2-13
2-Light Bath Bar
English Bronze Finish
14-1/2"W x 7-3/4"H x
6-3/4"E
2E 60W
White Opal Etched Glass

B. 8-6836-3-13
3-Light Bath Bar
English Bronze Finish
24"W x 7-3/4"H x 6-3/4"E
3E 60W
White Opal Etched Glass

C. 8-6836-4-13
4-Light Bath Bar
English Bronze Finish
33-1/2"W x 7-3/4"H x
6-3/4"E
4E 60W
White Opal Etched Glass

D. 9-6836-1-13
1-Light Sconce
English Bronze Finish
5"W x 7-3/4"H x 6-3/4"E
1E 60W
White Opal Etched Glass

MELROSE

POUR LE BAIN



E. 8-6836-2-11
2-Light Bath Bar
Polished Chrome Finish
14-1/2"W x 7-3/4"H x
6-3/4"E
2E 60W
White Opal Etched Glass

F. 8-6836-3-11
3-Light Bath Bar
Polished Chrome Finish
24"W x 7-3/4"H x 6-3/4"E
3E 60W
White Opal Etched Glass

G. 8-6836-4-11
4-Light Bath Bar
Polished Chrome Finish
33-1/2"W x 7-3/4"H x
6-3/4"E
4E 60W
White Opal Etched Glass

H. 9-6836-1-11
1-Light Sconce
Polished Chrome Finish
5"W x 7-3/4"H x 6-3/4"E
1E 60W
White Opal Etched Glass

Fixtures may be mounted either upright or downlight.

CAMERON

POUR LE BAIN



- A. 8-2542-3-322**
3-Light Bath Bar
Warm Brass Finish
24"W x 12"H x 8"E
3C 40W
White Fabric Shades
Metal Candle Covers

- B. 9-2542-1-322**
1-Light Sconce
Warm Brass Finish
5"W x 13"H x 8"E
1C 40W
White Fabric Shade
Metal Candle Cover

- C. 8-2542-2-322**
2-Light Bath Bar
Warm Brass Finish
15"W x 12"H x 8"E
2C 40W
White Fabric Shades
Metal Candle Covers



CAMERON

POUR LE BAIN



D.

- D. 8-2542-3-89**
3-Light Bath Bar
Matte Black Finish
24"W x 12"H x 8"E
3C 40W
White Fabric Shades
Metal Candle Covers



E.

- E. 8-2542-2-89**
2-Light Bath Bar
Matte Black Finish
15"W x 12"H x 8"E
2C 40W
White Fabric Shades
Metal Candle Covers



F.

- F. 9-2542-1-89**
1-Light Sconce
Matte Black Finish
5"W x 13"H x 8"E
1C 40W
White Fabric Shade
Metal Candle Cover



G.

- G. 8-2542-3-109**
3-Light Bath Bar
Polished Nickel Finish
24"W x 12"H x 8"E
3C 40W
White Fabric Shades
Metal Candle Covers



H.

- H. 8-2542-2-109**
2-Light Bath Bar
Polished Nickel Finish
15"W x 12"H x 8"E
2C 40W
White Fabric Shades
Metal Candle Covers



I.

- I. 9-2542-1-109**
1-Light Sconce
Polished Nickel Finish
5"W x 13"H x 8"E
1C 40W
White Fabric Shade
Metal Candle Cover

ADAMS

POUR LE BAIN





A. 9-4417-1-322
 1-Light Sconce
 Warm Brass Finish
 7"W x 11"H x 7-1/2"E
 1E 60W
 White Strie Glass

B. 8-4417-2-322
 2-Light Bath Bar
 Warm Brass Finish
 15-1/2"W x 8-3/4"H x 7"E
 2C 60W
 White Strie Glass

C. 8-4417-3-322
 3-Light Bath Bar
 Warm Brass Finish
 24"W x 8-3/4"H x 7"E
 3C 60W
 White Strie Glass

D. 8-4417-4-322
 4-Light Bath Bar
 Warm Brass Finish
 32"W x 8-3/4"H x 7"E
 4C 60W
 White Strie Glass

SIDNEY

POUR LE BAIN



A.



B.



C.



Fixtures may be mounted either uplight or downlight

SIDNEY

POUR LE BAIN



A. 8-1720-2-143
2-Light Bath Bar
Matte Black w/Warm Brass
14-3/4"W x 8"H x 6-3/4"E
2E 60W
Clear Water Piastra Glass

B. 8-1720-3-143
3-Light Bath Bar
Matte Black w/Warm Brass
23"W x 8"H x 6-3/4"E
3E 60W
Clear Water Piastra Glass

C. 8-1720-4-143
4-Light Bath Bar
Matte Black w/Warm Brass
32"W x 8"H x 6-3/4"E
4E 60W
Clear Water Piastra Glass

BRICKELL

POUR LE BAIN



A.



B.



C.



Fixtures may be mounted either uplight or downlight

BRICKELL

POUR LE BAIN



A. 8-3600-2-322
2-Light Bath Bar
Warm Brass w/Matte Black
14"W x 8-3/4"H x 5"E
2E 60W
Crackled Glass

B. 8-3600-3-322
3-Light Bath Bar
Warm Brass w/Matte Black
22"W x 8-3/4"H x 5"E
3E 60W
Crackled Glass

C. 8-3600-4-322
4-Light Bath Bar
Warm Brass w/Matte Black
30"W x 8-3/4"H x 5"E
4E 60W
Crackled Glass

GENRY

POUR LE BAIN



A. 9-8204-1-109

1-Light Sconce
 Polished Nickel Finish
 5-1/2"W x 13"H x 5-1/2"E
 1C 60W
 Handmade Water Glass



A.



B.

B. 8-8204-2-109

2-Light Bath Bar
 Polished Nickel Finish
 15-1/4"W x 7-3/4"H x 5-1/2"E
 2C 60W
 Handmade Water Glass



C.

C. 8-8204-3-109

3-Light Bath Bar
 Polished Nickel Finish
 25"W x 7-3/4"H x 5-1/2"E
 3C 60W
 Handmade Water Glass



D.

D. 8-8204-4-109

4-Light Bath Bar
 Polished Nickel Finish
 35"W x 7-3/4"H x 5-1/2"E
 4C 60W
 Handmade Water Glass

E.



E. 8-8204-4-322
4-Light Bath Bar
Warm Brass Finish
35"W x 7-3/4"H x 5-1/2"E
4C 60W
Handmade Water Glass

F.



F. 8-8204-3-322
3-Light Bath Bar
Warm Brass Finish
25"W x 7-3/4"H x 5-1/2"E
3C 60W
Handmade Water Glass

H.



H. 8-8204-2-322
2-Light Bath Bar
Warm Brass Finish
15-1/4"W x 7-3/4"H x 5-1/2"E
2C 60W
Handmade Water Glass

G.



G. 9-8204-1-322
1-Light Sconce
Warm Brass Finish
5-1/2"W x 13"H x 5-1/2"E
1C 60W
Handmade Water Glass

I.



I. 8-8204-2-BK
2-Light Bath Bar
Matte Black Finish
15-1/4"W x 7-3/4"H x 5-1/2"E
2C 60W
Handmade Water Glass

J.



J. 9-8204-1-BK
1-Light Sconce
Matte Black Finish
5-1/2"W x 13"H x 5-1/2"E
1C 60W
Handmade Water Glass

K.



K. 8-8204-3-BK
3-Light Bath Bar
Matte Black Finish
25"W x 7-3/4"H x 5-1/2"E
3C 60W
Handmade Water Glass

L.



L. 8-8204-4-BK
4-Light Bath Bar
Matte Black Finish
35"W x 7-3/4"H x 5-1/2"E
4C 60W
Handmade Water Glass

Fixtures may be mounted either uplight or downlight

ADDISON

POUR LE BAIN



A. 9-3981-1-322

1-Light Sconce
Warm Brass Finish
5-3/4"W x 9"H x 5-1/2"E
1C 60W
Clear Starburst Glass

B. 8-3981-4-322

4-Light Bath Bar
Warm Brass Finish
32"W x 9"H x 6-1/2"E
4C 60W
Clear Starburst Glass

C. 8-3981-3-322

3-Light Bath Bar
Warm Brass Finish
24"W x 9"H x 6-1/2"E
3C 60W
Clear Starburst Glass

D. 8-3981-2-322

2-Light Bath Bar
Warm Brass Finish
16"W x 9"H x 6-1/2"E
2C 60W
Clear Starburst Glass

ADDISON

POUR LE BAIN



A.

E. 9-3981-1-11
1-Light Sconce
Polished Chrome Finish
5-3/4"W x 9"H x 5-1/2"E
1C 60W
Clear Starburst Glass



B.

F. 8-3981-4-11
4-Light Bath Bar
Polished Chrome Finish
32"W x 9"H x 6-1/2"E
4C 60W
Clear Starburst Glass



C.

G. 8-3981-3-11
3-Light Bath Bar
Polished Chrome Finish
24"W x 9"H x 6-1/2"E
3C 60W
Clear Starburst Glass



D.

H. 8-3981-2-11
2-Light Bath Bar
Polished Chrome Finish
16"W x 9"H x 6-1/2"E
2C 60W
Clear Starburst Glass

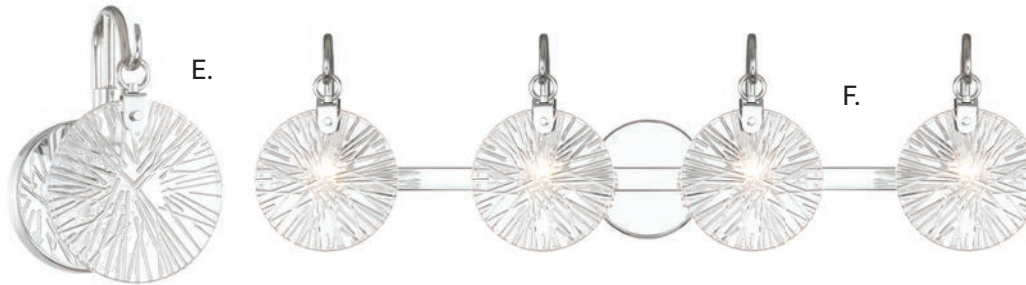

E.

I. 9-3981-1-BK
1-Light Sconce
Matte Black Finish
5-3/4"W x 9"H x 5-1/2"E
1C 60W
Clear Starburst Glass

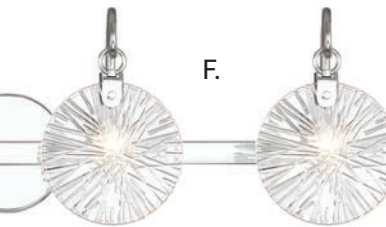

F.

J. 8-3981-4-BK
4-Light Bath Bar
Matte Black Finish
32"W x 9"H x 6-1/2"E
4C 60W
Clear Starburst Glass



G.

K. 8-3981-3-BK
3-Light Bath Bar
Matte Black Finish
24"W x 9"H x 6-1/2"E
3C 60W
Clear Starburst Glass

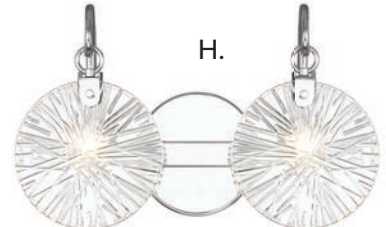

H.

L. 8-3981-2-BK
2-Light Bath Bar
Matte Black Finish
16"W x 9"H x 6-1/2"E
2C 60W
Clear Starburst Glass



I.

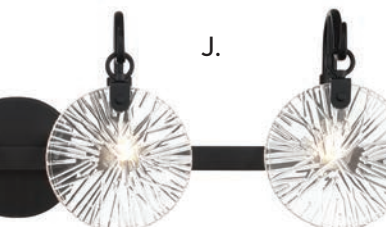

J.



K.



L.

BENNINGTON

POUR LE BAIN



Fixtures may be mounted either uplight or downlight

LED

BENNINGTON

POUR LE BAIN

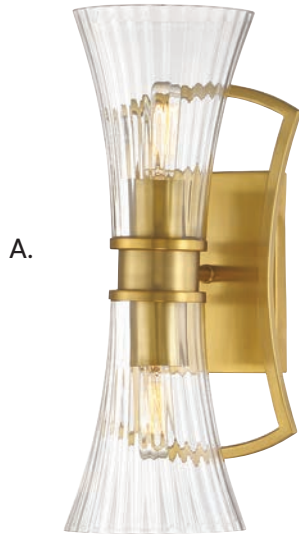

A. 9-9702-2-322
 2-Light Sconce
 Warm Brass Finish
 6-1/4"W x 15"H x 6-1/2"E
 4W Integrated Dimmable LED
 400 Lumens, 3000K, 90+ CRI
 Clear Ribbed Glass
LED G9 Bulbs Included

B. 8-9702-4-322
 4-Light Bath Bar
 Warm Brass Finish
 16"W x 8-3/4"H x 6"E
 4W Integrated Dimmable LED
 400 Lumens, 3000K, 90+ CRI
 Clear Ribbed Glass
LED G9 Bulbs Included

C. 8-9702-6-322
 6-Light Bath Bar
 Warm Brass Finish
 24"W x 8-3/4"H x 6"E
 4W Integrated Dimmable LED
 400 Lumens, 3000K, 90+ CRI
 Clear Ribbed Glass
LED G9 Bulbs Included

D. 8-9702-8-322
 8-Light Bath Bar
 Warm Brass Finish
 32"W x 8-3/4"H x 6"E
 4W Integrated Dimmable LED
 400 Lumens, 3000K, 90+ CRI
 Clear Ribbed Glass
LED G9 Bulbs Included

CANDLER

POUR LE BAIN



CANDLER

POUR LE BAIN

A.



B.



C.



A. 8-3596-2-322
2-Light Bath Bar
Warm Brass Finish
16-1/2"W x 8-3/4"L x 7-1/2"E
2C 60W
Laser Cut Glass

B. 8-3596-3-322
3-Light Bath Bar
Warm Brass Finish
24"W x 8-3/4"L x 7-1/2"E
3C 60W
Laser Cut Glass

C. 8-3596-4-322
4-Light Bath Bar
Warm Brass Finish
32"W x 8-3/4"L x 7-1/2"E
4C 60W
Laser Cut Glass

GARNET

POUR LE BAIN



A.



B.



C.

A. 9-6001-1-322

1-Light Sconce
Warm Brass Finish
5-1/2"W x 20-1/2"H x 7"E
1E 60W
Clear Crystal

B. 9-6001-1-89

1-Light Sconce
Matte Black Finish
5-1/2"W x 20-1/2"H x 7"E
1E 60W
Clear Crystal

C. 9-6001-1-109

1-Light Sconce
Polished Nickel Finish
5-1/2"W x 20-1/2"H x 7"E
1E 60W
Clear Crystal

D. 8-6001-4-322

4-Light Bath Bar
Warm Brass Finish
32"W x 9-1/2"H x 7"E
4E 60W
Clear Crystal

GARNET



D.

E. 8-6001-3-322
3-Light Bath Bar
Warm Brass Finish
24"W x 9-1/2"H x 7"E
3E 60W
Clear Crystal



E.

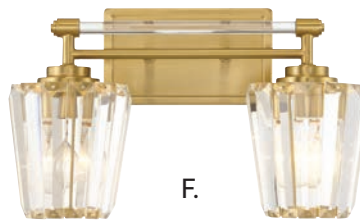

F.

F. 8-6001-2-322
2-Light Bath Bar
Warm Brass Finish
16"W x 9-1/2"H x 7"E
2E 60W
Clear Crystal

G. 8-6001-4-BK
4-Light Bath Bar
Matte Black Finish
32"W x 9-1/2"H x 7"E
4E 60W
Clear Crystal



G.

H. 8-6001-3-BK
3-Light Bath Bar
Matte Black Finish
24"W x 9-1/2"H x 7"E
3E 60W
Clear Crystal



H.



I.

I. 8-6001-2-BK
2-Light Bath Bar
Matte Black Finish
16"W x 9-1/2"H x 7"E
2E 60W
Clear Crystal

J. 8-6001-4-109
4-Light Bath Bar
Polished Nickel Finish
32"W x 9-1/2"H x 7"E
4E 60W
Clear Crystal



J.

K. 8-6001-3-109
3-Light Bath Bar
Polished Nickel Finish
24"W x 9-1/2"H x 7"E
3E 60W
Clear Crystal



K.



L.

L. 8-6001-2-109
2-Light Bath Bar
Polished Nickel Finish
16"W x 9-1/2"H x 7"E
2E 60W
Clear Crystal

Fixtures may be mounted either uplight or downlight

MORENO

POUR LE BAIN



Fixtures may be mounted either uplight or downlight

MORENO

POUR LE BAIN



A.

- A. 8-6601-4-BK**
 4-Light Bath Bar
 Matte Black Finish
 31"W x 9-1/2"H
 x 6-3/4"E
 4E 60W
 Clear Crystal



B.

- B. 8-6601-3-BK**
 3-Light Bath Bar
 Matte Black Finish
 23-1/2"W x 9-1/2"H
 x 6-3/4"E
 3E 60W
 Clear Crystal

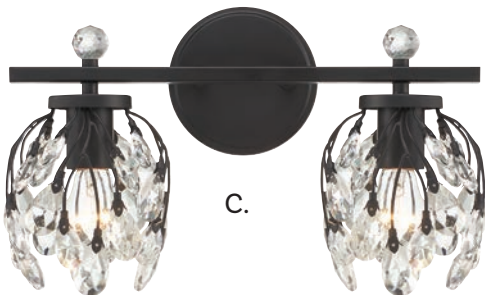

C.

- C. 8-6601-2-BK**
 2-Light Bath Bar
 Matte Black Finish
 15-1/2"W x 9-1/2"H
 x 6-3/4"E
 2E 60W
 Clear Crystal



D.

- D. 8-6601-2-11**
 2-Light Bath Bar
 Chrome Finish
 15-1/2"W x 9-1/2"H
 x 6-3/4"E
 2E 60W
 Clear Crystal



E.

- E. 8-6601-4-11**
 4-Light Bath Bar
 Chrome Finish
 31"W x 9-1/2"H
 x 6-3/4"E
 4E 60W
 Clear Crystal



F.

- F. 8-6601-3-11**
 3-Light Bath Bar
 Chrome Finish
 23-1/2"W x 9-1/2"H
 x 6-3/4"E
 3E 60W
 Clear Crystal

CONCORD

POUR LE BAIN



Fixtures may be mounted either uplight or downlight

CONCORD



A. 8-1102-4-143
 4-Light Bath Bar
 Matte Black w/ Warm Brass Finish
 30-3/4"W x 10-1/2"H x 6-1/2"E
 4E 60W
 Clear Ribbed Glass



B. 8-1102-3-143
 3-Light Bath Bar
 Matte Black w/ Warm Brass Finish
 22"W x 10-1/2"H x 6-1/2"E
 3E 60W
 Clear Ribbed Glass



C. 9-1102-1-143
 1-Light Sconce
 Matte Black w/ Warm Brass Finish
 4-1/2"W x 10-1/2"H x 6-1/2"E
 1E 60W
 Clear Ribbed Glass



D. 8-1102-2-143
 2-Light Bath Bar
 Matte Black w/ Warm Brass Finish
 15"W x 10-1/2"H x 6-1/2"E
 2E 60W
 Clear Ribbed Glass



E. 8-1102-2-146
 2-Light Bath Bar
 Silver w/ Polished Nickel Finish
 15"W x 10-1/2"H x 6-1/2"E
 2E 60W
 Clear Ribbed Glass



F. 9-1102-1-146
 1-Light Sconce
 Silver w/ Polished Nickel Finish
 4-1/2"W x 10-1/2"H x 6-1/2"E
 1E 60W
 Clear Ribbed Glass



G. 8-1102-3-146
 3-Light Bath Bar
 Silver w/ Polished Nickel Finish
 22"W x 10-1/2"H x 6-1/2"E
 3E 60W
 Clear Ribbed Glass



H. 8-1102-4-146
 4-Light Bath Bar
 Silver w/ Polished Nickel Finish
 30-3/4"W x 10-1/2"H x 6-1/2"E
 4E 60W
 Clear Ribbed Glass

CHANTILLY

POUR LE BAIN



Fixtures may be mounted either uplight or downlight

CHANTILLY



A.



B.

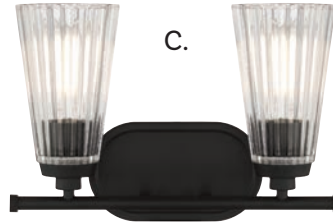

C.



D.



E.

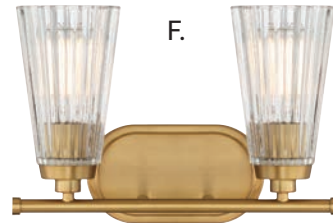

F.



G.



H.



I.

- A. 8-1745-4-BK**
4-Light Bath Bar
Matte Black Finish
30-1/2"W x 10"H x 7"E
4E 60W
Clear Ribbed Glass
- B. 8-1745-3-BK**
3-Light Bath Bar
Matte Black Finish
22"W x 10"H x 7"E
3E 60W
Clear Ribbed Glass
- C. 8-1745-2-BK**
2-Light Bath Bar
Matte Black Finish
14"W x 10"H x 7"E
2E 60W
Clear Ribbed Glass
- D. 8-1745-4-322**
4-Light Bath Bar
Warm Brass Finish
30-1/2"W x 10"H x 7"E
4E 60W
Clear Ribbed Glass
- E. 8-1745-3-322**
3-Light Bath Bar
Warm Brass Finish
22"W x 10"H x 7"E
3E 60W
Clear Ribbed Glass
- F. 8-1745-2-322**
2-Light Bath Bar
Warm Brass Finish
14"W x 10"H x 7"E
2E 60W
Clear Ribbed Glass
- G. 8-1745-4-109**
4-Light Bath Bar
Polished Nickel Finish
30-1/2"W x 10"H x 7"E
4E 60W
Clear Ribbed Glass
- H. 8-1745-3-109**
3-Light Bath Bar
Polished Nickel Finish
22"W x 10"H x 7"E
3E 60W
Clear Ribbed Glass
- I. 8-1745-2-109**
2-Light Bath Bar
Polished Nickel Finish
14"W x 10"H x 7"E
2E 60W
Clear Ribbed Glass

CALHOUN

POUR LE BAIN



Fixtures may be mounted either uplight or downlight.

CALHOUN

POUR LE BAIN



A.

A. 8-1020-4-SN
4-Light Bath Bar
Satin Nickel Finish
32"W x 8-3/4"H x 6-3/8"E
4E 60W
Clear Glass



B.

B. 8-1020-3-SN
3-Light Bath Bar
Satin Nickel Finish
24"W x 8-3/4"H x 6-3/8"E
3E 60W
Clear Glass



C.

C. 8-1020-2-SN
2-Light Bath Bar
Satin Nickel Finish
14-5/8"W x 8-3/4"H x 6-3/8"E
2E 60W
Clear Glass



D.

D. 8-1020-4-BK
4-Light Bath Bar
Matte Black Finish
32"W x 8-3/4"H x 6-3/8"E
4E 60W
Clear Glass



E.

E. 8-1020-3-BK
3-Light Bath Bar
Matte Black Finish
24"W x 8-3/4"H x 6-3/8"E
3E 60W
Clear Glass



F.

F. 8-1020-2-BK
2-Light Bath Bar
Matte Black Finish
14-5/8"W x 8-3/4"H x 6-3/8"E
2E 60W
Clear Glass



G.

G. 8-1020-4-322
4-Light Bath Bar
Warm Brass Finish
32"W x 8-3/4"H x 6-3/8"E
4E 60W
Clear Glass



H.

H. 8-1020-3-322
3-Light Bath Bar
Warm Brass Finish
24"W x 8-3/4"H x 6-3/8"E
3E 60W
Clear Glass



I.

I. 8-1020-2-322
2-Light Bath Bar
Warm Brass Finish
14-5/8"W x 8-3/4"H x 6-3/8"E
2E 60W
Clear Glass

BALLAS

POUR LE BAIN



Fixtures may be mounted either uplight or downlight.

BALLAS

POUR LE BAIN

A. 8-5606-4-BK
4-Light Bath Bar
Matte Black Finish
31-1/2"W x 9-3/4"H x 6-1/2"E
4E 60W
Clear Hammered Glass



A.

B. 8-5606-3-BK
3-Light Bath Bar
Matte Black Finish
23-1/2"W x 9-3/4"H x 6-1/2"E
3E 60W
Clear Hammered Glass



B.

C. 8-5606-2-BK
2-Light Bath Bar
Matte Black Finish
15-1/2"W x 9-3/4"H x 6-1/2"E
2E 60W
Clear Hammered Glass



C.

D. 8-5606-4-SN
4-Light Bath Bar
Satin Nickel Finish
31-1/2"W x 9-3/4"H x 6-1/2"E
4E 60W
Clear Hammered Glass



D.

E. 8-5606-3-SN
3-Light Bath Bar
Satin Nickel Finish
23-1/2"W x 9-3/4"H x 6-1/2"E
3E 60W
Clear Hammered Glass



E.

F. 8-5606-2-SN
2-Light Bath Bar
Satin Nickel Finish
15-1/2"W x 9-3/4"H x 6-1/2"E
2E 60W
Clear Hammered Glass



F.

DRAKE

POUR LE BAIN



DRAKE

POUR LE BAIN



- A. 8-9130-4-322**
4-Light Bath Bar
Warm Brass Finish
38"W x 10"H x 7-1/2"E
4E 60W
Clear Glass
- B. 8-9130-3-322**
3-Light Bath Bar
Warm Brass Finish
28-1/2"W x 10"H x 7-1/2"E
3E 60W
Clear Glass
- C. 8-9130-2-322**
2-Light Bath Bar
Warm Brass Finish
17-3/4"W x 10"H x 7-1/2"E
2E 60W
Clear Glass
- D. 8-9130-2-BK**
2-Light Bath Bar
Matte Black Finish
17-3/4"W x 10"H x 7-1/2"E
2E 60W
Clear Glass
- E. 8-9130-3-BK**
3-Light Bath Bar
Matte Black Finish
28-1/2"W x 10"H x 7-1/2"E
3E 60W
Clear Glass
- F. 8-9130-4-BK**
4-Light Bath Bar
Matte Black Finish
38"W x 10"H x 7-1/2"E
4E 60W
Clear Glass

Fixtures may be mounted either upright or downlight.

DRAKE

POUR LE BAIN



- | | | | | | |
|--|--|--|--|--|--|
| A. 8-9130-4-109
4-Light Bath Bar
Polished Nickel
Finish
38"W x 10"H x
7-1/2"E
4E 60W
Clear Glass | B. 8-9130-3-109
3-Light Bath Bar
Polished Nickel
Finish
28-1/2"W x 10"H x
7-1/2"E
3E 60W
Clear Glass | C. 8-9130-2-109
2-Light Bath Bar
Polished Nickel
Finish
17-3/4"W x 10"H x
7-1/2"E
2E 60W
Clear Glass | D. 8-9130-2-13
2-Light Bath Bar
English Bronze
Finish
17-3/4"W x 10"H x
7-1/2"E
2E 60W
Clear Glass | E. 8-9130-3-13
3-Light Bath Bar
English Bronze
Finish
28-1/2"W x 10"H x
7-1/2"E
3E 60W
Clear Glass | F. 8-9130-4-13
4-Light Bath Bar
English Bronze
Finish
38"W x 10"H x
7-1/2"E
4E 60W
Clear Glass |
|--|--|--|--|--|--|

DRAKE

POUR LE BAIN

A.



B.



C.



D.



E.



F.



Fixtures may be mounted either upright or downlight.

GORDON

POUR LE BAIN



Fixtures may be mounted either uplight or downlight



A. 8-2603-6-BK
 6-Light Bath Bar
 Matte Black Finish
 34"W x 8-3/4"H x 5-1/2"E
 6E 60W
 Clear Water Glass

B. 8-2603-4-BK
 4-Light Bath Bar
 Matte Black Finish
 22"W x 8-3/4"H x 5-1/2"E
 4E 60W
 Clear Water Glass

C. 8-2603-6-CH
 6-Light Bath Bar
 Polished Chrome Finish
 34"W x 8-3/4"H x 5-1/2"E
 6E 60W
 Clear Water Glass

D. 8-2603-4-CH
 4-Light Bath Bar
 Polished Chrome Finish
 22"W x 8-3/4"H x 5-1/2"E
 4E 60W
 Clear Water Glass

LAKEWOOD

POUR LE BAIN



LAKEWOOD

POUR LE BAIN



A.



B.



C.



D.



E.



F.



G.



H.

A. 9-1830-1-89
1-Light Sconce
Matte Black Finish
5-1/2"W x 9-1/2"H x 6-1/2"E
1E 60W
Clear Glass

B. 8-1830-2-BK
2-Light Bath Bar
Matte Black Finish
16"W x 9-1/2"H x 6-1/2"E
2E 60W
Clear Glass

C. 8-1830-3-BK
3-Light Bath Bar
Matte Black Finish
24"W x 9-1/2"H x 6-1/2"E
3E 60W
Clear Glass

D. 8-1830-4-BK
4-Light Bath Bar
Matte Black Finish
32"W x 9-1/2"H x 6-1/2"E
4E 60W
Clear Glass

E. 8-1830-4-322
4-Light Bath Bar
Warm Brass Finish
32"W x 9-1/2"H x 6-1/2"E
4E 60W
Clear Glass

F. 8-1830-3-322
3-Light Bath Bar
Warm Brass Finish
24"W x 9-1/2"H x 6-1/2"E
3E 60W
Clear Glass

G. 9-1830-1-322
1-Light Sconce
Warm Brass Finish
5-1/2"W x 9-1/2"H x 6-1/2"E
1E 60W
Clear Glass

H. 8-1830-2-322
2-Light Bath Bar
Warm Brass Finish
16"W x 9-1/2"H x 6-1/2"E
2E 60W
Clear Glass

SACREMENTO

POUR LE BAIN



Fixtures may be mounted either uplight or downlight.

SACRAMENTO



- A. 8-7045-4-SN**
4-Light Bath Bar
Satin Nickel Finish
32"W x 8-1/2"H x 5-3/8"E
4E 60W
Clear Seeded Glass



- B. 8-7045-3-SN**
3-Light Bath Bar
Satin Nickel Finish
24"W x 8-1/2"H x 5-3/8"E
3E 60W
Clear Seeded Glass



- C. 8-7045-2-SN**
2-Light Bath Bar
Satin Nickel Finish
14"W x 8-1/2"H x 5-3/8"E
2E 60W
Clear Seeded Glass

- D. 8-7045-4-BK**
4-Light Bath Bar
Matte Black Finish
32"W x 8-1/2"H x 5-3/8"E
4E 60W
Clear Seeded Glass



- E. 8-7045-3-BK**
3-Light Bath Bar
Matte Black Finish
24"W x 8-1/2"H x 5-3/8"E
3E 60W
Clear Seeded Glass



- F. 8-7045-2-BK**
2-Light Bath Bar
Matte Black Finish
14"W x 8-1/2"H x 5-3/8"E
2E 60W
Clear Seeded Glass



ALBANY

POUR LE BAIN



- | | | | | | |
|---|---|---|--|---|--|
| A. 8-560-4-BK
4-Light Bath Bar
Matte Black Finish
32"W x 11-3/8"H x
7-5/8"E
4E 60W
Clear Water Glass | B. 8-560-3-BK
3-Light Bath Bar
Matte Black Finish
24"W x 11-3/8"H x
7-5/8"E
3E 60W
Clear Water Glass | C. 8-560-2-BK
2-Light Bath Bar
Matte Black Finish
16"W x 11-3/8"H x
6-3/4"E
2E 60W
Clear Water Glass | D. 8-560-4-11
4-Light Bath Bar
Polished
Chrome Finish
32"W x 11-3/8"H x
7-5/8"E
4E 60W
Clear Water Glass | E. 8-560-3-11
3-Light Bath Bar
Polished
Chrome Finish
24"W x 11-3/8"H x
7-5/8"
3E 60W
Clear Water Glass | F. 8-560-2-11
2-Light Bath Bar
Polished
Chrome Finish
16"W x 11-3/8"H x
6-3/4"E
2E 60W
Clear Water Glass |
|---|---|---|--|---|--|

ALBANY

POUR LE BAIN



OCTAVE

POUR LE BAIN



Fixtures may be mounted either uplight or downlight.

OCTAVE

POUR LE BAIN



A.



C.



D.



E.



G.



H.



B.



F.

A. 8-4030-2-BK
2-Light Bath Bar
Matte Black Finish
13-3/4"W x 9"H x 5-1/2"E
2E 60W
Clear Glass

B. 9-4030-1-BK
1-Light Sconce
Matte Black Finish
5"W x 9-1/2"H x 6"E
1E 60W
Clear Glass

C. 8-4030-3-BK
3-Light Bath Bar
Matte Black Finish
21"W x 9"H x 5-1/2"E
3E 60W
Clear Glass

D. 8-4030-4-BK
4-Light Bath Bar
Matte Black Finish
28-3/4"W x 9"H x 5-1/2"E
4E 60W
Clear Glass

E. 8-4030-2-11
2-Light Bath Bar
Polished Chrome Finish
13-3/4"W x 9"H x 5-1/2"E
2E 60W
Clear Glass

F. 9-4030-1-11
1-Light Sconce
Polished Chrome Finish
5"W x 9-1/2"H x 6"E
1E 60W
Clear Glass

G. 8-4030-3-11
3-Light Bath Bar
Polished Chrome Finish
21"W x 9"H x 5-1/2"E
3E 60W
Clear Glass

H. 8-4030-4-11
4-Light Bath Bar
Polished Chrome Finish
28-3/4"W x 9"H x 5-1/2"E
4E 60W
Clear Glass

OCTAVE

POUR LE BAIN

A. 9-4030-1-13
 1-Light Sconce
 English Bronze Finish
 5"W x 9-1/2"H x 6"E
 1E 60W
 Clear Glass



A.

B. 8-4030-2-13
 2-Light Bath Bar
 English Bronze Finish
 13-3/4"W x 9"H x 5-1/2"E
 2E 60W
 Clear Glass



B.

C. 8-4030-3-13
 3-Light Bath Bar
 English Bronze Finish
 21"W x 9"H x 5-1/2"E
 3E 60W
 Clear Glass



C.

D. 8-4030-4-13
 4-Light Bath Bar
 English Bronze Finish
 28-3/4"W x 9"H x 5-1/2"E
 4E 60W
 Clear Glass



D.

E. 9-4030-1-322
 1-Light Sconce
 Warm Brass Finish
 5"W x 9-1/2"H x 6"E
 1E 60W
 Clear Glass



E.

F. 8-4030-2-322
 2-Light Bath Bar
 Warm Brass Finish
 13-3/4"W x 9"H x 5-1/2"E
 2E 60W
 Clear Glass



F.

G. 8-4030-3-322
 3-Light Bath Bar
 Warm Brass Finish
 21"W x 9"H x 5-1/2"E
 3E 60W
 Clear Glass



G.

H. 8-4030-4-322
 4-Light Bath Bar
 Warm Brass Finish
 28-3/4"W x 9"H x 5-1/2"E
 4E 60W
 Clear Glass



H.

Fixtures may be mounted either uplight or downlight.

OCTAVE

POUR LE BAIN



I.



J.



K.



L.

I. 8-4030-2-SN
2-Light Bath Bar
Satin Nickel Finish
13-3/4"W x 9"H x 5-1/2"E
2E 60W
Clear Glass

J. 9-4030-1-SN
1-Light Sconce
Satin Nickel Finish
5"W x 9-1/2"H x 6"E
1E 60W
Clear Glass

K. 8-4030-3-SN
3-Light Bath Bar
Satin Nickel Finish
21"W x 9"H x 5-1/2"E
3E 60W
Clear Glass

L. 8-4030-4-SN
4-Light Bath Bar
Satin Nickel Finish
28-3/4"W x 9"H x 5-1/2"E
4E 60W
Clear Glass

WRIGHT

POUR LE BAIN



A.



B.



C.

A. 9-3076-1-89

1-Light Sconce
Matte Black Finish
5-3/4"W x 10"H x 7-1/2"E
1E 60W
Clear Glass

B. 9-3076-1-322

1-Light Sconce
Warm Brass Finish
5-3/4"W x 10"H x 7-1/2"E
1E 60W
Clear Glass

C. 9-3076-1-11

1-Light Sconce
Polished Chrome Finish
5-3/4"W x 10"H x 7-1/2"E
1E 60W
Clear Glass



D.



E.

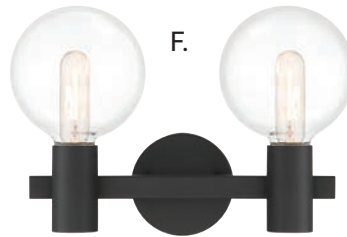

F.

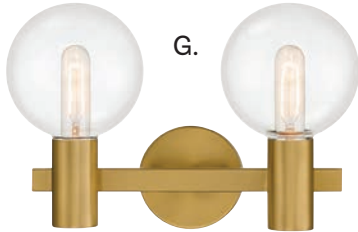

G.

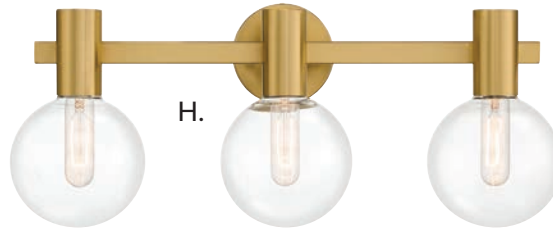

H.



I.

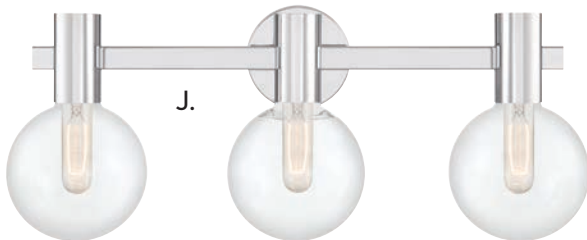

J.

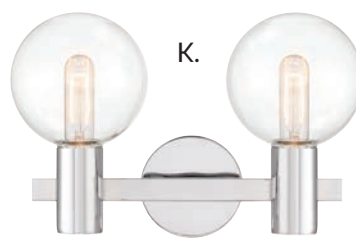

K.



L.

- D. 8-3076-4-BK**
4-Light Bath Bar
Matte Black Finish
34"W x 10"H x 7-1/2"E
4E 60W
Clear Glass
- E. 8-3076-3-BK**
3-Light Bath Bar
Matte Black Finish
25"W x 10"H x 7-1/2"E
3E 60W
Clear Glass
- F. 8-3076-2-BK**
2-Light Bath Bar
Matte Black Finish
15-1/2"W x 10"H x 7-1/2"E
2E 60W
Clear Glass
- G. 8-3076-2-322**
2-Light Bath Bar
Warm Brass Finish
15-1/2"W x 10"H x 7-1/2"E
2E 60W
Clear Glass
- H. 8-3076-3-322**
3-Light Bath Bar
Warm Brass Finish
25"W x 10"H x 7-1/2"E
3E 60W
Clear Glass
- I. 8-3076-4-322**
4-Light Bath Bar
Warm Brass Finish
34"W x 10"H x 7-1/2"E
4E 60W
Clear Glass
- J. 8-3076-3-11**
3-Light Bath Bar
Polished Chrome Finish
25"W x 10"H x 7-1/2"E
3E 60W
Clear Glass
- K. 8-3076-2-11**
2-Light Bath Bar
Polished Chrome Finish
15-1/2"W x 10"H x 7-1/2"E
2E 60W
Clear Glass
- L. 8-3076-4-11**
4-Light Bath Bar
Polished Chrome Finish
34"W x 10"H x 7-1/2"E
4E 60W
Clear Glass

Fixtures may be mounted either upright or downlight

CARSON

POUR LE BAIN



- A. 8-4050-4-SN**
 4-Light Bath Bar
 Satin Nickel Finish
 30"W x 8-1/2"H x 7"E
 4E 60W
 Clear Glass



A.

- B. 8-4050-3-SN**
 3-Light Bath Bar
 Satin Nickel Finish
 22-1/2"W x 8-1/2"H x 7"E
 3E 60W
 Clear Glass



B.

- C. 9-4050-1-SN**
 1-Light Sconce
 Satin Nickel Finish
 5-1/2"W x 8-1/2"H x 7"E
 1E 60W
 Clear Glass



C.

- D. 8-4050-2-SN**
 2-Light Bath Bar
 Satin Nickel Finish
 14"W x 8-1/2"H x 7"E
 2E 60W
 Clear Glass



D.



E.

E. 8-4050-4-BK
4-Light Bath Bar
Matte Black Finish
30"W x 8-1/2"H x 7"E
4E 60W
Clear Glass



F.

F. 8-4050-3-BK
3-Light Bath Bar
Matte Black Finish
22-1/2"W x 8-1/2"H x 7"E
3E 60W
Clear Glass



G.

G. 8-4050-2-BK
2-Light Bath Bar
Matte Black Finish
14"W x 8-1/2"H x 7"E
2E 60W
Clear Glass



H.

H. 9-4050-1-BK
1-Light Sconce
Matte Black Finish
5-1/2"W x 8-1/2"H x 7"E
1E 60W
Clear Glass



I.

I. 8-4050-4-322
4-Light Bath Bar
Warm Brass Finish
30"W x 8-1/2"H x 7"E
4E 60W
Clear Glass



J.

J. 8-4050-3-322
3-Light Bath Bar
Warm Brass Finish
22-1/2"W x 8-1/2"H x 7"E
3E 60W
Clear Glass



K.

K. 8-4050-2-322
2-Light Bath Bar
Warm Brass Finish
14"W x 8-1/2"H x 7"E
2E 60W
Clear Glass



L.

L. 9-4050-1-322
1-Light Sconce
Warm Brass Finish
5-1/2"W x 8-1/2"H x 7"E
1E 60W
Clear Glass

Fixtures may be mounted either uplight or downlight.

MASON

POUR LE BAIN



Fixtures may be mounted either uplight or downlight.

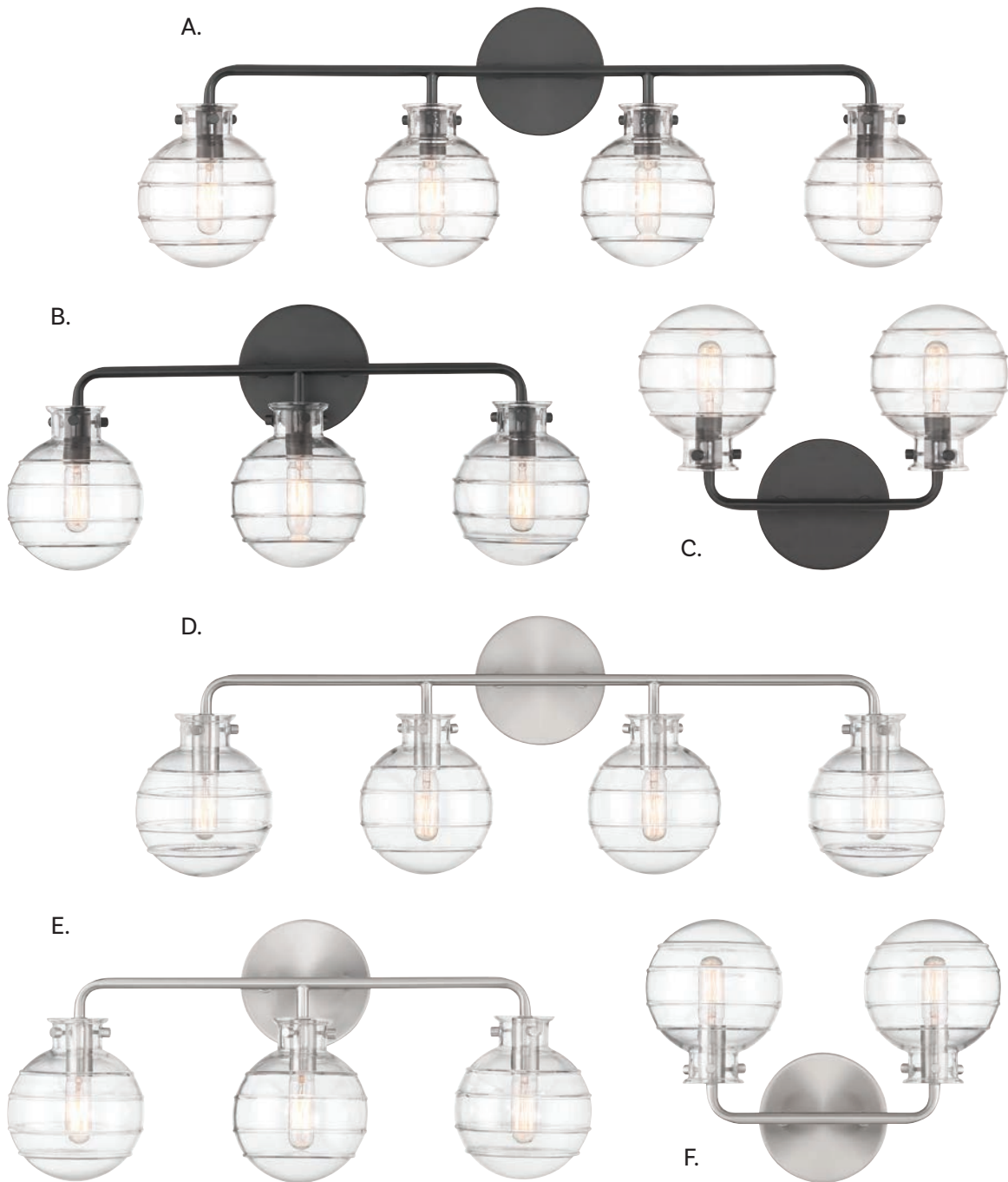

- | | | | | | |
|---|---|---|--|--|--|
| <p>A. 8-4300-4-BK
 4-Light Bath Bar
 Matte Black Finish
 30-1/2"W x 10"H x
 6-1/4"E
 4C 60W
 Clear Swirl Glass</p> | <p>B. 8-4300-3-BK
 3-Light Bath Bar
 Matte Black Finish
 22"W x 10"H x
 6-1/4"E
 3C 60W
 Clear Swirl Glass</p> | <p>C. 8-4300-2-BK
 2-Light Bath Bar
 Matte Black Finish
 13-1/2"W x 10"H x
 6-1/4"E
 2C 60W
 Clear Swirl Glass</p> | <p>D. 8-4300-4-SN
 4-Light Bath Bar
 Satin Nickel Finish
 30-1/2"W x 10"H x
 6-1/4"E
 4C 60W
 Clear Swirl Glass</p> | <p>E. 8-4300-3-SN
 3-Light Bath Bar
 Satin Nickel Finish
 22"W x 10"H x
 6-1/4"E
 3C 60W
 Clear Swirl Glass</p> | <p>F. 8-4300-2-SN
 2-Light Bath Bar
 Satin Nickel Finish
 13-1/2"W x 10"H x
 6-1/4"E
 2C 60W
 Clear Swirl Glass</p> |
|---|---|---|--|--|--|

CROSBY

POUR LE BAIN

A. 8-1860-4-322
4-Light Bath Bar
Warm Brass Finish
33"W x 10-1/2"H x 7-1/2"E
4C 60W
Clear Glass

A.



B. 8-1860-3-322
3-Light Bath Bar
Warm Brass Finish
24"W x 10-1/2"H x 7-1/2"E
3C 60W
Clear Glass

B.



C. 8-1860-2-322
2-Light Bath Bar
Warm Brass Finish
16"W x 10-1/2"H x 7-1/2"E
2C 60W
Clear Glass

C.



D. 8-1860-2-BK
2-Light Bath Bar
Matte Black Finish
16"W x 10-1/2"H x 7-1/2"E
2C 60W
Clear Glass

D.



E. 8-1860-3-BK
3-Light Bath Bar
Matte Black Finish
24"W x 10-1/2"H x 7-1/2"E
3C 60W
Clear Glass

E.



F. 8-1860-4-BK
4-Light Bath Bar
Matte Black Finish
33"W x 10-1/2"H x 7-1/2"E
4C 60W
Clear Glass

F.



CROSBY

POUR LE BAIN



HAMPTON

POUR LE BAIN



- A. 8-1972-2-322**
2-Light Bath Bar
Warm Brass Finish
16"W x 8-3/4"H x 6-1/2"E
2E 60W
Clear Crackled Glass
- B. 8-1972-3-322**
3-Light Bath Bar
Warm Brass Finish
24"W x 8-3/4"H x 6-1/2"E
3E 60W
Clear Crackled Glass
- C. 9-1972-1-322**
1-Light Sconce
Warm Brass Finish
4-3/4"W x 9-7/8"H x 6-1/2"E
1E 60W
Clear Crackled Glass
- D. 8-1972-4-322**
4-Light Bath Bar
Warm Brass Finish
32"W x 8-3/4"H x 6-1/2"E
4E 60W
Clear Crackled Glass



A.



B.



C.



D.

Fixtures may be mounted either uplight or downlight

BIRONE

POUR LE BAIN



E.



F.



G.



H.

E. 8-880-2-109
2-Light Bath Bar
Polished Nickel Finish
16"W x 8-1/2"H x 6-3/4"E
2E 60W
Clear Crystal Glass
Crystal Accents

F. 8-880-3-109
3-Light Bath Bar
Polished Nickel Finish
24"W x 8-1/2"H x 6-3/4"E
3E 60W
Clear Crystal Glass
Crystal Accents

G. 9-880-1-109
1-Light Sconce
Polished Nickel Finish
6"W x 8-1/2"H x 7-1/2"E
1E 60W
Clear Crystal Glass
Crystal Accent

H. 8-880-4-109
4-Light Bath Bar
Polished Nickel Finish
33"W x 8-1/2"H x 6-3/4"E
4E 60W
Clear Crystal Glass
Crystal Accents



Fixtures may be mounted either upright or downlight

VAUGHAN

POUR LE BAIN



- A. 8-4508-4-SN**
4-Light Bath Bar
Satin Nickel Finish
32-1/2"W x 9-1/4"H x 6"E
4E 60W
Clear Water Glass



- B. 8-4508-3-SN**
3-Light Bath Bar
Satin Nickel Finish
23-3/4"W x 9-1/4"H x 6"E
3E 60W
Clear Water Glass



- C. 8-4508-2-SN**
2-Light Bath Bar
Satin Nickel Finish
14-1/4"W x 9-1/4"H x 6"E
2E 60W
Clear Water Glass



Fixtures may be mounted either uplight or downlight

REDMOND

POUR LE BAIN



D.



E.



F.



D. 8-2154-3-67
3-Light Bath Bar
Matte Black w/
Polished Chrome
20"W x 9-1/4"H x 6"E
3E 60W
Clear Ribbed Glass

E. 8-2154-2-67
2-Light Bath Bar
Matte Black w/
Polished Chrome
12"W x 9-1/4"H x 6"E
2E 60W
Clear Ribbed Glass

F. 8-2154-4-67
4-Light Bath Bar
Matte Black w/
Polished Chrome
28"W x 9-1/4"H x 6"E
4E 60W
Clear Ribbed Glass

BRANNON

POUR LE BAIN

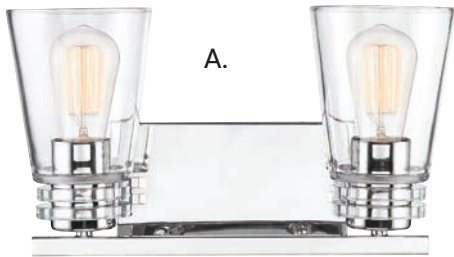

A.



B.



C.

A. 8-2148-2-109
2-Light Bath Bar
Polished Nickel Finish
14-3/8"W x 8-5/8"H x 6-1/2"E
2E 60W
Clear Glass
K9 Crystal

B. 8-2148-3-109
3-Light Bath Bar
Polished Nickel Finish
24"W x 8-5/8"H x 6-1/2"E
3E 60W
Clear Glass
K9 Crystal

C. 8-2148-4-109
4-Light Bath Bar
Polished Nickel Finish
33-5/8"W x 8-5/8"H x 6-1/2"E
4E 60W
Clear Glass
K9 Crystal



Fixtures may be mounted either uplight or downlight

LAMBERT

POUR LE BAIN

- D. 8-2149-3-11**
3-Light Bath Bar
Polished Chrome Finish
22"W x 9-3/4"H x 6"E
3E 60W
Clear Glass
- E. 8-2149-2-11**
2-Light Bath Bar
Polished Chrome Finish
13-1/2"W x 9-3/4"H x 6"E
2E 60W
Clear Glass
- F. 8-2149-4-11**
4-Light Bath Bar
Polished Chrome Finish
30-7/8"W x 9-3/4"H x 6"E
4E 60W
Clear Glass



D.

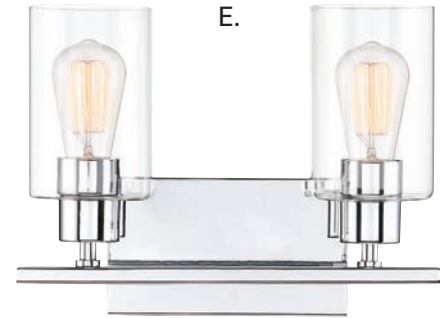

E.



F.

MARSHALL

POUR LE BAIN



Fixtures may be mounted either uplight or downlight.

MARSHALL

POUR LE BAIN



A.

- A. 8-8020-4-BK**
4-Light Bath Bar
Matte Black Finish
31"W x 9-1/2"H x 6-1/2"E
4E 60W
Clear Seeded Glass



B.

- B. 8-8020-3-BK**
3-Light Bath Bar
Matte Black Finish
22"W x 9-1/2"H x 6-1/2"E
3E 60W
Clear Seeded Glass



C.

- C. 8-8020-2-BK**
2-Light Bath Bar
Matte Black Finish
13-1/4"W x 9-1/2"H x 6-1/2"E
2E 60W
Clear Seeded Glass



D.

- D. 8-8020-4-11**
4-Light Bath Bar
Polished Chrome Finish
31"W x 9-1/2"H x 6-1/2"E
4E 60W
Clear Seeded Glass



E.

- E. 8-8020-3-11**
3-Light Bath Bar
Polished Chrome Finish
22"W x 9-1/2"H x 6-1/2"E
3E 60W
Clear Seeded Glass



F.

- F. 8-8020-2-11**
2-Light Bath Bar
Polished Chrome Finish
13-1/4"W x 9-1/2"H x 6-1/2"E
2E 60W
Clear Seeded Glass

VALE

POUR LE BAIN



Fixtures may be mounted either uplight or downlight.

- A. 8-7205-4-BK**
4-Light Bath Bar
Matte Black Finish
33"W x 9-3/4"H x 7-1/4"E
4E 60W
Clear Glass



A.

- B. 8-7205-3-BK**
3-Light Bath Bar
Matte Black Finish
24"W x 9-3/4"H x 7-1/4"E
3E 60W
Clear Glass



B.

- C. 8-7205-2-BK**
2-Light Bath Bar
Matte Black Finish
14-3/4"W x 9-3/4"H x 7-1/4"E
2E 60W
Clear Glass



C.

- D. 8-7205-4-SN**
4-Light Bath Bar
Satin Nickel Finish
33"W x 9-3/4"H x 7-1/4"E
4E 60W
Clear Glass



D.

- E. 8-7205-3-SN**
3-Light Bath Bar
Satin Nickel Finish
24"W x 9-3/4"H x 7-1/4"E
3E 60W
Clear Glass



E.

- F. 8-7205-2-SN**
2-Light Bath Bar
Satin Nickel Finish
14-3/4"W x 9-3/4"H x 7-1/4"E
2E 60W
Clear Glass



F.

MACAULEY

POUR LE BAIN



A. 8-2069-4-51
4-Light Bath Bar
Vintage Black w/
Warm Brass Finish
32"W x 9-3/4"H x 6-3/4"E
4E 60W
Clear Glass

B. 8-2069-2-51
2-Light Bath Bar
Vintage Black w/
Warm Brass Finish
14-1/2"W x 9-3/4"H x 6-3/4"E
2E 60W
Clear Glass

C. 8-2069-3-51
3-Light Bath Bar
Vintage Black w/
Warm Brass Finish
24"W x 9-3/4"H x 6-3/4"E
3E 60W
Clear Glass

A.



B.



C.



LANSING / WOODBURY

D.



D. LANSING
8-1780-2-111
 2-Light Bath Bar
 Satin Nickel w/
 Polished Nickel
 13-1/2"W x 10"H x 7"E
 2E 60W
 Clear Glass

E.



E. LANSING
8-1780-3-111
 3-Light Bath Bar
 Satin Nickel w/
 Polished Nickel
 24"W x 10"H x 7"E
 3E 60W
 Clear Glass

F.

G.



F. LANSING
8-1780-3-79
 3-Light Bath Bar
 English Bronze w/
 Warm Brass Finish
 24"W x 10"H x 7"E
 3E 60W
 Clear Glass

G. LANSING
8-1780-2-79
 2-Light Bath Bar
 English Bronze w/
 Warm Brass Finish
 13-1/2"W x 10"H x 7"E
 2E 60W
 Clear Glass

*H.



H. WOODBURY
8-530-4-322
 4-Light Bath Bar
 Warm Brass Finish
 28"W x 12"H x 7"E
 4E 60W
 White Glass

*I.

I. WOODBURY
8-530-2-322
 2-Light Bath Bar
 Warm Brass Finish
 14"W x 12"H x 7"E
 2E 60W
 White Glass

*Fixtures may be mounted either upright or downlight

BURGESS

POUR LE BAIN



- A. 8-993-6-41**
6-Light Bath Bar
Durango Finish
39"W x 10-1/4"H x 5-1/2"E
6E 60W



- B. 8-993-4-41**
4-Light Bath Bar
Durango Finish
28"W x 10-1/4"H x 5-1/2"E
4E 60W



- C. 8-993-3-41**
3-Light Bath Bar
Durango Finish
20"W x 10-1/4"H x 5-1/2"E
3E 60W



HALIFAX

POUR LE BAIN



D. 8-1255-4-165
4-Light Bath Bar
Satin Nickel w/
Gray Wood
36W x 9-3/4"H x 7"E
4E 60W
Clear Rippled Glass

E. 8-1255-3-165
3-Light Bath Bar
Satin Nickel w/
Gray Wood
25"W x 9-3/4"H x 7"E
3E 60W
Clear Rippled Glass

F. 8-1255-2-165
2-Light Bath Bar
Satin Nickel w/
Gray Wood
15"W x 9-3/4"H x 7"E
2E 60W
Clear Rippled Glass

*D.



*E.



*F.



*Fixtures may be mounted either uplight or downlight

COLTON

POUR LE BAIN



Fixtures may be mounted either uplight or downlight.



A.



B.



C.



D.



E.



F.



G.



H.

A. 8-338-2-13
2-Light Bath Bar
English Bronze Finish
13-1/2"W x 9"H x 5"E
2E 60W
White Opal Glass

B. 8-338-3-13
3-Light Bath Bar
English Bronze Finish
20-1/2"W x 9"H x 5"E
3E 60W
White Opal Glass

C. 8-338-4-13
4-Light Bath Bar
English Bronze Finish
28-1/2"W x 9"H x 5"E
4E 60W
White Opal Glass

D. 9-337-1-13
1-Light Sconce
English Bronze Finish
4-3/4"W x 10"H x 6"E
1E 60W
White Opal Glass

E. 9-337-1-SN
1-Light Sconce
Satin Nickel Finish
4-3/4"W x 10"H x 6"E
1E 60W
White Opal Glass

F. 8-338-2-SN
2-Light Bath Bar
Satin Nickel Finish
13-1/2"W x 9"H x 5"E
2E 60W
White Opal Glass

G. 8-338-3-SN
3-Light Bath Bar
Satin Nickel Finish
20-1/2"W x 9"H x 5"E
3E 60W
White Opal Glass

H. 8-338-4-SN
4-Light Bath Bar
Satin Nickel Finish
28-1/2"W x 9"H x 5"E
4E 60W
White Opal Glass

HERNDON / YATES

POUR LE BAIN

A. HERNDON
9-1007-1-SN
 1-Light Sconce
 Satin Nickel Finish
 5-1/2"W x 10-3/4"H x 7-1/2"E
 1E 60W
 Frosted White Glass



A

B. HERNDON
8-1007-2-SN
 2-Light Bath Bar
 Satin Nickel Finish
 18"W x 8"H x 7-1/2"E
 2E 60W
 Frosted White Glass



B.

C. HERNDON
8-1007-3-SN
 3-Light Bath Bar
 Satin Nickel Finish
 24"W x 8"H x 7-1/2"E
 3E 60W
 Frosted White Glass



C.

D. HERNDON
8-1007-4-SN
 4-Light Bath Bar
 Satin Nickel Finish
 30"W x 8"H x 7-1/2"E
 4E 60W
 Frosted White Glass



D.

E. YATES
8-6837-4-69
 4-Light Bath Bar
 Pewter Finish
 31"W x 8-3/4"H x 7-1/2"E
 4E 60W
 White Glass



E.

F. YATES
8-6837-2-69
 2-Light Bath Bar
 Pewter Finish
 15"W x 8-3/4"H x 7-1/2"E
 2E 60W
 White Glass



F.

G. YATES
8-6837-3-69
 3-Light Bath Bar
 Pewter Finish
 22-3/4"W x 8-3/4"H x 7-1/2"E
 3E 60W
 White Glass



G.

Fixtures may be mounted either uplight or downlight.

ELISE / KANE



H.



I.

H. ELISE

8-9127-2-SN

2-Light Bath Bar
Satin Nickel Finish
12-1/4"W x 10-1/8"H x 6-1/2"E
2E 60W
Frosted Opal Glass

I. ELISE

8-9127-1-SN

1-Light Sconce
Satin Nickel Finish
4-1/2"W x 10-1/2"H x 6-1/2"E
1E 60W
Frosted Opal Glass



J.

J. ELISE

8-9127-3-SN

3-Light Bath Bar
Satin Nickel Finish
20-1/2"W x 11"H x 6-1/2"E
3E 60W
Frosted Opal Glass



K.

K. KANE

8-890-4-SN

4-Light Bath Bar
Satin Nickel Finish
33"W x 8-1/2"H x 5-1/2"E
4E 60W
White Etched Glass



L.

L. KANE

8-890-3-SN

3-Light Bath Bar
Satin Nickel Finish
24"W x 8-1/2"H x 5-1/2"E
3E 60W
White Etched Glass



M.

M. KANE

8-890-2-SN

2-Light Bath Bar
Satin Nickel Finish
16"W x 8-1/2"H x 5-1/2"E
2E 60W
White Etched Glass

Fixtures may be mounted either uplight or downlight.

ENSLEY

CEILING



A. 6-7900-4-83

4-Light Semi-Flush
Bisque White Finish
20"W x 13"H
4C 60W

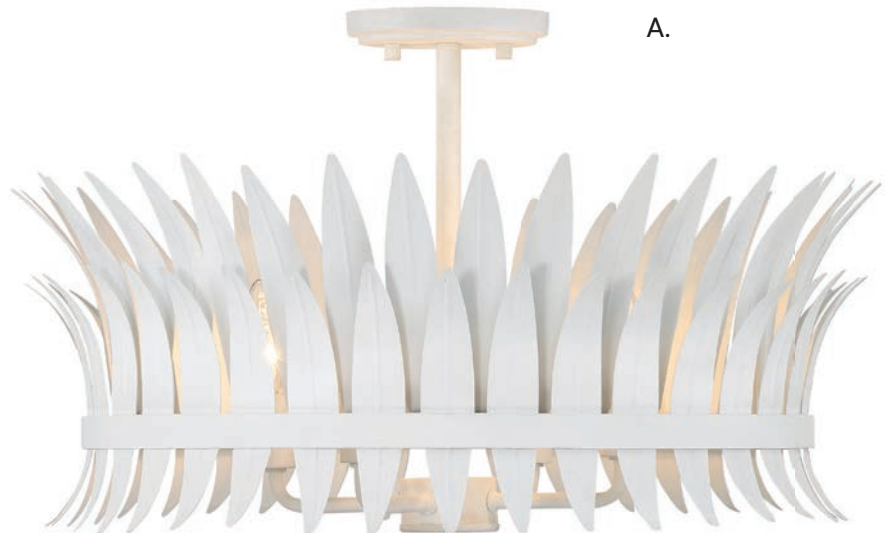

B. 6-7900-4-261

4-Light Semi-Flush
Matte Black w/ True Gold
20"W x 13"H
4C 60W

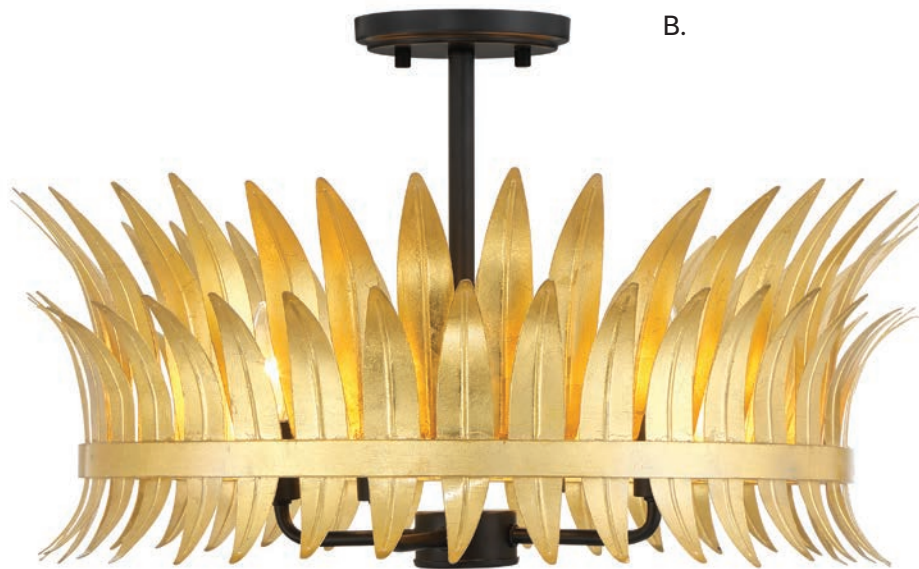

IDLEWILD

CEILING



IDLEWILD

CEILING

A.



B.



A. 6-5218-1-89
1-Light Flush Mount
Matte Black Finish
20"W x 13-1/4"H
1E 60W
Clear Crystal

B. 6-5218-1-322
1-Light Flush Mount
Warm Brass Finish
20"W x 13-1/4"H
1E 60W
Clear Crystal

STOCKTON

CEILING



STOCKTON

CEILING



A.



B.

- A. 6-1679-5-SN**
5-Light Semi-Flush
Satin Nickel Finish
24"W x 12"H
5C 60W

- B. 6-1679-5-322**
5-Light Semi-Flush
Warm Brass Finish
24"W x 12"H
5C 60W

- C. 6-1679-5-89**
5-Light Semi-Flush
Matte Black Finish
24"W x 12"H
5C 60W



C.

REID

CEILING

A.



B.



C.



A. 6-1953-4-322
4-Light Ceiling Light
Warm Brass Finish
20"W x 13-1/2"H
4E 60W
White Fabric Shade

B. 6-1953-4-89
4-Light Ceiling Light
Matte Black Finish
20"W x 13-1/2"H
4E 60W
White Fabric Shade

C. 6-1953-4-109
4-Light Ceiling Light
Polished Nickel Finish
20"W x 13-1/2"H
4E 60W
White Fabric Shade



MARCO

CEILING





A. 6-1950-6-322
6-Light Semi-Flush
Warm Brass Finish
24"W x 18-1/4"H
6C 60W
White Opal Glass

B. 6-1951-6-322
6-Light Semi-Flush
Warm Brass Finish
24"W x 18-1/4"H
6C 60W
Clear Glass

C. 6-1950-6-89
6-Light Semi-Flush
Matte Black Finish
24"W x 18-1/4"H
6C 60W
White Opal Glass



GAVIN

CEILING



GAVIN

CEILING



A.



B.



A. 6-1685-1-142

1-Light Semi-Flush
White w/ Warm Brass
20"W x 9"H
1E 60W
White Opal Glass

B. 6-1685-1-143

1-Light Semi-Flush
Matte Black w/ Warm Brass
20"W x 9"H
1E 60W
White Opal Glass

LYRIQUE

CEILING



LYRIQUE

CEILING

A.



B.

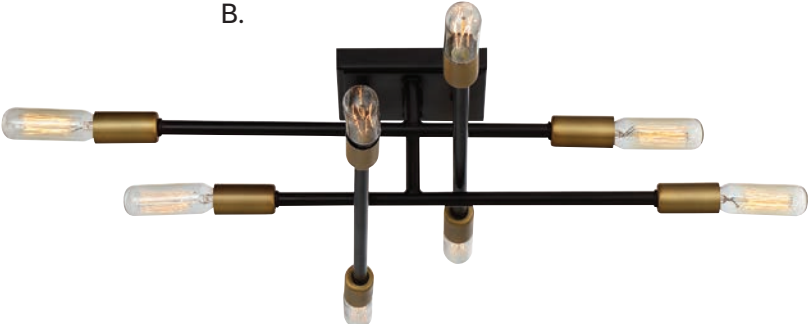

C.



D.

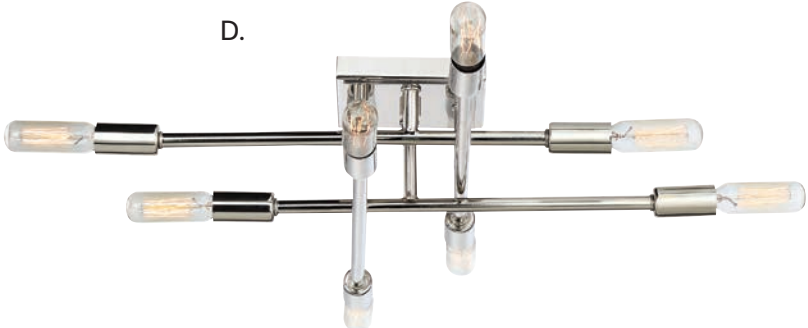

A. 6-7003-8-322
8-Light Flush Mount
Warm Brass Finish
19-1/2"L x 19-1/2"W x 4-3/4"H
8C 60W

B. 6-7003-8-77
8-Light Flush Mount
Bronze w/ Brass
19-1/2"L x 19-1/2"W x 4-3/4"H
8C 60W

C. 6-7003-8-89
8-Light Flush Mount
Matte Black Finish
19-1/2"L x 19-1/2"W x 4-3/4"H
8C 60W

D. 6-7003-8-109
8-Light Flush Mount
Polished Nickel Finish
19-1/2"L x 19-1/2"W x 4-3/4"H
8C 60W

CEILING

CEILING



A.



B.



C.



A. EATON

6-1981-1-143

1-Light Semi-Flush

Matte Black w/
Warm Brass

17"W x 10-1/4"H

1E 60W

Clear Glass

White Opal Chimney

B. HAYWARD

6-1695-4-143

4-Light Semi-Flush

Matte Black w/
Warm Brass

24"W x 8"H

4E 60W

Strie Piastra Glass

C. ALBERTI

6-1822-4-143

4-Light Flush Mount

Matte Black w/
Warm Brass

18-1/2"W x 5-1/4"H

4E 60W

White Alabaster Glass

CEILING

CEILING



D.



E.



F.



D. SCOUT
6-8074-15-SN
15" Flush Mount
Satin Nickel Finish
15"W x 6-1/2"H
3E 60W
UL Damp Rated

E. SCOUT
6-8074-15-13
15" Flush Mount
English Bronze Finish
15"W x 6-1/2"H
3E 60W
UL Damp Rated

F. GLENWOOD
6-3042-4-13
4-Light Semi-Flush
English Bronze Finish
14"W x 13-3/4"H
4C 60W
Clear Water Piastra Glass

CRAWFORD

CEILING



CRAWFORD

CEILING



A.



B.

- A. 6-1802-3-89**
3-Light Semi-Flush
Matte Black Finish
15"W x 13-1/2"H
3C 60W
Clear Water Glass

- B. 6-1802-3-322**
3-Light Semi-Flush
Warm Brass Finish
15"W x 13-1/2"H
3C 60W
Clear Water Glass

- C. 6-1802-3-SN**
3-Light Semi-Flush
Satin Nickel Finish
15"W x 13-1/2"H
3C 60W
Clear Water Glass



C.

LUCERNE

CEILING

A. 6-3350-16-109
3-Light Flush Mount
Polished Nickel Finish
15"W x 4-3/4"H
3E 60W
White Glass



A.

B. 6-3350-14-109
2-Light Flush Mount
Polished Nickel Finish
13-1/4"W x 4-3/4"H
2E 60W
White Glass



B.

C. 6-3350-16-13
3-Light Flush Mount
English Bronze Finish
15"W x 4-3/4"H
3E 60W
White Glass



C.

D. 6-3350-14-13
2-Light Flush Mount
English Bronze Finish
13-1/4"W x 4-3/4"H
2E 60W
White Glass



D.

E. 6-3350-16-322
3-Light Flush Mount
Warm Brass Finish
15"W x 4-3/4"H
3E 60W
White Glass



E.

F. 6-3350-14-322
2-Light Flush Mount
Warm Brass Finish
13-1/4"W x 4-3/4"H
2E 60W
White Glass



F.

G. 6-3350-16-SN
3-Light Flush Mount
Satin Nickel Finish
15"W x 4-3/4"H
3E 60W
White Glass



G.

H. 6-3350-14-SN
2-Light Flush Mount
Satin Nickel Finish
13-1/4"W x 4-3/4"H
2E 60W
White Glass



H.

I.



J.



K.



L.



I. 6-133-16-322
3-Light Flush Mount
Warm Brass Finish
16"W x 4"H
3E 60W
White Opal Glass

J. 6-133-16-44
3-Light Flush Mount
Classic Bronze Finish
16"W x 4"H
3E 60W
White Opal Glass

K. 6-134-3-322
3-Light Semi-Flush
Warm Brass Finish
16"W x 9-1/4"H
3E 60W
White Opal Glass

L. 6-134-3-44
3-Light Semi-Flush
Classic Bronze Finish
16"W x 9-1/4"H
3E 60W
White Opal Glass

CEILING

CEILING



A.



B.



C.



D.



E.



F.

A. CALHOUN

6-1024-3-SN

3-Light Semi-Flush
Satin Nickel Finish
13"W x 11-1/2"H
3E 60W
Clear Glass

B. CALHOUN

6-1024-3-322

3-Light Semi-Flush
Warm Brass Finish
13"W x 11-1/2"H
3E 60W
Clear Glass

C. CALHOUN

6-1024-3-89

3-Light Semi-Flush
Matte Black Finish
13"W x 11-1/2"H
3E 60W
Clear Glass

D. PENROSE

6-1043-3-109

3-Light Semi-Flush
Polished Nickel
Finish
12-1/2"W x 14"H
3C 60W
Clear Glass

E. PENROSE

6-1043-3-13

3-Light Semi-Flush
English Bronze
Finish
12-1/2"W x 14"H
3C 60W
Clear Glass

F. PENROSE

6-1043-3-SN

3-Light Semi-Flush
Satin Nickel
Finish
12-1/2"W x 14"H
3C 60W
Clear Glass

CEILING

CEILING



G.



H



I.



J.



K.

G. PENDLETON
6-7200-1-322
1-Light Semi-Flush
Warm Brass Finish
9-3/8"W x 9-3/4"H
1E 60W
Clear Glass

H. PENDLETON
6-7200-1-SN
1-Light Semi-Flush
Satin Nickel Finish
9-3/8"W x 9-3/4"H
1E 60W
Clear Glass

I. PENDLETON
6-7200-1-89
1-Light Semi-Flush
Matte Black Finish
9-3/8"W x 9-3/4"H
1E 60W
Clear Glass

J. BERG
6-3750-1-322
1-Light Semi-Flush
Warm Brass Finish
12"W x 12"H
1E 60W

K. BERG
6-3750-1-89
1-Light Semi-Flush
Matte Black Finish
12"W x 12"H
1E 60W

AVALON / OCTAVE

CEILING



A.

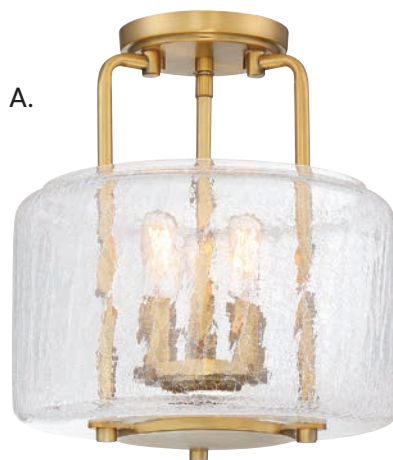

B.



C.



A. AVALON

6-7790-3-322

3-Light Semi-Flush

Warm Brass Finish

11-3/8"W x 12-1/4"H

1E 60W

Crackled Glass

B. AVALON

6-7790-3-89

3-Light Semi-Flush

Matte Black Finish

11-3/8"W x 12-1/4"H

1E 60W

Crackled Glass

C. OCTAVE

6-4037-1-BK

1-Light Semi-Flush

Matte Black Finish

6"W x 13-1/2"H

1E 60W

Clear Glass

OCTAVE

D.



E.



D. OCTAVE
6-4035-3-SN
3-Light Semi-Flush
Satin Nickel Finish
13"W x 11"H
3E 60W
Clear Glass

E. OCTAVE
6-4035-3-BK
3-Light Semi-Flush
Matte Black Finish
13"W x 11"H
3E 60W
Clear Glass

F.



G.



F. OCTAVE
6-4035-3-11
3-Light Semi-Flush
Polished Chrome Finish
13"W x 11"H
3E 60W
Clear Glass

G. OCTAVE
6-4035-3-13
3-Light Semi-Flush
English Bronze Finish
13"W x 11"H
3E 60W
Clear Glass

H.



H. OCTAVE
6-4035-3-322
3-Light Semi-Flush
Warm Brass Finish
13"W x 11"H
3E 60W
Clear Glass

KENT

CEILING



A.

A. 6-4900-4-89
4-Light Semi-Flush
Matte Black Finish
16"W x 14-3/4"H
4E 60W



B.

B. 6-4900-4-322
4-Light Semi-Flush
Warm Brass Finish
16"W x 14-3/4"H
4E 60W



C.

C. 6-4900-4-SN
4-Light Semi-Flush
Satin Nickel Finish
16"W x 14-3/4"H
4E 60W

BENSON

CEILING



D.

D. 6-7702-3-89
3-Light Semi-Flush
Matte Black Finish
13"W x 12"H
3C 60W



E.

E. 6-7702-3-322
3-Light Semi-Flush
Warm Brass Finish
13"W x 12"H
3C 60W



F.

F. 6-7702-3-SN
3-Light Semi-Flush
Satin Nickel Finish
13"W x 12"H
3C 60W

CEILING

CEILING



CEILING



A.



B.



C.



D.



E.



F.



G.



H.

A. 6-780-13-BK
2-Light Flush Mount
Matte Black Finish
13"W x 5"H
2E 60W
White Etched Glass

B. 6-780-11-BK
2-Light Flush Mount
Matte Black Finish
11"W x 4-1/2"H
2E 40W
White Etched Glass

C. 6-780-13-SN
2-Light Flush Mount
Satin Nickel Finish
13"W x 5"H
2E 60W
White Etched Glass

D. 6-780-11-SN
2-Light Flush Mount
Satin Nickel Finish
11"W x 4-1/2"H
2E 40W
White Etched Glass

E. 6-780-13-322
2-Light Flush Mount
Warm Brass Finish
13"W x 5"H
2E 60W
White Etched Glass

F. 6-780-11-322
2-Light Flush Mount
Warm Brass Finish
11"W x 4-1/2"H
2E 40W
White Etched Glass

G. 6-780-13-13
2-Light Flush Mount
English Bronze Finish
13"W x 5"H
2E 60W
White Etched Glass

H. 6-780-11-13
2-Light Flush Mount
English Bronze Finish
11"W x 4-1/2"H
2E 40W
White Etched Glass

ASCOTT

OUTDOOR



*A.



B.



*Includes 120" chain & 144" wire



A. 5-827-BK
 3-Light Outdoor Hanging Lantern
 Matte Black Finish
 6-1/2"W x 20"H
 3C 40W
 Clear Seeded Glass
UL Damp Rated

B. 5-828-BK
 3-Light Outdoor Post Lantern
 Matte Black Finish
 6-1/2"W x 18-3/4"H
 3C 60W
 Clear Seeded Glass
UL Wet Rated

C. 5-825-BK
 1-Light Outdoor Wall Lantern
 Matte Black Finish
 4-1/2"W x 21-1/2"H x 6-1/4"E
 1C 60W
 Clear Seeded Glass
UL Wet Rated

D. 5-829-BK
 3-Light Outdoor Wall Lantern
 Matte Black Finish
 6-1/2"W x 32"H x 9"E
 3C 60W
 Clear Seeded Glass
UL Wet Rated

E. 5-826-BK
 2-Light Outdoor Wall Lantern
 Matte Black Finish
 5-1/2"W x 26-3/4"H x 7-1/2"E
 2C 60W
 Clear Seeded Glass
UL Wet Rated



RAEBURN

OUTDOOR



*A.



B.



*Includes 120" chain & 144" wire

RAEBURN

OUTDOOR

C.



D.



E.



A. 5-475-144

1-Light Outdoor Hanging Lantern
Matte Black w/ Weathered
Brushed Brass Finish
8-1/2"W x 25"H
1E 60W
Clear Beveled Glass
UL Damp Rated

B. 5-476-144

1-Light Outdoor Post Lantern
Matte Black w/ Weathered
Brushed Brass Finish
8-1/2"W x 23-1/2"H
1E 60W
Clear Beveled Glass
UL Wet Rated

C. 5-474-144

1-Light Outdoor Wall Lantern
Matte Black w/ Weathered
Brushed Brass Finish
7"W x 23"H x 9"E
1E 60W
Clear Beveled Glass
UL Wet Rated

D. 5-472-144

1-Light Outdoor Wall Lantern
Matte Black w/ Weathered
Brushed Brass Finish
8-1/2"W x 28"H x 11"E
1E 60W
Clear Beveled Glass
UL Wet Rated

E. 5-473-144

1-Light Outdoor Wall Lantern
Matte Black w/ Weathered
Brushed Brass Finish
5-1/2"W x 18"H x 8"E
1E 60W
Clear Beveled Glass
UL Wet Rated



ERICSON

OUTDOOR



A.



B.



A. 5-1990-BK

1-Light Outdoor Wall Lantern
Matte Black Finish
6"W x 18-1/2"H x 9-1/4"E
1E 60W
Clear Glass
UL Wet Rated

B. 5-1989-BK

1-Light Outdoor Wall Lantern
Matte Black Finish
5.5"W x 16"H x 8-1/4"E
1E 60W
Clear Glass
UL Wet Rated

HAMILTON

OUTDOOR



C.



D.



C. 5-1986-BK
 1-Light Outdoor Wall Lantern
 Matte Black Finish
 7-1/2"W x 23-1/2"H x 9-1/2"E
 1C 60W
 Clear Outer Glass
 White Opal Chimney
UL Wet Rated

D. 5-1985-BK
 1-Light Outdoor Wall Lantern
 Matte Black Finish
 6-1/2"W x 21"H x 8"E
 1C 60W
 Clear Outer Glass
 White Opal Chimney
UL Wet Rated

ENGLEWOOD

OUTDOOR

A. 5-904-BK

2-Light Outdoor Wall Lantern
Matte Black Finish
7"W x 15"H x 8-3/4"E
2C 40W
Clear Glass
UL Wet Rated



A.

B. 5-903-BK

3-Light Outdoor Wall Lantern
Matte Black Finish
10-1/2"W x 23-1/2"H x 13"E
3C 40W
Clear Glass
UL Wet Rated



B.

C. 5-905-BK

3-Light Outdoor Wall Lantern
Matte Black Finish
8-1/2"W x 19"H x 11"E
3C 40W
Clear Glass
UL Wet Rated



C.

D. 5-901-BK

3-Light Outdoor Hanging Lantern
Matte Black Finish
10-1/2"W x 23-1/2"H
3C 40W
Clear Glass
UL Damp Rated

E. 5-902-BK

3-Light Outdoor Post Lantern
Matte Black Finish
10-1/2"W x 26"H
3C 40W
Clear Glass
UL Wet Rated



ENGLEWOOD



*Includes 120" chain & 144" wire

*D.



E.



OUTDOOR

MONTPELIER

OUTDOOR



*A.



B.



*Includes 120" chain & 144" wire

MONTPELIER

OUTDOOR

C.



A. 5-763-BK
3-Light Outdoor
Hanging Lantern
Matte Black Finish
7-1/2"W x 25"H
3C 40W
Clear Seeded Glass
UL Damp Rated

D.



B. 5-769-BK
3-Light Outdoor
Post Lantern
Matte Black Finish
7-1/2"W x 29"H
3C 60W
Clear Seeded Glass
UL Wet Rated

C. 5-766-BK
2-Light Outdoor
Wall Lantern
Matte Black Finish
6-1/4"W x 22"H x 8-1/4"E
2C 40W
Clear Seeded Glass
UL Wet Rated

E.



D. 5-764-BK
4-Light Outdoor
Wall Lantern
Matte Black Finish
9-1/2"W x 32"H x 12"E
4C 40W
Clear Seeded Glass
UL Wet Rated

F.



E. 5-765-BK
3-Light Outdoor
Wall Lantern
Matte Black Finish
7-1/2"W x 25"H x 10"E
3C 40W
Clear Seeded Glass
UL Wet Rated

F. 5-768-BK
1-Light Outdoor
Wall Lantern
Matte Black Finish
5-1/2"W x 18-1/2"H x 7-1/2"E
1E 60W
Clear Seeded Glass
UL Wet Rated

KINGSLEY

OUTDOOR



*A.



B.



*Includes 120" chain & 144" wire

KINGSLEY

OUTDOOR

C.



D.



A. 5-717-143

2-Light Outdoor
Hanging Lantern
Matte Black w/
Warm Brass
8-1/2"W x 22-1/2"H
2C 40W
Clear Seeded Glass
UL Damp Rated

B. 5-718-143

2-Light Outdoor
Post Lantern
Matte Black w/
Warm Brass
8-1/2"W x 22-1/2"H
2C 60W
Clear Seeded Glass
UL Wet Rated

C. 5-714-143

2-Light Outdoor
Wall Lantern
Matte Black w/
Warm Brass
8-1/2"W x 20-1/4"H x
9-3/4"E
2C 40W
Clear Seeded Glass
UL Wet Rated

E.



F.



D. 5-716-143

4-Light Outdoor
Wall Lantern
Matte Black w/
Warm Brass
11-1/2"W x 28"H x 13"E
4C 40W
Clear Seeded Glass
UL Wet Rated

E. 5-715-143

3-Light Outdoor
Wall Lantern
Matte Black w/
Warm Brass
10"W x 25-1/4"H x 11-1/2"E
3C 40W
Clear Seeded Glass
UL Wet Rated

F. 5-719-143

1-Light Outdoor
Wall Lantern
Matte Black w/
Warm Brass
7"W x 16-1/4"H x 8-1/4"E
1E 60W
Clear Seeded Glass
UL Wet Rated

GLENDALE

OUTDOOR



*A.



B.

*Includes 120" chain & 144" wire

GLENDALE

OUTDOOR



C.

E.



D.

A. 5-277-144

1-Light Outdoor Hanging Lantern
Matte Black w/ Weathered
Brushed Brass Finish
6-1/2"W x 28"H
1E 60W
Clear Seeded Glass
UL Damp Rated

B. 5-278-144

1-Light Outdoor Post Lantern
Matte Black w/ Weathered
Brushed Brass Finish
6-1/2"W x 28"H
1E 60W
Clear Seeded Glass
UL Wet Rated

C. 5-276-144

1-Light Outdoor Wall Lantern
Matte Black w/ Weathered
Brushed Brass Finish
5-3/4"W x 24-1/2"H x 7"E
1E 60W
Clear Seeded Glass
UL Wet Rated

D. 5-279-144

1-Light Outdoor Wall Lantern
Matte Black w/ Weathered
Brushed Brass Finish
6-1/2"W x 28"H x 8"E
1E 60W
Clear Seeded Glass
UL Wet Rated

E. 5-275-144

1-Light Outdoor Wall Lantern
Matte Black w/ Weathered
Brushed Brass Finish
5"W x 20-1/2"H x 6"E
1E 60W
Clear Seeded Glass
UL Wet Rated



MACAULEY

OUTDOOR



MACAULEY

OUTDOOR



A. 5-2066-51

1-Light Outdoor Sconce
Vintage Black w/ Warm Brass
5"W x 13-1/2"H x 7"E
1E 60W
Clear Glass
UL Wet Rated

B. 5-2067-51

1-Light Outdoor Sconce
Vintage Black w/ Warm Brass
7-1/2"W x 20-3/4"H x 9-3/4"E
1E 60W
Clear Glass
UL Wet Rated

C. 5-2068-51

3-Light Outdoor Sconce
Vintage Black w/ Warm Brass
9-1/8"W x 23-1/2"H x 11-1/4"E
3C 40W
Clear Glass
UL Wet Rated



PENINSULA

OUTDOOR



*A.



B.



*Includes 120" chain & 144" wire

PENINSULA

OUTDOOR

C.



A. 5-706-BK

1-Light Outdoor Hanging Lantern
Matte Black Finish
12"W x 32-1/2"H
1E 60W
Glacier Glass
UL Damp Rated

D.



B. 5-707-BK

1-Light Outdoor Post Lantern
Matte Black Finish
12"W x 36"H
1E 60W
Glacier Glass
UL Wet Rated

E.



C. 5-709-BK

1-Light Outdoor Wall Lantern
Matte Black Finish
7-1/2"W x 18"H x 10-1/2"E
1E 60W
Glacier Glass
UL Wet Rated

D. 5-708-BK

1-Light Outdoor Wall Lantern
Matte Black Finish
12"W x 30"H x 17"E
1E 60W
Glacier Glass
UL Wet Rated

E. 5-705-BK

1-Light Outdoor Wall Lantern
Matte Black Finish
10"W x 24"H x 13-1/2"E
1E 60W
Glacier Glass
UL Wet Rated



WOODSTOCK

OUTDOOR



A. 5-105-BK

3-Light Outdoor
Semi-Flush
Matte Black Finish
12"W x 14-1/2"H
3C 60W
Clear Seeded Glass
UL Damp Rated

B. 5-101-BK

3-Light Outdoor
Wall Lantern
Matte Black Finish
12"W x 23-1/2"H x 14"E
3C 60W
Clear Seeded Glass
UL Wet Rated

C. 5-100-BK

1-Light Outdoor
Wall Lantern
Matte Black Finish
8"W x 16.5"H x 9"E
1E 60W
Clear Seeded Glass
UL Wet Rated

D. 5-102-BK

4-Light Outdoor
Wall Lantern
Matte Black Finish
15"W x 30-1/2"H x 17"E
4C 60W
Clear Seeded Glass
UL Wet Rated

E. 5-104-BK

4-Light Outdoor
Hanging Lantern
Matte Black Finish
15"W x 23-1/2"H
4C 60W
Clear Seeded Glass
UL Damp Rated

WOODSTOCK

OUTDOOR

A.



B.



C.



D.



*E.



*Includes 120" chain & 144" wire

DENVER

OUTDOOR



*A.



B.



*Includes 120" chain & 144" wire

DENVER

OUTDOOR

C.



D.



A. 5-2025-BK
1-Light Outdoor
Hanging Lantern
Matte Black Finish
8"W x 16-1/8"H
1E 60W
Clear Seeded Glass
UL Damp Rated

B. 5-2024-BK
1-Light Outdoor
Post Lantern
Matte Black Finish
10"W x 19"H
1E 60W
Clear Seeded Glass
UL Wet Rated

C. 5-2020-BK
1-Light Outdoor
Wall Lantern
Matte Black Finish
6"W x 11"H x 7-1/2"E
1E 60W
Clear Seeded Glass
UL Wet Rated

E.



F.



D. 5-2022-BK
1-Light Outdoor
Wall Lantern
Matte Black Finish
10"W x 18"H x 11"E
1E 60W
Clear Seeded Glass
UL Wet Rated

E. 5-2023-BK
3-Light Outdoor
Wall Lantern
Matte Black Finish
16"W x 29"H x 17"E
3C 60W
Clear Seeded Glass
UL Wet Rated

F. 5-2021-BK
1-Light Outdoor
Wall Lantern
Matte Black Finish
8"W x 15"H x 9-1/2"E
1E 60W
Clear Seeded Glass
UL Wet Rated



MILLFORD

OUTDOOR



*A.



B.



*Includes 120" chain & 144" wire

MILLFORD

OUTDOOR



A. 5-638-BK
3-Light Outdoor
Hanging Lantern
Matte Black Finish
9"W x 23-1/4"H
3C 40W
Clear Seeded Glass
UL Damp Rated

B. 5-633-BK
3-Light Outdoor
Post Lantern
Matte Black Finish
9"W x 23-1/4"H
3C 60W
Clear Seeded Glass
UL Wet Rated

C. 5-635-BK
1-Light Outdoor
Wall Lantern
Matte Black Finish
7-1/2"W x 18-3/4"H x 9"E
1E 60W
Clear Seeded Glass
UL Wet Rated

D. 5-637-BK
4-Light Outdoor
Wall Lantern
Matte Black Finish
11"W x 26-3/4"H x 12-1/4"E
4C 40W
Clear Seeded Glass
UL Wet Rated

E. 5-636-BK
3-Light Outdoor
Wall Lantern
Matte Black Finish
9"W x 22"H x 10-1/2"E
3C 40W
Clear Seeded Glass
UL Wet Rated

F. 5-634-BK
1-Light Outdoor
Wall Lantern
Matte Black Finish
5-1/2"W x 14"H x 7"E
1E 60W
Clear Seeded Glass
UL Wet Rated



MILTON

OUTDOOR



A. 5-548-13

2-Light Outdoor Wall Lantern
English Bronze Finish
9-1/2"W x 19-1/2"H x 11-1/2"E
2C 40W
Clear Glass
UL Wet Rated

B. 5-549-13

4-Light Outdoor
Hanging Lantern
English Bronze Finish
12"W x 22"H
4C 60W
Clear Glass
UL Damp Rated

C. 5-546-13

1-Light Outdoor Wall Lantern
English Bronze Finish
6-1/2"W x 12-3/4"H x 8"E
1E 60W
Clear Glass
UL Wet Rated

D. 5-547-13

1-Light Outdoor Wall Lantern
English Bronze Finish
8"W x 16-1/2"H x 9-1/2"E
1E 60W
Clear Glass
UL Wet Rated

MILTON



A.



*B.



C.



D.

OUTDOOR

*Includes 120" chain & 144" wire

BROOKLINE

OUTDOOR



*A.



B.



LED



*Includes 120" chain & 144" wire

BROOKLINE

OUTDOOR

C.



D.



A. 5-357-BK

LED Outdoor Dark Sky
Hanging Lantern
Matte Black Finish
7-1/4"W x 21-3/4"H
6W Integrated Dimmable LED
409 Lumens, 3000K, 90+ CRI
Clear Seeded Glass
UL Damp Rated

B. 5-356-BK

LED Outdoor Post Lantern
Matte Black Finish
7-1/4"W x 22-1/2"H
6W Integrated Dimmable LED
409 Lumens, 3000K, 90+ CRI
Clear Seeded Glass
UL Wet Rated

C. 5-353-BK

LED Outdoor Dark Sky
Wall Lantern
Matte Black Finish
6-1/2"W x 17-1/2"H x 7-3/4"E
6W Integrated Dimmable LED
409 Lumens, 3000K, 90+ CRI
Clear Seeded Glass
UL Wet Rated

D. 5-355-BK

LED Outdoor Dark Sky
Wall Lantern
Matte Black Finish
12"W x 32-1/4"H x 14"E
14W Integrated Dimmable LED
740 Lumens, 3000K, 90+ CRI
Clear Seeded Glass
UL Wet Rated

E.



F.



E. 5-354-BK

LED Outdoor Dark Sky
Wall Lantern
Matte Black Finish
7-1/4"W x 20"H x 9"E
6W Integrated Dimmable LED
409 Lumens, 3000K, 90+ CRI
Clear Seeded Glass
UL Wet Rated

F. 5-352-BK

LED Outdoor Dark Sky
Wall Lantern
Matte Black Finish
5-1/2"W x 15"H x 6-3/4"E
6W Integrated Dimmable LED
409 Lumens, 3000K, 90+ CRI
Clear Seeded Glass
UL Wet Rated

JACKSON

OUTDOOR



A. 5-723-153

4-Light Outdoor
Hanging Lantern
Black w/ Gold Highlights
14"W x 29-1/4"H
4C 40W
Clear Glass
UL Damp Rated

B. 5-724-153

1-Light Outdoor
Post Lantern
Black w/ Gold Highlights
9"W x 22-3/4"H
1E 60W
Clear Glass
UL Wet Rated

C. 5-722-153

3-Light Outdoor
Wall Lantern
Black w/ Gold Highlights
10-7/8"W x 25-1/2"H x
11-3/4"E
3C 40W
Clear Glass
UL Wet Rated

D. 5-721-153

1-Light Outdoor
Wall Lantern
Black w/ Gold Highlights
9"W x 22-3/8"H x
9-7/8"E
1E 60W
Clear Glass
UL Wet Rated

E. 5-720-153

1-Light Outdoor
Wall Lantern
Black w/ Gold Highlights
7"W x 17-1/2"H x
7-13/16"E
1E 60W
Clear Glass
UL Wet Rated

JACKSON

OUTDOOR

*A.



B.



C.



D.



E.



*Includes 120" chain & 144" wire

ELLIJAY

OUTDOOR



*A.



B.



*Includes 120" chain & 144" wire

ELLIJAY

OUTDOOR



A. 5-145-BK

4-Light Outdoor
Hanging Lantern
Matte Black Finish
12"W x 21"H
4C 40W
Clear Glass
UL Damp Rated

B. 5-147-BK

3-Light Outdoor
Post Lantern
Matte Black Finish
9"W x 17-1/2"H
3C 60W
Clear Glass
UL Wet Rated

C. 5-146-BK

3-Light Outdoor
Hanging Lantern
Matte Black Finish
9"W x 15-3/4"H
3C 40W
Clear Glass
UL Wet Rated

D. 5-142-BK

4-Light Outdoor
Wall Lantern
Matte Black Finish
12"W x 25-1/4"H x 15"E
4C 40W
Clear Glass
UL Wet Rated

E. 5-141-BK

3-Light Outdoor
Wall Lantern
Matte Black Finish
9"W x 19"H x 11-1/4"E
3C 40W
Clear Glass
UL Wet Rated

F. 5-140-BK

1-Light Outdoor
Wall Lantern
Matte Black Finish
6"W x 9-1/2"H x 7"E
1E 60W
Clear Glass
UL Wet Rated



ELLIJAY

OUTDOOR



*A.



B.



*Includes 120" chain & 144" wire

ELLIJAY

OUTDOOR



A. 5-146-13
3-Light Outdoor
Hanging Lantern
English Bronze Finish
9"W x 15-3/4"H
3C 40W
Clear Glass
UL Damp Rated

B. 5-147-13
3-Light Outdoor
Post Lantern
English Bronze Finish
9"W x 17-1/2"H
3C 60W
Clear Glass
UL Wet Rated

C. 5-141-13
3-Light Outdoor
Wall Lantern
English Bronze Finish
9"W x 19"H x 11-1/4"E
3C 40W
Clear Glass
UL Wet Rated

D. 5-142-13
4-Light Outdoor
Wall Lantern
English Bronze Finish
12"W x 25-1/4"H x 15"E
4C 40W
Clear Glass
UL Wet Rated

E. 5-140-13
1-Light Outdoor
Wall Lantern
English Bronze Finish
6"W x 9-1/2"H x 7"E
1E 60W
Clear Glass
UL Wet Rated



HANCOCK

OUTDOOR



A. 5-453-BK

3-Light Outdoor
Hanging Lantern
Matte Black Finish
10-1/2"W x 25"H
3C 40W
Clear Seeded Glass
UL Damp Rated

B. 5-450-BK

1-Light Outdoor
Wall Lantern
Matte Black Finish
6-3/4"W x 17-1/4"H x
7-1/2"E
1E 60W
Clear Seeded Glass
UL Wet Rated

C. 5-452-BK

3-Light Outdoor
Wall Lantern
Matte Black Finish
10-1/2"W x 27-3/4"H x
10-1/2"E
3C 40W
Clear Seeded Glass
UL Wet Rated

D. 5-451-BK

1-Light Outdoor
Wall Lantern
Matte Black Finish
8-1/2"W x 22-3/4"H x
9-1/4"E
1E 60W
Clear Seeded Glass
UL Wet Rated

E. 5-454-BK

1-Light Outdoor
Post Lantern
Matte Black Finish
8-1/2"W x 24-1/4"H
1E 60W
Clear Seeded Glass
UL Wet Rated

HANCOCK

OUTDOOR

*A.



B.



C.



D.



E.



*Includes 120" chain & 144" wire

DUNNMORE

OUTDOOR



A. 5-3455-BK

1-Light Outdoor
Hanging Lantern
Matte Black Finish
8"W x 18-3/4"H
1E 75W
Seeded Glass
UL Damp Rated

B. 5-3451-BK

1-Light Outdoor Wall
Lantern
Matte Black Finish
6-1/2"W x 16"H x 8"E
1E 60W
Seeded Glass
UL Wet Rated

C. 5-3453-BK

3-Light Outdoor Wall
Lantern
Matte Black Finish
11"W x 23-1/2"H x 13"E
3C 40W
Seeded Glass
UL Wet Rated

D. 5-3454-BK

1-Light Outdoor Post
Lantern
Matte Black Finish
8"W x 23-1/2"H
1E 60W
Seeded Glass
UL Wet Rated

E. 5-3452-BK

1-Light Outdoor Wall
Lantern
Matte Black Finish
8"W x 18"H x 9-1/2"E
1E 60W
Seeded Glass
UL Wet Rated

DUNNMORE

OUTDOOR



*Includes 120" chain & 144" wire

BOONE

OUTDOOR

*A.



B.



*Includes 120" chain & 144" wire

BOONE

OUTDOOR



C.



D.

A. 5-816-BK
1-Light Outdoor
Hanging Lantern
Matte Black Finish
8-1/4"W x 22"H
1E 60W
Clear Beveled Glass
UL Damp Rated

B. 5-817-BK
1-Light Outdoor
Post Lantern
Matte Black Finish
8-1/4"W x 24-1/4"H
1E 60W
Clear Beveled Glass
UL Wet Rated

C. 5-813-BK
1-Light Outdoor
Wall Lantern
Matte Black Finish
8-1/4"W x 20"H x 8-1/2"E
1E 60W
Clear Beveled Glass
UL Wet Rated

D. 5-815-BK
4-Light Outdoor
Wall Lantern
Matte Black Finish
13-1/4"W x 32"H x 13-1/2"E
4C 40W
Clear Beveled Glass
UL Wet Rated



E.



F.

E. 5-814-BK
1-Light Outdoor
Wall Lantern
Matte Black Finish
10-1/4"W x 24-3/4"H x 11-1/2"E
1E 60W
Clear Beveled Glass
UL Wet Rated

F. 5-812-BK
1-Light Outdoor
Wall Lantern
Matte Black Finish
6-1/4"W x 15-1/4"H x 6-1/2"E
1E 60W
Clear Beveled Glass
UL Wet Rated



MONTE GRANDE

OUTDOOR



A. 5-256-25

3-Light Outdoor
Hanging Lantern
Slate Finish
10"W x 22-1/2"H
3C 40W
Pale Cream Seeded Glass
UL Damp Rated

B. 5-259-25

3-Light Outdoor
Wall Lantern
Slate Finish
10"W x 26-3/4"H x 12"E
3C 40W
Pale Cream Seeded Glass
UL Wet Rated

C. 5-258-25

1-Light Outdoor
Wall Lantern
Slate Finish
7"W x 17-3/4"H x 8-1/4"E
1E 60W
Pale Cream Seeded Glass
UL Wet Rated

D. 5-254-25

1-Light Outdoor
Wall Lantern
Slate Finish
5-1/2"W x 11-1/2"H
x 6-1/2"E
1E 60W
Pale Cream Seeded Glass
UL Wet Rated

MONTE GRANDE

OUTDOOR

*A.



B.



C.



D.



*Includes 120" chain & 144" wire



MONTE GRANDE

OUTDOOR

*A.



B.



*Includes 120" chain & 144" wire

MONTE GRANDE

OUTDOOR



C.



D.

A. 5-256-13
3-Light Outdoor
Hanging Lantern
English Bronze Finish
10"W x 22-1/2"H
3C 40W
Pale Cream Seeded Glass
UL Damp Rated

B. 5-255-13
3-Light Outdoor
Post Lantern
English Bronze Finish
10"W x 23-3/4"H
3C 60W
Pale Cream Seeded Glass
UL Wet Rated

C. 5-259-13
3-Light Outdoor
Wall Lantern
English Bronze Finish
10"W x 26-3/4"H x 12"E
3C 40W
Pale Cream Seeded Glass
UL Wet Rated

D. 5-257-13
4-Light Outdoor
Wall Lantern
English Bronze Finish
13"W x 34-1/2"H x 15-3/4"E
4C 40W
Pale Cream Seeded Glass
UL Wet Rated



E.



F.

E. 5-258-13
1-Light Outdoor
Wall Lantern
English Bronze Finish
7"W x 17-3/4"H x 8-1/4"E
1E 60W
Pale Cream Seeded Glass
UL Wet Rated

F. 5-254-13
1-Light Outdoor
Wall Lantern
English Bronze Finish
5-1/2"W x 11-1/2"H x 6-1/2"E
1E 60W
Pale Cream Seeded Glass
UL Wet Rated



PALMER

OUTDOOR



*A.

A. 5-1222-40
3-Light Outdoor Hanging Lantern
Walnut Patina Finish
9"W x 25"H
3C 40W
Clear Seeded Glass
UL Damp Rated



B.

B. 5-1223-40
3-Light Outdoor Post Lantern
Walnut Patina Finish
9"W x 22"H
3C 40W
Clear Seeded Glass
UL Wet Rated



C.

C. 5-1220-40
2-Light Outdoor Wall Lantern
Walnut Patina Finish
7-1/2"W x 24"H x 11-3/4"E
2C 40W
Clear Seeded Glass
UL Wet Rated

*Includes 120" chain & 144" wire

PALMER

OUTDOOR



D.

D. 5-1221-40
3-Light Outdoor Wall Lantern
Walnut Patina Finish
9"W x 26"H x 13"E
3C 40W
Clear Seeded Glass
UL Wet Rated



E.

E. 5-1224-40
4-Light Outdoor Wall Lantern
Walnut Patina Finish
11"W x 33-1/2"H x 16"E
4C 40W
Clear Seeded Glass
UL Wet Rated



BRENNAN

OUTDOOR



A.



B.



C.

A. 5-344-213
1-Light Outdoor
Wall Lantern
English Bronze w/
Gold Highlights
8"W x 17-3/4"H x 9"E
1E 60W
Clear Seeded Glass
UL Wet Rated

B. 5-341-213
1-Light Outdoor
Wall Lantern
English Bronze w/
Gold Highlights
6-1/2"W x 14-7/8"H x 7-3/8"E
1E 60W
Clear Seeded Glass
UL Wet Rated

C. 5-340-213
1-Light Outdoor
Wall Lantern
English Bronze w/
Gold Highlights
5"W x 11-1/4"H x 5-7/8"E
1E 60W
Clear Seeded Glass
UL Wet Rated



BRENNAN



OUTDOOR

BROOKE

OUTDOOR



BROOKE

OUTDOOR

A.



B.



A. 5-5910-BK
1-Light Outdoor Wall Lantern
Matte Black Finish
7-1/4"W x 17"H x 4-1/2"E
1C 60W
Clear Glass
UL Wet Rated

B. 5-5911-BK
2-Light Outdoor Wall Lantern
Matte Black Finish
8-1/4"W x 20"H x 5"E
2C 60W
Clear Glass
UL Wet Rated

WALL LIGHTING

OUTDOOR



A.



**A. BELMONT
5-179-137**

1-Light Outdoor
Dark Sky Wall Lantern
Textured Black w/ Warm Brass
12"W x 13"H x 13"E
1E 60W
UL Wet Rated

WALL LIGHTING

OUTDOOR



B.



C.



D.



E.

B. RALEIGH
5-9584-BK
1-Light Outdoor
Wall Lantern
Matte Black Finish
11"W x 11"H x 15-1/2"E
1E 60W
UL Wet Rated

C. DANSK
9-6074-1-90
1-Light Sconce
Galvanized Metal Finish
8"W x 13"H x 10"E
1E 60W
UL Wet Rated

D. DUNSTON DS
5-5630-DS-13
1-Light Outdoor
Dark Sky Wall Lantern
English Bronze Finish
8"W x 7-1/2"H x 9-1/4"E
1E 60W
UL Wet Rated

E. DUNSTON DS
5-5631-DS-13
1-Light Outdoor
Dark Sky Wall Lantern
English Bronze Finish
11"W x 9-1/2"H x 11-1/2"E
1E 60W
UL Wet Rated

KENSINGTON

OUTDOOR



A.



*B.



C.



D.



*E.



F.

- A. 5-0630-BK**
1-Light Outdoor Wall Lantern
Textured Black Finish
8-1/4"W x 20"H x 7-3/4"E
1E 60W
Clear Beveled Glass
UL Wet Rated
- B. 5-0635-BK**
3-Light Outdoor Hanging Lantern
Textured Black Finish
8-1/4"W x 13-3/4"H
3C 40W
Clear Beveled Glass
Metal Candle Covers
UL Damp Rated
- C. 5-0629-BK**
1-Light Outdoor Wall Lantern
Textured Black Finish
5-1/2"W x 10-1/2"H x 6"E
1E 60W
Clear Beveled Glass
UL Wet Rated
- D. 5-0634-BK**
1-Light Outdoor Wall Lantern
Textured Black Finish
7-3/4"W x 11-1/2"H x 8"E
1E 60W
Clear Beveled Glass
UL Wet Rated
- E. 5-0631-BK**
1-Light Outdoor Hanging Lantern
Textured Black Finish
8-1/8"W x 17-3/4"H
1E 60W
Clear Beveled Glass
UL Damp Rated
- F. 5-0633-BK**
1-Light Outdoor Wall Lantern
Textured Black Finish
8-1/4"W x 15-3/4"H x 7-3/4"E
1E 60W
Clear Beveled Glass
UL Wet Rated
- G. SCOUT**
6-8074-15-SN
15" Flush Mount
Satin Nickel Finish
15"W x 6-1/2"H
3E 60W
- H. SCOUT**
6-8074-15-13
15" Flush Mount
English Bronze
Finish
15"W x 6-1/2"H
3E 60W

*Includes 120" chain & 144" wire



EXTERIOR COLLECTIONS

OUTDOOR



G.



H.



I.



J.



K.



L.



M.



N.



O.

- I. BARRETT**
5-369-10-BK
10" Flush Mount
Matte Black Finish
10"W x 6"H
1E 60W
Clear Seeded Glass
UL Wet Rated
- J. BARRETT**
5-369-13-BK
13" Flush Mount
Matte Black Finish
13"W x 6-3/4"H
2E 60W
Clear Seeded Glass
UL Wet Rated
- K. 5-2066-72**
9" Flush Mount
Rustic Bronze Finish
9"W x 5"H
1E 60W
Frosted Glass
UL Damp Rated
- L. 5-1161-BK**
1-Light Outdoor
Wall Lantern
Matte Black Finish
4-3/4"W x 7-7/8"H x 5-1/2"E
1E 60W
Clear Glass
UL Wet Rated
- M. 5-1161-RP**
1-Light Outdoor
Wall Lantern
Rust Patina Finish
4-3/4"W x 7-7/8"H x 5-1/2"E
1E 60W
Clear Glass
UL Wet Rated
- N. 5-3045-72**
1-Light Outdoor
Wall Lantern
Rustic Bronze Finish
6"W x 9"H x 7"E
1E 60W
Clear Glass
UL Damp Rated
- O. 5-3045-BK**
1-Light Outdoor
Wall Lantern
Matte Black Finish
6"W x 9"H x 7"E
1E 60W
Clear Glass
UL Damp Rated

STEM INFORMATION

ITEM	FAMILY	EXT or EXTLG	SWIVEL	LENGTHS OF STEM / #STEMS IN BOX
1-1023-5-322	CALHOUN	EXT	30°	12"(8pc) & 6"(2pcs)
1-1023-5-89	CALHOUN	EXT	30°	12"(8pc) & 6"(2pcs)
1-1023-5-SN	CALHOUN	EXT	30°	12"(8pc) & 6"(2pcs)
1-1065-4-10	CAMEO	EXTLG	--	12"(8pc) & 6"(2pcs)
1-1099-5-182	LARAMIE	EXT	--	12"(4pcs) & 6"(1pc)
1-1099-5-183	LARAMIE	EXT	--	12"(4pcs) & 6"(1pc)
1-1270-6-50	AZORES	EXTLG	--	12"(8pc) & 6"(2pcs)
1-1590-9-38	AMANI	EXTLG	--	12"(4pcs) & 6"(1pc)
1-1590-9-50	AMANI	EXTLG	--	12"(4pcs) & 6"(1pc)
1-1591-14-38	AMANI	EXTLG	--	12"(4pcs) & 6"(1pc)
1-1591-14-50	AMANI	EXTLG	--	12"(4pcs) & 6"(1pc)
1-1592-15-38	AMANI	EXTLG	--	12"(4pcs) & 6"(1pc)
1-1592-15-50	AMANI	EXTLG	--	12"(4pcs) & 6"(1pc)
1-1613-4-322	FALLON	EXT	--	12"(4pcs) & 6"(1pc)
1-1613-4-89	FALLON	EXT	--	12"(4pcs) & 6"(1pc)
1-1614-3-322	FALLON	EXT	--	12"(4pcs) & 6"(1pc)
1-1614-3-89	FALLON	EXT	--	12"(4pcs) & 6"(1pc)
1-1623-6-322	CRISTOFER	EXT	--	12"(4pcs) & 6"(1pc)
1-1623-6-89	CRISTOFER	EXT	--	12"(4pcs) & 6"(1pc)
1-1624-8-322	CRISTOFER	EXT	--	12"(8pcs) & 6"(2pcs)
1-1624-8-89	CRISTOFER	EXT	--	12"(8pcs) & 6"(2pcs)
1-1630-5-143	BRODY	EXT	--	12"(4pcs) & 6"(1pc)
1-1630-5-173	BRODY	EXT	--	12"(4pcs) & 6"(1pc)
1-1631-6-143	BRODY	EXT	--	12"(4pcs) & 6"(1pc)
1-1631-6-173	BRODY	EXT	--	12"(4pcs) & 6"(1pc)
1-1635-5-143	ASHOR	EXT	--	12"(4pcs) & 6"(1pc)
1-1636-8-143	ASHOR	EXT	--	12"(4pcs) & 6"(1pc)
1-1637-8-143	ASHOR	EXTLG	--	12"(4pcs) & 6"(1pc)
1-1716-8-322	CHAUCER	EXT	--	12"(4pcs) & 6"(1pc)
1-1733-12-322	ARLON	EXT	--	12"(4pcs) & 6"(1pc)
1-1734-24-322	ARLON	EXTLG	--	12"(4pcs) & 6"(1pc)
1-1738-5-320	ASHE	EXTLG	--	12"(8pcs) & 6"(2pcs)
1-1760-8-198	DANIELS	EXTLG	--	12"(4pcs) & 6"(1pc)
1-1760-8-80	DANIELS	EXTLG	--	12"(4pcs) & 6"(1pc)
1-1785-6-322	EDGEWOOD	EXT	--	12"(4pcs) & 6"(1pc)
1-1785-6-89	EDGEWOOD	EXT	--	12"(4pcs) & 6"(1pc)
1-1786-5-322	EDGEWOOD	EXT	--	12"(4pcs) & 6"(1pc)
1-1786-5-89	EDGEWOOD	EXT	--	12"(4pcs) & 6"(1pc)
1-1800-16-171	VISTA	EXTLG	--	12"(8pcs) & 6"(2pcs)
1-1800-16-89	VISTA	EXTLG	--	12"(8pcs) & 6"(2pcs)
1-1805-10-109	KAMERON	EXTLG	--	12"(4pcs) & 6"(1pc)
1-1805-10-322	KAMERON	EXTLG	--	12"(4pcs) & 6"(1pc)
1-1805-10-89	KAMERON	EXTLG	--	12"(4pcs) & 6"(1pc)
1-181-4-171	BEACON	EXTLG	--	12"(4pcs) & 6"(1pc)
1-1824-6-320	CANNON	EXT	--	12"(4pcs) & 6"(1pc)
1-1832-5-322	LAKWOOD	EXT	--	12"(4pcs) & 6"(1pc)
1-1832-5-89	LAKWOOD	EXT	--	12"(4pcs) & 6"(1pc)

STEM INFORMATION

ITEM	FAMILY	EXT or EXTLG	SWIVEL	LENGTHS OF STEM / #STEMS IN BOX
1-1833-6-322	LAKEWOOD	EXT	--	12"(8pcs) & 6"(2pcs)
1-1833-6-89	LAKEWOOD	EXT	--	12"(8pcs) & 6"(2pcs)
1-1846-4-127	LIVORNO	EXT	--	12"(8pcs) & 6"(2pcs)
1-1847-8-127	LIVORNO	EXT	--	12"(8pcs) & 6"(2pcs)
1-1857-6-62	ARIEL	EXT	--	12"(4pcs) & 6"(1pc)
1-1858-6-62	ARIEL	EXTLG	--	12"(4pcs) & 6"(1pc)
1-1887-6-143	TIVOLI	EXT	--	12"(4pcs) & 6"(1pc)
1-1889-8-143	TIVOLI	EXT	--	12"(8pcs) & 6"(2pcs)
1-1893-6-143	TIVOLI	EXT	--	12"(4pcs) & 6"(1pc)
1-190-5-109	PALLADIAN	EXT	--	12"(8pcs) & 6"(2pcs)
1-190-5-322	PALLADIAN	EXT	--	12"(8pcs) & 6"(2pcs)
1-190-5-89	PALLADIAN	EXT	--	12"(8pcs) & 6"(2pcs)
1-190-5-SN	PALLADIAN	EXT	--	12"(8pcs) & 6"(2pcs)
1-1906-6-143	MIDLAND	EXT	--	12"(4pcs) & 6"(1pc)
1-1907-8-143	MIDLAND	EXT	--	12"(8pcs) & 6"(2pcs)
1-1961-16-18	GISELLE	EXTLG	--	12"(4pcs) & 6"(1pc)
1-1962-24-18	GISELLE	EXTLG	--	12"(4pcs) & 6"(1pc)
1-1963-10-18	GISELLE	EXTLG	--	12"(8pcs) & 6"(2pcs)
1-1982-4-143	EATON	EXT	--	12"(8pcs) & 6"(2pcs)
1-2031-5-260	PORTIA	EXTLG	--	12"(4pcs) & 6"(1pc)
1-2032-6-260	PORTIA	EXT	--	12"(8pcs) & 6"(2pcs)
1-2106-5-322	SHELLBOURNE	EXT	--	12"(4pcs) & 6"(1pc)
1-2135-5-67	FOLSOM	EXT	--	12"(4pcs) & 6"(1pc)
1-2139-8-67	FOLSOM	EXT	--	12"(4pcs) & 6"(1pc)
1-2216-6-322	LEIGHTON	EXT	--	12"(4pcs) & 6"(1pc)
1-2218-8-322	LEIGHTON	EXTLG	--	12"(4pcs) & 6"(1pc)
1-2294-12-262	OAKHURST	EXTLG	--	12"(4pcs) & 6"(1pc)
1-2296-16-262	OAKHURST	EXTLG	--	12"(4pcs) & 6"(1pc)
1-2304-6-260	QUATRIN	EXT	--	12"(4pcs) & 6"(1pc)
1-2305-8-260	QUATRIN	EXT	--	12"(8pcs) & 6"(2pcs)
1-2330-5-50	ORLEANS	EXTLG	--	12"(8pcs) & 6"(2pcs)
1-2330-5-60	ORLEANS	EXTLG	--	12"(8pcs) & 6"(2pcs)
1-2332-8-50	ORLEANS	EXTLG	--	12"(8pcs) & 6"(2pcs)
1-2332-8-60	ORLEANS	EXTLG	--	12"(8pcs) & 6"(2pcs)
1-2507-8-322	DEL MAR	EXTLG	--	12"(8pcs) & 6"(2pcs)
1-2508-4-322	DEL MAR	EXT	--	12"(8pcs) & 6"(2pcs)
1-2520-6-322	NEWPORT	EXT	--	12"(8pcs) & 6"(2pcs)
1-2520-6-89	NEWPORT	EXT	--	12"(8pcs) & 6"(2pcs)
1-2540-5-322	CAMERON	EXT	30°	12"(4pcs) & 6"(1pc)
1-2540-5-89	CAMERON	EXT	30°	12"(4pcs) & 6"(1pc)
1-2541-9-109	CAMERON	EXT	30°	12"(4pcs) & 6"(1pc)
1-2541-9-322	CAMERON	EXT	30°	12"(4pcs) & 6"(1pc)
1-2541-9-89	CAMERON	EXT	30°	12"(4pcs) & 6"(1pc)
1-2579-6-26	GRECIAN	EXTLG	--	12"(4 pcs) & 6"(1pc)
1-2802-6-322	HAYNES	EXT	--	12"(4pcs) & 6"(1pc)
1-2803-5-322	HAYNES	EXT	--	12"(8pcs) & 6"(2pcs)
1-2803-5-89	HAYNES	EXT	--	12"(8pcs) & 6"(2pcs)

STEM INFORMATION

ITEM	FAMILY	EXT or EXTLG	SWIVEL	LENGTHS OF STEM / #STEMS IN BOX
1-3073-5-11	WRIGHT	EXT	--	12"(4pcs) & 6"(1pc)
1-3073-5-322	WRIGHT	EXT	--	12"(4pcs) & 6"(1pc)
1-3073-5-89	WRIGHT	EXT	--	12"(4pcs) & 6"(1pc)
1-3074-8-11	WRIGHT	EXTLG	--	12"(4pcs) & 6"(1pc)
1-3074-8-322	WRIGHT	EXTLG	--	12"(4pcs) & 6"(1pc)
1-3074-8-89	WRIGHT	EXTLG	--	12"(4pcs) & 6"(1pc)
1-3165-8-322	GIDEON	EXT	--	12"(8pcs) & 6"(2pcs)
1-3166-6-322	GIDEON	EXTLG	--	12"(4pcs) & 6"(1pc)
1-3167-4-322	GIDEON	EXT	--	12"(4pcs) & 6"(1pc)
1-326-3-322	DENTON	EXT	--	12"(8pcs) & 6"(2pcs)
1-326-3-44	DENTON	EXT	--	12"(8pcs) & 6"(2pcs)
1-327-5-322	DENTON	EXT	--	12"(8pcs) & 6"(2pcs)
1-327-5-44	DENTON	EXT	--	12"(8pcs) & 6"(2pcs)
1-3319-7-11	MARIAS	EXT	--	12"(4pcs) & 6"(1pc)
1-3319-7-322	MARIAS	EXT	--	12"(4pcs) & 6"(1pc)
1-3319-7-89	MARIAS	EXT	--	12"(4pcs) & 6"(1pc)
1-3720-6-89	BOCA	EXTLG	--	12"(4pcs) & 6"(1pc)
1-3722-10-89	BOCA	EXTLG	--	12"(4pcs) & 6"(1pc)
1-4180-8-127	LIO	EXT	--	12"(4pcs) & 6"(1pc)
1-4410-5-109	JASMINE	EXT	--	12"(4pcs) & 6"(1pc)
1-4410-5-322	JASMINE	EXT	--	12"(4pcs) & 6"(1pc)
1-4410-5-89	JASMINE	EXT	--	12"(4pcs) & 6"(1pc)
1-4412-8-109	JASMINE	EXT	--	12"(4pcs) & 6"(1pc)
1-4412-8-322	JASMINE	EXT	--	12"(4pcs) & 6"(1pc)
1-4412-8-89	JASMINE	EXT	--	12"(4pcs) & 6"(1pc)
1-4418-3-322	ADAMS	EXT	--	12"(4pcs) & 6"(1pc)
1-4419-5-322	ADAMS	EXT	--	12"(4pcs) & 6"(1pc)
1-4570-8-89	CALGARY	EXTLG	--	12"(4pcs) & 6"(1pc)
1-4571-6-89	CALGARY	EXTLG	--	12"(4pcs) & 6"(1pc)
1-5148-14-24	ESTRELLA DEL MAR	EXTLG	--	12"(4 pcs) & 6"(1pc)
1-5407-5-322	FALSTER	EXT	--	12"(8pcs) & 6"(2pcs)
1-5407-5-89	FALSTER	EXT	--	12"(8pcs) & 6"(2pcs)
1-5409-5-322	FALSTER	EXT	--	12"(4pcs) & 6"(1pc)
1-5409-5-89	FALSTER	EXT	--	12"(4pcs) & 6"(1pc)
1-5500-6-322	NOUVEL	EXT	--	12"(4pcs) & 6"(1pc)
1-5502-8-322	NOUVEL	EXT	--	12"(4pcs) & 6"(1pc)
1-5504-12-322	NOUVEL	EXTLG	--	12"(4pcs) & 6"(1pc)
1-5533-8-143	ARCHWAY	EXT	--	12"(8pcs) & 6"(2pcs)
1-6219-4-322	LEGACY	EXT	--	12"(8pcs) & 6"(2pcs)
1-6219-4-89	LEGACY	EXT	--	12"(8pcs) & 6"(2pcs)
1-6415-8-322	PRESERVE	EXT	--	12"(4pcs) & 6"(1pc)
1-6415-8-89	PRESERVE	EXT	--	12"(4pcs) & 6"(1pc)
1-6508-5-127	LIO	EXT	--	12"(4pcs) & 6"(1pc)
1-6620-6-89	KAHN	EXTLG	--	12"(4pcs) & 6"(1pc)
1-6622-9-89	KAHN	EXTLG	--	12"(4pcs) & 6"(1pc)
1-6680-8-127	SORRENTO	EXTLG	--	12"(4pcs) & 6"(1pc)
1-6680-8-89	SORRENTO	EXTLG	--	12"(4pcs) & 6"(1pc)

STEM INFORMATION

ITEM	FAMILY	EXT or EXTLG	SWIVEL	LENGTHS OF STEM / #STEMS IN BOX
1-6680-8-SN	SORRENTO	EXTLG	--	12"(4pcs) & 6"(1pc)
1-6682-15-127	SORRENTO	EXTLG	--	12"(4pcs) & 6"(1pc)
1-6682-15-89	SORRENTO	EXTLG	--	12"(4pcs) & 6"(1pc)
1-6682-15-SN	SORRENTO	EXTLG	--	12"(4pcs) & 6"(1pc)
1-6697-4-143	COUPLET	EXT	--	12"(4pcs) & 6"(1pc)
1-6698-8-143	COUPLET	EXT	--	12"(4pcs) & 6"(1pc)
1-6699-8-143	COUPLET	EXT	--	12"(8pcs) & 6"(2pcs)
1-7000-6-109	LYRIQUE	EXT	30°	12"(4pcs) & 6"(1pc)
1-7000-6-322	LYRIQUE	EXT	30°	12"(4pcs) & 6"(1pc)
1-7000-6-77	LYRIQUE	EXT	30°	12"(4pcs) & 6"(1pc)
1-7000-6-89	LYRIQUE	EXT	30°	12"(4pcs) & 6"(1pc)
1-7001-12-109	LYRIQUE	EXT	30°	12"(4pcs) & 6"(1pc)
1-7001-12-322	LYRIQUE	EXT	30°	12"(4pcs) & 6"(1pc)
1-7001-12-77	LYRIQUE	EXT	30°	12"(4pcs) & 6"(1pc)
1-7001-12-89	LYRIQUE	EXT	30°	12"(4pcs) & 6"(1pc)
1-7504-10-322	MARIPOSA	EXTLG	--	12"(4pcs) & 6"(1pc)
1-7508-9-127	TALAMANCA	EXT	--	12"(8pcs) & 6"(2pcs)
1-7750-4-322	WYNWOOD	EXT	--	12"(4pcs) & 6"(1pc)
1-7751-5-322	WYNWOOD	EXT	--	12"(4pcs) & 6"(1pc)
1-7752-6-322	WYNWOOD	EXTLG	--	12"(4pcs) & 6"(1pc)
1-7804-5-142	SHEFFIELD	EXT	--	12"(8pcs) & 6"(2pcs)
1-7804-5-143	SHEFFIELD	EXT	--	12"(8pcs) & 6"(2pcs)
1-8003-6-127	PHAROS	EXT	--	12"(4pcs) & 6"(1pc)
1-8004-5-127	PHAROS	EXT	--	12"(4pcs) & 6"(1pc)
1-8005-2-127	PHAROS	EXT	--	12"(4pcs) & 6"(1pc)
1-8042-6-79	KIRKLAND	EXTLG	30°	12"(4pcs) & 6"(1pc)
1-8070-8-51	KEARNEY	EXT	30°	12"(4pcs) & 6"(1pc)
1-8803-5-322	HELEN	EXT	--	12"(4pcs) & 6"(1pc)
1-8804-8-322	HELEN	EXTLG	--	12"(4pcs) & 6"(1pc)
1-8860-8-109	BAKER	EXT	--	12"(4pcs) & 6"(1pc)
1-8860-8-322	BAKER	EXT	--	12"(4pcs) & 6"(1pc)
1-8860-8-89	BAKER	EXT	--	12"(4pcs) & 6"(1pc)
1-8862-16-109	BAKER	EXT	--	12"(4pcs) & 6"(1pc)
1-8862-16-109	BAKER	EXT	--	12"(4pcs) & 6"(1pc)
1-8862-16-322	BAKER	EXT	--	12"(4pcs) & 6"(1pc)
1-8862-16-322	BAKER	EXT	--	12"(4pcs) & 6"(1pc)
1-8862-16-89	BAKER	EXT	--	12"(4pcs) & 6"(1pc)
1-8862-16-89	BAKER	EXT	--	12"(4pcs) & 6"(1pc)
1-8892-5-101	HASTING	EXT	--	12"(8pc) & 6"(2pcss)
1-8951-8-322	DEL MAR	EXT	--	12"(8pc) & 6"(2pcss)
1-9601-6-171	LONGFELLOW	EXT	--	12"(8pc) & 6"(2pcss)
1-9601-6-89	LONGFELLOW	EXT	--	12"(8pc) & 6"(2pcss)
1-9704-10-322	BENNINGTON	EXTLG	--	12"(4pcs) & 6"(1pc)
1-9705-16-322	BENNINGTON	EXTLG	--	12"(4pcs) & 6"(1pc)
1-9772-10-322	WINFIELD	EXT	30°	12"(4pcs) & 6"(1pc)
1-9772-10-89	WINFIELD	EXT	30°	12"(4pcs) & 6"(1pc)
1-9773-12-322	WINFIELD	EXT	30°	12"(8pc) & 6"(2pcss)

STEM INFORMATION

ITEM	FAMILY	EXT or EXTLG	SWIVEL	LENGTHS OF STEM / #STEMS IN BOX
1-9773-12-89	WINFIELD	EXT	30°	12"(8pc) & 6"(2pcs)
1-9945-5-143	QUINCY	EXT	--	12"(4pcs) & 6"(1pc)
3-1617-4-11	KOLE	EXT	--	12"(4pcs) & 6"(1pc)
3-1617-4-322	KOLE	EXT	--	12"(4pcs) & 6"(1pc)
3-1617-4-89	KOLE	EXT	--	12"(4pcs) & 6"(1pc)
3-1773-6-320	ASHBURN	EXTLG	--	12"(4pcs) & 6"(1pc)
3-2226-8-322	ROHE	EXTLG	--	12"(4pcs) & 6"(1pc)
3-2226-8-89	ROHE	EXTLG	--	12"(4pcs) & 6"(1pc)
3-2406-4-322	ROSEDALE	EXT	--	12"(4pcs) & 6"(1pc)
3-2406-4-89	ROSEDALE	EXT	--	12"(4pcs) & 6"(1pc)
3-4197-4-322	BIRCH	EXT	--	12"(4pcs) & 6"(1pc)
3-4197-4-83	BIRCH	EXT	--	12"(4pcs) & 6"(1pc)
3-4390-5-47	BALI	EXTLG	--	12"(4pcs) & 6"(1pc)
3-4390-5-50	BALI	EXTLG	--	12"(4pcs) & 6"(1pc)
3-4391-6-47	BALI	EXTLG	--	12"(4pcs) & 6"(1pc)
3-4391-6-50	BALI	EXTLG	--	12"(4pcs) & 6"(1pc)
3-4901-4-322	KENT	EXT	30°	12"(4pcs) & 6"(1pc)
3-4901-4-89	KENT	EXT	30°	12"(4pcs) & 6"(1pc)
3-6612-4-322	DIPLOMAT	EXT	--	12"(4pcs) & 6"(1pc)
3-6612-4-89	DIPLOMAT	EXT	--	12"(4pcs) & 6"(1pc)
3-6612-4-SN	DIPLOMAT	EXT	--	12"(4pcs) & 6"(1pc)
3-7700-3-322	BENSON	EXT	--	12"(4pcs) & 6"(1pc)
3-7700-3-89	BENSON	EXT	--	12"(4pcs) & 6"(1pc)
3-7700-3-SN	BENSON	EXT	--	12"(4pcs) & 6"(1pc)
3-7701-5-322	BENSON	EXT	--	12"(4pcs) & 6"(1pc)
3-7701-5-89	BENSON	EXT	--	12"(4pcs) & 6"(1pc)
3-7701-5-SN	BENSON	EXT	--	12"(4pcs) & 6"(1pc)
3-8072-4-51	KEARNEY	EXT	30°	12"(4pcs) & 6"(1pc)
3-8811-6-92	JOLIET	EXTLG	--	12"(4pcs) & 6"(1pc)
3-9950-4-322	FARELL	EXT	--	12"(4pcs) & 6"(1pc)
3-9950-4-89	FARELL	EXT	--	12"(4pcs) & 6"(1pc)
6-1067-4-10	CAMEO	EXTLG	--	12"(4pcs) & 6"(1pc)
6-1272-4-50	AZORES	EXTLG	--	12"(4pcs) & 6"(1pc)
6-1662-4-322	ROTTERDAM	EXT	30°	12"(4pcs) & 6"(1pc)
6-6684-4-127	ANHOLT	EXT	--	12"(4pcs) & 6"(1pc)
7-1010-1-SN	HERNDON	EXT	90°	9.5"(3pcs)
7-1026-1-322	CALHOUN	EXT	90°	9.5"(3pcs)
7-1026-1-89	CALHOUN	EXT	90°	9.5"(3pcs)
7-1026-1-SN	CALHOUN	EXT	90°	9.5"(3pcs)
7-1027-1-322	CALHOUN	EXT	90°	9.5"(3pcs)
7-1027-1-89	CALHOUN	EXT	90°	9.5"(3pcs)
7-1027-1-SN	CALHOUN	EXT	90°	9.5"(3pcs)
7-1066-6-10	CAMEO	EXTLG	--	12"(4pcs) & 6"(1pc)
7-1271-6-50	AZORES	EXTLG	--	12"(4pcs) & 6"(1pc)
7-130-1-44	ASHMONT	EXT	90°	9.5"(3pcs)
7-130-1-63	ASHMONT	EXT	90°	9.5"(3pcs)
7-130-1-SN	ASHMONT	EXT	90°	9.5"(3pcs)













































STEM INFORMATION

ITEM	FAMILY	EXT or EXTLG	SWIVEL	LENGTHS OF STEM / #STEMS IN BOX
7-1398-3-14	BREWSTER	EXTLG	--	12"(4pcs) & 6"(1pc)
7-1399-5-14	BREWSTER	EXTLG	--	12"(4pcs) & 6"(1pc)
7-1429-1-89	MARCY	EXTLG	--	12"(4pcs) & 6"(1pc)
7-1610-6-322	PYRAMID	EXTLG	--	12"(4pcs) & 6"(1pc)
7-1610-6-89	PYRAMID	EXTLG	--	12"(4pcs) & 6"(1pc)
7-1620-43-322	LANDON	EXTLG	--	12"(4pcs) & 6"(1pc)
7-1621-53-322	LANDON	EXTLG	--	12"(4pcs) & 6"(1pc)
7-1622-117-322	LANDON	EXTLG	--	12"(4pcs) & 6"(1pc)
7-1643-1-143	ABEL	EXT	--	12"(4pcs) & 6"(1pc)
7-1660-6-322	ROTTERDAM	EXTLG	30°	12"(4pcs) & 6"(1pc)
7-1690-1-142	GAVIN	EXTLG	--	12"(4pcs) & 6"(1pc)
7-1690-1-143	GAVIN	EXTLG	--	12"(4pcs) & 6"(1pc)
7-1696-5-143	HAYWARD	EXTLG	--	12"(4pcs) & 6"(1pc)
7-1699-3-143	HAYWARD	EXTLG	--	12"(4pcs) & 6"(1pc)
7-1732-10-322	ARLON	EXT	--	12"(4pcs) & 6"(1pc)
7-1739-4-320	ASHE	EXTLG	--	12"(4pcs) & 6"(1pc)
7-1742-1-109	CHANTILLY	EXT	90°	9.5"(3pcs)
7-1742-1-322	CHANTILLY	EXT	90°	9.5"(3pcs)
7-1742-1-89	CHANTILLY	EXT	90°	9.5"(3pcs)
7-1774-6-320	ASHBURN	EXTLG	--	12"(4pcs) & 6"(1pc)
7-180-1-109	BECKER	EXT	90°	9.5"(2pcss)
7-180-1-322	BECKER	EXT	90°	9.5"(2pcss)
7-180-1-89	BECKER	EXT	90°	9.5"(2pcss)
7-180-1-SN	BECKER	EXT	90°	9.5"(2pcss)
7-182-3-171	BEACON	EXT	--	12"(4pcs) & 6"(1pc)
7-1831-1-322	LAKEWOOD	EXT	90°	9.5"(3pcs)
7-1831-1-322	LAKEWOOD	EXT	90°	9.5"(3pcs)
7-1831-1-89	LAKEWOOD	EXT	90°	9.5"(3pcs)
7-1831-1-89	LAKEWOOD	EXT	90°	9.5"(3pcs)
7-1927-6-143	KELVIN	EXT	--	12"(4pcs) & 6"(1pc)
7-1956-16-37	KILLIAM	EXTLG	--	12"(4pcs) & 6"(1pc)
7-1957-12-37	KILLIAM	EXTLG	--	12"(4pcs) & 6"(1pc)
7-1983-1-143	EATON	EXT	--	12"(8pc) & 6"(2pcss)
7-200-3-322	STIRLING	EXT	30°	12"(4pcs) & 6"(1pc)
7-2224-5-322	ROHE	EXTLG	--	12"(4pcs) & 6"(1pc)
7-2224-5-89	ROHE	EXTLG	--	12"(4pcs) & 6"(1pc)
7-2244-6-10	HENDREN	EXTLG	--	12"(1pc)
7-2255-1-322	BRANDON	EXT	--	12"(4pcs) & 6"(1pc)
7-2255-1-89	BRANDON	EXT	--	12"(4pcs) & 6"(1pc)
7-2265-1-322	BRISTO	EXT	--	12"(4pcs) & 6"(1pc)
7-2265-1-89	BRISTO	EXT	--	12"(4pcs) & 6"(1pc)
7-2303-4-260	QUATRIN	EXT	--	12"(4pcs) & 6"(1pc)
7-2351-12-11	VASARE	EXTLG	30°	12"(4pcs) & 6"(1pc)
7-2416-3-143	LAMAR	EXT	30°	12"(4pcs) & 6"(1pc)
7-2416-3-160	LAMAR	EXT	30°	12"(4pcs) & 6"(1pc)
7-2521-4-322	NEWPORT	EXT	--	12"(4pcs) & 6"(1pc)
7-2521-4-89	NEWPORT	EXT	--	12"(4pcs) & 6"(1pc)









































STEM INFORMATION

ITEM	FAMILY	EXT or EXTLG	SWIVEL	LENGTHS OF STEM / #STEMS IN BOX
7-3075-1-11	WRIGHT	EXT	90°	9.5"(3pcs)
7-3075-1-322	WRIGHT	EXT	90°	9.5"(3pcs)
7-3075-1-89	WRIGHT	EXT	90°	9.5"(3pcs)
7-3100-1-322	WESTBOURNE	EXT	90°	9.5"(3pcs)
7-3102-1-322	WESTBOURNE	EXTLG	30°	12"(4pcs) & 6"(1pc)
7-3168-3-322	GIDEON	EXT	--	12"(4pcs) & 6"(1pc)
7-3168-3-322	GIDEON	EXT	--	12"(4pcs) & 6"(1pc)
7-3171-1-322	ISLA BLANCA	--	--	--
7-3390-1-322	CARLTON	EXT	--	12"(4pcs) & 6"(1pc)
7-3390-1-89	CARLTON	EXT	--	12"(4pcs) & 6"(1pc)
7-3398-1-322	ASTER	EXT	--	12"(4pcs) & 6"(1pc)
7-3751-1-322	BERG	EXT	30°	12"(4pcs) & 6"(1pc)
7-3751-1-89	BERG	EXT	30°	12"(4pcs) & 6"(1pc)
7-3751-1-SN	BERG	EXT	30°	12"(4pcs) & 6"(1pc)
7-4036-1-11	OCTAVE	EXT	90°	9.5"(3pcs)
7-4036-1-13	OCTAVE	EXT	90°	9.5"(3pcs)
7-4036-1-322	OCTAVE	EXT	90°	9.5"(3pcs)
7-4036-1-BK	OCTAVE	EXT	90°	9.5"(3pcs)
7-4036-1-SN	OCTAVE	EXT	90°	9.5"(3pcs)
7-4134-1-13	VINTAGE	EXT	90°	9.5"(3pcs)
7-4134-1-SN	VINTAGE	EXT	90°	9.5"(3pcs)
7-4499-1-109	WILLIS	EXT	--	12"(4pcs) & 6"(1pc)
7-4499-1-322	WILLIS	EXT	--	12"(4pcs) & 6"(1pc)
7-4499-1-89	WILLIS	EXT	--	12"(4pcs) & 6"(1pc)
7-4600-1-142	CARLYSLE	EXT	--	12"(4pcs) & 6"(1pc)
7-4600-1-143	CARLYSLE	EXT	--	12"(4pcs) & 6"(1pc)
7-5012-1-109	GARVEY	EXT	90°	9.5"(3pcs)
7-5012-1-13	GARVEY	EXT	90°	9.5"(3pcs)
7-5532-4-143	ARCHWAY	EXT	--	12"(4pcs) & 6"(1pc)
7-6099-24-109	GALEA	EXT	30°	12"(4pcs) & 6"(1pc)
7-6099-24-322	GALEA	EXT	30°	12"(4pcs) & 6"(1pc)
7-6099-24-89	GALEA	EXT	30°	12"(4pcs) & 6"(1pc)
7-6304-4-322	CHARTWELL	EXT	--	12"(4pcs) & 6"(1pc)
7-6304-4-89	CHARTWELL	EXT	--	12"(4pcs) & 6"(1pc)
7-6407-3-322	THORNHILL	EXT	--	12"(4pcs) & 6"(1pc)
7-6407-3-89	THORNHILL	EXT	--	12"(4pcs) & 6"(1pc)
7-6427-1-322	LANAI	EXTLG	--	12"(4pcs) & 6"(1pc)
7-7006-1-322	FOSTER	EXT	--	12"(4pcs) & 6"(1pc)
7-7006-1-89	FOSTER	EXT	--	12"(4pcs) & 6"(1pc)
7-7006-1-SN	FOSTER	EXT	--	12"(4pcs) & 6"(1pc)
7-7201-1-322	PENDLETON	EXT	90°	9.5"(3pcs)
7-7201-1-89	PENDLETON	EXT	90°	9.5"(3pcs)
7-7201-1-SN	PENDLETON	EXT	90°	9.5"(3pcs)
7-730-1-109	CHIVAL	EXT	90°	9.5"(3pcs)
7-7639-1-11	BOWDIN	EXT	--	12"(4pcs) & 6"(1pc)
7-7639-1-322	BOWDIN	EXT	--	12"(4pcs) & 6"(1pc)
7-7639-1-83	BOWDIN	EXT	--	12"(4pcs) & 6"(1pc)

FINISH GUIDE

10		Champagne Luxe	59		French Gold w/ White Cashmere
11		Polished Chrome	60		Distressed Gold
13		English Bronze	62		Como Black w/ Gold
14		Cavalier Gold w/ Royal White	63		Warm Brass Lustre
18		Delphine	67		Matte Black w/ Polished Chrome
24		Centura w/ Burnished Gold	70		Weathervane
26		Champagne Mist w/ Coconut Shell	72		Rustic Bronze
28		Oiled Burnished Bronze	76		Florencian Bronze
31		Grecian Gold	77		Bronze w/ Brass
37		Cavalier Gold	79		English Bronze & Warm Brass
38		Royal Gold	80		Matte White
39		Fossil Stone	83		Bisque White
40		Walnut Patina	84		Rubbed Bronze W/ Gold Leaf
41		Durango	85		Rubbed Zinc w/ Silver Leaf
44		Classic Bronze	88		Oxidized Black
46		Calypso	89		Matte Black
47		White Cashmere	90		Galvanized Metal
50		Black Cashmere	92		Rumba
51		Vintage Black w/ Warm Brass	95		Warm Brass w/ Bronze
53		Silver Patina	101		Noblewood w/ Iron
54		Gold Patina	102		Patinated Bronze
58		Midnight	103		Satin Black w/ Hammered Gold

FINISH GUIDE

104		Metropolis Black w/ Gold	186		French Gold
109		Polished Nickel	188		Black Tourmaline
111		Satin Nickel w/ Polished Nickel	195		Warm Brass w/ Chrome
121		Mohican Bronze	198		Natural Antler
127		Noble Brass	212		Argentum & Gold
128		Café	213		English Bronze w/ Gold
137		Textured Black w/ Warm Brass	260		True Gold
142		White w/ Warm Brass	261		Matte Black w/ True Gold
143		Black w/ Warm Brass	262		Antique Gold
144		Matte Black w/ Burnished Brass	263		Black Marble w/ Warm Brass
153		Black w/ Gold Highlights	264		White Marble w/ Warm Brass
160		White w/ Brass	320		Warm Brass & Rope
165		Satin Nickel w/ Gray Wood	322		Warm Brass
171		Burnished Brass	323		Old Bronze
172		White w/ Polished Nickel	BK		Black
173		Black w/ Polished Nickel	BZ		Bronze
174		Navy w/ Polished Nickel	CH		Chrome
175		Gray w/ Polished Nickel	SN		Satin Nickel
177		Burnished Brass w/ Natural Rattan	WH		White
180		Matte Black w/ Dark Rattan			
182		Chelsea Gold			
183		Chelsea Walnut			

INDEX

1-1021-5-322.....	225	1-1672-12-89.....	381	1-1866-4-322.....	83
1-1021-5-89.....	223	1-1675-8-171.....	393	1-1867-10-322.....	83
1-1021-5-SN.....	224	1-1675-8-89.....	393	1-1868-15-322.....	81, 365
1-1023-5-322.....	225	1-1716-8-322.....	350	1-1868-15-89.....	81, 365
1-1023-5-89.....	223	1-1727-5-322.....	12	1-1887-6-143.....	56
1-1023-5-SN.....	224	1-1733-12-322.....	26	1-1889-8-143.....	56
1-1065-4-10.....	342	1-1734-24-322.....	26, 372	1-1893-6-143.....	56
1-1099-5-182.....	355	1-1738-5-320.....	325	1-190-5-109.....	213
1-1099-5-183.....	355	1-1756-6-109.....	187	1-190-5-322.....	213
1-1130-8-13.....	360	1-1756-6-322.....	187	1-190-5-89.....	213
1-1202-8-186.....	178	1-1756-6-89.....	187	1-190-5-SN.....	213
1-1202-8-83.....	178	1-1760-8-198.....	329	1-1906-6-143.....	244
1-1202-8-89.....	178	1-1760-8-80.....	329	1-1907-8-143.....	244
1-1270-6-50.....	113	1-1761-6-198.....	330	1-1932-15-322.....	394
1-1590-9-38.....	275	1-1761-6-80.....	330	1-1934-12-143.....	59, 370
1-1590-9-50.....	277	1-1785-6-322.....	185	1-1938-36-89.....	117, 371
1-1591-14-38.....	275	1-1785-6-89.....	185	1-1939-12-89.....	117
1-1591-14-50.....	277	1-1786-5-322.....	185	1-1943-10-89.....	391
1-1592-15-38.....	273	1-1786-5-89.....	185	1-1946-10-260.....	101
1-1592-15-50.....	273	1-1800-16-171.....	389	1-1961-16-18.....	103
1-1613-4-322.....	235	1-1800-16-89.....	389	1-1962-24-18.....	103
1-1613-4-89.....	235	1-1805-10-109.....	368	1-1963-10-18.....	105
1-1614-3-322.....	237	1-1805-10-322.....	368	1-1982-4-143.....	247
1-1614-3-89.....	237	1-1805-10-89.....	368	1-2031-5-260.....	99
1-1623-6-322.....	233	1-181-4-171.....	308	1-2032-6-260.....	99
1-1623-6-89.....	233	1-1823-6-320.....	327	1-2100-6-70.....	361
1-1624-8-322.....	231	1-1824-6-320.....	327	1-2106-5-322.....	23
1-1624-8-89.....	231	1-1832-5-322.....	292	1-2135-5-67.....	297
1-1630-5-143.....	189	1-1832-5-89.....	294	1-2139-8-67.....	297
1-1630-5-173.....	189	1-1833-6-322.....	292	1-2185-9-103.....	129
1-1631-6-143.....	190	1-1833-6-89.....	294	1-2206-8-322.....	39
1-1631-6-173.....	190	1-1838-6-322.....	350	1-2208-10-322.....	39
1-1635-5-143.....	250	1-1846-4-127.....	84	1-2216-6-322.....	9
1-1636-8-143.....	250	1-1847-8-127.....	84	1-2218-8-322.....	9
1-1637-8-143.....	250	1-1852-10-89.....	66	1-2221-6-109.....	168
1-1668-9-143.....	109	1-1857-6-62.....	289	1-2221-6-322.....	168
1-1669-4-143.....	109	1-1858-6-62.....	289	1-2221-6-83.....	168
1-1672-12-322.....	381	1-1865-3-322.....	83	1-2221-6-89.....	168

INDEX

1-2294-12-262.....	37	1-308-8-SN.....	194	1-423-3-322.....	209
1-2296-16-262.....	37	1-310-10-322.....	197	1-423-3-89.....	209
1-2304-6-260.....	42	1-310-10-89.....	197	1-424-5-109.....	211
1-2305-8-260.....	42	1-312-15-322.....	199	1-424-5-322.....	211
1-2330-5-50.....	33	1-312-15-89.....	199	1-424-5-44.....	211
1-2330-5-60.....	33	1-3165-8-322.....	44	1-424-5-89.....	211
1-2332-8-50.....	30	1-3166-6-322.....	44	1-424-5-SN.....	211
1-2332-8-60.....	30	1-3167-4-322.....	47	1-4410-5-109.....	171
1-2493-6-104.....	125	1-3170-6-322.....	146	1-4410-5-322.....	171
1-2507-8-322.....	149, 373	1-3173-8-322.....	146	1-4410-5-89.....	171
1-2508-4-322.....	151	1-326-3-322.....	214	1-4412-8-109.....	173
1-2520-6-322.....	238	1-326-3-44.....	214	1-4412-8-322.....	173
1-2520-6-89.....	238	1-327-5-322.....	214	1-4412-8-89.....	173
1-2540-5-322.....	182	1-327-5-44.....	214	1-4418-3-322.....	40
1-2540-5-89.....	182	1-3319-7-11.....	279	1-4419-5-322.....	40
1-2541-9-109.....	181	1-3319-7-322.....	279	1-4570-8-89.....	261, 385
1-2541-9-322.....	181	1-3319-7-89.....	279	1-4571-6-89.....	261
1-2541-9-89.....	181	1-3364-6-322.....	51	1-4681-8-102.....	133
1-2579-6-26.....	137	1-3392-4-322.....	220	1-5148-14-24.....	127
1-2700-6-322.....	20	1-3392-4-89.....	220	1-5186-12-59.....	141, 377
1-2702-8-322.....	20	1-3394-8-322.....	220	1-5407-5-322.....	303
1-2802-6-322.....	242	1-3394-8-89.....	220	1-5407-5-89.....	304
1-2802-6-89.....	241	1-3504-9-322.....	143	1-5409-5-322.....	303
1-2803-5-322.....	242	1-3505-15-322.....	143	1-5409-5-89.....	304
1-2803-5-89.....	241	1-3720-6-89.....	111	1-5500-6-322.....	7
1-3043-5-13.....	68	1-3722-10-89.....	111	1-5502-8-322.....	7
1-3060-6-60.....	107	1-3804-6-142.....	53	1-5504-12-322.....	5, 367
1-307-6-322.....	193	1-3804-6-143.....	53	1-5533-8-143.....	282
1-307-6-89.....	193	1-4000-6-31.....	123	1-6219-4-322.....	145
1-3073-5-11.....	287	1-4032-5-13.....	227	1-6219-4-89.....	145
1-3073-5-322.....	286	1-4032-5-322.....	227	1-6400-8-190.....	353
1-3073-5-89.....	285	1-4032-5-BK.....	227	1-6402-16-190.....	353, 384
1-3074-8-11.....	287	1-4032-5-SN.....	227	1-6415-8-322.....	379
1-3074-8-322.....	286	1-4046-12-322.....	161	1-6415-8-89.....	379
1-3074-8-89.....	285	1-4046-12-83.....	162	1-6508-5-127.....	154
1-308-8-322.....	194	1-4046-12-89.....	163	1-6620-6-89.....	119
1-308-8-44.....	194	1-4072-5-13.....	409	1-6622-9-89.....	119
1-308-8-89.....	194	1-4180-8-127.....	154	1-6680-8-127.....	176

INDEX

1-6680-8-89	175	1-8203-3-109	73	3-1936-6-143.....	60
1-6680-8-SN	177	1-8203-3-322.....	73	3-2226-8-322	95
1-6682-15-127.....	176	1-8203-3-89	73	3-2226-8-89	95
1-6682-15-89	175	1-8702-8-322.....	89	3-2406-4-322.....	485
1-6682-15-SN	177	1-8803-5-322	18	3-2406-4-89.....	485
1-6686-6-127.....	87	1-8804-8-322	18	3-3041-4-13	69
1-6688-8-127.....	87	1-8860-8-109.....	165	3-4080-4-79.....	501
1-6697-4-143.....	280	1-8860-8-322	165	3-4081-4-79	501
1-6698-8-143	280	1-8860-8-89	165	3-4197-4-322	334
1-6699-8-143	280	1-8862-16-109.....	167, 387	3-4197-4-83.....	335
1-6914-10-47.....	139	1-8862-16-322	167, 387	3-420-3-109	200
1-7000-6-109.....	301	1-8862-16-89	167, 387	3-420-3-322.....	200
1-7000-6-322.....	300	1-8892-5-101.....	359	3-420-3-44.....	200
1-7000-6-77.....	301	1-8951-8-322.....	151	3-420-3-89.....	200
1-7000-6-89.....	300	1-9084-12-13.....	383	3-420-3-SN.....	200
1-7001-12-109	299	1-9601-6-171.....	257	3-421-4-109	203
1-7001-12-322.....	298	1-9601-6-89	258	3-421-4-322.....	203
1-7001-12-77.....	299	1-9704-10-322	24	3-421-4-44.....	203
1-7001-12-89.....	298	1-9705-16-322	24, 376	3-421-4-89.....	203
1-7504-10-322.....	362	1-9772-10-322	218	3-421-4-SN.....	203
1-7508-9-127	153	1-9772-10-89.....	217	3-422-6-322.....	205
1-7712-10-195.....	15, 366	1-9773-12-322	218	3-422-6-44.....	205
1-7716-6-195	16	1-9773-12-89	217	3-422-6-89.....	205
1-7718-8-195	16	1-990-8-41	356	3-422-6-SN.....	205
1-7750-4-322.....	34	1-9945-5-143.....	54	3-4390-5-47	349
1-7751-5-322.....	34	24-FD-1698-143	254	3-4390-5-50.....	349
1-7752-6-322.....	34	24-FD-2008-171.....	64	3-4391-6-47	349
1-7804-5-142.....	264	24-FD-2008-89	64	3-4391-6-50.....	349
1-7804-5-143.....	262	26-FD-7806-142	266	3-4901-4-322.....	492
1-8003-6-127	157	26-FD-7806-143	266	3-4901-4-89.....	492
1-8004-5-127.....	159	27-FD-8201-109.....	74	3-6599-5-171.....	483
1-8005-2-127.....	159	27-FD-8201-322.....	74	3-6599-5-89.....	483
1-8042-6-79	269	27-FD-8201-89.....	74	3-6612-4-322.....	491
1-8070-8-51.....	271	28-FD-690-322.....	48	3-6612-4-89	491
1-8124-8-26	135	3-1617-4-11.....	478	3-6612-4-SN.....	491
1-8200-5-109.....	71	3-1617-4-322.....	478	3-6802-6-127.....	481
1-8200-5-322	71	3-1617-4-89.....	478	3-6802-6-188	481
1-8200-5-89	71	3-1773-6-320	323	3-6821-4-13	501

INDEX

3-7388-6-83	488	5-145-BK	715	5-341-213	730
3-7388-6-89	488	5-146-13	717	5-344-213	730
3-7388-6-322	488	5-146-BK	715	5-3451-BK	720
3-7388-6-SN	488	5-147-13	717	5-3452-BK	720
3-7700-3-322	494	5-147-BK	715	5-3453-BK	720
3-7700-3-89	494	5-179-137	734	5-3454-BK	720
3-7700-3-SN	494	5-1985-BK	689	5-3455-BK	720
3-7701-5-322	494	5-1986-BK	689	5-352-BK	711
3-7701-5-89	494	5-1989-BK	688	5-353-BK	711
3-7701-5-SN	494	5-1990-BK	688	5-354-BK	711
3-8072-4-51	271	5-2020-BK	705	5-355-BK	711
3-8811-6-92	347	5-2021-BK	705	5-356-BK	711
3-9950-4-322	487	5-2022-BK	705	5-357-BK	711
3-9950-4-89	487	5-2023-BK	705	5-369-10-BK	737
5-0629-BK	736	5-2024-BK	705	5-369-13-BK	737
5-0630-BK	736	5-2025-BK	705	5-450-BK	718
5-0631-BK	736	5-2066-51	699	5-451-BK	718
5-0633-BK	736	5-2066-72	737	5-452-BK	718
5-0634-BK	736	5-2067-51	699	5-453-BK	718
5-0635-BK	736	5-2068-51	699	5-454-BK	718
5-100-BK	702	5-254-13	727	5-472-144	687
5-101-BK	702	5-254-25	724	5-473-144	687
5-102-BK	702	5-255-13	727	5-474-144	687
5-104-BK	702	5-256-13	727	5-475-144	687
5-105-BK	702	5-256-25	724	5-476-144	687
5-1161-BK	737	5-257-13	727	5-546-13	708
5-1161-RP	737	5-258-13	727	5-547-13	708
5-1220-40	728	5-258-25	724	5-548-13	708
5-1221-40	729	5-259-13	727	5-549-13	708
5-1222-40	728	5-259-25	724	5-5630-DS-13	735
5-1223-40	728	5-275-144	697	5-5631-DS-13	735
5-1224-40	729	5-276-144	697	5-5910-BK	733
5-140-13	717	5-277-144	697	5-5911-BK	733
5-140-BK	715	5-278-144	697	5-633-BK	707
5-141-13	717	5-279-144	697	5-634-BK	707
5-141-BK	715	5-3045-72	737	5-635-BK	707
5-142-13	717	5-3045-BK	737	5-636-BK	707
5-142-BK	715	5-340-213	730	5-637-BK	707

INDEX

5-638-BK.....	707	5-905-BK.....	690	6-328-4-89.....	207
5-705-BK.....	701	5-9584-BK.....	735	6-328-4-SN.....	207
5-706-BK.....	701	6-1024-3-322.....	676	6-3350-14-109.....	674
5-707-BK.....	701	6-1024-3-89.....	676	6-3350-14-13.....	674
5-708-BK.....	701	6-1024-3-SN.....	676	6-3350-14-322.....	674
5-709-BK.....	701	6-1043-3-109.....	498, 676	6-3350-14-SN.....	674
5-714-143.....	695	6-1043-3-13.....	498, 676	6-3350-16-109.....	674
5-715-143.....	695	6-1043-3-BK.....	498	6-3350-16-13.....	674
5-716-143.....	695	6-1043-3-SN.....	499, 676	6-3350-16-322.....	674
5-717-143.....	695	6-1067-4-10.....	342	6-3350-16-SN.....	674
5-718-143.....	695	6-1272-4-50.....	115	6-3750-1-322.....	428, 677
5-719-143.....	695	6-133-16-322.....	675	6-3750-1-89.....	428, 677
5-720-153.....	712	6-133-16-44.....	675	6-4035-3-11.....	679
5-721-153.....	712	6-134-3-322.....	675	6-4035-3-13.....	679
5-722-153.....	712	6-134-3-44.....	675	6-4035-3-322.....	679
5-723-153.....	712	6-1662-4-322.....	29	6-4035-3-BK.....	679
5-724-153.....	712	6-1679-5-322.....	661	6-4035-3-SN.....	679
5-763-BK.....	693	6-1679-5-89.....	661	6-4037-1-BK.....	678
5-764-BK.....	693	6-1679-5-SN.....	661	6-4198-3-171.....	334
5-765-BK.....	693	6-1682-5-320.....	324	6-4198-3-83.....	335
5-766-BK.....	693	6-1685-1-142.....	667	6-4602-1-142.....	416
5-768-BK.....	693	6-1685-1-143.....	667	6-4602-1-143.....	416
5-769-BK.....	693	6-1695-4-143.....	253, 670	6-4900-4-322.....	492, 680
5-812-BK.....	723	6-1802-3-322.....	673	6-4900-4-89.....	492, 680
5-813-BK.....	723	6-1802-3-89.....	673	6-4900-4-SN.....	680
5-814-BK.....	723	6-1802-3-SN.....	673	6-5218-1-322.....	659
5-815-BK.....	723	6-1822-4-143.....	670	6-5218-1-89.....	659
5-816-BK.....	723	6-1950-6-322.....	665	6-6684-4-127.....	87
5-817-BK.....	723	6-1950-6-89.....	665	6-7003-8-109.....	669
5-825-BK.....	685	6-1951-6-322.....	665	6-7003-8-322.....	669
5-826-BK.....	685	6-1953-4-109.....	662	6-7003-8-77.....	669
5-827-BK.....	685	6-1953-4-322.....	662	6-7003-8-89.....	669
5-828-BK.....	685	6-1953-4-89.....	662	6-7200-1-322.....	473, 677
5-829-BK.....	685	6-1981-1-143.....	670	6-7200-1-89.....	473, 677
5-901-BK.....	690	6-3042-4-13.....	69, 671	6-7200-1-SN.....	473, 677
5-902-BK.....	690	6-328-4-109.....	207	6-7702-3-322.....	494, 681
5-903-BK.....	690	6-328-4-322.....	207	6-7702-3-89.....	494, 681
5-904-BK.....	690	6-328-4-44.....	207	6-7702-3-SN.....	494, 681

INDEX

6-7790-3-322.....	678	7-1041-6-SN.....	497	7-1804-4-89.....	459
6-7790-3-89.....	678	7-1066-6-10.....	342	7-1804-4-SN.....	459
6-780-11-13.....	683	7-1271-6-50.....	115	7-182-3-171.....	308
6-780-11-322.....	683	7-130-1-44.....	431	7-1825-5-320.....	320
6-780-11-BK.....	683	7-130-1-63.....	431	7-1831-1-322.....	292, 465
6-780-11-SN.....	683	7-130-1-SN.....	431	7-1831-1-89.....	294, 465
6-780-13-13.....	683	7-1398-3-14.....	399	7-1836-4-322.....	350
6-780-13-322.....	683	7-1399-5-14.....	399	7-1837-3-322.....	350
6-780-13-BK.....	683	7-1429-1-89.....	315	7-1850-8-89.....	66
6-780-13-SN.....	683	7-1610-6-322.....	97	7-1851-12-89.....	66
6-7900-4-261.....	657	7-1610-6-89.....	97	7-1872-3-322.....	411
6-7900-4-83.....	657	7-1620-43-322.....	79	7-1875-3-13.....	435
6-8074-15-13.....	671, 736	7-1621-53-322.....	79	7-1875-3-322.....	435
6-8074-15-SN.....	671, 736	7-1622-117-322.....	76, 374	7-1875-3-89.....	435
6-8602-1-322.....	306	7-1639-6-144.....	249	7-188-6-143.....	413
6-9353-3-46.....	339	7-1640-8-144.....	249	7-188-6-172.....	413
7-100-3-54.....	401	7-1643-1-143.....	477	7-1920-3-261.....	410
7-101-6-54.....	401	7-1656-3-128.....	319	7-1927-6-143.....	411
7-1010-1-SN.....	475	7-1657-3-89.....	319	7-1937-8-143.....	60
7-1011-1-109.....	445	7-1660-6-322.....	29	7-1947-8-260.....	101
7-1011-1-322.....	445	7-1690-1-142.....	415	7-1956-16-37.....	397
7-1011-1-89.....	445	7-1690-1-143.....	415	7-1957-12-37.....	397
7-1025-3-322.....	225	7-1696-5-143.....	253	7-1983-1-143.....	247
7-1025-3-89.....	223	7-1699-3-143.....	253	7-200-3-322.....	455
7-1025-3-SN.....	224	7-1732-10-322.....	26	7-2004-8-171.....	62
7-1026-1-322.....	471	7-1739-4-320.....	325	7-2004-8-89.....	62
7-1026-1-89.....	471	7-1742-1-109.....	464	7-2064-1-51.....	477
7-1026-1-SN.....	471	7-1742-1-322.....	464	7-2201-4-13.....	437
7-1027-1-322.....	471	7-1742-1-89.....	464	7-2201-4-322.....	437
7-1027-1-89.....	471	7-1774-6-320.....	323	7-2201-4-SN.....	437
7-1027-1-SN.....	471	7-180-1-109.....	451	7-2224-5-322.....	95
7-1040-3-109.....	498	7-180-1-322.....	451	7-2224-5-89.....	95
7-1040-3-13.....	498	7-180-1-89.....	451	7-2244-6-10.....	345
7-1040-3-BK.....	499	7-180-1-SN.....	451	7-2255-1-322.....	456
7-1040-3-SN.....	499	7-1803-3-322.....	459	7-2255-1-89.....	456
7-1041-6-109.....	497	7-1803-3-89.....	459	7-2265-1-322.....	457
7-1041-6-13.....	497	7-1803-3-SN.....	459	7-2265-1-89.....	457
7-1041-6-BK.....	497	7-1804-4-322.....	459	7-2303-4-260.....	42

INDEX

7-231-1-109.....	424	7-4034-3-SN.....	229	7-6407-3-322.....	449
7-231-1-322.....	424	7-4036-1-11.....	467	7-6407-3-89.....	449
7-231-1-323.....	424	7-4036-1-13.....	467	7-6427-1-322.....	315
7-231-1-89.....	424	7-4036-1-322.....	467	7-700-1-109.....	466
7-232-1-109.....	424	7-4036-1-BK.....	467	7-7006-1-322.....	461
7-232-1-322.....	424	7-4036-1-SN.....	467	7-7006-1-89.....	461
7-232-1-323.....	424	7-4134-1-13.....	475	7-7006-1-SN.....	461
7-232-1-89.....	424	7-4134-1-SN.....	475	7-701-1-SN.....	466
7-2351-12-11.....	121	7-4199-6-171.....	337	7-702-1-109.....	466
7-2416-3-143.....	415	7-4199-6-83.....	337	7-702-1-13.....	466
7-2416-3-160.....	415	7-4366-4-322.....	11	7-703-1-SN.....	466
7-2521-4-322.....	238	7-4368-6-322.....	11	7-7201-1-322.....	473
7-2521-4-89.....	238	7-4499-1-109.....	426	7-7201-1-89.....	473
7-2902-1-263.....	453	7-4499-1-322.....	426	7-7201-1-SN.....	473
7-2902-1-264.....	453	7-4499-1-89.....	426	7-730-1-109.....	431
7-3040-6-13.....	69	7-4600-1-142.....	416	7-7406-5-39.....	356
7-3075-1-11.....	453	7-4600-1-143.....	416	7-7639-1-11.....	421
7-3075-1-322.....	453	7-4618-6-83.....	333	7-7639-1-322.....	421
7-3075-1-89.....	453	7-487-4-53.....	403	7-7639-1-83.....	421
7-3100-1-322.....	455	7-487-4-54.....	403	7-7639-1-89.....	421
7-3102-1-322.....	455	7-488-6-53.....	403	7-7681-1-83.....	333
7-3168-3-322.....	47, 438	7-488-6-54.....	403	7-7714-4-195.....	15
7-3171-1-322.....	146	7-5012-1-109.....	454	7-7772-6-180.....	316
7-3362-6-322.....	51	7-5012-1-13.....	454	7-7800-8-142.....	264
7-3390-1-322.....	475	7-5014-3-84.....	405	7-7800-8-143.....	262
7-3390-1-89.....	475	7-5014-3-85.....	405	7-7802-4-142.....	264
7-3398-1-322.....	438	7-5106-5-177.....	311	7-7802-4-143.....	262
7-3751-1-322.....	429	7-5532-4-143.....	282	7-8001-1-127.....	159
7-3751-1-89.....	429	7-6025-3-322.....	442	7-8041-5-79.....	269
7-3751-1-SN.....	429	7-6025-3-89.....	442	7-8604-1-322.....	306
7-3901-3-109.....	446	7-6025-3-SN.....	442	7-8700-4-322.....	89
7-3901-3-322.....	446	7-6099-24-109.....	290	7-8701-6-322.....	89
7-3901-3-89.....	446	7-6099-24-322.....	290	7-8801-3-109.....	422
7-4001-6-31.....	123	7-6099-24-89.....	290	7-8801-3-322.....	422
7-4034-3-11.....	229	7-6192-4-171.....	313	7-8801-3-89.....	422
7-4034-3-13.....	229	7-6192-4-89.....	313	7-8810-6-92.....	347
7-4034-3-322.....	229	7-6304-4-322.....	433	7-8840-1-322.....	441
7-4034-3-BK.....	229	7-6304-4-89.....	433	7-8840-1-89.....	441

INDEX

7-8840-1-SN.....	441	8-1007-2-SN.....	654	8-1745-2-BK.....	609
7-885-1-182.....	406	8-1007-3-SN.....	654	8-1745-3-109.....	609
7-885-1-183.....	406	8-1007-4-SN.....	654	8-1745-3-322.....	609
7-886-3-182.....	406	8-1020-2-322.....	611	8-1745-3-BK.....	609
7-886-3-183.....	406	8-1020-2-BK.....	611	8-1745-4-109.....	609
7-8882-1-173.....	419	8-1020-2-SN.....	611	8-1745-4-322.....	609
7-8882-1-174.....	419	8-1020-3-322.....	611	8-1745-4-BK.....	609
7-8882-1-175.....	419	8-1020-3-BK.....	611	8-1780-2-111.....	649
7-8893-4-101.....	359	8-1020-3-SN.....	611	8-1780-2-79.....	649
7-9006-3-13.....	463	8-1020-4-322.....	611	8-1780-3-111.....	649
7-9006-3-322.....	463	8-1020-4-BK.....	611	8-1780-3-79.....	649
7-9006-3-89.....	463	8-1020-4-SN.....	611	8-1830-2-322.....	621
7-9006-3-SN.....	463	8-1102-2-143.....	607	8-1830-2-BK.....	621
7-9008-4-28.....	409	8-1102-2-146.....	607	8-1830-3-322.....	621
7-9009-5-28.....	409	8-1102-3-143.....	607	8-1830-3-BK.....	621
7-9012-6-58.....	131	8-1102-3-146.....	607	8-1830-4-322.....	621
7-9044-3-322.....	93	8-1102-4-143.....	607	8-1830-4-BK.....	621
7-9044-3-89.....	93	8-1102-4-146.....	607	8-1860-2-322.....	636
7-9046-4-322.....	93	8-1255-2-165.....	651	8-1860-2-BK.....	636
7-9046-4-89.....	93	8-1255-3-165.....	651	8-1860-3-322.....	636
7-9048-6-322.....	91	8-1255-4-165.....	651	8-1860-3-BK.....	636
7-9048-6-89.....	91	8-1627-2-11.....	581	8-1860-4-322.....	636
7-9063-1-95.....	474	8-1627-2-322.....	581	8-1860-4-BK.....	636
7-9064-1-95.....	474	8-1627-2-BK.....	581	8-1972-2-322.....	638
7-9132-1-109.....	468	8-1627-3-11.....	581	8-1972-3-322.....	638
7-9132-1-13.....	468	8-1627-3-322.....	581	8-1972-4-322.....	638
7-9132-1-322.....	468	8-1627-3-BK.....	581	8-1977-2-143.....	570
7-9132-1-89.....	468	8-1627-4-11.....	581	8-1977-3-143.....	570
7-9132-1-SN.....	468	8-1627-4-322.....	581	8-1977-4-143.....	570
7-9350-6-46.....	339	8-1627-4-BK.....	581	8-2069-2-51.....	648
7-9351-8-46.....	339	8-1638-3-143.....	569	8-2069-3-51.....	648
7-9352-10-46.....	341	8-1638-4-143.....	569	8-2069-4-51.....	648
7-9602-1-171.....	257	8-1638-5-143.....	569	8-2148-2-109.....	642
7-9602-1-89.....	258	8-1720-2-143.....	591	8-2148-3-109.....	642
7-9703-2-322.....	438	8-1720-3-143.....	591	8-2148-4-109.....	642
7-9770-1-322.....	218	8-1720-4-143.....	591	8-2149-2-11.....	643
7-9770-1-89.....	217	8-1745-2-109.....	609	8-2149-3-11.....	643
7-9906-8-171.....	311	8-1745-2-322.....	609	8-2149-4-11.....	643

INDEX

8-2154-2-67.....	641	8-3981-3-322.....	596	8-4128-3-322.....	573
8-2154-3-67.....	641	8-3981-3-BK.....	597	8-4128-3-BK.....	572
8-2154-4-67.....	641	8-3981-4-11.....	597	8-4128-3-SN.....	573
8-2542-2-109.....	587	8-3981-4-322.....	596	8-4128-4-322.....	573
8-2542-2-322.....	586	8-3981-4-BK.....	597	8-4128-4-BK.....	572
8-2542-2-89.....	587	8-4030-2-11.....	627	8-4128-4-SN.....	573
8-2542-3-109.....	587	8-4030-2-13.....	628	8-4300-2-BK.....	635
8-2542-3-322.....	586	8-4030-2-322.....	628	8-4300-2-SN.....	635
8-2542-3-89.....	587	8-4030-2-BK.....	627	8-4300-3-BK.....	635
8-2603-4-BK.....	619	8-4030-2-SN.....	629	8-4300-3-SN.....	635
8-2603-4-CH.....	619	8-4030-3-11.....	627	8-4300-4-BK.....	635
8-2603-6-BK.....	619	8-4030-3-13.....	628	8-4300-4-SN.....	635
8-2603-6-CH.....	619	8-4030-3-322.....	628	8-4417-2-322.....	589
8-3076-2-11.....	631	8-4030-3-BK.....	627	8-4417-3-322.....	589
8-3076-2-322.....	631	8-4030-3-SN.....	629	8-4417-4-322.....	589
8-3076-2-BK.....	631	8-4030-4-11.....	627	8-4508-2-SN.....	640
8-3076-3-11.....	631	8-4030-4-13.....	628	8-4508-3-SN.....	640
8-3076-3-322.....	631	8-4030-4-322.....	628	8-4508-4-SN.....	640
8-3076-3-BK.....	631	8-4030-4-BK.....	627	8-530-2-322.....	649
8-3076-4-11.....	631	8-4030-4-SN.....	629	8-530-4-322.....	649
8-3076-4-322.....	631	8-4050-2-322.....	633	8-560-2-11.....	624
8-3076-4-BK.....	631	8-4050-2-BK.....	633	8-560-2-BK.....	624
8-338-2-13.....	653	8-4050-2-SN.....	632	8-560-3-11.....	624
8-338-2-SN.....	653	8-4050-3-322.....	633	8-560-3-BK.....	624
8-338-3-13.....	653	8-4050-3-BK.....	633	8-560-4-11.....	624
8-338-3-SN.....	653	8-4050-3-SN.....	632	8-560-4-BK.....	624
8-338-4-13.....	653	8-4050-4-322.....	633	8-5606-2-BK.....	613
8-338-4-SN.....	653	8-4050-4-BK.....	633	8-5606-2-SN.....	613
8-3596-2-322.....	601	8-4050-4-SN.....	632	8-5606-3-BK.....	613
8-3596-3-322.....	601	8-4090-2-109.....	576	8-5606-3-SN.....	613
8-3596-4-322.....	601	8-4090-2-322.....	576	8-5606-4-BK.....	613
8-3600-2-322.....	593	8-4090-3-109.....	576	8-5606-4-SN.....	613
8-3600-3-322.....	593	8-4090-3-322.....	576	8-6001-2-109.....	603
8-3600-4-322.....	593	8-4090-4-109.....	576	8-6001-2-322.....	603
8-3981-2-11.....	597	8-4090-4-322.....	576	8-6001-2-BK.....	603
8-3981-2-322.....	596	8-4128-2-322.....	573	8-6001-3-109.....	603
8-3981-2-BK.....	597	8-4128-2-BK.....	572	8-6001-3-322.....	603
8-3981-3-11.....	597	8-4128-2-SN.....	573	8-6001-3-BK.....	603

INDEX

8-6001-4-109.....	603	8-7045-4-SN.....	623	8-9127-2-SN.....	655
8-6001-4-322.....	602	8-7205-2-BK.....	647	8-9127-3-SN.....	655
8-6001-4-BK.....	603	8-7205-2-SN.....	647	8-9130-2-109.....	616
8-6080-2-143.....	567	8-7205-3-BK.....	647	8-9130-2-13.....	616
8-6080-3-143.....	567	8-7205-3-SN.....	647	8-9130-2-322.....	615
8-6080-4-143.....	567	8-7205-4-BK.....	647	8-9130-2-BK.....	615
8-6180-2-143.....	565	8-7205-4-SN.....	647	8-9130-3-109.....	616
8-6180-3-143.....	565	8-7710-2-322.....	575	8-9130-3-13.....	616
8-6180-4-143.....	565	8-7710-2-BK.....	575	8-9130-3-322.....	615
8-6601-2-11.....	605	8-7710-2-SN.....	575	8-9130-3-BK.....	615
8-6601-2-BK.....	605	8-7710-3-322.....	575	8-9130-4-109.....	616
8-6601-3-11.....	605	8-7710-3-BK.....	575	8-9130-4-13.....	616
8-6601-3-BK.....	605	8-7710-3-SN.....	575	8-9130-4-322.....	615
8-6601-4-11.....	605	8-7710-4-322.....	575	8-9130-4-BK.....	615
8-6601-4-BK.....	605	8-7710-4-BK.....	575	8-9702-4-322.....	599
8-6836-2-11.....	585	8-7710-4-SN.....	575	8-9702-6-322.....	599
8-6836-2-13.....	584	8-8020-2-11.....	645	8-9702-8-322.....	599
8-6836-2-322.....	582	8-8020-2-BK.....	645	8-993-3-41.....	650
8-6836-2-SN.....	583	8-8020-3-11.....	645	8-993-4-41.....	650
8-6836-3-11.....	585	8-8020-3-BK.....	645	8-993-6-41.....	650
8-6836-3-13.....	584	8-8020-4-11.....	645	9-0159-2-76.....	560
8-6836-3-322.....	582	8-8020-4-BK.....	645	9-0700-1-109.....	533
8-6836-3-SN.....	583	8-8204-2-109.....	594	9-0700-1-322.....	533
8-6836-4-11.....	585	8-8204-2-322.....	595	9-0700-1-SN.....	533
8-6836-4-13.....	584	8-8204-2-BK.....	595	9-0900CP-1-109.....	549
8-6836-4-322.....	582	8-8204-3-109.....	594	9-0900CP-1-13.....	549
8-6836-4-SN.....	583	8-8204-3-322.....	595	9-0900CP-1-322.....	549
8-6837-2-69.....	654	8-8204-3-BK.....	595	9-0900CP-1-89.....	549
8-6837-3-69.....	654	8-8204-4-109.....	594	9-0900CP-1-SN.....	549
8-6837-4-69.....	654	8-8204-4-322.....	595	9-0901-1-109.....	546
8-6901-2-322.....	579	8-8204-4-BK.....	595	9-0901-1-322.....	546
8-6901-3-322.....	579	8-880-2-109.....	639	9-0901-1-44.....	546
8-6901-4-322.....	579	8-880-3-109.....	639	9-0901-1-89.....	546
8-7045-2-BK.....	623	8-880-4-109.....	639	9-0901-1-SN.....	546
8-7045-2-SN.....	623	8-890-2-SN.....	655	9-0902-1-109.....	530
8-7045-3-BK.....	623	8-890-3-SN.....	655	9-0902-1-322.....	530
8-7045-3-SN.....	623	8-890-4-SN.....	655	9-0902-1-89.....	530
8-7045-4-BK.....	623	8-9127-1-SN.....	563, 655	9-100-1-109.....	523

INDEX

9-100-1-44.....	523	9-1801-1-SN.....	525	9-2866-2-89.....	511
9-1007-1-SN.....	562, 654	9-1826-1-320.....	324	9-2901-2-263.....	527
9-101-1-109.....	541	9-183-2-171.....	308, 556	9-2901-2-264.....	527
9-101-1-322.....	541	9-1830-1-322.....	621	9-302-1-109.....	545
9-101-1-89.....	540	9-1830-1-89.....	621	9-302-1-322.....	544
9-101-1-SN.....	540	9-1888-1-143.....	559	9-302-1-44.....	544
9-103-2-109.....	541	9-1902-1-13.....	529	9-302-1-89.....	543
9-103-2-322.....	540	9-1902-1-322.....	529	9-302-1-SN.....	543
9-103-2-89.....	541	9-1905-2-143.....	244, 559	9-303-1-109.....	545
9-103-2-SN.....	540	9-1911-1-11.....	515	9-303-1-322.....	544
9-1068-1-10.....	342	9-1911-1-322.....	515	9-303-1-44.....	544
9-108-1-322.....	552	9-1911-1-89.....	515	9-303-1-89.....	543
9-108-1-89.....	552	9-1914-1-322.....	514	9-303-1-SN.....	543
9-108-1-SN.....	552	9-1914-1-89.....	514	9-3045-1-13.....	69
9-1102-1-143.....	607	9-1935-2-143.....	60, 555	9-3076-1-11.....	630
9-1102-1-146.....	607	9-1940-2-89.....	117, 557	9-3076-1-322.....	630
9-1200-1-109.....	535	9-1964-3-18.....	105	9-3076-1-89.....	630
9-1200-1-322.....	535	9-1968-1-11.....	517	9-3164-2-322.....	47, 558
9-1200-1-89.....	535	9-1968-1-322.....	517	9-3172-1-322.....	146, 555
9-1200-1-SN.....	535	9-1968-1-89.....	517	9-3305-2-109.....	503
9-16000-1-109.....	520	9-1972-1-322.....	562, 638	9-3305-2-322.....	503
9-16000-1-322.....	520	9-1977-1-143.....	558, 570	9-3305-2-89.....	503
9-16000-1-44.....	520	9-2006-1-171.....	62, 527	9-337-1-13.....	562, 653
9-1615-1-322.....	235	9-2006-1-89.....	62, 527	9-337-1-SN.....	562, 653
9-1615-1-89.....	235	9-2030-2-260.....	556	9-3506-3-322.....	143, 554
9-1632-1-143.....	528	9-2065-1-51.....	558	9-3981-1-11.....	597
9-1638-1-143.....	559, 569	9-2104-1-322.....	23, 557	9-3981-1-322.....	596
9-1645-1-143.....	528	9-2134-2-67.....	297, 522	9-3981-1-BK.....	597
9-1648-1-89.....	560	9-2204-2-322.....	39, 556	9-400-1-11.....	537
9-1649-1-89.....	560	9-2302-1-260.....	556	9-400-1-121.....	537
9-1686-1-142.....	547	9-2509-1-322.....	149, 555	9-4030-1-11.....	563, 627
9-1686-1-143.....	547	9-2542-1-109.....	532, 587	9-4030-1-13.....	563, 628
9-1697-1-143.....	253, 558	9-2542-1-322.....	532, 586	9-4030-1-322.....	563, 628
9-1755-1-109.....	534	9-2542-1-89.....	532, 587	9-4030-1-BK.....	563, 627
9-1755-1-322.....	534	9-2704-2-322.....	20, 554	9-4030-1-SN.....	563, 629
9-1755-1-89.....	534	9-2801-1-322.....	242	9-4044-2-322.....	161
9-1801-1-322.....	525	9-2801-1-89.....	241	9-4044-2-83.....	162
9-1801-1-89.....	525	9-2866-2-322.....	511	9-4044-2-89.....	163

INDEX

9-4050-1-322.....	563, 633	9-6836-1-11.....	562, 585	9-9131CP-1-109.....	551
9-4050-1-BK.....	563, 633	9-6836-1-13.....	562, 584	9-9131CP-1-13.....	551
9-4050-1-SN.....	563, 632	9-6836-1-322.....	562, 582	9-9131CP-1-322.....	551
9-4128-1-322.....	573	9-6836-1-SN.....	562, 583	9-9131CP-1-89.....	551
9-4128-1-BK.....	572	9-7005-1-322.....	524	9-9131CP-1-SN.....	551
9-4128-1-SN.....	573	9-7005-1-89.....	524	9-9157-1-51.....	559
9-4364-1-322.....	11, 556	9-7005-1-SN.....	524	9-960-1-13.....	550
9-4408-1-188.....	509	9-7140-1-322.....	531	9-960-1-322.....	550
9-4408-1-322.....	509	9-7140-1-SN.....	531	9-960-1-89.....	550
9-4417-1-322.....	40, 589	9-7144-1-109.....	545	9-9603-2-171.....	257, 526
9-4928-2-322.....	512	9-7144-1-322.....	544	9-9603-2-89.....	258, 526
9-4928-2-89.....	512	9-7144-1-44.....	544	9-961CP-1-109.....	548
9-5005-1-79.....	558	9-7144-1-89.....	543	9-961CP-1-13.....	548
9-5201-1-322.....	539	9-7144-1-SN.....	543	9-961CP-1-322.....	548
9-5201-1-83.....	539	9-7193-1-11.....	513	9-961CP-1-89.....	548
9-5201-1-89.....	539	9-7193-1-322.....	513	9-961CP-1-SN.....	548
9-5202-2-322.....	539	9-7193-1-89.....	513	9-9702-2-322.....	556, 599
9-5202-2-83.....	539	9-7506-1-127.....	153, 555	9-9771-2-322.....	218
9-5202-2-89.....	539	9-8002CP-1-127.....	157	9-9771-2-89.....	217
9-5405-1-322.....	303	9-8006CP-1-127.....	157	9-9944-1-143.....	54, 557
9-5405-1-89.....	304	9-8073-2-51.....	271, 559	9-996-1-109.....	518
9-5531-2-143.....	282, 557	9-8204-1-109.....	594	9-996-1-322.....	518
9-6001-1-109.....	602	9-8204-1-322.....	595	9-996-1-89.....	518
9-6001-1-322.....	602	9-8204-1-BK.....	595	9-996-1-SN.....	518
9-6001-1-89.....	602	9-8257-2-322.....	516	9-998-2-109.....	506
9-6054-1-13.....	522	9-8257-2-89.....	516	9-998-2-322.....	506
9-6074-1-90.....	735	9-8606-2-322.....	306, 555	9-998-2-44.....	506
9-6080-1-143.....	567	9-880-1-109.....	639	9-998-2-89.....	506
9-6180-1-143.....	565	9-8812-2-92.....	347	9-998-2-SN.....	506
9-6506-1-127.....	154, 555	9-8884-1-173.....	547		
9-6512-1-322.....	511	9-8884-1-174.....	547		
9-6520-1-109.....	505	9-8884-1-175.....	547		
9-6520-1-322.....	505	9-900-1-109.....	521		
9-6520-1-89.....	505	9-900-1-322.....	521		
9-6608-1-188.....	508	9-900-1-44.....	521		
9-6608-1-322.....	508	9-9004-1-88.....	560		
9-6624-1-89.....	119, 557	9-9004-2-88.....	560		
9-6696-2-143.....	559	9-9065-1-95.....	558		







3130 North Berkeley Lake Road NW | Duluth, GA 30096

TEL 800 801 1621 TEL 404 890 7540

SAVOYHOUSE.COM

MLXVI