



SAVOY HOUSE



MASTER FAN CATALOGUE
JUNE 2021





SAVOY HOUSE FANS



At Savoy House, we take pride in our vast selection of stylish, fashionable and powerful ceiling fans.



We offer you a wide variety of design-driven ceiling fan styles that are high-performance and energy-efficient, keeping you comfortable and reducing your energy costs. Whether you adore elegant traditional looks or prefer something a bit more cutting-edge contemporary, Savoy House has a ceiling fan just for you. We look forward to helping you find your new favorite fan.



SAVOY HOUSE FANS

TABLE OF CONTENTS

COLLECTIONS

- 04 Farmhouse
- 06 Farmhouse II
- 08 Bluffton
- 10 Velocity
- 12 La Salle
- 14 Dayton
- 16 Buckenham
- 18 Alsace
- 20 Connell
- 22 Monfort
- 24 Hyannis II
- 26 Salon Wind Star
- 28 Wind Star
- 30 Kentwood
- 32 Pine Harbor
- 34 Mystique
- 36 Sierra Madres
- 38 First Value
- 42 Builder Specialty
- 44 Nomad
- 46 Lancer
- 48 Ceiling Fans
- 60 Meridian Fan D'lier®
- 64 Lyon Fan D'lier®
- 66 Oslo Fan D'lier®
- 68 Weatherby Fan D'lier®
- 70 Stockholm Fan D'lier®
- 72 Etesian Fan D'lier®
- 74 Brisa Fan D'lier®
- 76 Colonade Fan D'lier®
- 78 Alsace Fan D'lier®
- 80 Kona Fan D'lier®
- 82 Vireo Fan D'lier®
- 84 Taurus Fan D'lier®
- 86 Fan Light Options
- 90 Controls
- 91 Standard Downrods
- 92 Specifications
- 96 Index

ALPHABETICAL

- 18 Alsace
- 78 Alsace Fan D'lier®
- 08 Bluffton
- 74 Brisa Fan D'lier®
- 16 Buckenham
- 42 Builder Specialty
- 48 Ceiling Fans
- 76 Colonade Fan D'lier®
- 20 Connell
- 14 Dayton
- 72 Etesian Fan D'lier®
- 04 Farmhouse
- 06 Farmhouse II
- 38 First Value
- 24 Hyannis II
- 30 Kentwood
- 80 Kona Fan D'lier®
- 46 Lancer
- 12 La Salle
- 64 Lyon Fan D'lier®
- 60 Meridian Fan D'lier®
- 22 Monfort
- 34 Mystique
- 44 Nomad
- 66 Oslo Fan D'lier®
- 32 Pine Harbor
- 26 Salon Wind Star
- 36 Sierra Madres
- 70 Stockholm Fan D'lier®
- 84 Taurus Fan D'lier®
- 10 Velocity
- 82 Vireo Fan D'lier®
- 68 Wetherby Fan D'lier®
- 28 Wind Star



FARMHOUSE



*PICTURED WITHOUT COVER
INCLUDED FOR NON-LIGHT USE

ENERGY USE AT HIGH SPEED

Airflow Use	Electricity Use	Airflow Efficiency
6,251 Cu Ft/Min	30.28W Excludes Lights	206.42 Cu Ft/Min/W

Compare: 49" to 60" ceiling fans have airflow efficiencies ranging from approximately 51 to 176 cu. ft. per min per watt at high speed.



Handheld Remote
Control Included
RMT-DC-UNIVERSAL

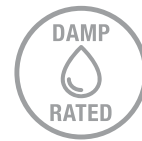

FARMHOUSE



60-760-12GR-187



60-760-12WO-168



60-760-12AO-89



FAN NUMBER	60-760-12GR-187	60-760-12WO-168	60-760-12AO-89
MOTOR FINISH	Brushed Pewter	Galvanized	Matte Black
BLADE FINISH	Grey Wood	Weathered Oak	Antique Oak
FAN LIGHT	Integrated/Cover	Integrated/Cover	Integrated/Cover
GLASS	White	White	White
DOWNROD FINISH	187	168	FB

- Motor Size DC 153 x 20
- 60" Blade Span
- 15° Blade Pitch
- 6-Speed Reversible Motor
- Fan Supplied With 8" Downrod
- Additional Downrod Lengths Sold Separately

- Fan Blades & Integrated Fan Light Included
- 17.5W LED Dimmable Module (1,450 Lumens, 3000K, 90 CRI)
- Cover For Non-Light Use Included
- Not Hugger Kit Adaptable
- Handheld Remote Included (RMT-DC-UNIVERSAL)

FARMHOUSE II



*PICTURED WITHOUT COVER
INCLUDED FOR NON-LIGHT USE

ENERGY USE AT HIGH SPEED

Airflow Use	Electricity Use	Airflow Efficiency
4,719	32.64W	144.59
Cu Ft/Min	Excludes Lights	Cu Ft/Min/W

Compare: 49" to 60" ceiling fans have airflow efficiencies ranging from approximately 51 to 176 cu. ft. per min per watt at high speed.



Handheld Remote
Control Included
RMT-DC-UNIVERSAL

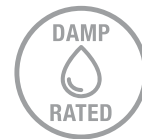

FARMHOUSE II



FAN NUMBER	44-770-6GR-187	44-770-6WO-168	44-770-6AO-89
MOTOR FINISH	Brushed Pewter	Galvanized	Matte Black
BLADE FINISH	Grey Wood	Weathered Oak	Antique Oak
FAN LIGHT	Integrated/Cover	Integrated/Cover	Integrated/Cover
GLASS	White	White	White
DOWNROD FINISH	187	168	FB

- Motor Size DC 153 x 10
- 44" Blade Span
- 15° Blade Pitch
- 6-Speed Reversible Motor
- Fan Supplied With 6" Downrod
- Additional Downrod Lengths Sold Separately
- Fan Blades & Integrated Fan Light Included
- 17.5W LED Dimmable Module (1,450 Lumens, 3000K, 90 CRI)
- Cover For Non-Light Use Included
- Not Hugger Kit Adaptable
- Handheld Remote Included (RMT-DC-UNIVERSAL)

BLUFFTON



ENERGY USE AT HIGH SPEED

Airflow Use	Electricity Use	Airflow Efficiency
9,744	32.89W	296.27
Cu Ft/Min	Excludes Lights	Cu Ft/Min/W

Compare: 49" to 60" ceiling fans have airflow efficiencies ranging from approximately 51 to 176 cu. ft. per min per watt at high speed.



Handheld Remote Control Included
RMT-DC-UNIVERSAL



BLUFFTON

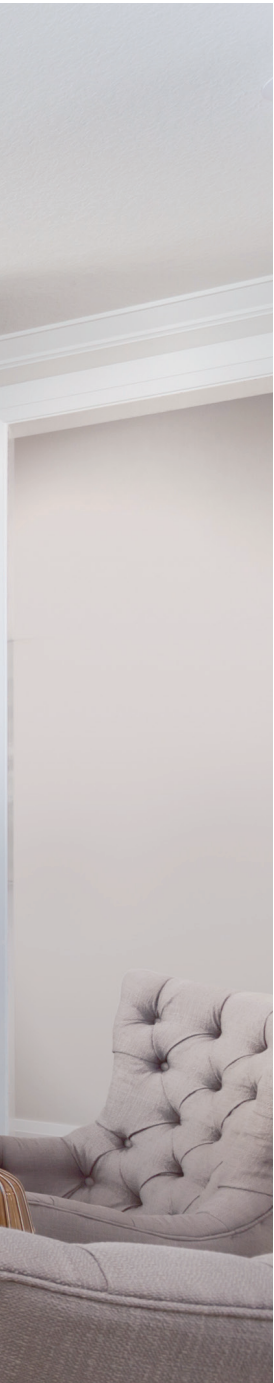

FAN NUMBER	72-5045-813-13	72-5045-8SV-SN	72-5045-8GR-GR	72-5045-889-89
MOTOR FINISH	English Bronze	Satin Nickel	Grey Wood	Matte Black
BLADE FINISH	English Bronze	Silver	Grey Wood	Matte Black
FAN LIGHT	Integrated	Integrated	Integrated	Integrated
GLASS	White Opal	White Opal	White Opal	White Opal
DOWNROD FINISH	13	SN	GR	FB

- Motor Size DC-165L
- 72" Blade Span
- 13° Blade Pitch
- 6-Speed Reversible Motor
- Additional Downrod Lengths Sold Separately
- ABS Blades & Integrated Fan Light Included
- 16W LED Dimmable Module (1,300 Lumens, 3000K, 80+ CRI)
- Not Hugger Kit Adaptable
- Handheld Remote Included (RMT-DC-UNIVERSAL)
- Fan & Blades are UL Wet Location

VELOCITY



*PICTURED WITHOUT COVER
INCLUDED FOR NON-LIGHT USE

VELOCITY



60-820-613-13



60-820-6SV-SN



FAN NUMBER	60-820-613-13	60-820-6SV-SN
MOTOR FINISH	English Bronze	Satin Nickel
BLADE FINISH	English Bronze	Silver
FAN LIGHT	Integrated/Cover	Integrated/Cover
GLASS	White Opal	White Opal
DOWNROD FINISH	13	SN

ENERGY USE AT HIGH SPEED		
Airflow Use	Electricity Use	Airflow Efficiency
8,175 Cu Ft/Min	93.63W Excludes Lights	87.31 Cu Ft/Min/W
Compare: 49" to 60" ceiling fans have airflow efficiencies ranging from approximately 51 to 176 cu. ft. per min per watt at high speed.		

- Motor Size 212 x 25
- 60" Blade Span
- 14° Blade Pitch
- 3-Speed Reversible Motor
- Additional Downrod Lengths Sold Separately
- Blades & Integrated Fan Light Included
- 2M 9W LED Dimmable Bulbs (810 Lumens per bulb, 3000K, 90 CRI)
- Cover For Non-Light Use Included
- Not Hugger Kit Adaptable
- Handheld Remote with B Receiver Included (RMT-AC-UNIVERSAL)
- Fan & Blades are UL/CUL Damp Location



Handheld Remote Control Included
RMT-AC-UNIVERSAL



LA SALLE



*PICTURED WITHOUT COVER
INCLUDED FOR NON-LIGHT USE

ENERGY USE AT HIGH SPEED

Airflow Use	Electricity Use	Airflow Efficiency
6,791 Cu Ft/Min	17.81W Excludes Lights	381.33 Cu Ft/Min/W

Compare: 49" to 60" ceiling fans have airflow efficiencies ranging from approximately 51 to 176 cu. ft. per min per watt at high speed.



Handheld Remote
Control Included
RMT-DC-UNIVERSAL



LA SALLE



60-5025-313-13



60-5025-3KO-SN



60-5025-3SV-SN



FAN NUMBER	60-5025-313-13	60-5025-3KO-SN	60-5025-3SV-SN
MOTOR FINISH	English Bronze	Satin Nickel	Satin Nickel
BLADE FINISH	English Bronze	KOA Wood	Silver
FAN LIGHT	Integrated/Cover	Integrated/Cover	Integrated/Cover
GLASS	White Frosted	White Frosted	White Frosted
DOWNROD FINISH	13	SN	SN

- Motor Size DC-165M
- 60" Blade Span
- 14° Blade Pitch
- 6-Speed DC Reversible Motor
- Additional Downrod Lengths Sold Separately

- ABS Blades & Integrated Fan Light Included
- 17W LED Dimmable Module (1,342 Lumens, 3000K, 90 CRI)
- Cover For Non-Light Use Included
- Not Hugger Kit Adaptable
- Handheld Remote Included (RMT-DC-UNIVERSAL)

DAYTON



*PICTURED WITHOUT COVER
INCLUDED FOR NON-LIGHT USE



52-6110-4RV-89



52-6110-4WH-WH



FAN NUMBER	52-6110-4RV-89	52-6110-4WH-WH
MOTOR FINISH	Matte Black	White
BLADE FINISH	Matte Black/Antique Oak	White
FAN LIGHT	Integrated/Cover	Integrated/Cover
GLASS	White Opal	White Opal
DOWNROD FINISH	FB	WH

- Motor Size 153 x 22
- 52" Blade Span
- 13.5° Blade Pitch
- 3-Speed Reversible Motor
- Additional Downrod Lengths Sold Separately
- Blades & Integrated Fan Light Included
- 17W LED Dimmable Module (1,350 Lumens, 3000K, 90 CRI)
- Not Hugger Kit Adaptable
- Handheld Remote with A Receiver Included (RMT-AC-UNIVERSAL)
- Cover For Non-Light Use Included

ENERGY USE AT HIGH SPEED

Airflow Use 4,665 Cu Ft/Min	Electricity Use 58.3W Excludes Lights	Airflow Efficiency 80.02 Cu Ft/Min/W
<small>Compare: 49" to 60" ceiling fans have airflow efficiencies ranging from approximately 51 to 176 cu. ft. per min per watt at high speed.</small>		



Handheld Remote
Control Included
RMT-AC-UNIVERSAL



BUCKENHAM



BUCKENHAM



- Motor Size DC-125
- 56" Blade Span
- 13° Blade Pitch
- 6-Speed Reversible Motor
- Additional Downrod Lengths Sold Separately
- Blades & Integrated Fan Light Included
- 18W LED Dimmable Module (1,500 Lumens, 3000K, 90 CRI)
- Not Hugger Kit Adaptable
- Handheld Remote Included (RMT-DC-UNIVERSAL)
- Fan & Blades are ETL Damp Location

FAN NUMBER	56-5075-5GWO-130
MOTOR FINISH	Aged Pewter
BLADE FINISH	Grey Weathered Oak
FAN LIGHT	Integrated
GLASS	White Frosted
DOWNROD FINISH	130

ENERGY USE AT HIGH SPEED		
Airflow Use	Electricity Use	Airflow Efficiency
6,032	31.86W	189.30
Cu Ft/Min	Excludes Lights	Cu Ft/Min/W

Compare: 49" to 60" ceiling fans have airflow efficiencies ranging from approximately 51 to 176 cu. ft. per min per watt at high speed.



Handheld Remote Control Included
RMT-DC-UNIVERSAL



ALSACE



ALSACE



- Motor Size 153 x 18
- 52" Blade Span
- 12° Blade Pitch
- 3-Speed Reversible Motor
- Additional Downrod Lengths Sold Separately
- Blades & Integrated Fan Light Included
- 3C 4W LED Dimmable Bulbs (300 Lumens per bulb, 2700K, 80+ CRI)
- Not Hugger Kit Adaptable
- Handheld Remote with A Receiver Included (RMT-AC-UNIVERSAL)
- Fan & Blades are UL/CUL Damp Location

FAN NUMBER	52-840-5CN-196
MOTOR FINISH	Reclaimed Wood
BLADE FINISH	Chestnut
FAN LIGHT	Integrated
DOWNROD FINISH	196

ENERGY USE AT HIGH SPEED		
Airflow Use	Electricity Use	Airflow Efficiency
4,983	61.33W	81.25
Cu Ft/Min	Excludes Lights	Cu Ft/Min/W
Compare: 49" to 60" ceiling fans have airflow efficiencies ranging from approximately 51 to 176 cu. ft. per min per watt at high speed.		



Handheld Remote Control Included
RMT-AC-UNIVERSAL



CONNELL



CONNELL



FAN NUMBER 56-578-5WA-13

MOTOR FINISH English Bronze

BLADE FINISH Walnut

FAN LIGHT Integrated

GLASS Clear Seeded

DOWNROD FINISH 13

ENERGY USE AT HIGH SPEED

Airflow Use	Electricity Use	Airflow Efficiency
5,696 Cu Ft/Min	36.8W Excludes Lights	80.69 Cu Ft/Min/W

Compare: 49" to 60" ceiling fans have airflow efficiencies ranging from approximately 51 to 176 cu. ft. per min per watt at high speed.

- Motor Size 188 x 22
- 56" Blade Span
- 13.5° Blade Pitch
- 3-Speed Reversible Motor
- Additional Downrod Lengths Sold Separately
- Blades & Integrated Fan Light Included
- 3M 8W LED Dimmable Bulbs (800 Lumens per bulb, 3000K, 80+ CRI)
- Not Hugger Kit Adaptable
- Handheld Remote with B Receiver Included (RMT-AC-UNIVERSAL)
- Fan & Blades are UL Damp Location



Handheld Remote
Control Included
RMT-AC-UNIVERSAL



MONFORT



FAN LIGHT OPTIONS PG 86-89

MONFORT



FAN NUMBER	62-5085-3WA-13	62-5085-3CN-109	62-5085-3SV-SN
MOTOR FINISH	English Bronze	Polished Chrome	Satin Nickel
BLADE FINISH	Walnut	Chestnut	Silver
FAN LIGHT	Optional	Optional	Optional
DOWNROD FINISH	13	109	SN

COMPATIBLE FAN LIGHTS: FLG-1200 Series, FLG-1400 Series, Ratcliffe Series

OPTIONAL REMOTE: RMT-AC-UNIVERSAL with C Receiver

- Motor Size 188 x 25
- 62" Blade Span
- 14° Blade Pitch
- 3-Speed Pull-Chain Reversible Motor
- Additional Downrod Lengths Sold Separately
- Optional Fan Light Sold Separately
- Not Hugger Kit Adaptable
- Fan & Blades are UL Damp Location

ENERGY USE AT HIGH SPEED		
Airflow Use 6,268 Cu Ft/Min	Electricity Use 86.26W Excludes Lights	Airflow Efficiency 72.66 Cu Ft/Min/W
Compare: 49" to 60" ceiling fans have airflow efficiencies ranging from approximately 51 to 176 cu. ft. per min per watt at high speed.		



HYANNIS II



ENERGY USE AT HIGH SPEED

Airflow Use	Electricity Use	Airflow Efficiency
5,093 Cu Ft/Min	67.34W Excludes Lights	75.63 Cu Ft/Min/W

Compare: 49" to 60" ceiling fans have airflow efficiencies ranging from approximately 51 to 176 cu. ft. per min per watt at high speed.



Handheld Remote Control Included
RMT-AC-UNIVERSAL



HYANNIS II



52-625-5AS-242



52-625-5CN-13



FAN NUMBER	52-625-5AS-242	52-625-5CN-13
MOTOR FINISH	Aged Steel	English Bronze
BLADE FINISH	Aged Steel	Chestnut
FAN LIGHT	Integrated	Integrated
GLASS	Indian Cream Scavo	Indian Cream Scavo
DOWNROD FINISH	242	13

- Motor Size 153 x 20
- 52" Blade Span
- 13.5° Blade Pitch
- 3-Speed Manual Reversible Motor
- Additional Downrod Lengths Sold Separately
- ABS Blades & Integrated Fan Light Included
- 2M 9W LED Dimmable Bulbs (810 Lumens per bulb, 3000K, 90 CRI)
- Not Hugger Kit Adaptable
- Handheld Remote with A Receiver Included (RMT-AC-UNIVERSAL)
- Fan & Blades are UL/CUL Wet Location

SALON WIND STAR



*PICTURED WITH FLG-1400-89 (OPTIONAL FAN LIGHT).
FAN LIGHT OPTIONS PG 86-89

ENERGY USE AT HIGH SPEED

Airflow Use	Electricity Use	Airflow Efficiency
7,390 Cu Ft/Min	97.14W Excludes Lights	76.08 Cu Ft/Min/W

Compare: 49" to 60" ceiling fans have airflow efficiencies ranging from approximately 51 to 176 cu. ft. per min per watt at high speed.



- Motor Size 212 x 25
- 68" Blade Span
- 16° Blade Pitch
- 3-Speed Pull-Chain Reversible Motor
- Optional Fan Light Sold Separately
- Additional Downrod Lengths Sold Separately
- Blades Included
- Not Hugger Kit adaptable

SALON WIND STAR



68-227-5RV-129



68-227-5RV-187



68-227-5RV-148



68-227-589-89



68-227-545-45

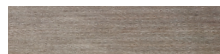

FAN NUMBER	68-227-5RV-129	68-227-5RV-187	68-227-5RV-148	68-227-589-89	68-227-545-45
MOTOR FINISH	Espresso	Brushed Pewter	Estate Brass	Matte Black	Aged Wood
BLADE FINISH	Walnut/Distressed	Chestnut/Grey Wood	Walnut/Matte Black	Matte Black	Aged Wood
FAN LIGHT	Optional	Optional	Optional	Optional	Optional
DOWNROD FINISH	129	187	148	FB	45

COMPATIBLE FAN LIGHTS: FLG-1200 Series, FLG-1400 Series, Ratcliffe Series

OPTIONAL REMOTE: RMT-AC-UNIVERSAL with C Receiver

WIND STAR



FAN LIGHT OPTIONS PG 86-89

ENERGY USE AT HIGH SPEED

Airflow Use	Electricity Use	Airflow Efficiency
4,623 Cu Ft/Min	61.14W Excludes Lights	75.62 Cu Ft/Min/W

Compare: 49" to 60" ceiling fans have airflow efficiencies ranging from approximately 51 to 176 cu. ft. per min per watt at high speed.



- Motor Size 172 x 14
- 52" Blade Span
- 13.5° Blade Pitch
- 3-Speed Pull-Chain Reversible Motor
- Additional Downrod Lengths Sold Separately
- Optional Fan Light Sold Separately
- Blades Included
- Dual Mounting System Included (Downrod & Hugger)

WIND STAR

52-830-589-89



52-830-5RV-148

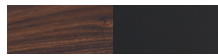

52-830-5RV-187



52-830-545-45



FAN NUMBER	52-830-589-89	52-830-5RV-148	52-830-5RV-187	52-830-545-45
MOTOR FINISH	Matte Black	Estate Brass	Brushed Pewter	Aged Wood
BLADE FINISH	Matte Black	Walnut/Matte Black	Chestnut/Grey Wood	Aged Wood
FAN LIGHT	Optional	Optional	Optional	Optional
DOWNROD FINISH	FB	148	187	45

COMPATIBLE FAN LIGHTS: FLG-1200 Series, FLG-1400 Series, Ratcliffe Series

COMPATIBLE REMOTE CONTROLS: RMT-AC-Universal with C Receiver

KENTWOOD



ENERGY USE AT HIGH SPEED

Airflow Use	Electricity Use	Airflow Efficiency
5,264	70.19W	75.01
Cu Ft/Min	Excludes Lights	Cu Ft/Min/W

Compare: 49" to 60" ceiling fans have airflow efficiencies ranging from approximately 51 to 176 cu. ft. per min per watt at high speed.



- Motor Size 172 x 17
- 52" Blade Span
- 12.5° Blade Pitch
- 3-Speed Pull-Chain Reversible Motor
- Additional Downrod Lengths Sold Separately
- Reversible Blades Included
- Optional Fan Light Sold Separately
- Dual Mounting System Included (Downrod & Hugger)
- Fan & Blades are UL Damp Location

KENTWOOD



52-5095-5RV-13

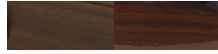

52-5095-5RV-109

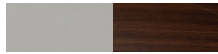

52-5095-5RV-SN

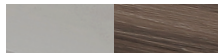

52-5095-5RV-WH

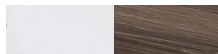

52-5095-545-45



FAN NUMBER	52-5095-5RV-13	52-5095-5RV-109	52-5095-5RV-SN	52-5095-5RV-WH	52-5095-545-45
MOTOR FINISH	English Bronze	Polished Nickel	Satin Nickel	White	Aged Wood
BLADE FINISH	Walnut/Chestnut	Silver/Chestnut	Silver/Grey Weathered Oak	White/Grey Weathered Oak	Aged Wood
FAN LIGHT	Optional	Optional	Optional	Optional	Optional
DOWNROD FINISH	13	109	SN	WH	45

COMPATIBLE FAN LIGHTS: FLG-1200 Series, FLG-1400 Series, Ratcliffe Series

OPTIONAL REMOTE: RMT-AC-UNIVERSAL with C Receiver

PINE HARBOR



FAN LIGHT OPTIONS PG 86-89

PINE HARBOR

52-SGC-5RV-13



52-SGC-5RV-SN



FAN NUMBER	52-SGC-5RV-13	52-SGC-5RV-SN
MOTOR FINISH	English Bronze	Satin Nickel
BLADE FINISH	Walnut/Teak	Maple/Chestnut
FAN LIGHT	Optional	Optional
DOWNROD FINISH	13	SN

COMPATIBLE FAN LIGHTS: Ratcliffe Series, FLC418 Series, FLG-1200 Series,

OPTIONAL REMOTE: RMT-AC-UNIVERSAL with D Receiver

- Motor Size 153 x 15
- 52" Blade Span
- 12° Blade Pitch
- 3-Speed Pull-Chain Reversible Motor
- Additional Downrod Lengths Sold Separately
- Optional Fan Light Sold Separately
- Reversible Color Fan Blades Included
- Dual Mounting System Included (Downrod & Hugger)

ENERGY USE AT HIGH SPEED

Airflow Use	Electricity Use	Airflow Efficiency
4,581	58.2W	78.72
Cu Ft/Min	Excludes Lights	Cu Ft/Min/W

Compare: 49" to 60" ceiling fans have airflow efficiencies ranging from approximately 51 to 176 cu. ft. per min per watt at high speed.



MYSTIQUE



MYSTIQUE



FAN NUMBER	52-831-5RV-13	52-831-5RV-SN	52-831-5RV-109	52-831-5RV-89
MOTOR FINISH	English Bronze	Satin Nickel	Polished Nickel	Matte Black
BLADE FINISH	Chestnut/Teak	Chestnut/Silver	Chestnut/Teak	Matte Black/Antique Oak
FAN LIGHT	Integrated	Integrated	Integrated	Integrated
GLASS	White Frosted	White Frosted	White Frosted	White Frosted
DOWNROD FINISH	13	SN	109	FB

OPTIONAL REMOTE: RMT-AC-UNIVERSAL with D Receiver

- Motor Size 153 x 17
- 52" Blade Span
- 12° Blade Pitch
- 3-Speed Pull-Chain Reversible Motor
- Additional Downrod Lengths Sold Separately
- Reversible Color Fan Blades & Integrated Fan Light Included
- 2M 9W LED Dimmable Bulbs (750 Lumens per bulb, 3000K, 80+ CRI)
- Dual Mounting System Included (Downrod & Hugger)
- Cover for Non-Light Use Included

ENERGY USE AT HIGH SPEED		
Airflow Use 4,609 Cu Ft/Min	Electricity Use 56.6W Excludes Lights	Airflow Efficiency 81.43 Cu Ft/Min/W
Compare: 49" to 60" ceiling fans have airflow efficiencies ranging from approximately 51 to 176 cu. ft. per min per watt at high speed.		



SIERRA MADRES



SIERRA MADRES



FAN NUMBER	52-CDC-5RV-SN
MOTOR FINISH	Satin Nickel
BLADE FINISH	White/Chestnut
FAN LIGHT	Integrated
GLASS	White Frosted
DOWNROD FINISH	SN

OPTIONAL REMOTE: RMT-AC-UNIVERSAL with D Receiver

- Motor Size 153 x 15
- 52" Blade Span
- 12° Blade Pitch
- 3-Speed Pull-Chain Reversible Motor
- Additional Downrod Lengths Sold Separately
- Reversible Color Fan Blades & Integrated Fan Light Included
- 1M 9W LED Dimmable Bulb (750 Lumens per bulb, 3000K, 80+ CRI)
- Dual Mounting System Included (Downrod & Hugger)
- Decorative Cover For Non-Light Use Included

ENERGY USE AT HIGH SPEED

Airflow Use	Electricity Use	Airflow Efficiency
4,543 Cu Ft/Min	62.49W Excludes Lights	72.71 Cu Ft/Min/W

Compare: 49" to 60" ceiling fans have airflow efficiencies ranging from approximately 51 to 176 cu. ft. per min per watt at high speed.



FIRST VALUE



ENERGY USE AT HIGH SPEED

Airflow Use	Electricity Use	Airflow Efficiency
5,4503 Cu Ft/Min	61W Excludes Lights	73.83 Cu Ft/Min/W

Compare: 49" to 60" ceiling fans have airflow efficiencies ranging from approximately 51 to 176 cu. ft. per min per watt at high speed.



- Motor Size 153 x 13
- 52" Blade Span
- 10.5° Blade Pitch
- 3-Speed Pull-Chain Reversible Motor
- Additional Downrod Lengths Sold Separately
- Reversible Color Fan Blades & Integrated Fan Light Included
- 2M 9W LED Bulbs (750 Lumens per bulb, 2700K, 80+ CRI)
- Dual Mounting System Included (Downrod & Hugger)

FIRST VALUE



52-ECM-5RV-13

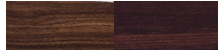

52-ECM-5RV-13WG



52-ECM-5RV-SN



52-ECM-5RV-WH



52-ECM-589-89



FAN NUMBER	52-ECM-5RV-13	52-ECM-5RV-13WG	52-ECM-5RV-SN	52-ECM-5RV-WH	52-ECM-589-89
MOTOR FINISH	English Bronze	English Bronze	Satin Nickel	White	Matte Black
BLADE FINISH	Walnut/Chestnut	Walnut/Chestnut	Chestnut/Grey Weathered Oak	White/Weathered Patina	Matte Black
FAN LIGHT	Integrated	Integrated	Integrated	Integrated	Integrated
GLASS	Cream	White	White	White	White
DOWNROD FINISH	13	13	SN	WH	FB

OPTIONAL REMOTE: RMT-AC-UNIVERSAL with D Receiver

FIRST VALUE



FAN LIGHT OPTIONS PG 86-89

ENERGY USE AT HIGH SPEED

Airflow Use 4,227 Cu Ft/Min	Electricity Use 60.48W Excludes Lights	Airflow Efficiency 69.89 Cu Ft/Min/W
-----------------------------------	--	--

Compare: 49" to 60" ceiling fans have airflow efficiencies ranging from approximately 51 to 176 cu. ft. per min per watt at high speed.



FIRST VALUE



52-EUP-5RV-13WG



52-EUP-5RV-SN



FAN NUMBER	52-EUP-5RV-13WG	52-EUP-5RV-SN
MOTOR FINISH	English Bronze	Satin Nickel
BLADE FINISH	Walnut/Chestnut	Chestnut/Grey Weathered Oak
FAN LIGHT	Integrated/Cover	Integrated/Cover
GLASS	Soft White Frosted	Soft White Frosted
DOWNROD FINISH	13	SN

OPTIONAL REMOTE: RMT-AC-UNIVERSAL with D Receiver

- Motor Size 153 x 12
- 52" Blade Span
- 12° Blade Pitch
- 3-Speed Pull-Chain Reversible Motor
- Additional Downrod Lengths Sold Separately
- Reversible Color Fan Blades & Integrated Fan Light Included
- 3M 9W LED Bulbs (750 Lumens per bulb, 2700K, 80+ CRI)
- Decorative Cover For Non-Light Use Included
- Dual Mounting System Included (Downrod & Hugger)

BUILDER SPECIALTY



FAN LIGHT OPTIONS PG 86-89

BUILDER SPECIALTY



52-FAN-5W-SN

52-FAN-5W-WH

FAN NUMBER	52-FAN-5W-SN	52-FAN-5W-WH
MOTOR FINISH	Satin Nickel	White
BLADE FINISH	White	White
FAN LIGHT	Optional	Optional
DOWNROD FINISH	SN	WH

COMPATIBLE FAN LIGHTS: FLC418 Series, FLG-1200 Series, Ratcliffe Series

OPTIONAL REMOTE: RMT-AC-UNIVERSAL with D Receiver

- Motor Size 153 x 18
- 52" Blade Span
- 12° Blade Pitch
- 3-Speed Pull-Chain Reversible Motor
- Additional Downrod Lengths Sold Separately
- Optional Fan Light Sold Separately
- Blades Included
- Dual Mounting System Included (Downrod & Hugger)

ENERGY USE AT HIGH SPEED

Airflow Use	Electricity Use	Airflow Efficiency
5,072 Cu Ft/Min	69.6W Excludes Lights	72.9 Cu Ft/Min/W
Compare: 49" to 60" ceiling fans have airflow efficiencies ranging from approximately 51 to 176 cu. ft. per min per watt at high speed.		



NOMAD



FAN LIGHT OPTIONS PG 86-89
DAMP FAN LIGHT OPTIONS PG 89

ENERGY USE AT HIGH SPEED

Airflow Use	Electricity Use	Airflow Efficiency
5,118 Cu Ft/Min	52.8W Excludes Lights	97 Cu Ft/Min/W

Compare: 49" to 60" ceiling fans have airflow efficiencies ranging from approximately 51 to 176 cu. ft. per min per watt at high speed.



NOMAD



52-EOF-5WA-13



52-EOF-5W-WH



52-EOF-5MB-FB



FAN NUMBER	52-EOF-5WA-13	52-EOF-5W-WH	52-EOF-5MB-FB
MOTOR FINISH	English Bronze	White	Flat Black
BLADE FINISH	Walnut	White	Matte Black
FAN LIGHT	Optional	Optional	Optional
DOWNROD FINISH	13	WH	FB

COMPATIBLE DAMP RATED FAN LIGHTS: FL-524, FLGC-1100

OPTIONAL REMOTE: RMT-AC-UNIVERSAL with C Receiver

- Motor Size 172 x 14
- 52" Blade Span
- 12° Blade Pitch
- 3-Speed Pull-Chain Reversible Motor
- All Weather Blades Included
- Fan Light & Additional Downrods Sold Separately
- Dual Mounting System Included (Downrod & Hugger)
- Fans & Blades are UL/CUL Wet Location

LANCER



FAN LIGHT OPTIONS PG 86-89
DAMP FAN LIGHT OPTIONS PG 89

LANCER



FAN NUMBER	52-SGO-5WA-13
MOTOR FINISH	English Bronze
BLADE FINISH	Walnut
FAN LIGHT	Optional
DOWNROD FINISH	13

ENERGY USE AT HIGH SPEED

Airflow Use 4,850 Cu Ft/Min	Electricity Use 54.37W Excludes Lights	Airflow Efficiency 89.21 Cu Ft/Min/W
-----------------------------------	--	--

Compare: 49" to 60" ceiling fans have airflow efficiencies ranging from approximately 51 to 176 cu. ft. per min per watt at high speed.

COMPATIBLE DAMP RATED FAN LIGHTS: FL-524, FLGC-1100

OPTIONAL REMOTE: RMT-AC-UNIVERSAL with D Receiver

- Motor Size 153 x 15
- 52" Blade Span
- 11.5° Blade Pitch
- 3-Speed Pull-Chain Reversible Motor
- All Weather Blades Included
- Optional Fan Light & Additional Downrods Sold Separately
- Dual Mounting System Included (Downrod & Hugger)
- Fans & Blades are UL/CUL Wet Location



CEILING FANS



CEILING FANS

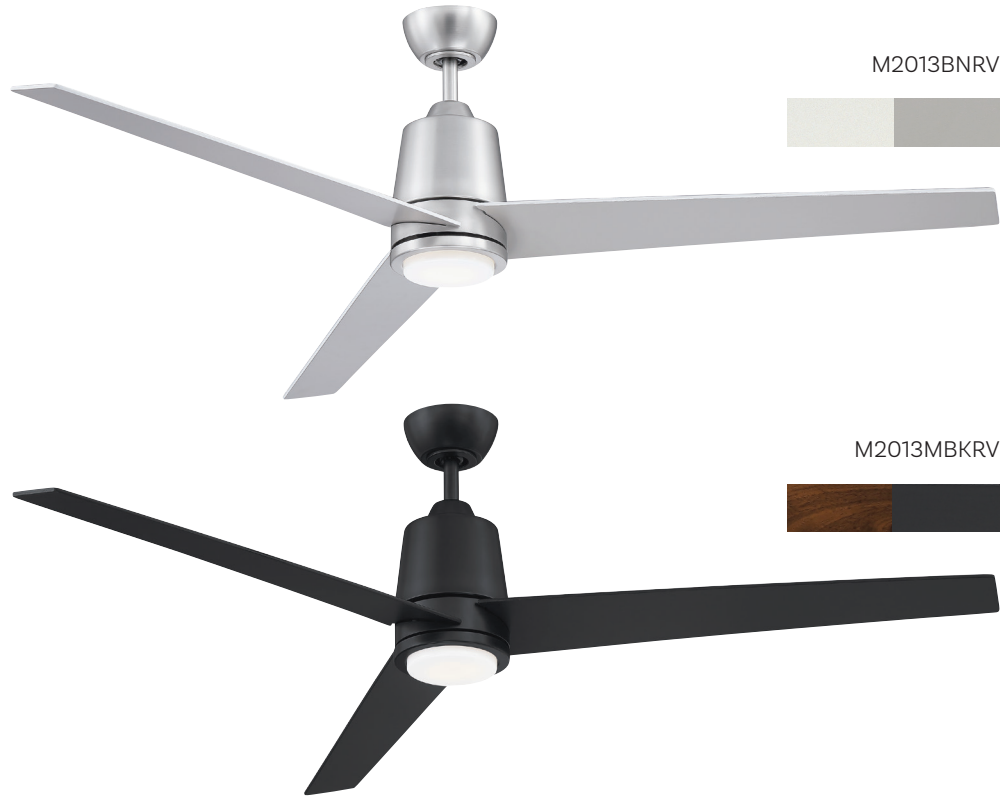

FAN NUMBER	M2013BNRV	M2013MBKRV
MOTOR FINISH	Brushed Nickel	Matte Black
BLADE FINISH	White/Brushed Nickel	Walnut/Matte Black
FAN LIGHT	Integrated	Integrated
GLASS	White Acrylic	White Acrylic
DOWNROD FINISH	SN	FB

ENERGY USE AT HIGH SPEED		
Airflow Use	Electricity Use	Airflow Efficiency
6,567.7	35.31W	186
Cu Ft/Min	Excludes Lights	Cu Ft/Min/W

Compare: 49" to 60" ceiling fans have airflow efficiencies ranging from approximately 51 to 176 cu. ft. per min per watt at high speed.

- Motor Size DC 125 x 30
- 56" Blade Span
- 26"W x 9-1/4"H (Cage Only)
- 13° Blade Pitch
- Additional Downrod Lengths Sold Separately
- Blades & Integrated Fan Light Included
- 17W LED Dimmable Module (1,350 Lumens, 3000K, 90 CRI)
- Not Hugger Kit Adaptable
- Handheld Remote included (RMT-DC-Universal)
- Fan & Blades are UL Damp Location



Handheld Remote Control Included
RMT-DC-UNIVERSAL



CEILING FANS



CEILING FANS



FAN NUMBER	M2012BN	M2012MBK
MOTOR FINISH	Brushed Nickel	Matte Black
FAN LIGHT	Integrated	Integrated
GLASS	White Opal	White Opal
DOWNROD FINISH	SN	FB

ENERGY USE AT HIGH SPEED		
Airflow Use 5,722 Cu Ft/Min	Electricity Use 50.76W Excludes Lights	Airflow Efficiency 112.73 Cu Ft/Min/W
Compare: 49" to 60" ceiling fans have airflow efficiencies ranging from approximately 51 to 176 cu. ft. per min per watt at high speed.		

- Motor Size 153 x 18
- 52" Blade Span
- 26"W x 9-1/4"H (Cage Only)
- 14° Blade Pitch
- Additional Downrod Lengths Sold Separately
- ABS Blades & Integrated Fan Light Included
- 16W LED Dimmable Module (1,500 Lumens, 3000K, 90 CRI)
- Not Hugger Kit Adaptable
- Handheld Remote with B Receiver included (RMT-AC-Universal)
- Fan & Blades are UL Damp Location



Handheld Remote Control Included
RMT-AC-UNIVERSAL



CEILING FANS



CEILING FANS

M2011BNRV



M2011MBKRV



FAN NUMBER	M2011BNRV	M2011MBKRV	ENERGY USE AT HIGH SPEED		
MOTOR FINISH	Brushed Nickel	Matte Black	Airflow Use	Electricity Use	Airflow Efficiency
BLADE FINISH	White/Silver	Antique Oak/Black	6,034	31.83W	189.58
FAN LIGHT	Integrated	Integrated	Cu Ft/Min	Excludes Lights	Cu Ft/Min/W
GLASS	White	White	Compare: 49" to 60" ceiling fans have airflow efficiencies ranging from approximately 51 to 176 cu. ft. per min per watt at high speed.		
DOWNROD FINISH	SN	FB			

- Motor Size DC 153 x 10
- 56" Blade Span
- 26"W x 9-1/4"H (Cage Only)
- 13.5° Blade Pitch
- Additional Downrod Lengths Sold Separately
- Blades & Integrated Fan Light Included
- 18W LED Dimmable Module (1,400 Lumens, 3000K, 90 CRI)
- Not Hugger Kit Adaptable
- Handheld Remote Included (RMT-DC-Universal)
- Fan & Blades are UL Damp Location



Handheld Remote Control Included
RMT-DC-UNIVERSAL



CEILING FANS



CEILING FANS



M2010BN



M2010MBK

FAN NUMBER	M2010BN	M2010MBK
MOTOR FINISH	Brushed Nickel	Matte Black
BLADE FINISH	Silver	Matte Black
DOWNROD FINISH	SN	FB

ENERGY USE AT HIGH SPEED		
Airflow Use 6,449 Cu Ft/Min	Electricity Use 59.42W	Airflow Efficiency 108.54 Cu Ft/Min/W
Compare: 49" to 60" ceiling fans have airflow efficiencies ranging from approximately 51 to 176 cu. ft. per min per watt at high speed.		

- Motor Size 188 x 20
- 58" Blade Span
- 26"W x 9-1/4"H (Cage Only)
- 6.8° Blade Pitch
- Additional Downrod Lengths Sold Separately
- ABS Blades Included
- Not Hugger Kit Adaptable
- Handheld Remote with B Receiver Included (RMT-AC-Universal)
- Fan & Blades are UL Damp Location
- Non-Light Kit Adaptable



Handheld Remote Control Included
RMT-AC-UNIVERSAL



CEILING FANS



ENERGY USE AT HIGH SPEED

Airflow Use	Electricity Use	Airflow Efficiency
5,297 Cu Ft/Min	58.55W Excludes Lights	90.47 Cu Ft/Min/W

Compare: 49" to 60" ceiling fans have airflow efficiencies ranging from approximately 51 to 176 cu. ft. per min per watt at high speed.



CEILING FANS

M2009BN



M2009ORB



FAN NUMBER	M2009BN	M2009ORB
MOTOR FINISH	Brushed Nickel	Oil Rubbed Bronze
BLADE FINISH	Chestnut/Grey Weathered Oak	Chestnut/Rubberwood
FAN LIGHT	Integrated	Integrated
GLASS	Clear	Clear
DOWNROD FINISH	SN	13

- Motor Size AC 153 x 18
- 52" Blade Span
- 12° Blade Pitch
- 3-Speed Pull-Chain Reversible Motor
- Additional Downrod Lengths Sold Separately

- Blades & Integrated Fan Light Included
- 1M 7W LED Dimmable Bulb (800 Lumens per bulb, 3000K, 80+ CRI)
- Dual-Mounting System Included (Downrod & Hugger)

CEILING FANS



CEILING FANS

M2006BN



M2006ORB



FAN NUMBER	M2006BN	M2006ORB
MOTOR FINISH	Brushed Nickel	Oil Rubbed Bronze
BLADE FINISH	Silver/Walnut	Cherry/Walnut
FAN LIGHT	Integrated	Integrated
DOWNROD FINISH	SN	13

- Motor Size 172 x 17
- 52" Blade Span
- 12.5° Blade Pitch
- 3-Speed Pull-Chain Reversible Motor
- Additional Downrod Lengths Sold Separately
- Blades & Integrated Fan Light Included
- 3M 4W LED Dimmable Bulbs (380 Lumens per bulb, 2700K, 80+ CRI)
- Dual-Mounting System Included (Downrod & Hugger)

ENERGY USE AT HIGH SPEED

Airflow Use	Electricity Use	Airflow Efficiency
5,110	69.52W	73.50
Cu Ft/Min	Excludes Lights	Cu Ft/Min/W

Compare: 49" to 60" ceiling fans have airflow efficiencies ranging from approximately 51 to 176 cu. ft. per min per watt at high speed.



FAN D'LIER®
MERIDIAN



FAN D'LIER® MERIDIAN



FAN NUMBER	M2007ORB
MOTOR FINISH	Oil Rubbed Bronze
BLADE FINISH	Matte Black
FAN LIGHT	Integrated
DOWNROD FINISH	13

ENERGY USE AT HIGH SPEED

Airflow Use	Electricity Use	Airflow Efficiency
1,471 Cu Ft/Min	38W Excludes Lights	38.71 Cu Ft/Min/W

Compare: 36" to 48" ceiling fans have airflow efficiencies ranging from approximately 71 to 86 cu. ft. per min. per watt at high speed.

- Motor Size 110 x 114
- 14" Blade Span
- 24"W x 29-1/8"H
- 13° Blade Pitch
- 3-Speed Non-Reversible Motor
- Additional Downrod Lengths Sold Separately
- 3M 8W LED Dimmable Bulbs (600 Lumens per bulb, 2400K, 80+ CRI)
- Handheld Remote with E Receiver Included (RMT-AC-UNIVERSAL)
- Not Hugger Kit Adaptable
- Fan & Blades are ETL Damp Location



Handheld Remote
Control Included
RMT-AC-UNIVERSAL

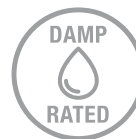

FAN D'LIER®
MERIDIAN



FAN D'LIER® MERIDIAN



FAN NUMBER	M2008ORB
MOTOR FINISH	Oil Rubbed Bronze
BLADE FINISH	Matte Black
FAN LIGHT	Integrated
DOWNROD FINISH	13

ENERGY USE AT HIGH SPEED

Airflow Use	Electricity Use	Airflow Efficiency
1,471 Cu Ft/Min	38W Excludes Lights	38.71 Cu Ft/Min/W

Compare: 36" to 48" ceiling fans have airflow efficiencies ranging from approximately 71 to 86 cu. ft. per min. per watt at high speed.

- Motor Size 105 x 115
- 14" Blade Span
- 24"W x 27-5/8"H
- 13° Blade Pitch
- 3-Speed Non-Reversible Motor
- Additional Downrod Lengths Sold Separately
- 3M 8W LED Dimmable Bulbs (600 Lumens per bulb, 2400K, 80 CRI)
- Handheld Remote with E Receiver Included (RMT-AC-UNIVERSAL)
- Not Hugger Kit Adaptable
- Fan & Blades are ETL Rated



Handheld Remote Control Included
RMT-AC-UNIVERSAL



FAN D'LIER® LYON



ENERGY USE AT HIGH SPEED

Airflow Use 1,471 Cu Ft/Min	Electricity Use 38W Excludes Lights	Airflow Efficiency 38.71 Cu Ft/Min/W
--	--	---

Compare: 36" to 48" ceiling fans have airflow efficiencies ranging from approximately 71 to 86 cu. ft. per min. per watt at high speed.



Handheld Remote
Control Included
RMT-AC-UNIVERSAL





39-FD-124-109

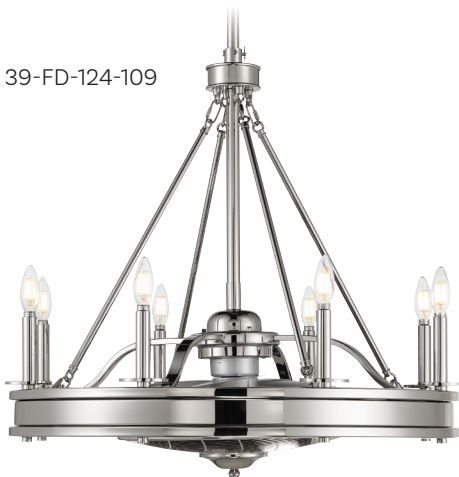

39-FD-124-322



39-FD-124-89



FAN NUMBER	39-FD-124-109	39-FD-124-322	39-FD-124-89
MOTOR FINISH	Polished Nickel	Warm Brass	Matte Black
BLADE FINISH	Silver	Gold	Black
FAN LIGHT	Integrated	Integrated	Integrated
DOWNROD FINISH	109	322	FB

- Motor Size 104 x 113
- 14" Blade Span
- 30"W x 40"H
- 13° Blade Pitch
- ABS Blades & Integrated Fan Light Included
- Additional Downrod Lengths Sold Separately

- 8C 6W LED Dimmable Bulbs (350 Lumens per bulb, 2700K, 90 CRI)
- Not Hugger Kit Adaptable
- Handheld Remote with E Receiver Included (RMT-AC-UNIVERSAL)
- Downrods included 4" & 18"

FAN D'LIER® OSLO



ENERGY USE AT HIGH SPEED

Airflow Use
870
Cu Ft/Min

Electricity Use
31W
Excludes Lights

Airflow Efficiency
28.06
Cu Ft/Min/W

Compare: 36" to 48" ceiling fans have airflow efficiencies ranging from approximately 71 to 86 cu. ft. per min. per watt at high speed.



Handheld Remote
Control Included
RMT-AC-UNIVERSAL



FAN D'LIER® OSLO



30-FD-126-322



30-FD-126-SN



30-FD-126-89



FAN NUMBER	30-FD-126-322	30-FD-126-SN	30-FD-126-89
MOTOR FINISH	Warm Brass	Satin Nickel	Matte Black
BLADE FINISH	Gold	Silver	Black
FAN LIGHT	Integrated	Integrated	Integrated
SHADE	White Linen	White Linen	White Linen
DOWNROD FINISH	322	SN	FB

- Motor Size 104 x 110
- 12" Blade Span
- 26"W x 15-1/2"H (Cage Only)
- 15° Blade Pitch
- ABS Blades & Integrated Fan Light Included
- Downrods Included 4" & 18"

- Additional Downrod Lengths Sold Separately
- 4M 6W LED Dimmable Bulbs (500 Lumens per bulb, 2700K, 80+ CRI)
- Not Hugger Kit Adaptable
- Handheld Remote with D Receiver Included (RMT-AC-UNIVERSAL)

FAN D'LIER®
WETHERBY



ENERGY USE AT HIGH SPEED

Airflow Use	Electricity Use	Airflow Efficiency
1,471	38W	38.71
Cu Ft/Min	Excludes Lights	Cu Ft/Min/W

Compare: 36" to 48" ceiling fans have airflow efficiencies ranging from approximately 71 to 86 cu. ft. per min. per watt at high speed.



Handheld Remote Control Included
 RMT-AC-UNIVERSAL

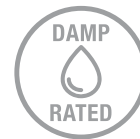

FAN D'LIER® WETHERBY

29-FD-122-SN



29-FD-122-44

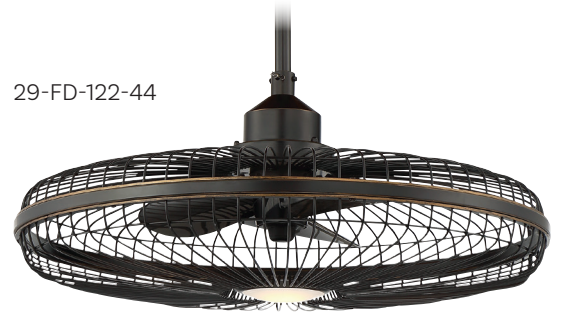

29-FD-122-322



FAN NUMBER	29-FD-122-SN	29-FD-122-44	29-FD-122-322
MOTOR FINISH	Satin Nickel	Classic Bronze	Warm Brass
BLADE FINISH	Silver	Black	Gold
FAN LIGHT	Integrated	Integrated	Integrated
GLASS	White Etched	White Etched	White Etched
DOWNROD FINISH	SN	13	322

- Motor Size 105 x 113
- 14" Blade Span
- 29-7/8"W x 26"H
- 13° Blade Pitch
- Downrods Included 4" & 18"
- Additional Downrod Lengths Sold Separately
- ABS Blades & Integrated Fan Light Included

- 12.5W LED Dimmable Module (800 Lumens, 3000K, 90 CRI)
- Not Hugger Kit Adaptable
- Handheld Remote with E Receiver Included (RMT-AC-UNIVERSAL)
- Fan & Blades are ETL Damp Location

FAN D'LIER®
STOCKHOLM



FAN D'LIER® STOCKHOLM



39-FD-125-53



39-FD-125-54

FAN NUMBER	39-FD-125-53	39-FD-125-54
MOTOR FINISH	Silver Patina	Gold Patina
BLADE FINISH	Silver	Gold
FAN LIGHT	Integrated	Integrated
DOWNROD FINISH	53	54

ENERGY USE AT HIGH SPEED

Airflow Use 1,471 Cu Ft/Min	Electricity Use 38W Excludes Lights	Airflow Efficiency 38.71 Cu Ft/Min/W
--	--	---

Compare: 36" to 48" ceiling fans have airflow efficiencies ranging from approximately 71 to 86 cu. ft. per min. per watt at high speed.

- Motor Size 104 x 113
- 14" Blade Span
- 31"W x 12"H (Cage Only)
- 13° Blade Pitch
- Additional Downrod Lengths Sold Separately
- ABS Blades & Integrated Fan Light Included
- 6C 6W LED Dimmable Bulbs (350 Lumens per bulb, 2700K, 90 CRI)
- Not Hugger Kit Adaptable
- Handheld Remote with E Receiver Included (RMT-AC-UNIVERSAL)
- Downrods Included 4" & 18"



Handheld Remote
Control Included
RMT-AC-UNIVERSAL



FAN D'LIER®
ETESIAN



FAN D'LIER® ETESIAN



FAN NUMBER	36-329-FD-21
MOTOR FINISH	Burnished Russett
FAN LIGHT	Integrated
GLASS	Clear Outer/Cream Inner
DOWNROD FINISH	21

ENERGY USE AT HIGH SPEED

Airflow Use	Electricity Use	Airflow Efficiency
1,471 Cu Ft/Min	38W Excludes Lights	38.71 Cu Ft/Min/W

Compare: 36" to 48" ceiling fans have airflow efficiencies ranging from approximately 71 to 86 cu. ft. per min. per watt at high speed.

- Motor Size 104 x 114
- 14" Blade Span
- 35-1/2"W x 40"H
- 13° Blade Pitch
- Additional Downrod Lengths Sold Separately
- ABS Blades & Integrated Fan Light Included
- 8M 6W LED Dimmable Bulbs (500 Lumens per bulb, 2700K, 80+ CRI)
- Not Hugger Kit Adaptable
- Handheld Remote with E Receiver Included (RMT-AC-UNIVERSAL)



Handheld Remote
Control Included
RMT-AC-UNIVERSAL



FAN D'LIER®
BRISA



FAN D' LIER® BRISA



FAN NUMBER 35-328-FD-13

MOTOR FINISH English Bronze

FAN LIGHT Integrated

SHADE Pale White Fabric

DOWNROD FINISH 13

ENERGY USE AT HIGH SPEED

Airflow Use	Electricity Use	Airflow Efficiency
1,471 Cu Ft/Min	38W Excludes Lights	38.71 Cu Ft/Min/W

Compare: 36" to 48" ceiling fans have airflow efficiencies ranging from approximately 71 to 86 cu. ft. per min. per watt at high speed.

- Motor Size 104 x 114
- 14" Blade Span
- 34-3/4"W x 39"H
- 13° Blade Pitch
- Downrods Included 4" & 18"
- Additional Downrod Lengths Sold Separately
- ABS Blades & Integrated Fan Light Included
- 8C 4W LED Dimmable Bulbs (300 Lumens per bulb, 2700K, 80+ CRI)
- Not Hugger Kit Adaptable
- Handheld Remote with E Receiver Included (RMT-AC-UNIVERSAL)



Handheld Remote
Control Included
RMT-AC-UNIVERSAL

LED

FAN D'LIER®
COLONADE



FAN D'LIER® COLONADE



FAN NUMBER	34-FD-123-155
MOTOR FINISH	Provence w/ Gold Accents
BLADE FINISH	Provence w/ Gold Accents
DOWNROD FINISH	155

ENERGY USE AT HIGH SPEED

Airflow Use	Electricity Use	Airflow Efficiency
1,471 Cu Ft/Min	38W Excludes Lights	38.71 Cu Ft/Min/W

Compare: 36" to 48" ceiling fans have airflow efficiencies ranging from approximately 71 to 86 cu. ft. per min. per watt at high speed.

- Motor Size 104 x 114
- 14" Blade Span
- 29-1/2"W x 34"H
- 13° Blade Pitch
- Downrods Included 4" & 18"
- Additional Downrod Lengths Sold Separately
- ABS Blades & Integrated Fan Light Included
- 6M 8W LED Dimmable Bulbs (600 Lumens per bulb, 2400K, 80+ CRI)
- Not Hugger Kit Adaptable
- Handheld Remote with E Receiver Included (RMT-AC-UNIVERSAL)



Handheld Remote
Control Included
RMT-AC-UNIVERSAL



FAN D'LIER®
ALSACE



FAN D'LIER® ALSACE



FAN NUMBER 26-9536-FD-196

MOTOR FINISH Reclaimed Wood

BLADE FINISH Chestnut

FAN LIGHT Integrated

GLASS White Etched

DOWNROD FINISH 196

ENERGY USE AT HIGH SPEED

Airflow Use	Electricity Use	Airflow Efficiency
2,276 Cu Ft/Min	40.38W Excludes Lights	56.35 Cu Ft/Min/W

Compare: 36" to 48" ceiling fans have airflow efficiencies ranging from approximately 71 to 86 cu. ft. per min. per watt at high speed.

- Motor Size 120 x 25
- 26" Blade Span
- 30"W x 17-5/8"H
- 13.5° Blade Pitch
- 3-Speed Reversible Motor
- Additional Downrod Lengths Sold Separately
- 18W LED Dimmable Module (1,400 Lumens, 3000K, 90 CRI)
- Not Hugger Kit Adaptable
- Handheld Remote with C Receiver Included (RMT-AC-UNIVERSAL)
- Fan & ABS Blades are UL/CUL Damp Location



Handheld Remote
Control Included
RMT-AC-UNIVERSAL



FAN D'LIER®
KONA



FAN D'LIER® KONA

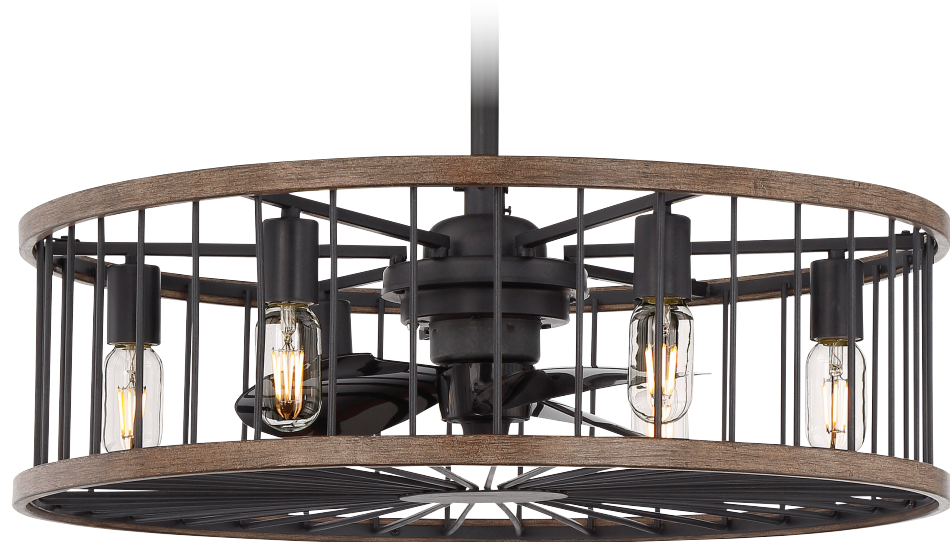

FAN NUMBER 26-9472-FD-133

MOTOR FINISH Sapele

BLADE FINISH Black

DOWNROD FINISH FB

ENERGY USE AT HIGH SPEED

Airflow Use	Electricity Use	Airflow Efficiency
1,471 Cu Ft/Min	38W Excludes Lights	38.71 Cu Ft/Min/W

Compare: 36" to 48" ceiling fans have airflow efficiencies ranging from approximately 71 to 86 cu. ft. per min. per watt at high speed.

- Motor Size 104 x 114
- 14" Blade Span
- 26"W x 9-1/4"H (Cage Only)
- 13° Blade Pitch
- Downrods Included 4" & 18"
- Additional Downrod Lengths Sold Separately
- ABS Blades & Integrated Fan Light Included
- 6M 6W LED Dimmable Bulbs (520 Lumens per bulb, 2700K, 80+ CRI)
- Not Hugger Kit Adaptable
- Handheld Remote with E Receiver Included (RMT-AC-UNIVERSAL)
- Fan & Blades are ETL Damp Location



Handheld Remote
Control Included
RMT-AC-UNIVERSAL



FAN D'LIER®
VIREO



FAN D'LIER® VIREO



FAN NUMBER	26-335-FD-272
MOTOR FINISH	Silver Dust
FAN LIGHT	Integrated
SHADE	Silver Mica
DOWNROD FINISH	272

ENERGY USE AT HIGH SPEED

Airflow Use	Electricity Use	Airflow Efficiency
1,471 Cu Ft/Min	38W Excludes Lights	38.71 Cu Ft/Min/W

Compare: 36" to 48" ceiling fans have airflow efficiencies ranging from approximately 71 to 86 cu. ft. per min. per watt at high speed.

- Motor Size 104 x 114
- 14" Blade Span
- 26"W x 30-1/8"H
- 13° Blade Pitch
- Downrods Included 4" & 18"
- Additional Downrod Lengths Sold Separately
- ABS Blades & Integrated Fan Light Included
- 6M 6W LED Dimmable Bulbs (500 Lumens per bulb, 2700K, 80+ CRI)
- Not Hugger Kit Adaptable
- Handheld Remote with E Receiver Included (RMT-AC-UNIVERSAL)



Handheld Remote
Control Included
RMT-AC-UNIVERSAL



FAN D' LIER®
TAURUS



FAN D' LIER® TAURUS



FAN NUMBER	30-333-FD-11
MOTOR FINISH	Polished Chrome
FAN LIGHT	Integrated
GLASS	White Opal
SHADE	Smoked & Clear Crystal
DOWNROD FINISH	11

ENERGY USE AT HIGH SPEED

Airflow Use	Electricity Use	Airflow Efficiency
870 Cu Ft/Min	31W Excludes Lights	28.06 Cu Ft/Min/W

Compare: 36" to 48" ceiling fans have airflow efficiencies ranging from approximately 71 to 86 cu. ft. per min. per watt at high speed.

- Motor Size 104 x 114
- 12" Blade Span
- 29-1/2"W x 30"H
- 15° Blade Pitch
- Downrods Included 4" & 18"
- Additional Downrod Lengths Sold Separately
- 6M 6W LED Dimmable Bulbs (500 Lumens per bulb, 2700K, 80+ CRI)
- Not Hugger Kit Adaptable
- Handheld Remote with D Receiver Included (RMT-AC-UNIVERSAL)



Handheld Remote
Control Included
RMT-AC-UNIVERSAL



FAN LIGHTS



A. **RATCLIFFE**
FLG-104-13
LED Fan Light
English Bronze Finish
15-3/4"W x 5"H
3M 7W LED Bulbs
(800 Lumens per bulb,
2700K, 80+ CRI)



B. **RATCLIFFE**
FLG-104-SN
LED Fan Light
Satin Nickel Finish
15-3/4"W x 5"H
3M 7W LED Bulbs
(800 Lumens per bulb,
2700K, 80+ CRI)



C. **RATCLIFFE**
FLG-104-187
LED Fan Light
Brushed Pewter Finish
15-3/4"W x 5"H
3M 7W LED Bulbs
(800 Lumens per bulb,
2700K, 80+ CRI)



FAN LIGHTS



D.



E.



F.



G.



H.

LED

D. FLG-1200-45
LED Fan Light
Aged Wood Finish
2M 6.5W LED Dimmable
Bulbs (600 Lumens per
bulb, 3000K, 80+ CRI)
White Frosted Glass

E. FLG-1200-129
LED Fan Light
Espresso Finish
2M 6.5W LED Dimmable
Bulbs (600 Lumens per
bulb, 3000K, 80+ CRI)
Cream Frosted Glass

F. FLG-1200-187
LED Fan Light
Brushed Pewter Finish
2M 6.5W LED Dimmable
Bulbs (600 Lumens per
bulb, 3000K, 80+ CRI)
White Frosted Glass

G. FLG-1200-148
LED Fan Light
Estate Brass Finish
2M 6.5W LED Dimmable
Bulbs (600 Lumens per
bulb, 3000K, 80+ CRI)
White Glass

H. FLG-1200-89
LED Fan Light
Matte Black Finish
2M 6.5W LED Dimmable
Bulbs (600 Lumens per
bulb, 3000K, 80+ CRI)
White Glass



I.



J.



K.



L.

I. FLG-1400-187
LED Fan Light
Brushed Pewter Finish
2M 6.5W LED Dimmable
Bulbs (600 Lumens per
bulb, 3000K, 80+ CRI)
White Frosted Glass

J. FLG-1400-129
LED Fan Light
Espresso Finish
2M 6.5W LED Dimmable
Bulbs (600 Lumens per
bulb, 3000K, 80+ CRI)
Cream Frosted Glass

K. FLG-1400-148
LED Fan Light
Estate Brass Finish
2M 6.5W LED Dimmable
Bulbs (600 Lumens per
bulb, 3000K, 80+ CRI)
White Glass

L. FLG-1400-89
LED Fan Light
Matte Black Finish
2M 6.5W LED Dimmable
Bulbs (600 Lumens per
bulb, 3000K, 80+ CRI)
White Glass

LED

FAN LIGHTS



FAN LIGHTS



A.

A. FL524-13

LED Fan Light
English Bronze Finish
8-1/4"W x 7"H
2M 9W LED Bulbs
(750 Lumens per bulb,
3000K, 80+ CRI)
Satin White Glass



B.

B. FL524-WH

LED Fan Light
White Finish
8-1/4"W x 7"H
2M 9W LED Bulbs
(750 Lumens per bulb,
3000K, 80+ CRI)
Satin White Glass



C.

C. FL524-FB

LED Fan Light
Flat Black Finish
8-1/4"W x 7"H
2M 9W LED Bulbs
(750 Lumens per bulb,
3000K, 80+ CRI)
Satin White Glass

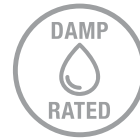

D.

D. FLGC-1110-13

LED Fan Light
English Bronze Finish
8-1/4"W x 7"H
1M 9W LED Bulb
(750 Lumens per bulb,
3000K, 80+ CRI)
White Opal Glass



E.

E. FLGC-1108-FB

LED Fan Light
Flat Black Finish
8-1/4"W x 7"H
1M 9W LED Bulb
(750 Lumens per bulb,
3000K, 80+ CRI)
White Opal Glass



CONTROLS



RMT-AC-UNIVERSAL

FULL FUNCTION HANDHELD FAN/LIGHT CONTROL WITH INDEPENDENT LIGHT CONTROL

- Three Speed Fan Control
- Separate On/Off Button with Full Range Light
- Dimming
- 3-volt Battery (Included)
- Up To A 40' Operating Distance
- Includes Wall Holster
- Transmitter Can Control Multiple Fans
- 1 Year Limited Warranty



















RMT-DC-UNIVERSAL

FULL FUNCTION HANDHELD FAN/LIGHT CONTROL WITH INDEPENDENT LIGHT CONTROL

- Six Speed Fan Control
- Separate On/Off Button With Full Range Light
- Dimming
- 3-volt Battery (Included)
- Up To A 40' Operating Distance
- Includes Wall Holster
- Transmitter Can Control Multiple Fans
- 1 Year Limited Warranty

Universal Remotes do not come with a reverse button if the fan has a manual reverse.

STANDARD DOWNRODS

	12"	18"	24"	36"	48"	60"	72"
 Polished Chrome	DR-12-11	DR-18-11	DR-24-11	DR-36-11	DR-48-11	DR-60-11	DR-72-11
 English Bronze	DR-12-13	DR-18-13	DR-24-13	DR-36-13	DR-48-13	DR-60-13	DR-72-13
 Burnished Russet	DR-12-21	DR-18-21	DR-24-21	DR-36-21	DR-48-21	DR-60-21	DR-72-21
 Aged Wood	DR-12-45	DR-18-45	DR-24-45	DR-36-45	DR-48-45	DR-60-45	DR-72-45
 Polished Nickel	DR-12-109	DR-18-109	DR-24-109	DR-36-109	DR-48-109	DR-60-109	DR-72-109
 Espresso	DR-12-129	DR-18-129	DR-24-129	DR-36-129	DR-48-129	DR-60-129	DR-72-129
 Grey Weathered Oak	DR-12-130	DR-18-130	DR-24-130	DR-36-130	DR-48-130	DR-60-130	DR-72-130
 Estate Brass	DR-12-148	DR-18-148	DR-24-148	DR-36-148	DR-48-148	DR-60-148	DR-72-148
 Brushed Pewter	DR-12-187	DR-18-187	DR-24-187	DR-36-187	DR-48-187	DR-60-187	DR-72-187
 Reclaimed Wood	DR-12-196	DR-18-196	DR-24-196	DR-36-196	DR-48-196	DR-60-196	DR-72-196
 Aged Steel	DR-12-242	DR-18-242	DR-24-242	DR-36-242	DR-48-242	DR-60-242	DR-72-242
 Silver Dust	DR-12-272	DR-18-272	DR-24-272	DR-36-272	DR-48-272	DR-60-272	DR-72-272
 Warm Brass	DR-12-322	DR-18-322	DR-24-322	DR-36-322	DR-48-322	DR-60-322	DR-72-322
 Flat Black	DR-12-FB	DR-18-FB	DR-24-FB	DR-36-FB	DR-48-FB	DR-60-FB	DR-72-FB
 Greywood	DR-12-GR	DR-18-GR	DR-24-GR	DR-36-GR	DR-48-GR	DR-60-GR	DR-72-GR
 Satin Nickel	DR-12-SN	DR-18-SN	DR-24-SN	DR-36-SN	DR-48-SN	DR-60-SN	DR-72-SN
 White	DR-12-WH	DR-18-WH	DR-24-WH	DR-36-WH	DR-48-WH	DR-60-WH	DR-72-WH

SPECIFICATIONS

Fan Series	MOTOR PERFORMANCE												
	MOTOR SIZE	LOW				MEDIUM				HIGH			
		RPM	WATT	AMP	CFM**	RPM	WATT	AMP	CFM**	RPM	WATT	AMP	CFM**
Alsace (52-840)	153x18	68	12.42	0.3	1906.59	116	32.7	0.393	3469	168	61.33	0.51	4983.21
Alsace Fan D'Lier (26-9536)	120x25	251	15.68	0.284	1298.71	375	28.21	0.346	1920.65	444	40.38	0.35	2275.61
Bluffton (72-5045)	DC-165L	54	6.36	0.11	4648.24	85	16	0.23	7600	105	32.89	0.45	9744.36
Brisa (35-328-FD)	104x114	870	23	0.31	1017	950	30	0.34	1194	1310	38	0.35	1471
Buckenham (56-5075)	DC 125	53	1.88	0.04	1964.82	125	14.3	0.217	4750	162	31.86	0.43	6032.22
Builder Specialty (52-FAN)	153x18	68	8.71	0.21	1472.43	129	28.1	0.34	3155	196	69.6	0.58	5072.72
Colonade (34-FD-123)	104x114	870	23	0.31	1017	950	30	0.34	1194	1310	38	0.35	1471
Connell (56-578)	188x22	68	14.46	0.26	2057.16	95	36	0.4	3100	154	70.59	0.59	5695.85
Dayton (52-6110)	153x20	63	12.97	0.23	1905.62	105	22	0.35	2850	150	58.3	0.49	4665.33
Etesian (36-329-FD)	104x114	870	23	0.31	1017	950	30	0.34	1194	1310	38	0.35	1471
Farmhouse (60-760)	153x20	50	4.44	0.08	2902.16	81	16.79	0.26	4970.18	97	30.28	0.41	6250.54
Farmhouse II (44-770)	153x10	50	1.8	0.04	1093.14	136	11.14	0.19	3319.07	200	32.64	0.44	4719.46
First Value Bowl (52-ECM)	153x13	61	9.47	0.21	1387.4	122	27.9	0.358	3017	180	60.99	0.51	4502.95
First Value Down Light (52-EUP)	153x12	64	9.83	0.21	1381.59	105	29	0.35	3210	190	60.48	0.5	4227.04
Hyannis II (52-625)	153x20	55	12.54	0.24	1563.12	105	33.9	0.41	3818.39	156	67.34	0.57	5092.67
Kentwood (52-5095)	172x17	73	13.02	0.25	2076.4	119	35.5	0.42	3370	172	70.19	0.59	5264.78
Kona (26-9472)	104x114	870	23	0.31	1017	950	30	0.34	1194	1310	38	0.35	1471
La Salle (60-5025)	DC-165M	51	3.18	0.07	2204.67	110	11	0.45	5200	144	17.81	0.27	6791.44
Lancer (52-SGO)	153x15	76	10.63	0.21	1944.59	126	28.1	0.38	3810	175	54.37	0.45	4850.47
Lyon (39-FD-124)	104x114	870	23	0.31	1017	950	30	0.34	1194	1310	38	0.35	1471
Meridian (M2006)	172x17	73	13.3	0.26	2057.94	119	35.5	0.42	3370.26	173	69.52	0.58	5109.84
Meridian (M2007)	104x114	870	23	0.31	1017	950	30	0.34	1194	1310	38	0.35	1471
Meridian (M2008)	104x114	870	23	0.31	1017	950	30	0.34	1194	1310	38	0.35	1471
Meridian (M2009)	153x18	63	11.26	0.22	1803.73	115	29.17	0.35	3521.85	169	58.55	0.49	5297.21
Meridian (M2010)	188x20	82	12.62	0.22	2576.5	134	32.96	0.37	4625.89	187	59.42	0.5	6449.26
Meridian (M2011)	153x10	48	2.1	0.04	1579.08	118	10.87	0.18	4233.26	166	31.83	0.41	6034.25
Meridian (M2012)	153x18	67	10.05	0.2	2107.19	126	29.74	0.34	4274.95	170	50.76	0.44	5722.34
Meridian (M2013)	125x30	49	1.58	0.03	1485.4	138	11.5	0.18	4444.75	198	35.31	0.46	6567.7

*If Fan Light included, measurement B is to bottom of Fan Light; otherwise to bottom of switch housing.

**Airflow is measured in cubic feet per minute (CFM).

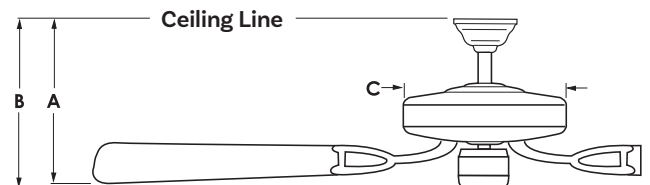

SPECIFICATIONS

DIMENSIONS			BLADE SPAN	BLADE PITCH	INCLUDED DOWNROD LENGTH	SAFETY RATING	FAN LIGHT ADAPTABLE	REMOTE CONTROLS		*** HUGGER KIT ADAPTABLE	LIMITED WARRANTY	PG #
A	B*	C						ADAPTABLE	RECEIVER			
10.87"	21.83	8.79	52"	12°	6"	UL, CUL	Included	Included	A	No	Lifetime	19
12.59"	17.52"	29.92"	26"	13.5°	6"	UL, CUL	Included	Included	C	No	Lifetime	71
11.41"	14.87"	7.40"	72"	13°	4.5"	ETL	Included	Included	-	No	Lifetime	9
34"	39.00"	34.75"	14"	13°	18"	ETL	Included	Yes	E	Dual	Lifetime	67
13.41"	16.34"	6.14"	56"	13°	6"	UL	Included	Included	-	No	Lifetime	17
10.75"	13.15	11.00	52"	12°	4"	UL, CUL	N/A	N/A	pull chain	Dual	Lifetime	43
29.41"	33.86"	14"	13°	18°	-	ETL	Included	Yes	E	Dual	Lifetime	69
13.32"	20.83"	10.24"	56"	13.5°	6"	UL	Included	Included	B	No	Lifetime	21
11.55"	14.72"	6.85"	52"	13.5°	4.5"	UL	Included	Included	A	No	Lifetime	15
39.88	35.50"	14"	13°	18°	-	ETL	Included	Yes	E	Dual	Lifetime	65
12.05"	14.10"	8.00"	60"	15°	8"	UL	Included	Included	-	No	Lifetime	5
11.81"	14.10"	8.03"	44"	15°	6"	UL	Included	Included	-	No	Lifetime	7
10.13"	19.02"	10.89"	52"	10.5°	4"	UL	Included	N/A	pull chain	Dual	Lifetime	39
11.34"	19.52"	11.00"	52"	11.5°	4.5"	UL	Included	N/A	pull chain	Dual	Lifetime	41
12.40"	19.88"	8.03"	52"	13.5°	6"	UL, CUL	Included	Included	A	No	Lifetime	25
11.06"	13.29"	12.60"	52"	12.5°	4.5"	UL	N/A	N/A	pull chain	Dual	Lifetime	31
26.5"	28.25"	26.00"	14"	13°	18"	ETL	Included	Yes	E	Dual	Lifetime	75
11.44"	14.30"	6.87"	60"	N/A	4.5"	ETL	Included	Included	-	No	Lifetime	13
11.24	14.09"	11.04"	52"	11.5°	4.5"	UL, CUL	N/A	N/A	pull chain	Dual	Lifetime	47
-	30.00"	40.55"	14"	13°	18"	ETL	Included	Yes	E	Dual	Lifetime	57
11.06"	18.29	12.60	52"	12.5°	4.5"	UL, CUL	Included	N/A	B	Dual	Lifetime	59
-	29.13"	24.00	14"	13°	18"	ETL	Included	Yes	E	Dual	Lifetime	61
-	27.63"	24.00"	14"	13°	18"	ETL	Included	Yes	E	Dual	Lifetime	63
11.52"	20.66"	10.24"	52"	12°	4.5"	UL, CUL	Included	N/A	A	Dual	Lifetime	57
12.26"	13.04"	9.61"	58	6.8°	6"	UL	N/A	Included	B	No	Lifetime	55
9.96"	12.79"	6.87"	56	13.5°	4.5"	UL	Included	Included	-	No	Lifetime	53
10.22"	13.49"	7.09"	52	14°	4.5"	UL	Included	Included	B	No	Lifetime	51
13.47"	15.74"	6.06"	56	13°	6"	UL	Included	Included	-	No	Lifetime	48

***Dual Mount includes downrod & convertible canopy for hugger style.

Downrod Length	Standard	12"	18"	24"	36"	48"	60"	72"
Ceiling Height	8'	9'	10'	11'	12'	13'	14'	15'

INDEX

26-335-FD-272.....	82	52-ECM-5RV-13.....	39	FLG-104-187.....	86
26-9472-FD-133.....	80	52-ECM-5RV-13WG.....	39	FLG-104-SN.....	86
26-9536-FD-196.....	78	52-ECM-5RV-SN.....	39	FLG-1200-45.....	87
29-FD-122-322.....	69	52-ECM-5RV-WH.....	39	FLG-1200-89.....	87
29-FD-122-44.....	69	52-EOF-5MB-FB.....	45	FLG-1200-129.....	87
29-FD-122-SN.....	69	52-EOF-5W-WH.....	45	FLG-1200-148.....	87
30-333-FD-11.....	84	52-EOF-5WA-13.....	45	FLG-1200-187.....	87
30-FD-126-322.....	67	52-EUP-5RV-13WG.....	41	FLG-1400-89.....	87
30-FD-126-89.....	67	52-EUP-5RV-SN.....	41	FLG-1400-129.....	87
30-FD-126-SN.....	67	52-FAN-5W-SN.....	43	FLG-1400-148.....	87
34-FD-123-155.....	76	52-FAN-5W-WH.....	43	FLG-1400-187.....	87
35-328-FD-13.....	74	52-SGC-5RV-13.....	33	FLGC1108-FB.....	89
36-329-FD-21.....	72	52-SGC-5RV-SN.....	33	FLGC1110-13.....	89
39-FD-124-109.....	65	52-SGO-5WA-13.....	47	M2006BN.....	59
39-FD-124-322.....	65	56-5075-5GWO-130.....	17	M2006ORB.....	59
39-FD-124-89.....	65	56-578-5WA-13.....	21	M2007ORB.....	61
39-FD-125-53.....	71	60-5025-313-13.....	13	M2008ORB.....	63
39-FD-125-54.....	71	60-5025-3KO-SN.....	13	M2009BN.....	57
44-770-6AO-89.....	7	60-5025-3SV-SN.....	13	M2009ORB.....	57
44-770-6GR-187.....	7	60-760-12AO-89.....	5	M2010BN.....	55
44-770-6WO-168.....	7	60-760-12GR-187.....	5	M2010MBK.....	55
52-5095-545-45.....	31	60-760-12WO-168.....	5	M2011BNRV.....	53
52-5095-5RV-109.....	31	60-820-613-13.....	11	M2011MBKRV.....	53
52-5095-5RV-13.....	31	60-820-6SV-SN.....	11	M2012BN.....	51
52-5095-5RV-SN.....	31	62-5085-3CN-109.....	23	M2012MBK.....	51
52-5095-5RV-WH.....	31	62-5085-3SV-SN.....	23	M2013BNRV.....	49
52-6110-4RV-89.....	15	62-5085-3WA-13.....	23	M2013MBKRV.....	49
52-6110-4WH-WH.....	15	68-227-545-45.....	27	RMT-AC-UNIVERSAL.....	90
52-625-5AS-242.....	25	68-227-589-89.....	27	RMT-DC-UNIVERSAL.....	90
52-625-5CN-13.....	25	68-227-5RV-129.....	27		
52-830-545-45.....	29	68-227-5RV-148.....	27		
52-830-589-89.....	29	68-227-5RV-187.....	27		
52-830-5RV-148.....	29	72-5045-813-13.....	9		
52-830-5RV-187.....	29	72-5045-889-89.....	9		
52-831-5RV-109.....	35	72-5045-8GR-GR.....	9		
52-831-5RV-13.....	35	72-5045-8SV-SN.....	9		
52-831-5RV-89.....	35	FL524-13.....	89		
52-831-5RV-SN.....	35	FL524-FB.....	89		
52-840-5CN-196.....	19	FL524-WH.....	89		
52-CDC-5RV-SN.....	37	FLG-104-13.....	86		





3130 N. Berkeley Lake Road NW ♦ Duluth, GA 30096
TEL 800 801 1621 ♦ TEL 404 890 7540 ♦ FAX 877 547 2869
SAVOYHOUSE.COM