



2023

SCHONBEK
Beyond[®]

CHANDELIERS	4
PENDANTS	44
INDOOR SCONCES	68
BATH/VANITY	92
FLUSH MOUNTS	108
EXTERIOR SCONCES	118
RECESSED	140

SCHONBEK BEYOND

Continuing a 150-year heritage of craftsmanship and cutting-edge design, Schonbek Beyond offers a stunning premium collection of all-LED luxury crystal luminaires.

With a contemporary twist on exquisite traditional design, Schonbek Beyond features modern, edgy motifs captured in fine, multifaceted crystal and a lustrous cavalcade of mixed metals that captivate the imagination.

Groundbreaking LED technology provides dramatic illumination to highlight the luminaire's distinctive silhouettes.

Welcome to a new era of luxury. Schonbek Beyond. Modern Masterpieces of Style and Artistry.

SCHONBEK
Beyond



OPTIC CRYSTAL

Modern advancements in the manufacture of optics used in telescopes have ushered in a new generation of crystal. Created to enhance internal light refraction, the Optic Crystal used in Schonbek luminaires catapults new designs into the future.



RADIANCE™ CRYSTAL DUST

Prismatic and enigmatic, Schonbek Radiance™ Crystal Dust is composed of tiny jewel-cut facets each sized, shaped and polished to shimmering perfection. Fabricated in Europe at the premier source for lead-free crystal, thousands of these brilliant gems embellish our lighting designs, casting luminous beams that dance and dazzle.



OPTIC HAZE™ CRYSTAL

Optic Haze™ is a distinctive Schonbek crystal composed of natural quartz featuring unique variations in luster, hue, patterning and texture. When illuminated, the depth and dimension of each crystal is accentuated, creating captivating visual interest.

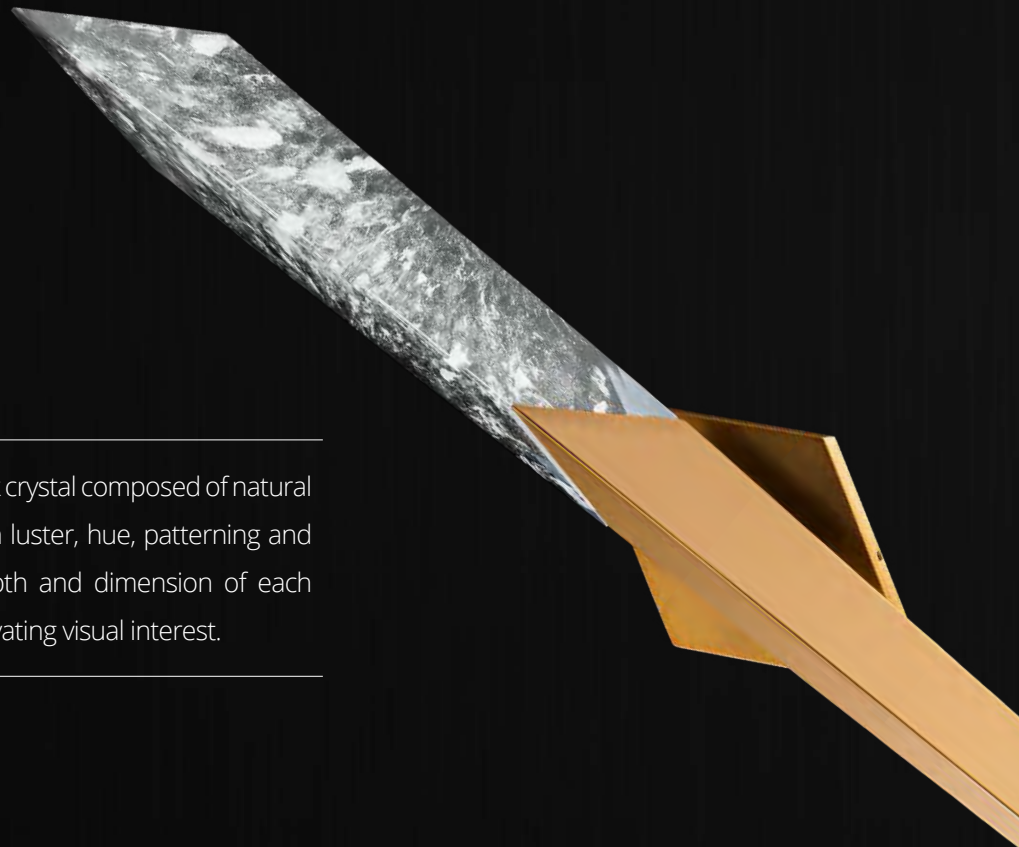

RADIANCE™ CRYSTAL

Radiance™ by Schonbek is our finest crystal offering: it is free of flaws, engineered for optimal brilliance and characterized by optical purity. Fabricated in Europe at the premier source for lead-free crystal, our proprietary Radiance™ Crystal has more than double the number of jewel-cut facets compared to those mass-produced and imported from the East. Radiance™ casts a scintillating play of light that dances and dazzles.





CHANDELIERS

Hollywood glamour, dazzling symphonies and edgy motifs in fine multifaceted crystal captivate the sparkle of modern luminaires, all complemented with a glimmering cavalcade of mixed metals. The sculptural elegance of contemporary chandeliers creates an enduring aesthetic statement. These timeless masterpieces offer remarkable details to be enjoyed and admired.

SOLITUDE

A dramatic character that you can't help but fall in love with. The Solitude chandelier features Schonbek Optic Haze Crystal composed of natural quartz gemstone that illuminates and gravitates. Crystal spears juxtapose heroically with bolts of luminous energy.



- Optic Haze Crystal is engineered from organic quartz rock crystal quarried from the Earth. Traces of natural elements create unique variations in luster, hue, patterning and texture when illuminated.
- Each hand selected piece features unique variations
- Built-in adjustable 3000K / 3500K / 4000K color temperature switch within the canopy
- Three 12" and one 6" down rods included (additional sold separately)
- Hang straight swivel
- Thin canopy conceals a proprietary dual voltage 120V/277V driver
- Spin-on round canopy with minimal hardware
- Can be mounted on a sloped ceiling
- Dimmer: ELV, TRIAC

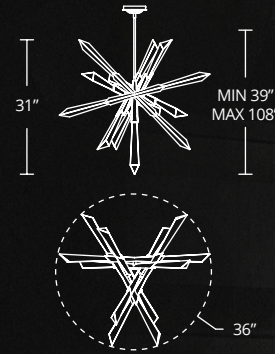

Finish

- AB: Aged Brass
- AN: Antique Nickel

Crystal

- Optic Haze Crystal

Model	Size	CCT	Voltage	Wattage	Weight	LED Lumens	Delivered Lumens
BPD31236	36"	3000K/3500K/4000K	120/277V	29W	29 lb	1800	1444

Example: BPD31236-AB



BENEDICTION

Benediction is a subtle statement of calming elegance. A ring adorned with sprays of crystals reminiscent of stalactites in a cavern is illuminated generously from within with hidden LEDs. Unique and inspiring.



- Random crystal configurations create uniqueness to individual preference
- Built-in adjustable 3000K / 3500K / 4000K color temperature switch within the canopy
- Thin powered aircraft cables provide an ultra clean look for adjustable suspension height
- Thin canopy conceals a proprietary universal 120V-220V-277V driver
- Spin-on round canopy with minimal hardware
- Can be mounted on a sloped ceiling
- Dimmer: ELV, TRIAC, 0-10V
- Patent pending design

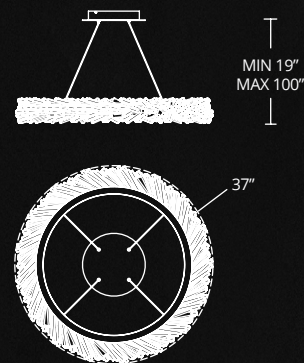

Finish

AB: Aged Brass

BK: Black

Crystal

Optic Crystal

Model	Size	CCT	Voltage	Wattage	Weight	LED Lumens	Delivered Lumens
BPD46237	37"	3000K/3500K/4000K	120-277V	55W	77 lb	4000	1200

Example: BPD46237-AB



MARTINI

A shower of jewels. Suspended in mid-air, Schonbek Optic and Optic Haze Crystal elements composed of natural quartz gemstone illuminate at varying heights to entice. Cascading from above and perfectly designed for over breakfast tables or nightstands in a bedroom to make a powerful yet elegant statement.



- Optic Haze Crystal is engineered from organic quartz rock crystal quarried from the Earth. Traces of natural elements create unique variations in luster, hue, patterning and texture when illuminated.
- Built-in adjustable 3000K / 3500K / 4000K color temperature switch within the canopy
- Thin powered aircraft cables provide an ultra clean look for adjustable suspension height
- Thin canopy conceals a proprietary universal 120V-220V-277V driver
- Decorative diamond texture diffuser is included to be installed to customer preference
- Can be mounted on a sloped ceiling
- Dimmer: ELV, TRIAC, 0-10V



BPD20205OH-PN



BPD20203OH-AB



BPD20209O-BK

Finish

- AB: Aged Brass
- BK: Black
- PN: Polished Nickel

Crystal

- Optic Crystal
- Optic Haze Crystal

Model	# of Lights	CCT	Voltage	Wattage	Weight	LED Lumens	Delivered Lumens
BPD20203	3 lights			25W	12 lb	1971	UP TO 1518
BPD20205	5 lights	3000K/3500K/4000K	120-277V	42W	24 lb	3285	UP TO 2530
BPD20209	9 lights			75W	33 lb	5913	UP TO 4554

Example: BPD20209O-BK

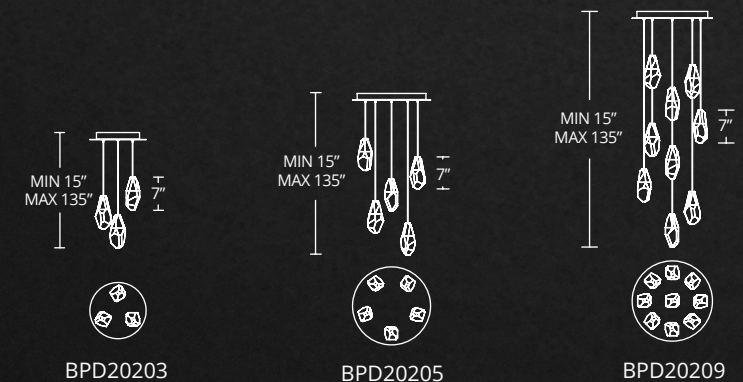

SYNAPSE

Connect with the sculptural elegance of this modern crystal chandelier. Synapse features Schonbek Optic Haze Crystal composed of natural quartz gemstone. This exquisite 12 light chandelier is both current and luxurious. Hidden behind each crystal element, a high-tech LED illuminates generously for beautiful ambient illumination for all to see. A head-turner that will dazzle in entryways and other important spaces.



- Unique Optic Haze Crystal diffuser
- Each hand selected piece features unique variations
- Built-in adjustable 3000K / 3500K / 4000K color temperature switch within the canopy
- Three 12" and one 6" down rods included (additional sold separately)
- Hang straight swivel
- Thin canopy conceals a proprietary universal 120V-220V-277V driver
- Spin-on round canopy with minimal hardware
- Can be mounted on a sloped ceiling
- Dimmer: ELV, TRIAC, 0-10V

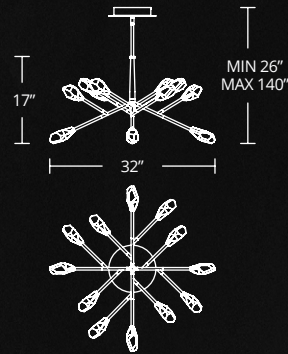

Finish

AB: Aged Brass

BK: Black

Crystal

Optic Haze Crystal



Model	Size	CCT	Voltage	Wattage	Weight	LED Lumens	Delivered Lumens
BPD32232	32"	3000K/3500K/4000K	120-277V	34W	29 lb	2894	1557

Example: BPD32232-AB



HERACLES

A geometric phenom with striking depth and dimension. This stunning modern design showcases an illuminated faceted Optic Crystal cube within tumbling cubes, like high-roller dice.



- Built-in adjustable 3000K / 3500K / 4000K color temperature switch within the canopy
- Three 12" and one 6" down rods included (additional sold separately)
- Hang straight swivel
- Spin-on round canopy with minimal hardware
- Thin canopy conceals a proprietary universal 120V-220V-277V driver
- Can be mounted on a sloped ceiling
- Dimmer: ELV, TRIAC, 0-10V

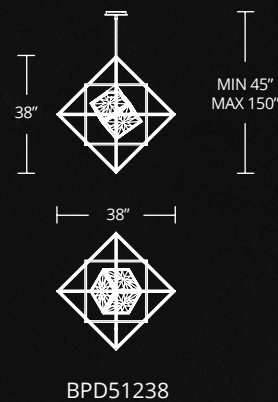
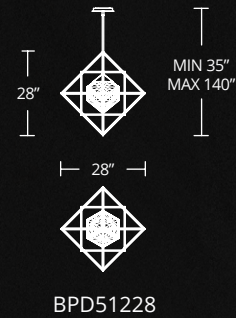

Finish

BK: Black

Crystal

Optic Crystal

Model	Size	CCT	Voltage	Wattage	Weight	LED Lumens	Delivered Lumens
BPD51228	28"	3000K/3500K/4000K	120-277V	18W	15 lb	1200	400
BPD51238	38"	3000K/3500K/4000K	120-277V	25W	28 lb	1800	600

Example: BPD51238-BK



MIRAGE

A twinkling array of suspended diamond-shaped crystals shimmer in matte black framed illumination. Beams of upward and down light illuminate the crystals in all directions for a magnificent and thought-provoking effect.



- Inner mirror grade backing plate
- Built-in adjustable 3000K / 3500K / 4000K color temperature switch within the canopy
- Thin canopy conceals a proprietary universal 120V-220V-277V driver
- Dimmer: ELV, TRIAC, 0-10V

Finish



BK: Black

Crystal



Optic Crystal

Model	Size	CCT	Voltage	Wattage	Weight	LED Lumens	Delivered Lumens
BPD16254	54"	3000K/3500K/4000K	120-277V	64W	43 lb	3841	2830

Example: BPD16254-BK

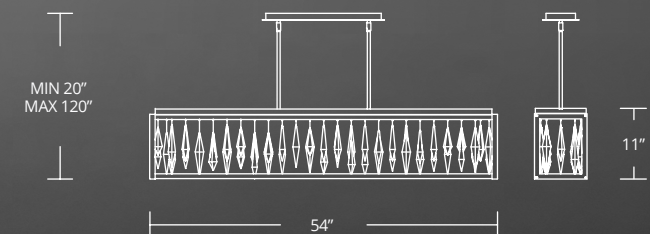

CORINTH

Adorned with large trillion-diamond shaped Schonbek Optic Haze Crystals composed of natural quartz gemstone. Corinth is a new statement on crystal. Hidden light sources and powered aircraft cables elevate a conservative profile with intrigue and technology. The solid double ring body is finished in crystal haze and deploys ambient up lighting.

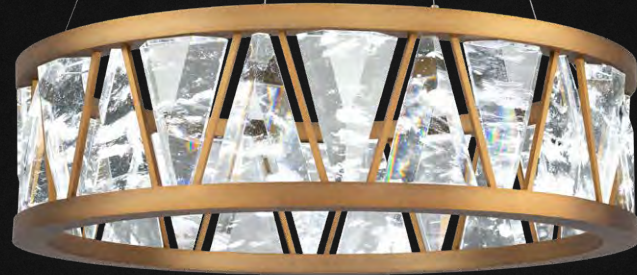

BPD74232-AB



- Optic Haze Crystal is engineered from organic quartz rock crystal quarried from the Earth. Traces of natural elements create unique variations in luster, hue, patterning and texture when illuminated.
- Each hand selected piece features unique variations
- Built-in adjustable 3000K / 3500K / 4000K color temperature switch within the canopy
- Thin powered aircraft cables provide an ultra clean look for adjustable suspension height
- Spin-on round canopy with minimal hardware
- Thin canopy conceals a proprietary universal 120V-220V-277V driver
- Can be mounted on a sloped ceiling
- Dimmer: ELV, TRIAC, 0-10V

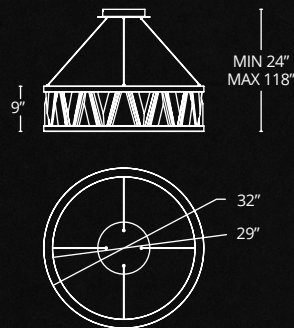

Finish

- AB: Aged Brass
- BK: Black

Crystal

- Optic Haze Crystal

Model	Size	CCT	Voltage	Wattage	Weight	LED Lumens	Delivered Lumens
BPD74232	32"	3000K/3500K/4000K	120-277V	55W	55 lb	3447	2500

Example: BPD74232-BK



ATOMIC

Express yourself in this artistic, rotating blend of light and movement in space. The hand stitched Italian black leather bands illuminate uniformly from within. In the nucleus of this dynamic piece is a central crystal that illuminates with an LED beam on the outer ring. A head-turning attention getter.





BPD45236-BK/BN



- Built-in adjustable 3000K / 3500K / 4000K color temperature switch within the canopy
- Three 12" and one 6" down rods included (additional sold separately)
- Hang straight swivel
- 360 degree adjustable rings design
- Thin canopy conceals a proprietary universal 120V-220V-277V driver
- Can be mounted on a sloped ceiling
- Dimmer: ELV, TRIAC, 0-10V
- Patent pending design

Finish

 BK/AB: Black/Aged Brass

 BK/BN: Black/Brushed Nickel

Crystal

 Optic Crystal

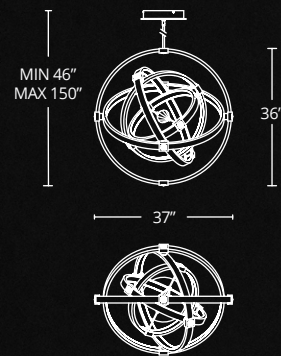

Model	Size	CCT	Voltage	Wattage	Weight	LED Lumens	Delivered Lumens
BPD45236	36"	3000K/3500K/4000K	120-277V	115W	32 lb	7300	6123

Example: BPD45236-BK/AB



MYSTIQUE

A restrained silhouette, luxuriously bound in vintage leather for a look of disciplined decadence. The slender linear pendant reveals a shimmering diffuser of applied crystal gemstones that transmute the bright integral LEDs for ample task illumination.



- Diffuser uses 18,000 (42") and 30,000 (70") pieces of Radiance Crystal Dust fabricated for Schonbek in Europe
- Silver stitching leather frame
- Built-in adjustable 3000K / 3500K / 4000K color temperature switch within the canopy
- Thin powered aircraft cables provide an ultra clean look for adjustable suspension height
- Thin canopy conceals a proprietary universal 120V-220V-277V driver
- Can be mounted on a sloped ceiling
- Dimmer: ELV, TRIAC, 0-10V

Finish

● BK: Black

Crystal

● Radiance Crystal Dust

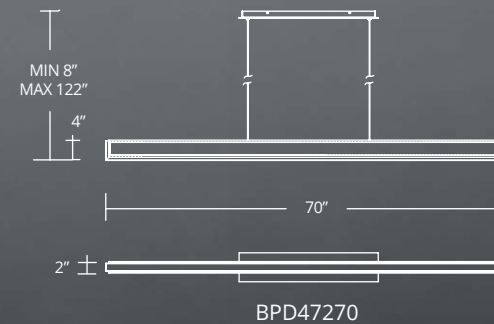
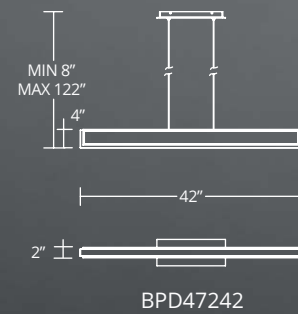

Model	Size	CCT	Voltage	Wattage	Weight	LED Lumens	Delivered Lumens
BPD47242	42"	3000K/3500K/4000K	120-277V	30W	10 lb	2661	1991
BPD47270	70"	3000K/3500K/4000K	120-277V	45W	16 lb	3597	2579

Example: BPD47242-BK



QUEST

Crystal ball patterned to offer enhanced illumination, this Schonbek Optic Haze Crystal sphere projects omnidirectional high quality LED illumination for an astonishing, graceful aesthetic.



- Optic Haze Crystal is engineered from organic quartz rock crystal quarried from the Earth. Traces of natural elements create unique variations in luster, hue, patterning and texture when illuminated.
- Built-in adjustable 3000K / 3500K / 4000K color temperature switch within the canopy
- Thin powered aircraft cables provide an ultra clean look for adjustable suspension height
- Can be mounted on a sloped ceiling
- Thin canopy conceals a proprietary universal 120V-220V-277V driver
- Dimmer: ELV, 0-10V, TRIAC



BPD40203-BK

BPD40205-AB



Finish

- AB: Aged Brass
- BK: Black

Crystal

- Optic Haze Crystal

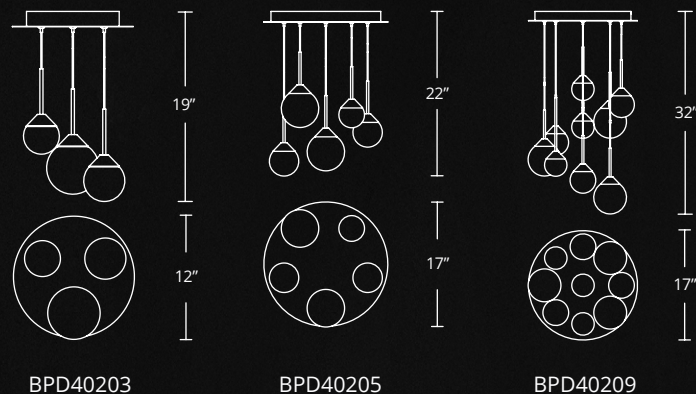

BPD40203

BPD40205

BPD40209

Model	# of Lights	CCT	Voltage	Wattage	Weight	LED Lumens	Delivered Lumens
BPD40203	3			12W	15 lb	1076	1053
BPD40205	5	3000K/3500K/4000K	120-277V	22W	27 lb	1813	1772
BPD40209	9			38W	42 lb	2779	2519

Example: BPD40209-AB



SLIPSTREAM

Like a current of air, Slipstream is modern, graceful and stylishly curved with seamless spatial flow. This extraordinary luminaire adds a twist of matte black metal with Optic Haze Crystal orbs, composed of natural quartz gemstone, to radiate captivatingly and enhance your space with a unique look and personality.

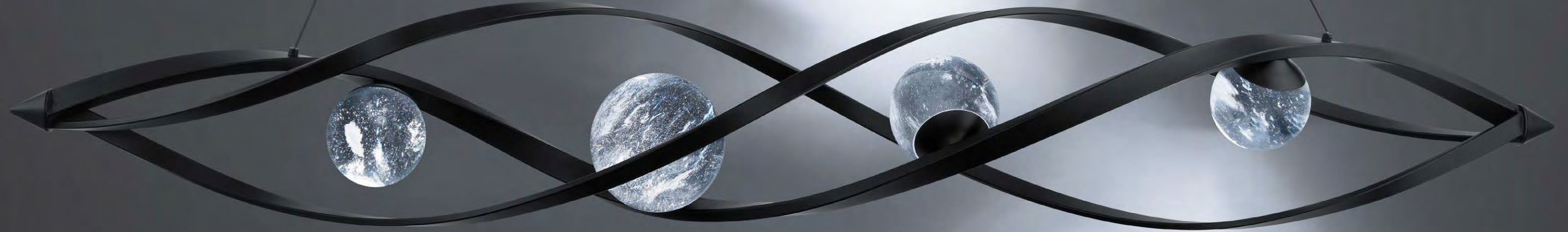

- Optic Haze Crystal is engineered from organic quartz rock crystal quarried from the Earth. Traces of natural elements create unique variations in luster, hue, patterning and texture when illuminated.
- Each hand selected piece features unique variations
- Built-in adjustable 3000K / 3500K / 4000K color temperature switch within the canopy
- Thin powered aircraft cables provide an ultra clean look for adjustable suspension height
- Spin-on round canopy with minimal hardware
- Thin canopy conceals a proprietary universal 120V-220V-277V driver
- Can be mounted on a sloped ceiling
- Dimmer: ELV, 0-10V, TRIAC

Finish



BK: Black

Crystal



Optic Haze Crystal

Model	Size	CCT	Voltage	Wattage	Weight	LED Lumens	Delivered Lumens
BPD50257	57"	3000K/3500K/4000K	120-277V	25W	21 lb	3550	1066

Example: BPD50257-BK

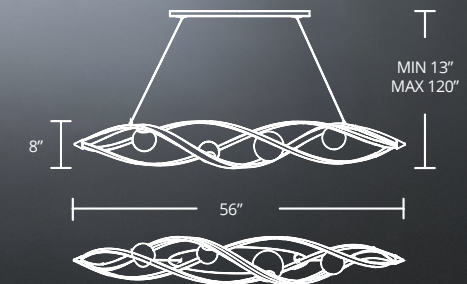

MOSAIC

Create a glamorous and edgy motif with Mosaic, a jewelry-inspired pendant. Over 60,000 pieces of hand-applied Radiance Crystal Dust covers the entire inner diffuser to provide the captivating sparkle of this modern crystal luminaire. A sculptural masterpiece to illuminate any table or surface in a home, hotel or office.



- Uses 60,000+ pieces of Radiance Crystal Dust fabricated for Schonbek in Europe
- Built-in adjustable 3000K / 3500K / 4000K color temperature switch within the canopy
- Thin powered aircraft cables provide an ultra clean look for adjustable suspension height
- Thin canopy conceals a proprietary universal 120V-220V-277V driver
- Spin-on round canopy with minimal hardware
- Can be mounted on a sloped ceiling
- Dimmer: ELV, TRIAC, 0-10V
- Patent pending design



Finish

BS: Black Stainless Steel

Crystal

Radiance Crystal Dust

Model	Size	CCT	Voltage	Wattage	Weight	LED Lumens	Delivered Lumens
BPD30230	31"	3000K/3500K/4000K	120-277V	40W	31 lb	3429	2746

Example: BPD30230-BS

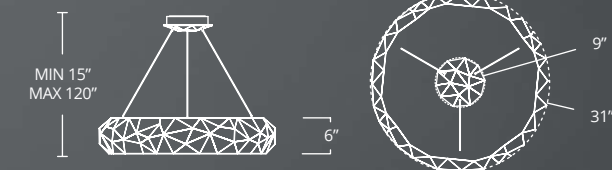

HIBISCUS

Height-adjustable, faceted crystal teardrop elements float in mid-air. Cascading from above and perfectly designed for illuminating foyers and dining tables while making a dramatic design statement in a range of residential and hospitality environments.



BPD21203-AB

BPD21205-PN



- Built-in adjustable 3000K / 3500K / 4000K color temperature switch within the canopy
- Thin powered aircraft cables provide an ultra clean look for adjustable suspension height
- Canopy conceals a proprietary universal 120V-220V-277V driver
- Can be mounted on a sloped ceiling
- Dimmer: ELV, TRIAC, 0-10V

Finish

- AB: Aged Brass
- BK: Black
- PN: Polished Nickel

Crystal

- Optic Crystal

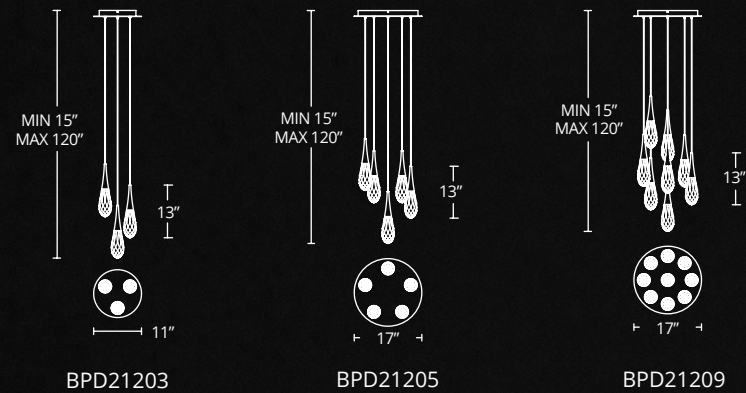

Model	# of Lights	CCT	Voltage	Wattage	Weight	LED Lumens	Delivered Lumens
BPD21203	3 lights			14W	15 lb	1170	1050
BPD21205	5 lights	3000K/3500K/4000K	120-277V	31W	28 lb	1950	1525
BPD21209	9 lights			55W	43 lb	3510	2745

Example: BPD21209-BK



LUNA

Thousands of hand-applied precision cut Radiance Crystal Dust shaped into glowing crescent silhouettes are captured within a sleek frame, rendering a fascinating abstract aesthetic that mesmerizes from above.



- Uses 30,000+ pieces of Radiance Crystal Dust fabricated for Schonbek in Europe
- Built-in adjustable 3000K / 3500K / 4000K color temperature switch within the canopy
- Thin canopy conceals a proprietary universal 120V-220V-277V driver
- Thin powered aircraft cables provide an ultra clean look for adjustable suspension height
- Slide-on rectangular canopy with minimal hardware
- Can be mounted on a sloped ceiling
- Dimmer: ELV, TRIAC, 0-10V

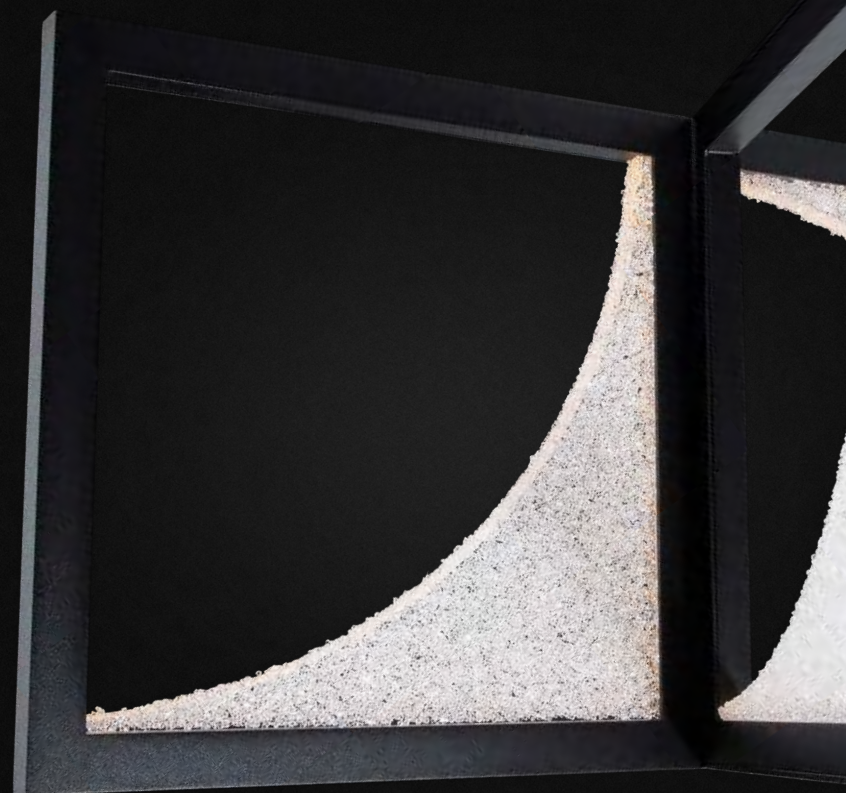

Finish

BK: Black

Crystal

Radiance™ Crystal Dust

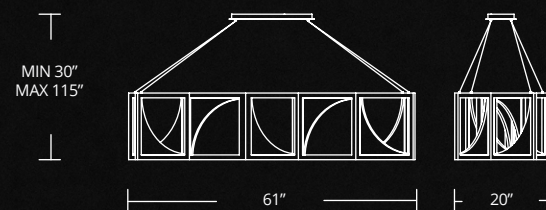

Model	Size	CCT	Voltage	Wattage	Weight	LED Lumens	Delivered Lumens
BPD94261	61"	3000K/3500K/4000K	120-277V	41.5W	38 lb	2367	1260

Example: BPD94261-BK



STARDUST

Shredding into myriad flickering fragments of light, over 70,000 pieces of hand-applied precision cut Radiance Crystal Dust bring captivating sparkle into the inner diffuser of this elegant dome luminaire.



- Three 12" and one 6" down rods included (additional sold separately)
- Thin canopy conceals a proprietary universal 120V-220V-277V driver
- Built-in adjustable 3000K / 3500K / 4000K color temperature switch within the canopy
- Spin-on round canopy with minimal hardware
- Hang straight swivel for slope ceiling adaptable
- Dimmer: ELV, 0-10V, TRIAC



Finish

- BK: Black
- PN: Polished Nickel

Crystal

- Radiance Crystal Dust

Model	Size	CCT	Voltage	Wattage	Weight	LED Lumens	Delivered Lumens
BPD19323	23"	3000K/3500K/4000K	120-277V	40W	31 lb	4500	3266

Example: BPD19323-BK

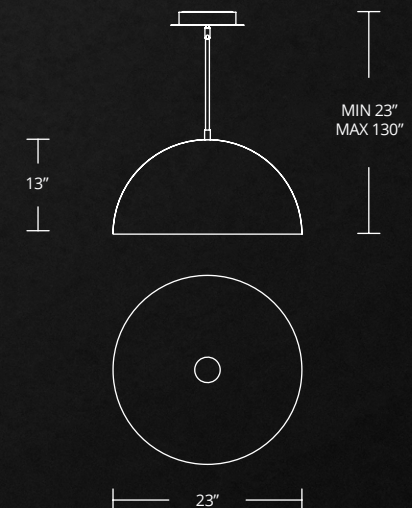

KINDJAL

A subtle twist of luxe. Kindjal is an exquisite Optic Crystal icicle that twists to a point from a cohesive metal fitting that conceals a powerful LED that provides ample downlighting. Stylish, textured materiality.



- Built-in adjustable 3000K / 3500K / 4000K color temperature switch within the canopy
- Thin powered aircraft cables provide an ultra clean look for adjustable suspension height
- Thin canopy conceals a proprietary driver
- Spin-on round canopy with minimal hardware
- Can be mounted on a sloped ceiling
- Dimmer: ELV, TRIAC
- Patent pending design



BPD13203-AB

BPD13218-PN



Finish

- AB: Aged Brass
- BK: Black
- PN: Polished Nickel

Crystal

- Optic Crystal

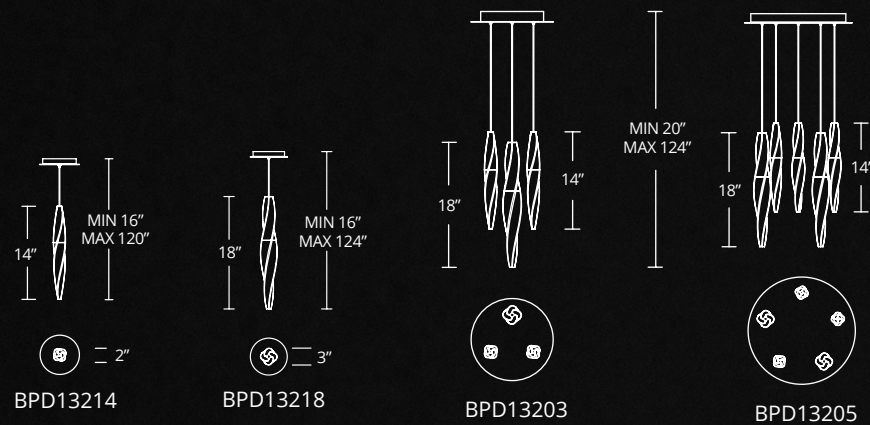

Model	# of Lights	CCT	Voltage	Wattage	Weight	LED Lumens	Delivered Lumens
BPD13214	1 light (14")	3000K/3500K/4000K	120/277V	9W	1 lb	630	398
BPD13218	1 light (18")		120/277V	9W	2 lb	630	440
BPD13203	3 lights		120-277V	24W	6 lb	1800	1200
BPD13205	5 lights		120-277V	41W	9 lb	3000	2000

Example: BPD13205-BK



KINDJAL

A subtle twist of luxe. Slender Optic Crystal icicles cascade from a sleek round canopy at different heights. From behind each crystal that twists down to a point, premium-quality LEDs illuminate spaces below.

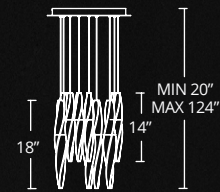

BPD13209

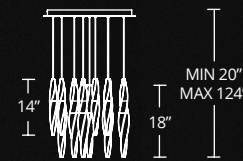

BPD13215



BPD13221



- Built-in adjustable 3000K / 3500K / 4000K color temperature switch within the canopy
- Thin powered aircraft cables provide an ultra clean look for adjustable suspension height
- Canopy conceals a proprietary universal 120V-220V-277V driver
- Can be mounted on a sloped ceiling
- Dimmer: ELV, TRIAC, 0-10V
- Patent pending design

Finish

- AB: Aged Brass
- BK: Black
- PN: Polished Nickel

Crystal

- Optic Crystal

Model	#of Lights	CCT	Voltage	Wattage	Weight	LED Lumens	Delivered Lumens
BPD13209	9 lights			72W	15 lb	5400	3600
BPD13215	15 lights	3000K/3500K/4000K	120-277V	118W	26 lb	9000	6000
BPD13221	21 lights			166W	35 lb	12600	8400

Example: BPD13221-PN



ENCHANTE

A lustrous combination of sleek metal and channel-set faceted crystal, Enchante is brought to life by LEDs integrated within the luminaire, creating a timeless luxe of beautiful, ambient lighting.



- Built-in adjustable 3000K / 3500K / 4000K color temperature switch within the canopy
- Six 12" and two 6" down rods included (additional sold separately)
- Thin canopy conceals a proprietary universal 120V-220V-277V driver
- Hang straight swivel for slope ceiling adaptable (sideways only)
- Slide-on rectangular canopy with minimal hardware
- Dimmer: ELV, 0-10V, TRIAC
- Patent pending design

Finish

- AB: Aged Brass
- BK: Black

Crystal

- Optic™ Crystal

Model	Size	CCT	Voltage	Wattage	Weight	LED Lumens	Delivered Lumens
BPD75243	43"	3000K/3500K/4000K	120-277V	43W	68 lb	1350	980

Example: BPD75243-BK

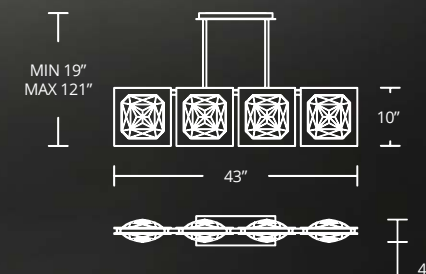

MARQUIS

A lighting experience like no other, Marquis invites you into a world of wonder between reality and illusion. A vision of infinity celebrates the human imagination and eclipses the limits of the mind with this interpretation of light and design using the emotive medium of Swarovski® Crystal.



- Built-in two set of CCT options when on dimmer: dim to warm from 2700K to 6500K or brightness dimming at 3500K fixed CCT
- Six 12" and two 6" down rods included (additional sold separately)
- Hang straight swivel
- Slide-on rectangular canopy with minimal hardware
- Thin canopy conceals a proprietary universal 120V-220V-277V driver
- Can be mounted on a sloped ceiling
- Dimmer: ELV, TRIAC, 0-10V

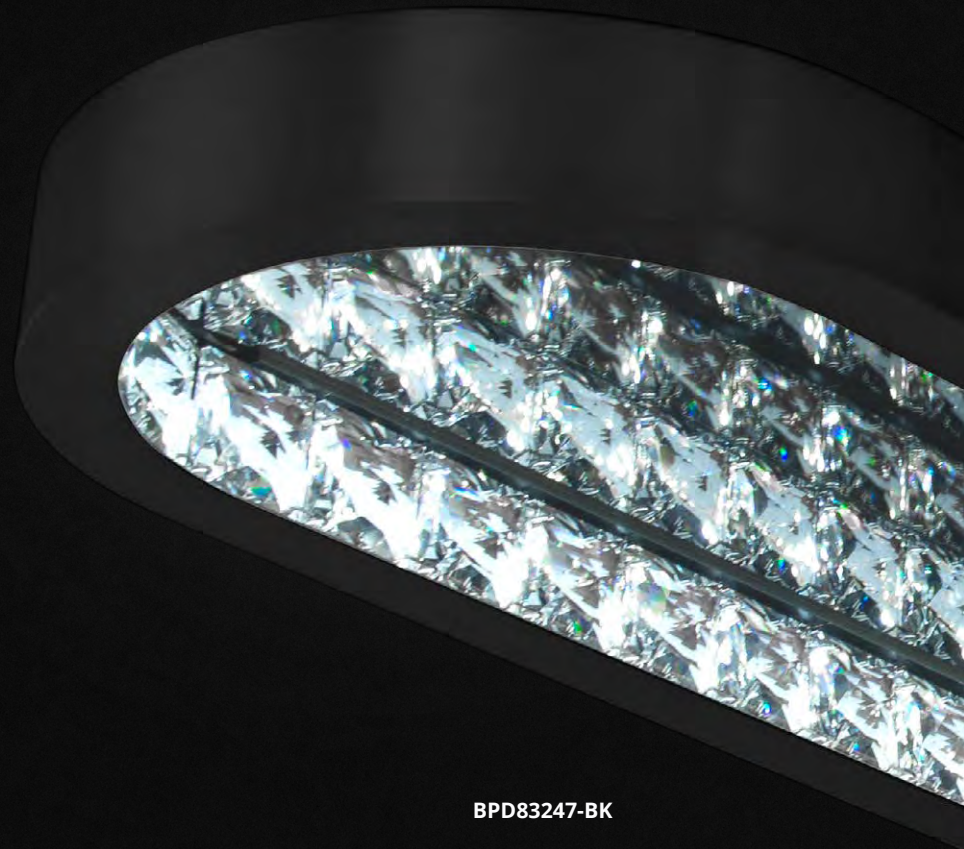

BPD83247-BK

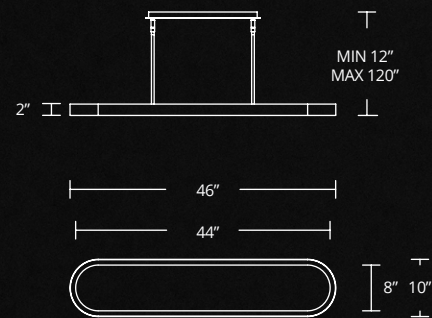

Finish

- AB: Aged Brass
- BK: Black

Crystal

- Swarovski® Crystal



Model	Size	CCT	Voltage	Wattage	Weight	LED Lumens	Delivered Lumens
BPD83247	46"	2700K-6500K	120-277V	88W	28 lb	6480	750

Example: BPD83247-AB





PENDANTS

Offering a new realm of artistry in crystal, our pendants sparkle with brilliance. Illuminated by LEDs that embody Schonbek's mastery of light and combining exquisite craftsmanship, cutting-edge technology and lustrous metals, these luminaires conjure a dazzling vision that transcends time to bring infinite beauty and wonder to the world of interiors.

DEVOTION

Framed silhouettes enhance this refined look featuring crystal tapers. An arousing mix of shapes and styles to elevate featured designs.



- Uses 1,000+ pieces of Radiance Crystal Dust fabricated for Schonbek in Europe
- Built-in adjustable 3000K / 3500K / 4000K color temperature switch within the canopy
- Thin canopy conceals a proprietary dual voltage 120V/277V driver
- Three 12" and one 6" down rods included (additional sold separately)
- Hang straight swivel
- Spin-on round canopy with minimal hardware
- Can be mounted on a sloped ceiling
- Dimmer: ELV, TRIAC

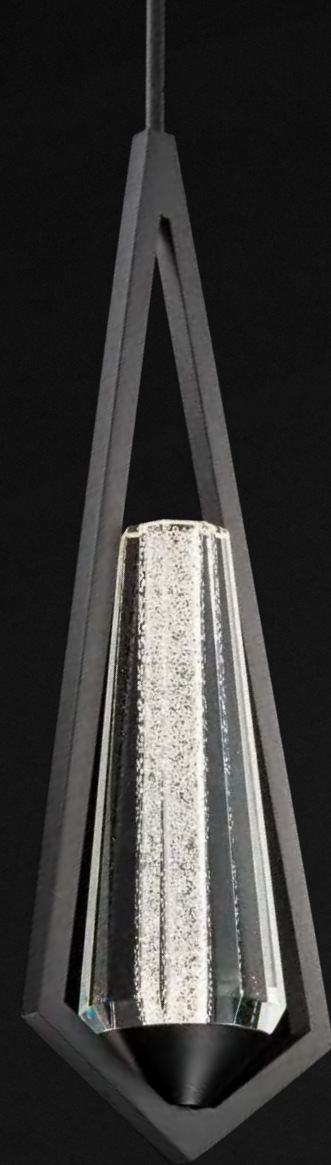

BPD66218-BK



BPD66218-AB

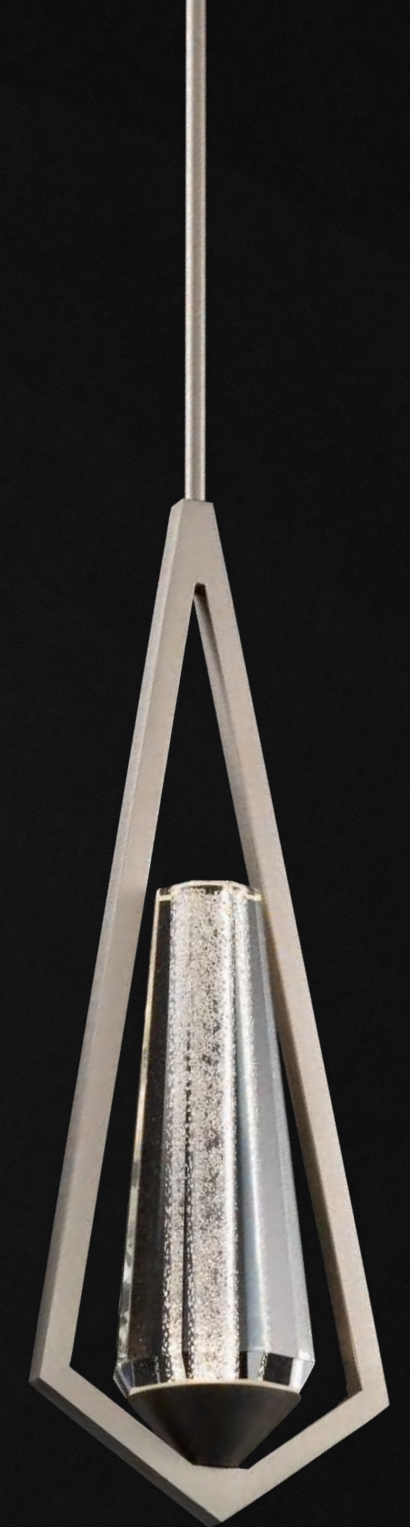

BPD66218-SN

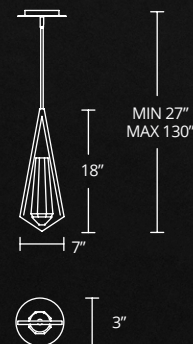

Finish

- AB: Aged Brass
- BK: Black
- SN: Satin Nickel

Crystal

- Radiance™ Crystal Dust

Model	Size	CCT	Voltage	Wattage	Weight	LED Lumens	Delivered Lumens
BPD66218	18"	3000K/3500K/4000K	120/277V	5W	6 lb	335	278

Example: BPD66218-AB



SOLAN

With a swirl of grace, Solan offers a touch of whimsy from hand-finished arms surrounding a glimmering column of clear Optic Crystal. Hidden LEDs create a scintillating play of light that changes like a kaleidoscope, constantly intriguing and fascinating.



- Built-in adjustable 3000K / 3500K / 4000K color temperature switch within the canopy
- Thin canopy conceals a proprietary dual voltage 120V/277V driver
- Optic Crystal accent spin-on round canopy with minimal hardware included
- Hang straight swivel for slope ceiling adaptable
- Three 12" and one 6" down rods included (additional sold separately)
- Dimmer: ELV, 0-10V, TRIAC



BPD23318-BK

Finish

 BK: Black

Crystal

 Optic Crystal

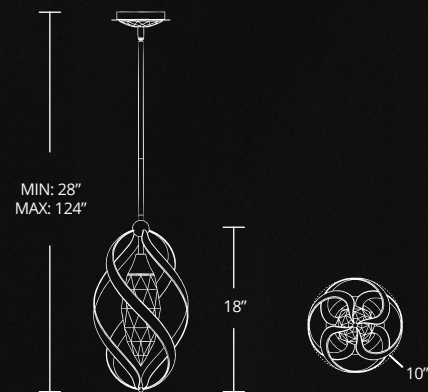

Model	Size	CCT	Voltage	Wattage	Weight	LED Lumens	Delivered Lumens
BPD23318	18"	3000K/3500K/4000K	120/277V	11W	13 lb	500	460

Example: BPD23318-BK



TRYST

A visual rendezvous creating a kiss of light. Optic Haze Crystal delivers mesmerizing LED illumination contrasted by rich dark leather, bringing focus to this partnership.



- Optic Haze Crystal is engineered from organic quartz rock crystal quarried from the Earth. Traces of natural elements create unique variations in luster, hue, patterning and texture when illuminated.
- Built-in adjustable 3000K / 3500K / 4000K color temperature switch within the canopy
- Thin canopy conceals a proprietary dual voltage 120V/277V driver and can be mounted on sloped ceiling
- Slide-on canopy with minimal hardware
- Thin powered aircraft cables provide an ultra clean look for adjustable suspension height
- Dimmer: ELV, TRIAC



BPD27321-BK

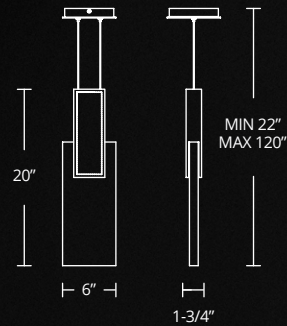

Finish

BK: Black

Crystal

Optic Haze Crystal



Model	Size	CCT	Voltage	Wattage	Weight	LED Lumens	Delivered Lumens
BPD27321	20"	3000K/3500K/4000K	120/277V	11W	11 lb	428	253

Example: BPD27321-BK



FAZZOLETTO

Filled with the light of imagination, faceted Optic Clear crystal presents a multi-layered depth. LED illumination creates infinite sparkling reflections from this jewel-like pendant with a glittering crystal canopy.



- Three 12" and one 6" down rods included (additional sold separately)
- Built-in adjustable 3000K / 3500K / 4000K color temperature switch within the canopy
- Thin canopy conceals a proprietary dual voltage 120V/277V driver
- Spin-on round canopy with minimal hardware
- Can be mounted on a sloped ceiling
- Dimmer: ELV, TRIAC



BPD33315-BK



Finish

- AB: Aged Brass
- BK: Black

Crystal

- Optic Crystal

Model	Size	CCT	Voltage	Wattage	Weight	LED Lumens	Delivered Lumens
BPD33315	15"	3000K/3500K/4000K	120/277V	9W	16 lb	450	372

Example: BPD33315-AB



STRAPPED

Mixed materials devise a textured aesthetic. A single brilliant Optic Haze Crystal pendant suspended from leather strapping and chrome reflects light in all directions. The sparkle is enhanced by a crystal-encrusted canopy.



- Optic Haze is thoughtfully engineered from quartz rock crystal with traces of natural elements found on Earth. Each organic element illuminates beautifully to entice and radiate with its natural and unique, inherent variations in luster, hue, patterning and texture.
- Built-in adjustable 3000K / 3500K / 4000K color temperature switch within the canopy
- Thin canopy conceals a proprietary dual voltage 120V/277V driver and can be mounted on sloped ceiling
- Leather suspension belt can be trimmed to customized length
- Illuminated crystal haze accent on the canopy
- Dimmer: ELV, TRIAC



BPD36312-PN



Finish

PN: Polished Nickel

Crystal

Optic Haze Crystal

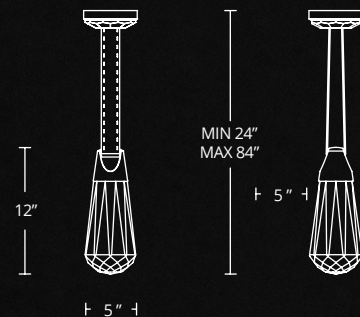

Model	Size	CCT	Voltage	Wattage	Weight	LED Lumens	Delivered Lumens
BPD36312	12"	3000K/3500K/4000K	120/277V	16W	12 lb	1005	771

Example: BPD36312-PN



WONDER

A singular faceted crystal is channel set simply and illuminated internally by hidden LED sources to offer a blissful charm. Introduce a simple elegance to any space from baths to reception areas.



BPD38210-PN



- Built-in adjustable 3000K / 3500K / 4000K color temperature switch within the canopy
- Thin canopy conceals a proprietary dual voltage 120V/277V driver
- Three 12" and one 6" down rods included (additional sold separately)
- Hang straight swivel
- Spin-on round canopy with minimal hardware
- Can be mounted on a sloped ceiling
- Dimmer: ELV, TRIAC

Finish

- BK: Black
- PN: Polished Nickel

Crystal

- Optic Crystal

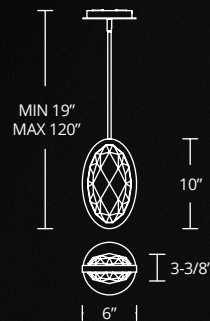

Model	Size	CCT	Voltage	Wattage	Weight	LED Lumens	Delivered Lumens
BPD38210	10"	3000K/3500K/4000K	120/277V	15W	10 lb	785	416

Example: BPD38210-BK



PRIMROSE

Surpass the ordinary with this punctuated minimalist conical pendant. A faceted Optic Crystal shade within the matte black outer shade converges on a top-of-the-line LED light source for an exquisite delight.



BPD34208-CH



- Built-in adjustable 3000K / 3500K / 4000K color temperature switch within the canopy
- Uses 1,200+ pieces of Radiance Crystal Dust fabricated for Schonbek in Europe
- Thin powered aircraft cables provide an ultra clean look for adjustable suspension height
- Thin canopy conceals a proprietary dual voltage 120V/277V driver
- Spin-on round canopy with minimal hardware
- Can be mounted on a sloped ceiling
- Dimmer: ELV, TRIAC

Finish

BK: Black

CH: Chrome

Crystal

Optic Crystal

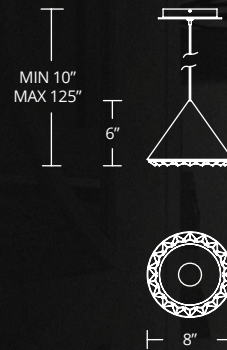

Model	Size	CCT	Voltage	Wattage	Weight	LED Lumens	Delivered Lumens
BPD34208	8"	3000K/3500K/4000K	120/277V	13W	3 lb	512	382

Example: BPD34208-BK



CRU

Appealing to your sensibility, this sculpted Optic Crystal design evokes a dimensional look of fluidity. Install Cru in groups to feature tables or draw circulation towards reception areas. Matching sconce available. A clear cylinder touched by a little grace.



- Built-in adjustable 3000K / 3500K / 4000K color temperature switch within the canopy
- Thin canopy conceals a proprietary dual voltage 120V/277V driver
- Three 12" and one 6" down rods included (additional sold separately)
- Hang straight swivel
- Spin-on round canopy with minimal hardware
- Can be mounted on a sloped ceiling
- Dimmer: ELV, TRIAC
- Patent pending design



BPD14214-PN

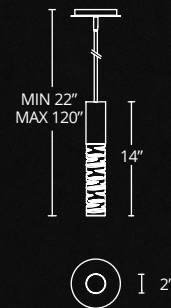

Finish

● PN: Polished Nickel

Crystal

● Optic Crystal

Model	Size	CCT	Voltage	Wattage	Weight	LED Lumens	Delivered Lumens
BPD14214	14"	3000K/3500K/4000K	120/277V	8W	6 lb	600	439

Example: BPD14214-PN



HIBISCUS

Crystal fashion comes to light in unique forms. Delicate, graceful drops of exquisite crystal embraced by tapered metal forms that glow with a charming lustre. Matching crystal overlays are applied to the metal canopies for an additional touch of luxury.



- Built-in adjustable 3000K / 3500K / 4000K color temperature switch within the canopy
- Thin powered aircraft cables provide an ultra clean look for adjustable suspension height
- Thin canopy conceals a proprietary dual voltage 120/277V driver
- Spin-on round canopy with minimal hardware
- Can be mounted on a sloped ceiling
- Dimmer: ELV, TRIAC

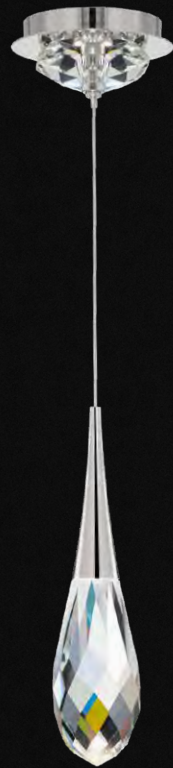

BPD21213-PN



BPD21213-BK

Finish

- AB: Aged Brass
- BK: Black
- PN: Polished Nickel

Crystal

- Optic Crystal



BPD21213

Model	# of Lights	CCT	Voltage	Wattage	Weight	LED Lumens	Delivered Lumens
BPD21213	1 light (13")	3000K/3500K/4000K	120/277V	6.5W	6 lb	305	247

Example: BPD21213-AB





QUEST

Crystal ball patterned to offer enhanced illumination. This Schonbek Optic Haze Crystal sphere projects omnidirectional high quality LED illumination for an astonishing, graceful aesthetic. Specify Quests in a row to create a timeless elegance.



- Optic Haze Crystal is engineered from organic quartz rock crystal quarried from the Earth. Traces of natural elements create unique variations in luster, hue, patterning and texture when illuminated.
- Each hand selected piece features unique variations
- Built-in adjustable 3000K / 3500K / 4000K color temperature switch within the canopy
- Thin canopy conceals a proprietary dual voltage 120V/277V driver
- Three 12" and one 6" down rods included (additional sold separately)
- Hang straight swivel
- Spin-on round canopy with minimal hardware
- Can be mounted on a sloped ceiling
- Dimmer: ELV, TRIAC

Finish

-  AB: Aged Brass
-  BK: Black
-  BN: Brushed Nickel

Crystal

-  Optic Haze Crystal



BPD40206-BN

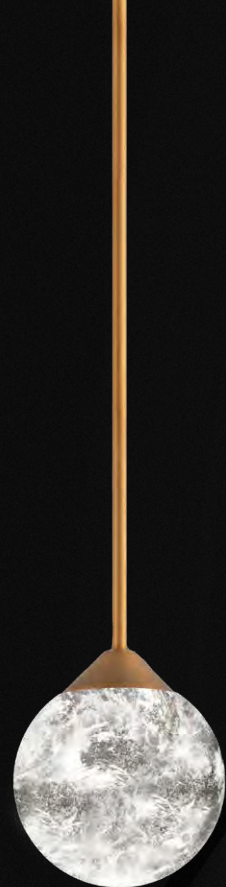

BPD40206-AB

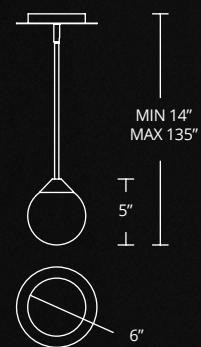

Model	Size	CCT	Voltage	Wattage	Weight	LED Lumens	Delivered Lumens
BPD40206	6"	3000K/3500K/4000K	120/277V	5W	7 lb	335	325

Example: BPD40206-BK



MARTINI

Suspended in mid-air, a jewel of Schonbek Optic and Optic Haze Crystal composed of natural quartz gemstone illuminates to entice. The chiseled metal fitting is congruent with the faceted crystal to confer elegance in design continuity.



BPD202070-BK



BPD202070-PN



- Optic Haze Crystal is engineered from organic quartz rock crystal quarried from the Earth. Traces of natural elements create unique variations in luster, hue, patterning and texture when illuminated.
- Built-in adjustable 3000K / 3500K / 4000K color temperature switch within the canopy
- Thin powered aircraft cables provide an ultra clean look for adjustable suspension height
- Thin canopy conceals a proprietary dual voltage 120V/277V driver
- Spin-on round canopy with minimal hardware
- Optional decorative diamond texture diffuser is included to be installed to customer preference
- Can be mounted on a sloped ceiling
- Dimmer: ELV, TRIAC

Finish

- AB: Aged Brass
- BK: Black
- PN: Polished Nickel

Crystal

- Optic Crystal
- Optic Haze Crystal



Model	# of Lights	CCT	Voltage	Wattage	Weight	LED Lumens	Delivered Lumens
BPD20207	1 light	3000K/3500K/4000K	120/277V	8W	4 lb	657	UP TO 506

Example: BPD202070H-AB





INDOOR SCONCES

Reimagine iconic abstract crystal designs with an exquisite touch of elegance that speaks directly to true luxury. Unique and sophisticated forms create comfortable ambient illumination throughout corridors and upscale spaces. Luxurious artisanal metals embrace sumptuous crystal elements for the finest in wall luminaires.

TRYST

A visual rendezvous creating a kiss of light. Optic Haze Crystal delivers mesmerizing LED illumination contrasted by rich dark leather, bringing focus to this partnership.



BWS27320-BK



- Optic Haze Crystal is engineered from organic quartz rock crystal quarried from the Earth. Traces of natural elements create unique variations in luster, hue, patterning and texture when illuminated.
- Built-in adjustable 3000K / 3500K / 4000K color temperature switch
- No driver or transformer required
- Ambient and down illumination
- Dimmer: ELV, TRIAC

Finish

 BK: Black

Crystal

 Optic Haze Crystal

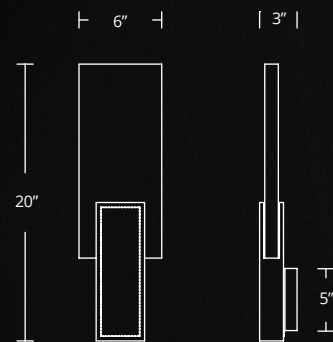

Model	Size	CCT	Voltage	Wattage	Weight	LED Lumens	Delivered Lumens
BWS27320	20"	3000K/3500K/4000K	120V	15W	9 lb	686	617

Example: BWS27320-BK



KINDJAL

A subtle twist of luxe. Kindjal is an exquisite Optic Crystal icicle that twists to a point from a cohesive metal casting that conceals a powerful LED that provides ample illumination. Stylish, textured materiality.



- Built-in adjustable 3000K / 3500K / 4000K color temperature switch
- Thin canopy conceals a proprietary universal 120V-220V-277V driver
- Ambient and down illumination
- Dimmer: ELV, TRIAC, 0-10V
- Patent pending design

Finish

- AB: Aged Brass
- BK: Black
- PN: Polished Nickel

Crystal

- Optic Crystal



BWS13218-BK



BWS13218-PN

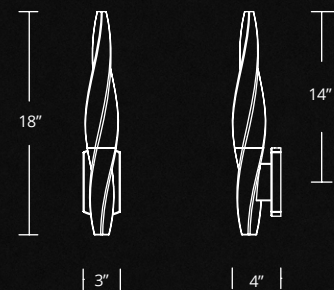

Model	Size	CCT	Voltage	Wattage	Weight	LED Lumens	Delivered Lumens
BWS13218	18"	3000K/3500K/4000K	120-277V	12W	3 lb	900	502

Example: BWS13218-AB



SOLITUDE

Luxuriously crafted and beautifully designed to add dramatic character to any space, a spear of Optic Haze Crystal composed of natural quartz gemstone illuminates and gravitates with bolts of luminous energy.



- Optic Haze Crystal is engineered from organic quartz rock crystal quarried from the Earth. Traces of natural elements create unique variations in luster, hue, patterning and texture when illuminated.
- Built-in adjustable 3000K / 3500K / 4000K color temperature switch
- Thin canopy conceals a proprietary dual voltage 120V/277V driver
- Dimmer: ELV, TRIAC



BWS31229-AB

BWS31232-PN

Finish

- AN: Antique Nickel
- AB: Aged Brass

Crystal

- Optic Haze Crystal

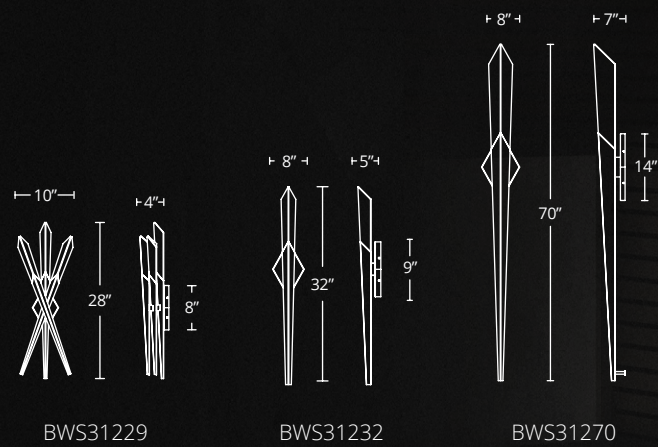

BWS31229

BWS31232

BWS31270

Model	Size	CCT	Voltage	Wattage	Weight	LED Lumens	Delivered Lumens
BWS31229	29"			15W	7 lb	900	675
BWS31232	32"	3000K/3500K/4000K	120/277V	21W	4 lb	1236	900
BWS31270	70"			28W	21 lb	1650	1242

Example: BWS31270-AN



MIRAGE

A sparkling array of diamond-shaped Optic Crystals shimmer within an angular silhouette. Each faceted crystal is brightly illuminated, creating a magnificent and thought-provoking effect.



- Inner mirror grade backing plate
- Built-in adjustable 3000K / 3500K / 4000K color temperature switch
- Thin canopy conceals a proprietary universal 120V-220V-277V driver
- Dimmer: ELV, TRIAC, 0-10V



BWS16216-BK

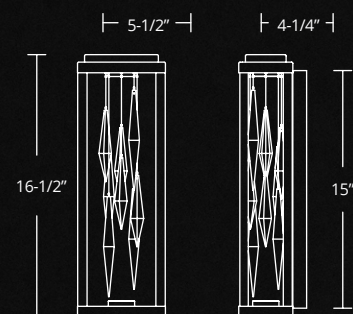

Finish

○ BK: Black

Crystal

● Optic Crystal



Model	Size	CCT	Voltage	Wattage	Weight	LED Lumens	Delivered Lumens
BWS16216	17"	3000K/3500K/4000K	120-277V	12W	7 lb	562	171

Example: BWS16216-BK



MAGNATE

Monumentally unique and sophisticated. A bold façade conceals LEDs that illuminate the Schonbek Optic Haze Crystal engineered from natural quartz.



BWS71216-BK



- Optic Haze Crystal is engineered from organic quartz rock crystal quarried from the Earth. Traces of natural elements create unique variations in luster, hue, patterning and texture when illuminated.
- Each hand selected piece features unique variations
- Built-in adjustable 3000K / 3500K / 4000K color temperature switch
- Thin canopy conceals a proprietary universal 120V-220V-277V driver
- Dimmer: ELV, TRIAC, 0-10V

Finish

 BK: Black

Crystal

 Optic Haze Crystal

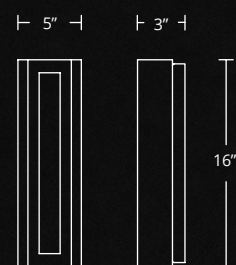

Model	Size	CCT	Voltage	Wattage	Weight	LED Lumens	Delivered Lumens
BWS71216	16"	3000K/3500K/4000K	120-277V	24W	13 lb	1765	384

Example: **BWS71216-BK**



HELIOS

A brilliant façade punctuated with faceted Optic Crystals like a series of symmetric windows. An exquisite touch of simple elegance speaking luxury.



- Built-in adjustable 3000K / 3500K / 4000K color temperature switch
- Thin canopy conceals a proprietary dual voltage 120V/277V driver
- Ambient and down illumination
- Dimmer: ELV, TRIAC



BWS15214-BK

Finish

● AB: Aged Brass

○ BK: Black

Crystal

● Optic Crystal

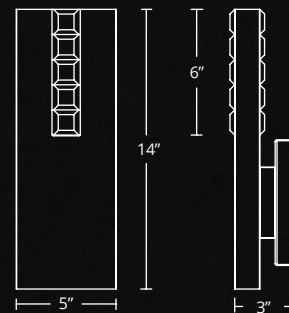

Model	Size	CCT	Voltage	Wattage	Weight	LED Lumens	Delivered Lumens
BWS15214	14"	3000K/3500K/4000K	120/277V	15W	6 lb	720	605

Example: BWS15214-AB



GLACIO

Accentuating the veining in its Schonbek Optic Haze Crystal, LEDs highlight the unique patterning found throughout, offering comfortable ambient illumination and an ethereal quality.



- Optic Haze Crystal is engineered from organic quartz rock crystal quarried from the Earth. Traces of natural elements create unique variations in luster, hue, patterning and texture when illuminated.
- Each hand selected piece features unique variations
- Built-in adjustable 3000K / 3500K / 4000K color temperature switch
- No driver or transformer required
- Dimmer: ELV, TRIAC



BWS73214-BK



Finish

BK: Black

Crystal

Optic Haze Crystal

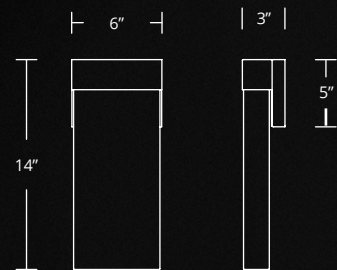

Model	Size	CCT	Voltage	Wattage	Weight	LED Lumens	Delivered Lumens
BWS73214	14"	3000K/3500K/4000K	120V	11W	13 lb	553	438

Example: **BWS73214-BK**



ECHELON

A faceted abstract design of solid Optic Crystal. Hidden LEDs illuminate the crystal internally and also provide downlight for wayfinding on this interior wall sconce.



BWS10224-PN



- Built-in adjustable 3000K / 3500K / 4000K color temperature switch
- Ambient and down light illumination
- No driver or transformer required
- Can be mounted on wall in all orientations
- Dimmer: ELV, TRIAC
- Patent pending design

Finish

- BK: Black
- PN: Polished Nickel

Crystal

- Optic Crystal

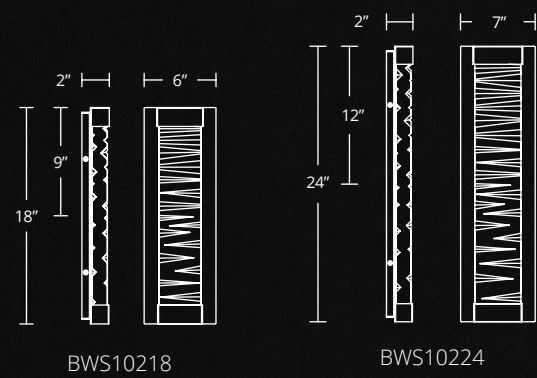

BWS10218

BWS10224

Model	Size	CCT	Voltage	Wattage	Weight	LED Lumens	Delivered Lumens
BWS10218	18"	3000K/3500K/4000K	120V	11W	13 lb	490	387
BWS10224	24"	3000K/3500K/4000K	120V	17W	19 lb	593	513

Example: BWS10218-BK



MADISON

Shining like an eye catching princess-cut diamond. A feature faceted Swarovski® Crystal accent is internally illuminated to create a refractive effect on the wall. Additional downward LEDs provide wayfinding illumination. Handsome in black, white and titanium. A bright jewel box.

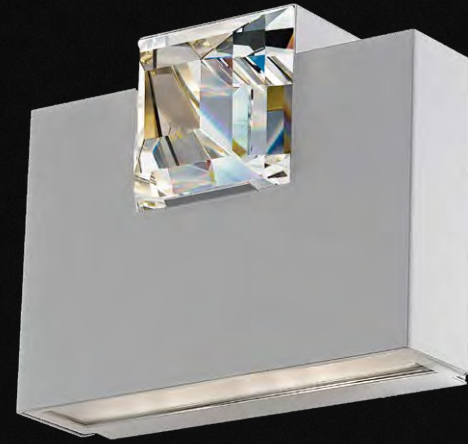

BWS90209-TT



- Built-in adjustable 3000K / 3500K / 4000K color temperature switch
- Thin canopy conceals a proprietary dual voltage 120V/277V driver
- Ambient and down illumination
- Dimmer: ELV, TRIAC

Finish

- BK: Black
- TT: Titanium
- WT: White

Crystal

- Swarovski® Crystal

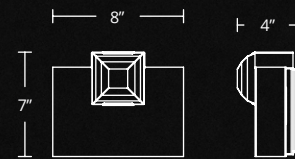

Model	Size	CCT	Voltage	Wattage	Weight	LED Lumens	Delivered Lumens
BWS90209	8"	3000K/3500K/4000K	120/277V	11W	5 lb	1024	440

Example: BWS90209-BK



FRAGMENT

Enjoy indirect illumination from this modern wall or ceiling element. LEDs illuminate its stunning shatter patterned reclaimed crystal.

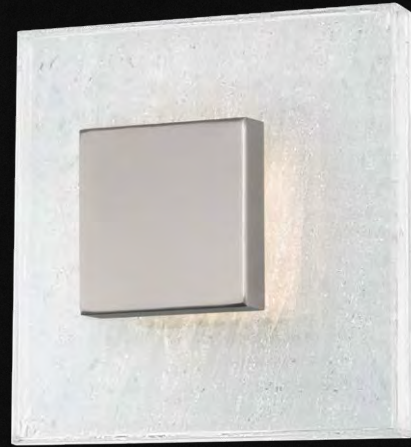

BWS70208-BN



- Built-in adjustable 3000K / 3500K / 4000K color temperature switch
- No driver or transformer required
- Can be mounted on wall in all orientations
- Dimmer: ELV, TRIAC

Finish

-  BK: Black
-  BN: Brushed Nickel

Crystal

-  Optic Haze Crystal

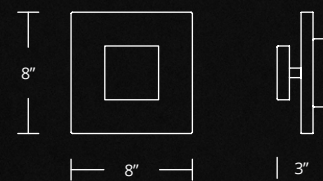

Model	Size	CCT	Voltage	Wattage	Weight	LED Lumens	Delivered Lumens
BWS70208	8"	3000K/3500K/4000K	120V	17W	6 lb	1275	405

Example: BWS70208-BK



CRU

Appealing to your sensibility, this sculpted Optic Crystal sconce design evokes a dimensional look of fluidity. A clear cylinder touched by a little grace. Robust functional downlight for illuminating surfaces below. Matching pendant and vanity available.



- Built-in adjustable 3000K / 3500K / 4000K color temperature switch
- Thin canopy conceals a proprietary dual voltage 120V/277V driver
- Ambient and down illumination
- Dimmer: ELV, TRIAC
- Patent pending design



BWS14214-PN

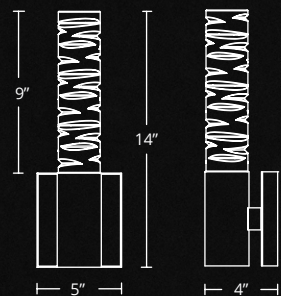

Finish

PN: Polished Nickel

Crystal

Optic Crystal

Model	Size	CCT	Voltage	Wattage	Weight	LED Lumens	Delivered Lumens
BWS14214	14"	3000K/3500K/4000K	120/277V	15W	7 lb	912	691

Example: BWS14214-PN





BATH/VANITY

Sleek, spectacular, unique and fully functional. Indulge in sophisticated chiseled crystal designs that will transform your bath into your own personal sanctuary and showcase remarkable details and craftsmanship. Appealing to your sensibilities, sculpted crystal designs deliver flattering ambient and task illumination above a vanity or mirror.

GUILD

A chiseled look of refinement highlights remarkable details, hand craftsmanship and sparkling Optic Crystal in this luxurious bath luminaire.



- Built-in adjustable 3000K / 3500K / 4000K color temperature switch
- Can be mounted on wall in all orientations
- Proprietary universal 120V-220V-277V driver concealed within canopy
- Dimmer: ELV, TRIAC, 0-10V
- Patent pending design



BWS11226-BK

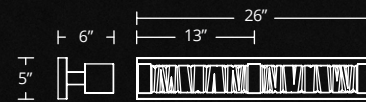

BWS11226

Finish

- BK: Black
- CH: Chrome

Crystal

- Optic Crystal

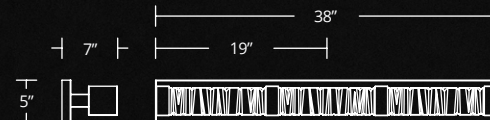

BWS11238

Model	Size	CCT	Voltage	Wattage	Weight	LED Lumens	Delivered Lumens
BWS11226	26"	3000K/3500K/4000K	120-277V	30W	28 lb	2207	1161
BWS11238	38"	3000K/3500K/4000K	120-277V	42W	41 lb	2910	2124

Example: BWS11238-CH



SOIREE

Spectacular and unique, hand-applied Radiance Crystal Dust releases its brilliance in a constant play of light, providing the perfect fusion of form and function for upscale interiors.



- Delicate hand-applied clear and AB (Aurora Borealis) color European Radiance grade precision-cut crystals
- Uses 4,600+(28") and 6,200+ (37") respectively pieces of Radiance Crystal Dust fabricated for Schonbek in Europe
- Built-in adjustable 3000K / 3500K / 4000K color temperature switch
- Thin canopy conceals a proprietary universal 120V-220V-277V driver
- Can be mounted on wall in all orientations
- Dimmer: ELV, TRIAC, 0-10V
- Patent pending design

Finish

- AB: Aged Brass
- PN: Polished Nickel

Crystal

- Radiance Crystal Dust



BWS17228-PN

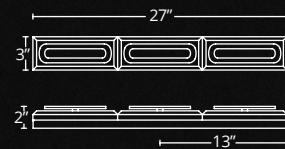

BWS17228

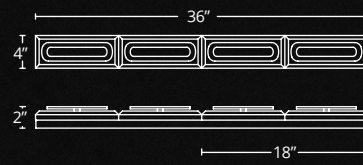

BWS17236

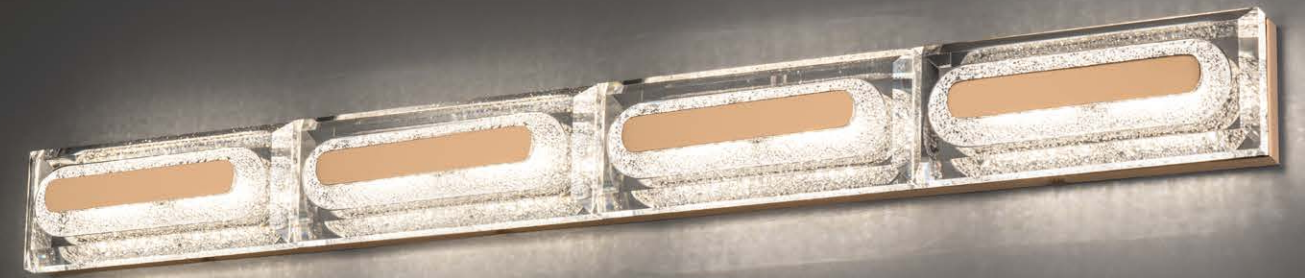

Model	Size	CCT	Voltage	Wattage	Weight	LED Lumens	Delivered Lumens
BWS17228	27"	3000K/3500K/4000K	120-277V	20W	10 lb	1500	826
BWS17236	36"	3000K/3500K/4000K	120-277V	30W	14 lb	2300	1806

Example: BWS17236-AB



KINDJAL

A subtle twist of luxe. Kindjal features exquisite Optic Crystal icicles that twist to a point from a cohesive metal fitting, concealing powerful LEDs which provide ample illumination. Stylish, textured materiality.



- Built-in adjustable 3000K / 3500K / 4000K color temperature switch
- A proprietary universal 120V-220V-277V driver to be installed in junction box.
- Can be mounted on wall in all orientations
- Dimmer: ELV, TRIAC, 0-10V
- Patent pending design

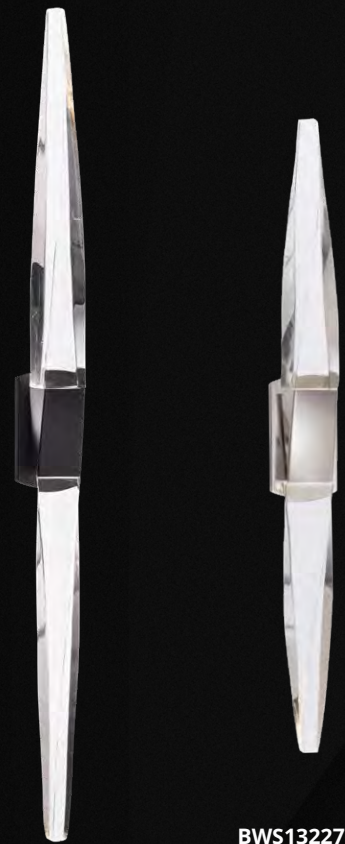

BWS13237-BK

BWS13227-PN

Finish

AB: Aged Brass

BK: Black

PN: Polished Nickel

Crystal

Optic Crystal

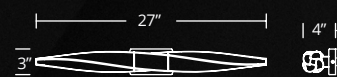

BWS13227

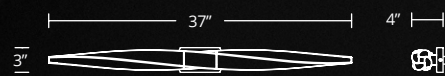

BWS13237

Model	Size	CCT	Voltage	Wattage	Weight	LED Lumens	Delivered Lumens
BWS13227	27"	3000K/3500K/4000K	120-277V	16W	4 lb	1260	875
BWS13237	37"	3000K/3500K/4000K	120-277V	16W	5 lb	1260	881

Example: BWS13227-AB



VERANDAH

A stunning bath sconce for the ages commands attention with V-cut channels precisely hand-applied with Schonbek Radiance Crystal Dust. This ADA Compliant luminaire may be mounted vertically and horizontally as a vanity light or wall sconce.

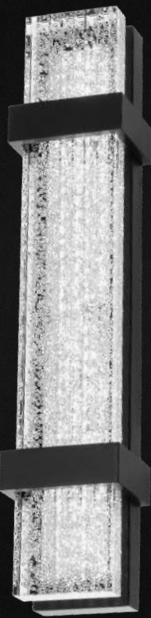

BWS18218-BK



- Uses 4,300+ (18"), 6,200+ (27") and 8,600 (37") respectively pieces of Radiance Crystal Dust fabricated for Schonbek in Europe
- Built-in adjustable 3000K / 3500K / 4000K color temperature switch
- No driver or transformer required
- Can be mounted on wall in all orientations
- Dimmer: ELV, TRIAC

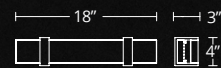

BWS18218



BWS18227

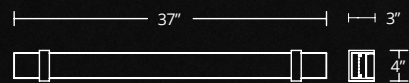

BWS18237

Finish

AB: Aged Brass

BK: Black

CH: Chrome

Crystal

Radiance Crystal Dust



Model	Size	CCT	Voltage	Wattage	Weight	LED Lumens	Delivered Lumens
BWS18218	18"			29W	4 lb	1850	1650
BWS18227	27"	3000K/3500K/4000K	120V	33W	5 lb	2700	2300
BWS18237	37"			50W	7 lb	3800	3400

Example: BWS18218-AB



ABERDEEN

A sleek modern LED luminaire with clean lines and crisp styling. Reclaimed crystal in a shattered pattern delivers ample ambient task illumination for both residential and commercial settings. Offered in both brushed nickel and black finishes. Luxury is in the details.



BWS78228-BN



- Built-in adjustable 3000K / 3500K / 4000K color temperature switch
- No driver or transformer required
- Can be mounted on wall in all orientations
- Dimmer: ELV, TRIAC
- Patent pending design

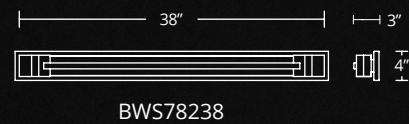
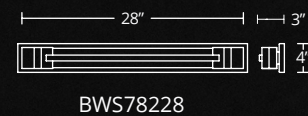

Finish

- BK: Black
- BN: Brushed Nickel



Model	Size	CCT	Voltage	Wattage	Weight	LED Lumens	Delivered Lumens
BWS78228	28"	3000K/3500K/4000K	120V	18W	4 lb	1200	530
BWS78238	38"	3000K/3500K/4000K	120V	24W	6 lb	1700	750

Example: BWS78228-BN



CHANDLER

Accentuate a modern bath with a geometric work of art. LEDs concealed within the frame illuminate dimensional blocks of translucent Optic Haze Crystal, making this luminaire a dramatic option to light a vanity.



- Optic Haze Crystal is engineered from organic quartz rock crystal quarried from the Earth. Traces of natural elements create unique variations in luster, hue, patterning and texture when illuminated.
- Each hand selected piece features unique variations
- Built-in adjustable 3000K / 3500K / 4000K color temperature switch
- No driver or transformer required
- Can be mounted on wall vertically or upside down
- Dimmer: ELV, TRIAC

Finish

BK: Black

Crystal

Optic Haze Crystal

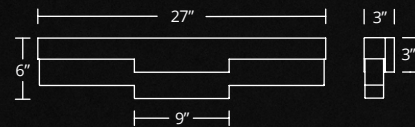

Model	Size	CCT	Voltage	Wattage	Weight	LED Lumens	Delivered Lumens
BWS79227	27"	3000K/3500K/4000K	120V	32W	19 lb	1623	1502

Example: BWS79227-BK



CRU

Appealing to your sensibility, this sculpted Optic Crystal design evokes a dimensional look of fluidity. Two clear cylinders touched by a little grace. Matching pendant, sconce and vanity also available.



- Built-in adjustable 3000K / 3500K / 4000K color temperature switch
- Can be mounted on wall in all orientations
- Thin canopy conceals a proprietary dual voltage 120V/277V driver
- Dimmer: ELV, TRIAC
- Patent pending design

Finish

● PN: Polished Nickel

Crystal

● Optic Crystal

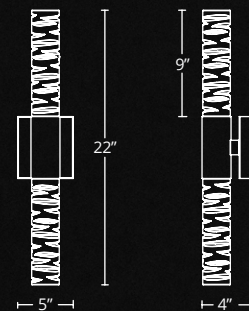

Model	Size	CCT	Voltage	Wattage	Weight	LED Lumens	Delivered Lumens
BWS14222	22"	3000K/3500K/4000K	120/277V	15W	10 lb	912	782

Example: BWS14222-PN





FLUSH MOUNTS

Elegance, dramatic and distinctive. Sophisticated geometric forms create a soft, welcoming glow from premium LEDs. These lustrous beauties are ravishing and brilliant, like illuminated jewels for the home, offering a crescendo of style and craftsmanship excellence.

ENCHANTE

A lustrous combination of sleek metal and channel-set faceted crystal, Enchante is brought to life by LEDs integrated within the luminaire, creating a timeless luxe of beautiful, ambient lighting.



BFM75210-AB

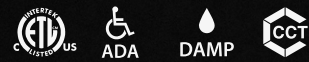

- Built-in adjustable 3000K / 3500K / 4000K color temperature switch within the canopy
- Thin canopy conceals a proprietary universal 120V-220V-277V driver
- Slide-on canopy with minimal hardware
- Can be mounted on ceiling or wall in all orientations
- Dimmer: ELV, 0-10V, TRIAC
- Patent pending design

Finish

● AB: Aged Brass

○ BK: Black

Crystal

● Optic Crystal

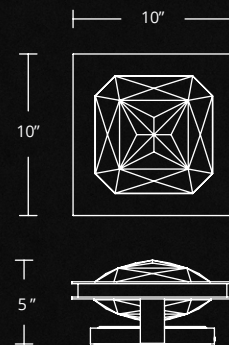

Model	Size	CCT	Voltage	Wattage	Weight	LED Lumens	Delivered Lumens
BFM75210	10"	3000K/3500K/4000K	120-277V	30W	18 lb	500	360

Example: BFM75210-BK





MELANGE

A modern round form with an artistic shade of Schonbek Optic Haze Crystal delivers a soft, welcoming glow from premium quality LEDs. This lovely ceiling mount projects from a stepped hardware frame.



- Unique hazy quartz crystal diffuser filled with 3,600 pieces of Radiance Crystal Dust fabricated for Schonbek in Europe
- Each hand selected piece features unique variations
- Built-in adjustable 3000K / 3500K / 4000K color temperature switch within the canopy
- No driver or transformer required
- Can be mounted on ceiling or wall in all orientations
- Dimmer: ELV, TRIAC

Finish

-  AB: Aged Brass
-  BK: Black
-  BN: Brushed Nickel

Crystal

-  Optic Haze Crystal

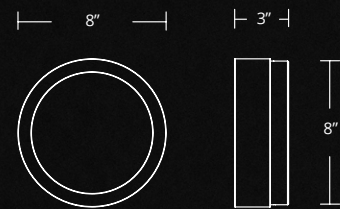

Model	Size	CCT	Voltage	Wattage	Weight	LED Lumens	Delivered Lumens
BFM61208	8"	3000K/3500K/4000K	120V	15W	8 lb	1501	1169

Example: **BFM61208-BK**



CARAT

Ravishing, multifaceted and as brilliant as an engagement ring. Thick Schonbek Optic Crystal creates an impressive textured glass inner shade embraced by a chiseled complementary frame. High quality LEDs deploy optimal ambient illumination.



- Built-in adjustable 3000K / 3500K / 4000K color temperature switch within the canopy
- Thin canopy conceals a proprietary universal 120V-220V-277V driver
- Can be mounted on ceiling or wall in all orientations
- Dimmer: ELV, TRIAC, 0-10V
- Patent pending design

Finish

PN: Polished Nickel

Crystal

Optic Crystal

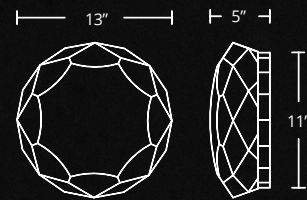

Model	Size	CCT	Voltage	Wattage	Weight	LED Lumens	Delivered Lumens
BFM12213	13"	3000K/3500K/4000K	120-277V	23W	17 lb	2800	2062

Example: BFM12213-PN



WHISPER

A chiseled luminaire offers a dimensional look for a luxurious aesthetic. Schonbek Optic Haze Crystal composed of natural quartz gemstone creates an elegant centerpiece for any room to complete a powerful architectural statement.



BFM39212-AB



- Optic Haze Crystal is engineered from organic quartz rock crystal quarried from the Earth. Traces of natural elements create unique variations in luster, hue, patterning and texture when illuminated.
- Each hand selected piece features unique variations
- Built-in adjustable 3000K / 3500K / 4000K color temperature switch
- Thin canopy conceals a proprietary universal 120V-220V-277V driver
- Can be mounted on ceiling or wall in all orientations
- Dimmer: ELV, TRIAC, 0-10V

Finish

AB: Aged Brass

BK: Black

CH: Chrome

Crystal

Optic Haze Crystal

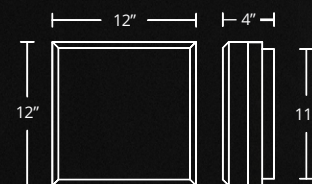

Model	Size	CCT	Voltage	Wattage	Weight	LED Lumens	Delivered Lumens
BFM39212	12"	3000K/3500K/4000K	120-277V	44W	45 lb	4800	1448

Example: BFM39212-BK





EXTERIOR SCONCES

Elegance for the outdoors. Our exterior wall luminaires showcase sparkling crystal elements that twinkle like starlight as they reflect and refract illumination from hidden LEDs. These exquisite wall sconces bring a luxe aesthetic and long-lasting performance to upscale facades.

DREAMCATCHER

An abundance of crystal capturing and reflecting our dreams and desires. Sparkling illumination from LEDs held within the frame's confines is reflected and amplified, showering your space with shards of light.



- Uses specially formulated powder coat with Premium 316 Marine Grade stainless steel hardware to resist UV and coastal environmental conditions
- Built-in adjustable 3000K / 3500K / 4000K color temperature switch
- Thin canopy conceals a proprietary dual voltage 120V/277V driver
- Clip on swinging door to allow easy cleaning of interior
- Dimmer: ELV, TRIAC

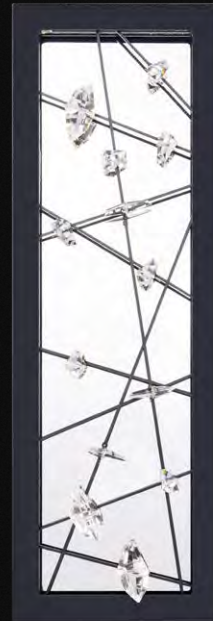

BWSW43318-BK

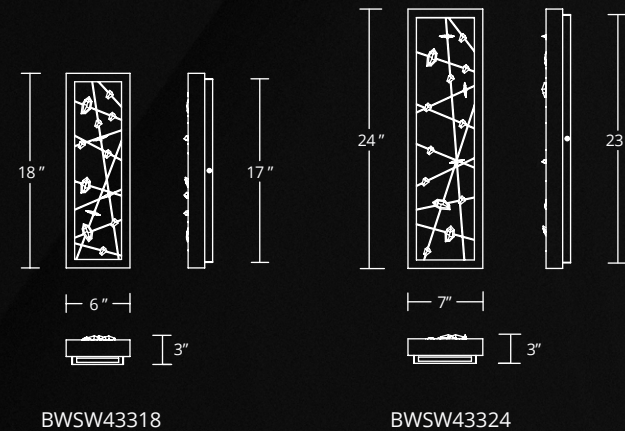

Finish



Crystal

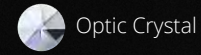

Model	Size	CCT	Voltage	Wattage	Weight	LED Lumens	Delivered Lumens
BWSW43318	18"	3000K/3500K/4000K	120/277V	19W	7 lb	600	411
BWSW43324	24"	3000K/3500K/4000K	120/277V	28W	9 lb	1300	1020

Example: BWSW43324-BK



STRATA

A trifecta of Optic Haze Crystal is bound within a stratum of metal planes. Each faceted piece of crystal is individually illuminated by LEDs to provide the perfect sparkling wash of light.

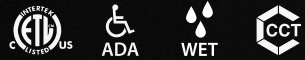

- Optic Haze Crystal is engineered from organic quartz rock crystal quarried from the Earth. Traces of natural elements create unique variations in luster, hue, patterning and texture when illuminated.
- Uses specially formulated powder coat with Premium 316 Marine Grade stainless steel hardware to resist UV and coastal environmental conditions
- Built-in adjustable 3000K / 3500K / 4000K color temperature switch
- Ambient and down illumination
- Thin canopy conceals a proprietary dual voltage 120V/277V driver
- Dimmer: ELV, TRIAC
- Patent pending design

Finish

 BK: Black

Crystal

 Optic Haze Crystal

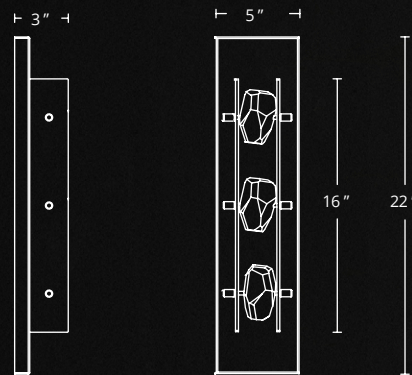

BWSW10322



BWSW10322-BK



Model	Size	CCT	Voltage	Wattage	Weight	LED Lumens	Delivered Lumens
BWSW10322	22"	3000K/3500K/4000K	120/277V	11W	9 lb	226	181
BWSW10328	28"				11 lb		

Example: BWSW10322-BK



VAIL

Precisely cut Optic Haze crystal is framed by planes of opaque matte metal. LED illumination reflects off a mirror-like stainless steel backplate, casting light through the crystal and highlighting its unique patterning.

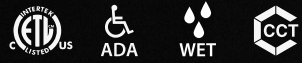

- Optic Haze Crystal is engineered from organic quartz rock crystal quarried from the Earth. Traces of natural elements create unique variations in luster, hue, patterning and texture when illuminated.
- Uses specially formulated powder coat with Premium 316 Marine Grade stainless steel hardware to resist UV and coastal environmental conditions
- Built-in adjustable 3000K / 3500K / 4000K color temperature switch
- Ambient and down illumination
- Thin canopy conceals a proprietary dual voltage 120V/277V driver
- Dimmer: ELV, TRIAC
- Patent pending design



BWSW14318-BK



Finish

BK: Black

Crystal

Optic Haze Crystal

Model	Size	CCT	Voltage	Wattage	Weight	LED Lumens	Delivered Lumens
BWSW14318	18"	3000K/3500K/4000K	120/277V	10W	9 lb	700	231
BWSW14324	24"			14W	14 lb	1003	297

Example: **BWSW14324-BK**



LABRYNTH

Sparkling Clear Optic Crystal combines the uncomplicated appeal of simple cuts with the playfulness of mirrored reflections.



- Uses specially formulated powder coat with Premium 316 Marine Grade stainless steel hardware to resist UV and coastal environmental conditions
- Built-in adjustable 3000K / 3500K / 4000K color temperature switch
- Thin canopy conceals a proprietary universal 120V-220V-277V driver
- Dimmer: ELV, 0-10V, TRIAC



BWSW21332-BK

Finish

 BK: Black

Crystal

 Optic Crystal

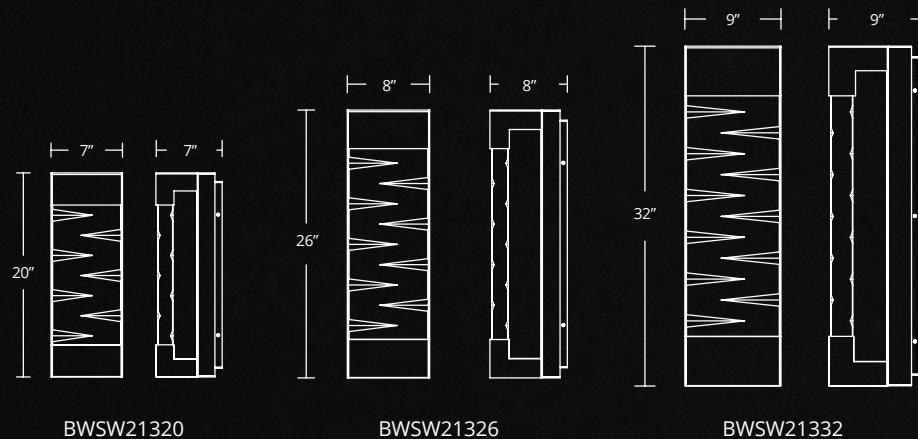

Model	Size	CCT	Voltage	Wattage	Weight	LED Lumens	Delivered Lumens
BWSW21320	20"			30W	11 lb	1786	1197
BWSW21326	26"	3000K/3500K/4000K	120-277V	37W	17 lb	1678	1065
BWSW21332	32"			45W	27 lb	2027	1484

Example: BWSW21320-BK



VESTA

Modern Art. A multi-dimensional statement made by uniquely patterned cloudy crystal intersecting with reflective plates to create dynamic lines of light.



- Optic Haze Crystal is engineered from organic quartz rock crystal quarried from the Earth. Traces of natural elements create unique variations in luster, hue, patterning and texture when illuminated.
- Uses specially formulated powder coat with Premium 316 Marine Grade stainless steel hardware to resist UV and coastal environmental conditions
- Built-in adjustable 3000K / 3500K / 4000K color temperature switch
- Thin canopy conceals a proprietary dual voltage 120V/277V driver
- Dimmer: ELV, TRIAC



BWSW36324-BK

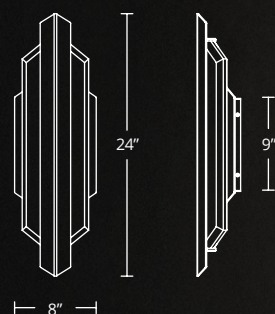

Finish

BK: Black

Crystal

Optic Haze Crystal

Model	Size	CCT	Voltage	Wattage	Weight	LED Lumens	Delivered Lumens
BWSW36324	24"	3000K/3500K/4000K	120/277V	27W	13 lb	1065	750

Example: BWSW36324-BK



MYTHICAL

Like an all-seeing eye, a faceted crystal gem clasped within a sleek triangle emanates divine rays of sparkling illumination. A symbol for the ages.



- Uses specially formulated powder coat with Premium 316 Marine Grade stainless steel hardware to resist UV and coastal environmental conditions
- Built-in adjustable 3000K / 3500K / 4000K color temperature switch
- Can be mounted on ceiling or wall in all orientations
- Thin canopy conceals a proprietary dual voltage 120V/277V driver
- Dimmer: ELV, TRIAC



BWSW11307-BKAB

Finish

 BK/AB: Black/Aged Brass

Crystal

 Optic Crystal

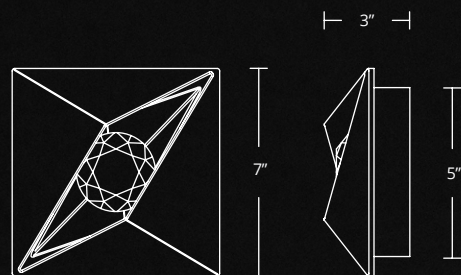

Model	Size	CCT	Voltage	Wattage	Weight	LED Lumens	Delivered Lumens
BWSW11307	7"	3000K/3500K/4000K	120/277V	16W	2 lb	1466	396

Example: **BWSW11307-BKAB**



GLACIER

Uniting bold geometric angles, clear crystal in an interlocking pattern delivers textured backlit, edge lit and downlight illumination with a sleek, black base casting downlight for wayfinding at night.



- Uses specially formulated powder coat with Premium 316 Marine Grade stainless steel hardware to resist UV and coastal environmental conditions
- Built-in adjustable 3000K / 3500K / 4000K color temperature switch
- Thin canopy conceals a proprietary universal 120V-220V-277V driver
- Dimmer: ELV, 0-10V, TRIAC



BWSW32327-BK

Finish

BK: Black

Crystal

Optic Crystal

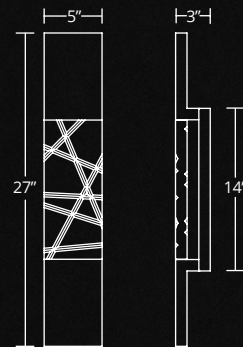

Model	Size	CCT	Voltage	Wattage	Weight	LED Lumens	Delivered Lumens
BWSW32327	27"	3000K/3500K/4000K	120-277V	14W	9 lb	947	815

Example: BWSW32327-BK



VIDA

An angular form accented by a trio of faceted Optic Crystal presents a multi-dimensional design. Lose yourself in the depths of reflection from its up and down illumination.



- Uses specially formulated powder coat with Premium 316 Marine Grade stainless steel hardware to resist UV and coastal environmental conditions
- Built-in adjustable 3000K / 3500K / 4000K color temperature switch
- No driver or transformer required
- Dimmer: ELV, TRIAC
- Patent pending design



BWSW54312-BK

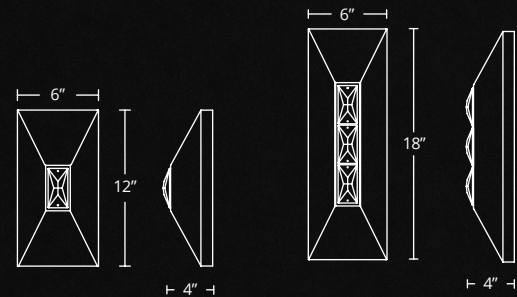

BWSW54312

BWSW54318

Finish

BK: Black

Crystal

Optic Crystal



Model	Size	CCT	Voltage	Wattage	Weight	LED Lumens	Delivered Lumens
BWSW54312	12"	3000K/3500K/4000K	120V	12W	8 lb	1078	176
BWSW54318	18"			30W	11 lb	3330	357

Example: BWSW54318-BK



POLAR

Clean lines frame a shimmering pour of crystal. Illuminated from above, a brilliant column captures rhythms and textures of transparency, luminosity and shadows, creating a stunning focal point on a luxury home's exterior.



- Uses specially formulated powder coat with Premium 316 Marine Grade stainless steel hardware to resist UV and coastal environmental conditions
- Built-in adjustable 3000K / 3500K / 4000K color temperature switch
- Thin canopy conceals a proprietary universal 120V-220V-277V driver
- Dimmer: ELV, 0-10V, TRIAC



BWSW59322-BK

Finish

BK: Black

Crystal

Optic Crystal

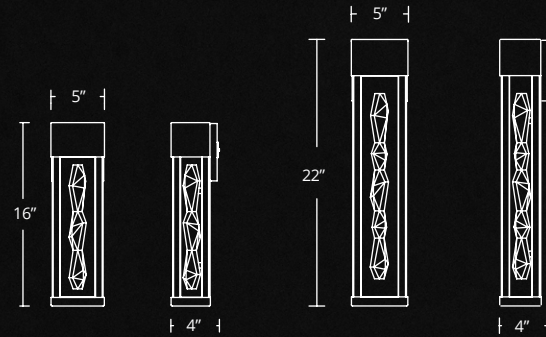

BWSW59316

BWSW59322

Model	Size	CCT	Voltage	Wattage	Weight	LED Lumens	Delivered Lumens
BWSW59316	16"	3000K/3500K/4000K	120-277V	21	5 lb	1200	695
BWSW59322	22"	3000K/3500K/4000K	120-277V	21	7 lb	1500	842

Example: BWSW59316-BK



CASCADE

Infinite unfolding facets create a multi-layered depth that draws the eye and imagination inward. Sleek metal bars frame chunks of crystal, delivering sparkling LED illumination to light facades in splendor.



- Uses specially formulated powder coat with Premium 316 Marine Grade stainless steel hardware to resist UV and coastal environmental conditions
- Built-in adjustable 3000K / 3500K / 4000K color temperature switch
- Ambient and down illumination
- Thin canopy conceals a proprietary universal 120V-220V-277V driver
- Dimmer: ELV, 0-10V, TRIAC



BWSW49318-BK



EXTERIOR SCANCES

Finish

BK: Black

Crystal

Optic Crystal

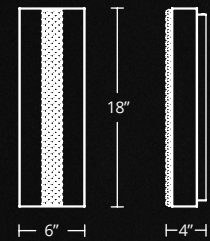

BWSW49318

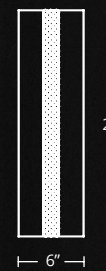
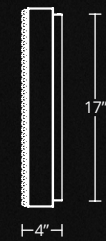

BWSW49324



Model	Size	CCT	Voltage	Wattage	Weight	LED Lumens	Delivered Lumens
BWSW49318	18"	3000K/3500K/4000K	120-277V	15W	8 lb	956	673
BWSW49324	24"			24W	12 lb	1687	1200

Example: BWSW49318-BK





RECESSED

Animate spaces with a sparkling play of light from our collection of luxury recessed lighting. Resplendent state-of-the-art LED illumination reflects, refracts and diffuses light from each Schonbek Radiance Crystal element in these exquisite ceiling luminaires, brilliantly enhancing spaces.

HIELO

An undulating arrangement of layered Schonbek Radiance Crystal prisms illuminated by LEDs create a play of light and energy within the crystal, releasing its fiery brilliance.



- Sold as New Construction, may be reconfigured in the field for Remodel
- Thin canopy conceals a proprietary universal 120V-240V driver
- Built-in adjustable 3000K / 3500K / 4000K color temperature switch within the canopy
- Dimmer: ELV, TRIAC

Finish

CH: Chrome

Crystal

Radiance Crystal

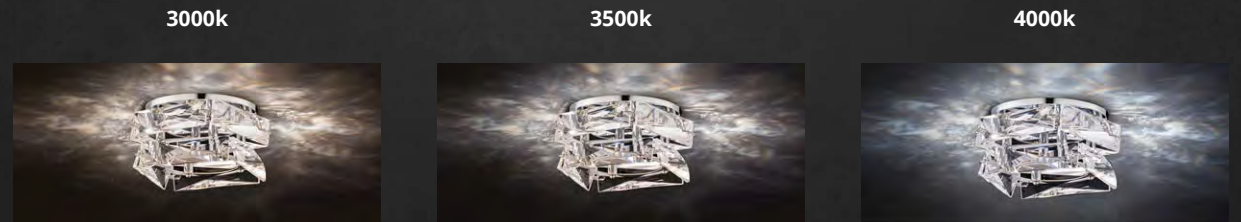
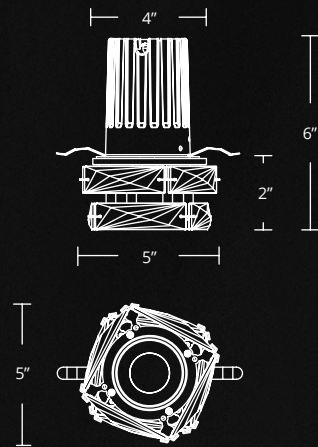

Model	Size	CCT	Voltage	Wattage	Weight	LED Lumens	Delivered Lumens
BR40305	5"	3000K/3500K/4000K	120-240V	12W	3 lb	597	358

Example: BR40305N-CH



XEO

LED light plays with a circle of sparkling Schonbek Radiance Crystal squares, animating ceilings with multidimensional reflections while delivering even illumination.



- Sold as New Construction, may be reconfigured in the field for Remodel
- Thin canopy conceals a proprietary universal 120V-240V driver
- Built-in adjustable 3000K / 3500K / 4000K color temperature switch within the canopy
- Dimmer: ELV, TRIAC

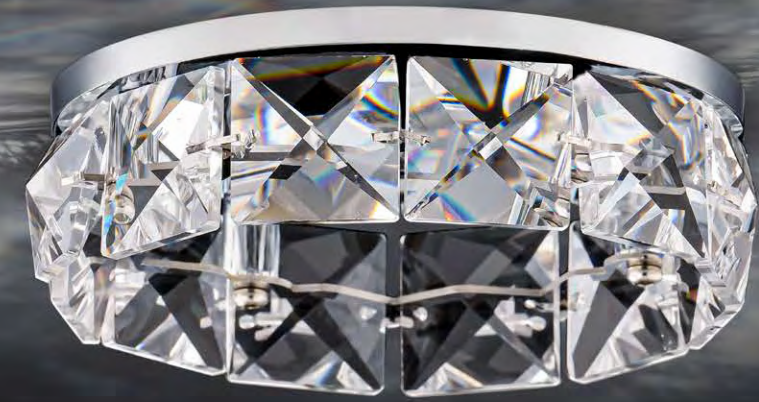

Finish

CH: Chrome

Crystal

Radiance Crystal

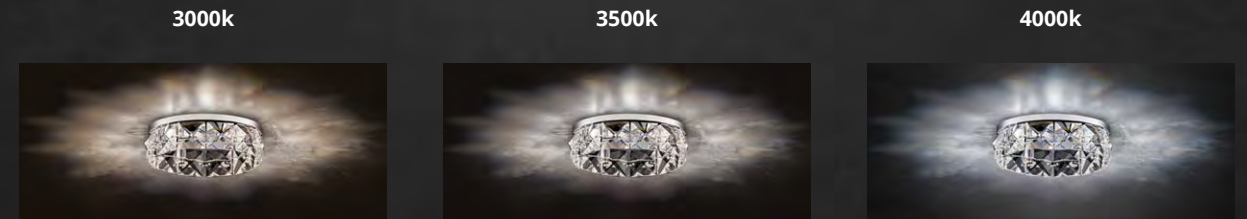
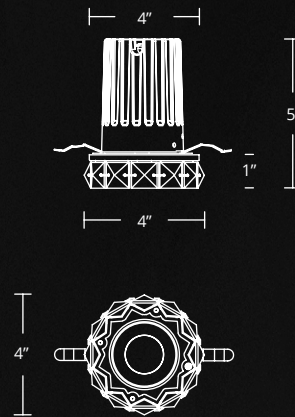

Model	Size	CCT	Voltage	Wattage	Weight	LED Lumens	Delivered Lumens
BR40310	4"	3000K/3500K/4000K	120-240V	12W	3 lb	597	358

Example: BR40310N-CH



VISATA

Stunning Schonbek Radiance prisms descend from a central canopy, creating an inner dynamism of lines, angles and planes in perpetual motion, throwing luminous beams in numerous directions.



- European precision AB (Aurora Borealis) crystal on clear prism crystal
- Sold as New Construction, may be reconfigured in the field for Remodel
- Thin canopy conceals a proprietary universal 120V-240V driver
- Built-in adjustable 3000K / 3500K / 4000K color temperature switch within the canopy
- Dimmer: ELV, TRIAC

Finish

CH: Chrome

Crystal

Radiance Crystal

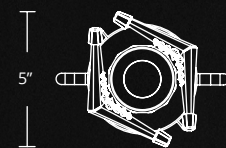
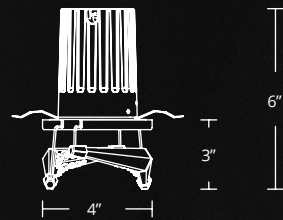

3000k



3500k



4000k



Model	Size	CCT	Voltage	Wattage	Weight	LED Lumens	Delivered Lumens
BR40330	4"	3000K/3500K/4000K	120-240V	12W	3 lb	597	358

Example: BR40330N-CH



VEGA

A smoothly faceted Schonbek Radiance Crystal shade emanates sparkling symmetrical light, bringing charm and balance to every home's design.

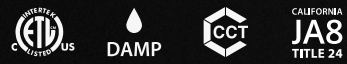

- Sold as New Construction, may be reconfigured in the field for Remodel
- Thin canopy conceals a proprietary universal 120V-240V driver
- Built-in adjustable 3000K / 3500K / 4000K color temperature switch within the canopy
- Dimmer: ELV, TRIAC

Finish

CH: Chrome

Crystal

Radiance Crystal

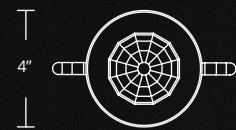
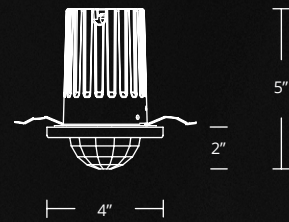

Model	Size	CCT	Voltage	Wattage	Weight	LED Lumens	Delivered Lumens
BR40320	4"	3000K/3500K/4000K	120-240V	12W	3 lb	597	358

Example: BR40320N-CH



MADISON

Shining like a princess-cut diamond, a featured faceted Radiance Crystal accent creates a lovely refractive effect on the ceiling from integrated LEDs delivering outward and downward illumination.



- Sold as New Construction, may be reconfigured in the field for Remodel
- Thin canopy conceals a proprietary universal 120V-240V driver
- Built-in adjustable 3000K / 3500K / 4000K color temperature switch within the canopy
- Dimmer: ELV, TRIAC

Finish

CH: Chrome

Crystal

Radiance Crystal

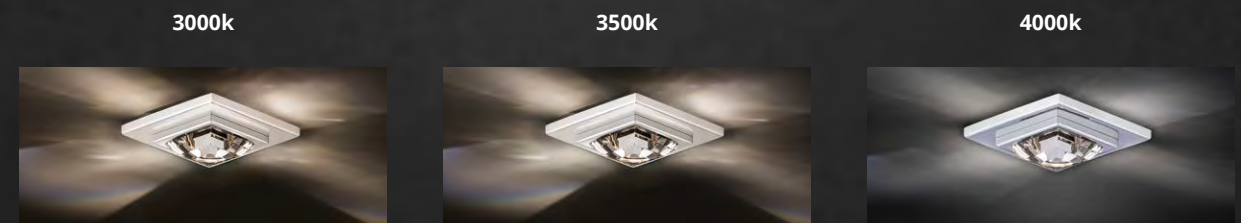
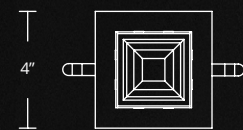
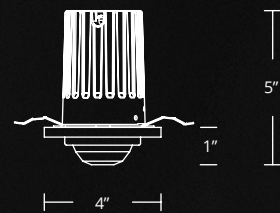

Model	Size	CCT	Voltage	Wattage	Weight	LED Lumens	Delivered Lumens
BR40325	4"	3000K/3500K/4000K	120-240V	12W	3 lb	597	358

Example: BR40325N-CH



ARLES

Geometrically precise, a Schonbek Radiance Crystal shade is filled with resplendent LED illumination, offering an opulent yet timeless look to luxury spaces.



- Sold as New Construction, may be reconfigured in the field for Remodel
- Thin canopy conceals a proprietary universal 120V-240V driver
- Built-in adjustable 3000K / 3500K / 4000K color temperature switch within the canopy
- Dimmer: ELV, TRIAC

Finish

CH: Chrome

Crystal

Radiance Crystal

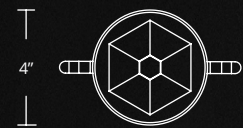
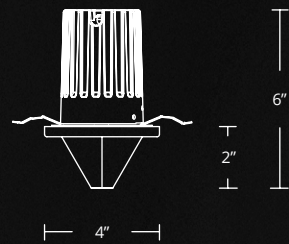

Model	Size	CCT	Voltage	Wattage	Weight	LED Lumens	Delivered Lumens
BR40315	4"	3000K/3500K/4000K	120-240V	12W	3 lb	597	358

Example: BR40315N-CH



INDEX

A

ABERDEEN 102
ARLES 152
ATOMIC 20

B

BENEDICTION 8

C

CARAT 114
CASCADE 138
CHANDLER 104
CORINTH 18
CRU 60, 90, 106

D

DEVOTION 46

E

ECHELON 84
ENCHANTE 110

F

FAZZOLETTO 52
FRAGMENT 88

G

GLACIO 82
GUILD 94

H

HELIOS 80
HERACLES 14
HIBISCUS 30, 62

I

J

K

KINDJAL 36, 38, 72, 98

L

LABRYNTH 126
LUNA 32

M

MADISON 86
MAGNATE 78
MARTINI 10, 66
MARQUIS 42
MELANGE 112
MIRAGE 76
MOSAIC 28
MYSTIQUE 22
MYTHICAL 130

N

O

P

POLAR 136
PRIMROSE 58

Q

QUEST 24, 64

R

S

SLIPSTREAM 26
SOIREE 96
SOLITUDE 6, 74
SYNAPSE 12

T

TRYST 50, 70

U

V

VAIL 124
VEGA 148
VERANDAH 100
VESTA 128
VIDA 134
VISATA 146

W

WHISPER 116
WONDER 56

X

XEO 144

Y

Z

HEADQUARTERS/EASTERN DISTRIBUTION CENTER
61 INDUSTRIAL BLVD, PLATTSBURGH, NY 12901

Consult the factory to take advantage of our custom capabilities in large quantities.
For up-to-date product specifications and assistance, please visit: [schonbek.com](https://www.schonbek.com) or call **1-800-836-1892**
We retain the right to modify the design of our products at any time as part of the company's continuous improvement program. Please refer to our website for the latest product specifications.

© Copyright 2023 W SCHONBEK LLC

All rights reserved. This catalog is copyrighted and W SCHONBEK LLC will use all measures available to it under the law against anyone who copies or derives from its copyrighted work.

This catalog includes many patent-pending products or features. We will not hesitate to enforce our intellectual property rights through injunctive relief and seek further relief through damages if we have reason to believe the patents are being infringed.

[SCHONBEK.COM](https://www.schonbek.com)

SCHONBEK.COM