



FOREVER™
SCHONBEK

2024 COLLECTION

FOREVER BY SCHONBEK

jewelry for your home™

Presenting the 2024 Forever by Schonbek Collection

Our second collection for Forever by Schonbek entwines the many facets of luxury crystal lighting with the revelations of LED innovations to speak a new language of light. From brilliant, ethereal floral designs to the seductive shimmer of our Radiance™ Crystal offerings, every jewelry-inspired luminaire is a unique work of art.

In the Spirit of Innovation: Our Pursuit of Sustainability

For 150 years, Schonbek has been at the forefront of innovation in the lighting industry. In keeping with the spirit of this legacy, we are committed to making strides towards a greener and more eco-conscious future. Each of these Forever by Schonbek luminaires feature energy efficient, CCT LED technology and is ETL rated to meet high performance, reliability and safety standards.

Additionally, we have made the decision to reduce the size of this supplement to minimize our ecological footprint and contribute to preserving our planet's resources. There is a QR code next to each product listing to enhance your browsing experience. Scan the code with your smart device for access to the product pages of our website for complete details on the design, features and specifications of each luminaire.

COQUETTE

SJ7714 | Linear Pendant

A decadent bouquet of
Radiance™ Crystal blossoms

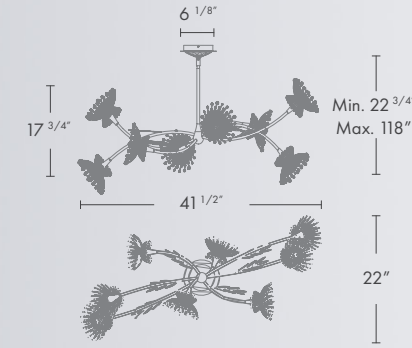

MODEL	L x W x H	HANG LENGTH	WEIGHT	CCT	LED LUMENS	DELIVERED LUMENS
SJ7708	42" x 22" x 18"	23" Min. 118" Max.	11 lbs	3000K 3500K 4000K	1468	Up To 1175

COQUETTE

SJ7708 | Linear Pendant

Slender arms hold Radiance™
Crystal Dust blossoms



FIORELLA

SJ8933 | Pendant

A floral design of Optic
Crystal and French Gold

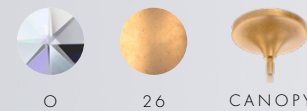
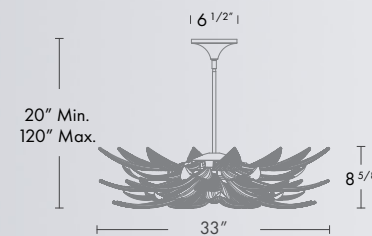

MODEL	L x W x H	HANG LENGTH	WEIGHT	CCT	LED LUMENS	DELIVERED LUMENS
SJ8933	33" x 33" x 9"	20" Min. 120" Max.	54 lbs	3000K 3500K 4000K 5000K	4300	Up To 2018

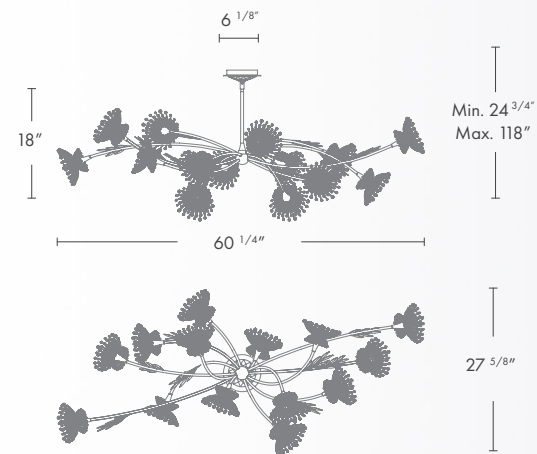

MODEL	L x W x H	HANG LENGTH	WEIGHT	CCT	LED LUMENS	DELIVERED LUMENS
SJ7714	60" x 28" x 18"	25" Min 118" Max	16 lbs.	3000K 3500K 4000K	1765	Up To 1562

SEDUCTION

SJ4354 | Linear Pendant

Radiance™ Crystal orbs lined with Radiance™ Crystal Dust and linked by metal cuffs

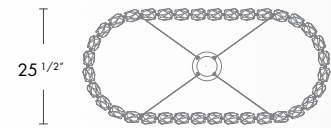
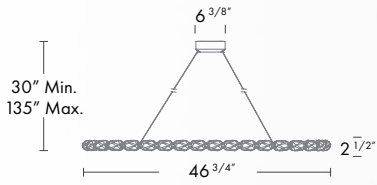

MODEL	L x W x H	HANG LENGTH	CRYSTALS	WEIGHT	CCT	LED LUMENS	DELIVERED LUMENS
SJ4354	47" x 26" x 3"	30" Min. 135" Max.	32	33.5 lbs.	3000K 3500K 4000K	6567	Up To 6239



SEDUCTION

SJW4407 | Bath Vanity

Radiance™ Crystal beads lined with Radiance™ Crystal Dust and bound with metallic cuffs

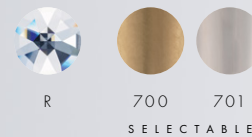
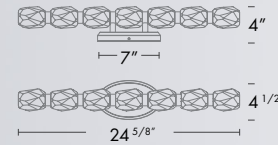

MODEL	L x W x H	CRYSTALS	WEIGHT	CCT	LED LUMENS	DELIVERED LUMENS
SJW4407	25" x 4" x 5"	7	7.9 lbs.	3000K 3500K 4000K	2215	Up To 2104

SEDUCTION

SJ4323 & SJ4332 | Pendant

Radiance™ Crystal orbs lined with Radiance™ Crystal Dust and bound with metallic links

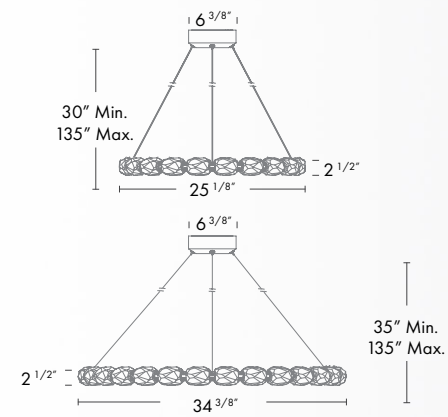

MODEL	L x W x H	HANG LENGTH	CRYSTALS	WEIGHT	CCT	LED LUMENS	DELIVERED LUMENS
SJ4323	25" x 25" x 3"	30" Min. 135" Max.	20	22 lbs.	3000K 3500K 4000K	4709	Up To 4474
SJ4332	34" x 34" x 3"	35" Min. 135" Max.	28	30 lbs.	3000K 3500K 4000K	5534	Up To 5257



SEDUCTION

SJW4411 | Bath Vanity

Radiance™ Crystal beads lined with Radiance™ Crystal Dust and cuffed by metal

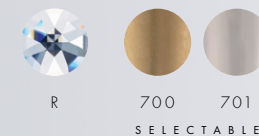
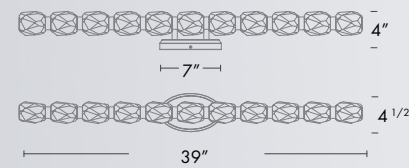

MODEL	L x W x H	CRYSTALS	WEIGHT	CCT	LED LUMENS	DELIVERED LUMENS
SJW4411	39" x 4" x 5"	11	11.5 lbs.	3000K 3500K 4000K	3123	Up To 2967

COQUETTE

SJ7705 | Wall Sconce

Radiance™ Crystal blossoms
top slender arms

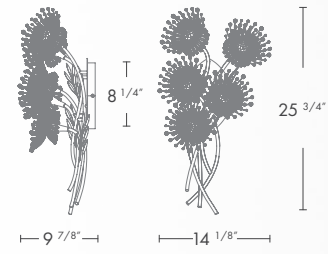

MODEL	L x W x H	WEIGHT	CCT	LED LUMENS	DELIVERED LUMENS
SJ7705	14" x 10" x 26"	6 lbs	3000K 3500K 4000K	958	Up To 767

CRYSTAL

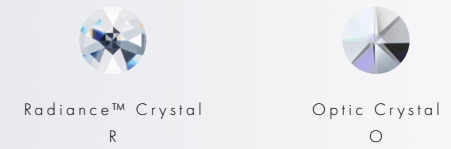

FINISHES



RHAPSODIE

SJ9514 | Wall Sconce & Flush Mount

Optic Crystal and Aged Brass petals
bloom around a cut crystal center

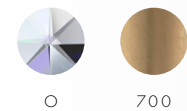
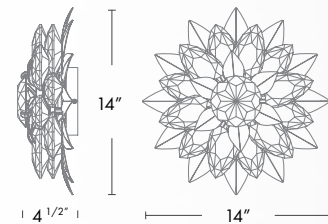

MODEL	L x W x H	WEIGHT	CCT	LED LUMENS	DELIVERED LUMENS
SJ9514	5" x 14" x 14"	10 lbs	3000K 3500K 4000K 5000K	2500	Up To 1234

SELECTABLE COLOR TEMPERATURES

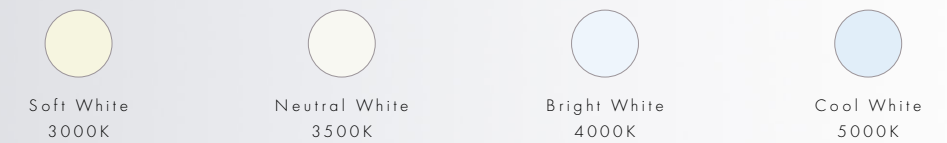

HEADQUARTERS/EASTERN DISTRIBUTION CENTER
61 INDUSTRIAL BLVD, PLATTSBURGH, NY 12901

Schonbek technology and designs are protected by several patents and patent applications. Schonbek will not hesitate to enforce its intellectual property rights through injunctive relief and seek further relief through damages if it has reason to believe its patents are being infringed.

Copyright © 2024 Schonbek. All rights reserved. This catalog is copyrighted and Schonbek will use all measures available to it under the law against anyone who copies or derives from its copyrighted work.

Schonbek retains the right to modify the design of its products at any time as part of the company's continuous improvement program. Please refer to our website for the latest product specifications.



jewelry for your home™

SCHONBEK.COM/FOREVER

©2024 W SCHONBEK LLC