



SCHONBEK
Beyond[®]

2 0 2 4

SCHONBEK BEYOND

Introducing 2024 Schonbek Beyond Luminaires

We are excited to premier our latest collections of luxury LED lighting from Schonbek Beyond. Taking a contemporary twist on exquisite traditional design, our new designs feature modern, edgy motifs captured in the finest crystal elements and highlighted by innovative LED technology.

In the Spirit of Innovation: Our Pursuit of Sustainability

For 150 years, Schonbek has been at the forefront of innovation in the lighting industry. In keeping with the spirit of this legacy, we are committed to making strides towards a greener and more eco-conscious future. Therefore, we've decided to reduce the size of this supplement to minimize our ecological footprint and contribute to preserving our planet's resources.

There is a QR code next to each product listing to enhance your browsing experience. Scan the code with your smart device for access to the product pages of our website for complete details on the design, features and specifications of each luminaire.

Thank you for joining us on this journey towards a brighter and greener tomorrow.

SCHONBEK
Beyond

INTRODUCING
**MULTI-LIGHT
 SELECTIONS**

Schonbek Beyond presents our new collection of multi-light luminaires, which incorporates multiple pendants installed onto one square, round or linear canopy. These pendants are arranged in various ways on a single canopy to create an artful statement as well as deliver ample lighting to spaces throughout a luxury home or hospitality setting.

S Q U A R E

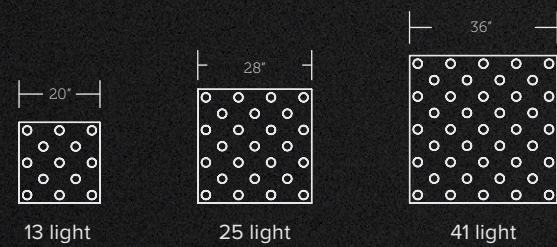

L I N E A R

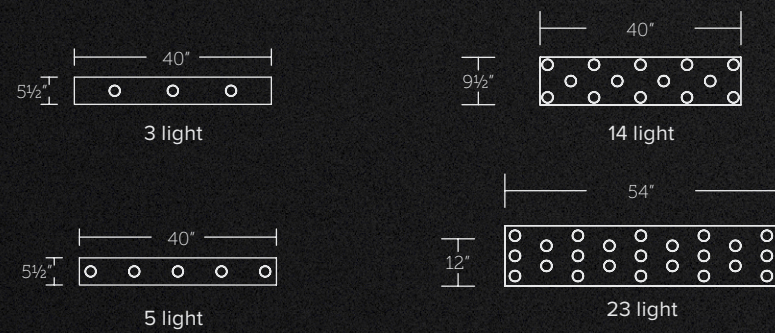

R O U N D

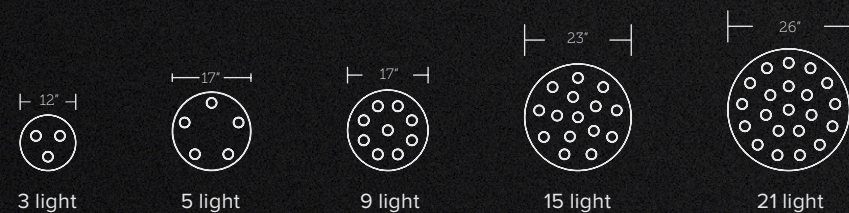

AVAILABLE FAMILIES

- SOLITUDE
p. 4
- HIBISCUS
p. 6
- KINDJAL
p. 8
- MARTINI
p. 10
- QUEST
p. 12



SOLITUDE

MULTI-LIGHT

BPD31415

- Optic Haze™ Quartz includes unique variations in luster, hue, and patterning
- Easily accessible 3CCT adjustability switch. Set from 3000K/3500K/4000K.
- Thin, powered aircraft cables provide adjustable suspension height for an ultra-clean look
- Can be mounted on a sloped ceiling
- Driver concealed within the fixture

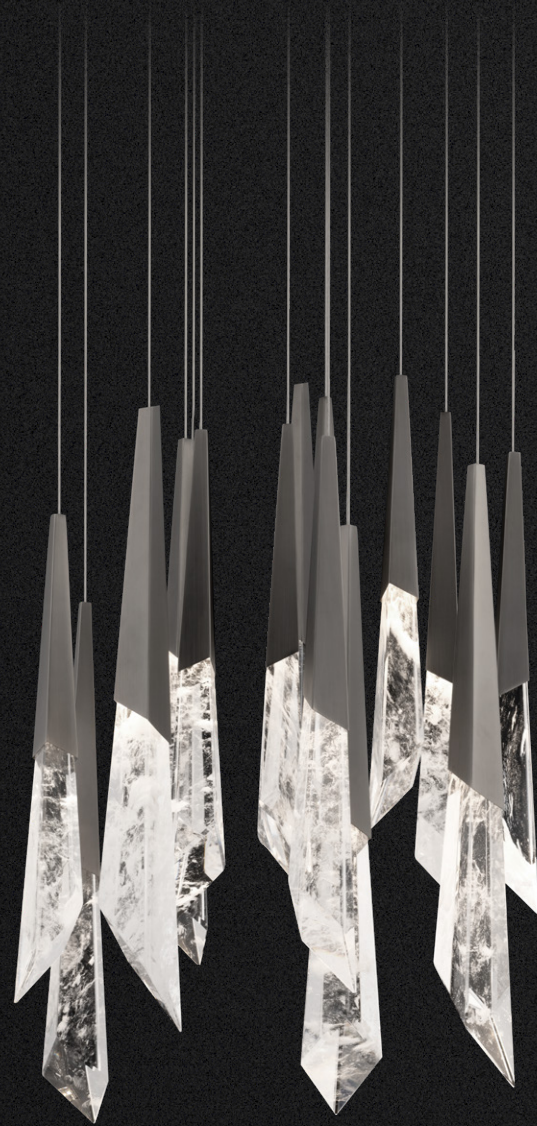
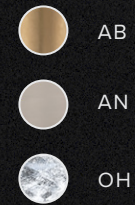

SOLITUDE



SQUARE

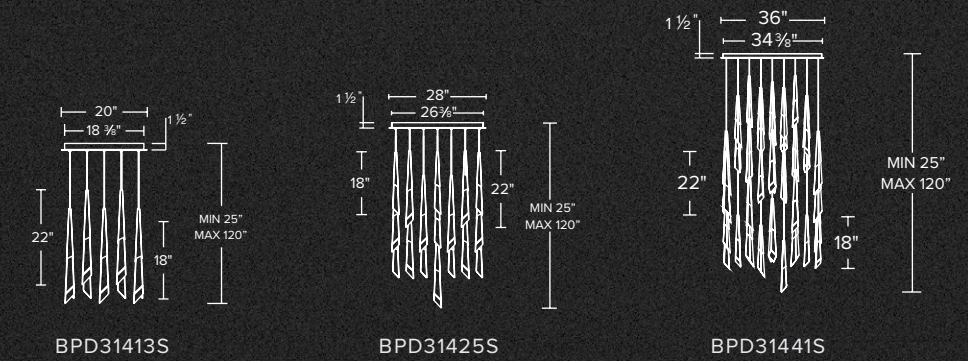

LINEAR

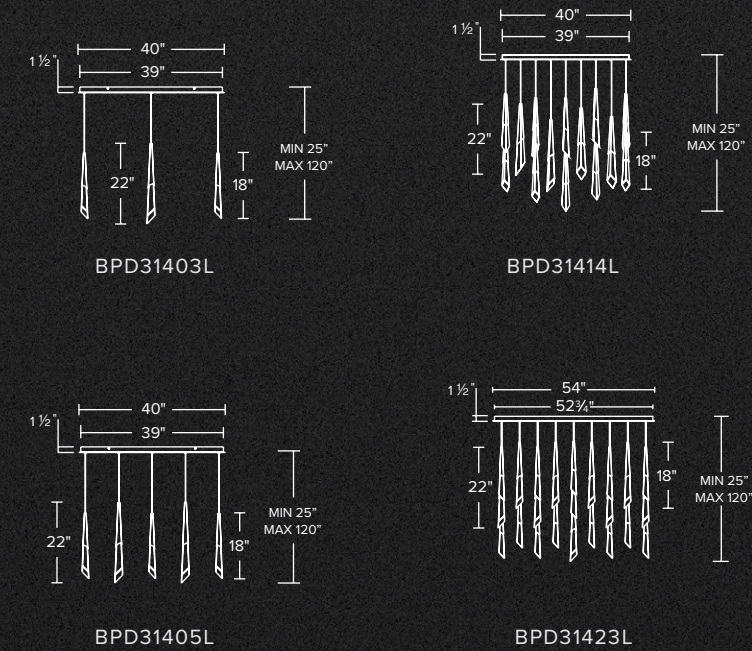

ROUND

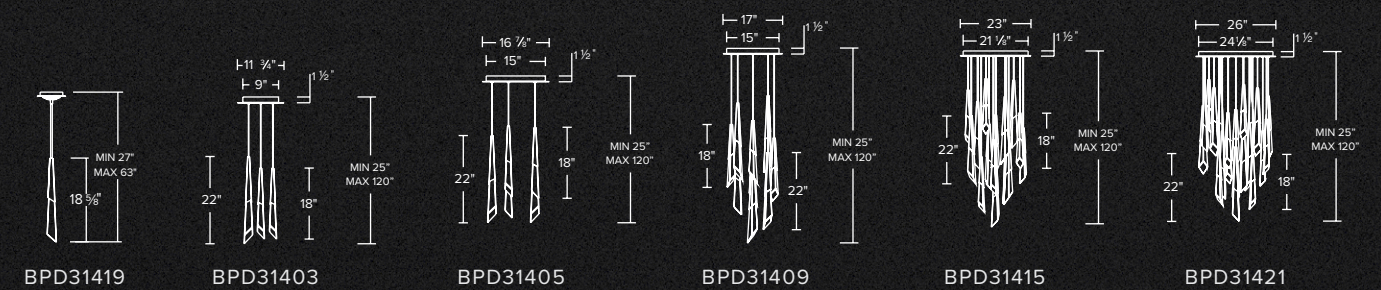

MODEL	Light Bulbs	Weight	Voltage	Wattage	LED LUM	DEL LUM
BPD31413S	13	55 LBS	120-277V	113W	4575	2947
BPD31425S	25	106 LBS	120-277V	217W	8755	5727
BPD31441S	41	175 LBS	120-277V	356W	14445	9272
BPD31403L	3	19 LBS	120-277V	26W	1045	695
BPD31405L	5	25 LBS	120-277V	43W	1765	1126
BPD31414L	14	55 LBS	120-277V	122W	4830	3308
BPD31423L	23	94 LBS	120-277V	200W	8105	5199
BPD31419	1	5 LBS	120/277V	5.2W	256	97
BPD31403	3	12 LBS	120-277V	26W	1045	695
BPD31405	5	23 LBS	120-277V	43W	1765	1126
BPD31409	9	35 LBS	120-277V	78W	3205	1988
BPD31415	15	62 LBS	120-277V	130W	5365	3281
BPD31421	21	84 LBS	120-277V	183W	7525	4574

HIBISCUS

MULTI-LIGHT

BPD21205

- Illuminated Optic Crystal
- Easily accessible 3CCT adjustability switch. Set from 3000K/3500K/4000K.
- Thin, powered aircraft cables provide adjustable suspension height for an ultra-clean look
- Can be mounted on a sloped ceiling
- Driver concealed within the fixture

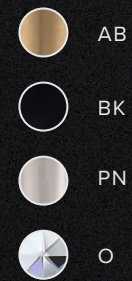

HIBISCUS



SQUARE

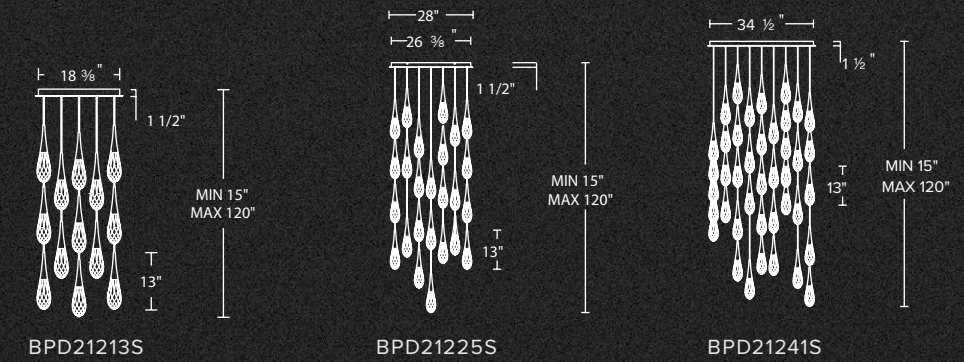

LINEAR

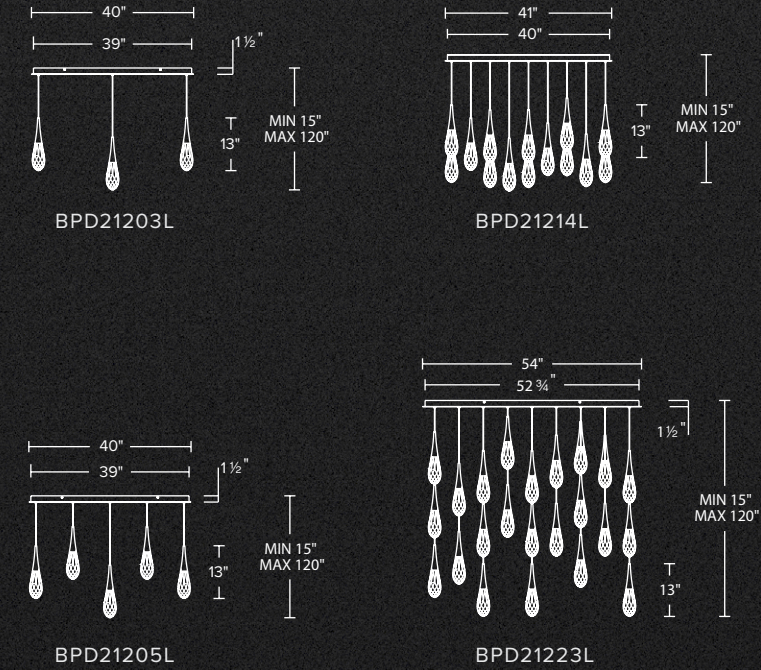

ROUND

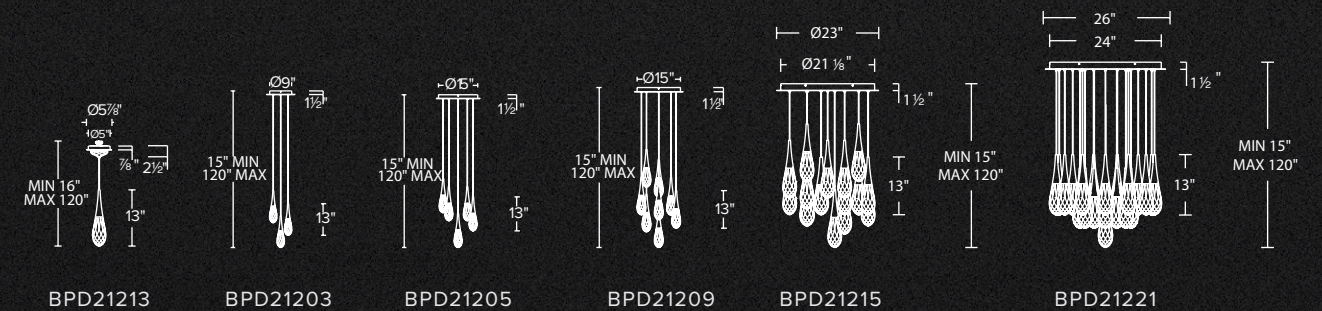

MODEL	Light Bulbs	Weight	Voltage	Wattage	LED LUM	DEL LUM
BPD21213S	13	66 LBS	120-277V	79W	3965	3484
BPD21225S	25	127 LBS	120-277V	149W	7625	6700
BPD21241S	41	208 LBS	120-277V	241W	12505	10988
BPD21203L	3	21 LBS	120-277V	18W	915	804
BPD21205L	5	29 LBS	120-277V	31W	1525	1340
BPD21214L	14	67 LBS	120-277V	83W	4270	3752
BPD21223L	23	113 LBS	120-277V	136W	7015	6164
BPD21213	1	6 LBS	120/277V	7W	585	390
BPD21203	3	15 LBS	120-277V	17.5W	915	804
BPD21205	5	27 LBS	120-277V	31W	1525	1340
BPD21209	9	41 LBS	120-277V	52W	2745	2412
BPD21215	15	73 LBS	120-277V	87W	4575	4020
BPD21221	21	100 LBS	120-277V	122W	6405	5628



KINDJAL

MULTI-LIGHT

BPD13209

- Illuminated Optic Crystal
- Easily accessible 3CCT adjustability switch. Set from 3000K/3500K/4000K.
- Thin, powered aircraft cables provide adjustable suspension height for an ultra-clean look
- Can be mounted on a sloped ceiling
- Driver concealed within the fixture

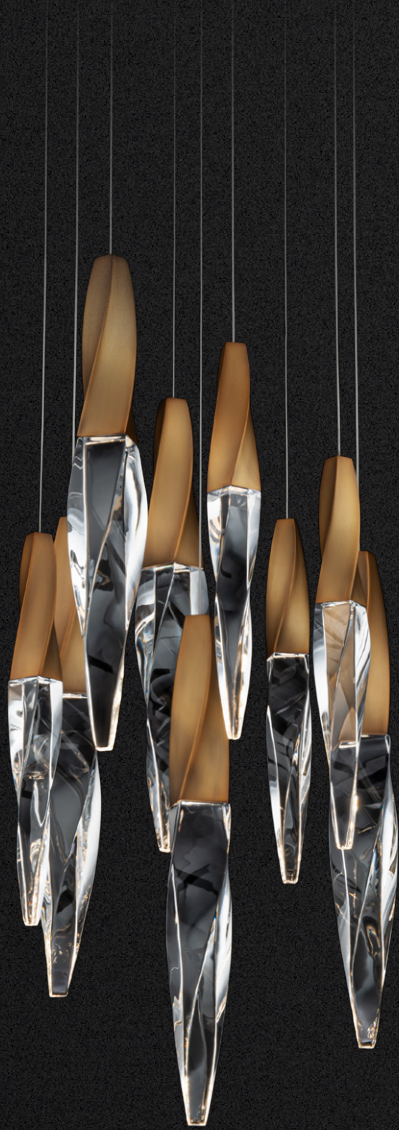
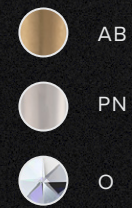

KINDJAL



SQUARE

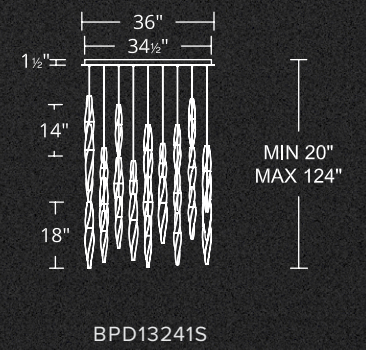
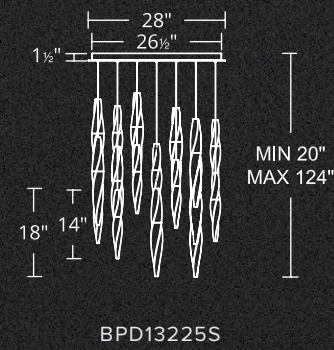
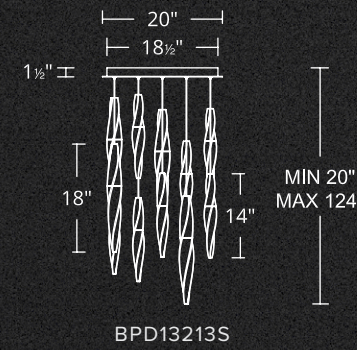

LINEAR

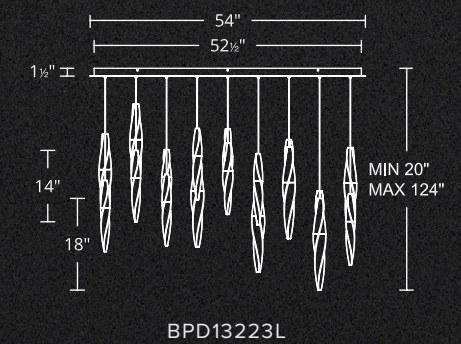
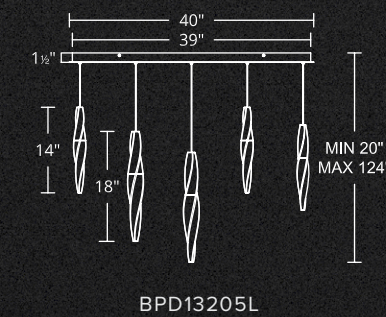
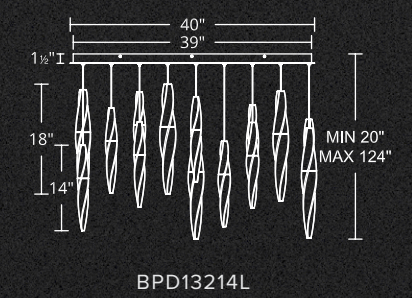
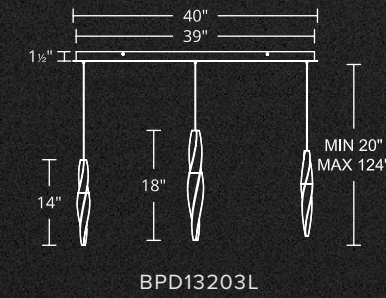

ROUND

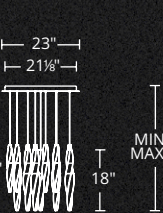
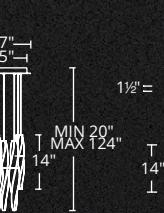
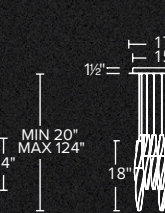
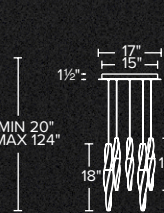
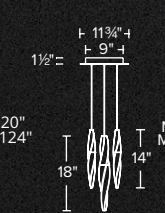
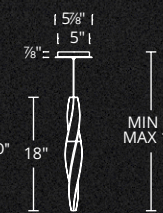
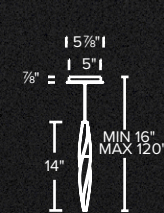

MODEL	Light Bulbs	Weight	Voltage	Power	LED LUM	DEL LUM
BPD13213S	13	88 LBS	120-277V	104W	7920	4930
BPD13225S	25	169LBS	120-277V	198W	15120	9410
BPD13241S	41	278 LBS	120-277V	324W	24660	15100
BPD13203L	3	26 LBS	120-277V	24W	1800	920
BPD13205L	5	37 LBS	120-277V	41W	3060	1950
BPD13214L	14	91 LBS	120-277V	111W	8460	5270
BPD13223L	23	152 LBS	120-277V	182W	13860	8630
BPD13214	1	1 LBS	120/277V	9W	630	398
BPD13218	1	1.5 LBS	120/277V	9W	630	440
BPD13203	3	6 LBS	120-277V	24W	1800	1200
BPD13205	5	9 LBS	120-277V	41W	3000	2000
BPD13209	9	15 LBS	120-277V	72W	5400	3600
BPD13215	15	26 LBS	120-277V	118W	9000	6000
BPD13221	21	35 LBS	120-277V	166W	12600	8400



MARTINI

MULTI-LIGHT

BPD20213S

- Offered with Optic Crystal or Optic Haze™ Quartz
- Optic Haze™ Quartz includes unique variations in luster, hue, and patterning
- Easily accessible 3CCT adjustability switch. Set from 3000K/3500K/4000K.
- Thin, powered aircraft cables provide adjustable suspension height for an ultra-clean look
- Can be mounted on a sloped ceiling
- Driver concealed within the fixture

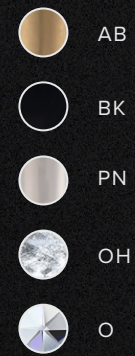

MARTINI



SQUARE

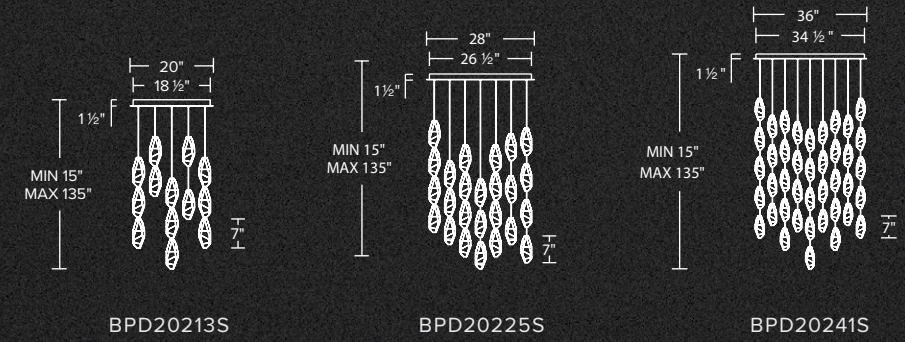

LINEAR

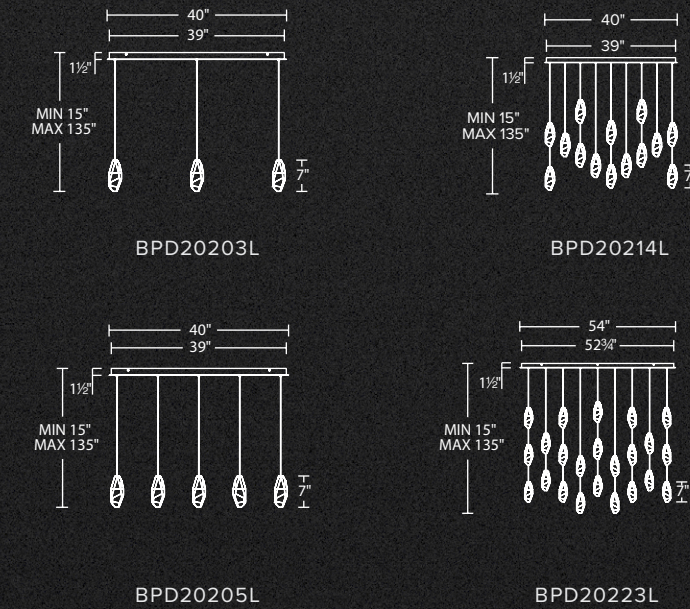

ROUND

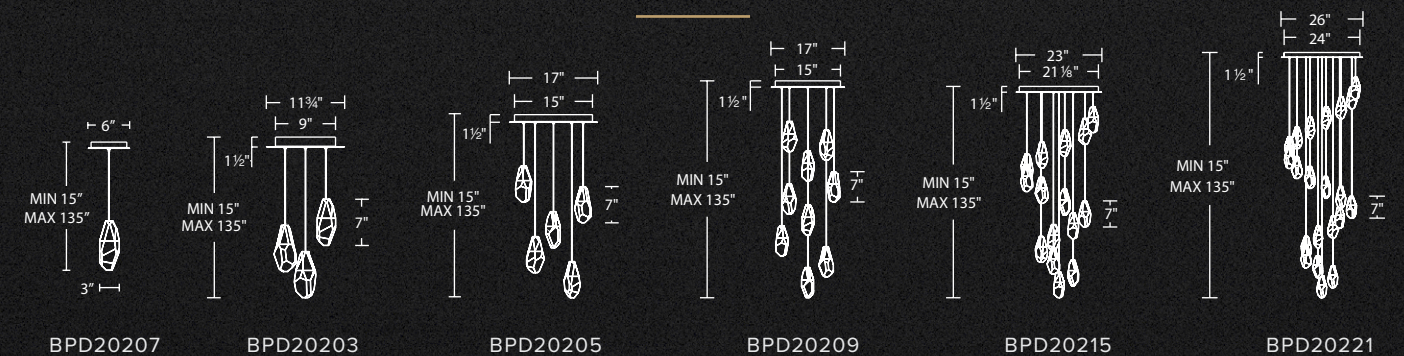

MODEL	Light Bulbs	Weight	Voltage	Power	LED LUM	DEL LUM
BPD20213S	13	55 LBS	120-277V	90W	7800	6097
BPD20225S	25	105 LBS	120-277V	195W	15000	11725
BPD20241S	41	173 LBS	120-277V	316W	24600	19229
BPD20203L	3	19 LBS	120-277V	23W	1800	1407
BPD20205L	5	11 LBS	120-277V	40W	3000	2345
BPD20214L	14	24 LBS	120-277V	110W	8400	6566
BPD20223L	23	93 LBS	120-277V	178W	13800	10787
BPD20207	1	4 LBS	120/277V	8W	657	490
BPD20203	3	12 LBS	120-277V	23W	1800	1407
BPD20205	5	23 LBS	120-277V	40W	3000	2345
BPD20209	9	34 LBS	120-277V	69W	5400	4221
BPD20215	15	60 LBS	120-277V	115W	9000	7035
BPD20221	21	81 LBS	120-277V	161W	12600	9849





QUEST

MULTI-LIGHT

BPD40209

- Optic Haze™ Quartz includes unique variations in luster, hue, and patterning
- Easily accessible 3CCT adjustability switch. Set from 3000K/3500K/4000K.
- Thin, powered aircraft cables provide adjustable suspension height for an ultra-clean look
- Can be mounted on a sloped ceiling
- Driver concealed within the fixture

-  AB
-  BK
-  OH



QUEST



SQUARE

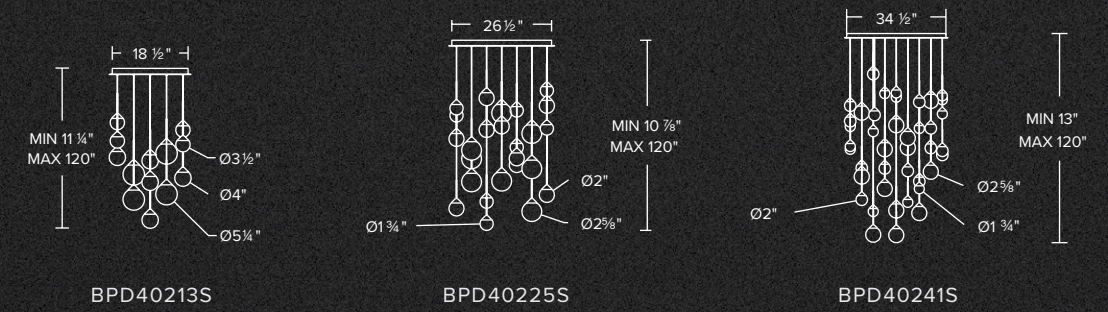

LINEAR

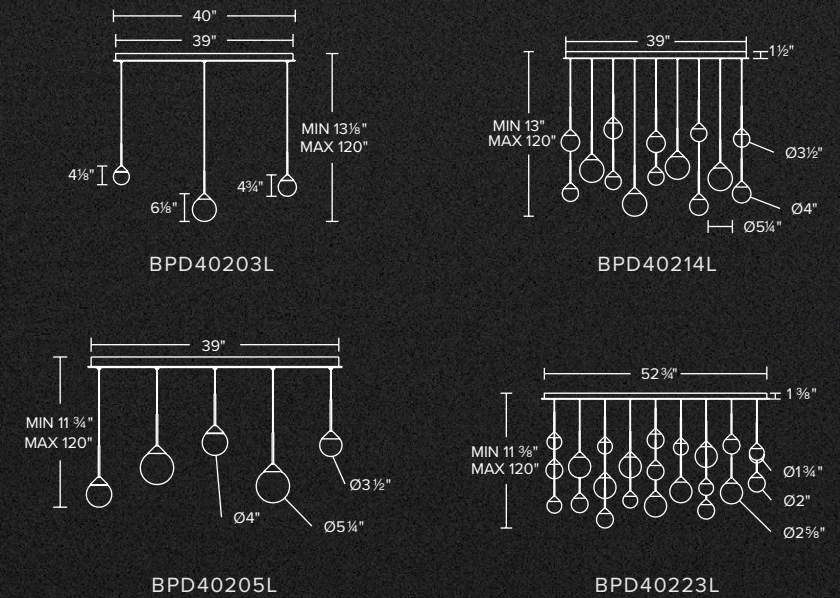

ROUND

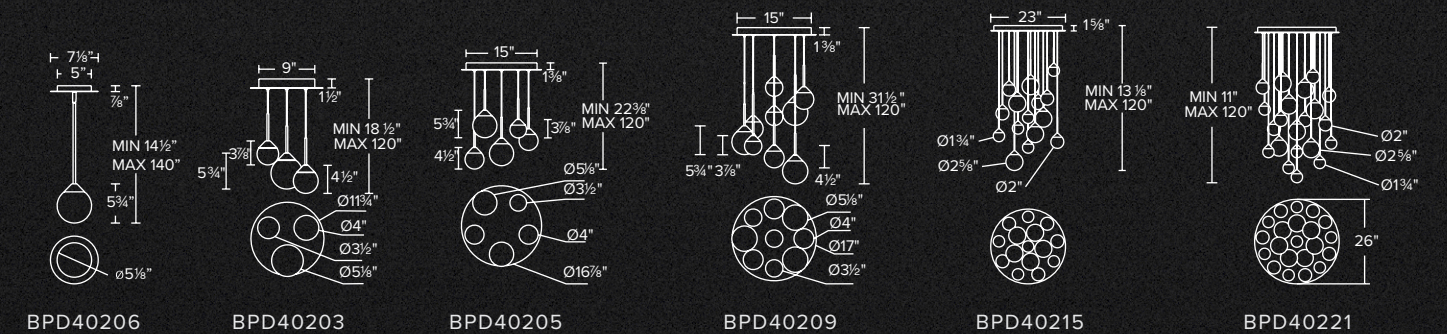

MODEL					LED LUM	DEL LUM
BPD40213S	13	69 LBS	120-277V	24W	1879	1792
BPD40225S	25	134 LBS	120-277V	43W	3843	3666
BPD40241S	41	218 LBS	120-277V	74W	6426	6130
BPD40203L	3	22 LBS	120-277V	43W	3843	3666
BPD40205L	5	34 LBS	120-277V	86W	7686	7332
BPD40214L	14	70 LBS	120-277V	129W	11529	10998
BPD40223L	23	117 LBS	120-277V	17W	1331	1270
BPD40206	1	8 LBS	120/277V	5W	313	307
BPD40203	3	16 LBS	120-277V	17W	1331	1270
BPD40205	5	30 LBS	120-277V	24W	1879	1792
BPD40209	9	44 LBS	120-277V	37W	3213	3065
BPD40215	15	34 LBS	120-277V	43W	3843	3666
BPD40221	21	104 LBS	120-277V	74W	6426	6130

ASTRAL

PENDANT

BPD37413



BPD37413-AB



7 LBS
 120/277V
 28W
 1181 LED LUM
 1027 DEL LUM

- Illuminated Optic Crystal
- Radiance™ Crystal Dust diffuser
- Easily accessible 4CCT adjustability switch. Set from 3000K/3500K/4000K/5000K.
- Includes hang straight swivel for sloped ceiling installation
- Driver concealed within the fixture

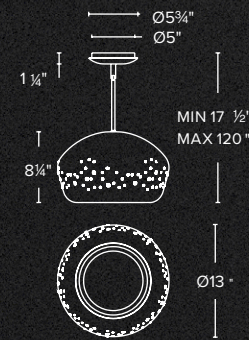

BPD65419-AB



ORGANZA

MINI PENDANT

BPD65419

7 LBS
 120/277V
 16.5W
 1500 LED LUM
 486 DEL LUM

- Illuminated Optic Haze™ Quartz includes unique variations in luster, hue, and patterning
- Easily accessible 4CCT adjustability switch. Set from 3000K/3500K/4000K/5000K.
- Includes hang straight swivel for sloped ceiling installation
- Driver concealed within the fixture

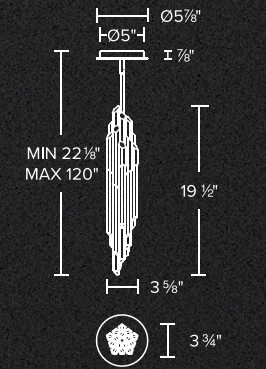

FROZEN

PENDANT

BPD97447

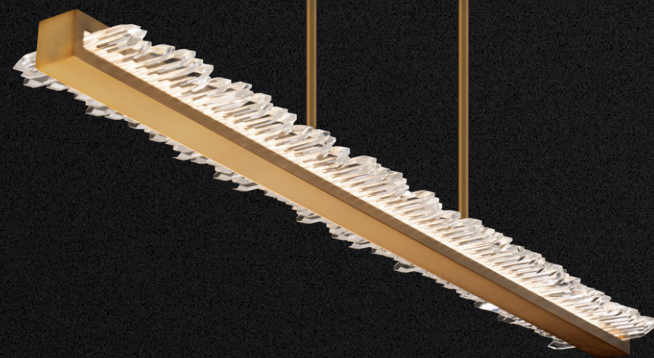

BPD97447-AB



25 LBS
 120-277V
 43.2W
 3800 LED LUM
 1415 DEL LUM

- Illuminated Optic Crystal shards held within an Aged Brass frame
- Easily accessible 4CCT adjustability switch. Set from 3000K/3500K/4000K/5000K.
- Includes hang straight swivel for sloped ceiling installation
- Driver concealed within the fixture

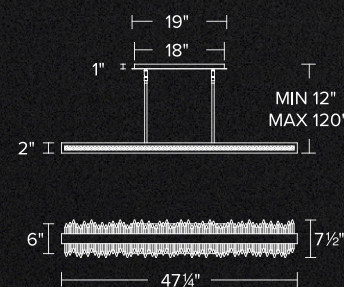

BPD33448-BK

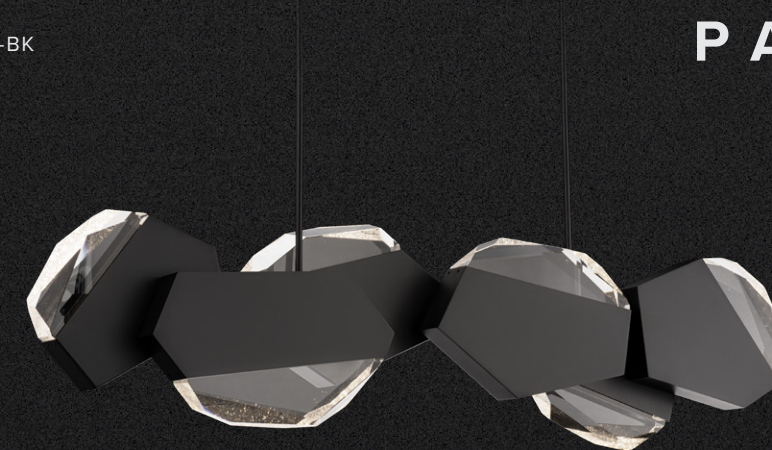

PALISADE

PENDANT

BPD33448

51 LBS
 120/277V
 56W
 2932 LED LUM
 2819 DEL LUM

- Illuminated Optic Crystal and Black metal frame
- Radiance™ Crystal Dust diffuser
- Easily accessible 4CCT adjustability switch. Set from 3000K/3500K/4000K/5000K.
- Includes hang straight swivel for sloped ceiling installation
- Driver concealed within the fixture

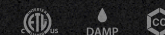
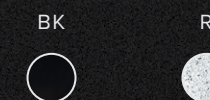
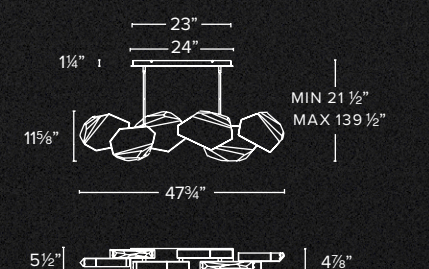

SOLITUDE

PENDANT

BPD31460

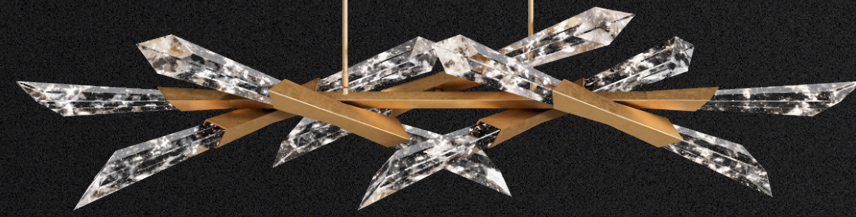

BPD31460-AB



44 LBS
 120-277V
 42W
 1951 LED LUM
 897 DEL LUM

- Optic Haze™ Quartz includes unique variations in luster, hue, and patterning
- Easily accessible 3CCT adjustability switch. Set from 3000K/3500K/4000K.
- Includes hang straight swivel for sloped ceiling installation
- Driver concealed within the fixture

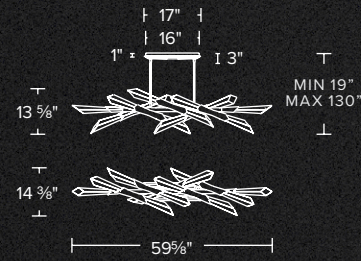

BWS41422-BK



BARRA

INDOOR SCONCE

BWS41422

18 LBS
 120V
 25.5W
 680 LED LUM
 480 DEL LUM

- Illuminated Optic Crystal inlaid into Black sconce
- Radiance™ Crystal Dust diffuser
- Ambient lighting with up and down illumination
- Easily accessible 4CCT adjustability switch. Set from 3000K/3500K/4000K/5000K.
- Driver concealed within the fixture

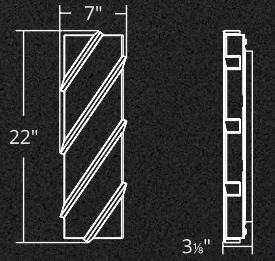

SOLITUDE

PENDANT

BPD31248



BPD31248-AB



52 LBS
 120-277V
 42W
 1154 LED LUM
 3013 DEL LUM

- Optic Haze™ Quartz includes unique variations in luster, hue, and patterning
- Easily accessible 3CCT adjustability switch. Set from 3000K/3500K/4000K.
- Includes hang straight swivel for sloped ceiling installation
- Driver concealed within the fixture

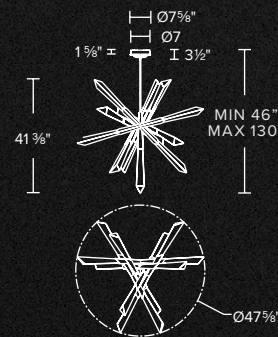

BWS42416-PN



BATON

INDOOR SCONCE

BWS42416

5 LBS
 120/277V
 11W
 569 LED LUM
 435 DEL LUM

- Illuminated Optic Haze™ Quartz includes unique variations in luster, hue, and patterning
- Easily accessible 4CCT adjustability switch. Set from 3000K/3500K/4000K/5000K.
- Can be mounted on wall in all orientations
- Driver concealed within the fixture

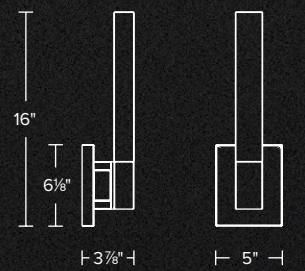

ORGANZA

INDOOR SCONCE

BWS65428



BWS65428-AB



10 LBS
 120-277V
 23.5W
 2100 LED LUM
 736 DEL LUM

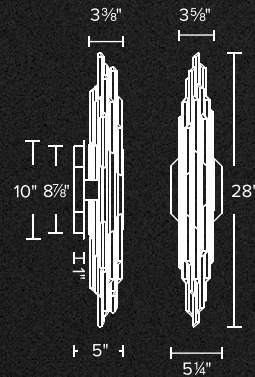

- Illuminated Optic Haze™ Quartz includes unique variations in luster, hue, and patterning
- Easily accessible 4CCT adjustability switch. Set from 3000K/3500K/4000K/5000K.
- Can be mounted on wall in all orientations
- Driver concealed within the fixture



BWS42426-BK



BATON

BATH VANITY

BWS42426

8 LBS
 120/277V
 17W
 1171 LED LUM
 755 DEL LUM

- Illuminated Optic Haze™ Quartz includes unique variations in luster, hue, and patterning
- Easily accessible 4CCT adjustability switch. Set from 3000K/3500K/4000K/5000K.
- Can be mounted on wall in all orientations
- Driver concealed within the fixture

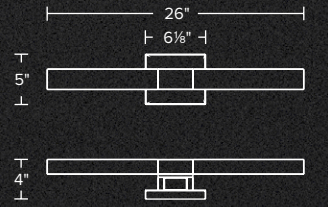

TERRACE

INDOOR SCONCE

BWS62424



BWS62424-AB



9 LBS
 120-277V
 37W
 1435.2 LED LUM
 1210 DEL LUM

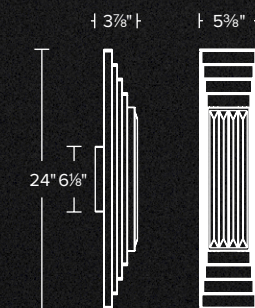

- Illuminated Optic Crystal - Diffused edge lit design
- Easily accessible 4CCT adjustability switch. Set from 3000K/3500K/4000K/5000K.
- Can be mounted on wall in all orientations
- Driver concealed within the fixture



BWS65438-BK

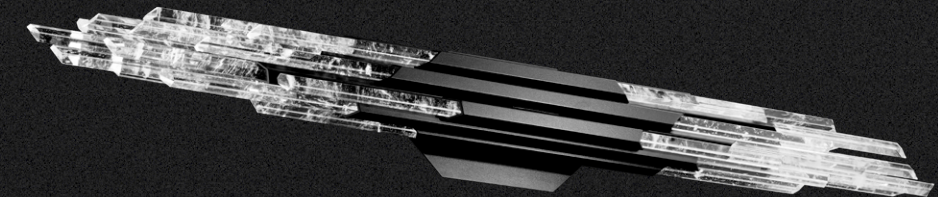

ORGANZA

BATH VANITY

BWS65438

14 LBS
 120-277V
 23.5W
 2100 LED LUM
 488 DEL LUM

- Illuminated Optic Haze™ Quartz includes unique variations in luster, hue, and patterning
- Easily accessible 4CCT adjustability switch. Set from 3000K/3500K/4000K/5000K.
- Can be mounted on wall in all orientations
- Driver concealed within the fixture

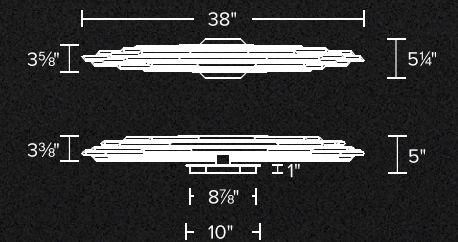

BRAMBLE

FLUSH MOUNT

BFM96412



BFM96412-AB



15 LBS
 120/277V
 30W
 2712 LED LUM
 1743 DEL LUM

- Pressed glass and Radiance™ Crystal Dust diffuser in Aged Brass frame
- Easily accessible 4CCT adjustability switch. Set from 3000K/3500K/4000K/5000K.
- Can be mounted on ceiling or wall in all orientations
- Driver concealed within the fixture

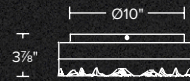

BFM98409-BK



PROMENADE

FLUSH MOUNT

BFM98409

9 LBS
 120V
 12.5W
 1000 LED LUM
 500 DEL LUM

- Faceted Optic Crystal
- Radiance™ Crystal Dust diffuser
- Additional diffused back light
- Easily accessible 4CCT adjustability switch. Set from 3000K/3500K/4000K/5000K.
- Can be mounted on ceiling or wall in all orientations
- Driver concealed within the fixture

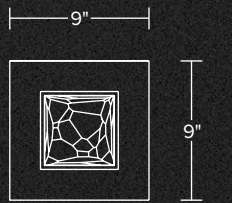

JANGLE

FLUSH MOUNT

BFM64418



BFM64418-BK



9 LBS
 120/277V
 55W
 3150 LED LUM
 2818 DEL LUM

- Radiance™ Crystal Dust diffuser held within Black frame
- Easily accessible 4CCT adjustability switch. Set from 3000K/3500K/4000K/5000K.
- Driver concealed within the fixture

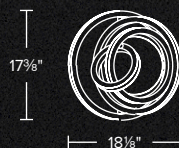

BFM82408-AB

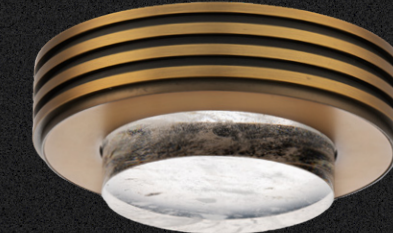

ZIRACLE

FLUSH MOUNT

BFM82408

6 LBS
 120/277V
 20W
 1169 LED LUM
 694 DEL LUM

- Illuminated Optic Haze™ Quartz includes unique variations in luster, hue, and patterning
- Radiance™ Crystal Dust diffuser
- Additional diffused back light
- Easily accessible 4CCT adjustability switch. Set from 3000K/3500K/4000K/5000K.
- Can be mounted on ceiling or wall in all orientations
- Driver concealed within the fixture

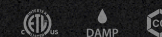
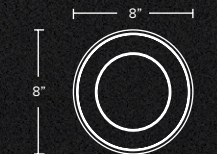

SOLITUDE

SEMI-FLUSH MOUNT

BFM31428

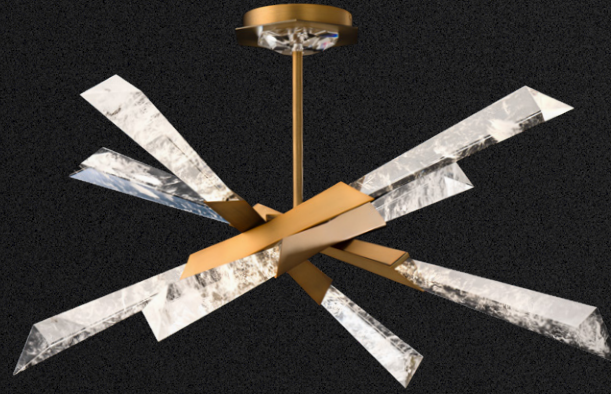

BFM31428-AB



BFR45428-BK/BN

- 8 LBS
- 120/277V
- 16W
- 1400 LED LUM
- 900 DEL LUM

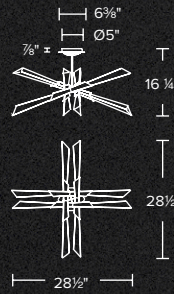

- Optic Haze™ Quartz includes unique variations in luster, hue, and patterning
- Easily accessible 3CCT adjustability switch. Set from 3000K/3500K/4000K.
- Driver concealed within the fixture



ATOMIC

SMART FAN

BFR45428



- 28 LBS
- 120V
- 38W
- 1721 LED LUM
- 1164 DEL LUM

SOLITUDE

SEMI-FLUSH MOUNT

BFM31417

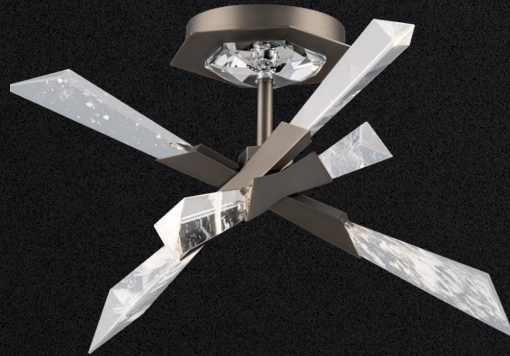

BFM31417-AN



- 6 LBS
- 120/277V
- 12W
- 900 LED LUM
- 600 DEL LUM

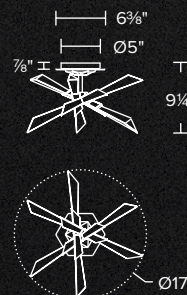

- Optic Haze™ Quartz includes unique variations in luster, hue, and patterning
- Easily accessible 3CCT adjustability switch. Set from 3000K/3500K/4000K.
- Driver concealed within the fixture



- Six-speed DC motor smart fan reversible from remote control or app
- Easily accessible 3CCT adjustability switch. Set from 3000K/3500K/4000K.

Total Power	38W	Pitch	16°
LED Power	25W	Sweep	23°
High CFM	2163	Downrod	4.5"
High Power	13W	Lead Wire	80"
Weighted Average CFM	1431	CRI	90
Weighted Average Power	9W	Sloped Ceiling	30°
Estimated Yearly Energy Cost (\$)	4		
Efficiency CFM/W	114W		

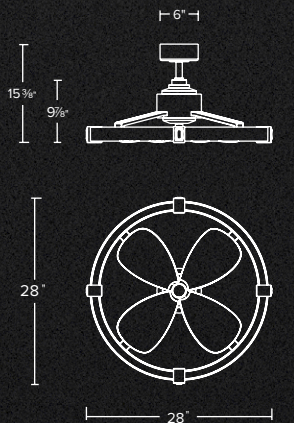
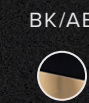
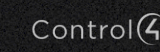





SKU GUIDE

B P D 3 1 4 6 0 - A B



Model Finish

SWATCH GUIDE

Finish

-  AB - AGED BRASS
-  AN - ANTIQUE NICKEL
-  BK - BLACK
-  BN - BRUSHED NICKEL
-  BK/AB - BLACK/AGED BRASS
-  BK/BN - BLACK/BRUSHED NICKEL
-  PN - POLISHED NICKEL

Crystal

-  O - OPTIC
-  OH - OPTIC HAZE
-  R - RADIANCE CRYSTAL DUST

ICON GUIDE



Light Count



Weight



Voltage



Wattage



LED Lumens



Delivered Lumens

HEADQUARTERS/EASTERN DISTRIBUTION CENTER

61 INDUSTRIAL BLVD, PLATTSBURGH, NY 12901

Schonbek technology and designs are protected by several patents and patent applications. Schonbek will not hesitate to enforce its intellectual property rights through injunctive relief and seek further relief through damages if it has reason to believe its patents are being infringed. Visit www.schonbek.com/patents for more details about Schonbek patents.

Copyright © 2024 Schonbek. All rights reserved. This catalog is copyrighted and Schonbek will use all measures available to it under the law against anyone who copies or derives from its copyrighted work.

Schonbek retains the right to modify the design of its products at any time as part of the company's continuous improvement program. Please refer to our website for the latest product specifications.

SCHONBEK.COM

