



WAC

LANDSCAPE LIGHTING

2018 NEW PRODUCT SUPPLEMENT

HARDSCAPE WITH DUAL CCT AND INTEGRAL BRIGHTNESS CONTROL



Transformer

*For 12V Grand Accent, Accent, Mini Accent,
Mini Wall Wash and Dual CCT Hardscape*

- IP65 Rated
- 12V to 15V taps
- Knock outs for power and photosensor connections
- 3-prong outlet for timer
- Outdoor rated stainless steel

Model

9075-TRN-SS	75W Max Dimensions: 13.97" L x 5.35"W x 5.63"H
9150-TRN-SS	150W Max Dimensions: 18.90" L x 6.69"W x 6.30"H
9300-TRN-SS	300W Max Dimensions: 18.90" L x 6.69"W x 6.30"H
9600-TRN-SS	600W Max (2 x 300W outputs) Dimensions: 14.49" L x 10.08"W x 5.94"H

HARDSCAPE

New with Dual CCT and Integral Brightness Control
New Sand and Graphite Finishes to Match Stonework



7181-27/30 18 inches



7121-27/30 12 inches



7061-27/30 6 inches



7031* 3 inches

* Due to its compact size, the 7031 is dedicated in either 2700K or 3000K. Lead Wire remains on the side of the fixture.

12V

Input: 9-15VAC
Lumens: Up to 330 lm
CRI: 90+
Rated Life: 50,000 hours

- Integral brightness control
Select color temperature option*
- Hardscape easily detaches from capstone bracket after installation
- Corrosion-resistant aluminum alloy
- Factory-sealed water tight fixture
- Transformer required (sold separately)
- Tightly spaced and diffused LEDs for even illumination
- Direct burial gel-filled wire nuts included

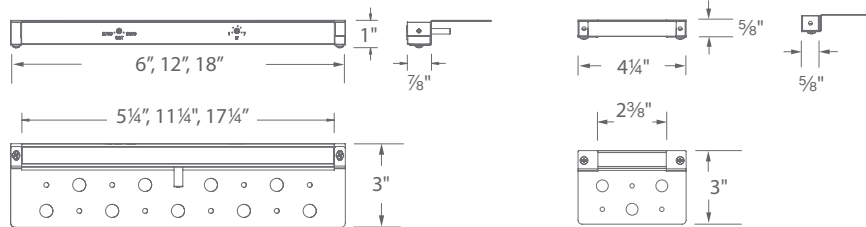

7061, 7121, 7181

7031*

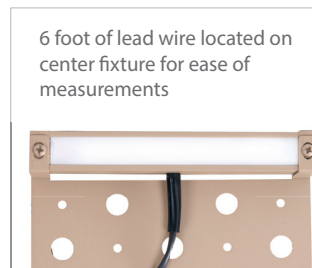

Length	Model	Color Temp	Wattage	Max Lumens	Finishes
3" *	7031-27 7031-30	2700K Warm White* 3000K Pure White*	1.4W, 2.5VA	40	BZ Bronze on Aluminum GH Graphite SD Sand
6"	New 7061-27/30	2700K Warm White 3000K Pure White	4.5W, 5.6VA	120	
12"	New 7121-27/30	2700K Warm White 3000K Pure White	7.0W, 7.3VA	225	
18"	New 7181-27/30	2700K Warm White 3000K Pure White	8.5W, 8.5VA	330	

Example: **7181-27/30SD**

GRAND ACCENT 740-2000 LUMENS

New



MOONLIGHTING EFFECT

Introducing the latest addition to our family of landscape accent lights, now with even more light output. When mounted high in trees and pointing downward, Grand Accent creates a beautiful moonlighting effect with a cool white light and superior lumen output.

- New 4000K Color Temperature option resembles moonlight
- Adjustable beam 15° to 60°
- Continuously adjustable lumen output 740-2000 lm

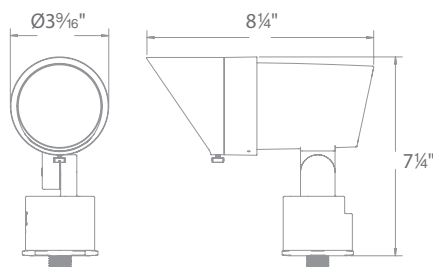

Mounting stake and direct burial gel filled wire nuts Included

12V

- Integral brightness control
- Adjustable beam angle 15°-60°
- One fixture replaces 50W to 100W halogen accent light
- Transformer required (sold separately)

Input: 9-15VAC
Power: 15W to 35W / 21VA -44VA
Lumens: 740 lm to 2000 lm
Beam Angle: 15° to 60°
CRI: 85
Rated Life: 45,000 hours

Color Temperature

2700K	Warm White
5211-27BZ	Bronze on Aluminum
5211-27BK	Black on Aluminum
3000K	Pure White
5211-30BZ	Bronze on Aluminum
5211-30BK	Black on Aluminum
4000K	Cool White
5211-40BZ	Bronze on Aluminum
5211-40BK	Black on Aluminum

Accessories For Grand Accent

Grand Accent Snoot	5211-SNOOT-BZ 5211-SNOOT-BK	Bronze on Aluminum Black on Aluminum
6" Long Shroud	5211-LSHR-BZ 5211-LSHR-BK	Bronze on Aluminum Black on Aluminum
Optics	LENS-25-AMB Amber LENS-25-GRN Green LENS-25-RED Red	LENS-25-BLU Blue LENS-25-FR Frosted

MINI ACCENT 45-365 LUMENS

Now available in Black



1838 listed (12V)
1598 listed (120V)



Mounting stake and direct burial gel filled wire nuts Included

12V

- Integral brightness control
- Adjustable beam angle 10° to 50°
- One fixture replaces 20W to 35W halogen accent light
- Transformer required (sold separately)

Input: 9-15VAC
Power: 1W to 7W / 2VA -10.5VA
Lumens: 45 lm to 365 lm
Beam Angle: 10° to 50°
CRI: 85
Rated Life: 70,000 hours

2700K

Warm White

5111-27BZ
5111-27BBR
New! **5111-27BK**

Bronze on Aluminum
 Bronze on Brass
 Black on Aluminum

3000K

Pure White

5111-30BZ
5111-30BBR
New! **5111-30BK**

Bronze on Aluminum
 Bronze on Brass
 Black on Aluminum

Accessories For Mini Accent

 Mini Accent Snoot	5111-SNOOT-BZ 5111-SNOOT-BBR 5111-SNOOT-BK	Bronze on Aluminum Bronze on Brass Black on Aluminum
 5" Long Shroud	5111-LSHR-BZ 5111-LSHR-BBR 5111-LSHR-BK	Bronze on Aluminum Bronze on Brass Black on Aluminum

 Optics	LENS-16-AMB Amber	LENS-16-FR Frosted
	LENS-16-GRN Green	LENS-16-SPR Spread
	LENS-16-RED Red	LENS-16-BEL Elongating
	LENS-16-BLU Blue	

ACCENT 190-1045 LUMENS

Now available in Black



Mounting stake and direct burial gel filled wire nuts Included

12V

- Integral brightness control
- Adjustable beam angle 10° to 60°
- One fixture replaces 35W to 75W halogen accent light
- Transformer required (sold separately)

Input: 9-15VAC
Power: 2W to 16W / 2VA -23VA
Lumens: 190 lm to 1045 lm
Beam Angle: 10° to 60°
CRI: 85
Rated Life: 70,000 hours

2700K

Warm White

5011-27BZ
5011-27BBR
New! **5011-27BK**

Bronze on Aluminum
 Bronze on Brass
 Black on Aluminum

3000K

Pure White

5011-30BZ
5011-30BBR
New! **5011-30BK**

Bronze on Aluminum
 Bronze on Brass
 Black on Aluminum

120V

Transformer Not Required

Input: 110V - 120VAC
Power: 3.5W to 14.5W
Lumens: 100 lm to 900 lm
Beam Angle: 15° to 60°
CRI: 85
Rated Life: 45,000 hours



3000K

Pure White

5012-30BZ
5012-30BBR
New! **5012-30BK**

Bronze on Aluminum
 Bronze on Brass
 Black on Aluminum

Accessories For Accent

 Accent Snoot	5010-SNOOT-BZ 5010-SNOOT-BBR 5010-SNOOT-BK	Bronze on Aluminum Bronze on Brass Black on Aluminum
 6" Long Shroud	5010-LSHR-BZ 5010-LSHR-BBR 5010-LSHR-BK	Bronze on Aluminum Bronze on Brass Black on Aluminum

 Optics	LENS-20-AMB Amber	LENS-20-BLU Blue
	LENS-20-GRN Green	LENS-20-FR Frosted
	LENS-20-RED Red	LENS-20-SPR Spread

MINI WALL WASH

WITH DUAL CCT AND INTEGRAL BRIGHTNESS CONTROL



1838 listed (12V)

12V

- Integral brightness control
Select color temperature option
- A uniform wide distribution wall wash from a small form factor
- Mounting stake and direct burial gel-filled wire nuts all included
- Transformer required (sold separately)

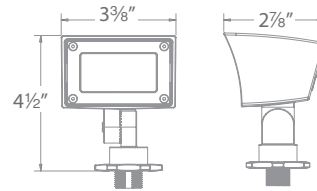

Input: 9-15VAC
Power: 1W to 8W / 2-12VA
Lumens: 80 lm to 420 lm
Beam Angle: Symmetrical (70° by 95°)
CRI: 85+
Rated Life: 60,000 hours
CCT: 2700K & 3000K
 Warm White & Pure White

5121-27/30BZ Bronze on Aluminum
5121-27/30BBR Bronze on Brass
5121-27/30BK Black on Aluminum

A uniform wide distribution wall wash from a small form factor

Accessories For Mini Wall Wash

Mini Wall Wash Optics 	LENS-2X3-AMB	Amber
	LENS-2X3-GRN	Green
	LENS-2X3-RED	Red
	LENS-2X3-BLU	Blue
	LENS-2X3-FR	Frosted
	LENS-2X3-SPR	Spread



3000K
Pure White light 8 Watts



3000K
Pure White light 4 Watts



2700K
Warm White light 4 Watts



WALL WASH

Now available in Black



1838 listed (12V)
1598 listed (120V)

12V

- Integral brightness control
- Mounting stake and direct burial gel-filled wire nuts all included with 12V
- Transformer required (sold separately)

Input: 9-15VAC
Power: 2W to 16W / 2 - 23VA
Brightness: 190 lm to 980 lm
Beam Angle: 15° upward (50° by 80°)
CRI: 85
Rated Life: 70,000 hours



120V Transformer Not Required

- Integral brightness control

Input: 110V - 120VAC
Power: 3.5W to 14.5W
Brightness: 95 lm to 855 lm
Beam Angle: 15° upward (50° by 80°)
CRI: 85
Rated Life: 45,000 hours

2700K Warm White
5021-27BZ Bronze on Aluminum
5021-27BBR Bronze on Brass
5021-27BK Black on Aluminum **New!**

3000K Pure White
5021-30BZ Bronze on Aluminum
5021-30BBR Bronze on Brass
5021-30BK Black on Aluminum **New!**

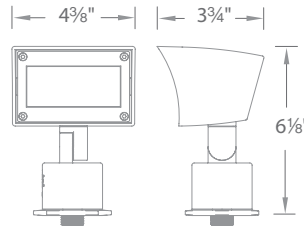

3000K Pure White
5022-30BZ Bronze on Aluminum
5022-30BBR Bronze on Brass
5022-30BK Black on Aluminum **New!**

Accessories For Wall Wash

Wall Wash Optics 	LENS-2X4-AMB	Amber
	LENS-2X4-GRN	Green
	LENS-2X4-RED	Red
	LENS-2X4-BLU	Blue
	LENS-2X4-FR	Frosted
	LENS-2X4-SPR	Spread

Accessories For Mini Accent, Accent, Grand Accent, Mini Wall Wash and Wall Wash

Additional Stake		9000-ST9-BZ	Bronze	Durable PC stake
Surface Mount Flange/Stake		5000-SCP-BZ 5000-SCP-BBR	Bronze on Aluminum Bronze on Brass	Includes three 7 inch threaded stainless steel stabilizing pins for ground mounting or surface mounts with four screws or over a junction box
Guardian Mount		9000-SP9-BZ	Stainless Steel	Heavy duty stainless steel spike to position fixture Formed from a single plate of stainless steel
Gutter Mount Bracket		5000-GM-BZ	Stainless Steel	Stainless Steel universal bracket for mounting in gutter
Tree Mount Junction Box		5000-TCP-BZ	Bronze on Aluminum	Bronze on Aluminum box with Stainless steel mounting screws. Two 1/2" NPT threaded holes
Rod L-Coupler		5000-LCO-BZ	Bronze	
Extension Rods		5000-X04-BZ 5000-X08-BZ 5000-X12-BZ 5000-X18-BZ 5000-X24-BZ	4 in 8 in 12 in 18 in 24 in Bronze	Extends distance between light accent and Surface Mount Canopy, Stake, or Tree Mount box

2' RECESSED INGROUNDS + INDICATORS



2" RECESSED INGROUNDS + INDICATORS

Now available in a single directional light

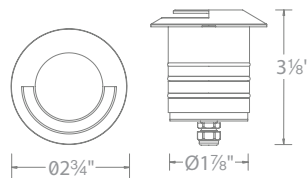

		Model	Finishes
2" SINGLE DIRECTION Optional spring clip accessory included	Input 9-15VAC Power 4.1W / 6.6VA Brightness 5 lm Color Temp 3000K CRI 85 Rated Life 70,000 hours	2091-3055 2091-30BS	Stainless Steel
	6' lead wire included		Bronzed Stainless Steel

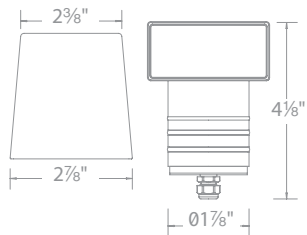

		Model	Finishes
2" GROUND HOOD Optional spring clip accessory included	Input 9-15VAC Power 4.1W / 6.6VA Brightness 25 lm Color Temp 3000K CRI 85 Beam Angle Asymmetrical Rated Life 70,000 hours	2081-305S 2081-30BS	Stainless Steel
	6' lead wire included		Bronzed Stainless Steel

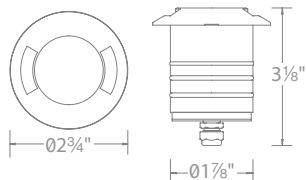

		Model	Finishes
2" BI-DIRECTIONAL Optional spring clip accessory included	Input 9-15VAC Power 4.1W / 6.6VA Brightness 5 lm Color Temp 3000K CRI 85 Rated Life 70,000 hours	2071-305S 2071-30BS	Stainless Steel
	6' lead wire included		Bronzed Stainless Steel

Accessories



2000-CON-PVC

2" Concrete Pour Kit
(1/2" PVC pipe included)

For installation in concrete. Mounts over a 4" outdoor rated junction box.

12V RECTANGULAR STEP & WALL LIGHTS



LOW VOLTAGE STEP LIGHTS



Input: 9 - 15VAC
Power: 2W 3.1VA
Brightness: Up to 38 lm
CRI: 90+
Rated Life: 60,000 hours

- Corrosion-resistant aluminum alloy, or cast stainless steel construction
- Fits into 2" x 4" junction box with minimum inside dimensions of 3"L x 2"W x 2.5"D
- IP66 rated, Protected against high-pressure water jets
- 100 - 10% MLV dimming
- Landscape transformer required (sold separately)

		Model	Color Temp	Finishes
		4071-27 4071-30 4071-AM	2700K 3000K Amber	BK Black on Aluminum BZ Bronze on Aluminum WT White on Aluminum SS Stainless Steel
		4051-27 4051-30 4051-AM	2700K 3000K Amber	BK Black on Aluminum BZ Bronze on Aluminum WT White on Aluminum
		4061-27 4061-30 4061-AM	2700K 3000K Amber	BK Black on Aluminum BZ Bronze on Aluminum WT White on Aluminum
		4031-27 4031-30 4031-AM	2700K 3000K Amber	BK Black on Aluminum BZ Bronze on Aluminum WT White on Aluminum
		4041-27 4041-30 4041-AM	2700K 3000K Amber	BK Black on Aluminum BZ Bronze on Aluminum WT White on Aluminum
		4091-27 4091-30 4091-AM	2700K 3000K Amber	BK Black on Aluminum BZ Bronze on Aluminum WT White on Aluminum

Example: **4071-27SS**

Transformer Required (sold separately)

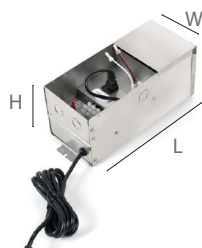

Model	
9075-TRN-SS	75W Max Dimensions: 13.97" L x 5.35"W x 5.63"H
9150-TRN-SS	150W Max Dimensions: 18.90" L x 6.69"W x 6.30"H
9300-TRN-SS	300W Max Dimensions: 18.90" L x 6.69"W x 6.30"H
9600-TRN-SS	600W Max (2 x 300W outputs) Dimensions: 14.49" L x 10.08"W x 5.94"H

MINI TIKI LED AREA LIGHT



TIKI & MINI TIKI LED AREA LIGHT

Now available in a 15inch size

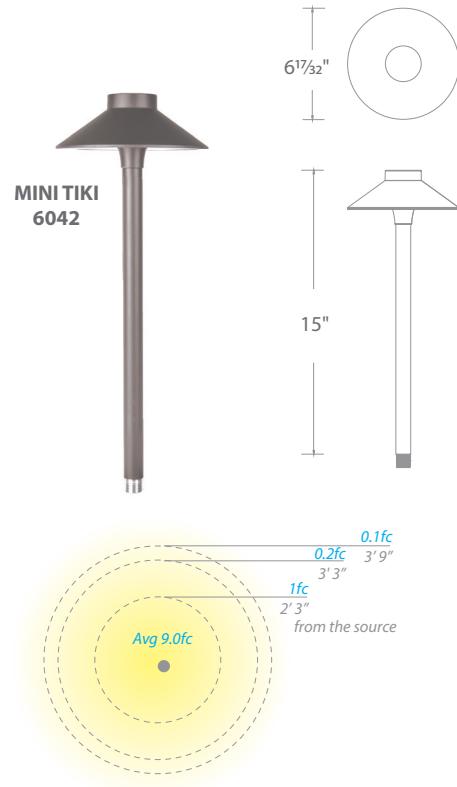
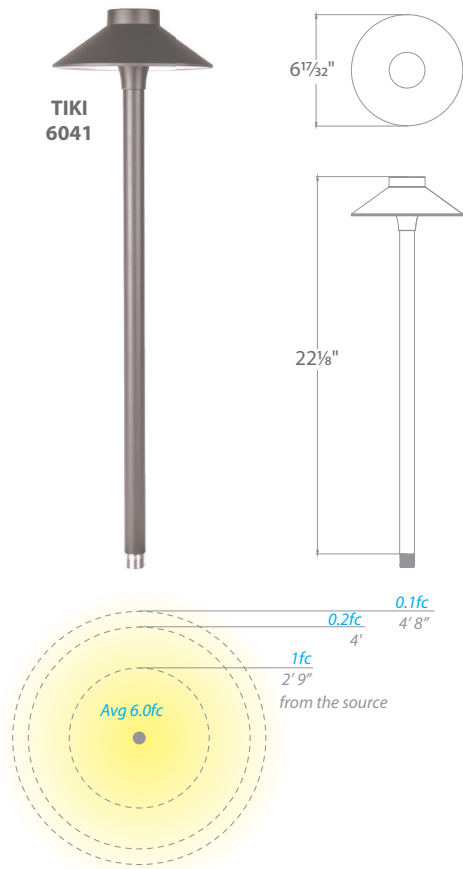
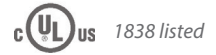

- Sturdy side mount design works well in applications where directional illumination is desired
- **Recommended spacing for installation :**
Residential: 7ft to 9ft
Commercial: 5ft to 7ft

		Model	Color Temp	Finishes
Input:	9 - 15VAC	6041 22"	27 2700K Warm White	BZ Bronze on Aluminum
Power:	6.5W, 9.5VA			
Brightness:	Up to 225 lm	6042 15"	30 3000K Pure White	BK Black on Aluminum
CRI:	90			
Rated Life:	60,000 hours			

Example: 6042-30BK

Mounting stake, 6 foot lead wire, and direct burial gel filled wire nuts included

Accessories

Additional Mounting Stake		9000-ST9-BZ	Bronze	Durable PC stake
Surface Mount Flange/Stake		5000-SCP-BZ 5000-SCP-BBR	Bronze on Aluminum Bronze on Brass	Includes three 7 inch threaded stainless steel stabilizing pins for ground mounting or surface mounts with four screws or over a junction box
Guardian Mount		9000-SP9-BZ	Stainless Steel	Heavy duty stainless steel spike to position fixture Formed from a single piece of metal

Now available in a Higher Power Option and Architectural Black

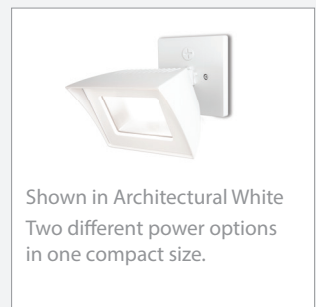
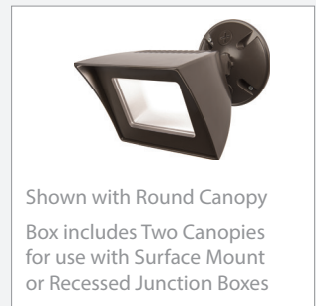

Input: 120V
CRI: 90
Dimming: 100% - 10% ELV
Rated Life: 54,000 hours

- Breathable waterproof technology and factory-sealed LED light engine ensures fixture can maintain stable atmospheric pressure and prevent condensation
- Die-cast aluminum construction
- 120V direct wire—no driver needed
- 1/2" threaded heavy-duty mounting arm
- Photo or motion sensor sold separately

		Power	Comparable	Color Temp	Delivered Lumens	Finish
	Flood	WP-LED335	35.5W	100W HID	30 3000K 2450 50 5000K 2730	aBK Architectural Black aBZ Architectural Bronze aGH Architectural Graphite aWT Architectural White
	New! Flood Pro	WP-LED354	53W	150W HID	35 3500K 3445	

Example: **WP-LED354-35-aWT**

MOTION SENSOR (120V) available in 3 complementary colors

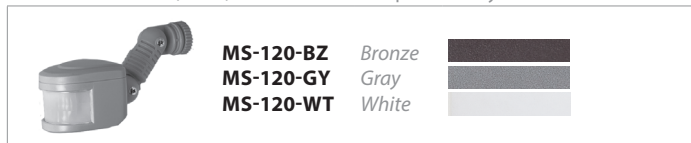

PHOTOSENSOR (120V) available in 3 complementary colors

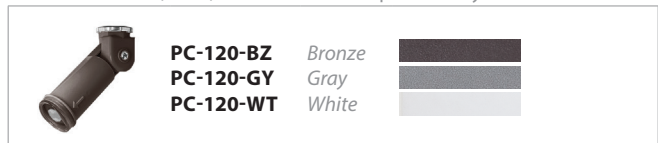

Endurance™ LED SINGLE & DOUBLE SPOT

Now available in Architectural Black



Input: 120V
CRI: 85
Dimming: 100% - 10% ELV
Rated Life: 39,000 hours*

- Factory-sealed LED light engine
- Die-cast aluminum construction
- 120V direct wire - no driver needed
- Photo or motion sensor sold separately

	Power	Comparable	Color Temp	Delivered Lumens	Finish
	15W	75W Halogen	30	965	aBK Architectural Black aBZ Architectural Bronze aGH Architectural Graphite aWT Architectural White
			50	1030	

Example: **WP-LED415-30-aWT**

	Power	Comparable	Color Temp	Delivered Lumens	Finish
	30W	2 x 75W Halogen	30	965 x2	aBK Architectural Black aBZ Architectural Bronze aGH Architectural Graphite aWT Architectural White
			50	1030 x2	

Example: **WP-LED430-30-aBZ**

*WAC Lighting is committed to using the best LEDs available to provide even higher efficacies and improved illumination qualities. Newer LEDs may have only 6,000 hours of actual test data from LM80 reports. While our thermal test results indicate expected lifetimes even better than the previous generation published at 50,000+ hours, we may only report 6X the actual tested hours. The published rated hours above does not represent our expectation of how long you'll be able to enjoy this quality LED luminaire. We will update the rated hours when additional test results are available.

MOTION SENSOR (120V) available in 3 complementary colors

MS-120-BZ	Bronze	
MS-120-GY	Gray	
MS-120-WT	White	

PHOTOSENSOR (120V) available in 3 complementary colors

PC-120-BZ	Bronze	
PC-120-GY	Gray	
PC-120-WT	White	



WAC
LANDSCAPE LIGHTING

Many LED luminaire designs within contain patent pending features.
WAC Lighting will not hesitate to enforce its intellectual property rights through injunctive relief
and seek further relief through damages if it has reason to believe the patents are being infringed upon.

WAC Lighting retains the right to modify the design of our products at any time as part of the company's continuous improvement program.
Please refer to our website for the latest product specifications. Copyright 2018
walandscape-lighting.com