



2019 WAC LIGHTING
ESSENTIALS



WAC LIMITED

POP-IN 4" LED RECESSED



Minimum profile downlight with driver and electrical connection box attached to fixture for easy remodel or new construction installation.

Power: 12W
Input: 120V
Dimming: 100% - 10% ELV, 100%-5% TRIAC
Rated Life: 50,000 hours
CRI: 90

- Electrical wiring box directly on the back of fixture
- Available as a remodel or new construction
- Installs into ceilings between 1/2" and 1 1/2" thick
- Construction: Die-cast aluminum with frosted TIR lens
- 5 Year Warranty

	Model	Beam	Max Lumens	Max CBCP	Color Temp	Finish
	R4DRDR Round Remodel IC-Rated, Airtight Wet location listed	F 45°	1035	1390	930 3000K	WT White
	R4DRDN Round New Construction IC-Rated, Airtight Wet location listed	F 45°	1035	1390	930 3000K	WT White

Example: **R4DRDR-F930-WT**

Frame-In Kit (Optional Accessory)

	Model	Notes
	R4DRDN-FRAME IC-Rated, Airtight	Ceiling thickness: 1/2" - 1 1/2"

OCULUX 2" & 3.5" LED RECESSED

Introductory Performance LED

Engineered with state of the art LED and driver technology, Oculux 3.5" and 2" family of recessed lighting offers various styles, the IC and Airtight Rated housings, and low glare optical distributions to beautifully illuminate a diverse range of applications.

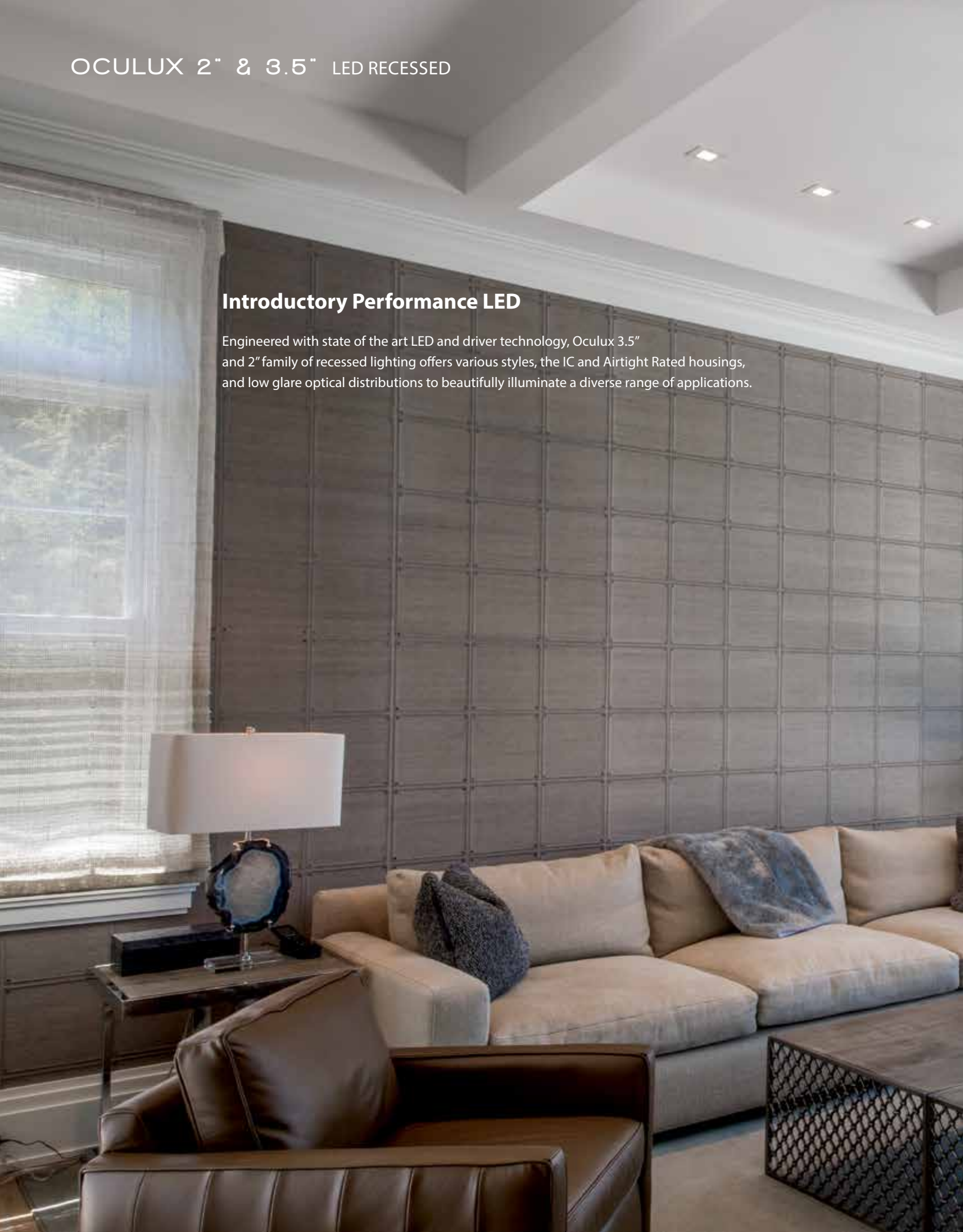

OCULUX 2" LED RECESSED









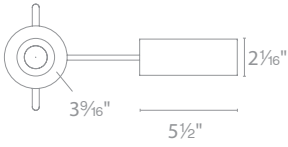
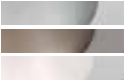

TITLE 24
CALIFORNIA

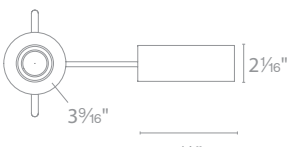

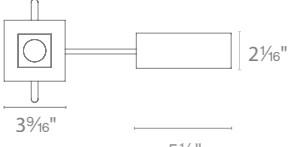
Power: 9W / 11W
Comparable to: 50W MR16
Input: 120V
Rated Life: 50,000 hours

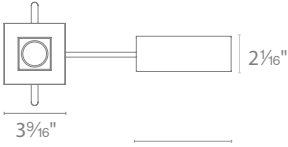
- Sold as new construction, may be reconfigured in the field for remodel use
- Cutout: 3⁹/₁₆"
- Single LED module for high-performance illumination without hot spots
- Ceiling thickness: 1/2"-1"
- ELV or TRIAC or 0-10V dimming compatible

		Model	Max Lumens	Max CBCP	Beam	Color Temp	Finish
 	R2BRD R2BRD-11	680 940	2490 2957	N 25° F 45°	927 2700K 930 3000K	HZWT Haze/White BN Brushed Nickel WT White	
 	R2BRA R2BRA-11	685 1005	3245 4666	S 15° N 25° F 45°	927 2700K 930 3000K	BN Brushed Nickel WT White	
 	R2BSD R2BSD-11	700 955	2462 2749	N 25° F 45°	927 2700K 930 3000K	HZWT Haze/White BN Brushed Nickel WT White	
 	R2BSA R2BSA-11	685 1005	3245 4666	S 15° N 25° F 45°	927 2700K 930 3000K	BN Brushed Nickel WT White	

Example: **R2BRD-11-N930-WT**

INTEGRAL HOUSING AND TRIM: BOTH NEW CONSTRUCTION & REMODEL NEW CONSTRUCTION CONFIGURATION

IC-Rated, Airtight

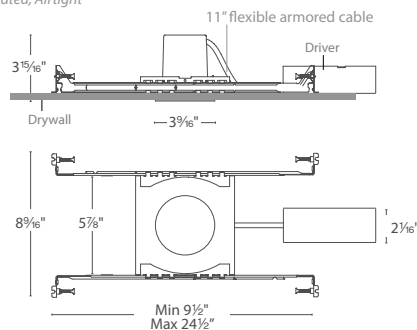

IC-rated and airtight



All-in-one unit, ready to install right out of box





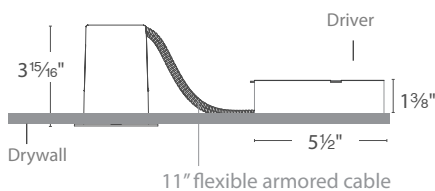

REMODEL CONFIGURATION

IC-Rated, Airtight

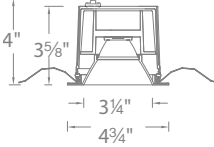

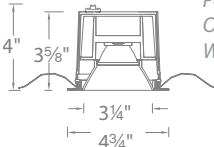
OCULUX 3.5" LED RECESSED

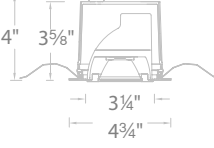

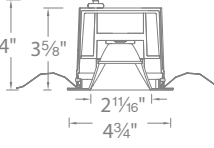
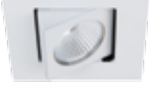
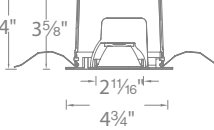
Trims (Order Housing Separately)		Model	Beam	Max Lumens	Max CBCP	Color Temp	Finish
		Round Open Reflector Wet Location Listed 40° visual cutoff R3BRD	S 15° N 25° F 50°	970	5132	927 2700K 930 3000K	HZWT Haze/White BN Brushed Nickel WT White
		Polycarbonate Trim Face* Open Reflector Wet Location R3BRDP	S 15° N 25° F 50°	1025	5144	927 2700K 930 3000K	WT White
<i>*Conforms to local code Dead Front requirements</i>							
		Round 0 - 35° Adjustable 48° visual cutoff R3BRA	S 15° N 25° F 50°	985	4712	927 2700K 930 3000K	BN Brushed Nickel WT White
		Square Open Reflector Wet Location Listed 35° visual cutoff R3BSD	S 15° N 25° F 50°	930	4823	927 2700K 930 3000K	HZWT Haze/White BN Brushed Nickel WT White
		Square 0 - 35° Adjustable 48° visual cutoff R3BSA	S 15° N 25° F 50°	985	4712	927 2700K 930 3000K	BN Brushed Nickel WT White

Example: **R3BRD-S927-WT**



Power: 11W
Comparable to: 75W MR16
Input: 120V or 277V
Rated Life: 50,000 hours
CRI: 90

- IC-rated, Airtight in Remodel and New Construction
- Shallow housing under 4" depth
- Cutout: 4 1/4"
- Single LED module for high-performance illumination without hot spots
- Ceiling thickness: 1/2"-1"
- Dimming: 100% - 5% TRIAC, ELV
100% - 1% 0-10V



Housings (Required) - Order Separately From Trims

	Model	Input	Dimming	Notes	
<p><i>New Construction</i></p>	R3BNICA-10 IC-Rated, Airtight	120V	100% - 5% TRIAC, ELV, 0-10V	Less than 4" plenum depth Allows adjustment in any direction when used with adjustable trims	
	R3BNICA-10U IC-Rated, Airtight	120V - 277V	120V 100% - 5% TRIAC, ELV, 0-10V	277V 100% - 1% 0-10V	Ceiling thickness: 1/2"-1"
	R3BNICA-10U-EM Emergency Backup IC-Rated, Airtight	120V - 277V	120V 100% - 5% TRIAC, ELV, 0-10V	277V 100% - 1% 0-10V	Provides 90 minutes of emergency illumination
<p><i>Remodel</i></p>	R3BBRT-10 IC-Rated	120V	100% - 5% TRIAC, ELV, 0-10V	4 1/4" plenum depth Allows adjustment in any direction when used with adjustable trims Ceiling thickness: 1/2"-1"	

WAC LIMITED

LOTOS 4" & 6" LED RECESSED



Shallow profile LED that is designed to fit in furred down ceilings without sacrificing lumen output. Available in 4" or 6" recessed or 4" adjustable LED recessed.

Input: 120-277V
Rated Life: 50,000 hours
Dimming: 100% - 10% ELV, 100%-5% TRIAC
CRI: 90

- Height: Fixture – 1", Driver 1¼"
- Heavy gauge retention clips secures fixture to ceiling
- Installs into ceilings between ½" and 1 ½" thick
- Construction: Steel with translucent diffuser
- 5 Year Warranty

	Model	Beam	Power	Max Lumens	Color Temp	Finish
	R4ERDR 4" Round Downlight IC-Rated, Airtight	W	9W	550	930 3000K	WT White
	R6ERDR 6" Round Downlight IC-Rated, Airtight	W	14W	1000	930 3000K	WT White

Example: **R4ERDR-W930-WT**

WAC LIMITED

LOTOS 4" ADJUSTABLE LED RECESSED



Shallow profile LED that is designed to fit in furred down ceilings without sacrificing lumen output. Available in 4" or 6" recessed or 4" adjustable LED recessed.

- | | | |
|--------------------|-------------------------------|--|
| Input: | 120-277V | • Height: Fixture – 1 1/8", Driver 1 1/4" |
| Rated Life: | 50,000 hours | • 360° Retractable Pivot: Downlight and Adjustable |
| Dimming: | 100% - 10% ELV, 100%-5% TRIAC | • Heavy gauge retention clips secures fixture to ceiling |
| CRI: | 90 | • Installs into ceilings between 1/2" and 1 1/2" thick |
| | | • Construction: Steel with frosted TIR lens |
| | | • 5 Year Warranty |

	Model	Beam	Power	Max Lumens	Max CBCP	Color Temp	Finish
	R4ERAR 4" Round Adjustable IC-Rated, Airtight	W 45°	9W	750	1020	930 3000K	WT White

Example: **R4ERAR-W930-WT**

WAC LIMITED

DISC FUNCTIONAL LED CEILING LIGHT AND RECESSED RETROFIT



Multiple mid-powered LEDs illuminate the acrylic diffuser uniformly.

Dimming: 100% - 5% ELV, 100%-5% TRIAC

Input: 120V

Rated Life: 36,000 hours

- Construction: Aluminum with translucent diffuser
- 5 Year Warranty



Install over a 3" or 4" junction box or pancake box



Retrofit over a 4", 5" or 6" recessed can

	Model	Lumens	Power	Color Temp	CRI	Finish	
	FM-304	725	12W	930 3000K	90	BN Brushed nickel BZ Bronze WT White	Fits over a 4" recessed can or direct wire in a 3" or 4" junction box or pancake box
	FM-306	950	15W	930 3000K 940 4000K	90	BN Brushed nickel BZ Bronze WT White	Fits over a 5" to 6" recessed can or direct wire in a 3" or 4" junction box or pancake box
	FM-306	950	15W	930JB 3000K	90	WT White	

Example: **FM-306-930JB-WT**

WAC LIMITED

I CAN'T BELIEVE IT'S NOT RECESSED
FUNCTIONAL LED CEILING LIGHT



TITLE 24
CALIFORNIA



Multiple mid-powered LEDs illuminate the acrylic diffuser uniformly without socket shadows which are common in conventional flush mounts.

Input: 120V
CRI: 90
Dimming: 100% - 10% ELV, 100%-5% TRIAC
Rated Life: 54,000 hours

- Imitates a traditional 6" Line voltage recessed downlight with an R30 light bulb.
- Install into 4" Junction box or a combination 3/0-4/0 electrical box.
- Construction: Aluminum with translucent diffuser
- Finished screw caps included to eliminate shadows
- 5 Year Warranty

	Lumens	Power	Color Temp	CRI	Finish	
	FM-616G2-930-WT	1050	16W	3000K	90	White

Example: FM-616G2-930-WT

WAC LIMITED ROUND & SQUARE

FUNCTIONAL LED CEILING OR WALL LUMINAIRE



At just 1/2" thick, these edge-lit flush mounts are frequently replacing the usage of recessed lighting and larger flush mounts to preserve ceiling height. Mounting over standard size junction boxes, the broad illumination is perfect for lighting hallways and other narrow spaces. Available in a range of sizes, smaller sizes are also wet location rated for use outdoors.

Input: 120-277V

CRI: 90

Dimming: 100% - 10% ELV, 100%-5% TRIAC

Rated Life: 50,000 hours

• Sizes: 5"

• Install into 3", 4" or a combination 3/0-4/0 electrical box.

• Construction: Injection molded UV rated PC with translucent diffuser

• Suitable for outdoor and coastal regions

• 5 Year Warranty

	Model	Wattage	Max Lumen	Color Temp	CRI	Finish
	FM-05RN Round	12W	1050	930	3000K	90
				935	3500K	90
	FM-05SQ Square	12W	1030	930	3000K	90
				935	3500K	90
						BZ Bronze NI Nickel WT White

Example: **FM-05RN-930-WT**









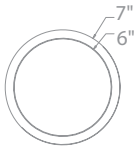

WAC LIMITED ROUND & SQUARE

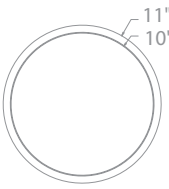
FUNCTIONAL LED CEILING OR WALL LUMINAIRE

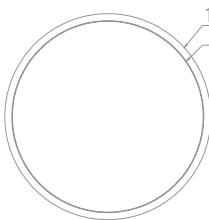

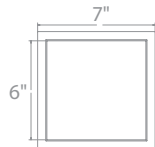
Input: 120V
CRI: 90
Dimming: 100% - 10% ELV, 100%-5% TRIAC
Rated Life: 50,000 hours

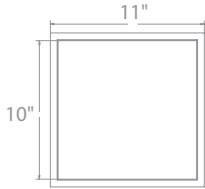
- Sizes: 7", 11", 15" (Round only)
- Install into 3", 4" or a combination 3/0-4/0 electrical box.
- Construction: Aluminum with translucent diffuser
- 5 Year Warranty

		Model	Wattage	Max Lumen	Color Temp	CRI	Finish
		FM-07RN Round	15W	1100			
		FM-11RN Round	20W	1650	930 3000K 935 3500K	90 90	BN Brushed Nickel BZ Bronze WT White
		FM-15RN Round	28W	2550			
		FM-07SQ Square	15W	1100			
		FM-11SQ Square	20W	1650	930 3000K 935 3500K	90 90	BN Brushed Nickel BZ Bronze WT White

Example: **FM-15RN-930-WT**



High light-output, hidden hardware, and broad even illumination are the primary features of this popular flushmount. Often installed in bathrooms, hallways, closets, and dorm rooms, installation is a snap.

Input: 120-277V
Dimming: 100% - 5% ELV, 100%-5% TRIAC
Rated Life: 50,000 hours

- Sizes: 11", 14", 16"
- Install into 3", 4" or a combination 3/0-4/0 electrical box.
- Construction: Aluminum with translucent diffuser
- 5 Year Warranty

		Lumens	Power	Color Temp	CRI	Finish
	FM-211	1320	15W	27 2700K 30 3000K 35 3500K	90	
	FM-214	1790	20W	27 2700K 30 3000K 35 3500K	90	WT White
	FM-216	2445	27W	27 2700K 30 3000K 35 3500K	90	

Example: FM-214-35-WT

WAC LIMITED

BLO 2 FUNCTIONAL LED CEILING AND WALL



With its cleaner profile and higher lumen light performance, BLO 2 is a contemporary flushmount design to accommodate trends in hotel guest room designs and public spaces in multifamily apartment complex.

Input: 120-277V

Dimming: 100% - 10% ELV, 100%-5% TRIAC

Rated Life: 50,000 hours

- Sizes: 13", 15"
- Height: 2 5/8"
- Install into 3", 4" or a combination 3/0-4/0 electrical box.
- Construction: Aluminum with translucent diffuser
- 5 Year Warranty

	Model	Lumens	Power	Color Temp	CRI	Finish
	FM-113G2	1650	20W	27 2700K	90	WT White
30 3000K						
35 3500K						
	FM-115G2	2300	27W	27 2700K	90	WT White
30 3000K						
35 3500K						

Example: **FM-115G2-35-WT**

WAC LIMITED

FLO 2 LED FUNCTIONAL CEILING AND WALL



Slimmer, sleeker, and more durable than its predecessors, FLO2 boasts premium quality light and excellent energy efficiency. A versatile replacement for utility lights in laundry rooms, closets, garages, and bulkheads.

Input: 120-277V
Dimming: 100% - 10% ELV, 100% - 5% TRIAC
Rated Life: 50,000 hours

- Sizes: 24", 36", 48"
- Construction: Aluminum with white acrylic diffuser
- Installation: Wall and Ceiling
- 5 Year Warranty

	Model	Lumens	Power	Color Temp	CRI	Finish
	WS-224G2	1255 1325	16W	27 2700K 30 3000K 35 3500K	90	WT White
	WS-236G2	1915 2130	25W	27 2700K 30 3000K 35 3500K	90	
	WS-248G2	2390 2630	30W	27 2700K 30 3000K 35 3500K	90	

WAC LIMITED

METRO LED FLUSH MOUNT



Multiple mid-powered LEDs deliver soft illumination through translucent acrylic. Metro is available as a wall sconce or as a flush mount to meet a variety of applications. Available in Chrome and Brushed nickel to pair with popular bath hardware.

Input: 120-277V
Dimming: 100%-10% ELV, 100% - 5% TRIAC
Rated Life: 50,000 hours

- Sizes: 12", 18"
- Height: 1 3/4"
- Install into 3", 4" or a combination 3/0-4/0 electrical box.
- Construction: Aluminum with translucent diffuser
- 5 Year Warranty

	Model	Lumens	Power	Color Temp	CRI	Finish
	FM-180112	1600	24W	30 3000K	90	BN Brushed Nickel
	FM-180118	2500	32W	35 3500K		CH Chrome

Example: **FM-180118-30-BN**



Multiple mid-powered LEDs deliver soft illumination through translucent acrylic. Metro is available as a wall sconce or as a flush mount to meet a variety of applications. Available in Chrome and Brushed nickel to pair with popular bath hardware.

- | | | |
|--------------------|-------------------------------|--|
| Input: | 120-277V | • Sizes: 20", 27", 37" |
| Dimming: | 100%-10% ELV, 100% - 5% TRIAC | • Construction: Aluminum with white acrylic diffuser |
| Rated Life: | 50,000 hours | • Installation: Wall and Ceiling |
| | | • 5 Year Warranty |

	Model	Lumens	Power	Color Temp	CRI	Finish
	WS-180120	960	16W	30 3000K 35 3500K	90	BN Brushed Nickel CH Chrome
	WS-180127	1300	20W			
	WS-180137	1950	28W			

Example: **WS-180127-35-BN**



Sleek style with plated brushed nickel finished end caps and high-powered LEDs that provides broad ample illumination. Fuse can be mounted on walls or on the ceiling to suit a variety of applications and styles in current architectural design.

- | | | |
|--------------------|-------------------------------|--|
| Input: | 120-277V | • Sizes: 16", 27", 37" |
| Dimming: | 100%-10% ELV, 100% - 5% TRIAC | • Construction: Aluminum with white acrylic diffuser |
| Rated Life: | 50,000 hours | • Installation: Wall and Ceiling |
| | | • 5 Year Warranty |

	Model	Lumens	Power	Color Temp	CRI	Finish
	WS-180216	900	16W	30 3000K 35 3500K	90	BN <i>Brushed Nickel</i>
	WS-180227	1350	20W			
	WS-180237	1950	28W			

Example: **WS-180216-30-BN**



This low-profile transitional wall sconce provides bountiful light and style. Link adds a clean, modern look to bath vanities and other décor. May be installed horizontally over a vanity or vertically as a sconce.

Input: 120-277V
Dimming: 100%-10% ELV, 100% - 5% TRIAC
Rated Life: 50,000 hours

- Sizes: 27", 37"
- Construction: Aluminum with white acrylic diffuser
- Installation: Wall and Ceiling
- 5 Year Warranty

	Model	Lumens	Power	Color Temp	CRI	Finish
	WS-180327	1225	20W	30 3000K	90	BN Brushed Nickel
	WS-180337	1850	28W			

Example: **WS-180337-30-BN**

WAC LIMITED

TURBO LED VANITY LIGHTS AND WALL SCONCE



A contemporary design provides soft diffused illumination through translucent acrylic. Turbo can be mounted vertically or horizontally to accommodate a variety of applications. Available in Chrome and Brushed nickel to pair with popular bath hardware.

- | | | |
|--------------------|-------------------------------|---|
| Input: | 120-277V | • Sizes: 14", 24" |
| Dimming: | 100%-10% ELV, 100% - 5% TRIAC | • Construction: Aluminum with dual layer acrylic diffuser |
| Rated Life: | 50,000 hours | • Installation: Wall and Ceiling |
| | | • 5 Year Warranty |

	Model	Lumens	Power	Color Temp	CRI	Finish
	WS-180414	1015	12W	30 3000K 35 3500K	90	BN Brushed Nickel CH Chrome
	WS-180424	1550	18W	30 3000K 35 3500K	90	BN Brushed Nickel CH Chrome

Example: **WS-180414-35-BN**

Brink

12", 18", 24" and 36" LED Bath & Sconce

remove?
If not, needs updating



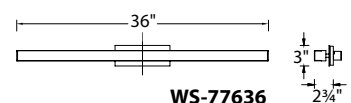
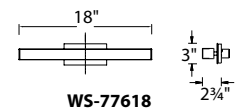
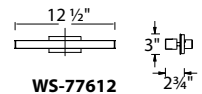

Color Temp: 2700K, 3000K, 3500K
CRI: 90
Dimming: 100%–5% ELV
Rated Life: 85,000 hours
Input: 120–277V

- Co-extruded acrylic diffuser
- Conversion plate for 4" junction box included
- Can be mounted vertically, horizontally or at an angle
- Adjustable backplate
- **2.76" x 1.26" x 1.18" Universal Driver (120V-220V-277V) installs within junction box**
- ADA compliant





A beautiful bar of pure LED light radiates through the co-extruded acrylic diffuser for brighter illumination, and an adjustable back plate adds versatility to this design's many attributes. It's a clean modern sconce anywhere you mount it.

	Size	Color Temp	Watt	LED Lumens	Delivered Lumens	Finish
WS-77612-27	12"	2700K	10W	863	741	AL <i>Brushed Aluminum</i>  BR <i>Brushed Brass</i> 
WS-77612-35		3500K	10W	935	803	
WS-77618-27	18"	2700K	15W	1155	910	
WS-77618-35		3500K	15W	1330	1115	
WS-77624-27	24"	2700K	20W	1595	1330	
WS-77624-35		3500K	20W	1785	1510	
WS-77636-27	36"	2700K	30W	2365	1985	
WS-77636-35		3500K	30W	2561	2180	
WS-77612-30	12"	3000K	10W	905	767	
WS-77618-30	18"		15W	1225	1015	
WS-77624-30	24"		20W	1720	1440	
WS-77636-30	36"		30W	2445	2095	

Example: **WS-77636-30-BR**

Vista

20", 26" & 38" LED Bath & Sconce

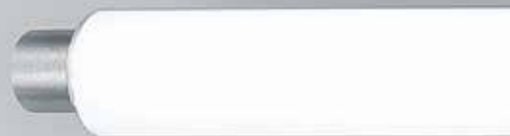

A brilliant outlook . Versatile 1 inch narrow spears of light.

Color Temp: 3000K
CRI: 90
Dimming: 100% - 5% ELV
Rated Life: 54,000 hours
Input: 120 - 277V

- Spot free linear illumination
- Conversion plate for 4" junction box included
- Adjustable backplate (see line drawing for range)*
- Co-extruded clear and white acrylic provides substance, luminosity and optical efficacy
- Mount vertically or horizontally
- 2.76" x 1.26" x 1.18" universal voltage driver (120V-220V-277V) installs within junction box

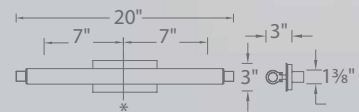

WS-40720

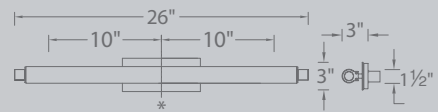

WS-40726

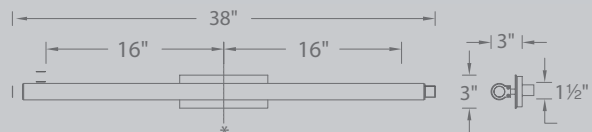

WS-40738

***Driver installs within a junction box**



	Size	Watt	LED Lumens	Delivered Lumens	Finish
WS-40720	20"	15.5W	1385	1190	AL <i>Brushed Aluminum</i> 
WS-40726	26"	21W	1710	1500	
WS-40738	38"	31.5W	2670	2380	

Example: **WS-40720-AL**

SOLO LED FIXED RAIL

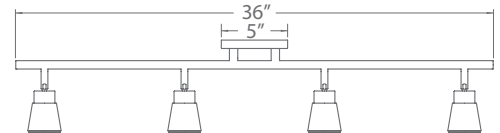
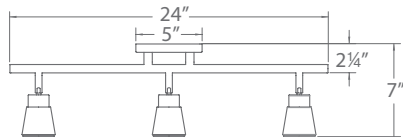
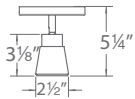

Monopoint 3-head, or 4-head fixed track with individually adjustable LED track fixtures can be wall mounted or ceiling mounted for a wide multitude of applications. It is specifically designed for residential and low-ceiling commercial applications.

- | | |
|--|---|
| <p>Power: 10W/head</p> <p>Delivered Lumens: Up to 800</p> <p>CBCP: Up to 1095</p> <p>Comparable to: 65W MR16</p> <p>Dimming: 100% - 10% ELV, 100%-5% TRIAC</p> <p>Input: 120V</p> <p>Rated Life: 50,000 hours</p> | <ul style="list-style-type: none"> • Monopoint, 3-head, or 4-head fixed rails • Sizes: 5" (Monopoint), 24", 36" • Construction: Die-cast aluminum with frosted TIR lens • Installation: Wall and Ceiling • 350° horizontal and 90° vertical aiming per head • 5 Year Warranty |
|--|---|

System	Model	Lights	Beam	Lumens	CBCP	Color Temp	CRI	Finish
TK	1805	01 03 04	45°	800/head	1095/head	30 3000K	90	BN Brushed Nickel

Example: TK-180503-30-BN



The Charge 8010 track luminaire offers superior light output in a small, unobtrusive design. Developed for residential spaces and lower-mounted commercial applications.

- | | | |
|--------------------------|---------------------------------|---|
| Power: | 11W | • Suitable for H, J or L track |
| Delivered Lumens: | Up to 850 | • Also available as a 4ft track pack kit |
| CBCP: | Up to 1196 | • 350° horizontal and 90° vertical aiming |
| Comparable to: | 65W MR16 | • Construction: Die-cast aluminum with frosted TIR lens |
| Dimming: | 100% - 10% ELV, 100% - 5% TRIAC | • 5 Year Warranty |
| Input: | 120V | |
| Rated Life: | 50,000 hours | |

	System	Model	Beam	Lumens	CBCP	Color Temp	CRI	Finish
	H H Track L L Track J J/J2 Track	8010	45°	850	1196	30 3000K	90	
<p>Track Pack includes</p> <ul style="list-style-type: none"> • 4ft H Track • Floating Canopy • Three 8010 Charge Track Heads 	H H Track	8010/3	45°	850 x3	1196 x3	30 3000K	90	BK Black WT White

Example: **H-8010-30-BK**



SILO X10 2010



Power: 10W
Input: 120V
Beam: 25° and 35° included
Comparable to: 65W MR16
ELV Dimming: 100% - 5%
Rated Life: 50,000 hours

- Field replaceable TIR lens for beam control (35° installed and 25° included in the box)
- Die-cast aluminum construction in a small, and clean design
- Performance luminaire with integral LED and driver
- Abrasion resistant powder-coated finishes
- Accommodates one lens or one glare control accessory

System	Model	Color Temp	CRI	Beam	Lumens	CBCP	Finish	
	H H Track	2010	930	3000K	90	25°	790	2575
	L L Track							
	J J/J2 Track							
				35°	790	1545	BR Brushed Brass BK Black BN Brushed Nickel DB Dark Bronze WT White	

Example: **H-2010-930-BR**

LENS ACCESSORIES

Amber	LENS-11-AMB
Blue	LENS-11-BLU
Green	LENS-11-GRN
Red	LENS-11-RED
Frosted	LENS-11-FR
Spread	LENS-11-SPR
Beam Elongating	LENS-11-BEL

GLARE CONTROL ACCESSORIES

Cross Louver	LENS-11P-CRL-BK
	LENS-11P-CRL-BN
	LENS-11P-CRL-WT
Snoot	LENS-11-SNOOT-BK
	LENS-11-SNOOT-BN
	LENS-11-SNOOT-WT



OCULUX 7011

Power: 11W
Delivered Lumens: Up to 890
CBCP: Up to 4972
Comparable to: 65W MR16
Dimming: 100% - 10% ELV, TRIAC
Input: 120V
Rated Life: 50,000 hours

- **Three beam angle options included (see diagram below):**
 50° optic pre-installed, easily removable
 30° optic interchangeable component
 17° without additional optic.
- Integral driver and high output COB LED
- Outperforms halogen 65W MR16
- 350° horizontal and 90° vertical aiming

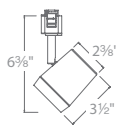
System	Model	Beam	Lumens	CBCP	Color Temp	CRI	Finish
	H H Track	17°	890	4972	930 3000K	90	BK Black BN Brushed Nickel DB Dark Bronze WT White
	L L Track	30°	855	1961			
	J J/J2 Track	50°	830	789			

Example: **H-7011-930-DB**

REPLACEMENT OPTICS

30°	Narrow Flood	FILM-16-N
50°	Flood	FILM-16-F

Interchangeable beam options:

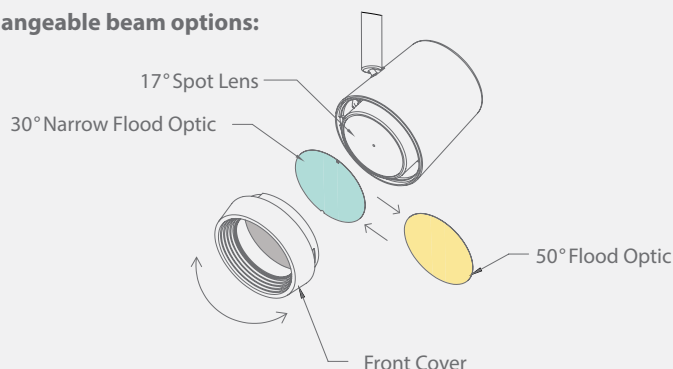

H TRACK SYSTEM

Description: Single circuit H-Track
Power per Circuit: 120V, 1920W max
Operating Current: Rated 20A max



TRACK SECTIONS

Model	Length	Finish	Description
HT H Track	2 2'	BK Black	120V 3-wire track
	4 4'	BN Brushed Nickel	
	6 6'	WT White	
	8 8'	DB* Dark Bronze	

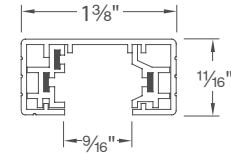

Example: **HT6-BK**

Each section includes two matching end caps.















QUICK CONNECT ADAPTER

Quick Connect Adapter		EN-HQ50AR H Track	BK Black BN Brushed Nickel WT White DB Dark Bronze	Use to easily connect any Quick Connect pendant or fixture. Min.Load: 1W Max Load: 50W
-----------------------	---	--------------------------	---	--

TRACK SUSPENSION

All Track Suspension Kit		SK	18 18" 36 36" 24 24" 48 48"	BK Black BN Brushed Nickel WT White DB Dark Bronze	Extends track from ceiling. Includes track bracket, rod and ceiling canopy.
Suspension Kit Extender		R	18 18" 48 48" 24 24" 72 72" 36 36"	BK Black BN Brushed Nickel WT White DB Dark Bronze	Use with Rod Coupler (RI) to further extend track from ceiling.
Sloped Ceiling Adapter		SK14		BK Black BN Brushed Nickel WT White DB Dark Bronze	Use with suspension kits to accommodate sloped ceilings. Max capacity: 7A, 800W, 120V
Rod Coupler		RI		BK Black BN Brushed Nickel WT White DB Dark Bronze	Join two rods for suspensions longer than 48".
Suspension Adjustment Collar kit		SK05	Includes two collars	BK Black BN Brushed Nickel WT White DB Dark Bronze	Used when suspension rod is field cut to custom lengths. One kit of two required for each rod.
Low Voltage Track Head Extension		X	6 6" 24 24" 12 12" 36 36" 18 18" 48 48"	BK Black BN Brushed Nickel WT White DB Dark Bronze	Extends low voltage track heads from track. Specify extension, fixture and finish. Only available as complete unit. Custom order Example: X18-HHT-809-WT
Line Voltage Track Head Extension (H track only)		H	18 18" 36 36" 24 24" 48 48"	BK Black BN Brushed Nickel WT White DB Dark Bronze	Extends H System line voltage track heads.
Wall Mount Suspension Bracket		TBKT	18"	BK Black BN Brushed Nickel WT White DB Dark Bronze	Extends track 24" from wall. Use two per 4' length, three per 8' length.

Example: **SK24-BK**

ACCESSORIES		Model	Finish	Description
Live End Connector		HLE	BK Black BN Brushed Nickel WT White DB Dark Bronze	4¼" × 1⅜" × ¾" Use for direct wiring through ceiling. A canopy plate is required when using with a standard junction box.
Live End BX Connector		HBXLE	BK Black BN Brushed Nickel WT White DB Dark Bronze	6" × 1⅜" × 1¼" Use with surface mounted BX or non-metallic sheathed cable. Also provides through the ceiling connection.
"I" Power Connector		HI-PWR	BK Black BN Brushed Nickel WT White DB Dark Bronze	6¾" × 1⅜" × ¾" Power entry point at the connection of 2 tracks.
"L" Connector Left		HL-LEFT	BK Black BN Brushed Nickel WT White DB Dark Bronze	2¾" × 2¾" × ¾" Use to join 2 track sections to make power feedable 90° left polarity turns.
"L" Connector Right		HL-RIGHT	BK Black BN Brushed Nickel WT White DB Dark Bronze	2¾" × 2¾" × ¾" Use to join 2 track sections to make power feedable 90° right polarity turns.
"T" Connector		HT	BK Black BN Brushed Nickel WT White DB Dark Bronze	4" × 2¾" × ¾" Use to join 3 track sections. "T" Connector with opposite polarity can be custom ordered.
"X" Connector		HX	BK Black BN Brushed Nickel WT White DB Dark Bronze	4⅞" × 4⅞" × ¾" Use to join 4 track sections.
"I" Connector		HI	BK Black BN Brushed Nickel WT White DB Dark Bronze	3" × 1⅜" × ¾" Use to join two sections of track with electrical continuity.
"I" Dead End Connector		HI-DEC	BK Black BN Brushed Nickel WT White DB Dark Bronze	3" × 1⅜" × ¾" Joins two sections of track without electrical continuity.
Flexible Track Connector		HFLX	BK Black BN Brushed Nickel WT White DB Dark Bronze	9¾" × 1⅜" × ¾" Connects two track sections at variable angles. Use as a transition from wall-to-wall, wall-to-ceiling, or ceiling-to-ceiling. Power feedable.
Suspension Loop		H-LOOP	BK Black BN Brushed Nickel WT White DB Dark Bronze	1⅜" × 1⅜" × 3" 3 inch electrical loop accepts chain hung fixtures up to 35lbs. Contains compartment for electrical connections.
15' Cord, Male Plug		HCORD use with H and J	BK Black WT White	15' Maximum capacity: 7A, 800W, 120V.
T-Bar Drop Ceiling Attachment		T-BARCLIP	Chrome	1½" × 1¼" Attaches track to T-bar drop ceilings. Use two for 2 foot or 4 foot tracks, three for 6 foot or 8 foot tracks.
Monopoint Canopy Adapter		HMP	BK Black BN Brushed Nickel WT White DB Dark Bronze	5⅜" × 5⅜" Mount a single track fixture to a junction box. When used with a low voltage track head the transformer box will protrude off of the face of the monopoint.
Canopy Plate		CP	BK Black BN Brushed Nickel WT White DB Dark Bronze	4½" × 4½" Covers a standard 4 inch junction box. Use with any powerable connectors.
Floating Canopy Connector		HFC	BK Black BN Brushed Nickel WT White DB Dark Bronze	4½" × 4½" × 1½" Connects to octagon box. Allows track to be powered anywhere along the length of the track

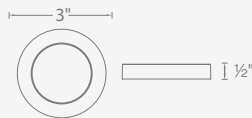

Surface mounted

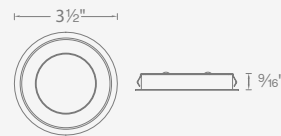

Recessed

Power: 24V, 5W
 CRI: 90
 ELV Dimming: 100% – 5%
 Rated Life: 100,000 hours
 Cutout: 3 1/4" for recessed applications

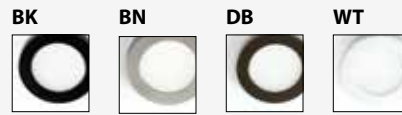

- Can be surface or recessed mounted
- Super thin profile at 1/2"
- Edge-lit LEDs reduce glare and assure even light distribution
- Anti-microbial white paint
- ELV dimming

Model	Color Temp	Lumens	Finish
HR-LED90	27	2700K 200	BK Black
	30	3000K 200	BN Brushed Nickel
			DB Dark Bronze
			WT White



Example: **HR-LED90-30-BN**
 Includes 6 foot lead wire

CLASS 2 ENCLOSED ELECTRONIC TRANSFORMERS (REQUIRED)

Model	Output	Input	Dimming	Min Load	Max Fixture Run	L	W	H	
 cUL _{US} EN-2460-RB2 EN-24100-RB2 EN-24100-277-RB2-T	24V, 60W	120V	ELV	1W	7	6 1/2"	1 5/8"	1 1/4"	Fits through small openings
	24V, 96W	120V	ELV	1W	10	6 1/2"	1 5/8"	1 1/4"	
	24V, 96W	120V-277V	0-10V	1W			12 3/8"	3 1/4"	
 cUL _{US} EN-2460-P-AR	24V, 60W	120V	Yes	1W	7	2 3/4"	1 5/8"	1 3/4"	Plug-in power supply with on/off switch and 6' detachable cord
 MTB-01 Multiple terminal box	12.5A max accommodates up to 6 output connections for 14 AWG wires. Terminal block is used to easily wire together multiple output connections for a neat under cabinet installation without the use of open splices. 3 1/4" L x 1 3/4" W x 7/8" H								

- Secondary wiring for Class 2 transformers does not require conduit sheathed cable or clamp wiring techniques
- Intrinsically safe, Class 2 transformers permit no greater than a 5 amp current to be drawn
- Non-metallic sheathed cable may be used for secondary wiring in walls and ceilings
- Power consumption may vary depending on the efficiency of the power supply being used

BUTTON LIGHTS 24V LED



Recessed or Surface Mount with 24V transformer

Power:	24V, 4.8W	CRI:	85
Lumens:	215 (round), 185 (square)	Dimming:	100% – 10% ELV dimming
Compares To:	20W Xenon Bi-pin	Rated Life:	70,000 hours
Color Temp:	2700K, 3000K	Cutout:	2 1/8" for round recessed applications



Model	Color temp	Finish
 Surface Mount HR-LED87 Round	27 2700K 3000K	BK Black BN Brushed Nickel CB Copper Bronze CH Chrome DB Dark Bronze WT White
 Recessed Mount HR-LED87S Square		

Example: **HR-LED87S-WT** Includes 6 foot lead wire

CLASS 2 ELECTRONIC TRANSFORMERS (REQUIRED)

1W minimum load

- Plug-in power supply with on/off toggle switch and 6' detachable cord
- 1W minimum load

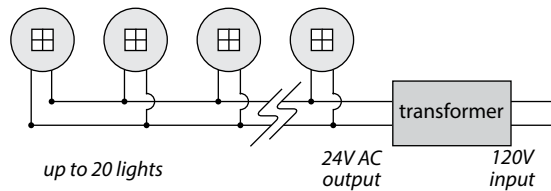

Minimizes wiring back to transformer

Type	Model	Input	Output	Dimming	Power Up To	Dimensions
 Remote	EN-2460-RB2	120V	24V AC/60W	ELV	12 × LED87	6 1/2" x 1 5/8" x 1 1/4"
	EN-24100-RB2		24V AC/96W	ELV	20 × LED87	6 1/2" x 1 5/8" x 1 1/4"
	EN-24100-277-RB2-T	120V-277V	24V AC/96W	0-10V	20 X LED87	12 3/8" x 3 1/4" x 2"
 Plug-In	EN-2460-P-AR	120V	24V AC/60W		12 × LED87	2 3/4" x 1 5/8" x 1 1/4"
 MTB-01 Multiple terminal box		3 1/4" L x 1 3/4" W x 7/8" H				

Retrofit Housing

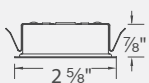

Use to replace HR-88 and HR-86 using existing wiring and cutout, LEDme® Button light not included.

Model #	Finish
HR-LED-COV	BK Black
	BN Brushed Nickel
	CB Copper Bronze
	CH Chrome
	DB Dark Bronze
	WT White

Example: **HR-LED-COV-BK**

Frosted Lens Accessory

Softens light and reduces glare for square or round

Model #
LENS-13-FR

LEDME DUO DIRECT WIRE AC LED COLOR OPTIONS LIGHT BAR

Brushed Aluminum Finish

Minimal space between luminaires

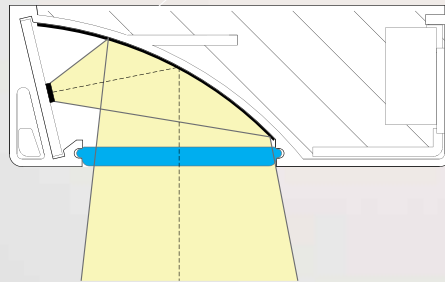

Using a 98% efficient reflector, light from the LED sources inside the housing diffuse inside the mixing chamber in order to create evenly distributed illumination. Patent Pending

LEDME DUO DIRECT WIRE AC LED COLOR OPTIONS LIGHT BAR



TITLE 24
CALIFORNIA



Color Temp: 2700K and 3000K
CRI: 90+
Dimming: 100% – 10% smooth and continuous ELV and TRIAC dimming
Rated Life: 54,000 hours

- Extruded aluminum construction for optimal thermal management
- Indirect diffused light source reduces glare and creates uniform illumination
- Captive screws for easy installation
- Multiple knock outs for ease of wiring
- Thin 1" profile
- 120VAC—no driver needed
- Non-metallic sheathed cable connectors included
- One "I" connector included with each luminaire

	Model	Length	Watt	Lumens	Color Temp	Finish
	BA-ACLED8-27/30	8"	6.0W	370	2700K	BZ Bronze AL Brushed Aluminum WT Anti-Microbial White
	BA-ACLED12-27/30	12"	8.0W	510		
	BA-ACLED18-27/30	18"	10.0W	660	3000K	
	BA-ACLED24-27/30	24"	15.0W	1035		
	BA-ACLED30-27/30	30"	17.5W	1290		
	BA-ACLED36-27/30	36"	19.5W	1540		
BA-ACLED42-27/30	42"	22.5W	1765			

Example: **BA-ACLED12-27/30AL**

Anti-microbial powder coat paint proven to restrain a wide range of bacteria, coliform, mold, fungus, algae and yeast.

- May be hard-wired with 120V power or used with a plug-in power cord
- Subsequent fixtures may be powered with an "I" Connector or Interconnect Cable carrying 120V
- May be individually switched and/or wired to a wall box switch/dimmer

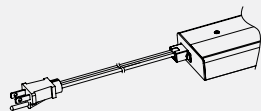

Power Cord

Model	Length
BA-PC6 WT White BK Black	6'

Supplies power in any application.

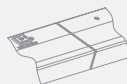

"I" Connector

Model	Max Fixture Run
BA-I-WT	6

Interconnection for seamless end to end transitions. **Each light bar includes one.**

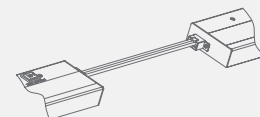

Interconnect Cable

Model	Length	Max Fixture Run	WT White BK Black
BA-IC12	12"	4	WT White BK Black
BA-IC24	24"	4	
BA-IC36	36"	3	

Example: **BA-IC12-WT**

Links two light bars using a single power connection.



Power: 4W/ft
Lumens: Up to 330 lm/ft
CRI: 90
Rated Life: 80,000 hours

- Specially rated for installation in the storage area of a clothes closet
- UV stabilized protective coating protects LEDs and circuitry for long term use in damp locations
- May field cut every 6 inches at the end of a run
- Includes an end cap
- Max run length of 25 feet

TAPE SELECTIONS

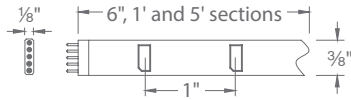

System	Color Temp	Length	Qty	Finish	
LED-TX24	22 2200K	6IN 6 inches	1	WT White	
	27 2700K		1 1 foot		
	30 3000K		5 5 feet		
	35 3500K		1-40 1 foot		40
	45 4500K				

Example: **LED-TX2435-6IN-WT**

"L" CONNECTOR

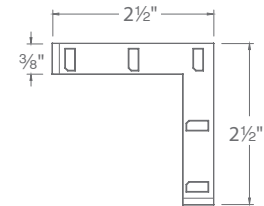

System	Color Temp	Finish
LED-TX24	22 2200K	5L-WT White
	27 2700K	
	30 3000K	
	35 3500K	
	45 4500K	

Example: **LED-TX2435-5L-WT**

Each "L" connector consumes 2 Watts



Power: 3W/ft
Lumens: Up to 215 lm/ft
CRI: 85
Rated Life: 50,000 hours

- Designed for bright cove or task lighting
- UV stabilized protective coating protects LEDs and circuitry for long term use in damp locations
- May field cut every 2 inches at the end of a run
- Includes an end cap
- Maximum run length of 33 feet
- Specially rated for installation in the storage area of a clothes closet

TAPE SELECTIONS

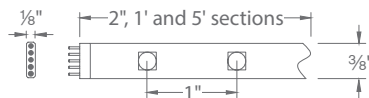

System	Color Temp	Length	Qty	Finish	
LED-T24	W 2700K	2IN 2 inches	1	WT White	
	P 3000K		2IN-10 2 inches		10
	35 3500K		1 1 foot		1
	C 4500K		5 5 feet		1
			1-40 1 foot		40

Example: **LED-T24W-1-40-WT**

"L" CONNECTOR

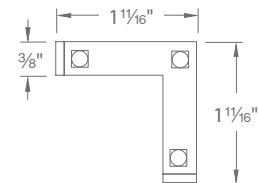



System	Color Temp	Finish
LED-T24	W 2700K	3L-WT White
	P 3000K	
	35 3500K	
	C 4500K	

Example: **LED-T24W-3L-WT**

Each "L" connector consumes 1.2 Watts



COMPATIBLE CLASS 2 POWER SUPPLY (REQUIRED)

Type	Model	Input	Output	Dimming
Remote	 EN-2460-RB2-T	120VAC	24VAC / 60W	ELV
	EN-24100-RB2-T	120VAC	24VAC / 96W	ELV
Remote	 EN-24100-277-RB2-T	120 - 277VAC	24VDC / 96W	0-10V
Plug-in	 EN-2460-P-AR-T	120VAC	24VAC / 60W	Includes a 6 foot lead wire
	EN-24100-P-AR-T	120VAC	24VAC / 96W	

12V OR 24V CAPACITIVE TOUCH SWITCH AND OCCUPANCY CONTROL KIT COMPATIBLE WITH ALL DAMP RATED INVISILED TAPE SYSTEMS



CT-6A-R2

Includes a Touch Panel, an Occupancy Sensor, and a Controller
AC/DC input at 12V(60W Max) or 24V(96W Max)
Connect on secondary side of driver/transformer

LITE INVISILED® DAMP RATED 150 LM/FT TAPE LIGHT



Power: 2W / ft
Lumens: Up to 150 lm / ft
CRI: 85
Rated Life: 50,000 hours

- Specially rated for installation in the storage area of a clothes closet
- UV stabilized protective coating protects LEDs and circuitry for long term use in damp locations
- May field cut every 2 inches at the end of a run
- Includes an end cap
- Max run length of 40 feet per power supply

TAPE SELECTIONS

System	Color Temp	Length	Qty	Finish
LED-T24	27L 2700K 30L 3000K	2IN 2 inches	1	WT White
		2IN10 2 inches	10	
		1 1 foot	1	
		5 5 feet	1	
		1-40 1 foot	40	

Example: **LED-T2427L-5-WT**

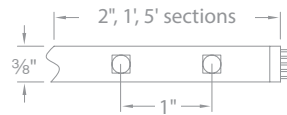

"L" CONNECTOR



System	Color Temp	Finish
LED-T24	27L 2700K 30L 3000K	3L-WT White

Example: **LED-T2427L-3L-WT**

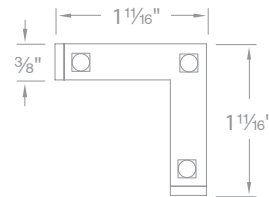
Each "L" connector consumes 0.7 Watts



COMPATIBLE CLASS 2 POWER SUPPLY (REQUIRED)

Type	Model	Input	Output	Dimming
Remote	 EN-2460-RB2-T	120VAC	24VAC / 60W	ELV
	EN-24100-RB2-T	120VAC	24VAC / 96W	ELV
Remote	 EN-24100-277-RB2-T	120 - 277VAC	24VDC / 96W	0-10V
Plug-in	 EN-2460-P-AR-T	120VAC	24VAC / 60W	Includes a 6 foot lead wire
	EN-24100-P-AR-T	120VAC	24VAC / 96W	

See Page 187 and 188 for additional mounting and wiring accessories.

INDOOR ALUMINUM CHANNELS

COMPATIBLE WITH ALL DAMP RATED INVISIBLE TAPE SYSTEMS

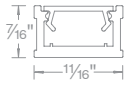

Aluminum Channel **LED-T-CH** 5 feet
Additional End Caps **LED-T-CH-EC** 2 pcs

Diffuses light from InvisiLED tape
 Includes a diffuser, two end caps, and five screws
 Compatible with Pro, Pro2, Pro3, LITE, Classic, Palette
 See pages 1-6, 191-194 for recessed channels

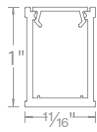

Deep Aluminum Channel **LED-T-CH1** 5 feet
Additional End Cap **LED-T-CH1-EC** 2 pcs

Eliminates visible hot spots
 Includes a diffuser, two end caps, and five screws
 Compatible with Pro, Pro2, Pro3, LITE, Classic, Palette

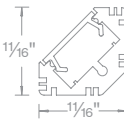

45° Angled Aluminum Channel **LED-T-CH2** 5 feet
Additional End Caps **LED-T-CH2-EC** 2 pcs

Includes a diffuser, two end caps, and five screws
 Compatible with Pro, Pro2, Pro3, LITE, Classic, Palette



Installed with 45° Angled Aluminum Channel in toe kick and Pro 3 InvisiLED®

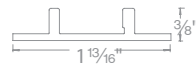
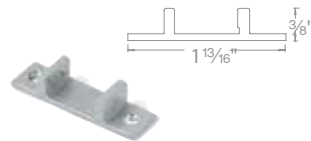

Fixed Channel Clip **LED-T-CL3-PT**

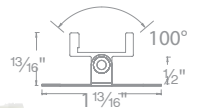
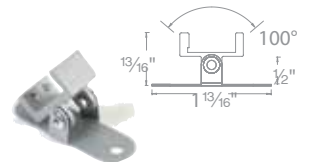

Adjustable Channel Clip **LED-T-CL2-PT**

Includes 2 pieces, 4 screws. Use to mount Aluminum Channel, Deep Aluminum Channel, 45° Angled Aluminum Channel

INDOOR MOUNTING ACCESSORIES

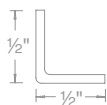

Aluminum Retrofit Channel **LED-T-RC** 3 feet

Can be bent to create fixed curves or used as a glare shield
 Compatible with Pro, Pro2, Pro3, LITE, Classic, Palette

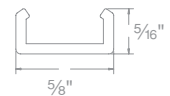

Clear Channel **LED-TO24-CH5** 5 feet



Clip
 For surfaces that are difficult to adhere
LED-T-CL 10 pcs
 10 Screws



Curve Clip
 Secures on one edge
LED-T-CL1 10 pcs
 10 Screws

Clips to hold indoor InvisiLED tapes sections
 Compatible with Pro, Pro2, Pro3, LITE, Classic, Palette

INDOOR CONTROL

Conveniently install an secondary side of power supply for adding senior friendly low voltage lighting to furniture and toe kicks



Capacitive Touch Switch and Occupancy Control Kit **CT-6A-R2**

Includes a Touch Panel, an Occupancy Sensor, and a Controller.
Compatible with WAC low voltage LED (12V or 24V) undercabinet products

INDOOR ELECTRICAL ACCESSORIES

	In Wall Rated Extension Cable	LED-TC-WEXT-144	Black	12 ft
		LED-TC-WEXT-144-WT	White	12 ft
		LED-TC-WEXT-240	Black	20 ft
		LED-TC-WEXT-240-WT	White	20 ft
<i>Extends distance between a hard wired power supply or a wiring box to a tape section.</i>				
	In Wall Rated Joiner Cable	LED-TC-WIC-144	Black	12 ft
		LED-TC-WIC-144-WT	White	12 ft
		LED-TC-WIC-240	Black	20 ft
		LED-TC-WIC-240-WT	White	20 ft
<i>Connects tape sections. 2 female ends. 1 male to male connector included</i>				
	Lead Wire	LED-TC-P-2	Black	2 ft
		LED-TC-P-2-WT	White	2 ft
		LED-TC-P-12	Black	12 ft
		LED-TC-P-12-WT	White	12 ft
<i>Alternative lengths for plug-in power supplies</i>				
	Extension Cable	LED-TC-EXT-144	Black	12 ft
		LED-TC-EXT-144-WT	White	
<i>Extends distance between a hard wired power supply or a wiring box to a tape section</i>				
	Low Voltage Wiring Box With Feed	LED-TC-B-2	Black	L: 1½ in W: ¾ in H: 7⁄8 in
		LED-TC-B-2-WT	White	
<i>Neatly houses connectors for up to two wires with 12" female feed</i>				
	Low Voltage Wiring Box	LED-T-B		L: 1½ in W: ¾ in H: 7⁄8 in
<i>Neatly houses connections for up to two wires</i>				
	Wiring Box With Switch	TB-S		L: 6¼ in W: 1½ in H: 1¼ in
<i>Use when spanning a large gap in a system layout without leaving exposed wiring. Optional switch included</i>				

Compatible with Pro, Pro2, Pro3, LITE, Classic

	LED-TC-IC2	Black	2 in
	LED-TC-IC2-WT	White	2 in
	LED-TC-IC6	Black	6 in
	LED-TC-IC6-WT	White	6 in
	LED-TC-IC12	Black	12 in
	LED-TC-IC12-WT	White	12 in
	LED-TC-IC36	Black	36 in
	LED-TC-IC36-WT	White	36 in
	LED-TC-IC72	Black	72 in
LED-TC-IC72-WT	White	72 in	
<i>Connects tape sections</i>			
	LED-TC-MM	Black	50 Qty

Compatible with Pro, Pro2, Pro3, LITE, Classic, Palette
Change directionality of tape runs and reuse cut ends of tape.

	3-Way "Y" Connector	LED-TC-Y	Black
		LED-TC-Y-WT	White
<i>Connects tape sections</i>			
	4-Way "X" Connector	LED-TC-X	Black
		LED-TC-X-WT	White
<i>Connects tape sections</i>			
	"L" Connector	LED-TC-L	Black
		LED-TC-L-WT	White
<i>Connects tape sections</i>			
	End cap	LED-TC-EC	Black
		LED-TC-EC-WT	White
<i>1 cut and 1 male end cap</i>			

Compatible with Pro, Pro2, Pro3, LITE, Classic, Palette

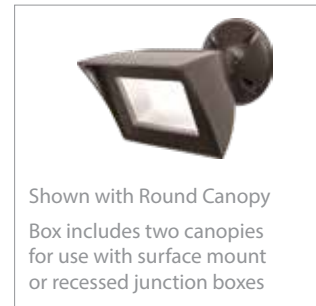

Input	120V
CRI	90
Dimming:	100% - 10% ELV
Rated Life	54,000 hours

- Breathable waterproof technology and factory-sealed LED light engine ensures fixture can maintain stable atmospheric pressure and prevent condensation
- Die-cast aluminum construction
- 120V direct wire—no driver needed
- 1/2" threaded heavy-duty mounting arm
- Photo or motion sensor sold separately

		Power	Comparable	Color Temp	Delivered Lumens	Finish
	Flood	WP-LED335	35.5W	100W HID	30 3000K 2450 50 5000K 2730	aBK Architectural Black aBZ Architectural Bronze aGH Architectural Graphite aWT Architectural White
	Flood Pro	WP-LED354	53W	150W HID	35 3500K 3445	

Example: **WP-LED354-35-aWT**

MOTION SENSOR (120V)

Available in 4 complementary colors

	MS-120-BK	Black
	MS-120-BZ	Bronze
	MS-120-GY	Gray
	MS-120-WT	White

PHOTOSENSOR (120V)

Available in 4 complementary colors

	PC-120-BK	Black
	PC-120-BZ	Bronze
	PC-120-GY	Gray
	PC-120-WT	White



Input: 120V
CRI: 85
Dimming: 100% - 10% ELV
Rated Life: 39,000 hours

- Factory-sealed LED light engine
- Die-cast aluminum construction
- 120V direct wire - no driver needed
- Photo/motion sensor sold separately

	Power	Comparable	Color Temp	Delivered Lumens	Finish
	15W	75W Halogen	30 3000K 50 5000K	965 1030	aBK Architectural Black aBZ Architectural Bronze aGH Architectural Graphite aWT Architectural White

Example: WP-LED415-30-AWT

PHOTOSENSOR (120V)
 Available in 4 complementary colors

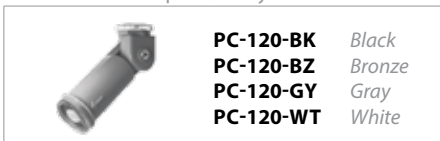

MOTION SENSOR (120V)
 Available in 4 complementary colors





Input: 120V
CRI: 85
Dimming: 100% - 10% ELV
Rated Life: 39,000 hours

- Factory-sealed LED light engine
- Die-cast aluminum construction
- 120V direct wire - no driver needed
- Photo/motion sensor sold separately

		Power	Comparable	Color Temp	Delivered Lumens	Finish
		30W	2 x 75W Halogen	30	965 x2	aBK Architectural Black aBZ Architectural Bronze aGH Architectural Graphite aWT Architectural White
				50	1030 x2	

Example: WP-LED430-30-ABZ

PHOTOSENSOR (120V)
 Available in 4 complementary colors

PC-120-BK Black
PC-120-BZ Bronze
PC-120-GY Gray
PC-120-WT White

MOTION SENSOR (120V)
 Available in 4 complementary colors

MS-120-BK Black
MS-120-BZ Bronze
MS-120-GY Gray
MS-120-WT White

Endurance™ SLIM LED WALL PACKS SECURITY LIGHT



- Factory-sealed LED light engine
- Die-cast aluminum construction
- 20° forward throw illumination
- Built-in level for easy adjustment
- Photo/Motion sensor sold separately



Tempered Prismatic Glass
Reduces glare while optimizing light distribution

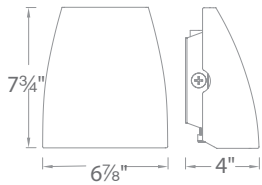

Input	120V-277V
Power	19W/27W/35W
Brigthness	Delivered 1390/2075/2750 lm
Comparable	39W/70W/100W HID
Color Temp	3000K
CRI	85
Dimming:	100% - 10% ELV or 0-10V
Rated Life	100,000 hours

MOTION SENSOR (120V)
Available in 3 complementary colors



- MS-120-BZ** *Bronze*
- MS-120-GY** *Gray*
- MS-120-WT** *White*

3000K *Pure White*

- WP-LED119-30** **aBZ** *Architectural Bronze*
- WP-LED127-30** **aGH** *Architectural Graphite*
- WP-LED135-30** **aWT** *Architectural White*

PHOTOSENSOR (120V)
Available in 3 complementary colors



- PC-120-BZ** *Bronze*
- PC-120-GY** *Gray*
- PC-120-WT** *White*

Endurance™ LED WALL PACK SECURITY LIGHT



- Factory-sealed LED light engine
- Die-cast aluminum construction
- 20° forward throw illumination
- Built-in level for easy adjustment
- Photo/Motion sensor sold separately

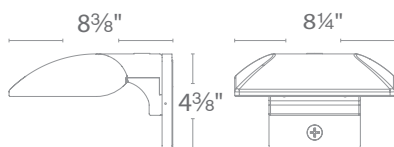

Input	120V-277V
Power	19W/27W
Brighthness	Delivered 1435 lm/2095 lm
Comparable	39W HID/70W HID
Color Temp	3000K/5000K
CRI	85
Dimming:	100% - 10% ELV or 0-10V
Rated Life	100,000 hours

3000K/5000K *Pure White*

WP-LED219-30	aBZ	<i>Architectural Bronze</i>
WP-LED227-30	aGH	<i>Architectural Graphite</i>
	aWT	<i>Architectural White</i>



Mounts in any orientation
For direct and indirect illumination

MOTION SENSOR (120V)

Available in 3 complementary colors



MS-120-BZ	<i>Bronze</i>
MS-120-GY	<i>Gray</i>
MS-120-WT	<i>White</i>



Includes box sleeve. For use with surface mount junction boxes

PHOTOSENSOR (120V)

Available in 3 complementary colors



PC-120-BZ	<i>Bronze</i>
PC-120-GY	<i>Gray</i>
PC-120-WT	<i>White</i>

RUBIX DECORATIVE LED CEILING MOUNTS

Input: 120-277V Color Temp: 3000K Pure White
 Dimming: 100% - 10% CRI: 90
 ELV or 0-10V Rated Life: 70,000 hours

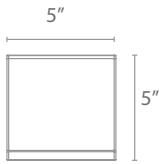

- Ceiling mount
- Die-cast aluminum construction

Beam 86°
 Power 16W
 Lumens 750 lm

FM-W2505

- AL** *Brushed Aluminum*
- BK** *Black*
- BZ** *Bronze*
- GH** *Graphite*
- WT** *White*



Example: FM-W2505-BK

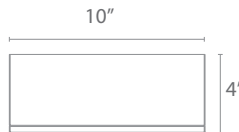

- Ceiling mount
- Die-cast aluminum construction

Beam 95°
 Power 30W
 Lumens 1875 lm

FM-W2510

- AL** *Brushed Aluminum*
- BK** *Black*
- BZ** *Bronze*
- GH** *Graphite*
- WT** *White*

Example: FM-W2510-BK

RUBIX & SCOOP DECORATIVE LED WALL MOUNTS

- Mounts up or down
- Die-cast aluminum construction

Input: 120-277V Color Temp: 3000K Pure White
 Dimming: 100% - 10% ELV or 0-10V CRI: 90
 Rated Life: 70,000 hours



WALL MOUNT



SCOOP WALL MOUNT

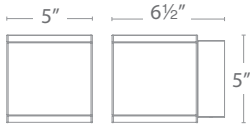

Single light WS-W2504

Beam 86°
 Power 16W
 Lumens 750 lm

Up & Down light WS-W2505

Beam 86°
 Power 30W
 Lumens 1400 lm

WS-W2504 **AL** *Brushed Aluminum*
WS-W2505 **BK** *Black*
BZ *Bronze*
GH *Graphite*
WT *White*

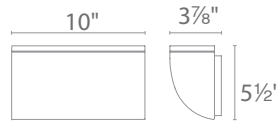

Beam 86°
 Power 16W
 Lumens 805 lm

WS-W20506 **AL** *Brushed Aluminum*
BK *Black*
BZ *Bronze*
GH *Graphite*
WT *White*

Example: WS-W2504-BZ



Example: WS-W20506-BK



WALL MOUNT



Single light WS-W2509

Beam 86°
 Power 16W
 Lumens 805 lm

- Mounts up or down
- Die-cast aluminum construction

WS-W2509 **AL** *Brushed Aluminum*
BK *Black*
BZ *Bronze*
GH *Graphite*
WT *White*

WALL MOUNT



Up & Down light WS-W2510

Beam 86°
 Power 30W
 Lumens 1385 lm

WS-W2510 **AL** *Brushed Aluminum*
BK *Black*
BZ *Bronze*
GH *Graphite*
WT *White*

TUBE DECORATIVE LED CEILING MOUNT

PENDANT

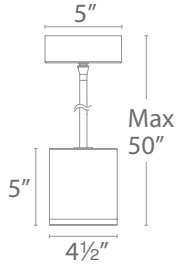

- Die-cast aluminum construction
- Hang straight swivel
- Three 12" and one 6" down rods included
- Dark Sky Friendly

Beam 33°
 Power 16W
 Lumens 800 lm

PD-W2605

- WT** *White*
- BK** *Black*
- BZ** *Bronze*
- GH** *Graphite*
- AL** *Brushed Aluminum*

Example: PD-W2605-BK

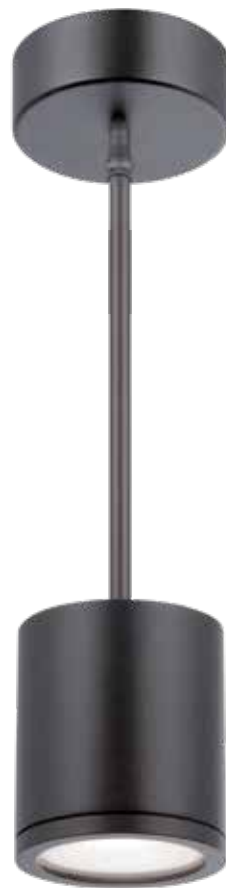

TUBE LED DECORATIVE CEILING MOUNT

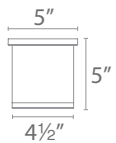

- Ceiling mount
- Die-cast aluminum construction
- Dark Sky Friendly

Beam 35°
 Power 16W
 Lumens 800 lm

FM-W2605

- WT** *White*
- BK** *Black*
- BZ** *Bronze*
- GH** *Graphite*
- AL** *Brushed Aluminum*

Example: FM-W2605-WT

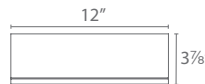

- Ceiling mount
- Die-cast aluminum construction

Beam 91°
 Power 30W
 Lumens 1740 lm

FM-W2612

- WT** *White*
- BK** *Black*
- BZ** *Bronze*
- GH** *Graphite*
- AL** *Brushed Aluminum*

Example: FM-W2612-GH

TUBE DECORATIVE LED WALL MOUNTS

Input: 120-277V Color Temp: 3000K Pure White
 Dimming: 100% - 10% ELV or 0-10V CRI: 90
 Rated Life: 70,000 hours



SINGLE LIGHT WALL MOUNT

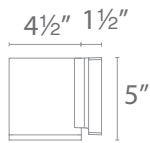

- Mounts up or down
- Die-cast aluminum construction

Beam 33°
 Power 16W
 Lumens 800 lm

WS-W2605

WT White
BK Black
BZ Bronze
GH Graphite
AL Brushed Aluminum

Example: WS-W2605-AL



DOUBLE LIGHT WALL MOUNT

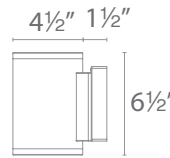

- Die-cast aluminum construction

Beam 33°
 Power 30W
 Lumens 1750 lm

WS-W2604

WT White
BK Black
BZ Bronze
GH Graphite
AL Brushed Aluminum

Example: WS-W2604-AL



SINGLE LIGHT WALL MOUNT



- Mounts up or down
- Die-cast aluminum construction

Beam 70°
 Power 16W
 Lumens 825 lm

WS-W2609

WT White
BK Black
BZ Bronze
GH Graphite
AL Brushed Aluminum

Example: WS-W2609-BK



DOUBLE LIGHT WALL MOUNT



- Die-cast aluminum construction

Beam 70°
 Power 30W
 Lumens 1525 lm

WS-W2610

WT White
BK Black
BZ Bronze
GH Graphite
AL Brushed Aluminum

Example: WS-W2610-BK

STEP LIGHTS LED LANDSCAPE



1838 listed (12V)
1598 listed (120V)

CIRCLE AND SQUARE STEP LIGHTS

- Solid stainless steel construction
- Includes a spring clip for wall or step applications
- 6' lead wire

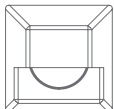
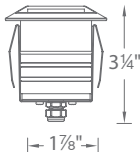
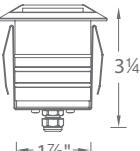

Model

Circle 2041	Square 2061	Input Power	Brightness	Color Temp	CRI	Rated Life	Model	Finishes
 2 3/4"	 2 3/4"	9-15VAC	50 lm	3000 K	85	70,000 hours	2041-30SS 2041-30BS	Stainless Steel Bronzed Stainless Steel
 1 7/8" x 3 1/4"	 1 7/8" x 3 1/4"	4.1W / 6.6VA	50 lm	3000 K	85	70,000 hours	2061-30SS 2061-30BS	Stainless Steel Bronzed Stainless Steel

RECTANGLE STEP LIGHTS

Solid Die-cast brass, corrosion resistant aluminum alloy, or cast stainless steel construction

	12V	120V
Input Power	9 - 15VAC 2W 3.1VA	110 - 120VAC 3.5W
Brightness	Up to 38 lm	Up to 65 lm
CRI	90+	90+
Rated Life	60,000 hours	54,000 hours

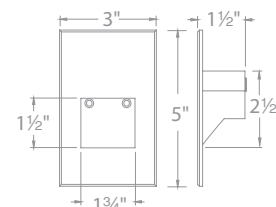
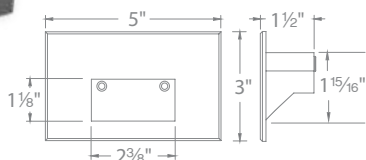

Voltage	Model	Color Temp	Finishes
12V	4011-27	2700K	BBR Bronze on Brass*** BZ Bronze on Aluminum BK Black on Aluminum
	4011-30	3000K	
	4011-AM	Amber	
120V**	WL-LED100-C-	3000K	WT White on Aluminum SS* Cast Stainless Steel
	WL-LED100-AM-	Amber	

Example: 4011-30BZ

*Cast Stainless Steel finish is only available in 3000K and Amber Colors.

**Available in 277V; Example: WL-LED100F-C-WT

*** Bronze on Brass is not available in 277V.

Voltage	Model	Color Temp	Finishes
12V	4021-27	2700K	BZ Bronze on Aluminum BK Black on Aluminum WT White on Aluminum
	4021-30	3000K	
	4021-AM	Amber	
120V**	WL-LED200-C-	3000K	SS* Cast Stainless Steel
	WL-LED200-AM-	Amber	

Example: 4021-AMBK

Endurance™ RETROFIT LED BRICK LIGHTS



- Easily retrofit most existing incandescent brick lights
- Factory-sealed LED light engine
- Die-cast aluminum construction
- 120V direct wire - no driver needed
- Maintenance-free LED upgrade

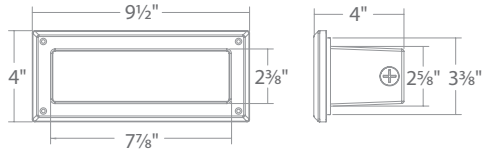

WL-5105
Opal

Input	120V	3000K	<i>Pure White</i>
Power	5.5W		
Brightness	Up to 110 lm		
CRI	90	WL-5105-30	aBK <i>Architectural Black</i>
Dimming:	100% - 10% ELV		aBZ <i>Architectural Bronze</i>
Rated Life	80,000 hours		aGH <i>Architectural Graphite</i>
			aWT <i>Architectural White</i>

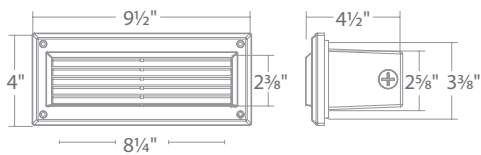

WL-5205
Louver

Input	120V	3000K	<i>Pure White</i>
Power	5.5W		
Brightness	Up to 45 lm		
CRI	90	WL-5205-30	aBK <i>Architectural Black</i>
Dimming:	100% - 10% ELV		aBZ <i>Architectural Bronze</i>
Rated Life	80,000 hours		aGH <i>Architectural Graphite</i>
			aWT <i>Architectural White</i>

WAC LIMITED

120V/277V RECTANGULAR STEP & WALL LIGHTS



Input: 120V, 277V
Brightness: Up to 4 lm
CRI: 90
Dimming: 100% - 10% ELV (120V only)
Rated Life: 50,000 hours

- Fluid decorative profile with full cut-off illumination
- Die-cast aluminum construction with abrasion-resistant powder-coated finish, or plated brushed nickel finish
- Title 24 compliant (120V only)

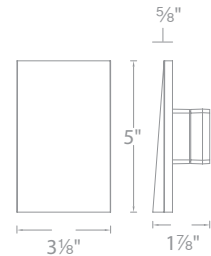
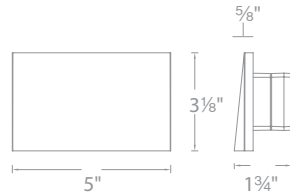

Voltage	Power	Model	Color Temp	Finishes
120V	3.5W	WL-LED110-C	3000K	BK Black on AL BN* Brushed Nickel BZ Bronze on AL WT White on AL
		WL-LED110-AM	Amber	
277V	3W	WL-LED110F-C	3000K	
		WL-LED110F-AM	Amber	

Voltage	Power	Model	Color Temp	Finishes
120V	3.5W	WL-LED210-C	3000K	BK Black on AL BN* Brushed Nickel BZ Bronze on AL WT White on AL
		WL-LED210-AM	Amber	
277V	3W	WL-LED210F-C	3000K	
		WL-LED210F-AM	Amber	

Example: **WL-LED110-C-WT**

Example: **WL-LED210-C-BK**

*BN Finish is not warranted for contact with harsh chemicals or exterior installations.

Input: 120V, 277V
Brightness: Up to 36 lm
CRI: 90
Dimming: 100% - 10% ELV (120V only)
Rated Life: 50,000 hours

- Louvered design shields glare for visual comfort
- Die-cast aluminum construction with abrasion-resistant powder-coated finish
- Title 24 Compliant (120V only)

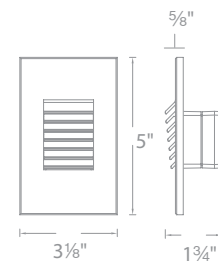
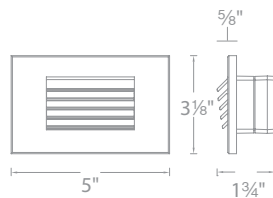

Voltage	Power	Model	Color Temp	Finishes
120V	3.5W	WL-LED120-C	3000K	BK Black on AL BZ Bronze on AL WT White on AL
		WL-LED120-AM	Amber	
277V	3W	WL-LED120F-C	3000K	
		WL-LED120F-AM	Amber	

Voltage	Power	Model	Color Temp	Finishes
120V	3.5W	WL-LED220-C	3000K	BK Black on AL BZ Bronze on AL WT White on AL
		WL-LED220-AM	Amber	
277V	3W	WL-LED220F-C	3000K	
		WL-LED220F-AM	Amber	

Example: **WL-LED120-C-BZ**

Example: **WL-LED220-C-BZ**

AL - Aluminum

WAC LIMITED

120V/277V RECTANGULAR STEP & WALL LIGHTS



Input: 120V, 277V
Brightness: Up to 40 lm
CRI: 90
Dimming: 100% - 10% ELV (120V only)
Rated Life: 50,000 hours

- Tempered glass diffuses light for even illumination
- Die-cast aluminum construction with abrasion-resistant powder-coated finish, or marine-grade stainless steel option available
- Title 24 compliant (120V only)

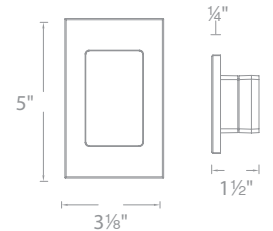
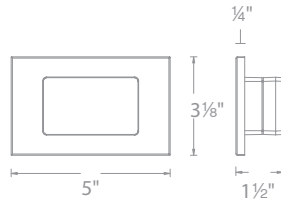

Mounts Vertically or Horizontally

Voltage	Power	Model	Color Temp	Finishes
120V	3.5W	WL-LED130-C	3000K	BK Black on AL BZ Bronze on AL SS Stainless Steel WT White on AL
		WL-LED130-AM	Amber	
277V	3W	WL-LED130F-C	3000K	
		WL-LED130F-AM	Amber	

Example: **WL-LED130-C-SS**

Input: 120V, 277V
Brightness: Up to 3 lm
CRI: 90
Dimming: 100% - 10% ELV (120V only)
Rated Life: 50,000 hours

- Geometric design with downward illumination
- Die-cast aluminum construction with abrasion-resistant powder-coated finish
- Title 24 compliant (120V only)

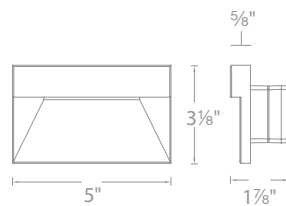

Voltage	Power	Model	Color Temp	Finishes
120V	3.5W	WL-LED140-C	3000K	BK Black on AL BZ Bronze on AL WT White on AL
		WL-LED140-AM	Amber	
277V	3W	WL-LED140F-C	3000K	
		WL-LED140F-AM	Amber	

Example: **WL-LED140-C-BK**

AL - Aluminum

WAC LIGHTING

wacighting.com

ACCENT

IP66 
1838 listed
1598 listed

12V

- Integral brightness control
- Adjustable beam angle 10° to 60°
- One fixture replaces all older halogen landscape accent lights.

Transformer Required (order separately)

Input	9 -15VAC
Power	2W to 16W / 2VA -23VA
Brightness	190 lm to 1045 lm
Beam Angle	10° to 60°
CRI	85
Rated Life	70,000 hours

2700K	Warm White
5011-27	BK Black on Aluminum
	BZ Bronze on Aluminum
	BBR Bronze on Brass

3000K	Pure White
5011-30	BK Black on Aluminum
	BZ Bronze on Aluminum
	BBR Bronze on Brass

120V







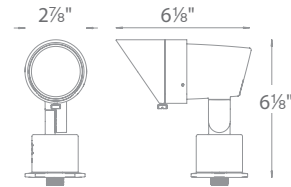



- Integral brightness control
- Adjustable beam angle 15° to 60°
- Simple to retrofit existing line voltage systems or coordinate well with a new commercial landscape job

Input	110V - 120VAC
Power	3.5W to 14.5W
Brightness	100 lm to 900 lm
Beam Angle	15° to 60°
CRI	85
Rated Life	45,000 hours

3000K	Pure White
5012-30	BK Black on Aluminum
	BZ Bronze on Aluminum
	BBR Bronze on Brass



Accessories

6" Long Shroud		5010-LSHR-BK 5010-LSHR-BZ 5010-LSHR-BBR	Black on Aluminum Bronze on Aluminum Bronze on Brass	Reduce glare; ideal for downlighting application	
Accent Snoot		5010-SNOOT-BK 5010-SNOOT-BZ 5010-SNOOT-BBR	Black on Aluminum Bronze on Aluminum Bronze on Brass	Reduce glare; ideal for downlighting application	
9" Mounting Stake		9000-ST9-BZ	Bronze	Durable PC stake	
14" Mounting Stake		9000-ST14-BZ	Bronze	Durable PC stake	
Power Stake		M6000-STAKE	Black	Easy wiring accessory designed for 120V products; eliminates the need for a separate J-box.	
Surface Mount Flange/Stake		5000-SCP-BK 5000-SCP-BZ 5000-SCP-BBR	Black on Aluminum Bronze on Aluminum Bronze on Brass	Includes three 7 inch threaded stainless steel stabilizing pins for ground mounting or surface mounts with four screws or over a junction box	
Guardian Mount		9000-SP9-BZ	Stainless Steel	Heavy duty stainless steel spike to position fixture; formed from a single piece of metal	
Gutter Mount Bracket		5000-GM-BK 5000-GM-BZ	Black on Stainless Steel Bronze on Stainless Steel	Stainless steel universal mounting bracket for gutter mounting fixture	
Tree Mount Junction Box		5000-TCP-BK 5000-TCP-BZ	Black on Aluminum Bronze on Aluminum	Aluminum box with stainless steel mounting screws; two 1/2" NPT threaded holes	
		5000-TCL-BK 5000-TCL-BZ	Black on Aluminum Bronze on Aluminum	Large Aluminum box with stainless steel mounting screws; two 1/2" NPT threaded holes	
Large Tree Mount Canopy Strap		5000-TST-BK	Black on Steel and terylene	Ratcheting device with strap to be used with Large Tree Mount Junction Box (5000-TCL)	
Optics		LENS-20-AMB Amber LENS-20-GRN Green LENS-20-RED Red	LENS-20-BLU Blue LENS-20-FR Frosted LENS-20-SPR Spread	LENS-20-BEL Beam Elongating	Enhances saturation of florals and foliage

Mounting stake (12V), Detachable shroud, 6' lead wire and direct burial gel filled wire nuts (12V) or standard wire nuts (120V) included

WALL WASH

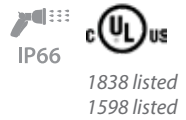

12V

- Integral brightness control

Input	9 -15VAC
Power	2W to 16W / 2 - 23VA
Brightness	190 lm to 980 lm
Beam Angle	15° upward (50° by 80°)
CRI	85
Rated Life	70,000 hours

2700K Warm White

5021-27	BK Black on Aluminum
	BZ Bronze on Aluminum
	BBR Bronze on Brass

3000K Pure White

5021-30	BK Black on Aluminum
	BZ Bronze on Aluminum
	BBR Bronze on Brass

Transformer Required (order separately)

120V

- Integral brightness control

Input	110V - 120VAC
Power	3.5W to 14.5W
Brightness	95 lm to 855 lm
Beam Angle	15° upward (50° by 80°)
CRI	85
Rated Life	45,000 hours

3000K Pure White

5022-30	BK Black on Aluminum
	BZ Bronze on Aluminum
	BBR Bronze on Brass

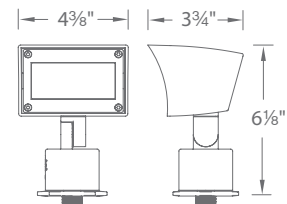

Accessories

9" Mounting Stake		9000-ST9-BZ	Bronze	Durable PC stake
14" Mounting Stake		9000-ST14-BZ	Bronze	Durable PC stake
Power Stake		M6000-STAKE	Black	Easy wiring accessory designed for 120V products; eliminates the need for a separate J-box.
Surface Mount Flange/Stake		5000-SCP-BK 5000-SCP-BZ 5000-SCP-BBR	Black on Aluminum Bronze on Aluminum Bronze on Brass	Includes three 7 inch threaded stainless steel stabilizing pins for ground mounting or surface mounts with four screws or over a junction box
Guardian Mount		9000-SP9-BZ	Stainless Steel	Heavy duty stainless steel spike to position fixture; formed from a single piece of metal
Gutter Mount Bracket		5000-GM-BZ 5000-GM-BK	Black on Stainless Steel Bronze on Stainless Steel	Stainless steel universal mounting bracket for gutter mounting fixture
Tree Mount Junction Box		5000-TCP-BK 5000-TCP-BZ	Black on Aluminum Bronze on Aluminum	Aluminum box with Stainless steel mounting screws; two 1/2" NPT threaded holes
Extension Rods		5000-X04-BZ/BK 4 in 5000-X08-BZ/BK 8 in 5000-X12-BZ/BK 12 in	5000-X18-BZ/BK 18 in 5000-X24-BZ/BK 24 in	Extends distance between Accent light and surface mount canopy, stake, or tree mount box
Rod L-Coupler		5000-LCO-BK 5000-LCO-BZ	Black Bronze	
Wall Wash Optics		LENS-2X4-AMB Amber LENS-2X4-GRN Green LENS-2X4-RED Red	LENS-2X4-BLU Blue LENS-2X4-FR Frosted LENS-2X4-SPR Spread	Enhances saturation of florals and foliage and turtle friendly

Mounting stake (12V), detachable shroud, 6' lead wire and direct burial gel filled wire nuts (12V) or standard wire nuts (120V) included

3" INGROUND

IP67



1838 listed
1598 listed

12V

- Integral brightness control
- Adjustable beam angle
- Directional aim with +/- 20° Tilt

Input Power	9-15VAC 2W to 12W / 2-17VA
Brightness	70 lm to 505 lm
Beam Angle	15° to 60°
CRI	85
Rated Life	55,000 hours

2700K	Warm White
5031-27	BZ Bronze on Aluminum
	BBR Bronze on Brass

3000K	Pure White
5031-30	BZ Bronze on Aluminum
	BBR Bronze on Brass

120V



- Integral brightness control
- Adjustable beam angle

Input Power	110V - 120VAC 3W to 11.5W
Brightness	65 lm to 515 lm
Beam Angle	15° to 60°
CRI	85
Rated Life	45,000 hours

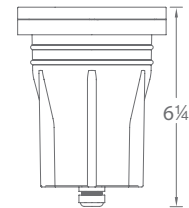
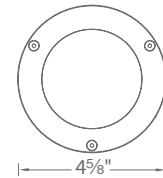
3000K	Pure White
5032-30	BZ Bronze on Aluminum
	BBR Bronze on Brass



Accessories

Rock Guard		5030-GRD-BZ 5030-GRD-BBR	Bronze on Aluminum Bronze on Brass	Protects the fixture surface
Optics		LENS-25-AMB LENS-25-GRN LENS-25-RED LENS-25-BLU LENS-25-FR LENS-25-HCL	Amber Green Red Blue Frosted Honeycomb Louver reduces glare	Enhances saturation of florals and foliage
Concrete Pour Kit		5030-PIP-PVC	Shown with temporary dense foam cap	For installation in concrete; five 1/2" NPT threaded holes, PC

6' lead wire and direct burial gel filled wire nuts (12V) or standard wire nuts (120V) included

TRANSFORMER LED LANDSCAPE

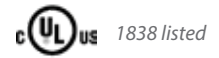





- IP65 Rated
- 12V to 15V taps
- Knock outs for power and photosensor connections
- 3-prong outlet for timer
- Outdoor rated stainless steel transformer contains an outdoor rated 3-prong plug for power



Model	
9075-TRN-SS	75W Max Dimensions: 13.97" L x 5.35"W x 5.63"H
9150-TRN-SS	150W Max Dimensions: 18.90" L x 6.69"W x 6.30"H
9300-TRN-SS	300W Max Dimensions: 18.90" L x 6.69"W x 6.30"H
9600-TRN-SS	600W Max (2 x 300W outputs) Dimensions: 14.49" L x 10.08"W x 5.94"H

ACCESSORIES LED LANDSCAPE

Mechanical Timer		9000-MTI-WT	White	Connect within the transformer
Photosensor		9000-PCH-GY	1000VA Max	Attached directly to the transformer
Photosensor - Remote		9000-PCR-GY	1000VA Max	If transformer is located in a shady spot, this photosensor has a 10 foot cord and a stainless steel bracket to secure in a sunny area
Direct Burial Water proof Wire Nuts		9020-WNT-BK		Silicone filled wire nut with gasket (Pack of 20pcs)
12V Direct Burial Outdoor Cable		9100-12G-BK 9250-12G-BK 9500-12G-BK	100 feet 12 gauge 250 feet 12 gauge 500 feet 12 gauge	



WAC LIGHTING

wacighting.com
1-800-526-2588