The background features a series of flowing, overlapping blue lines that create a sense of movement and depth, resembling a stylized wave or a digital signal. The lines are more prominent on the left and bottom, fading into the dark background towards the top and right.

WAC

2020

OCULUX ARCHITECTURAL 2" MULTIPLE SPOTS

LED RECESSED MULTIPLE SPOTS

TITLE 24
CALIFORNIA



Unobtrusive, low profile design provides superior color rendering regardless of color temperature. Rare earth magnetic light engine mounting makes installation and maintenance easy.



Minimal Footprint
Small housing fits into tight plenum spaces

Performance per light engine

Up to 795lm	8.5W	IC
Up to 1280lm	15W	Non IC

Design Flexibility
Choice of IC or Non IC and power options

- 2700K 90CRI
- 3000K 90CRI
- 3500K 90CRI
- 4000K 90CRI

Quality Illumination
90 CRI for excellent color rendering across multiple CCT options



Versatility
Individual light engine control standard / Universal dimming protocols



TITLE 24
CALIFORNIA

Feature Rich
Wet Location standard / Title 24 Compliant /
Magnetic light engine for ease of servicability

OCULUX ARCHITECTURAL 2" MULTIPLE SPOTS

LED RECESSED MULTIPLE SPOTS

HOUSING

Universal Housing 120V - 277V
 Airtight, IC Rated and Non IC option
 Universal housing can be used with Trim or Trimless

Light engines can be independently operated



ADJUSTABLE LIGHT ENGINE

Revolutionary design ensures center beam alignment is maintained throughout 0°-40° tilt and 360° horizontal rotation

Rare earth magnetic light engine mounting makes both installation and maintenance easy

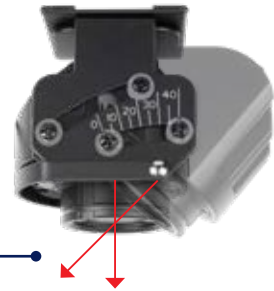

ACCESSORIES

Optional field changeable optic film accessories available

Accommodates one lens or glare control accessory
 Accessory holder sold separately

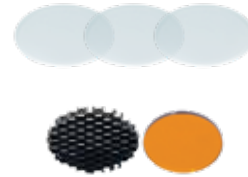

TRIMS

Powder coated die-cast aluminum construction Wet Location with optional lens

BEVEL

General illumination with high lumen output

PINHOLE

Small aperture with superior glare control

TRIM



TRIMLESS



TRIM



TRIMLESS

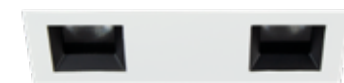



OCULUX ARCHITECTURAL 2" MULTIPLE SPOTS

BEAM SPECIFIC OPTICS



Accessory Films
included in Optic
Film Package

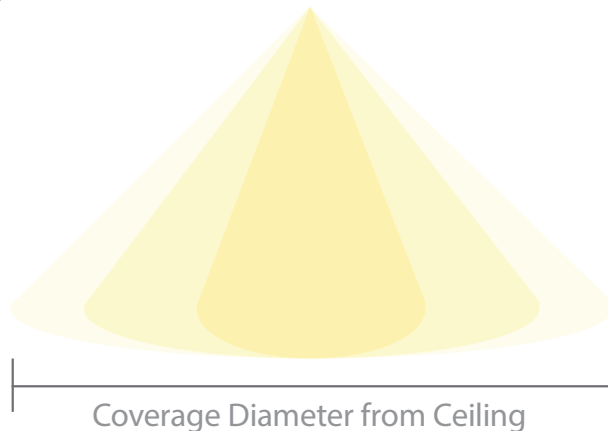
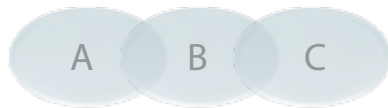

ACCESSORY OPTIC FILMS sold separately

MT-2-FILM

Optic Film Package: includes 3 films (A, B, C)

LENS-11-HLD Required (sold separately)

Primary Optic	Accessory Film	Resulting Beam
S (16°)	A	25°
S (16°)	B	45°
S (16°)	C	55°
N (30°)	A	35°
N (30°)	B	55°
N (30°)	C	65°
F (50°)	A	52°
F (50°)	B	70°
F (50°)	C	80°

Coverage Diameter From 8' Ceiling in feet

Primary Optic	No Film	+ Film A	+ Film B	+ Film C
Spot	2'	3.5'	6.5'	8.5'
Narrow	4.5'	5'	8.5'	10'
Flood	7.5'	8'	11'	13.5'

Coverage Diameter From 10' Ceiling in feet

Primary Optic	No Film	+ Film A	+ Film B	+ Film C
Spot	3'	4.5'	8.5'	10.5'
Narrow	5.5'	6.5'	10.5'	12.5'
Flood	9.5'	10'	14'	17'

OCULUX ARCHITECTURAL 2" MULTIPLE SPOTS

LED RECESSED MULTIPLE SPOTS



Comparable: 75W MR16
Input: 120V - 277V
Rated Life: 50,000 hours
CRI: 90
Dimming: 100%-5% ELV, TRIAC
 100%-5% 0-10V

- Vertical adjustable aiming 40°, horizontal adjustable aiming 360°
- Refined 2" aperture and shallow <4" housing height
- Bevel and pinhole trim options
- Trim and Trimless (shared housing)
- Accommodates one lens accessory or honeycomb louver
- Rare earth magnetic light engine mounting

1 LIGHT

	Model	Finish
	MT-21DT 1 Light Trim Bevel	BK WT Black White
	MT-21DL 1 Light Trimless Bevel	BK WT Black White
	MT-21PT 1 Light Trim Pinhole	BK WT Black White trim with black interior
	MT-21PL 1 Light Trimless Pinhole	BK WT Black White trim with black interior

Example: **MT-21DL-WT**

	Power	Beam	Bevel Trim		Pinhole Trim		Color Temp
			Max Lumens	Max CBCP	Max Lumens	Max CBCP	
	8.5W	S 16° N 30° F 50°	700	6075	680	5915	927 2700K 930 3000K 935 3500K 940 4000K
			650	1825	605	1830	
			795	1095	760	1070	
	15W	S 16° N 30° F 50°	1085	9660	1070	9510	
			1055	2840	920	2825	
			1280	1765	1180	1665	

Example: **MT-2109-S935**

ACCESSORY HOLDER sold separately

LENS-11-HLD Required for use with any lens or accessory

GLARE CONTROL ACCESSORIES sold separately

LENS-11-HCL Honeycomb Louver

LENS ACCESSORIES sold separately

LENS-11	AMB Amber	SPR Spread
	RED Red	BEL Beam Elongating
	FR Frosted	

OCULUX ARCHITECTURAL 2" MULTIPLE SPOTS

LED RECESSED MULTIPLE SPOTS



Comparable: 75W MR16
Input: 120V - 277V
Rated Life: 50,000 hours
CRI: 90
Dimming: 100%-5% ELV, TRIAC
 100%-5% 0-10V

- Vertical adjustable aiming 40°, horizontal adjustable aiming 360°
- Refined 2" aperture and shallow <4" housing height
- Bevel and pinhole trim options
- Trim and Trimless (shared housing)
- Accommodates one lens accessory or honeycomb louver
- Rare earth magnetic light engine mounting

2 LIGHT

	Model	Finish
	MT-22DT 2 Light Trim Bevel	BK WT Black White
	MT-22DL 2 Light Trimless Bevel	BK WT Black White
	MT-22PT 2 Light Trim Pinhole	BK WT Black White trim with black interior
	MT-22PL 2 Light Trimless Pinhole	BK WT Black White trim with black interior

Example: **MT-22DT-WT**

	Power	Beam	Bevel Trim		Pinhole Trim		Color Temp	
			Max Lumens	Max CBCP	Max Lumens	Max CBCP		
<p>MT-2209 New Construction 17W IC Rated, Airtight</p>	17W	S 16° N 30° F 50°	700 x2	6075 x2	680 x2	5915 x2	927 930 935 940	2700K 3000K 3500K 4000K
			650 x2	1825 x2	605 x2	1830 x2		
			795 x2	1095 x2	760 x2	1070 x2		
<p>MT-2215 New Construction 30W Non-IC, Airtight</p>	30W	S 16° N 30° F 50°	1085 x2	9660 x2	1070 x2	9510 x2		
			1055 x2	2840 x2	920 x2	2825 x2		
			1280 x2	1765 x2	1180 x2	1665 x2		

Example: **MT-2209-S935**

OCULUX ARCHITECTURAL 2" MULTIPLE SPOTS

LED RECESSED MULTIPLE SPOTS



Comparable: 75W MR16
Input: 120V - 277V
Rated Life: 50,000 hours
CRI: 90
Dimming: 100%-5% ELV, TRIAC
 100%-5% 0-10V

- Vertical adjustable aiming 40°, horizontal adjustable aiming 360°
- Refined 2" aperture and shallow <4" housing height
- Bevel and pinhole trim options
- Trim and Trimless (shared housing)
- Accommodates one lens accessory or honeycomb louver
- Rare earth magnetic light engine mounting

3 LIGHT

	Model	Finish
	MT-23DT 3 Light Trim Bevel	BK WT Black White
	MT-23DL 3 Light Trimless Bevel	BK WT Black White
	MT-23PT 3 Light Trim Pinhole	BK WT Black White trim with black interior
	MT-23PL 3 Light Trimless Pinhole	BK WT Black White trim with black interior

Example: **MT-23PT-BK**

	Power	Beam	Bevel Trim		Pinhole Trim		Color Temp
			Max Lumens	Max CBCP	Max Lumens	Max CBCP	
<p>MT-2309 New Construction IC Rated, Airtight</p>	25.5W	S 16° N 30° F 50°	700 x3	6075 x3	680 x3	5915 x3	927 2700K 930 3000K 935 3500K 940 4000K
			650 x3	1825 x3	605 x3	1830 x3	
			795 x3	1095 x3	760 x3	1070 x3	
<p>MT-2315 New Construction Non-IC, Airtight</p>	45W	S 16° N 30° F 50°	1085 x3	9660 x3	1070 x3	9510 x3	
			1055 x3	2840 x3	920 x3	2825 x3	
			1280 x3	1765 x3	1180 x3	1665 x3	

Example: **MT-2315-S935**

OCULUX ARCHITECTURAL 3.5" DIM-TO-WARM LED RECESSED

The LED downlight that warms as you dim.
Imitates incandescent light with our intuitive Dim to Warm technology.

ELV, TRIAC, and 0-10V dimming protocols
available standard for intergration with
virtually any control system.



3000K



GAME NIGHT

PURE WHITE LIGHT TO
SEE EVERYTHING CRYSTAL CLEAR

Delivers up to 1025 lumens at a
brilliant pure white 3000K and 95+ CRI.
Perfect to complete all necessary visual tasks.



1800K



MOVIE NIGHT

WARM INCANDESCENCE TO
RENDER CANDLES UNNECESSARY

Set the mood in dimmed
ambience at a warm glow of 1800K.
Unwind to a relaxing evening movie or dinner.

OCULUX ARCHITECTURAL 3.5" DIM-TO-WARM LED RECESSED

FOUR-IN-ONE NEW CONSTRUCTION HOUSING

Downlight, 0° - 30° Adjustable, Pinhole and Wall Wash



HOUSING

Universal Housing 120V - 277V
Airtight, IC Rated and Non IC option
Round and Square option

Field adjustable collar adapts to 1/2" - 1" ceiling thicknesses

Die-cast trimless spackle frame included



ADJUSTABLE LIGHT ENGINE

Sliding 0° - 30° tilt maximizes light extraction through aperture
365° horizontal rotation with dim-to-warm LED technology



Indexed hot aiming



SPOT & FLOOD OPTICS

Narrow beam TIR Lens pre-installed with every housing
Interchangeable Flood optic supplied

TRIMS

Powder coated die-cast aluminum construction Wet
Location with optional lens

TRIM

TRIMLESS



DOWNLIGHT & ADJUSTABLE

0° - 30° adjustment above the ceiling

ADJUSTABLE PINHOLE

0° - 30° adjustment above the ceiling

WALL WASH

Adjusted to 15° position

TRIM

TRIMLESS

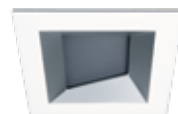

OCULUX ARCHITECTURAL 3.5" DIM-TO-WARM LED RECESSED



ROUND NEW CONSTRUCTION HOUSING

Downlight, 0° - 30° Adjustable, Adjustable Pinhole and Wall Wash
Universal Voltage and Universal Dimming
IC and Non IC, Airtight, and Wet Location listed

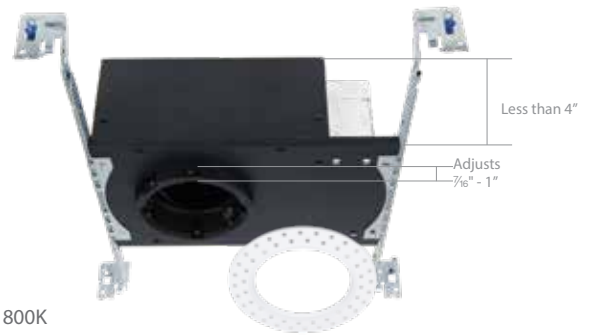

- | | | |
|--------------------|--------------|--|
| Power: | 13W, 16W | • Dim to Warm color temperature range: 3000K-1800K |
| Comparable: | 75W PAR30 | • Die-cast trimless spackle frame included for use with flangeless trims |
| Input: | 120V - 277V | • Vertical Adjustment 0 - 30°, Horizontal Adjustment 365° |
| Rated Life: | 50,000 hours | • Dimming: 100% - 1% ELV, TRIAC |
| CRI: | 95 | 100% - 5% 0-10V |

Housings (Required) - Order Separately From Trims

	Model	Power	Color Temp
<p><i>New Construction</i></p>	R3CRN-13 Round IC-Rated Airtight	13W	WD 1800K - 3000K
	R3CRN-16 Round Non IC Airtight	16W	WD 1800K - 3000K

Example: **R3CRN-13-WD**

ROUND REMODEL HOUSING

Downlight, 0° - 30° Adjustable, Adjustable Pinhole and Wall Wash
Universal Voltage and Universal Dimming
Non IC, Airtight, and Wet Location listed



- | | | |
|--------------------|--------------|--|
| Power: | 16W | • Dim to Warm color temperature range: 3000K-1800K |
| Comparable: | 75W PAR30 | • Die-cast trimless spackle frame included for use with flangeless trims |
| Input: | 120V - 277V | • Vertical Adjustment 0 - 30°, Horizontal Adjustment 365° |
| Rated Life: | 50,000 hours | • Dimming: 100% - 1% ELV, TRIAC |
| CRI: | 95 | 100% - 5% 0-10V |

Housings (Required) - Order Separately From Trims

	Model	Power	Color Temp
<p><i>Remodel Trim</i></p>	R3CRR-16 Round Trim	16W	WD 1800K - 3000K
	R3CRRL-16 Round Trimless	16W	WD 1800K - 3000K

Example: **R3CRR-16-WD**









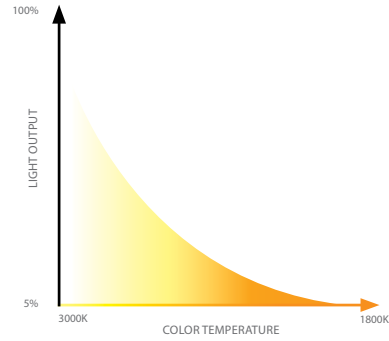

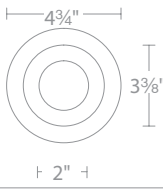

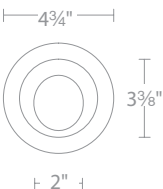

OCULUX ARCHITECTURAL 3.5" DIM-TO-WARM LED RECESSED



ROUND

Construction: Die-cast Aluminum
Delivered Lumens: Up to 1020
Standards: UL & cUL Wet Location listed

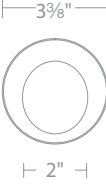

Trims (Required) - Order Housing Separately		Model	Power	Beam	Max Lumens	Max CBCP	Finish	
		R3CRDT Round Downlight & Adjustable Wet Location listed	13W	34° 60°	860 750	2110 665	HZWT Haze/White WT White	
			16W	34° 60°	1020 890	2500 785		
		R3CRPT Round Adjustable Pinhole Wet Location listed	13W	32° 54°	760 600	2115 660	WT White	
			16W	32° 54°	900 710	2500 780		
		R3CRWT Round Wall Wash Wet Location listed	13W	Asym	630	N/A	HZWT Haze/White WT White	
			16W	Asym	745	N/A		
Trimless								
		R3CRDL Round Downlight & Adjustable Wet Location listed	13W	34° 60°	860 750	2110 665	HZ Haze WT White	
			16W	34° 60°	1020 890	2500 785		
		R3CRPL Round Adjustable Pinhole Wet Location listed	13W	32° 54°	760 600	2115 660	WT White	
			16W	32° 54°	900 710	2500 780		
		R3CRWL Round Wall Wash Wet Location listed	13W	Asym	630	N/A	HZ Haze WT White	
			16W	Asym	745	N/A		

Example: **R3CRWL-HZ**

OCULUX ARCHITECTURAL 3.5" DIM-TO-WARM LED RECESSED



SQUARE NEW CONSTRUCTION HOUSING

Downlight, 0° - 30° Adjustable, Adjustable Pinhole and Wall Wash
Universal Voltage and Universal Dimming
IC and Non IC, Airtight, and Wet Location listed

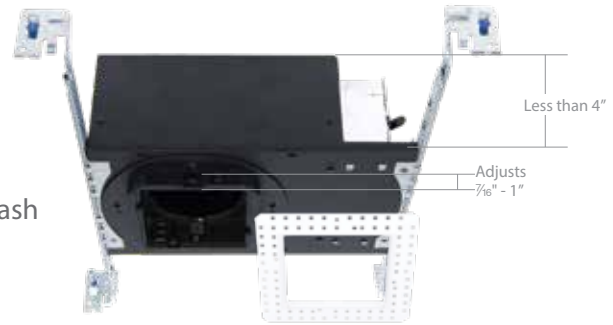

- | | | |
|--------------------|--------------|--|
| Power: | 13W, 16W | • Dim to Warm color temperature range: 3000K-1800K |
| Comparable: | 75W PAR30 | • Die-cast trimless spackle frame included for use with flangeless trims |
| Input: | 120V - 277V | • Vertical Adjustment 0 - 30°, Horizontal Adjustment 365° |
| Rated Life: | 50,000 hours | • Dimming: 100% - 1% ELV, TRIAC |
| CRI: | 95 | 100% - 5% 0-10V |

Housings (Required) - Order Separately From Trims

Model Power Color Temp

New Construction		Model	Power	Color Temp
		R3CSN-13 Square IC-Rated Airtight	13W	WD 1800K - 3000K
		R3CSN-16 Square Non IC Airtight	16W	WD 1800K - 3000K

Example: **R3CSN-13-WD**

SQUARE REMODEL HOUSING

Downlight, 0° - 30° Adjustable, Adjustable Pinhole and Wall Wash
Universal Voltage and Universal Dimming
Non IC, Airtight, and Wet Location listed



- | | | |
|--------------------|--------------|--|
| Power: | 16W | • Dim to Warm color temperature range: 3000K-1800K |
| Comparable: | 75W PAR30 | • Die-cast trimless spackle frame included for use with flangeless trims |
| Input: | 120V - 277V | • Vertical Adjustment 0 - 30°, Horizontal Adjustment 365° |
| Rated Life: | 50,000 hours | • Dimming: 100% - 1% ELV, TRIAC |
| CRI: | 95 | 100% - 5% 0-10V |

Housings (Required) - Order Separately From Trims

Model Power Color Temp

Remodel Trim		Model	Power	Color Temp
		R3CSR-16 Square Trim	16W	WD 1800K - 3000K
		R3CSRL-16 Square Trimless	16W	WD 1800K - 3000K

Example: **R3CSR-16-WD**

OCULUX ARCHITECTURAL 3.5" DIM-TO-WARM LED RECESSED



SQUARE

Construction: Die-cast Aluminum
Delivered Lumens: Up to 1025
Standards: UL & cUL Wet Location listed

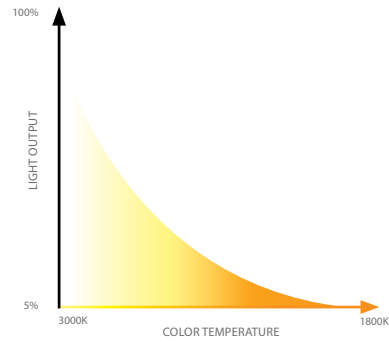

Trims (Required) - Order Housing Separately		Model	Power	Beam	Max Lumens	Max CBCP	Finish
		R3CSDT Square Downlight & Adjustable Wet Location listed	13W	34° 60°	865 790	2165 665	HZWT Haze/White White
			16W	34° 60°	1025 930	2565 790	
		R3CSPT Square Adjustable Pinhole Wet Location listed	13W	32° 54°	795 600	2165 625	WT White
			16W	32° 54°	940 710	2530 740	
		R3CSWT Square Wall Wash Wet Location listed	13W	Asym	610	N/A	HZWT Haze/White White
			16W	Asym	720	N/A	
Trimless							
		R3CSDL Square Downlight & Adjustable Wet Location listed	13W	34° 60°	865 790	2165 665	HZWT Haze White
			16W	34° 60°	1025 930	2565 790	
		R3CSPL Square Adjustable Pinhole Wet Location listed	13W	32° 54°	795 600	2165 625	WT White
			16W	32° 54°	940 710	2530 740	
		R3CSWL Square Wall Wash Wet Location listed	13W	Asym	610	N/A	HZWT Haze White
			16W	Asym	720	N/A	

Example: **R3CSDL-WT**

SILO LED PENDANT



PD-2015

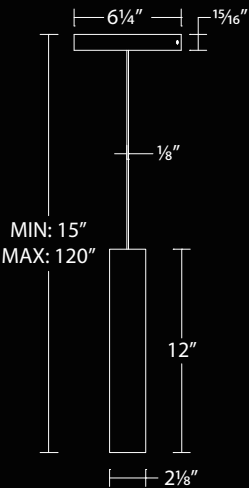

Thin powered suspension cable matches pendant body finish
Retractable accenting collar extends up to 3/8" for two toned appearance.

PD-2020

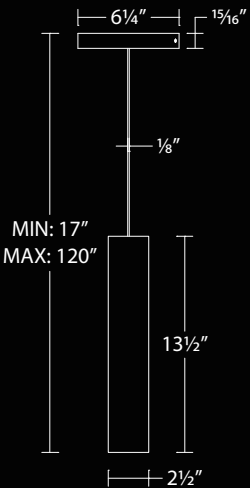

SILO LED PENDANT

Dimming: ELV, 0-10V (Monopoint), ELV (Track)
Input: 120-277V (Monopoint), 120V (Track)
Rated Life: 50,000 hours

- Available as Monopoint and for H/L/J Track
- Single screw canopy for easy junction box installation with monopoint
- Universal voltage driver concealed within canopy for monopoint
- **All Monopoints and H/L/J-PD2015** are Title 24 Compliant
- Accenting collar included, see ordering table for finishes



WT/BK

BK/GL

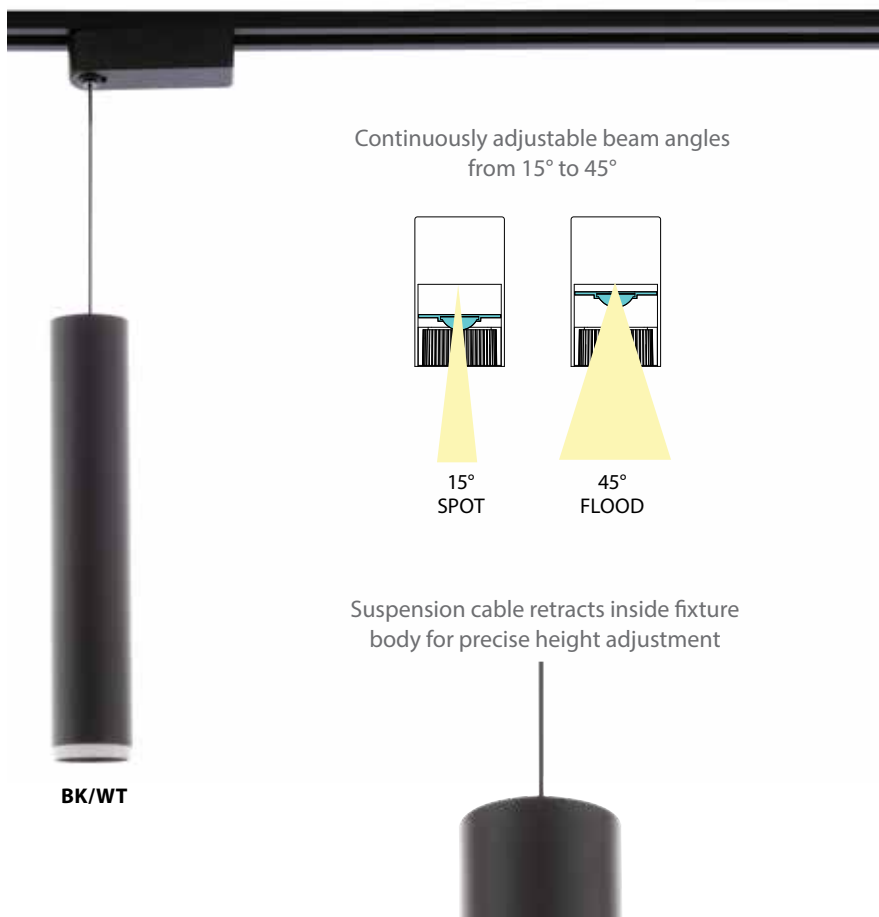

Continuously adjustable beam angles from 15° to 45°

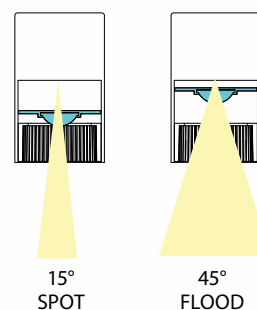

Suspension cable retracts inside fixture body for precise height adjustment

BK/WT

Model	Power	Beam	Max Lumens	CBCP	Color Temp	CRI	Finish	Body/Collar
PD-2015	15W	15°	395	3034	927 2700K 930 3000K 935 3500K 940 4000K	90	BK/BK Black/Black	BK/GL Black/Gold
		45°	730	1327			BK/WT Black/White	WT/BK White/Black
PD-2020	20W	15°	760	5944	935 3500K 940 4000K	90	WT/BK White/Black	WT/GL White/Gold
		45°	1125	1722			WT/WT White/White	

Example: **PD-2015-930-BK/WT**

System	Model	Power	Beam	Lumens	CBCP	Color Temp	CRI	Finish	Body/Collar
H H Track	PD2015	15W	15°	395	3034	927 2700K 930 3000K 935 3500K 940 4000K	90	BK/BK Black/Black	BK/GL Black/Gold
			45°	730	1327			BK/WT Black/White	WT/BK White/Black
L L Track	PD2015	15W	15°	395	3034	927 2700K 930 3000K 935 3500K 940 4000K	90	BK/BK Black/Black	BK/GL Black/Gold
			45°	730	1327			BK/WT Black/White	WT/BK White/Black
J J/J2 Track	PD2020	20W	15°	760	5944	935 3500K 940 4000K	90	WT/BK White/Black	WT/GL White/Gold
			45°	1125	1722			WT/WT White/White	

Example: **H-PD2020-930-BK/BK**

INVISILED® CCT

COLOR TEMPERATURE ADJUSTABLE TAPE



- 600 lumens max run: 15 feet
- 400 lumens max run: 20 feet
- 300 lumens max run: 30 feet
- 200 lumens max run: 40 feet
- 100 lumens max run: 60 feet

CLOSET RATED

DAMP

UL LISTED

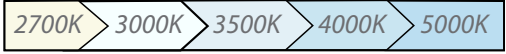

TITLE 24 CALIFORNIA





.4" *Actual size shown

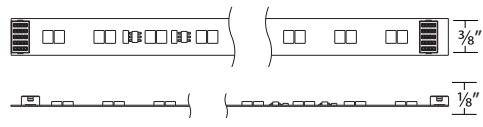

- | | | |
|--------------------|-------------------|--|
| Input: | 24VDC | <ul style="list-style-type: none"> • May be cut and easily reconnected every 4 inches • Select and choose desirable CCT with matching CCT selectable power supply • UV stabilized protective coating protects LEDs and circuitry for long term use in Damp Locations • Connections may be separated and reconnected at each junction point • Equal brightness for an entire light strip • Strong adhesive bonding with the 3M adhesive VHB • Gold plated connector protects from corrosion, heat, and ensures a reliable electrical connection • 100ft max distance between the power supply and beginning of InvisILED® |
| Dimming: | ELV, TRIAC, 0-10V | |
| Lumens: | Up to 600 lm/ft | |
| Rated Life: | 50,000 hours | |
| CRI: | 95 | |



TAPE SELECTIONS

System	Max Run	Power	Length (in feet)				Color Temp	Finish	
 T24-CS1	100+lm/ft	60ft	1.2W/ft	01	05	10	20	60	2700K 3000K 3500K 4000K 5000K WT White
 T24-CS2	200+lm/ft	40ft	2.4W/ft	01	05	10	20	40	
T24-CS3	300+lm/ft	30ft	3W/ft	01	05	10	20	30	
T24-CS4	400+lm/ft	20ft	4.6W/ft	01	05	10	20	N/A	
T24-CS6	600+lm/ft	15ft	6.3W/ft	01	05	10	15	N/A	

Example: **T24-CS3-10-2750WT**

COMPATIBLE CLASS 2 POWER SUPPLY (REQUIRED)









- 7 1/16" x 3 7/8" x 1 3/8"
- Universal Input, ≥ 0.9 pf
- Overload and short circuit protection



- 10 3/4" x 8 5/8" x 1 3/8"
- Universal Input, ≥ 0.9 pf
- Overload and short circuit protection

Model	Input	Output	Dimming
PS-24DC-U60R-CS-SM	120V-277VAC	24VDC 60W	ELV/ TRIAC / 0-10V
PS-24DC-U96R-CS-SM	120V-277VAC	24VDC 96W	ELV/ TRIAC / 0-10V
Includes 6ft lead wire with connector			
PS-24DC-U288R-CSSM	120V-277VAC	24VDC 288W (3 x 96W)	ELV/ TRIAC / 0-10V
Includes 3x 6ft lead wire with connector			

ACCESSORIES

Type	Model	Finish
 <p>Tape to Tape Connector Connects tape sections</p>	T24-MM-WT	White
 <p>Tape to Tape T Connector Connects tape sections</p>	T24-TI-WT	White
 <p>Tape to Tape X Connector Connects tape sections</p>	T24-XI-WT	White
 <p>Tape to Tape L Connector Connects tape sections</p>	T24-LI-WT	White
 <p>Joiner Cable Extender Connects joiner cable to joiner cable, female on both sides</p>	T24-FF-WT	White
 <p>Flex Tape to Tape Y Connector Connects tape sections</p>	T24-Y-WT T24-Y-BK	White Black
 <p>Flex Tape to Tape X Connector Connects tape sections</p>	T24-X-WT T24-X-BK	White Black

Type	Model	Length	Finish
 <p>In Wall Rated Joiner Cable Connects tape sections, 2 male ends</p>	T24-IC-002	2 in	WT White BK Black
	T24-IC-006	6 in	
	T24-IC-012	1 ft	
	T24-IC-036	3 ft	
	T24-IC-072	6 ft	
	T24-IC-144	12 ft	
	T24-IC-240	20 ft	

Example: **T24-IC-002-WT**

Type	Model	Length	Finish
 <p>In Wall Rated Extension Cable Extends distance between a hard wire power supply or a wiring box to a tape section</p>	T24-EX3-072	6 ft	WT White BK Black
	T24-EX3-144	12 ft	
	T24-EX3-240	20 ft	
	T24-EX3-1200	100 ft	

Example: **T24-EX3-240-WT**

PRO INVISIBLE® DAMP RATED 200 LM/FT TAPE LIGHT



Cut every 2 inches



Closet Rated



Damp Rated



UV Protective Coating



Power: 3W / ft
 Lumens: Up to 215 lm / ft
 CRI: 85
 Rated Life: 50,000 hours

- Designed for bright cove or task lighting
- UV stabilized protective coating protects LEDs and circuitry for long term use in Damp Locations
- May be cut every 2 inches at the end of a run
- Offered in an inclusive 24VAC option
- Includes an end cap
- Maximum run length of 33 feet
- Specially rated for installation in the storage area of a clothes closet

TAPE SELECTIONS

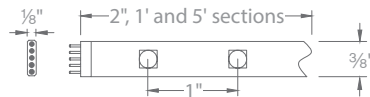

System	Color Temp	Length	Qty	Finish
LED-T24	W 2700K	2IN 2 inches	1	WT White
	P 3000K	2IN-10 2 inches	10	
	35 3500K	1 1 foot	1	
	C 4500K	5 5 feet	1	
		1-40 1 foot	40	

Example: **LED-T24W-1-40-WT**

"L" CONNECTOR

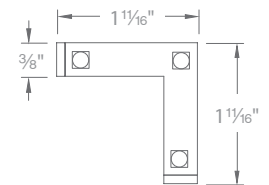

System	Color Temp	Finish
LED-T24	W 2700K	3L-WT White
	P 3000K	
	35 3500K	
	C 4500K	

Example: **LED-T24W-3L-WT**
 Each "L" connector consumes 1.2 Watts

COMPATIBLE CLASS 2 POWER SUPPLY (REQUIRED)

Type	Model	Input	Output	Dimming
Remote	EN-2460-RB2-T	120VAC	24VAC / 60W	ELV
	EN-24100-RB2-T	120VAC	24VAC / 96W	ELV
Remote	PS-24DC-U60R-PI	120-277VAC	24VDC 60W	ELV/ TRIAC / 0-10V
	PS-24DC-U96R-PI		24VDC 96W	
Remote	EN-24100-277-RB2-T	120- 277VAC	24VDC / 96W	0-10V
Plug-in	EN-2460-P-AR-T	120VAC	24VAC / 60W	N/A
	EN-24100-P-AR-T	120VAC	24VAC / 96W	

PRO2 INVISILED® DAMP RATED 300 LM/FT TAPE LIGHT

Power: 4W / ft
Lumens: Up to 330 lm / ft
CRI: 90
Rated Life: 80,000 hours

- Specially rated for installation in the storage area of a clothes closet
- UV stabilized protective coating protects LEDs and circuitry for long term use in Damp Locations
- May be cut every 6 inches at the end of a run
- Offered in an inclusive 24VAC option
- Includes an end cap
- Max run length of 25 feet

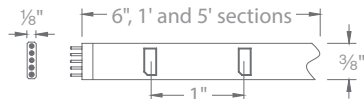

PRO3 INVISILED® DAMP RATED V450 LM/FT TAPE LIGHT

Power: 5W / ft
Lumens: Up to 475 lm / ft
CRI: 90
Rated Life: 70,000 hours

- Ideal in straight or curved ceiling coves for general illumination
- Laterally bendable design
- UV stabilized protective coating protects LEDs and circuitry for long term use in Damp Locations
- May be cut every 6 inches at the end of a run
- Offered in an inclusive 24VAC option
- Includes an end cap and a male to male connector with each tape section
- Max run length of 20 feet per power supply



Constant 1" on-center diode spacing over connections

Curve clip LED-T-CL1 shown

Longitudinally bendable over marked signs

Field-cutable every 6" at the end of a run

TAPE SELECTIONS

System	Color Temp	Length	Qty	Finish
LED-TX24	22 2200K	6IN 6 inches	1	WT White
	27 2700K	1 1 foot	1	
	30 3000K	5 5 feet	1	
	35 3500K	1-40 1 foot	40	
	45 4500K			

Example: **LED-TX2435-6IN-WT**

TAPE SELECTIONS

System	Color Temp	CRI	Length	Qty	Finish
LED-TE24	27 2700K	95	6IN 6 inches	1	WT White
	30 3000K	95	1 1 foot	1	
	35 3500K	90	5 5 feet	1	
	45 4500K	90	1-40 1 foot	40	

Example: **LED-TE2435-6IN-WT**

"L" CONNECTOR

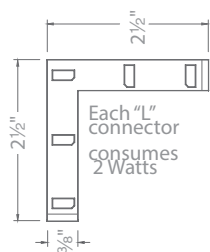

Each "L" connector consumes 2 Watts

System	Color Temp	Finish
LED-TX24V	22 2200K	5L-WT White
	27 2700K	
	30 3000K	
	35 3500K	
	45 4500K	

Example: **LED-TX2435-5L-WT**



See p.21 for Power Supplies

LITE INVISILED® DAMP RATED 150 LM/FT TAPE LIGHT



Power: 2W / ft
 Lumens: Up to 150 lm / ft
 CRI: 85
 Rated Life: 50,000 hours

- Specially rated for installation in the storage area of a clothes closet
- UV stabilized protective coating protects LEDs and circuitry for long term use in Damp Locations
- May be cut every 2 inches at the end of a run
- Offered in an inclusive 24VAC option
- Includes an end cap
- Max run length of 40 feet per power supply

TAPE SELECTIONS

System	Color Temp	Length	Qty	Finish
LED-T24	27L 2700K 30L 3000K	2IN 2 inches	1	WT White
		2IN10 2 inches	10	
		1 1 foot	1	
		5 5 feet	1	
		1-40 1 foot	40	

Example: **LED-T2427L-5-WT**

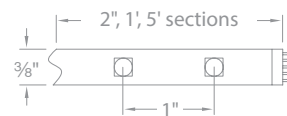

"L" CONNECTOR



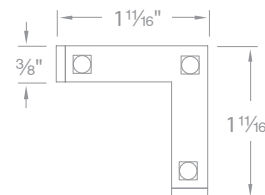

System	Color Temp	Finish
LED-T24	27L 2700K 30L 3000K	3L-WT White

Example: **LED-T2427L-3L-WT**

Each "L" connector consumes 0.7 Watts



COMPATIBLE CLASS 2 POWER SUPPLY (REQUIRED)

Type	Model	Input	Output	Dimming	
Remote	 EN-2460-RB2-T	120VAC	24VAC / 60W	ELV	Includes a 6 foot lead wire
	EN-24100-RB2-T	120VAC	24VAC / 96W	ELV	
Remote	 PS-24DC-U60R-PI PS-24DC-U96R-PI	120-277VAC	24VDC 60W 24VDC 96W	ELV/ TRIAC / 0-10V	Includes a 6 foot lead wire
Remote	 EN-24100-277-RB2-T	120- 277VAC	24VDC / 96W	0-10V	Includes a 6 foot lead wire
Plug-in	 EN-2460-P-AR-T	120VAC	24VAC / 60W	N/A	Includes a 6 foot lead wire
	EN-24100-P-AR-T	120VAC	24VAC / 96W	N/A	

INVISILED® ACCESSORIES FOR PRO, PRO2, PRO3 & LITE

INDOOR CONTROL

Conveniently install a secondary side of power supply for adding senior friendly low voltage lighting to furniture and toe kicks



Capacitive Touch Switch and Occupancy Control Kit **CT-6A-R2**

Includes a Touch Panel, an Occupancy Sensor, and a Controller.
Compatible with WAC low voltage LED (12V or 24V) undercabinet products

INDOOR ELECTRICAL ACCESSORIES

	In Wall Rated Extension Cable <i>Extends distance between a hard wired power supply or a wiring box to a tape section</i>	LED-TC-WEXT-144	Black	12 ft
		LED-TC-WEXT-144-WT	White	12 ft
		LED-TC-WEXT-240	Black	20 ft
		LED-TC-WEXT-240-WT	White	20 ft
	In Wall Rated Joiner Cable <i>Connects tape sections. 2 female ends. 1 male to male connector included</i>	LED-TC-WIC-144	Black	12 ft
		LED-TC-WIC-144-WT	White	12 ft
		LED-TC-WIC-240	Black	20 ft
		LED-TC-WIC-240-WT	White	20 ft
	Lead Wire <i>Alternative lengths for plug-in power supplies</i>	LED-TC-P-2	Black	2 ft
		LED-TC-P-2-WT	White	2 ft
		LED-TC-P-12	Black	12 ft
		LED-TC-P-12-WT	White	12 ft
	Extension Cable <i>Extends distance between a hard wired power supply or a wiring box to a tape section</i>	LED-TC-EXT-144	Black	12 ft
		LED-TC-EXT-144-WT	White	
	Low Voltage Wiring Box With Feed <i>Neatly houses connectors for up to two wires with 12" female feed</i>	LED-TC-B-2	Black	L: 1½ in W: ¾ in H: 7/8 in
		LED-TC-B-2-WT	White	
	Low Voltage Wiring Box <i>Neatly houses connections for up to two wires</i>	LED-T-B		L: 1½ in W: ¾ in H: 7/8 in
	Wiring Box With Switch <i>Use when spanning a large gap in a system layout without leaving exposed wiring, optional switch included</i>	TB-S		L: 6¼ in W: 1½ in H: 1¼ in

Compatible with Pro, Pro2, Pro3, LITE

	Joiner Cable <i>Connects tape sections</i>	LED-TC-IC2	Black	2 in
		LED-TC-IC2-WT	White	2 in
		LED-TC-IC6	Black	6 in
		LED-TC-IC6-WT	White	6 in
		LED-TC-IC12	Black	12 in
		LED-TC-IC12-WT	White	12 in
		LED-TC-IC36	Black	36 in
		LED-TC-IC36-WT	White	36 in
		LED-TC-IC72	Black	72 in
LED-TC-IC72-WT	White	72 in		
	Male to male connector	LED-TC-MM	Black	50 Qty

Compatible with Pro, Pro2, Pro3, LITE

Change directionality of tape runs and reuse cut ends of tape

	3-Way "Y" Connector <i>Connects tape sections</i>	LED-TC-Y	Black
		LED-TC-Y-WT	White
	4-Way "X" Connector <i>Connects tape sections</i>	LED-TC-X	Black
		LED-TC-X-WT	White
	"L" Connector <i>Connects tape sections</i>	LED-TC-L	Black
		LED-TC-L-WT	White
	End cap <i>1 cut and 1 male end cap</i>	LED-TC-EC	Black
		LED-TC-EC-WT	White

Compatible with Pro, Pro2, Pro3, LITE

INDOOR ALUMINUM CHANNELS

COMPATIBLE WITH ALL DAMP RATED INVISILED® TAPE SYSTEMS



Aluminum Channel **LED-T-CH** 5 feet
 Additional End Caps **LED-T-CH-EC** 2 pcs

Diffuses light from InvisiLED® tape
 Includes a diffuser, two end caps, and five screws
 Compatible with CCT, Pro, Pro2, Pro3, LITE



Deep Aluminum Channel **LED-T-CH1** 5 feet
 Additional End Cap **LED-T-CH1-EC** 2 pcs

Eliminates visible hot spots
 Includes a diffuser, two end caps, and five screws
 Compatible with CCT, Pro, Pro2, Pro3, LITE



45° Angled Aluminum Channel **LED-T-CH2** 5 feet
 Additional End Caps **LED-T-CH2-EC** 2 pcs

Includes a diffuser, two end caps, and five screws
 Compatible with CCT, Pro, Pro2, Pro3, LITE



Installed with 45° Angled Aluminum Channel in toe kick and Pro 3 InvisiLED®

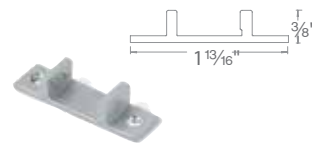

Fixed Channel Clip **LED-T-CL3-PT**

Includes 2 pieces, 4 screws. Use to mount Aluminum Channel, Deep Aluminum Channel, 45° Angled Aluminum Channel

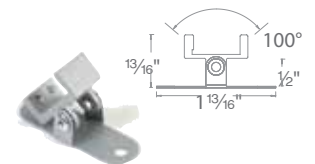

Adjustable Channel Clip **LED-T-CL2-PT**

INDOOR MOUNTING ACCESSORIES



Aluminum Retrofit Channel **LED-T-RC** 3 feet

Can be bent to create fixed curves or used as a glare shield
 Compatible with Pro, Pro2, Pro3, LITE



Clip **LED-T-CL** 10 pcs
 For surfaces that are difficult to adhere 10 Screws

Clips to hold indoor InvisiLED® tapes sections
 Compatible with Pro, Pro2, Pro3, LITE



Clear Channel **LED-TO24-CH5** 5 feet



Curve Clip **LED-T-CL1** 10 pcs
 Secures on one edge 10 Screws

Clips to hold indoor InvisiLED® tapes sections
 Compatible with Pro, Pro2, Pro3, LITE

SYMMETRICAL RECESSED CHANNEL

Indoor InvisiLED® tape

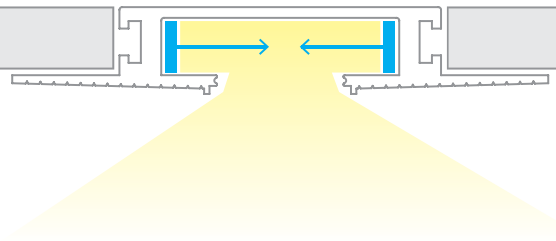

- Installs within 5/8" drywall depth
- Linear channel can be field cut
- Accommodates either one or two runs of InvisiLED® indoor tape
- Includes a translucent white acrylic diffuser
- Dense foam insert to be removed in installation after spackling

8ft linear channel

LED-T-RCH1-WT

- Includes 1 diffuser
- 8 perforated metal sheets

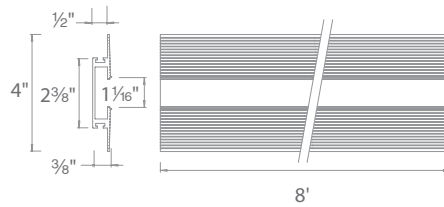

Power feed

LED-T-RBOX1-WT

- The end cap may be placed on either side
- Hanger bars may be installed on any side of the wiring box
- Kit includes: 1 wiring box
- 2 hanger bars
- 4 five-pin InvisiLED® adapters
- 2 end cap
- 1 diffuser
- 2 channel connector
- 1 counter sink drill bit
- 1 drill bit
- 1 installation tool

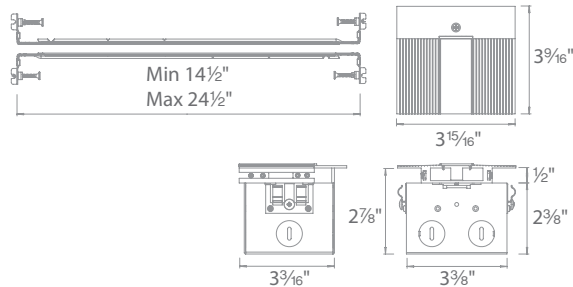

Lateral corner

LED-T-CTC1-WT

- Includes: diffuser
- 2 channel connectors
- 2 perforated metal sheets

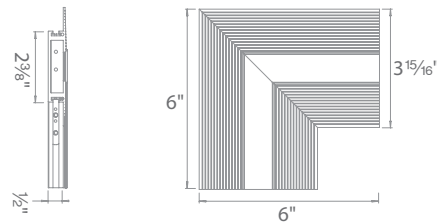

Perpendicular corner

LED-T-WTC1-WT

- Transitions between walls or wall to ceiling
- Includes: diffuser
- 2 channel connectors
- 2 perforated metal sheets

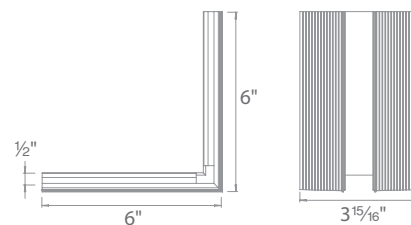

Outside corner

LED-T-WTW1-WT

- Transitions around columns, bump outs, or soffits
- Includes: diffuser
- 2 channel connectors
- 2 perforated metal sheets

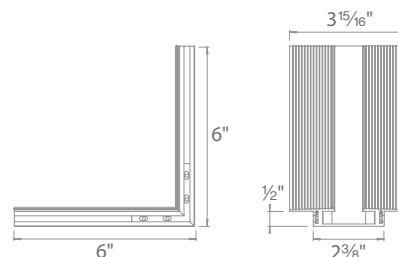

RECESSED CHANNEL INSTALLATION GUIDE

Step 1: Install WAC Power feed wiring box



Step 2: Cut out 2 3/8" wide and 5/8" deep opening to the length of the channel run



Step 3: Cut channel and mount channel to studs without removing the foam insert



Step 4: Spackle, sand and paint around the soft strip channel



Step 5: Remove and discard foam insert and install InvisiLED® on one or both sides of the channel



Step 6: For LED-T-RCH1-WT, snap in acrylic lens to finish



ASYMMETRICAL RECESSED CHANNEL



Indoor InvisiLED® tape

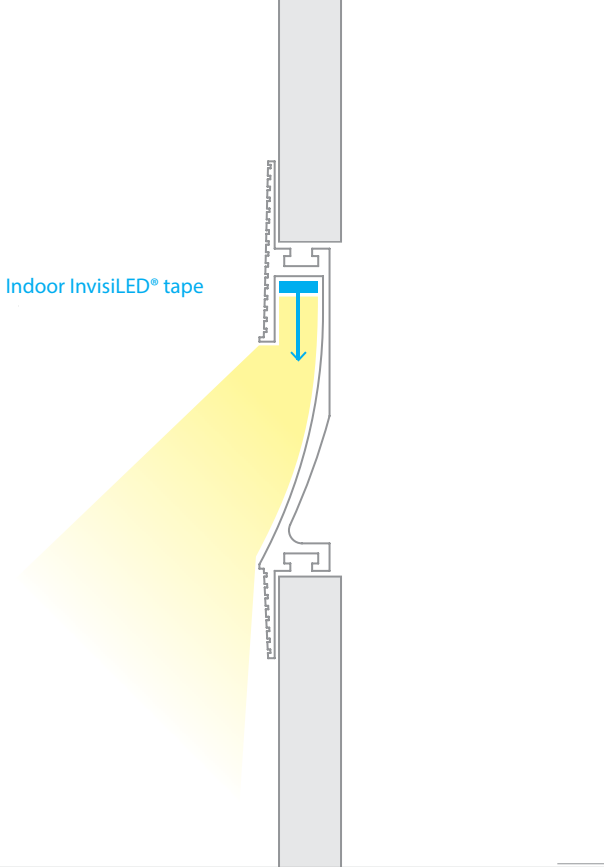

- Installs within 5/8" drywall depth
- Linear channel can be field cut
- Accommodates one run of InvisiLED® indoor tape
- Dense foam insert to be removed in installation after spackling
- Recommended installation within 15 inches of surface to be illuminated

8ft linear channel

LED-T-RCH2-WT

- Includes: 8 perforated metal sheets
- 2 channel connectors

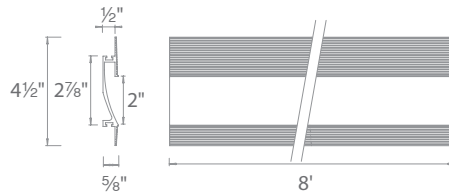

Power feed

LED-T-RBOX2-WT

- The end cap may be placed on either side
- Hanger bars may be installed on any side of the wiring box
- Includes: 1 wiring box
- 2 channel connectors
- 2 hanger bars
- 1 counter sink bit
- 2 five-pin InvisiLED® adapters
- 1 drill bit
- 2 end caps (left and right)

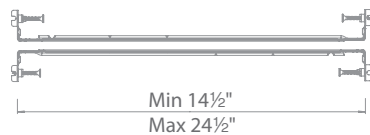
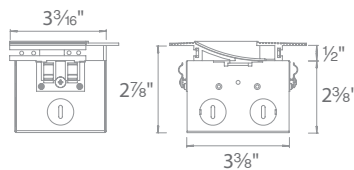
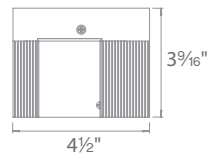

INDIRECT RECESSED CHANNEL

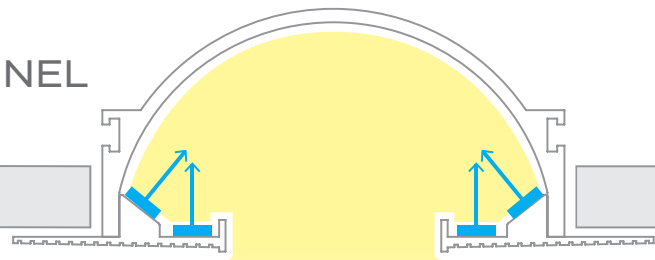

Indoor InvisiLED® tape

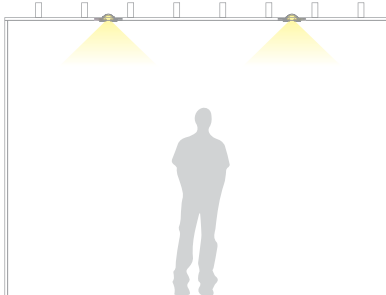

Linear channel can be field cut
 Accommodates up to four runs of InvisiLED® indoor tape
 Dense foam insert to be removed in installation after spackling
 Allows option to use different color InvisiLED® in one channel and switch them separately

8ft linear channel

LED-T-RCH3-WT

Includes: 10 perforated metal sheets
 2 channel connectors

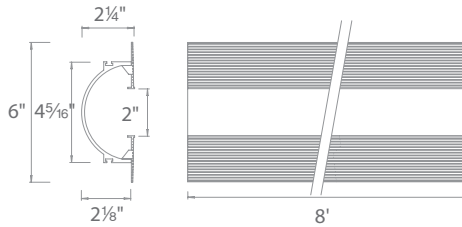

Power feed

LED-T-RBOX3-WT

The end cap may be placed on either side
 Hanger bars may be installed on any side of the wiring box

Includes: 1 wiring box
 2 hanger bars
 4 five-pin InvisiLED® adapters
 1 end cap
 2 channel connectors
 1 counter sink drill bit
 1 drill bit

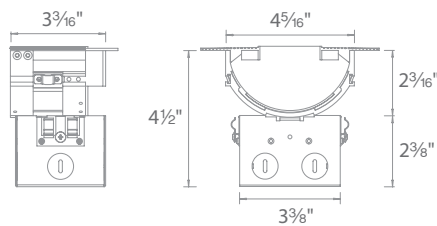
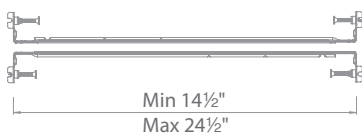
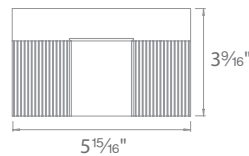

INVISILED® OUTDOOR WET RATED LED TAPE

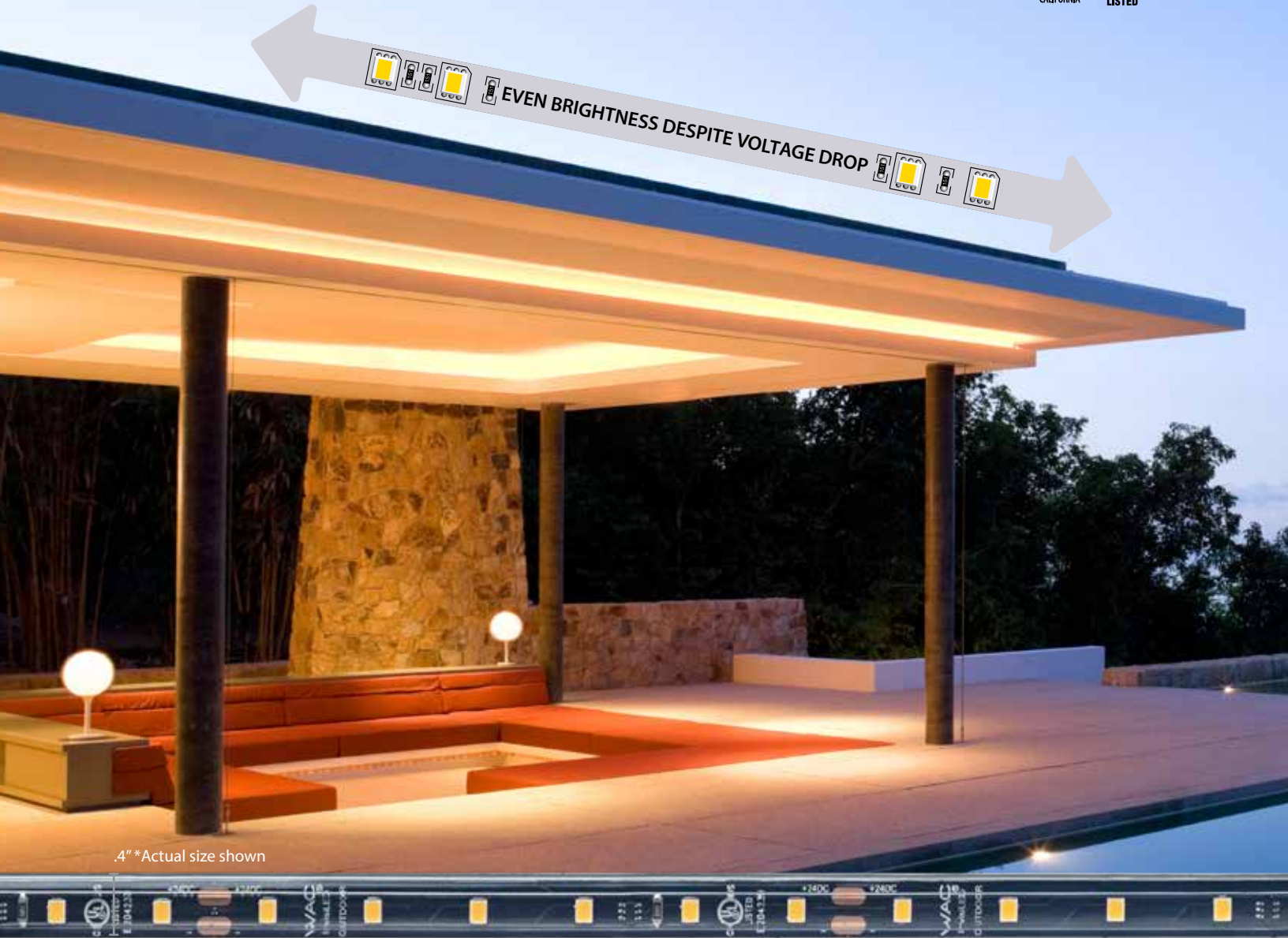

.4" *Actual size shown



Cut every 4 inches

Input: 24VDC
Dimming: 100%-1% ELV, TRIAC
Lumens: Up to 200 lm/ft
Rated Life: 50,000 hours
CRI: 90

- May be cut every 4 inches
- Beam Spread: 115°
- Multiple roll lengths offered
- Even brightness from end to end
- Protection against water spray, dust with silicone jacket (IP65)
- 100ft max distance between the power supply and beginning of InvisILED®

TAPE SELECTIONS

System	Max Run	Power	Length (in feet)							Color Temp		Finish
T24-OD1	100+lm/ft	80ft	1.2W/ft	01	05	10	20	40	80	27	2700K	Black
										30	3000K	
										40	4000K	
T24-OD2	200+lm/ft	40ft	2.4W/ft	01	05	10	20	40	N/A			

Example: **T24-OD1-20-27**











COMPATIBLE CLASS 2 POWER SUPPLY (REQUIRED)



- 8 3/8" x 2 13/16" x 1 11/16"
- Universal Input, ≥ 0.9 pf
- Overload and short circuit protection

Model	Input	Output	Dimming
PS-24DC-U96R-WE	120V-277VAC	24VDC 96W	ELV/TRIAC
Includes 6ft lead wire			

ACCESSORIES

Type	Model	Finish	
 <p><i>Invisiled Outdoor Joiner Cable</i> Extends power supply lead wire</p>	T24-WE-IC-002-BK	2 in	
	T24-WE-IC-006-BK	6 in	
	T24-WE-IC-012-BK	1 ft	
	T24-WE-IC-036-BK	3 ft	Black
	T24-WE-IC-072-BK	6 ft	
	T24-WE-IC-144-BK	12 ft	
	T24-WE-IC-240-BK	20 ft	
 <p><i>Invisiled Outdoor Lead Wire</i> Connects to Indoor Power Supply</p>	T24-WE-B012-BK	1 ft	
	T24-WE-B072-BK	6 ft	Black
 <p><i>Invisiled Outdoor Power Connector Kit with Wire Jacket and Silicone Sealant</i> Allows power to Wet Rated tape</p>	T24-WE-EX2-006-BK	6 in	Black
 <p><i>Invisiled Outdoor Tape to Tape Y Connector</i> Splits power to the two tape sections</p>	T24-WE-Y-BK		Black
 <p><i>Wet Rated Tape End Cap with Silicone Sealant</i> 24VDC Wet Rated (10 pieces)</p>	T24-WE-EC		Clear
 <p><i>Invisiled Outdoor Surface Mounting Clip</i> 24VDC Wet Rated Tape Mounting Screws (10 pieces)</p>	LED-TO24-C1		Black
 <p><i>Invisiled Outdoor Edge Mounting Clip</i> 24VDC Wet Rated Tape Mounting Screws (10 pieces)</p>	LED-TO24-C2		Black
 <p><i>Invisiled Outdoor Underside Mounting Clip</i> 24VDC Wet Rated Tape Mounting Screws (10 pieces)</p>	T24-WE-C3		Black
 <p><i>Invisiled Outdoor Surface Mount Clear Channel</i> 5 ft</p>	T24-WE-CH5		Clear
 <p><i>Silicone Sealant</i> Wet Location Tape Sealant (45 grams)</p>	T24-WE-SI-45		White



Surface or Recessed Mounted

120V Direct Input
No Driver Required

BUILD A SYSTEM

Available in multiple color temperatures, finishes, and recessed or surface mounted options. Order single pucks or kits of multiple pucks to link together.

BEAUTIFULLY FINISHED CAST ALUMINUM



Black

Brushed Nickel

White

CCT SELECTABLE

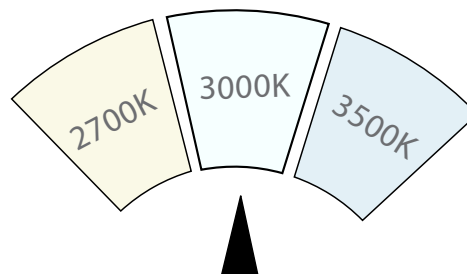

PUCK LIGHT UNDERCABINET LIGHTING



A solid lighting solution for kitchen counters, our 120V Undercabinet Puck Light with 3 CCT selectable technology provides quality illumination for all tasks.

- Input:** 120V
- CRI:** 90+
- Dimming:** 100%-10% ELV
100%-5% TRIAC
- Rated Life:** 50,000 hours
- CCT Selectable: 2700K/3000K/3500K
- Available for surface or recessed mount
- **No driver required**
- Construction: Die-cast Aluminum and PC Diffuser

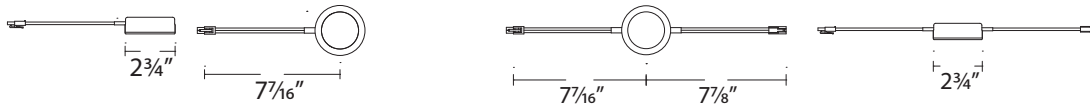

	Model	Power	Max Lumens	Color Temp	Finish
	HR-AC71 <i>Includes Power Cord</i>	4.0W	290	CS 2700K 3000K 3500K	BK Black BN Brushed Nickel WT White
	HR-AC72	4.0W	290	CS 2700K 3000K 3500K	BK Black BN Brushed Nickel WT White
	HR-AC73 <i>3 Puck Kit</i> <i>Includes Power Cord</i>	4.0W x 3	290 x 3	CS 2700K 3000K 3500K	BK Black BN Brushed Nickel WT White

Example: **HR-AC72-CS-BN**

	Model		Finish
	HR-PC6	<i>Power Cord</i>	BK Black WT White
	HR-HWB	<i>Hardware Box</i>	BK Black WT White
	HR-IC	12 12" 24 24" 36 36" <i>Linking Cable</i>	BK Black WT White

Example: **HR-HWB-BK**

WAC LIMITED

DISC LED FAN



F-002L-BN



An energy efficient LED luminaire with a quiet DC motor makes Disc 70% more efficient than AC fans.



DISC LED FAN



A streamlined look suited for bedrooms and living rooms. The sweep of the 52" blades efficiently create a "cooling effect" and complement the silent DC motor.

- Blade:** 13° Pitch, 52" Sweep, Plywood
- Downrod:** 3/4" W x 4 1/2" H Included
- Mounting Slope:** Up to 30°
- Lead Wire:** 80"
- Hanging Weight:** 14 lbs
- LED Lumens:** 2100
- Total Power:** 52W
- LED Power:** 25W

- 3-speed 120 x 15 DC motor for quiet and powerful operation
- Precision balanced blades for wobble-free operation
- Pull-chain operated and reversible from housing
- Fan and LED module are Energy Star® certified

Model	Housing	Blade
F-002L	BN <i>Brushed Nickel</i>	<i>Titanium Silver</i>
	MB <i>Matte Black</i>	<i>Matte Black</i>
	MW <i>Matte White</i>	<i>Matte White</i>

Example: **F-002L-BN**

ENERGY GUIDE		
	High Speed	Weighted Average
Electricity	25W	17W
Airflow	5,032 CFM	3,964 CFM
Energy Costs*	\$5/yr	\$5/yr
Efficiency	237 CFM/W	237 CFM/W

* Estimated annual energy cost based on \$0.12 per kWh and 6.4 hours use per day

ACCESSORIES sold separately

XF-	12	18	24	36	48	60	72	BN	MB	MW
Downrods	12"	18"	24"	36"	48"	60"	72"	Brushed Nickel	Matte Black	Matte White

ACCESSORIES sold separately

XF-I Coupler	BN MB MW	Brushed Nickel Matte Black Matte White
XF-SCK Slope Ceiling Kit	BN MB MW	Brushed Nickel Matte Black Matte White

ION 2" LED RECESSED



Minimum profile ION 2" Round and Square downlight with remote driver and electrical connection box for easy Remodel or New Construction installation.

Power: 9W
Input: 120-277V
Dimming: 100% - 10% ELV,
 100%-5% TRIAC
Rated Life: 50,000 hours
CRI: 90

- Height: Fixture 3 7/8"
- Installs into ceilings between 1/2" and 1 1/2" thick
- Construction: Die-cast Aluminum with frosted TIR lens

	Model	Beam	Max Lumens	Max CBCP	Color Temp	Finish
	R2DRDR Round Remodel IC-Rated, Airtight Wet Location listed	F 45°	710	993	930 3000K	WT White
	R2DRDN Round New Construction IC-Rated, Airtight Wet Location listed	F 45°	710	993	930 3000K	WT White
	R2DSDR Square Remodel IC-Rated, Airtight Wet Location listed	F 45°	755	1014	930 3000K	WT White
	R2DSDN Square New Construction IC-Rated, Airtight Wet Location listed	F 45°	755	1014	930 3000K	WT White

Example: **R2DRDR-F930-WT**

Frame-In Kit (Optional Accessory)

New Construction Frame



Model

Notes

R2DRDN-FRAME
 IC-Rated, Airtight

Ceiling thickness: 1/2" - 1 1/2"

POP-IN 4" LED RECESSED



Minimum profile downlight with driver and electrical connection box attached to fixture for easy Remodel or New Construction installation.

Power: 12W
Input: 120-277V
Dimming: 100% - 10% ELV,
 100%-5% TRIAC
Rated Life: 50,000 hours
CRI: 90

- Electrical wiring box directly on the back of fixture
- Available as a Remodel or New Construction
- Installs into ceilings between 1/2" and 1 1/2" thick
- Construction: Die-cast aluminum with frosted TIR lens

	Model	Beam	Max Lumens	Max CBCP	Color Temp	Finish
	R4DRDR Round Remodel IC-Rated, Airtight Wet Location listed	F 45°	1035	1390	930 3000K	WT White
	R4DRDN Round New Construction IC-Rated, Airtight Wet Location listed	F 45°	1035	1390	930 3000K	WT White
	R4DSDR Square Remodel IC-Rated, Airtight Wet Location listed	F 45°	1035	1390	930 3000K	WT White
	R4DSDN Square New Construction IC-Rated, Airtight Wet Location listed	F 45°	1035	1390	930 3000K	WT White

Example: **R4DRDR-F930-WT**
 Frame-In Kit (Optional Accessory)

Model Notes

New Construction Frame



R4DRDN-FRAME
 IC-Rated, Airtight

Ceiling thickness: 1/2" - 1 1/2"

BLAZE 6" LED RECESSED

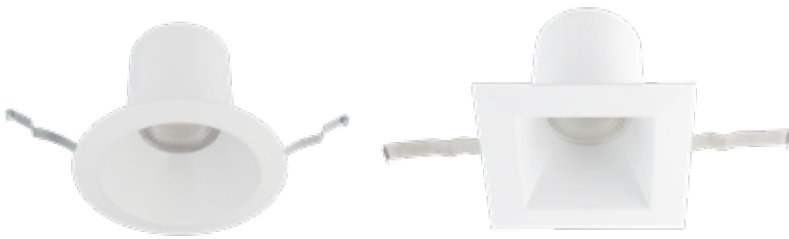

BLAZE 6" Round and Square.
5-CCT selectable downlight.

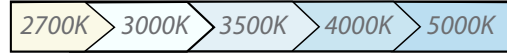

Remodel and New Construction applications.
Remote driver and wiring box included.

Power: 25W
Input: 120-277V
Dimming: 100% - 10% ELV,
100%-5% TRIAC
Rated Life: 50,000 hours
CRI: 90

- Height: fixture 5 3/8"
- CCT Selectable: 2700K/3000K/3500K/4000K/5000K
- Installs into ceilings between 1/2" and 1 1/2" thick
- Construction: Die-cast Aluminum with frosted TIR lens

	Model	Beam	Max Lumens	Max CBCP	ColorTemp	Finish
	<p>R6DRDR Round Remodel IC-Rated, Airtight Wet Location listed</p>	F 55°	2485	2292	2700K 3000K 3500K 4000K 5000K	WT White
	<p>R6DRDN Round New Construction IC-Rated, Airtight Wet Location listed</p>	F 55°	2485	2292	2700K 3000K 3500K 4000K 5000K	WT White
	<p>R6DSDR Square Remodel IC-Rated, Airtight Wet Location listed</p>	F 55°	2360	2340	2700K 3000K 3500K 4000K 5000K	WT White
	<p>R6DSDN Square New Construction IC-Rated, Airtight Wet Location listed</p>	F 55°	2360	2340	2700K 3000K 3500K 4000K 5000K	WT White

Example: **R6DSDR-F9CS-WT**

Frame-In Kit (Optional Accessory)	Model	Notes
	R6DRDN-FRAME IC-Rated, Airtight	Ceiling thickness: 1/2" - 1 1/2"



TITLE 24

CALIFORNIA

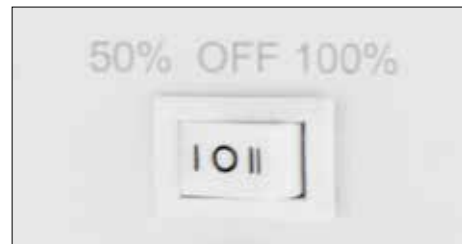

Rocker Switch
adjusts between
0%, 50%, or 100%



CCT Selectable

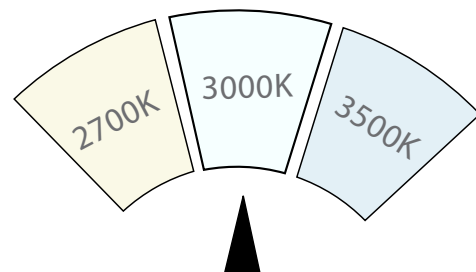

BARLIGHT UNDERCABINET LIGHTING



Perfect for lighting kitchen counters, our 120V Undercabinet Bar Light with selectable 3 CCT technology and a High-Low switch to provide quality illumination for all tasks.



Input: 120V
Rated Life: 50,000 hours
Dimming: 100%-10% ELV
 100%-5% TRIAC
CRI: 90

- CCT Selectable: 2700K/3000K/3500K
- Rocker switch to adjust between 0%, 50%, or 100%
- Construction: Aluminum with white PC diffuser

		Model	Length	Power	Max Lumens @3000K	Color Temp	Finish
	BA-AC	08	8"	6.5W	355	CS 2700K 3000K 3500K	WT White
		18	18"	10.5W	600		
		24	24"	15W	910		
		30	30"	17.5W	1075		

Example: **BA-AC18-CS-WT**

FLUSH MOUNT EM BATTERY BACKUP



High light-output, hidden hardware, and broad, even illumination are the primary features of this sleek flush mount. Often used in hallways, dorm rooms, and bathrooms, installation is a snap.



Convenient emergency battery backup button is discreet to maintain product appearance



Input: 120-277V
CRI: 90
Dimming: 100% - 10% ELV,
 100%-5% TRIAC
Rated Life: 50,000 hours

- CCT Selectable: 2700K/3000K/3500K/4000K/5000K
- Install into 3", 4" or a combination 3/0-4/0 electrical box
- Construction: Aluminum with translucent diffuser

Model	Wattage	Max Lumen	Color Temp	CRI	Finish
FM-200111	15W	1080			
FM-200115	25W	1815	2700K 3000K 3500K 4000K 5000K	90	BN Brushed Nickel
FM-200115EM <i>Emergency Back Up</i>					
FM-200118					
FM-200118EM <i>Emergency Back Up</i>					

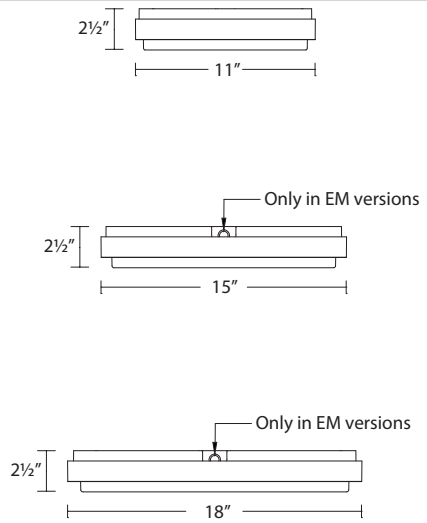

Example: **FM-200115-CS-BN**

CYLINDER OUTDOOR SCONCE



Available in single and double directions, Cylinder is ideal for illuminating outdoor entrances and walkways.



Input: 120V
CRI: 80
Dimming: 100%-10% ELV
Rated Life: 50,000 hours

- Construction: Die-cast Aluminum
- Sizes: 6 3/4" Single Light, 9 7/16" Double Lights
- Finish: Powder Coated Aluminum

	Diameter	Watt	Max Delivered Lumens	Color Temp	CRI	Finish
<p>WS-W190208</p>	5"	6W	260	30	3000K	80
<p>WS-W190212</p>	6"	18W	515			

BK Black
BZ Bronze
WT White

Example: **WS-W190208-30-BK**

STEP LIGHTS WITH INTEGRAL PHOTOCELL

Energy saving photocell sensor activates LEDs when its dark, and automatically powers off when there is ambient light.

Good for indoor and outdoor applications 

Fits into 2"x4" switch box 



STEP LIGHTS WITH INTEGRAL PHOTOCELL



Photocell is unobtrusive and does not compromise low profile design

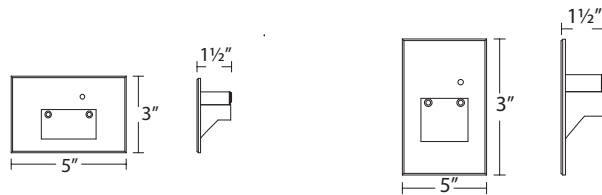

Input: 120V
Power: 2W
Lumens: Up to 65lm
CRI: 90+
Rated Life: 54,000 hours

- Options in die-cast brass or 316 marine-grade stainless steel
- Fits into 2"×4" J-Box with minimum inside dimensions of 3"×2"×2"
- No driver needed
- No heat radiation

System	Color			Finish
WL-LED102 120V Horizontal Scoop	30 Pure White	3000K (CCT)	BK Black on Aluminum BN* Brushed Nickel on Aluminum BZ Bronze on Aluminum SS Stainless Steel WT White on Aluminum	
	AM Amber	610nm (Peak)		
WL-LED103 120V Horizontal Scoop	30 Pure White	3000K (CCT)	WT* Anti-microbial White	
	AM Amber	610nm (Peak)		
WL-LED202 120V Vertical Scoop	30 Pure White	3000K (CCT)	BK Black on Aluminum BN* Brushed Nickel on Aluminum BZ Bronze on Aluminum SS Stainless Steel WT White on Aluminum	
	AM Amber	610nm (Peak)		
WL-LED203 120V Vertical Scoop	30 Pure White	3000K (CCT)	WT* Anti-microbial White	
	AM Amber	610nm (Peak)		

*Anti-microbial powder coat paint proven to restrain a wide range of bacteria, coliform, mold, fungus, algae and yeast.

*Anti-microbial powder coat paint proven to restrain a wide range of bacteria, coliform, mold, fungus, algae and yeast.

Example: **WL-LED103-30-WT**

*BN Finish is not warranted for contact with chemicals or exterior installations.
 Use Brass or Stainless Steel Step and Wall Lights for harsh outdoor environments.

ADJUSTABLE BEAM WALL WASH LED LANDSCAPE

WITH BEAM AND INTEGRAL BRIGHTNESS CONTROL

New!

- Continuously adjustable NEMA beam distribution 3x4 (35°x60°), 4x5 (60°x90°), 5x6 (90°x120°)
- IP66 Rated, protected against powerful water jets
- Solid die-cast brass or corrosion resistant aluminum alloy

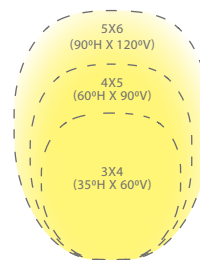
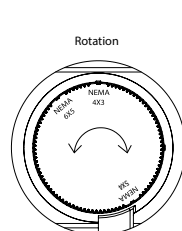
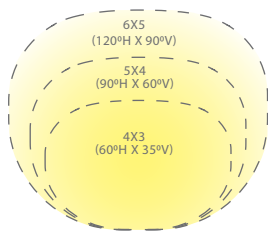
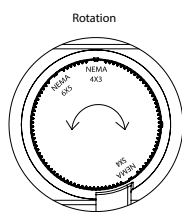

Architectural beam distributions from 3x4 to 4x5 to 5x6 proportions and everything in between.
Always a uniform wide beam wash of light.



NEMA 5x4 ←

→ NEMA 4x5

ADJUSTABLE BEAM WALL WASH LED LANDSCAPE

WITH BEAM AND INTEGRAL BRIGHTNESS CONTROL



New!

12V

- Continuously adjustable NEMA beam distribution 3x4 (35°x60°), 4x5 (60°x90°), 5x6 (90°x120°)
- Integral brightness control
- Rotatable fixture head for vertical distribution

Transformer Required (order separately)

Input Power	9-15VAC
Brightness	3W to 25W/4.4VA-27.8VA
Beam Angle	200 lm to 1500 lm
CRI	Assorted NEMA distributions
Rated Life	85
	70,000 hours

120V

- Continuously adjustable NEMA beam distribution 3x4 (35°x60°), 4x5 (60°x90°), 5x6 (90°x120°)
- Integral brightness control
- Simple to retrofit existing line voltage systems or coordinate well with a new commercial landscape job

Input Power	110V - 120VAC
Brightness	3W to 25W
Beam Angle	200 lm to 1550 lm
CRI	Assorted NEMA distributions
Rated Life	85
	45,000 hours

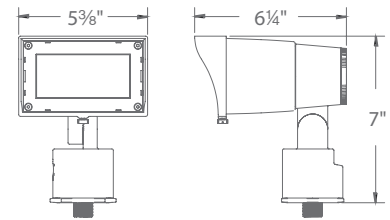

5221-27 2700K	BK	Black on Aluminum
	BZ	Bronze on Aluminum
	BBR	Bronze on Brass

5222-27 2700K	BK	Black on Aluminum
	BZ	Bronze on Aluminum
	BBR	Bronze on Brass

5221-30 3000K	BK	Black on Aluminum
	BZ	Bronze on Aluminum
	BBR	Bronze on Brass

5222-30 3000K	BK	Black on Aluminum
	BZ	Bronze on Aluminum
	BBR	Bronze on Brass

Architectural beam distributions from 3x4 to 4x5 to 5x6 proportions and everything in between.

Always a uniform wide beam wash of light.

Accessories

14" Mounting Stake		9000-ST14-BZ	Bronze	Durable PC stake	
Surface Mount Flange/Stake		5000-SCP-BK 5000-SCP-BZ 5000-SCP-BBR	Black on Aluminum Bronze on Aluminum Bronze on Brass	Includes three 7 inch threaded stainless steel stabilizing pins for ground mounting or surface mounts with four screws or over a junction box	
Guardian Mount		9000-SP9-BZ	Stainless Steel	Heavy duty stainless steel spike to position fixture	
Gutter Mount Bracket		5000-GM-BK 5000-GM-BZ	Black on Aluminum Bronze on Aluminum	Stainless steel universal mounting bracket for gutter mounting fixture	
Tree Mount Junction Box		5000-TCP-BK 5000-TCP-BZ	Black on Aluminum Bronze on Aluminum	Aluminum box with stainless steel mounting screws; two 1/2" NPT threaded holes, UL 120V listed	
		5000-TCL-BK 5000-TCL-BZ	Black on Aluminum Bronze on Aluminum	Large Aluminum box with stainless steel mounting screws; two 1/2" NPT threaded holes, UL 120V listed	
Large Tree Mount Canopy Strap		5000-TST-BK	Black on Steel and terylene	Ratcheting device with strap to be used with Large Tree Mount Junction Box (5000-TCL)	
Optics		LENS-3X5-AMB LENS-3X5-GRN LENS-3X5-RED	Amber Green Red	LENS-3X5-BLU Blue LENS-3X5-FR Frosted LENS-3X5-SPR Spread	LENS-3X5-BEL Beam Elongating Enhances saturation of florals and foliage

14" Mounting stake (12V), detachable shroud, 6' lead wire and direct burial gel filled wire nuts (12V) or standard wire nuts (120V) included

HARDSCAPE LED LANDSCAPE

NEW WITH QUICK RELEASE LIGHT ENGINE, DUAL CCT AND INTEGRAL BRIGHTNESS CONTROL

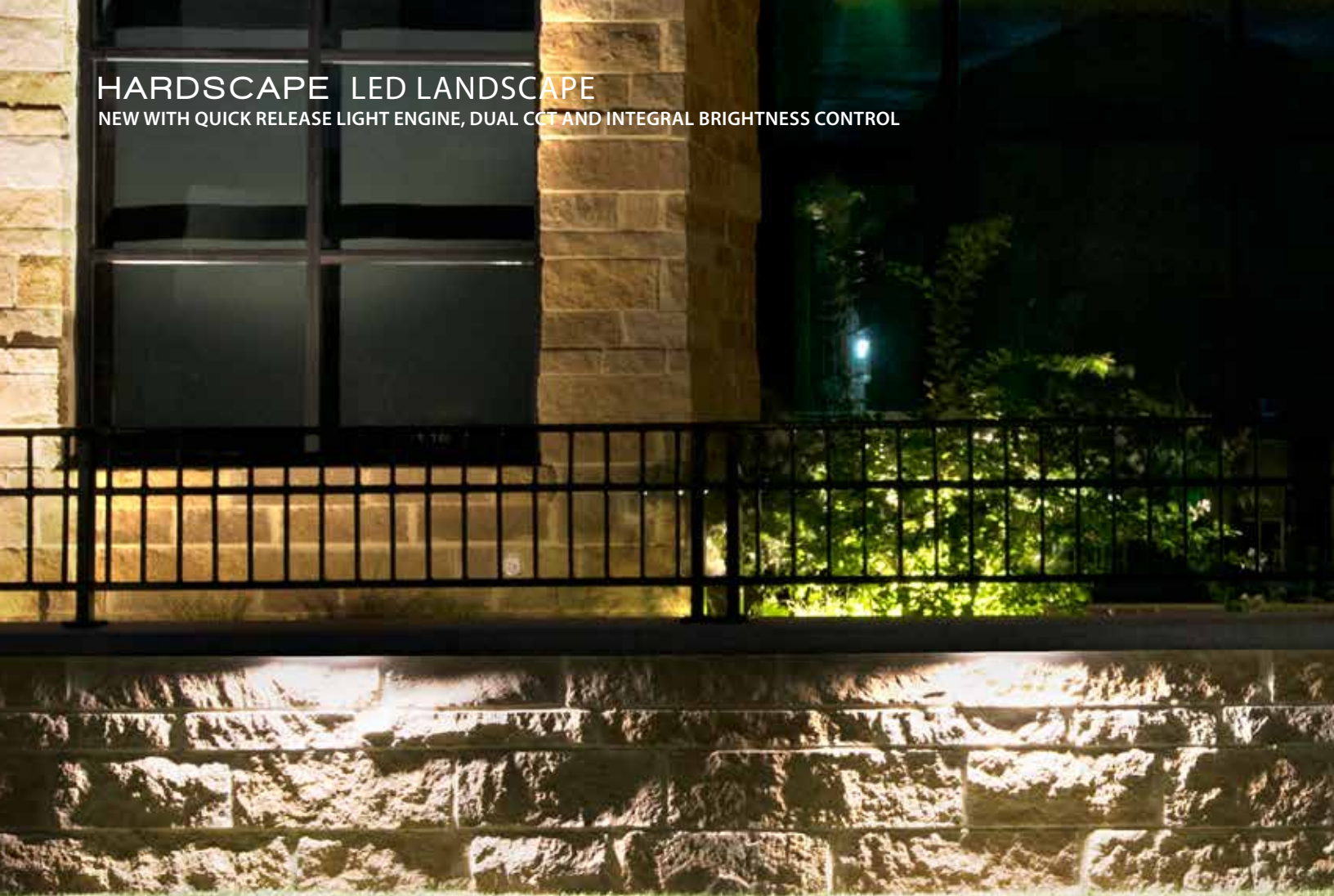

New!



CCT SELECTABLE ONBOARD

2700K > 3000K

Quick Release

Based on popular demand, our new patent-pending invention allows for a watertight male/female connection at the fixture for ease of replacement after it is installed

HARDSCAPE LED LANDSCAPE

NEW WITH QUICK RELEASE LIGHT ENGINE, DUAL CCT AND INTEGRAL BRIGHTNESS CONTROL



7182-27/30 18 inches

12V



7122-27/30 12 inches



7062-27/30 6 inches



7032* 3 inches

* Due to its compact size, the 7032 is dedicated in either 2700K or 3000K.

- Quick Release connection at fixture easily detach from Capstone bracket after installation
- Integral Brightness control
- Select Color Temperature in the field
- Corrosion-resistant aluminum alloy
- Factory-sealed water tight fixture
- Transformer required (sold separately)
- Tightly spaced and diffused LEDs for even illumination
- 6' lead wire and direct burial gel-filled wire nuts included
- Patents pending

Input: 9-15VAC
Lumens: Up to 350 lm
CRI: 90+
Rated Life: 50,000 hours

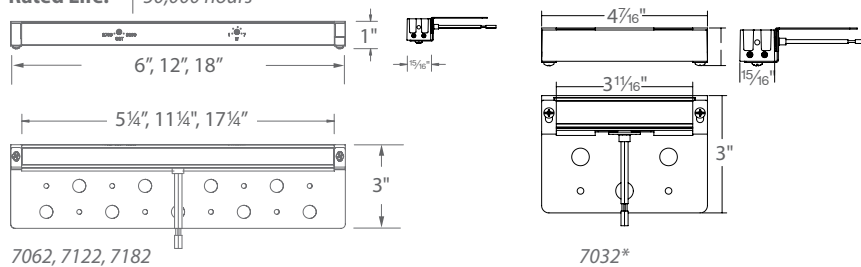

7062, 7122, 7182

7032*



Length	Model	Color Temp	Wattage	Max Lumens	Finishes
3"*	7032-27 7032-30	2700K Warm White* 3000K Pure White*	1.5W, 2.6VA	50	BZ Bronze on Aluminum GH Graphite SD Sand
6"	7062-27/30	2700K Warm White 3000K Pure White	4.5W, 5.6VA	110	BZ Bronze on Aluminum BBR Bronze on Brass GH Graphite SD Sand
12"	7122-27/30	2700K Warm White 3000K Pure White	7.0W, 7.6VA	230	BZ Bronze on Aluminum BBR Bronze on Brass GH Graphite SD Sand
18"	7182-27/30	2700K Warm White 3000K Pure White	8.5W, 9.3VA	350	BZ Bronze on Aluminum GH Graphite SD Sand

Example: **7182-27/30SD**

SURFACE MOUNTED STEP LIGHT LED LANDSCAPE
LOW PROFILE INSTALLATION



Constant light output for 9V-15V input,
compatible with all WAC Landscape Lighting products.

SURFACE MOUNTED STEP LIGHT LED LANDSCAPE

LOW PROFILE INSTALLATION



- **Slim, low profile design-surface mount installation (junction box not required)**
- Die-cast aluminum or die-cast brass
- Invisible hardware
- 6' lead wire included
- Compatible with WAC 12V Landscape Transformers (sold separately)

Fixture can be mounted directly to the wall without a junction box

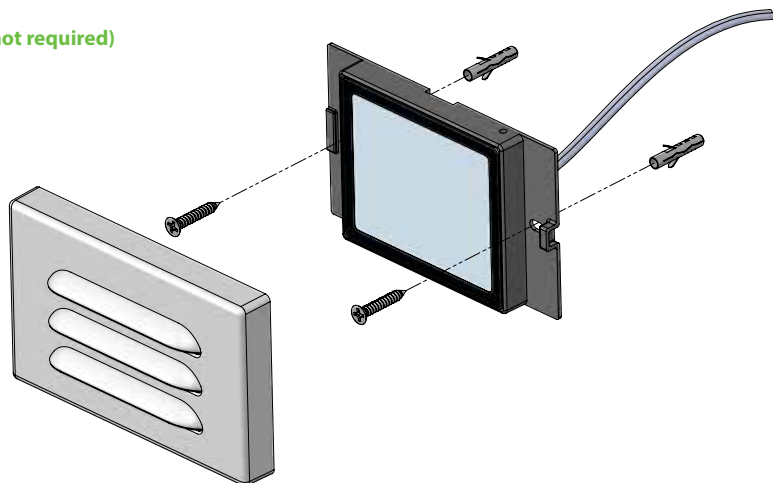

Input	9-15VAC
Power	4W / 6.5VA
Brightness	55 lm
Color Temp	2700K Warm white, 3000K Pure white
CRI	90
Rated Life	70,000 hours



4501-27 2700K	BK Black on Aluminum
4501-30 3000K	BZ Bronze on Aluminum
	WT White on Aluminum
	BBR Bronze on Brass

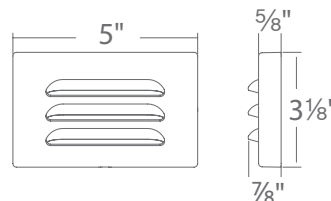

Input	9-15VAC
Power	8W / 12VA
Brightness	100 lm
Color Temp	2700K Warm white, 3000K Pure white
CRI	90
Rated Life	70,000 hours



4901-27 2700K	BK Black on Aluminum
4901-30 3000K	BZ Bronze on Aluminum
	WT White on Aluminum
	BBR Bronze on Brass

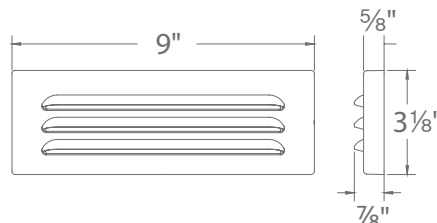

INDEX

RECESSED

OCULUX ARCHITECTURAL 2" MULTIPLE SPOTS 2-7
OCULUX ARCHITECTURAL 3.5" DIM-TO-WARM..... 8-13

TRACK/MONOPOINT

SILO LED PENDANT..... 14-15

INVISILED®

INVISILED® CCT COLOR TEMPERATURE ADJUSTABLE TAPE 16-17
PRO 18-19
PRO2 20
PRO3 20
LITE 21
INVISILED® ACCESSORIES..... 22-27
INVISILED® OUTDOOR WET RATED LED TAPE 28-29

LIMITED

PUCK LIGHT 30-31
DISC LED FAN 32-33
ION 2" LED RECESSED 34
POP-IN 4" LED RECESSED 35
BLAZE 6" LED RECESSED 36
LOTOS 4" & 6" ADJUSTABLE LED RECESSED 37
BARLIGHT 38-39
FLUSH MOUNT EM BATTERY BACKUP..... 40
CYLINDER OUTDOOR SCONCE 41

OUTDOOR

STEP LIGHTS WITH INTEGRAL PHOTOCELL..... 42-43

LANDSCAPE

ADJUSTABLE BEAM WALL WASH 44-45
HARDSCAPE..... 46-47
SURFACE MOUNTED STEP LIGHT 48-49

Headquarters

Tel: 800.526.2588

Fax: 800.526.2585

West Coast Factory

1750 S Archibald Ave
Ontario, CA 91761

East Coast Factory

44 Harbor Park Dr
Port Washington, NY 11050

Central Factory

1600 Distribution Ct
Lithia Springs, GA 30122

Consult the factory to take advantage of our custom capabilities in large quantities. For up to date product specifications and assistance please

visit **waclighting.com**

or call

1-800-526-2588

Copyright © 2020 by WAC Lighting.

All rights reserved. This catalog is copyrighted and WAC Lighting will use all measures available to it under the law against anyone who copies or derives from its copyrighted work.

WAC Lighting retains the right to modify the design of our products at any time as part of the company's continuous improvement program.

The background features a dark, almost black, space with several glowing, curved lines in shades of blue and cyan. These lines flow from the top right towards the bottom left, creating a sense of movement and depth. The lines vary in thickness and brightness, with some appearing as thin, sharp streaks and others as broader, more ethereal bands. The overall effect is reminiscent of light trails or the movement of liquid in a dark environment.

WAC LIGHTING

wacighting.com