



WAC LIMITED





WAC LIMITED

Maximize desirability and minimize expenses with WAC Limited products designed to accommodate both single-family or multifamily housing projects and large-scale apartment complexes and hotel guestrooms.

Lighting a space well elevates the perceived value of all finishes used and increases functionality of spaces while also minimizing maintenance and energy expenses. Dollar for dollar, quality lighting improves occupant experiences more than any other construction material. Our wide array of products cover kitchens, baths, bedrooms, closets, hallways, living rooms, laundry rooms, and garages—all designed for safety and proven to last.

We also understand that installation costs are a major part of the value equation. As such, WAC Limited products are engineered to reduce installation costs. Premium lighting products and designs can be found in the WAC Lighting and dweLED product lines.

DISC II LED FAN



F-033L-BN



An energy efficient ceiling fan with a quiet DC motor and LED luminaire make Disc II 70% more efficient than conventional fans

DISC II LED FAN



A streamlined look suited for bedrooms and living rooms. The sweep of the 52" blades efficiently create a "cooling effect" and complement the silent DC motor.

- Blade:** 13° Pitch, 52" Sweep, Plywood
- Downrod:** 3/4" W x 4 1/2" H Included
- Mounting Slope:** Up to 30°
- Lead Wire:** 80"
- Hanging Weight:** 18 lbs
- LED Lumens:** 2100
- Total Power:** 52W
- LED Power:** 25W

- 3-speed 120 x 15 DC motor for quiet and powerful operation
- Precision balanced blades for wobble-free operation
- Pull-chain operated and reversible from housing
- Fan and LED module are Energy Star® certified
- Memory module—fan will recall last speed setting if switched off
- Damp rated

Model	Housing		Blade
F-033L	BN	Brushed Nickel	Titanium Silver
	MB	Matte Black	Matte Black
	MW	Matte White	Matte White

Example: **F-033L-BN**

ENERGY GUIDE		
Standard	High Speed	Weighted Average
Electricity	25W	17W
Airflow	5,032 CFM	3,964 CFM
Energy Costs*	-	\$5/yr
Efficiency	237 CFM/W	237 CFM/W

*Estimated annual energy cost based on \$0.12 per kWh and 6.4 hours use per day

ACCESSORIES sold separately

DC-I Coupler	BN	Brushed Nickel
	MB	Matte Black
	MW	Matte White
SC- Slope Ceiling Kit	BN	Brushed Nickel
	MB	Matte Black
	MW	Matte White
DR- Downrods	12	BN Brushed Nickel MB Matte Black MW Matte White
	18	
	24	
	36	
	48	

ATLANTIS LED FAN



TITLE 24
CALIFORNIA



DAMP



ATLANTIS offers a Damp rated, high-value fan with three speed options and can be reversed from the housing to pull hot air up during winter months. Enhance your interiors with the gently-curved shape of this elegant fan.

Blade:	13° Pitch, 52" Sweep, Steel, Plywood
Downrod:	3/4" W x 6" H included
Mounting Slope:	Up to 30°
Lead Wire:	80"
Hanging Weight:	18 lbs
LED Lumens:	1600/708
Total Power:	83W
LED Power:	19.5W

- 3 fan speeds
- Silent 153 x 16 AC motor
- Pull chain operation
- Fan is reversible from housing
- Dim using 0-10v dimmer
- Compatible with the optional battery powered wall control/receiver (F-WCAC-WT)
- Works with AC motor ceiling fan controls and light dimmers

Model	Housing	Blade
F-072L	BN Brushed Nickel	Titanium Silver
	MB Matte Black	Matte Black
	MW Matte White	Matte White

Example: **F-072L-MB**

ENERGY GUIDE		
Standard	High Speed	Weighted Average
Electricity	63W	40W
Airflow	5,001 CFM	3,717 CFM
Energy Costs*	-	\$11/yr
Efficiency	92 CFM/W	92 CFM/W

*Estimated annual energy cost based on \$0.12 per kWh and 6.4 hours use per day

ACCESSORIES sold separately

DC-I Coupler	BN Brushed Nickel		
	MB Matte Black		
	MW Matte White		
SC- Slope Ceiling Kit	BN Brushed Nickel		
	MB Matte Black		
	MW Matte White		
DR- Downrods	12	48	BN Brushed Nickel
	18	60	MB Matte Black
	24	72	MW Matte White
	36		



Optional battery powered wall control/receiver (F-WCAC-WT)

ATLANTIS FLUSH Flush Mount LED Fan



TITLE 24
CALIFORNIA



DAMP

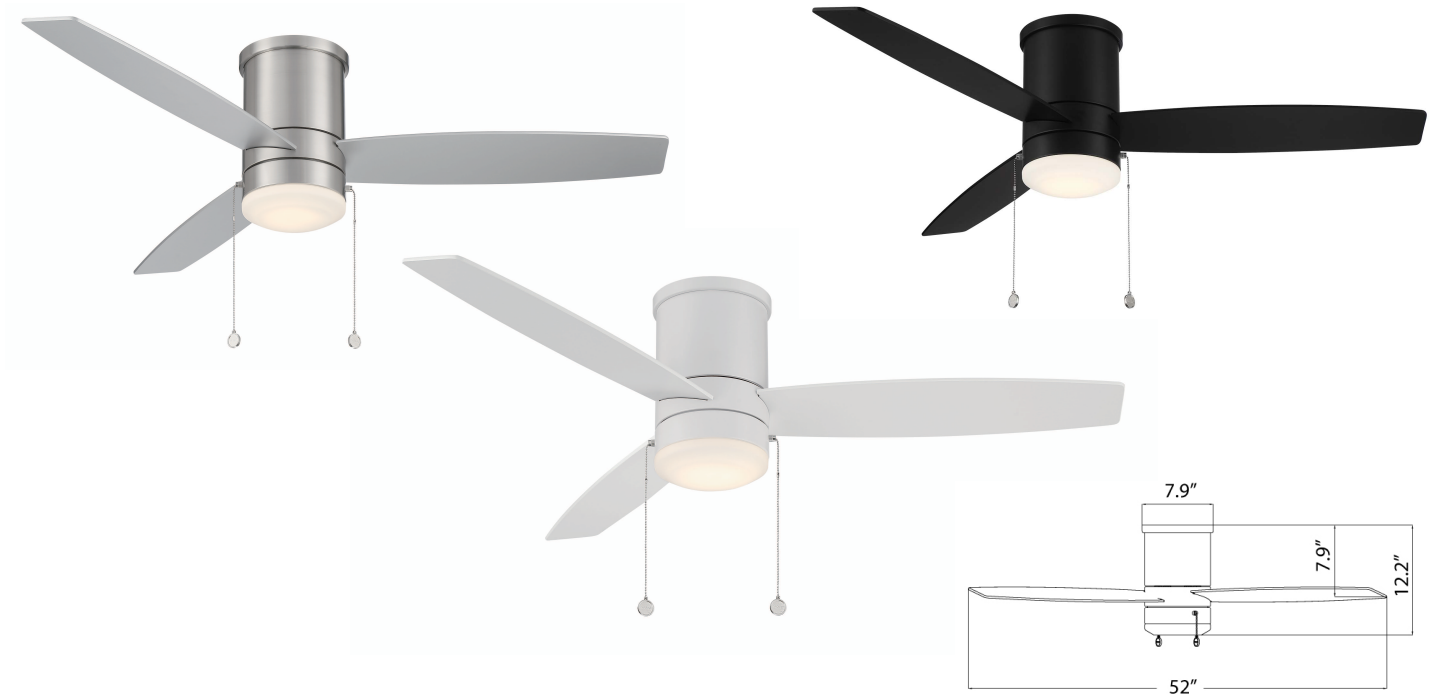

ATLANTIS offers a Damp rated, high-value fan with three speed options and can be reversed from the housing to pull hot air up during winter months. Enhance your interiors with the gently-curved shape of this elegant fan.

Blade: 13° Pitch, 52" Sweep, Steel, Plywood
 Lead Wire: 8"
 Hanging Weight: 18 lbs
 LED Lumens: 1600/708
 Total Power: 83W
 LED Power: 19.5W

- 3 fan speeds
- Silent 153 x 16 AC motor
- Pull chain operation
- Fan is reversible from housing
- Dim using 0-10v dimmer
- Compatible with the optional battery powered wall control/receiver (F-WCAC-WT)
- Works with AC motor ceiling fan controls and light dimmers

Model	Housing	Blade
F-073L	BN Brushed Nickel	Titanium Silver
	MB Matte Black	Matte Black
	MW Matte White	Matte White

ACCESSORIES sold separately



Optional battery powered wall control/receiver (F-WCAC-WT)

Example: **F-073L-MB**

ENERGY GUIDE		
Standard	High Speed	Weighted Average
Electricity	63W	40W
Airflow	4,116 CFM	3,046 CFM
Energy Costs*	-	\$11/yr
Efficiency	75 CFM/W	75 CFM/W

*Estimated annual energy cost based on \$0.12 per kWh and 6.4 hours use per day



TITLE 24
CALIFORNIA



Cut and securely reconnect with ease



Input: 24VDC
Lumens: Up to 300 lm/ft
Rated Life: 50,000 hours
CRI: 90

- Cut and re-connectable with secure screw terminal accessories
- May be cut every 2 inches
- Uniform illumination
- Seamless line of light



TAPE SELECTIONS

System	Lumens	Max Run	Power	Length	Color Temp	Finish
T24-GE3	300+lm/ft	15ft (60W) 24ft (96W)	3W/ft	15 15 ft spool (includes 2pcs T24-BS-MM-CL)	27 2700K	WT White
				24 24 ft spool (includes 4pcs T24-BS-MM-CL)	30 3000K	
				100 100 ft spool (includes 10pcs T24-BS-MM-CL)	35 3500K	
					40 4000K	

Example: **T24-GE3-15-30WT**

See page 11 for compatible power supplies and accessories

BASICS TAPE CUT AND CONNECT



Available in convenient spools up to 100ft

Up to 40ft max distance between power supply and beginning of tape run

Cut and securely reconnect with ease

.31" *Actual size shown



Input: 24VDC
 Lumens: Up to 200 lm/ft
 Rated Life: 50,000 hours
 CRI: 90

- Cut and re-connectable with secure screw terminals accessories
- May be cut every 4 inches
- Good color rendering
- Suitable for installation in a clothes closet
- 40ft max distance between the power supply and beginning of tape

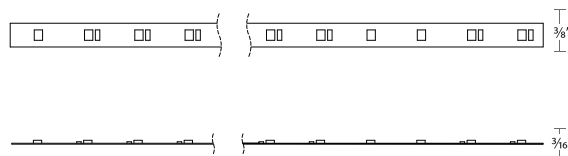

TAPE SELECTIONS

System	Lumens	Max Run	Power	Length	Color Temp	Finish
T24-BS1	100+lm/ft	40ft	1.2W/ft	15 15 ft spool (includes 2pcs T24-BS-MM-CL)	27 2700K	WT White
				40 40 ft spool (includes 8pcs T24-BS-MM-CL)	30 3000K	
				100 100 ft spool (includes 20pcs T24-BS-MM-CL)	35 3500K	
T24-BS2	200+lm/ft	30ft	2.4W/ft	40 4000K		
				50 5000K		

Example: T24-BS1-15-27WT

See page 11 for compatible power supplies and accessories

INDOOR ALUMINUM CHANNELS

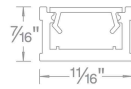

Aluminum Channel
Additional End Caps

LEO-T-CH
LEO-T-CH-EC

5 feet
2 pcs

*Diffuses light from LED tape
Includes a diffuser, two end caps, and five screws*

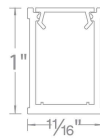

Deep Aluminum Channel
Additional End Cap

LEO-T-CH1
LEO-T-CH1-EC

5 feet
2 pcs

*Eliminates visible hot spots
Includes a diffuser, two end caps, and five screws*

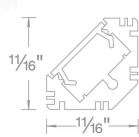

45° Angled Aluminum Channel
Additional End Caps

LEO-T-CH2
LEO-T-CH2-EC

5 feet
2 pcs

Includes a diffuser, two end caps, and five screws

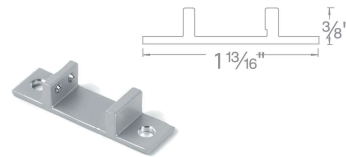

Fixed
Channel Clip

LED-T-CL3-PT

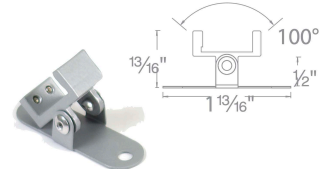

Adjustable
Channel Clip

LED-T-CL2-PT

Includes 1 piece, 4 screws. Use to mount Aluminum Channel Deep Aluminum Channel, 45° Angled Aluminum Channel

INDOOR MOUNTING ACCESSORIES

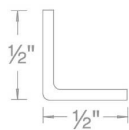

Aluminum Retrofit Channel

LEO-T-RC

3 feet

Can be bent to create fixed curves or used as a glare



Mounting Clip
Secures on one edge

T24-BS-CL1

Pack of 10

Clips to hold indoor tape sections. Includes 10 clips, 10 screws.



COMPATIBLE CLASS 2 POWER SUPPLY (REQUIRED)



- ELV Dimming 100%-10%
- 6ft Output lead wires





- Universal Input, ≥ 0.9 pf
- Overload and short circuit protection

Model	Dimension	Input	Output	Dimming
EN-BT60-24	6½" x 2½" x 1¼"	120V	24VDC 60W	ELV
EN-BT96-24	6½" x 2½" x 1¼"	120V	24VDC 96W	ELV
PS-24DC-U60R-BT	7¾" x 3¾" x 1"	120V-277V	24VDC 60W	ELV/TRIAC
PS-24DC-U96R-BT	8¾" x 3¾" x 1½"	120V-277V	24VDC 96W	ELV/TRIAC

ACCESSORIES FOR GEMINI AND BASICS TAPE

Connectors	Type	Model	Finish
	Inline Tape to Tape Connector Connects tape sections (10 pieces per pack)	T24-BS-MM	CL Clear
	Power to Tape Connector Connects tape sections (10 pieces per pack)	T24-BS-PM	CL Clear
	L Connector Connects tape sections (2 pieces per pack)	T24-BS-L	CL Clear
	Flex Y Connector Connects tape sections and power feed Includes LED-T-B (1pc)	T24-BS-Y	BK WT Black White
	Flex X Connector Connects tape sections and power feed Includes LED-T-B (1pc)	T24-BS-X	BK WT Black White
	Low Voltage Wiring Box Neatly house connections for up to 2 wires	LED-T-B	-- --

Example: **T24-BS-MM-CL**

Extension Cables	Type	Model	Finish
	Joiner Cable Extends distance between tape sections	T24-BS-IC-002 2 in T24-BS-IC-006 6 in T24-BS-IC-012 1 ft T24-BS-IC-036 3 ft T24-BS-IC-072 6 ft	BK WT Black White
	Extension Cable Extends distance between tape sections and power supply (Includes LED-T-B (1 pc) & screw driver	T24-BS-EX2-072 6 ft T24-BS-EX2-144 12 ft T24-BS-EX2-240 20 ft T24-BS-EX2-480 40 ft	BK WT Black White

Example: **T24-BS-EX2-240-WT**

PUCK LIGHT UNDERCABINET LIGHTING



Surface or Recessed Mounted

120V Direct Input
No Driver Required

BUILD A SYSTEM

Available in multiple color temperatures, finishes, and recessed or surface mounted options. Order single pucks or kits of multiple pucks to link together.

BEAUTIFULLY FINISHED CAST ALUMINUM



Black

Brushed Nickel

White

ALL-IN-ONE CCT SELECTABLE



PUCK LIGHT UNDERCABINET LIGHTING



A solid lighting solution for kitchen counters, our 120V Undercabinet Puck Light with 3 CCT selectable technology provides quality illumination for all tasks.

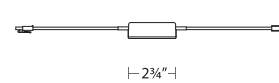
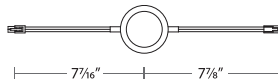
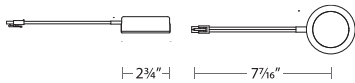

Input: 120V
CRI: 90+
Dimming: 100%-10% ELV
 100%-5% TRIAC
Rated Life: 50,000 hours

- CCT Selectable: 2700K/3000K/3500K
- Available for surface or recessed mount
- **No driver required**
- Construction: Die-cast Aluminum and PC Diffuser



	Model	Power	Max Lumens	Color Temp	Finish
NEW	 HR-AC70 1 single wired light	4.0W	290	CS 2700K 3000K 3500K	BK Black BN Brushed Nickel WT White
	 HR-AC71 1 single wired light and cord	4.0W	290	CS 2700K 3000K 3500K	BK Black BN Brushed Nickel WT White
	 HR-AC72 1 double wired light	4.0W	290	CS 2700K 3000K 3500K	BK Black BN Brushed Nickel WT White
	 HR-AC73 Puck Light Kit: 2 double wired light, 1 single wired light, and cord	4.0W x 3	290 x 3	CS 2700K 3000K 3500K	BK Black BN Brushed Nickel WT White

Example: **HR-AC72-CS-BN**

Model	Description	Finish
 HR-PC6	Power Cord	BK Black WT White
 HR-HWB	Hardware Box	BK Black WT White
 HR-IC	12 12" 24 24" 36 36" Linking Cable	BK Black WT White

Example: **HR-HWB-BK**

BARLIGHT UNDERCABINET LIGHTING

TITLE 24

CALIFORNIA



50% OFF 100%

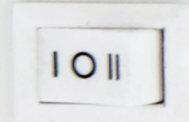

ROCKER SWITCH
ADJUSTS BETWEEN
0%, 50%, OR 100%



2700K 3000K 3500K

BARLIGHT UNDERCABINET LIGHTING



Perfect for lighting kitchen counters, our 120V Undercabinet Barlight with selectable 3 CCT technology and a High-Low switch to provide quality illumination for all tasks.

ALL-IN-ONE CCT SELECTABLE



- Input:** 120V
 - Rated Life:** 50,000 hours
 - Dimming:** 100%-10% ELV
100%-5% TRIAC
 - CRI:** 90
- CCT Selectable: 2700K/3000K/3500K
 - Rocker switch to adjust between 0%, 50%, or 100%
 - Construction: Aluminum with white PC diffuser

Model	Length	Power	Max Lumens @3000K	Color Temp	Finish
BA-AC	08 8"	6.5W	355	CS 2700K 3000K 3500K	WT White
	18 18"	10.5W	600		
	24 24"	15W	910		
	30 30"	17.5W	1075		

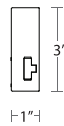
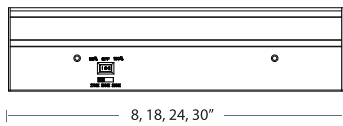

Example: **BA-AC18-CS-WT**



LOTOS 4" & 6" ADJUSTABLE LED RECESSED



ALL-IN-ONE CCT SELECTABLE



Shallow profile LED that is designed to fit in furred down ceilings without sacrificing lumen output.

- Input:** 120-277V
- Rated Life:** 50,000 hours
- Dimming:** 100%-10% ELV, 100%-5% TRIAC
- CRI:** 90
- Height: fixture-1½", Driver 1¼"
- 360° Retractable Pivot: Downlight and Adjustable
- Heavy gauge retention clips secures fixture to ceiling
- Installs into ceilings between ½" and 1½" thick
- Construction: Steel with frosted TIR lens
- CCT Selectable: 2700K/3000K/3500K/4000K/5000K

Model	Beam	Power	Max Lumens	Max CBCP	Color Temp	Finish
<p>R4ERAR 4" Round Adjustable IC-Rated, Airtight</p>	W	45°	9W	795	1050	2700K
						3000K
						9CS 3500K
						4000K
						5000K
<p>R4ESAR 4" Square Adjustable IC-Rated, Airtight</p>	W	45°	9W	750	1050	930 3000K
						WT White
<p>R6ERAR 6" Round Adjustable IC-Rated, Airtight</p>	W	45°	15W	1340	1915	2700K
						3000K
						9CS 3500K
						4000K
						5000K

Example: **R4ERAR-W9CS-WT**

Frame-In Kit (Optional Accessory)	Model	Notes
New Construction Frame	RER-FRAME	Suitable for joists ranging from 12" to 24" apart
6ft Extension Cable	RER-6	In-wall rated cable uses twist lock to secure to fixture and driver

LOTOS 2" ADJUSTABLE LED RECESSED



Shallow profile LED that is designed to fit in furred down ceilings without sacrificing light output.

Input: 120-277V
Rated Life: 50,000 hours
Dimming: 100%-10% ELV,
 100%-5% TRIAC
CRI: 90

- Height: Fixture 2 1/4" Driver 1 1/4"
- 360° Retractable Pivot: Downlight and Adjustable
- Heavy gauge retention clips secure fixture to ceiling
- Installs into ceilings between 1/2" and 1 1/2" thick
- Construction: Steel with frosted TIR lens

	Model	Beam	Power	Max Lumens	Max CBCP	Color Temp	Finish
	R2ERAR 2" Round Adjustable IC-Rated, Airtight	W 35°	6W	500	1203	930 3000K	WT White
	R2ESAR 2" Square Adjustable IC-Rated, Airtight	W 35°	6W	500	1203	930 3000K	WT White
	R2ESAR-2 2 Light Adjustable IC-Rated, Airtight	W 35°	12W	500x2	1203 x2	930 3000K	WT White
	R2ESAR-3 3 Light Adjustable IC-Rated, Airtight	W 35°	18W	500x3	1203 x3	930 3000K	WT White

Example: **R2ERAR-W930-WT**

LOTOS 4" & 6" LED RECESSED





ALL-IN-ONE CCT SELECTABLE



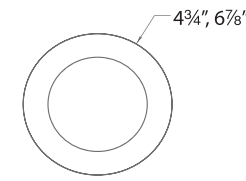

Shallow profile LED that is designed to fit in furred down ceilings without sacrificing lumen output.

Input: 120-277V
Rated Life: 50,000 hours
Dimming: 100%-10% ELV, 100%-5% TRIAC
CRI: 90

- Height: Fixture-1", Driver 1¼"
- Heavy gauge retention clips secures fixture to ceiling
- Installs into ceilings between ½" and 1½" thick
- Construction: Steel with translucent diffuser
- 5 Year Warranty
- CCT Selectable: 2700K/3000K/3500K/4000K/5000K

Model	Beam	Power	Max Lumens	Color Temp	Finish
 R4ERDR 4" Round Downlight IC-Rated, Airtight	W	8W	725	2700K	WT White
				3000K	
				9CS 3500K	
				4000K	
				5000K	
 R6ERDR 6" Round Downlight IC-Rated, Airtight	W	14W	1200	2700K	WT White
				3000K	
				9CS 3500K	
				4000K	
				5000K	

Example: **R4ERDR-W9CS-WT**

Frame-In Kit (Optional Accessory)	Model	Notes
New Construction Frame	 RER-FRAME	Suitable for joists ranging from 12" to 24" apart
6ft Extension Cable	 RER-6	In-wall rated cable uses twist lock to secure to fixture and driver

PATRIOT 3" LED RECESSED



5CCT meets adjustability. WAC's 3" PATRIOT Recessed Downlight and Adjustable provides up to 1000 lumens, suitable for residential applications. An optional frame-in kit is available for all new construction installations.

Power: 12W
 Input: 120-277V
 Dimming: 100% - 10% ELV,
 100%-5% TRIAC
 Rated Life: 50,000 hours
 CRI: 90

- Available as a Remodel or New Construction
- Installs into ceilings between 1/2" and 1 1/2" thick
- CCT Selectable: 2700K/3000K/3500K/4000K/5000K
- Two beam angle options included: 45° beam film pre-installed, remove film for 25° narrow beam
- Construction: Die-cast aluminum with reflector

	Model	Max	Max	Color Temp	Finish
	R3HRDR Round Remodel IC-Rated, Airtight Wet Location listed	1035	3045	2700K 3000K 3500K 4000K 5000K 9CS	WT White
	R3HRAR Round Adjustable Remodel IC-Rated, Airtight Wet Location listed	1000	3095	2700K 3000K 3500K 4000K 5000K 9CS	WT White
	R3HSDR Square Remodel IC-Rated, Airtight Wet Location listed	1035	3045	2700K 3000K 3500K 4000K 5000K 9CS	WT White
	R3HSAR Square Adjustable Remodel IC-Rated, Airtight Wet Location listed	1000	3095	2700K 3000K 3500K 4000K 5000K 9CS	WT White

Example: **R3HRDR-F9CS-WT**

Frame-In Kit (Optional Accessory)

New Construction Frame



Model	Notes
R3H-FRAME	Ceiling thickness: 1/2" - 1 1/2"



ION 2" LED RECESSED

Minimum profile ION 2" Round and Square downlight with remote driver and electrical connection box for easy remodel or new construction installation.



Power: 9W
Input: 120-277V
Dimming: 100% - 10% ELV,
 100%-5% TRIAC
Rated Life: 50,000 hours
CRI: 90

- Height: Fixture 3 7/8"
- Installs into ceilings between 1/2" and 1 1/2" thick
- Construction: Die-cast aluminum with frosted TIR lens
- IC-Rated, Airtight and Wet Location Listed



	Model	Beam	Max Lumens	Max CBCP	Color Temp	Finish
	R2DRDR Round Remodel	F 45°	710	993	930 3000K	WT White
	R2DRDN Round New Construction					
	R2DSDR Square Remodel	F 45°	755	1014	930 3000K	WT White
	R2DSDN Square New Construction					

Example: **R2DRDR-F930-WT**

Frame-In Kit (Optional Accessory)

New Construction Frame



Model

R2DRDN-FRAME

Notes

Ceiling thickness: 1/2" - 1 1/2"

POP-IN 4" LED RECESSED



Minimum profile downlight with driver and electrical connection box attached to fixture for easy Remodel or New Construction installation.

- Electrical wiring box directly on the back of fixture
- Available as a Remodel or New Construction
- Installs into ceilings between 1/2" and 1 1/2" thick
- Construction: Die-cast aluminum with frosted TIR lens
- CCT Selectable: 2700K/3000K/3500K/4000K/5000K

Power: 12W
Input: 120-277V
Dimming: 100% - 10% ELV,
100%-5% TRIAC
Rated Life: 50,000 hours
CRI: 90

	Model	Beam	Max Lumens	Max CBCP	Color Temp	Finish
	R4DRDR Round Remodel IC-Rated, Airtight Wet Location listed	F 45°	1080	1309	2700K 3000K 9CS 3500K 4000K 5000K	WT White
	R4DRDN Round New Construction IC-Rated, Airtight Wet Location listed	F 45°	1080	1309	2700K 3000K 9CS 3500K 4000K 5000K	WT White
	R4DSDR Square Remodel IC-Rated, Airtight Wet Location listed	F 45°	1000	1256	2700K 3000K 9CS 3500K 4000K 5000K	WT White
	R4SDN Square New Construction IC-Rated, Airtight Wet Location listed	F 45°	1000	1256	2700K 3000K 9CS 3500K 4000K 5000K	WT White

Example: **R4DRDR-F930-WT**

Frame-In Kit (Optional Accessory)

Model

Notes

New Construction Frame



R4DRDN-FRAME

Ceiling thickness: 1/2" - 1 1/2"



TITLE 24
CALIFORNIA



BLAZE 6" LED RECESSED

ALL-IN-ONE CCT SELECTABLE



BLAZE 6" Round and Square.
5-CCT selectable downlight.



Power: 25W
Input: 120-277V
Dimming: 100% - 10% ELV,
100%-5% TRIAC
Rated Life: 50,000 hours
CRI: 90

- Height: fixture 5 3/8"
- CCT Selectable: 2700K/3000K/3500K/4000K/5000K
- Installs into ceilings between 1/2" and 1 1/2" thick
- Remodel and New Construction applications
- Construction: Die-cast aluminum with frosted TIR lens
- Remote driver and wiring box included
- IC-Rated, Airtight and Wet Location Listed

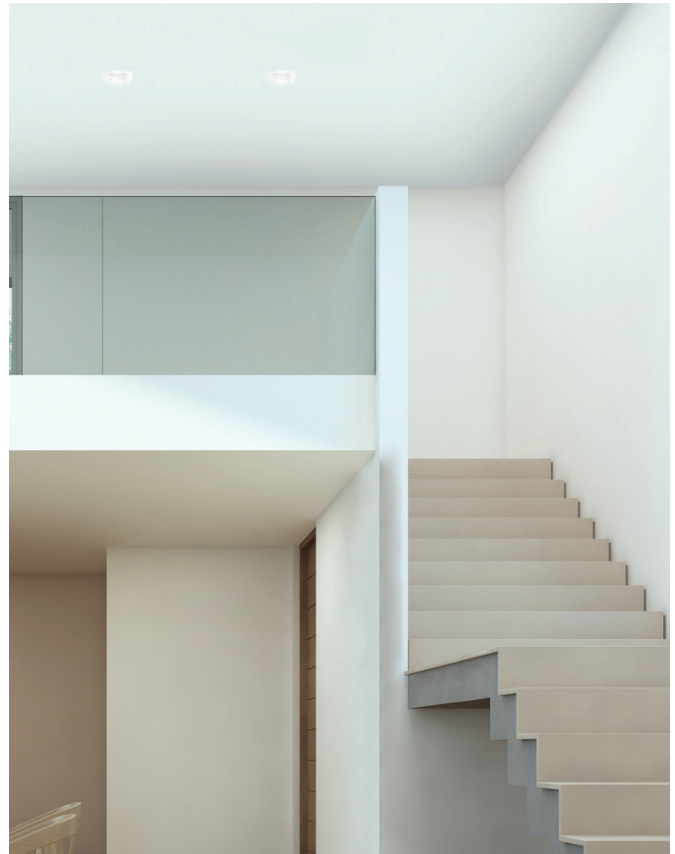

	Model	Beam	Max Lumens	Max CBCP	Color Temp	Finish
	R6DRDR Round Remodel	F 55°	2485	2292	2700K	WT White
	R6DRDN Round New Construction				3000K 3500K 4000K 5000K	
	R6SDSR Square Remodel	F 55°	2360	2340	2700K	WT White
	R6SDSN Square New Construction				3000K 3500K 4000K 5000K	

Example: **R6SDSR-F9CS-WT**

Frame-In Kit (Optional Accessory)

New Construction



Model
R6DRDN-FRAME
IC-Rated, Airtight

Notes
Ceiling thickness: 1/2"-1 1/2"



LITHIUM EM BATTERY BACKUP



ALL-IN-ONE CCT SELECTABLE

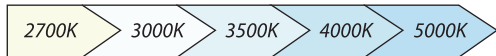

Convenient emergency battery backup button is discreet to maintain product appearance

The standard ceiling light and emergency battery backup ceiling light are nearly identical in 2 convenient sizes.

High light-output, hidden hardware, and broad, even illumination are the primary features of this sleek flush mount. Often used in hallways, dorm rooms, and bathrooms, installation is a snap.

Input: 120-277V
CRI: 90
Dimming: 100%-10% ELV,
 100%-5% TRIAC
Rated Life: 50,000 hours

- CCT Selectable: 2700K/3000K/3500K/4000K/5000K
- Install over 3", 4" or a combination 3/0-4/0 electrical box
- Construction: Aluminum with translucent diffuser

	Model	Wattage	Max Lumen	Color Temp	CRI	Finish
	FM-200111	15W	1080			
	FM-200115	25W	1815	CS 2700K 3000K 3500K 4000K 5000K	90	BN Brushed Nickel
	FM-200115EM <i>Emergency Back Up</i>					
	FM-200118	31W	2410			
	FM-200118EM <i>Emergency Back Up</i>					

Example: **FM-200115-CS-BN**

I CAN'T BELIEVE IT'S NOT RECESSED
FUNCTIONAL LED CEILING LIGHT



Multiple mid-powered LEDs illuminate the acrylic diffuser uniformly without socket shadows which are common in conventional flush mounts.

Input: 120V
CRI: 90
Dimming: 100% - 10% ELV, 100%-5% TRIAC
Rated Life: 54,000 hours

- Imitates a traditional 6" Line voltage recessed downlight with an R30 light bulb.
- Install into 4" Junction box or a combination 3/0-4/0 electrical box.
- Construction: Aluminum with translucent diffuser
- Finished screw caps included to eliminate shadows
- 5 Year Warranty



	Model	Lumens	Power	Color Temp	CRI	Finish
	FM-616G2-930-WT	1050	16W	3000K	90	White

Example: **FM-616G2-930-WT**

DISC FUNCTIONAL LED CEILING LIGHT AND RECESSED RETROFIT



FM-306MS-930JB-WT

Multiple mid-powered LEDs illuminate the acrylic diffuser uniformly.

Input: 120V
Dimming: 100% - 5% ELV, 100%-5% TRIAC
Rated Life: 36,000 hours

- FM-306MS : Motion Sensor keeps the light illuminated for 3 minutes before shutting off if no movement is detected
- Construction: Aluminum with translucent diffuser
- 5 Year Warranty



Install over a 3" or 4" junction box or pancake box



Retrofit over a 4", 5" or 6" recessed can

	Model	Lumens	Power	Color Temp	CRI	Finish	
	FM-304	725	12W	930 3000K	90	BN Brushed nickel BZ Bronze WT White	Fits over a 4" recessed can or direct wire in a 3" or 4" junction box or pancake box
	FM-306	950	15W	930 3000K 940 4000K	90	BN Brushed nickel BZ Bronze WT White	Fits over a 5" to 6" recessed can or direct wire in a 3" or 4" junction box or pancake box
	FM-306	950	15W	930JB 3000K	90	WT White	Direct mount in a 3" or 4" junction box or pancake box
	FM-306MS Infrared Motion Sensor	1100	14W	930JB 3000K	90	WT White	Direct mount in a 3" or 4" junction box or pancake box

Example: **FM-306-930JB-WT**



GLO • BLO • FLO
LED FUNCTIONAL CEILING AND WALL MOUNTS



ALL-IN-ONE CCT SELECTABLE



GLO

- Install over 3", 4" or a combination 3/0-4/0 electrical box
- Construction: Aluminum with translucent diffuser
- 5 Year Warranty
- CCT Selectable: 2700K/3000K/3500K/4000K/5000K



	Model	Max Lumens	Power	Color Temp	CRI	Finish								
	FM-211	1160	15W	CS	90	WT White								
							1660	22W	CS	90				
											2300	26W	CS	90

Example: **FM-214-CS-WT**

BLO

- Install over 3", 4" or a combination 3/0-4/0 electrical box
- Construction: Aluminum with translucent diffuser
- 5 Year Warranty
- CCT Selectable: 2700K/3000K/3500K/4000K/5000K



	Model	Max Lumens	Power	Color Temp	CRI	Finish
	FM-113	1600	22W	CS	90	WT White

Example: **FM-115-CS-WT**

FLO

- Sizes: 24", 36", 48"
- Construction: Aluminum with white acrylic diffuser
- Installation: Wall and Ceiling
- 5 Year Warranty
- CCT Selectable: 2700K/3000K/3500K/4000K/5000K



	Model	Max Lumens	Power	ColorTemp	CRI	Finish				
	WS-224	1400	17W	CS	90	WT White				
							2250	28W	CS	90

Example: **WS-236-CS-WT**

ROUND & SQUARE 5 INCH FUNCTIONAL LED CEILING OR WALL LUMINAIRE



At just ½" thick, these edge-lit flush mounts are frequently replacing the usage of recessed lighting and larger flush mounts to preserve ceiling height. Mounting over standard size junction boxes, the broad illumination is perfect for lighting hallways and other narrow spaces. Available in a range of sizes, smaller sizes are also wet location rated for use outdoors.

Input: 120-277V

CRI: 90

Dimming: 100% - 10% ELV, 100%-5% TRIAC

Rated Life: 50,000 hours

- Sizes: 5"
- Install into 3", 4" or a combination 3/0-4/0 electrical box.
- Construction: Injection molded UV rated PC with translucent diffuser
- Suitable for outdoor and coastal regions
- 5 Year Warranty

	Model	Wattage	Max Lumen	Color Temp	CRI	Finish
	FM-05RN Round	12W	1050			
	FM-05SQ Square	12W	1030	930 3000K 935 3500K	90 90	BK Black BZ Bronze NI Nickel WT White

Example: **FM-05RN-930-WT**

ROUND & SQUARE

7 INCH, 11 INCH, AND 15 INCH FUNCTIONAL LED CEILING OR WALL LUMINAIRE



Input: 120V
CRI: 90
Dimming: 100% - 10% ELV, 100%-5% TRIAC
Rated Life: 50,000 hours

- Sizes: 7", 11", 15" (Round only)
- Install into 3", 4" or a combination 3/0-4/0 electrical box.
- Construction: Aluminum with translucent diffuse
- 5 Year Warranty

	Model	Wattage	Max Lumen	Color Temp	CRI	Finish
	FM-07RN Round	15W	1100			
	FM-11RN Round	20W	1525	930 3000K 935 3500K	90 90	BK Black BN Brushed Nickel BZ Bronze WT White
	FM-15RN Round	28W	2550			
	FM-07SQ Square	15W	1100			
	FM-11SQ Square	20W	1650	930 3000K 935 3500K	90 90	BK Black BN Brushed Nickel BZ Bronze WT White

Example: **FM-15RN-930-WT**



TURBO LED VANITY LIGHTS AND WALL SCONCE

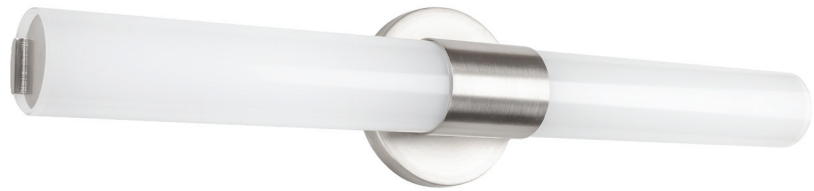

A contemporary design provides soft diffused illumination through translucent acrylic. Turbo can be mounted vertically or horizontally to accommodate a variety of applications. Available in Chrome and Brushed nickel to pair with popular bath hardware.

Input: 120-277V
Dimming: 100%-10% ELV, 100% - 5% TRIAC
Rated Life: 50,000 hours

- Sizes: 14", 24"
- Construction: Aluminum with dual layer acrylic diffuser
- Installation: Wall and Ceiling
- 5 Year Warranty

	Model	Lumens	Power	Color Temp	CRI	Finish
	WS-180414	950 1000	12W 12W	30 3000K 35 3500K	90	BN Brushed Nickel CH Chrome
	WS-180424	1480 1570	18W 18W	30 3000K 35 3500K	90	BN Brushed Nickel CH Chrome

Example: **WS-180414-35-BN**

METRO LED FLUSH MOUNT



Multiple mid-powered LEDs deliver soft illumination through translucent acrylic. Metro is available as a wall sconce or as a flush mount to meet a variety of applications. Available in Chrome and Brushed Nickel to pair with popular bath hardware.

Input: 120-277V
Dimming: 100%-10% ELV, 100% - 5% TRIAC
Rated Life: 50,000 hours

- Sizes: 12", 18"
- Height: 1 3/4"
- Install into 3", 4" or a combination 3/0-4/0 electrical box.
- Construction: Aluminum with translucent diffuser
- 5 Year Warranty

	Model	Lumens	Power	Color Temp	CRI	Finish
	FM-180112	1800	24W	30 3000K	90	BN CH Brushed Nickel Chrome
	FM-180118	2375	32W	30 3000K	90	

Example: **FM-180118-30-BN**

METRO LED VANITY LIGHTS AND WALL SCONCE



Multiple mid-powered LEDs deliver soft illumination through translucent acrylic. Metro is available as a wall sconce or as a flush mount to meet a variety of applications. Available in Chrome and Brushed nickel to pair with popular bath hardware.

- | | | |
|--------------------|-------------------------------|--|
| Input: | 120-277V | • Sizes: 20", 27", 37" |
| Dimming: | 100%-10% ELV, 100% - 5% TRIAC | • Construction: Aluminum with white acrylic diffuser |
| Rated Life: | 50,000 hours | • Installation: Wall and Ceiling |
| | | • 5 Year Warranty |

	Model	Lumens	Power	ColorTemp	CRI	Finish
	WS-180120	1150	16W	30 3000K	90	BN <i>Brushed Nickel</i> CH <i>Chrome</i>
	WS-180127	1450	20W	30 3000K	90	
	WS-180137	2130	28W	30 3000K	90	

Example: **WS-180127-30-BN**

FUSE LED VANITY LIGHTS AND WALL SCONCE



Sleek style with plated brushed nickel finished end caps and high-powered LEDs that provides broad ample illumination. Fuse can be mounted on walls or on the ceiling to suit a variety of applications and styles in current architectural design.

- | | |
|---|---|
| <p>Input: 120-277V</p> <p>Dimming: 100%-10% ELV, 100% - 5% TRIAC</p> <p>Rated Life: 50,000 hours</p> | <ul style="list-style-type: none"> • Sizes: 16", 27", 37" • Construction: Aluminum with white acrylic diffuser • Installation: Wall and Ceiling • 5 Year Warranty |
|---|---|

	Model	Lumens	Power	Color Temp	CRI	Finish
	WS-180216	1025	16W	30 3000K	90	BN <i>Brushed Nickel</i>
	WS-180227	1450	20W	30 3000K	90	
	WS-180237	2025	28W	30 3000K	90	

Example: **WS-180216-30-BN**

LINK LED VANITY LIGHTS AND WALL SCNCE



This low-profile transitional wall sconce provides bountiful light and style. Link adds a clean, modern look to bath vanities and other décor. May be installed horizontally over a vanity or vertically as a sconce.

Input: 120-277V
Dimming: 100%-10% ELV, 100% - 5% TRIAC
Rated Life: 50,000 hours

- Sizes: 27", 37"
- Construction: Aluminum with white acrylic diffuser
- Installation: Wall and Ceiling
- 5 Year Warranty

	Model	Lumens	Power	Color Temp	CRI	Finish
	WS-180327	1380	20W	30 3000K	90	BN <i>Brushed Nickel</i>
	WS-180337	1950	28W	30 3000K	90	

Example: **WS-180337-30-BN**

CUBIX & CYLINDER OUTDOOR SCNCE



WS-W220208-30-BK



WS-W220212-30-WT



WS-W190208-30-BZ



WS-W190212-30-WT

Available in single and double directions, Cubix and Cylinder are ideal for illuminating outdoor entrances and walkways.

Input: 120V
 CRI: 80
 Dimming: 100%-10% ELV
 Rated Life: 50,000 hours

- Construction: Die-cast aluminum
- Sizes: 6 $\frac{3}{4}$ " Single Light, 9 $\frac{1}{16}$ " Double Lights
- Finish: Powder Coated Aluminum

	Model	Watt	Max Delivered Lumens	Color Temp	CRI	Finish
	WS-W220208	6W	285	30 3000K	80	BK Black BZ Bronze WT White
	WS-W220212	18W	765			
	WS-W190208	6W	260			
	WS-W190212	18W	515			

Example: **WS-W220208-30-BK**

VEGA OUTDOOR SCNCE



Input: 120V
 CRI: 90
 Dimming: 100%-10% ELV
 Rated Life: 50,000 hours

- Construction: Die-cast Aluminum with acrylic diffuser
- Sizes: 9" and 14"
- Finish: Powder Coated Aluminum

	Model	Watt	Max Delivered Lumens	Color Temp	CRI	Finish
	WS-W190109	8W	545	30 3000K	90	BK Black
	WS-W190114	16W	1,050			

Example: **WS-W190114-30-BK**

120V/277V RECTANGULAR STEP & WALL LIGHTS



Input: 120V, 277V
Brightness: Up to 4 lm
CRI: 90
Dimming: 100% - 10% ELV (120V only)
Rated Life: 50,000 hours

- Fluid decorative profile with full cut-off illumination
- Die-cast aluminum construction with abrasion-resistant powder-coated finish, or plated brushed nickel finish
- Title 24 compliant (120V only)

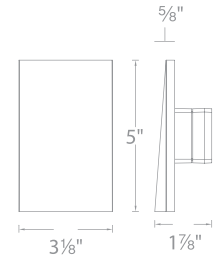
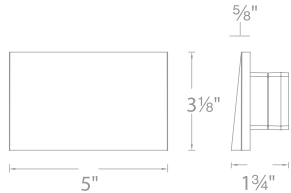

Voltage	Power	Model	Color Temp	Finishes
120V	3.5W	WL-LED110-C	3000K	BK Black on AL
		WL-LED110-AM	Amber	BN* Brushed Nickel
277V	3W	WL-LED110F-C	3000K	BZ Bronze on AL
		WL-LED110F-AM	Amber	WT White on AL

Example: **WL-LED110-C-WT**

Voltage	Power	Model	Color Temp	Finishes
120V	3.5W	WL-LED210-C	3000K	BK Black on AL
		WL-LED210-AM	Amber	BN* Brushed Nickel
277V	3W	WL-LED210F-C	3000K	BZ Bronze on AL
		WL-LED210F-AM	Amber	WT White on AL

Example: **WL-LED210-C-BK**

*BN Finish is not warranted for contact with harsh chemicals or exterior installations.

Input: 120V, 277V
Brightness: Up to 36 lm
CRI: 90
Dimming: 100% - 10% ELV (120V only)
Rated Life: 50,000 hours

- Louvered design shields glare for visual comfort
- Die-cast aluminum construction with abrasion-resistant powder-coated finish
- Title 24 Compliant (120V only)

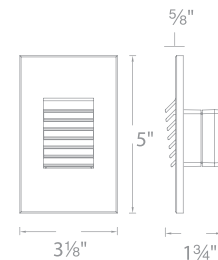
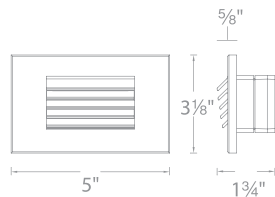

Voltage	Power	Model	Color Temp	Finishes
120V	3.5W	WL-LED120-C	3000K	BK Black on AL
		WL-LED120-AM	Amber	BZ Bronze on AL
277V	3W	WL-LED120F-C	3000K	WT White on AL
		WL-LED120F-AM	Amber	

Example: **WL-LED120-C-BZ**

Voltage	Power	Model	Color Temp	Finishes
120V	3.5W	WL-LED220-C	3000K	BK Black on AL
		WL-LED220-AM	Amber	BZ Bronze on AL
277V	3W	WL-LED220F-C	3000K	WT White on AL
		WL-LED220F-AM	Amber	

Example: **WL-LED220-C-BZ**

120V/277V RECTANGULAR STEP & WALL LIGHTS



Input: 120V, 277V
Brightness: Up to 40 lm
CRI: 90
Dimming: 100% - 10% ELV (120V only)
Rated Life: 50,000 hours

- Tempered glass diffuses light for even illumination
- Die-cast aluminum construction with abrasion-resistant powder-coated finish, or marine-grade stainless steel option available
- Title 24 compliant (120V only)

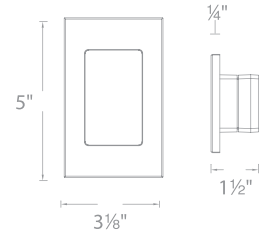
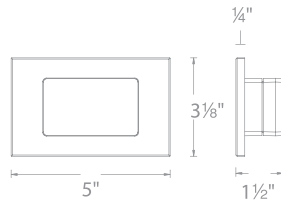

Mounts Vertically or Horizontally

Voltage	Power	Model	Color Temp	Finishes
120V	3.5W	WL-LED130-C	3000K	BK Black on AL BZ Bronze on AL SS Stainless Steel WT White on AL
		WL-LED130-AM	Amber	
277V	3W	WL-LED130F-C	3000K	
		WL-LED130F-AM	Amber	

Example: **WL-LED130-C-SS**

Input: 120V, 277V
Brightness: Up to 3 lm
CRI: 90
Dimming: 100% - 10% ELV (120V only)
Rated Life: 50,000 hours

- Geometric design with downward illumination
- Die-cast aluminum construction with abrasion-resistant powder-coated finish
- Title 24 compliant (120V only)

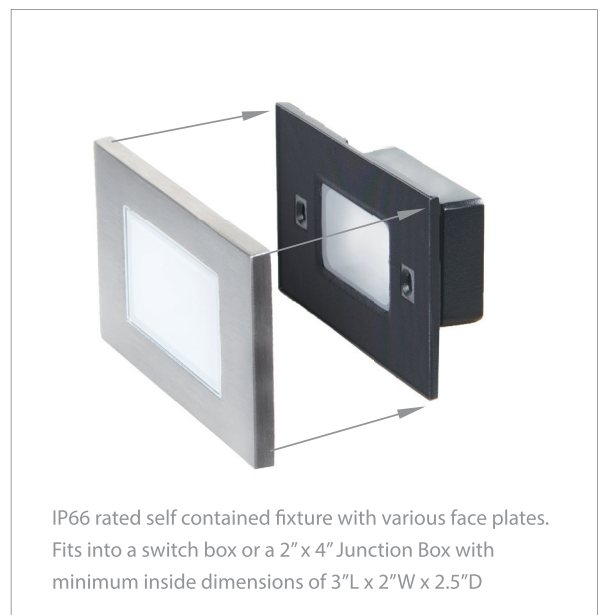
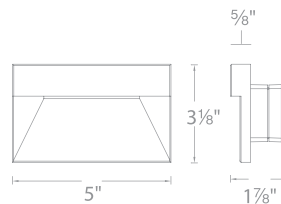
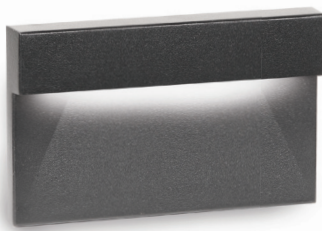

Voltage	Power	Model	Color Temp	Finishes
120V	3.5W	WL-LED140-C	3000K	BK Black on AL BZ Bronze on AL WT White on AL
		WL-LED140-AM	Amber	
277V	3W	WL-LED140F-C	3000K	
		WL-LED140F-AM	Amber	

Example: **WL-LED140-C-BK**

SOLO LED FIXED RAIL NEW BLACK AND WHITE FINISHES

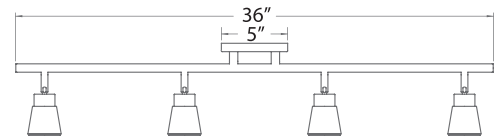
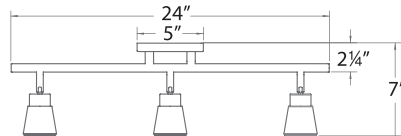
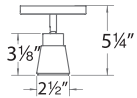

Monopoint, 3-head, or 4-head fixed track with individually adjustable LED track fixtures can be wall mounted or ceiling mounted for a wide multitude of applications. It is specifically designed for residential and low-ceiling commercial applications.

Power: 10W/head
Delivered Lumens: Up to 800
CBCP: Up to 1095
Comparable to: 65W MR16
Dimming: 100%-10% ELV, 100%-5% TRIAC
Input: 120V
Rated Life: 50,000 hours

- Monopoint, 3-head, or 4-head fixed rails
- Sizes: 5" (Monopoint), 24", 36"
- Construction: Die-cast aluminum with frosted TIR lens
- Installation: Wall and Ceiling
- 350° horizontal and 90° vertical aiming per head
- 5 Year Warranty

System	Model	Lights	Beam	Lumens	CBCP	Color Temp	CRI	Finish	
TK	1805	01	45°	800/head	1095/head	30	3000K	90	BK
		03							BN
		04							WT
									Black
									Brushed Nickel
									White

Example: **TK-180503-30-BK**

LOW VOLTAGE LED/MR16 FLEXIBLE SPOT LIGHTS

Power: 7W
Lumens: 450
CBCP: 929
Comparable: 35W MR16

Color Temp: 3000K
CRI: 90
Dimming: ELV
Rated Life: 25,000 hours

- Integral Electronic transformer
- Accepts 12V LED MR16, Halogen MR16 lamps up to 50W max
- LED MR16 included when ordered as LED
- 1 watt minimum load
- Can be wall or ceiling mounted
- Available extensions from 6 to 48 inches
- Clear lens included (see below for alternate lens options)

826

Model	Lamp	Extension (optional)	Finish
ME-826LED	LED	X6 6"	BK Black
ME-826	Halogen	X12 12"	BN Brushed Nickel
		X18 18"	WT White
		X24 24"	
		X36 36"	
		X48 48"	

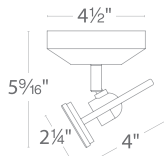

Example: **ME-826LED-BN** or **ME-826LED-X36-BN** (with 36" extension)



007

Model	Lamp	Extension (optional)	Finish
ME-007LED	LED	X6 6"	BK Black
ME-007	Halogen	X12 12"	BN Brushed Nickel
		X18 18"	WT White
		X24 24"	
		X36 36"	
		X48 48"	

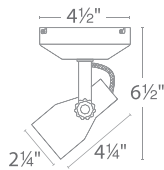

Example: **ME-007LED-BK** or **ME-007LED-X6-BK** (with 6" extension)



FRAMING PROJECTOR ACCESSORY

008FP	BK Black
	WT White

Example: **008FP-BK**



808

Model	Lamp	Extension (optional)	Finish
ME-808LED	LED	X6 6"	BK Black
ME-808	Halogen	X12 12"	WT White
		X18 18"	
		X24 24"	
		X36 36"	
		X48 48"	

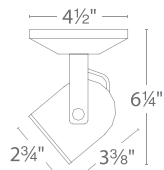

Example: **ME-808LED-WT** or **ME-808LED-X12-WT** (with 12" extension)



LAMPS

	Finish	Power	Color Temp	Input	Beam	CRI	Lumens	CBCP	Average Life
 MR16 MR16LED-BAB-BK MR16LED-BAB-WT	Black White	7W	3000K	12V	35°	90	450	929	25,000 Hours

LENS ACCESSORIES

Amber LENS-16-AMB	Blue Green LENS-16-BLU LENS-16-GRN	Red Frosted LENS-16-RED LENS-16-FR	UV Filter Spread LENS-16-UVF LENS-16-SPR	Beam Elongating Honeycomb Louver LENS-16-BEL LENS-16-HCL
--------------------------	--	--	--	--

BULLET 7010 LED TRACK



TITLE 24
CALIFORNIA



- Suitable for H, J or L track
- 350° horizontal and 90° vertical aiming
- Construction: Die-cast aluminum with frosted TIR lens
- Dimming: 100%-10% ELV, 100%-5% TRIAC
- Input: 120V
- Power: 10W
- Rated Life: 50,000 hours
- 5 Year Warranty

	System	Model	Beam	Lumens	CBCP	Color Temp	CRI	Finish
	H H Track	7010	45°	850	1078	30 3000K	90	BK Black BN Brushed Nickel DB Dark Bronze WT White
	L L Track J J/J2 Track	7010	45°	850	1078	30 3000K	90	BK Black WT White

Example: **H-7010-30-BN**

CHARGE 8010 & 8020 LED TRACK



TITLE 24
CALIFORNIA



H-8010/3-30-BN



H-8010-30-BK



H-8020-30-WT

- Suitable for H, J or L track
- 350° horizontal and 90° vertical aiming
- Driver concealed within fixture
- Construction: Die-cast aluminum with frosted TIR lens
- Dimming: 100%-10% ELV, 100%-5% TRIAC
- Input: 120V
- Power: 8010 (11W), 8020 (16W)
- Rated Life: 50,000 hours
- 5 Year Warranty

	System	Model	Beam	Lumens	CBCP	Color Temp	CRI	Finish
	H H Track L L Track J J/J2 Track	8020	45°	1280	1402	30 3000K	90	BK Black BN Brushed Nickel DB Dark Bronze WT White
	H H Track	8010	45°	850	1196	30 3000K	90	BK Black BN Brushed Nickel DB Dark Bronze WT White
	L L Track J J/J2 Track	8010	45°	850	1196	30 3000K	90	BK Black WT White
<p>Track Pack includes</p> <ul style="list-style-type: none"> • 4ft H Track • Floating Canopy • Three 8010 Charge Track Heads 	H H Track	8010/3	45°	850 x3	1196 x3	30 3000K	90	BK Black BN Brushed Nickel DB Dark Bronze WT White

Example: **H-8010-30-DB**

MR16 TRACK LUMINAIRES LED AND HALOGEN
1 WATT MINIMUM LOAD

802

System	Model	Lamp	Finish
HHT H	802LED	MR16 LED 12V 7W Included	BK Black
LHT L	802	MR16 12V 50W max (Sold Separately)	BN Brushed Nickel
JHT J/J2	802L	MR16 12V 75W max (Sold Separately)	WT White

Example: **LHT-802-BK**

Clear lens included

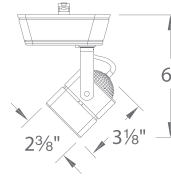

809

System	Model	Lamp	Finish
HHT H	809LED	MR16 LED 12V 7W Included	BK Black
LHT L	809	MR16 12V 50W max (Sold Separately)	BN Brushed Nickel
JHT J/J2	809L	MR16 12V 75W max (Sold Separately)	WT White

Example: **HHT-809-BN**

Clear lens included

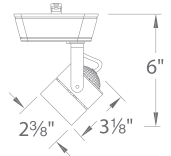

180

System	Model	Lamp	Finish
HHT H	180LED	MR16 LED 12V 7W Included	BK Black
LHT L	180	MR16 12V 50W max (Sold Separately)	BN Brushed Nickel
JHT J/J2	180L	MR16 12V 75W max (Sold Separately)	WT White

Example: **LHT-180-BN**

Clear lens included

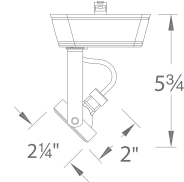

160

System	Model	Lamp	Finish
HHT H	160LED	MR16 LED 12V 7W Included	BK Black
LHT L	160	MR16 12V 50W max (Sold Separately)	WT White
JHT J/J2	160L	MR16 12V 75W max (Sold Separately)	

Example: **HHT-160LED-WT**

Clear lens included

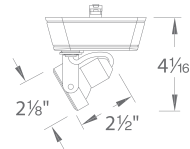

LENS ACCESSORIES

Amber **LENS-16-AMB**

Blue Green **LENS-16-BLU**
LENS-16-GRN

Red Frosted **LENS-16-RED**
LENS-16-FR

UV Filter Spread **LENS-16-UVF**
LENS-16-SPR

Beam Elongating Honeycomb Louver **LENS-16-BEL**
LENS-16-HCL

MR16 TRACK LUMINAIRES LED AND HALOGEN

1 WATT MINIMUM LOAD

007

Framing Projector Accessory  **008FP-BK** Black
008FP-WT White

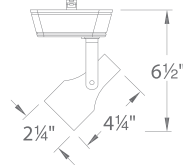

System	Model	Lamp	Finish
HHT H	007LED	MR16 LED 12V 7W Included	
LHT L	007	MR16 12V 50W max (Sold Separately)	BK Black
JHT J/J2	007L	MR16 12V 75W max (Sold Separately)	WT White

Example: **JHT-007-BN**

Clear lens included

Available in monopoint

808

System	Model	Lamp	Finish
HHT H	808LED	MR16 LED 12V 7W Included	
LHT L	808	MR16 12V 50W max (Sold Separately)	BK Black DB Dark Bronze
JHT J/J2	808L	MR16 12V 75W max (Sold Separately)	WT White

Example: **JHT-808LED-BK**

Clear lens included

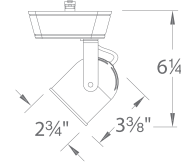

Available in monopoint 

DUNE

System	Model	Lamp	Finish
HHT H	826LED	MR16 LED 12V 7W Included	
LHT L	826	MR16 12V 50W max (Sold Separately)	BK Black BN Brushed Nickel
JHT J/J2	826L	MR16 12V 75W max (Sold Separately)	WT White

Example: **HHT-826-BN**

Clear lens included

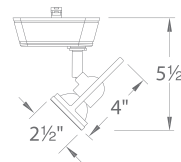

LED LAMPS

		Finish	Power	Color Temp	Input	Beam	CRI	Lumens	CBCP	Average Life
	MR16	MR16LED-BAB-BK MR16LED-BAB-WT	7W	3000K	12V	35°	90	450	850	25,000 Hours

GU10 TRACK LUMINAIRES LED AND HALOGEN

103

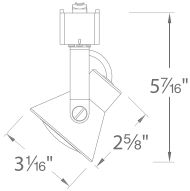

System	Model	Lamp	Finish
HTK H	103LED	GU10 LED 7W included	BK Black
LTK L			DB Dark Bronze
JTK J/J2			WT White

Example: **LTK-103LED-BK**

104

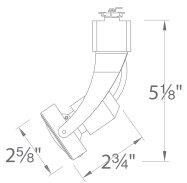

System	Model	Lamp	Finish
HTK H	104LED	GU10 LED 7W included	BK Black
LTK L			WT White
JTK J/J2			

Example: **LTK-104LED-WT**

LED LAMPS

	Model	Finish	Power	Color Temp	Input	Beam	CRI	Lumens	CBCP	Average Life
	GU10	GU10LED-BAB-BK GU10LED-BAB-WT	7W	3000K	12V	35°	90	470	850	25,000 Hours

PAR AND BR TRACK LUMINAIRES LED AND HALOGEN

725

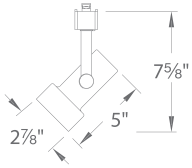

System	Model	Lamp	Finish
HTK H	725	PAR20 / BR20 50W max	BK Black
LTK L			WT White
JTK J/J2			

Example: **HTK-725-WT**

Order lamp separately



Shown **HTK-725-WT**
with **PAR20 50W Halogen** lamp

720, 730, 738

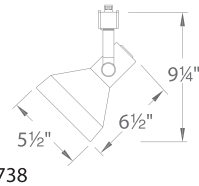
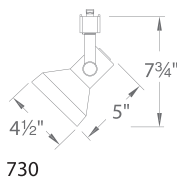
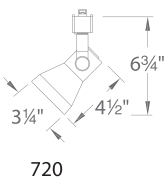

System	Model	Lamp	Finish
HTK H	720	PAR20 50W max	BK Black WT White
LTK L	730	PAR30 75W max	
JTK J/J2	738	PAR38 100W max	

Example: **HTK-730-BK**

Order lamp separately



Shown **HTK-738-BK**
with **PAR38 90W Halogen** lamp

PAR AND BR TRACK LUMINAIRES LED AND HALOGEN

178 UNIVERSAL MEDIUM BASE



Shown with **PAR20LED-10N30-BK** LED lamp

System	Model	Lamp	Finish
HTK H	178	BR20/30/40, PAR20/30/38 120V 100W Max	BK Black
LTK L			BN Brushed Nickel
JTK J/J2			WT White

Example: **LTK-178-BN** Order lamp separately

Barn Door (order separately)

PAR20BD	BK Black	
PAR30BD	BN Brushed Nickel	
PAR38BD	WT White	

188 ADJUSTABLE UNIVERSAL MEDIUM BASE



Shown with **PAR30LED-L14N30-WT** LED lamp

System	Model	Lamp	Finish
HTK H	188	BR20/30/40, PAR20/30/40 120V 100W Max	BK Black
LTK L			WT White
JTK J/J2			

Example: **HTK-188-WT** Order lamp separately

Barn Door (order separately)

PAR20BD	BK Black	
PAR38BD	WT White	

PAR AND BR TRACK LUMINAIRES LED AND HALOGEN

704

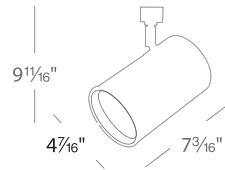

System	Model	Lamp	Finish
HTK H	704	120V BR30 and PAR30 75W Max	BK Black WT White
LTK L			
JTK J/J2			

Example: **LTK-704-WT**

Order lamp separately

703

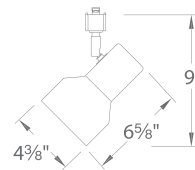

System	Model	Lamp	Finish
HTK H	703	BR30 and PAR30 75W Max	BK Black WT White
LTK L			
JTK J/J2			

Example: **HTK-703-BK**

Order lamp separately

763, 764, 765



763



764



765

System	Model	Lamp	Finish
HTK H	763	LED BR20 7.5W, LED PAR20 10.3W	BK Black BN Brushed Nickel WT White
LTK L	764	LED BR30 14W, LED PAR30 14.6W	
JTK J/J2	765	LED BR40 17W, LED PAR38 17.8W	

Example: **HTK-763-WT**

Order lamp separately

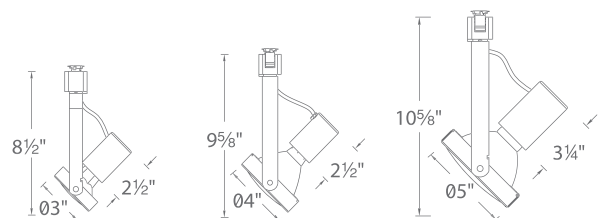

763

764

765

H TRACK CURRENT LIMITER

WAC Track Current Limiters are designed to address energy allowances.

WITHOUT A CURRENT LIMITER

Wattage towards energy allowance

ASHRAE 90.1 AND IECC

The greater of either:

- The sum of the maximum rated wattage of the luminaires OR
- 30 watts per linear ft of track circuit

CALIFORNIA'S TITLE 24

The greater of either:

- The sum of the maximum rated wattage of the luminaires OR
- 45 watts per linear ft of track circuit

WITH A CURRENT LIMITER

Wattage towards energy allowance







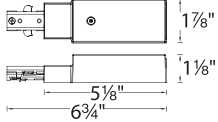

ASHRAE 90.1 AND IECC

Wattage rating of the current limiter

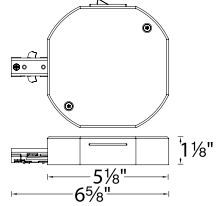
CALIFORNIA'S TITLE 24

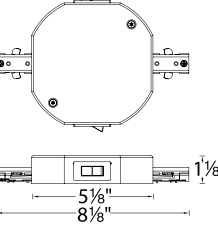

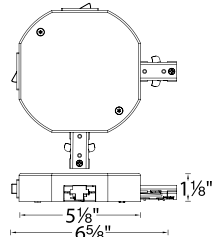

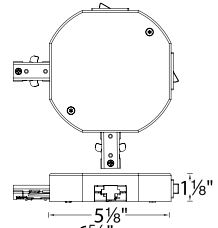
The greater of either:

- Wattage rating of the current limiter OR
- 12.5 watts per linear foot of track circuit

	Model	Circuit Breaker	Max Wattage	Finish	
 <p><i>Slim Single Live End</i></p> 	THL-HLES				
 <p><i>Single Live End</i></p> 	THL-HLE				
 <p><i>Double Live End</i></p> 	THL-HI				
 <p><i>Double Live End (Left)</i></p> 	THL-LEFT				
 <p><i>Double Live End (Right)</i></p> 	THL-RIGHT				
		1/2A	0.5A	60W	BK Black BN Brushed Nickel WT White
		1A	1.0A	120W	
		2A	2.5A	300W	
		5A	5.0A	600W	
		7A	7.5A	900W	
		10A	10.0A	1200W	
		1-1/2A	0.5A	60W	
		2-1/2A	0.5A per end	60W per end	
		1-1A	1.0A	120W	
		2-1A	1.0A per end	120W per end	
		1-2A	2.5A	300W	
		2-2A	2.5A per end	300W per end	
		1-5A	5.0A	600W	
		2-5A	5.0A per end	600W per end	
		1-7A	7.5A	900W	
		2-7A	7.5A per end	900W per end	
		1-10A	10.0A	1200W	
		2-10A	10.0A per end	1200W per end	

Example: **THL-LEFT-1-1/2A-WT**

LED LAMPS*

	Model	Finish	Lamp Type	Power	CCT	Lumens	Average Life	CRI	Ø	L
	JCLEd-2-30-WT	White	JC Bi-pin G5.3 base	12V 2W	3000K	110	25,000 hrs	85	3/4"	2 3/16"
	MR16LED-BAB-BK MR16LED-BAB-WT	Black White	MR16 G5.3 base 35° beam	12V 8W	3000K	450	25,000 hrs	90	2"	1 5/16"
	GU10LED-BAB-BK GU10LED-BAB-WT	Black White	GU10 35° beam	120V 8W	3000K	470	25,000 hrs	90	2"	5 1/16"
	BR40LED-15N27-WT	White	BR40 med base 100° beam	120V 15W	2700K	1050	25,000 hrs	90	4 3/4"	5 13/16"
	A19LED-12-30-WT	White	A19 med base 300° beam	120V 9.5W	3000K	800	25,000 hrs	90	2 3/8"	4 1/3"

H TRACK SYSTEM

Description: Single circuit H-Track
Power per Circuit: 120V, 1920W max
Operating Current: Rated 20A max



TRACK SECTIONS

Model	Length	Finish	Description
HT H Track	2 2'	BK Black	120V 3-wire track
	4 4'	BN Brushed Nickel	
	6 6'	WT White	
	8 8'	DB Dark Bronze	

Example: **HT6-BK**

Each section includes two matching end caps.

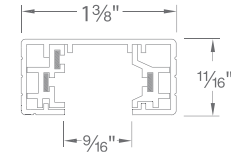















QUICK CONNECT ADAPTER

Quick Connect Adapter		EN-HQ50AR H Track	BK Black BN Brushed Nickel WT White DB Dark Bronze	Use to easily connect any Quick Connect pendant or fixture. Min.Load: 1W Max Load: 50W
-----------------------	--	--------------------------	---	--

TRACK SUSPENSION





All Track Suspension Kit		SK	18 18" 24 24" 36 36" 48 48"	BK Black BN Brushed Nickel WT White DB Dark Bronze	Extends track from ceiling. Includes track bracket, rod and ceiling canopy.	
Suspension Kit Extender		R	18 18" 24 24" 36 36" 48 48" 72 72"	BK Black BN Brushed Nickel WT White DB Dark Bronze	Use with Rod Coupler (RI) to further extend track from ceiling.	
Sloped Ceiling Adapter		SK14		BK Black BN Brushed Nickel WT White DB Dark Bronze	Use with suspension kits to accommodate sloped ceilings. Max capacity: 7A, 800W, 120V	
Rod Coupler		RI		BK Black BN Brushed Nickel WT White DB Dark Bronze	Join two rods for suspensions longer than 48".	
Suspension Adjustment Collar kit		SK05	Includes two collars		BK Black BN Brushed Nickel WT White DB Dark Bronze	Used when suspension rod is field cut to custom lengths. One kit of two required for each rod.
Low Voltage Track Head Extension		X	6 6" 12 12" 18 18" 24 24" 36 36" 48 48"	BK Black BN Brushed Nickel WT White DB Dark Bronze	Extends low voltage track heads from track. Specify extension, fixture and finish. Only available as complete unit. Custom order Example: X18-HHT-809-WT	
Line Voltage Track Head Extension (H track only)		H	18 18" 24 24" 36 36" 48 48"	BK Black BN Brushed Nickel WT White DB Dark Bronze	Extends H System line voltage track heads.	
Wall Mount Suspension Bracket		TBKT	18"	BK Black BN Brushed Nickel WT White DB Dark Bronze	Extends track 24" from wall. Use two per 4' length, three per 8' length.	

Example: **SK24-BK**



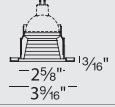

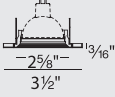

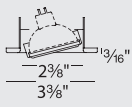



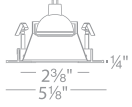

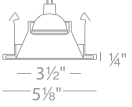

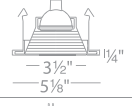
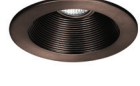
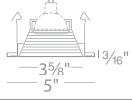
ACCESSORIES	Model	Finish	Description	
Live End Connector	 HLE	BK Black BN Brushed Nickel WT White DB Dark Bronze	4 1/4" x 1 3/8" x 3/4" Use for direct wiring through ceiling. A canopy plate is required when using with a standard junction box.	
Live End BX Connector	 HBXLE	BK Black BN Brushed Nickel WT White DB Dark Bronze	6" x 1 3/8" x 1 1/4" Use with surface mounted BX or non-metallic sheathed cable. Also provides through the ceiling connection.	
"I" Power Connector	 HI-PWR	BK Black BN Brushed Nickel WT White DB Dark Bronze	6 3/4" x 1 3/8" x 3/4" Power entry point at the connection of 2 tracks.	
"L" Connector Left		HL-LEFT	BK Black BN Brushed Nickel WT White DB Dark Bronze	2 3/4" x 2 3/4" x 3/4" Use to join 2 track sections to make power feedable 90° left polarity turns.
"L" Connector Right		HL-RIGHT	BK Black BN Brushed Nickel WT White DB Dark Bronze	2 3/4" x 2 3/4" x 3/4" Use to join 2 track sections to make power feedable 90° right polarity turns.
"T" Connector	 HT	BK Black BN Brushed Nickel WT White DB Dark Bronze	4" x 2 3/4" x 3/4" Use to join 3 track sections. "T" Connector with opposite polarity can be custom ordered.	
"X" Connector	 HX	BK Black BN Brushed Nickel WT White DB Dark Bronze	4 1/8" x 4 1/8" x 3/4" Use to join 4 track sections.	
"I" Connector	 HI	BK Black BN Brushed Nickel WT White DB Dark Bronze	3" x 1 3/8" x 3/4" Use to join two sections of track with electrical continuity.	
"I" Dead End Connector	 HI-DEC	BK Black BN Brushed Nickel WT White DB Dark Bronze	3" x 1 3/8" x 3/4" Joins two sections of track without electrical continuity.	
Flexible Track Connector	 HFLX	BK Black BN Brushed Nickel WT White DB Dark Bronze	9 3/4" x 1 3/8" x 3/4" Connects two track sections at variable angles. Use as a transition from wall-to-wall, wall-to-ceiling, or ceiling-to-ceiling. Power feedable.	
Suspension Loop	 H-LOOP	BK Black BN Brushed Nickel WT White DB Dark Bronze	1 3/8" x 1 3/8" x 3" 3 inch electrical loop accepts chain hung fixtures up to 35lbs. Contains compartment for electrical connections.	
15' Cord, Male Plug	 HCORD use with H and J	BK Black WT White	15' Maximum capacity: 7A, 800W, 120V.	
T-Bar Drop Ceiling Attachment	 T-BARCLIP	Chrome	1 1/2" x 1 1/4" Attaches track to T-bar drop ceilings. Use two for 2 foot or 4 foot tracks, three for 6 foot or 8 foot tracks.	
Monopoint Canopy Adapter	 HMP	BK Black BN Brushed Nickel WT White DB Dark Bronze	5 3/8" x 5 3/8" Mount a single track fixture to a junction box. When used with a low voltage track head the transformer box will protrude off of the face of the monopoint.	
Canopy Plate	 CP	BK Black BN Brushed Nickel WT White DB Dark Bronze	4 1/2" x 4 1/2" Covers a standard 4 inch junction box. Use with any powerable connectors.	
Floating Canopy Connector	 HFC	BK Black BN Brushed Nickel WT White DB Dark Bronze	4 1/2" x 4 1/2" x 1 1/2" Connects to octagon box. Allows track to be powered anywhere along the length of the track	

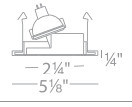
2.5" LOW VOLTAGE MR16

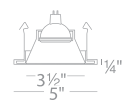
1WATT MINIMUM LOAD TRANSFORMERS 

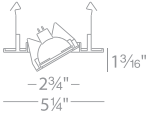
2.5" Trims (Order Housing Separately)		Model	Finish	Baffle/Trim
		HR-834 HR-834LED <i>Metal Trim Step Baffle</i>	WT/WT	<i>White/White</i>
		HR-836 HR-836LED <i>Metal Trim</i>	BN CB WT	<i>Brushed Nickel</i> <i>Copper Bronze</i> <i>White</i>
		HR-837 HR-837LED <i>Gimbal Ring,</i> <i>25° Adjustment from Vertical</i>	BK BN CB WT	<i>Black</i> <i>Brushed Nickel</i> <i>Copper Bronze</i> <i>White</i>

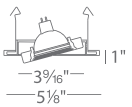
4" LOW VOLTAGE MR16

4" Downlight Trims (Order Housing Separately)		Model	Finish	Reflector/Trim
		HR-D412-S HR-D412LED-S <i>Square Open Reflector</i>	SC/BN SC/WT	<i>Specular/Brushed Nickel</i> <i>Specular/White</i>
		HR-D412 HR-D412LED <i>Round Open Reflector</i>		<i>35° Adjustment from Vertical,</i> <i>MR16, 50W max</i>
		HR-D411 HR-D411LED <i>Step Baffle</i>	WT/WT	<i>White Baffle/White</i> <i>MR16, 50W max</i>
		HR-8411 HR-8411LED <i>Step Baffle</i>	WT/WT	<i>White Baffle/White</i> <i>MR16, 50W max</i>
		HR-D413 HR-D413LED <i>Slot Trim</i>	WT	<i>White</i> <i>MR16, 50W max</i>
		HR-D418-S HR-D418LED-S <i>Shower Light Clear Flat Lens</i>	WT	<i>White</i> <i>35° Adjustment from Vertical</i> <i>Wet Location Listed,</i> <i>MR16, 50W max</i>
		HR-D416 HR-D416LED <i>Directional Spot</i>	BN WT	<i>Brushed Nickel</i> <i>White</i> <i>30° Adjustment from Vertical</i> <i>MR16, 50W max</i>
		HR-D417 HR-D417LED <i>Gimbal Ring</i>		<i>25° Adjustment from Vertical</i> <i>MR16, 50W max</i>
		HR-D425 HR-D425LED <i>Directional Spot</i>	WT	<i>White</i> <i>80° Adjustment from Vertical</i> <i>MR16, 50W max</i>

2.5" Housings (Required)

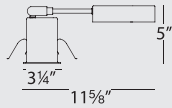

Model
HR-801
Electronic Non-IC Remodel
12V/120V 50W max

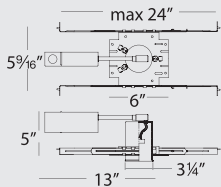

Model
HR-802
Electronic Non-IC New Construction
12V/120V 50W max

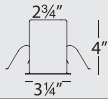

Model
HR-800*
For Cabinet Use
12V/24V,
Non-IC 35W max

*Remote Electronic Class 2 Transformer Required (Sold Separately)

- 1 Watt Minimum Load Transformers
- Non-IC housings require 3" of clearance from insulation on all sides.
- Accommodates ceiling thickness of up to 3/4" for both remodel or new construction.

For Use with HR-800 Housing

1 Watt Minimum Class 2 Enclosed Electronic Transformers

Model	Output	L	W	H
EN-1260-RB2	12V, 1 x 60W	6 5/8"	1 5/8"	1 1/8"
EN-12120-RB2	12V, 2 x 60W	6"	3 1/4"	2 5/8"
EN-12180-RB2	12V, 3 x 60W	6 3/4"	3 5/8"	2 5/8"
EN-12300-RB2	12V, 5 x 60W	8 1/2"	4 5/8"	2 5/8"
EN-2460-RB2	24V, 60W	6 1/2"	1 5/8"	1 1/4"
EN-24100-RB2	24V, 96W	6 1/2"	1 5/8"	1 1/4"

Accommodates Most LED MR16 or Halogen MR16 Lamps

- Die-cast aluminum construction
- Steel spring clips secure trim to housing
- Abrasion resistant powder coat paint or plated metal finish

4" Low Voltage Housings (Required)

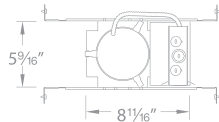
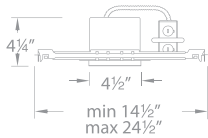

Model **HR-8402E** **Voltage** 120V **Transformer** Electronic **Output** 12V, 50W max
1W min **Type** New Construction Non-IC

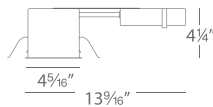

Model **HR-8401E** **Voltage** 120V **Transformer** Electronic **Output** 12V, 50W max
1W min **Type** Remodel Non-IC



Non-IC housings require 3" of clearance from insulation on all sides.
Accommodates ceiling thickness of up to 3/4" for remodel & 3/4" for new construction.

*Not Compatible with HR-D418 or HR-D418-S

LOW VOLTAGE MR16 MULTIPLE SPOTS



1WATT MINIMUM LOAD TRANSFORMERS

Trims (Order Housing Separately)		Model	Finish	Trim/Reflector
1 LIGHT		1 Light Trim MT-116 Halogen MR16 sold separately MT-116LED LED MR16 Included	WT/WT	White/White
		1 Light Invisible Trim™ MT-116TL Halogen MR16 sold separately MT-116LEDTL LED MR16 Included	WT	White

Example: **MT-116-WT/WT**

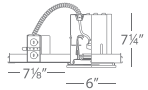
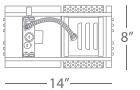
Low Voltage Multiple Spot Housings (Required)		Model	Type	Wattage	Rating
		MT-116HS	1 Light	12V 50W MAX	Non-IC

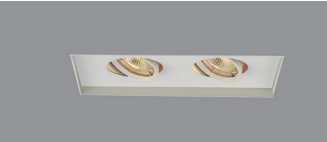
Trims (Order Housing Separately)		Model	Finish	Trim/Reflector
2 LIGHTS		2 Light Trim MT-216 Halogen MR16 sold separately MT-216LED LED MR16 Included	WT/WT	White/White
		2 Light Invisible Trim™ MT-216TL Halogen MR16 sold separately MT-216LEDTL LED MR16 Included	WT	White

Example: **MT-216TL-WT**

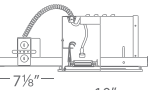
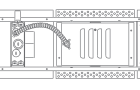
Low Voltage Multiple Spot Housings (Required)		Model	Type	Lamp	Rating
		MT-216HS	2 Lights	12V 50W MAX	Non-IC

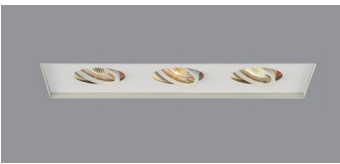
Trims (Order Housing Separately)		Model	Finish	Trim/Reflector
3 LIGHTS		3 Light Trim MT-316 Halogen MR16 sold separately MT-316LED LED MR16 Included	WT/WT	White/White
		3 Light Invisible Trim™ MT-316TL Halogen MR16 sold separately MT-316LEDTL LED MR16 Included	WT	White

Example: **MT-316-WT/WT**

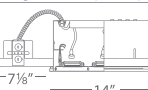
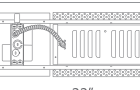
Low Voltage Multiple Spot Housings (Required)		Model	Type	Lamp	Rating
		MT-316HS	3 Lights	12V 50W MAX	Non-IC

Non-IC housings require 3" of clearance from insulation on all sides. Recommended ELV dimming

Accommodates ceiling thickness of up to 1" for remodel & 3/4" for new construction.

LENSES, LOUVERS & LAMPS

Colored Lenses	Color
LENS-16 Colored Lens	AMB Amber
	BLU Blue
	GRN Green
	RED Red

Lenses & Louvers	
LENS-16-UVF UV Filter Lens	LENS-16-SPR Spread Lens
LENS-16-FR Frosted Lens	LENS-16-BEL Beam Elongating Lens
LENS-16-HCL Honeycomb Louver	

LED MR16 Lamp	Finish
MR16LED-BAB	BK Black
	WT White

INDEX

2.5" LOW VOLTAGE MR16	56-57
4" LOW VOLTAGE MR16	56-57
120V/277V RECTANGULAR STEP & WALL LIGHTS	40-41
ATLANTIS LED FAN	6-7
BARLIGHT UNDERCABINET LIGHTING	14-15
BASICS TAPE	9-11
BLAZE 6"	23
BLO 2	29
BULLET	44
CHARGE	45
CUBIX OUTDOOR SCONCE	38
CYLINDER OUTDOOR SCONCE	38
DISC	27
DISC II LED FAN	4-5
FLO	29
LOTOS 2" MULTIPLES	18
FUSE	36
GEMINI TAPE	8-11
GLO	29
GU10 TRACK LUMINAIRES	48
H TRACK CURRENT LIMITER	52
H TRACK SYSTEM	54-55
I CAN'T BELIEVE IT'S NOT RECESSED	26
ION 2"	21
LED LAMPS	53
LINK	37
LITHIUM EM BATTERY BACKUP	24-25
LOTOS 4" & 6" ADJUSTABLE	16-17
LOTOS 4" & 6" DOWNLIGHT	19
LOW VOLTAGE MR16 MULTIPLE SPOTS	58
METRO	34-35
MR16 TRACK LUMINAIRES	46-47
PAR AND BR TRACK LUMINAIRES LED AND HALOGEN	49-51
POP-IN 4"	22
PUCK LIGHT	12-13
ROUND & SQUARE	30-31
SOLO	42
TURBO	32-33
VEGA OUTDOOR SCONCE	39

Headquarters

Tel: 800.526.2588
Fax: 800.526.2585

West Coast Factory

1750 S Archibald Ave
Ontario, CA 91761

East Coast Factory

44 Harbor Park Dr
Port Washington, NY 11050

Central Factory

1600 Distribution Ct
Lithia Springs, GA 30122

Consult the factory to take advantage of our custom capabilities in large quantities. For up to date product specifications and assistance please visit **waclighting.com** or call **1-800-526-2588**

Copyright © 2022 by WAC Lighting.

All rights reserved. This catalog is copyrighted and WAC Lighting will use all measures available to it under the law against anyone who copies or derives from its copyrighted work. WAC Lighting retains the right to modify the design of our products at any time as part of the company's continuous improvement program.



WAC LIMITED