

2023



WAC LIMITED







WAC LIMITED

Maximize desirability and minimize expenses with WAC LIMITED products designed to accommodate single-family or multi-family residential, apartment living, and large-scale hospitality projects.

A well-lit space elevates the perceived value of all finishes used and increases functionality of spaces while also minimizing maintenance and energy expenses. Dollar for dollar, quality lighting improves occupant experiences more than any other construction material. Our wide array of products covers kitchens, baths, bedrooms, closets, hallways, living rooms, laundry rooms and garages—all designed for safety and proven to last.

We also understand that installation costs are a major part of the value equation. As such, WAC LIMITED luminaries are engineered to reduce these costs. Premium lighting products and designs for residential and hospitality applications can be found in the WAC Lighting and dweLED product lines.

WAC LIMITED

DISC II LED FAN



F-033L-BN



An energy efficient ceiling fan with a quiet DC motor and LED luminaire make Disc II 70% more efficient than conventional fans.

DISC II LED FAN



A streamlined look suited for bedrooms and living rooms. The sweep of the 52" blades efficiently creates a cooling effect and complements the silent DC motor.

- Blade:** 12° pitch, 52" sweep, plywood
- Downrod:** 3/4" W x 4 1/2" H included
- Mounting Slope:** Up to 30° standard, 45° with optional Slope Ceiling Kit
- Lead Wire:** 80"
- Hanging Weight:** 18 lbs
- Lumens/Delivered Lumens:** 2100/1410
- Total Power:** 51W
- LED Power:** 25W
- CRI:** 90
- Color Temperature:** 3000K
- LED Rated Life:** 50,000 hrs
- LED Dimming:** 100%-10% ELV/TRIAC
(Refer to online product page for dimming compatibility)

- 3-speed 120 x 15 DC motor for quiet and powerful operation
- Precision balanced blades for wobble-free operation
- Pull-chain operated and reversible from housing
- Fan and LED module are Energy Star® certified
- Memory module—fan will recall last speed setting if switched off
- Damp rated

Model	Housing	Blade
F-033L	BN Brushed Nickel	Titanium Silver
	MB Matte Black	Matte Black
	MW Matte White	Matte White

Example: **F-033L-BN**

ENERGY GUIDE		
Standard	High Speed	Weighted Average
Electricity	25W	17W
Airflow	5,032 CFM	3,964 CFM
Energy Costs*	-	\$5/yr
Efficiency	237 CFM/W	237 CFM/W

*Estimated annual energy cost based on \$0.12 per kWh and 6.4 hours use per day

ACCESSORIES sold separately

DC-I Coupler	BN Brushed Nickel				
	MB Matte Black				
	MW Matte White				
SC- Slope Ceiling Kit	BN Brushed Nickel				
	MB Matte Black				
	MW Matte White				
DR- Downrods	12"				
	18"				
	24"				
	36"				
	48"				
	60"				
72"					
BN Brushed Nickel	MB Matte Black	MW Matte White			
			BN Brushed Nickel	MB Matte Black	MW Matte White

ATLANTIS LED FAN



ATLANTIS offers a Damp rated, high-value fan with three speed options and can be reversed from the housing. Enhance your interiors with the gently-curved shape of this elegant fan.

- Blade:** 13° pitch, 52" sweep, plywood
- Downrod:** 3/4" W x 6" H included
- Mounting Slope:** Up to 30° standard,
45° with optional Slope Ceiling Kit
- Lead Wire:** 80"
- Hanging Weight:** 18 lbs
- Lumens/Delivered Lumens:** 1600/708
- Total Power:** 83W
- LED Power:** 19.5W
- CRI:** 90
- Color Temperature:** 3000K
- LED Rated Life:** 50,000 hrs
- LED Dimming:** 100%-10% ELV/TRIAC
(Refer to online product page for dimming compatibility)

- 3 fan speeds
- Silent 153 x 16 AC motor
- Pull chain operation
- Fan is reversible from housing

Model	Housing	Blade
F-072L	BN Brushed Nickel	Titanium Silver
	MB Matte Black	Matte Black
	MW Matte White	Matte White

Example: **F-072L-MB**

ENERGY GUIDE		
Standard	High Speed	Weighted Average
Electricity	63W	40W
Airflow	5,001 CFM	3,717 CFM
Energy Costs*	-	\$11/yr
Efficiency	92 CFM/W	92 CFM/W

*Estimated annual energy cost based on \$0.12 per kWh and 6.4 hours use per day

ACCESSORIES sold separately

DC-I Coupler	BN Brushed Nickel
	MB Matte Black
	MW Matte White
SC- Slope Ceiling Kit	BN Brushed Nickel
	MB Matte Black
	MW Matte White
DR- Downrods	12"
	18"
	24"
	36"
	48"
	60"
	72"

ATLANTIS FLUSH FLUSH MOUNT LED FAN

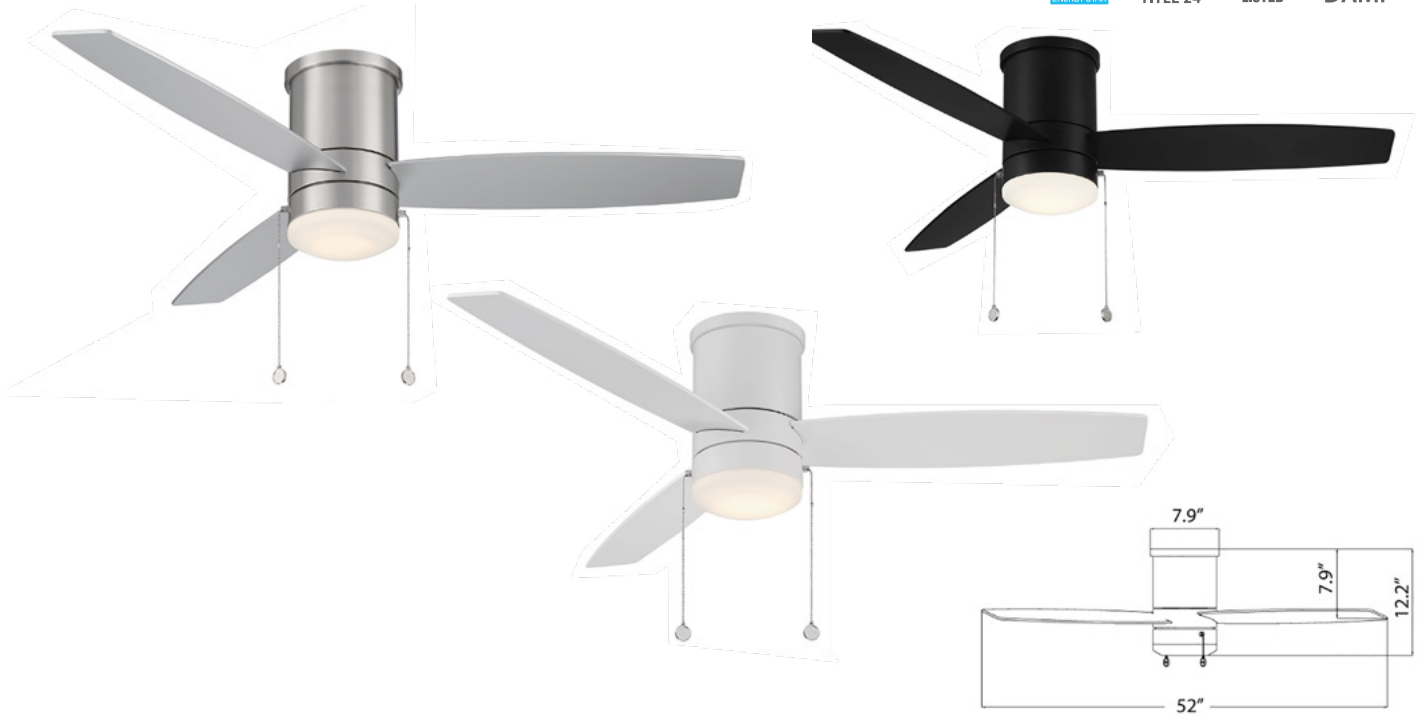

ATLANTIS FLUSH offers a Damp rated, high-value fan with three speed options and can be reversed from the housing. Enhance your interiors with the gently-curved shape of this elegant fan.

- Blade: 13° pitch, 52" sweep, plywood
- Lead Wire: 8"
- Hanging Weight: 18 lbs
- Lumens/Delivered Lumens: 1600/708
- Total Power: 83W
- LED Power: 19.5W
- CRI: 90
- Color Temperature: 3000K
- LED Rated Life: 50,000 hrs
- LED Dimming: 100%-10% ELV/TRIAC
(Refer to online product page for dimming compatibility)

- 3 fan speeds
- Silent 153 x 16 AC motor
- Pull chain operation
- Fan is reversible from housing

Model	Housing	Blade
F-073L	BN <i>Brushed Nickel</i>	<i>Titanium Silver</i>
	MB <i>Matte Black</i>	<i>Matte Black</i>
	MW <i>Matte White</i>	<i>Matte White</i>

Example: **F-073L-MB**

ENERGY GUIDE		
Standard	High Speed	Weighted Average
Electricity	63W	40W
Airflow	4,116 CFM	3,046 CFM
Energy Costs*	-	\$11/yr
Efficiency	75 CFM/W	75 CFM/W

*Estimated annual energy cost based on \$0.12 per kWh and 6.4 hours use per day



Cut and securely reconnect with ease



Input: 24VDC
 Lumens: Up to 300 lm/ft
 Rated Life: 50,000 hours

- Cut and re-connectable with secure screw terminal accessories
- May be cut every 2 inches
- Uniform illumination
- Seamless line of light

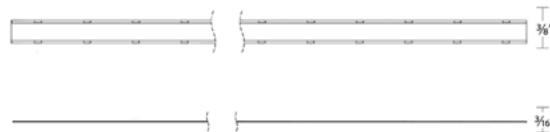

System	Lumens	Max Run	Wattage	Length	Length Description	Color Temp	CRI	Finish
T24-GE1	100+ lm/ft	40ft (60W), 40 ft (96W)	1.2W/ft	15	15 ft spool (incl. 2 pcs Tape to Tape Connector)	27 2700K	90	WT White
T24-GE2	200+ lm/ft	24ft (60W), 30ft (96W)	2.2W/ft	24	24 ft spool (incl. 4 pcs Tape to Tape Connector)	30 3000K		
T24-GE3	300+ lm/ft	15ft (60W), 24ft (96W)	3.9W/ft	100	100 ft spool (incl. 10 pcs Tape to Tape Connector)	35 3500K		
						40 4000K		

Example: **T24-GE3-15-27WT**

POWER SUPPLY (REQUIRED)



- ELV Dimming 100%-10%
- 6ft Output lead wires



- TRIAC, ELV Dimming 100%-1%
- Universal Input, ≤ 0.9 pf
- Overload and short circuit protection

Model	Dimension	Input	Output	Dimming
EN-BT60-24	6½" x 2⅛" x 1¼"	120V	24VDC 60W	ELV
EN-BT96-24	6½" x 2⅛" x 1¼"	120V	24VDC 96W	ELV
PS-24DC-U60R-BT	8⅜" x 2⅛" x 1¼"	120V-277V	24VDC 60W	ELV/TRIAC
PS-24DC-U96R-BT	8⅜" x 2⅛" x 1¼"	120V-277V	24VDC 96W	ELV/TRIAC

ACCESSORIES FOR GEMINI TAPE

	Type	Model	Finish
	Tape to Tape Connector <i>Connects tape sections (10 pieces per pack)</i>	T24-BS-MM	
	Power to Tape Connector <i>Connects tape sections (10 pieces per pack)</i>	T24-BS-PM	CL Clear
	L Connector <i>Connects tape sections (2 pieces per pack)</i>	T24-BS-L	
	Flex Y Connector <i>Connects tape sections and power feed Includes LED-T-B (1pc)</i>	T24-BS-Y	BK Black WT White
	Flex X Connector <i>Connects tape sections and power feed Includes LED-T-B (1pc)</i>	T24-BS-X	
	Low Voltage Wiring Box <i>Neatly house connections for up to 2 wires</i>	LED-T-B	White

Example: **T24-BS-MM-CL**

	Type	Model	Finish
	Joiner Cable <i>Extend distance between tape sections</i>	T24-BS-IC-002 T24-BS-IC-006 T24-BS-IC-012 T24-BS-IC-036 T24-BS-IC-072	2 in 6 in 1 ft 3 ft 6 ft BK Black WT White
	Extension Cable <i>Extends distance between tape sections and power supply (Includes LED-T-B (1 pc) & screw driver)</i>	T24-BS-EX2-072 T24-BS-EX2-144 T24-BS-EX2-240 T24-BS-EX2-480	6 ft 12 ft 20 ft 40 ft

Example: **T24-BS-EX2-240-WT**

	Model	Finish	Input/Output	L	W	H	Description
	IR-96-24VACDC-BK IR-96-24VACDC-WT	Black White	24V AC/DC 96W	1⅜"	¾"	⅜"	IR (Infrared) sensor switch works by turning the lights on when it becomes unobstructed. Can be surface mounted with bracket provided or double sided adhesive.



INDOOR ALUMINUM CHANNELS



Aluminum Channel **LED-T-CH** 5 feet
Additional End Caps **LED-T-CH-EC** 2 pcs

*Diffuses light from WAC tape
 Includes a diffuser, two end caps, and five screws*



Deep Aluminum Channel **LED-T-CH1** 5 feet
Additional End Caps **LED-T-CH1-EC** 2 pcs

*Eliminates visible hot spots
 Includes a diffuser, 2 end caps, and 5 screws*



45° Angled Aluminum Channel **LED-T-CH2** 5 feet
Additional End Caps **LED-T-CH2-EC** 2 pcs

Includes a diffuser, 2 end caps, and 5 screws



Fixed Angle Channel Clip **LED-T-CL3-PT**

Includes 2 pieces, 4 screws. Use to mount Aluminum Channel



Spot Optic - Deep Channel* **LED-T-CH3-SP** 5 feet
Additional End Caps **LED-T-CH1-EC** 2 pcs

*Eliminates visible hot spots
 Includes a diffuser, 2 end caps, and 5 screws*

**Spot 9° Beam Angle*



Flood Optic - Deep Channel* **LED-T-CH3-FL** 5 feet
Additional End Caps **LED-T-CH1-EC** 2 pcs

*Eliminates visible hot spots
 Includes a diffuser, 2 end caps, and 5 screws*

**Flood 54° Beam Angle*



Wide Flood Optic - Deep Channel* **LED-T-CH3-WF** 5 feet
Additional End Caps **LED-T-CH1-EC** 2 pcs

*Eliminates visible hot spots
 Includes a diffuser, 2 end caps, and 5 screws*

**Wide Flood 84° Beam Angle*



Adjustable Channel Clip **LED-T-CL2-PT**

*Includes 2 pieces, 4 screws. Used to mount Aluminum Channel.
 Adjust 50° from center either way*

INDOOR MOUNTING ACCESSORIES



Aluminum Retrofit Channel **LED-T-RC** 3 feet

Can be bent to create fixed curves or used as a glare shield

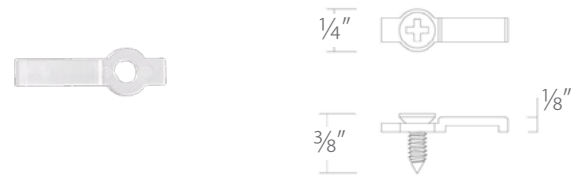

Plastic Mounting Clip **T24-BS-CL1** Clear

*For installation on non-flat surfaces
 Includes: 10 pcs plastic clips and 10 pcs screws*



50% OFF 100%



ROCKER SWITCH
ADJUSTS BETWEEN
50%, OFF, OR 100%

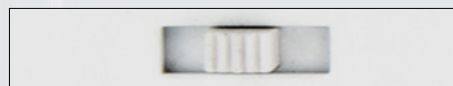

ALL-IN-ONE CCT SELECTABLE,
ADJUSTS BETWEEN
2700K, 3000K
OR 3500K

BARLIGHT UNDERCABINET LIGHTING



ALL-IN-ONE CCT SELECTABLE

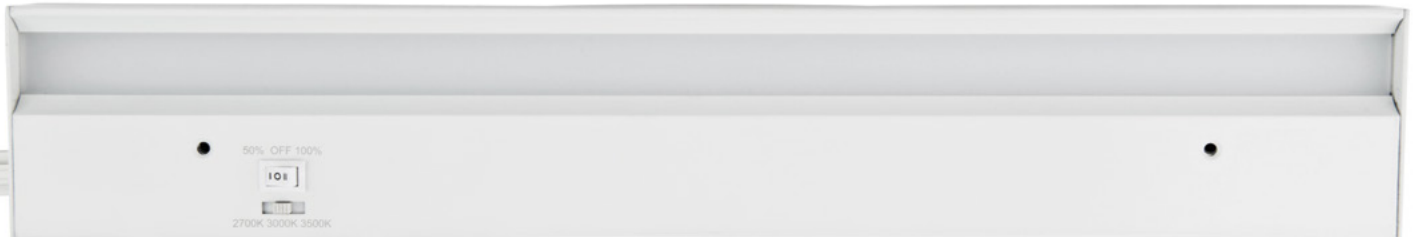

Perfect for lighting kitchen counters, our 120V under cabinet Barlight with selectable 3 CCT technology and a High-Low switch to provide quality illumination for all tasks.

- Input:** 120V
- Dimming:** 100%-10% ELV, 100%-5% TRIAC
- Rated Life:** 50,000 hours
- Rocker switch to adjust between 0%, 50%, or 100%
- Construction: aluminum with white PC diffuser
- CCT selectable: 2700K/3000K/3500K

Model	Length	Wattage	Max Lumens at 3000K	Color Temp	CRI	Finish
BA-AC	08 8"	6.5W	355	CS 2700K 3000K 3500K	90	WT White
	18 18"	10.5W	600			
	24 24"	15W	910			
	30 30"	17.5W	1075			

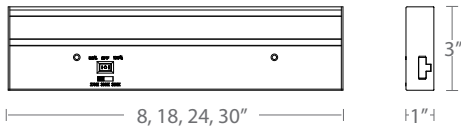

Example: **BA-AC18-CS-WT**

Model	Description	Length	Finish
BA-I	"l" Connector BA-I		WT White
BA-IC12 BA-IC24 BA-IC36	Interconnect Cable BA-IC	12" 24" 36"	
BA-PC6	Power Cord	72"	



MINI PUCK LIGHT UNDER CABINET LIGHTING



An innovative under cabinet lighting solution that can be surface mounted or recessed mounted into cabinetry for a cleaner appearance, Mini Puck Lights deliver optimal ambient illumination in kitchens and other spaces.

- Input:** 24VAC or 24VDC
Dimming: 100%-10% ELV, 100%-5% TRIAC
Rated Life: 50,000 hours
- Install as surface or recessed
 - Compatible with portable wall plug or hardwired 24V driver/transformer
 - Construction: die-cast Aluminum and PC diffuser
 - Each fixture equipped with 6ft lead wires

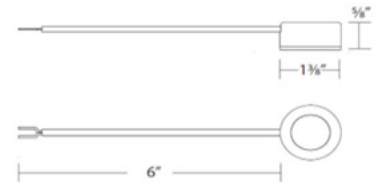

	Model	Wattage	Lumens	Color Temp	CRI	Finish
	HR-LED10 <i>1 single light</i>	2W per light	95lm per light	30 3000K	90	BK Black WT White
	HR-LED10/6 <i>Pack of 6 lights</i>					
	HR-LED10/10 <i>Pack of 10 lights</i>					
	HR-LED10/6K <i>Puck Light Kit: 6 wired lights, 1 multiple terminal block, and 24V Portable Power Supply</i>					

Example: **HR-LED10-30-BK**

COMPATIBLE 24VDC CLASS 2 POWER SUPPLY

	Model	Dimensions	Input	Output	Dimming	Finish
<i>Portable Power Supply</i> 	EN-2420D-P-BK EN-2420D-P-WT	2 3/4" x 1 5/8" x 1 1/8"	100V-240V	24VDC 24W	Non-Dimmable	Black White
<i>Remote Power Supply</i> 	EN-24DC060-UNV-RB2 EN-24DC096-UNV-RB2	8 1/8" x 2 1/16" x 2 1/4" 8 1/8" x 2 1/16" x 2 1/4"	100V-277V 100V-277V	24VDC 60W 24VDC 96W	TRIAC, ELV TRIAC, ELV	Black Black

COMPATIBLE 24VAC CLASS 2 POWER SUPPLY

	Model	Dimensions	Input	Output	Dimming	Finish
<i>Portable Power Supply</i> 	EN-2460-P-AR	2 3/4" x 1 5/8" x 1 3/4"	120V	24VAC 60W	Non-Dimmable	Black
<i>Remote Power Supply</i> 	EN-2460-RB2 EN-24100-RB2	6 1/2" x 1 5/8" x 1 1/4" 6 1/2" x 1 5/8" x 1 1/4"	120V 120V	24VAC 60W 24VAC 100W	ELV	Black Black

MULTIPLE TERMINAL BLOCK

	Model	Description	Finish
	MTB-01 MTB-01-WT	Multiple Terminal Block (Enclosure for up to 6 output connections)	Black White

PUCK LIGHT UNDER CABINET LIGHTING



Surface or Recessed Mounted

120V Direct Input
No Driver Required

BUILD A SYSTEM

Available with 3 CCT selectable color temperatures, finishes, and recessed or surface mounted options. Order single pucks or kits of multiple pucks to link together.

BEAUTIFULLY FINISHED CAST ALUMINUM



Black

Brushed Nickel

White

ALL-IN-ONE CCT SELECTABLE



2700K

3000K

3500K

PUCK LIGHT UNDER CABINET LIGHTING



A solid lighting solution for kitchen counters, our 120V under cabinet Puck Light with 3 CCT selectable technology provides quality illumination for all tasks.

Input: 120V
Dimming: 100%-10% ELV
Rated Life: 50,000 hours

- Install as surface or recessed mount
- No driver required
- Construction: die-cast aluminum and PC diffuser
- CCT selectable: 2700K/3000K/3500K

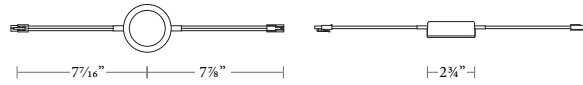
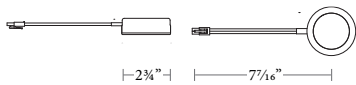

	Model	Wattage	Max Lumens	Color Temp	CRI	Finish
	HR-AC70 <i>1 single wired light</i>	4W	290	CS 2700K 3000K 3500K	90	BK Black BN Brushed Nickel WT White
	HR-AC71 <i>1 single wired light and cord</i>					
	HR-AC72 <i>1 double wired light</i>					
	HR-AC73 <i>Puck light kit: 2 double wired lights, 1 single wired light, and cord</i>	4W x 3	290 x 3			

Example: **HR-AC72-CS-BN**

	Model	Description		CRI	Finish
	HR-PC6	Power Cord		90	BK Black WT White
	HR-HWB	Hardware Box			
	HR-IC	12 24 36	12" 24" 36" Linking Cable		

Example: **HR-HWB-BK**



LOTOS 2" ADJUSTABLE LED RECESSED



Shallow profile LED that is designed to fit in furred down ceilings without sacrificing lumen output.

Input: 120-277V
Dimming: 100%-5% ELV, TRIAC
Rated Life: 50,000 hours

- Fixture height: 2¼", driver: 1¼"
- 360° retractable pivot: downlight and adjustable
- Heavy gauge retention clips secure fixture to ceiling
- Installs into ceilings between ½" and 1½" thick
- Minimum plenum space required: 4"
- Construction: steel with frosted TIR lens

	Model	Beam	Wattage	Max Lumens	Max CBCP	Color Temp	CRI	Finish	
	R2ERAR 2" Round Adjustable IC Rated, Airtight, Wet Location Listed		6W	500	1203				
	R2ESAR 2" Square Adjustable IC Rated, Airtight, Wet Location Listed								
	R2ESAR-2 2 Light Adjustable IC Rated, Airtight, Wet Location Listed	W 45°	12W	500x2	1203x2	930	3000K	90	WT White
	R2ESAR-3 3 Light Adjustable IC Rated, Airtight, Wet Location Listed		18W	500x3	1203x3				

Example: **R2ERAR-W930-WT**

LOTOS 4" & 6" ADJUSTABLE LED RECESSED



ALL-IN-ONE CCT SELECTABLE



R4ERAR/R6ERAR



R4ERA2R



Shallow profile LED that is designed to fit in furred down ceilings without sacrificing lumen output.

Input: 120-277V
Dimming: 100%-5% ELV, TRIAC
Rated Life: 50,000 hours

- Fixture height: 1½", driver 1¼"
- 360° retractable pivot: downlight and adjustable
- Heavy gauge retention clips secures fixture to ceiling
- Installs into ceilings between ½" and 1½" thick
- Minimum plenum space required: 4"
- Construction: steel with frosted TIR lens
- CCT selectable: 2700K/3000K/3500K/4000K/5000K

Model	Beam	Wattage	Max Lumens	Max CBCP	Color Temp	CRI	Finish
<p>R4ERAR 4" Round Adjustable IC Rated, Airtight, Wet Location Listed</p>	W 45°	9W	800	1020	2700K 3000K 3500K 4000K 5000K	90	WT White
<p>R4ESAR 4" Square Adjustable IC Rated, Airtight, Wet Location Listed</p>	W 45°	9W	750	1050	930 3000K		
<p>R4ERA2R 4" Round Regressed Adjustable IC Rated, Airtight, Wet Location Listed</p>	W 50°	9W	775	750	2700K 3000K 3500K 4000K 5000K		
<p>R6ERAR 6" Round Adjustable IC Rated, Airtight, Wet Location Listed</p>	W 45°	15W	1340	1896	9CS 2700K 3000K 3500K 4000K 5000K		

Example: **R4ERAR-W9CS-WT**

Optional Accessories	Model	Notes
New Construction Frame	RER-FRAME	Suitable for joists ranging from 12" to 24" apart
6ft Extension Cable	RER-6	In-wall rated cable uses twist lock to secure to fixture and driver (only suitable for non-CS models)

LOTOS 4" & 6" LED RECESSED



ALL-IN-ONE CCT SELECTABLE



Shallow profile LED that is designed to fit in furred down ceilings without sacrificing lumen output.

Input: 120-277V
Dimming: 100%-5% ELV, TRIAC
Rated Life: 50,000 hours

- Fixture height: 1", driver 1¼"
- Heavy gauge retention clips secures fixture to ceiling
- Installs into ceilings between ½" and 1½" thick
- Minimum plenum space required: 4"
- Construction: steel with translucent diffuser
- CCT selectable: 2700K/3000K/3500K/4000K/5000K

	Model	Beam	Wattage	Max Lumens	Color Temp	CRI	Finish
	R4ERDR 4" Round Downlight IC Rated, Airtight, Wet Location Listed	W	8W	725	2700K 3000K 3500K 4000K 5000K	90	WT White
	R6ERDR 6" Round Downlight IC Rated, Airtight, Wet Location Listed	W	12W	1200	9CS		

Example: **R4ERDR-W9CS-WT**

Frame-In Kit (Optional Accessory)

	Model	Notes
New Construction Frame 	RER-FRAME	Suitable for joists ranging from 12" to 24" apart



LOTOS FIRE RATED RECESSED



ALL-IN-ONE CCT SELECTABLE



R4ERAR/R6ERAR



R4ERA2R



R4ERDR/R6ERDR



Fire rated to reduce the spread of flames and maintain the integrity of the ceiling.

- Input:** 120-277V
Dimming: 100%-5% ELV, TRIAC
Rated Life: 50,000 hours
- 360° retractable pivot: downlight and adjustable
 - Heavy gauge retention clips secures fixture to ceiling
 - Installs into ceilings between 1/2" and 1 1/2" thick
 - Minimum plenum space required: 4 1/2"
 - Construction: steel with frosted TIR lens
 - CCT selectable: 2700K/3000K/3500K/4000K/5000K
 - Fire rated - ASTM E119 and UL 263 certified

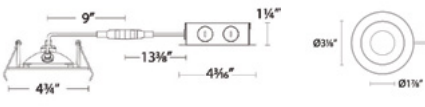
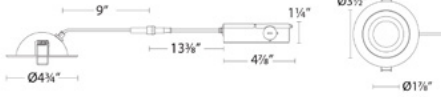
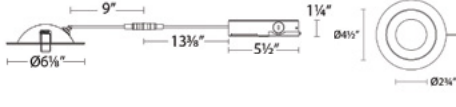
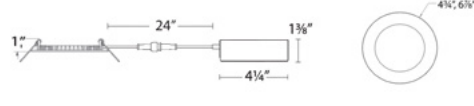
Model	Beam	Wattage	Max Lumens	Color Temp	CRI	Fire Rated	Finish
 <p>R4ERAR 4" Round Adjustable IC Rated, Airtight, Wet Location Listed</p>	W 45°	9W	800	9CS 2700K 3000K 3500K 4000K 5000K	90	F	WT White
 <p>R4ERA2R 4" Round Regressed Adjustable IC Rated, Airtight, Wet Location Listed</p>	W 50°	9W	775				
 <p>R6ERAR 6" Round Adjustable IC Rated, Airtight, Wet Location Listed</p>	W 45°	15W	1320				
 <p>R4ERDR 4" Round Downlight IC Rated, Airtight, Wet Location Listed</p> <p>R6ERDR 6" Round Downlight IC Rated, Airtight, Wet Location Listed</p>	W 180°	8W	725				
	W 180°	12W	1200				

Example: R6ERAR-W9CS-FWT

PATRIOT 3" LED RECESSED



ALL-IN-ONE CCT SELECTABLE



5-CCT meets adjustability. 3" PATRIOT Recessed Downlight and Adjustable provides up to 1000 lumens, perfect for residential applications. An optional frame-in kit is available for all new construction installations.

Power: 12W
Input: 120-277V
Dimming: 100%-10% ELV, 100%-5% TRIAC
Rated Life: 50,000 hours

- Available as a remodel or new construction
- Installs into ceilings between 1/2" and 1 1/2" thick
- Two beam angle options included: 45° beam film pre-installed, remove film for 25° narrow beam
- Construction: die-cast aluminum with reflector
- CCT selectable: 2700K/3000K/3500K/4000K/5000K

Model	Beam	Max Lumens	Max CBCP	Color Temp	CRI	Finish
 R3HRDR Round Remodel IC Rated, Airtight, Wet Location Listed	F 25° 45°	1035	3045	9CS 2700K 3000K 3500K 4000K 5000K	90	WT White
 R3HRAR Round Adjustable Remodel IC Rated, Airtight, Wet Location Listed		1000	3095			
 R3HSDR Square Remodel IC Rated, Airtight, Wet Location Listed		1035	3045			
 R3HSAR Square Adjustable Remodel IC Rated, Airtight, Wet Location Listed		1000	3095			

Example: **R3HRDR-F9CS-WT**

Frame-In Kit (Optional Accessory)

Model

Notes

New Construction Frame



R3H-FRAME

Ceiling thickness: 1/2" - 1 1/2"

ION 2" LED RECESSED



Minimum profile ION 2" Round and Square downlight with removable driver and electrical box for easy remodel or new construction installation.

Power: 9W
 Input: 120-277V
 Dimming: 100%-10% ELV, 100%-5% TRIAC
 Rated Life: 50,000 hours

- Available as a remodel or new construction
- Installs into ceilings between 1/2" and 1 1/2" thick
- Construction: die-cast aluminum with frosted TIR lens

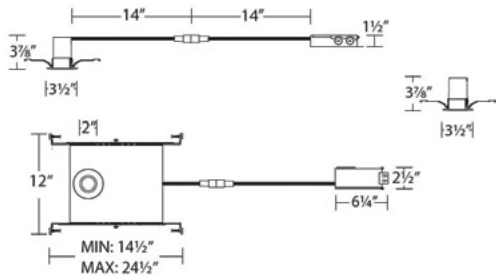
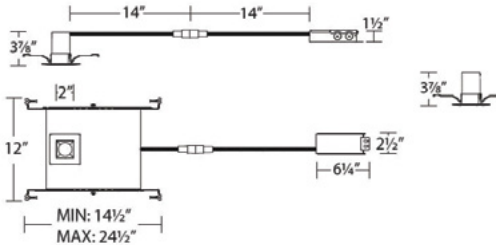

Model	Beam	Max Lumens	Max CBCP	Color Temp	CRI	Finish
 <p>R2DRDR Round Remodel IC Rated, Airtight, Wet Location Listed</p> <p>R2DRDN Round New Construction IC Rated, Airtight, Wet Location Listed</p>		680	1390			
	F 45°			930 3000K	90	WT White
 <p>R2DSDR Square Remodel IC Rated, Airtight, Wet Location Listed</p> <p>R2DSDN Square New Construction IC Rated, Airtight, Wet Location Listed</p>		735	1390			

Example: **R2DRDR-F930-WT**

Frame-In Kit (Optional Accessory)

Model

Notes

New Construction Frame



R2DRDN-FRAME

Ceiling thickness: 1/2" - 1 1/2"

POP-IN 4" LED RECESSED



ALL-IN-ONE CCT SELECTABLE



Minimum profile downlight with driver and electrical connection box attached to fixture for easy Remodel or New Construction installation.

Power: 12W
 Input: 120-277V
 Dimming: 100%-10% ELV, 100%-5% TRIAC
 Rated Life: 50,000 hours

- Electrical wiring box directly on the back of the fixture
- Available as a remodel or new construction
- Installs into ceilings between 1/2" and 1 1/2" thick
- Construction: die-cast aluminum with frosted TIR lens
- CCT selectable: 2700K/3000K/3500K/4000K/5000K

Model	Beam	Max Lumens	Max CBCP	Color Temp	CRI	Finish
<p>R4DRDR Round Remodel IC Rated, Airtight, Wet location Listed</p>						
<p>R4DRDN Round New construction IC Rated, Airtight, Wet location Listed</p>		1080	1309			
<p>R4SDR Square Remodel IC Rated, Airtight, Wet location Listed</p>						
<p>R4SDN Square New construction IC Rated, Airtight, Wet location Listed</p>	F 45°	1000	1256	2700K 3000K 3500K 4000K 5000K	90	WT White

Example: **R4DRDR-F9CS-WT**

Frame-In Kit (Optional Accessory)

Model

Notes

New Construction Frame



R4DRDN-FRAME

Ceiling thickness: 1/2"-1 1/2"

BLAZE 6" LED RECESSED



ALL-IN-ONE CCT SELECTABLE



BLAZE 6" Round and Square.
5-CCT selectable downlight.

Power: 25W
 Input: 120-277V
 Dimming: 100%-10% ELV, 100%-5% TRIAC
 Rated Life: 50,000 hours

- Available as a remodel or new construction
- Installs into ceilings between 1/2" and 1 1/2" thick
- Construction: die-cast aluminum with frosted TIR lens
- CCT selectable: 2700K/3000K/3500K/4000K/5000K

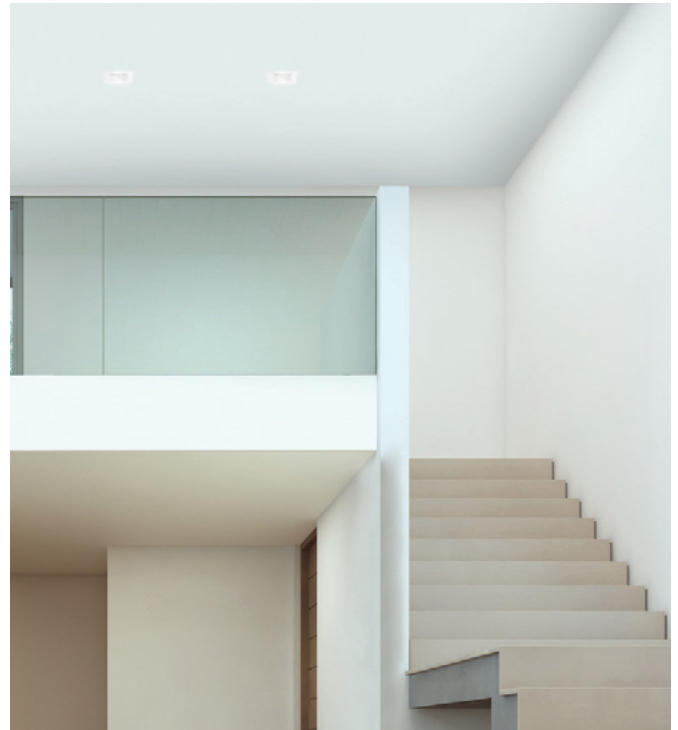

	Model	Beam	Max Lumens	Max CBCP	Color Temp	CRI	Finish
	R6DRDR Round Remodel IC Rated, Airtight, Wet Location Listed	F 55°	2485	2130	9CS 2700K 3000K 3500K 4000K 5000K	90	WT White
	R6DRDN Round New construction IC Rated, Airtight, Wet location Listed						
	R6DSDR Square Remodel IC Rated, Airtight, Wet location Listed	F 55°	2360	2060	9CS 2700K 3000K 3500K 4000K 5000K	90	WT White
	R6DSDN Square New Construction IC Rated, Airtight, Wet location Listed						

Example: **R6DSDR-F9CS-WT**

Frame-In Kit (Optional Accessory)

Model

Notes

New Construction Frame



R6DRDN-FRAME

Ceiling thickness: 1/2"-1 1/2"



LITHIUM EM BATTERY BACKUP



ALL-IN-ONE CCT SELECTABLE



Convenient emergency battery backup button is discreet to maintain product appearance

The standard ceiling light and emergency battery backup ceiling light are nearly identical in 2 convenient sizes.

High light output, hidden hardware, and broad even illumination are the primary features of this sleek flush mount. Often used in hallways, dorm rooms, and bathrooms. Installation is a snap.

Input: 120-277V

Dimming: 100%-10% ELV, 100%-5% TRIAC

Rated Life: 50,000 hours

- During emergency mode, fixture will stay illuminated for 90 minutes at reduced power
- Install over 3", 4" or a combination 3/0-4/0 electrical box
- Construction: aluminum with translucent diffuser
- CCT selectable: 2700K/3000K/3500K/4000K/5000K

	Model	Wattage	Max Lumens	Color Temp	CRI	Finish
	FM-200111	15W	1080	CS 2700K 3000K 3500K 4000K 5000K	90	BN <i>Brushed Nickel</i>
	FM-200115	25W	1815			
	FM-200115EM <i>Emergency Back Up</i>					
	FM-200118	31W	2410			
	FM-200118EM <i>Emergency Back Up</i>					

Example: **FM-200115-CS-BN**

I CAN'T BELIEVE IT'S NOT RECESSED
FUNCTIONAL LED CEILING LIGHT



Multiple mid-powered LEDs illuminate the acrylic diffuser uniformly without socket shadows, which are common in conventional flush mounts.

Input: 120V
Dimming: 100%-10% ELV, 100%-5% TRIAC
Rated Life: 50,000 hours

- Imitates a traditional 6" line voltage recessed downlight with an R30 light bulb
- Install into 4" junction box or a combination 3/0-4/0 electrical box
- Construction: aluminum with translucent diffuser
- Finished screw caps included to eliminate shadows

	Model	Max Lumens	Power	Color Temp	CRI	Finish
	FM-616G2-930	1050	16W	3000K	90	WT White

Example: **FM-616G2-930-WT**

DISC FUNCTIONAL LED CEILING LIGHT & RECESSED RETROFIT



FM-306-930JB-WT



FM-306MS-930JB-WT

Multiple mid-powered LEDs uniformly illuminate the acrylic diffuser.

Input: 120V
Dimming: 100%-10% ELV, 100%-5% TRIAC
Rated Life: 50,000 hours

- FM-306MS: motion sensor keeps the light illuminated for 3 minutes before shutting off if no movement is detected
- Construction: aluminum with translucent diffuser



Install over a 3" or 4" junction box or pancake box



Retrofit over a 4", 5" or 6" recessed can

	Model	Max Lumens	Wattage	Color Temp	CRI	Finish	
	FM-304	725	12W	930 3000K	90	BN Brushed Nickel BZ Bronze WT White	Fits over a 4" recessed can or direct wire in a 3" or 4" junction box or pancake box
	FM-306	950	15W	930 940 3000K 4000K	90		Fits over a 5" to 6" recessed can or direct wire in a 3" or 4" junction box or pancake box
	FM-306MS <i>Infrared Motion Sensor</i>	1100	14W	930JB 3000K	90	WT White	Direct mount on a 3" or 4" junction box or pancake box
	FM-309	1725	23W	9CSJB 2700K 3000K 3500K 4000K 5000K	90	WT White	

Example: **FM-306-930JB-WT**



BLO · FLO · GLO

LED FUNCTIONAL CEILING & WALL MOUNTS



ALL-IN-ONE CCT SELECTABLE



BLO



Input: 120-277V
Dimming: 100%-10% ELV, 100%-5% TRIAC
Rated Life: 50,000 hours

- Install over 3", 4" or a combination 3/0, 4/0 electrical box
- Construction: aluminum with translucent acrylic diffuser
- CCT selectable: 2700K/3000K/3500K/4000K/5000K

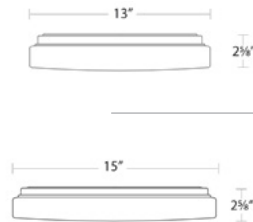

Model	Max Lumens	Wattage	Color Temp	CRI	Finish
FM-113	1600	22W	CS 2700K 3000K 3500K 4000K 5000K	90	WT White
FM-115	2230	26W			

FLO



Input: 120-277V
Dimming: 100%-10% ELV, 100%-5% TRIAC
Rated Life: 50,000 hours

- Sizes: 24", 36", 48"
- Installation: wall and ceiling
- Construction: aluminum with translucent acrylic diffuser
- CCT selectable: 2700K/3000K/3500K/4000K/5000K

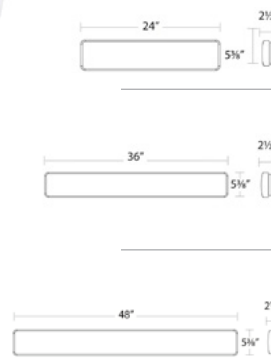

Model	Max Lumens	Wattage	Color Temp	CRI	Finish
WS-224	1400	17W	CS 2700K 3000K 3500K 4000K 5000K	90	WT White
WS-236	2250	28W			
WS-248	2630	32W			

GLO



Input: 120-277V
Dimming: 100%-10% ELV, 100%-5% TRIAC
Rated Life: 50,000 hours

- Install over 3", 4" or a combination 3/0, 4/0 electrical box
- Construction: aluminum with translucent acrylic diffuser
- CCT selectable: 2700K/3000K/3500K/4000K/5000K

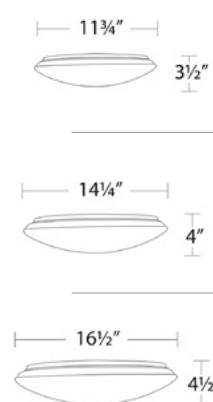

Model	Max Lumens	Wattage	Color Temp	CRI	Finish
FM-211	1160	15W	CS 2700K 3000K 3500K 4000K 5000K	90	WT White
FM-214	1660	22W			
FM-216	2300	26W			

ROUND & SQUARE
5" FUNCTIONAL LED CEILING OR WALL LUMINAIRE



At just 1/2" thick, these edge-lit flush mounts are frequently replacing the usage of recessed lighting and larger flush mounts to preserve ceiling height. Mounting over standard size junction boxes, the broad illumination is perfect for lighting hallways and other narrow spaces. Available in a range of sizes, smaller sizes are also wet location rated for use outdoors.

Input: 120V-277V
Dimming: 100%-10% ELV, 100%-5% TRIAC
Rated Life: 50,000 hours

- Size: 5"
- Install into 3", 4" or a combination 3/4-4/0 electrical box
- Construction: injection molded UV rated PC with translucent diffuser
- Suitable for outdoor and coastal regions

	Model	Wattage	Max Lumens	Color Temp	CRI	Finish
	FM-05RN Round	12W	1050	930 3000K	90	BK Black BZ Bronze NI Nickel WT White
				935 3500K	90	BZ Bronze NI Nickel WT White
	FM-05SQ Square	12W	1030			BZ Bronze NI Nickel WT White







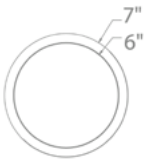

Example: **FM-05RN-930-WT**

ROUND & SQUARE
FUNCTIONAL LED CEILING OR WALL LUMINAIRE

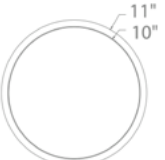

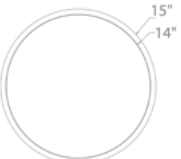
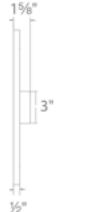
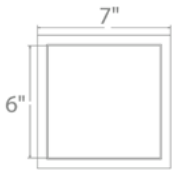
Input: 120V
Dimming: 100%-10% ELV, 100%-5% TRIAC
Rated Life: 50,000 hours

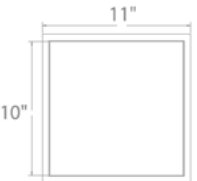
- Sizes: 7", 11", 15" (Round only)
- Install into 3", 4" or a combination 3/4-4/0 electrical box
- Construction: aluminum with translucent diffuser

		Model	Max Lumens	Wattage	Color Temp	CRI	Finish
		FM-07RN <i>Round</i>	1100	15W			
		FM-11RN <i>Round</i>	1525	20W			BK <i>Black</i> BN <i>Brushed Nickel</i> BZ <i>Bronze</i> WT <i>White</i>
		FM-15RN <i>Round</i>	2550	28W	930 3000K 935 3500K	90 90	
		FM-07SQ <i>Square</i>	1100	15W			BN <i>Brushed Nickel</i> BZ <i>Bronze</i> WT <i>White</i>
		FM-11SQ <i>Square</i>	1650	20W			

Example: **FM-15RN-930-WT**



REMI LED VANITY LIGHTS & WALL SCNCE



CALIFORNIA
JA8
TITLE 24



ALL-IN-ONE CCT SELECTABLE

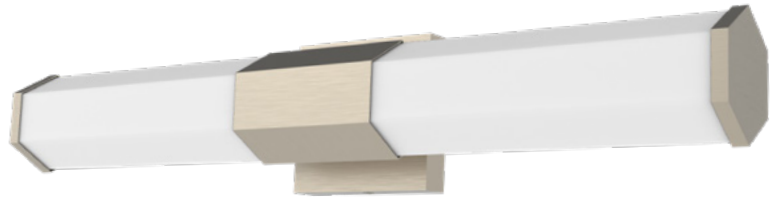

Finely crafted of white acrylic and aluminum, Remi delivers robust, flattering illumination as a vanity luminaire in a elegant bath or wall sconce that blends with any interior decor.

Input: 120V

Dimming: 100%-10% ELV, 100%-5% TRIAC

Rated Life: 50,000 hours

- Sizes: 16", 24"

- Construction: aluminum with acrylic diffuser

- CCT selectable: 2700K/3000K/3500K

	Model	Max Lumens	Wattage	Color Temp	CRI	Finish
	WS-230116	900	18W	CS 2700K 3000K 3500K	90	BN Brushed Nickel BK Black
	WS-230124	1500	30W			

Example: **WS-230116-CS-BN**



TURBO LED VANITY LIGHTS & WALL SCNCE



A contemporary design provides soft diffused illumination through translucent acrylic. Turbo can be mounted vertically or horizontally to accommodate a variety of applications. Available in Chrome and Brushed Nickel to pair with popular bath hardware.

Input: 120-277V

Dimming: 100%-10% ELV, 100%-5% TRIAC

Rated Life: 50,000 hours

- Sizes: 14", 24"

- Construction: aluminum with dual layer acrylic diffuser

	Model	Max Lumens	Wattage	Color Temp	CRI	Finish
	WS-180414	1000	12W	30 3000K	90	BN Brushed Nickel
				35 3500K	90	CH Chrome
	WS-180424	1570	18W			

Example: **WS-180414-35-BN**



Multiple mid-powered LEDs deliver soft illumination through translucent acrylic. Metro is available as a wall sconce or as a flush mount to meet a variety of applications. Available in Chrome and Brushed Nickel to pair with popular bath hardware.

Input: 120-277V
Dimming: 100%-10% ELV, 100%-5% TRIAC
Rated Life: 50,000 hours

- Sizes: 12", 18"
- Fixture height: 1 3/4"
- Install into 3", 4" or a combination 3/0-4/0 electrical box
- Construction: aluminum with dual layer acrylic diffuser

	Model	Max Lumens	Wattage	Color Temp	CRI	Finish
	FM-180112	1800	24W	30 3000K	90	BN Brushed Nickel CH Chrome
	FM-180118	2375	32W			

Example: **FM-180118-30-BN**

METRO LED VANITY LIGHTS & WALL SCNCE



Multiple mid-powered LEDs deliver soft illumination through translucent acrylic. Metro is available as a wall sconce or as a flush mount to meet a variety of applications. Available in Chrome and Brushed Nickel to pair with popular bath hardware.

Input: 120-277V

Dimming: 100%-10% ELV, 100%-5% TRIAC

Rated Life: 50,000 hours

- Sizes: 20", 27", 37"

- Construction: aluminum with dual layer acrylic diffuser

- Can be mounted vertically or horizontally

	Model	Max Lumens	Wattage	Color Temp	CRI	Finish
	WS-180120	1150	16W			
	WS-180127	1450	20W	30 3000K	90	BN Brushed Nickel CH Chrome
	WS-180137	2130	28W			

Example: **WS-180127-30-BN**



Sleek style with plated brushed nickel finished end caps and high-powered LEDs that provide broad ample illumination. Fuse can be mounted on walls or on the ceiling to suit a variety of applications and styles in current architectural design.

- | | | |
|--------------------|-----------------------------|---|
| Input: | 120V-277V | • Sizes: 16", 27", 37" |
| Dimming: | 100%-10% ELV, 100%-5% TRIAC | • Construction: aluminum with acrylic diffuser |
| Rated Life: | 50,000 hours | • Installation: wall or ceiling, horizontally or vertically |

	Model	Max Lumens	Wattage	Color Temp	CRI	Finish
	WS-180216	1025	16W			
	WS-180227	1450	20W	30 3000K	90	BN Brushed Nickel
	WS-180237	2025	28W			

Example: **WS-180216-30-BN**

LINK LED VANITY LIGHTS & WALL SCNCE



This low-profile transitional wall sconce provides bountiful light and style. Link adds a clean, modern look to bath vanities and other decor. May be installed horizontally over a vanity or vertically as a sconce.

- | | |
|--|--|
| <p>Input: 120V-277V</p> <p>Dimming: 100%-10% ELV, 100%-5% TRIAC</p> <p>Rated Life: 50,000 hours</p> | <ul style="list-style-type: none"> • Sizes: 27", 37" • Construction: aluminum with white acrylic diffuser • Can be mounted vertically or horizontally |
|--|--|

	Model	Max Lumens	Wattage	Color Temp	CRI	Finish
	WS-180327	1380	20W	30 3000K	90	BN <i>Brushed Nickel</i>
	WS-180337	1950	28W			

Example: **WS-180337-30-BN**



WS-W220208-30-BK



WS-W220212-30-WT



WS-W190208-30-BZ



WS-W190212-30-WT

Available in single and double directions, Cubix and Cylinder are ideal for illuminating outdoor entrances and walkways.

Input: 120V
Dimming: 100%-10% ELV
Rated Life: 50,000 hours

- Sizes: 6 $\frac{3}{4}$ " single light, 9 $\frac{9}{16}$ " double lights
- Construction: die-cast aluminum
- Finish: powder coated aluminum

	Model	Wattage	Max Lumens	Color Temp	CRI	Finish
	WS-W220208 <i>Single Light</i>	6W	285	30 3000K	80	BK Black BZ Bronze WT White
	WS-W220212 <i>Double Light</i>	18W	765			
	WS-W190208 <i>Single Light</i>	6W	285			
	WS-W190212 <i>Double Light</i>	18W	765			

Example: **WS-W220208-30-BK**

CYLINDER OUTDOOR SCNCE



Offered in a curvaceous single and double head configuration, the adjustable Cylinder Indoor/Outdoor Sconces provide strong energy efficient LED spot lighting precisely where you need it. Cleanly finished with no visible hardware, these stylish aluminum cylinders are available in three architectural powder coat finishes.

Input: 120V
Dimming: 100%-10% ELV
Rated Life: 50,000 hours

- Construction: aluminum with TIR lens
- Finish: powder coated aluminum

	Model	Max Lumens	Wattage	Color Temp	CRI	Finish
	WS-W230301	1085	17W	30 3000K	90	BK Black BZ Bronze WT White
	WS-W230302	1085 x 2	33W			

Example: **WS-W230301-30-BK**



Add a modern vibe and powerful illumination to your porch, deck, or garage with the sleek Vega, an ADA-compliant indoor/outdoor sconce.

Input: 120V
Dimming: 100%-10% ELV
Rated Life: 50,000 hours

- Sizes: 9", 14"
- Construction: die-cast aluminum with acrylic diffuser
- Finish: powder coated aluminum

	Model	Max Lumens	Wattage	Color Temp	CRI	Finish
	WS-W190109	545	8W	30 3000K	90	BK Black
	WS-W190114	1050	16W			

Example: **WS-W190114-30-BK**

VUE OUTDOOR SCNCE



ALL-IN-ONE CCT SELECTABLE

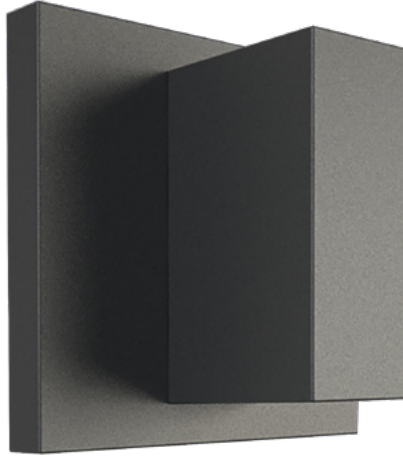
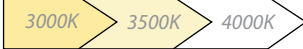

A geometric design that defines a modern aesthetic in your indoor or outdoor space. Vue is a die-cast aluminum sconce that provides up and down lighting for beautiful ambient illumination.

Input: 120V
Dimming: 100%-10% ELV
Rated Life: 50,000 hours

- Size: 5"
- Construction: die-cast aluminum
- Finish: powder coated aluminum
- CCT selectable: 3000K/3500K/4000K

	Model	Max Lumens	Wattage	Color Temp	CRI	Finish
	WS-W230205	250 Up 250 Down	9W	CS 3000K 3500K 4000K	90	BK Black WT White

Example: **WS-W230205-CS-BK**

120/277V RECTANGULAR STEP & WALL LIGHTS



Input: 120V, 277V
Brightness: Up to 4 lm
Dimming: 100%-10% ELV (120V only)
Rated Life: 50,000 hours

- Fluid decorative profile with full cut-off illumination
- Die-cast aluminum construction with abrasion-resistant powder-coated finish or plated brushed nickel finish
- Title 24 compliant (120V only)

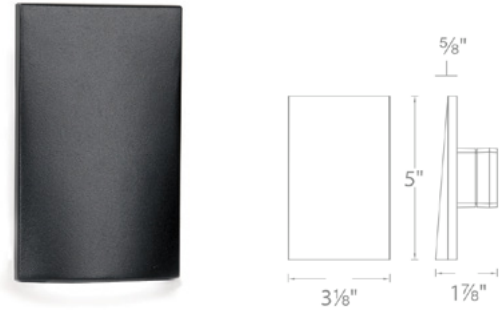
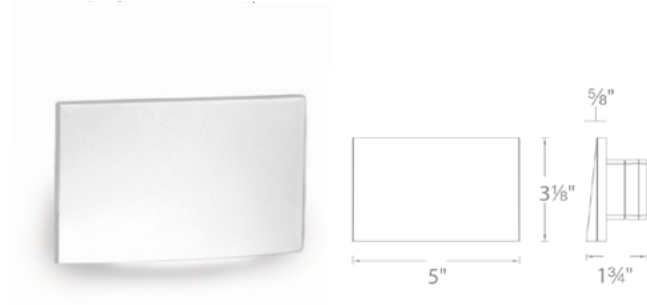

Model	Voltage	Wattage	Color Temp	CRI	Finish
WL-LED110-C WL-LED110-AM	120V	3.5W	3000K Amber	90	BK Black on AL BN* Brushed Nickel BZ Bronze on AL WT White on AL
WL-LED110F-C WL-LED110F-AM	277V	3W	3000K Amber		

Example: **WL-LED110-C-WT**

Model	Voltage	Wattage	Color Temp	CRI	Finish
WL-LED210-C WL-LED210-AM	120V	3.5W	3000K Amber	90	BK Black on AL BN* Brushed Nickel BZ Bronze on AL WT White on AL
WL-LED210F-C WL-LED210F-AM	277V	3W	3000K Amber		

Example: **WL-LED210-C-BK**

* BN finish is damp location listed and is not warranted for contact with harsh chemicals or exterior installations.

Input: 120V, 277V
Brightness: Up to 36 lm
Dimming: 100%-10% ELV (120V only)
Rated Life: 50,000 hours

- Louvered design shields glare for visual comfort
- Die-cast aluminum construction with abrasion-resistant powder-coated finish

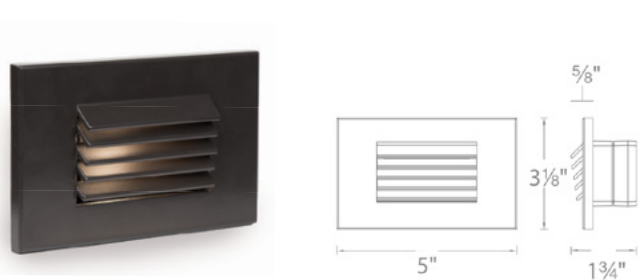

Model	Voltage	Wattage	Color Temp	CRI	Finish
WL-LED120-C WL-LED120-AM	120V	3.5W	3000K Amber	90	BK Black on AL BZ Bronze on AL WT White on AL
WL-LED120F-C WL-LED120F-AM	277V	3W	3000K Amber		

Example: **WL-LED120-C-BZ**

Model	Voltage	Wattage	Color Temp	CRI	Finish
WL-LED220-C WL-LED220-AM	120V	3.5W	3000K Amber	90	BK Black on AL BZ Bronze on AL WT White on AL
WL-LED220F-C WL-LED220F-AM	277V	3W	3000K Amber		

Example: **WL-LED220-C-BZ**

120V/277V RECTANGULAR STEP & WALL LIGHTS



Input: 120V, 277V
Brightness: Up to 40 lm
Dimming: 100%-10% ELV (120V only)
Rated Life: 50,000 hours

- Tempered glass diffuses light for even illumination
- Die-cast aluminum construction
- Abrasion-resistant powder-coated finish or marine grade stainless steel option available
- Title 24 compliant (120V only)

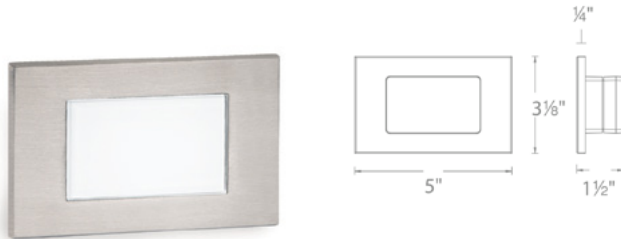

Model	Voltage	Wattage	Color Temp	CRI	Finish
WL-LED130-C WL-LED130-AM	120V	3.5W	3000K Amber	90	BK Black on AL BZ Bronze on AL SS Stainless Steel WT White on AL
WL-LED130F-C WL-LED130F-AM	277V	3W	3000K Amber		

Example: **WL-LED130-C-SS**

Input: 120V, 277V
Brightness: Up to 3 lm
Dimming: 100%-10% ELV (120V only)
Rated Life: 50,000 hours

- Geometric design with downward illumination
- Die-cast aluminum construction with abrasion-resistant powder-coated finish
- Title 24 compliant (120V only)

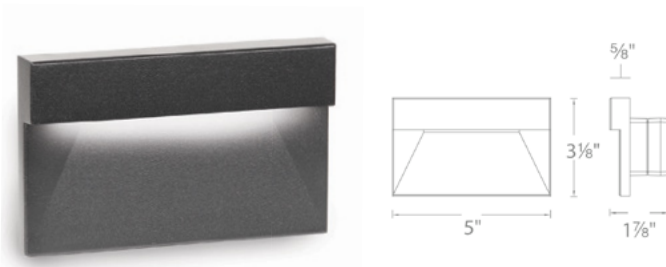

Model	Voltage	Wattage	Color Temp	CRI	Finish
WL-LED140-C WL-LED140-AM	120V	3.5W	3000K Amber	90	BK Black on AL BZ Bronze on AL WT White on AL
WL-LED140F-C WL-LED140F-AM	277V	3W	3000K Amber		

Example: **WL-LED140-C-BK**

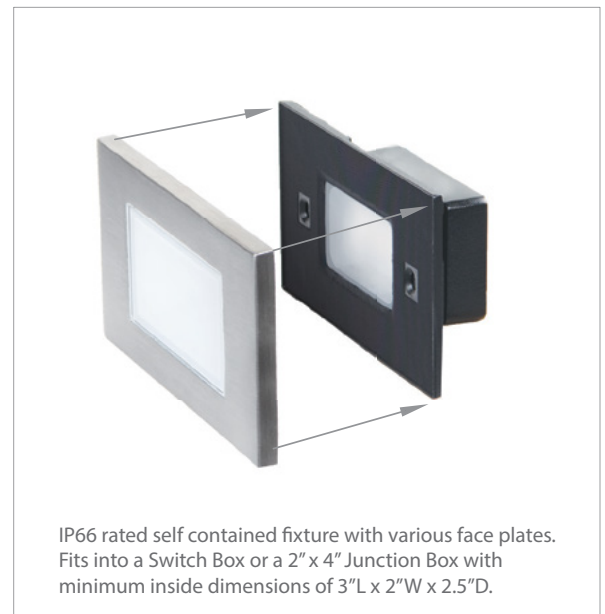

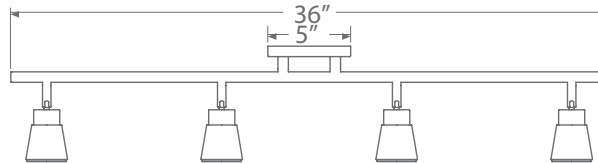
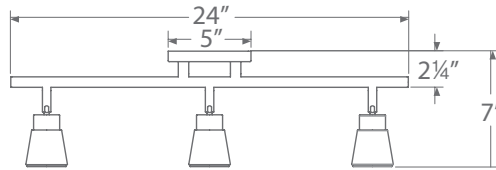
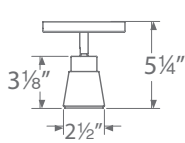

Monopoint, 3-head, or 4-head fixed track with individually adjustable LED track fixtures can be wall mounted or ceiling mounted for a wide multitude of applications. It is specifically designed for residential and low-ceiling commercial applications.

Comparable To: 65W MR16
Input: 120V
Dimming: 100%-10% ELV, 100%-5% TRIAC
Rated Life: 50,000 hours

- Monopoint, 3-head, or 4-head fixed rails
- Sizes: 5" (Monopoint), 24", 36"
- Construction: die-cast aluminum with frosted TIR lens
- Installation: wall and ceiling
- 350° horizontal and 90° vertical aiming per head

System	Model	Lights	Beam	Max Lumens	CBCP	Wattage	Color Temp	CRI	Finish
TK	1805	01	45°	800	1095	10W	30 3000K	90	BK Black BN Brushed Nickel WT White
		03		2400 (800 x3)	3285 (1095 x3)	30W			
		04		3200 (800 x4)	4380 (1095 x4)	40W			

Example: **TK-180503-30-BK**



LOW VOLTAGE LED/MR16 FLEXIBLE SPOT LIGHTS

Power: 7W Color Temp: 3000K
 Lumens: 450 Dimming: ELV
 CBCP: 929 LED Lamp
 Comparable: 35W MR16 Rated Life: 25,000 hours

- Integral electronic transformer
- Accepts 12V LED MR16 or halogen MR16 lamps up to 50W max
- LED MR16 included when ordered as LED
- 1 watt minimum load
- Can be wall or ceiling mounted
- Available extensions from 6 to 48 inches
- Clear lens included (see below for alternate lens options)

826

	Model	Lamp	Extension (optional)	CRI	Finish
	ME-826LED ME-826	LED Halogen	X6 6"	90	BK Black WT White
			X12 12"		
			X18 18"		
			X24 24"		
			X36 36"		
			X48 48"		

Example: **ME-826LED-BN** or **ME-826LED-X36-BN** (with 36" extension)



007

	Model	Lamp	Extension (optional)	CRI	Finish
	ME-007LED ME-007	LED Halogen	X6 6"	90	BK Black WT White
			X12 12"		
			X18 18"		
			X24 24"		
			X36 36"		
			X48 48"		

Example: **ME-007LED-BN** or **ME-007LED-X6-BK** (with 6" extension)



FRAMING PROJECTOR ACCESSORY

008FP	BK	Black
	WT	White

Example: **008FP-BK**



808

	Model	Lamp	Extension (optional)	CRI	Finish
	ME-808LED ME-808	LED Halogen	X6 6"	90	BK Black WT White
			X12 12"		
			X18 18"		
			X24 24"		
			X36 36"		
			X48 48"		

Example: **ME-808LED-BN** or **ME-808LED-X12-WT** (with 12" extension)



LAMPS

	Finish	Wattage	Color Temp	Input	Beam	CRI	Lumens	CBCP	Average Life	
	MR16LED-BAB-BK MR16LED-BAB-WT	Black White	7W	3000K	12V	35°	90	450	929	25,000 Hours

LENS ACCESSORIES

Amber	LENS-16-AMB	Blue Green	LENS-16-BLU LENS-16-GRN	Red Frosted	LENS-16-RED LENS-16-FR	UV Filter Spread	LENS-16-UVF LENS-16-SPR	Beam Elongating Honeycomb Louver	LENS-16-BEL LENS-16-HCL
-------	--------------------	---------------	--	----------------	---	---------------------	--	-------------------------------------	--



- Suitable for H, J or L track
- 350° horizontal and 90° vertical aiming
- Driver concealed within fixture
- Construction: die-cast aluminum with frosted TIR lens
- Input: 120V
- Dimming: 100%-10% ELV, 100%-5% TRIAC
- Rated Life: 50,000 hours

	System	Model	Beam	Max Lumens	CBCP	Wattage	Color Temp	CRI	Finish
	H H Track	7010	45°	850	1078	10W	30 3000K	90	BK Black BN Brushed Nickel WT White
	L L Track J J/J2 Track	7010			1078				BK Black WT White

Example: **H-7010-30-BN**

CHARGE 8010 & 8020 LED TRACK



CALIFORNIA
JA8
TITLE 24



H-8010/3-30-BN

H-8010-30-BK

H-8020-30-WT

- Suitable for H, J or L track
- 350° horizontal and 90° vertical aiming
- Driver concealed within fixture
- Construction: die-cast aluminum with frosted TIR lens
- Input: 120V
- Dimming: 100%-10% ELV, 100%-5% TRIAC
- Rated Life: 50,000 hours

		System	Model	Beam	Max Lumens	CBCP	Wattage	Color Temp	CRI	Finish
	H H Track L L Track J J/J2 Track	8020	45°	1280	1402	16W	30 3000K	90	BK Black BN Brushed Nickel WT White	
		H H Track L L Track J J/J2 Track		8010	850	1196			11W	BK Black BN Brushed Nickel DB Dark Bronze WT White
<p>Track Pack includes</p> <ul style="list-style-type: none"> • 4ft H Track • Floating Canopy • Three 8010 Charge Track Heads 	H H Track	8010/3		850x3	1196x3	11Wx3			BK Black BN Brushed Nickel DB Dark Bronze WT White	

Example: **H-8010-30-DB**

H TRACK SYSTEM

Description: Single circuit H-Track
Power per Circuit: 120V, 1920W max
Operating Current: Rated 20A max



TRACK SECTIONS

Model	Length	Finish	Description
HT H Track	2 2'	BK Black	120V 3-wire track
	4 4'	BN Brushed Nickel	
	6 6'	WT White	
	8 8'	DB Dark Bronze	

Example: **HT6-BK**

Each section includes two matching end caps

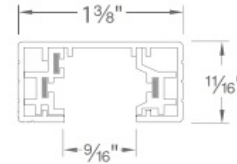

TRACK SUSPENSION

System	Model	Finish			
All Track Suspension Kit	SK	BK Black BN Brushed Nickel WT White DB Dark Bronze			
	18 18" 24 24"		36 36" 48 48"		
Suspension Kit Extender	R				
	18 18" 24 24" 36 36"		48 48" 72 72"		
	Sloped Ceiling Adapter		SK14		
Rod Coupler	RI				
Suspension Adjustment Collar Kit	SK05		Includes two collars		
Low Voltage Track Head Extension	X		6 6" 12 12" 18 18"	24 24" 36 36" 48 48"	
		Line Voltage Track Head Extension (H track only)	H	18 18" 24 24"	36 36" 48 48"
				Wall Mount Suspension Bracket	TBKT

Extends track from ceiling. Includes track bracket, rod and ceiling canopy. Use two per 4' length, three per 8' length.

Use with Rod Coupler (RI) to further extend track from ceiling.

Use with suspension kits to accommodate sloped ceilings. Max capacity: 7A, 800W, 120V.

Join two rods for suspensions longer than 48".

Used when suspension rod is field cut to custom lengths. One kit of two required for each rod.

















Extends low voltage track heads from track. Specify extension, fixture and finish. Only available as complete unit. Custom order example: X18-HHT-809-WT.

Extends H System line voltage track heads.

Extends track 24" from wall. Use two per 4' length, three per 8' length.

Example: **SK24-BK**

ACCESSORIES

		Model	Finish	Dimensions	Description
Live End Connector		HLE		4 1/4" x 1 3/8" x 3/4"	Use for direct wiring through ceiling. A canopy plate is required when using with a standard junction box.
Live End BX Connector		HBXLE		6" x 1 3/8" x 1 1/4"	Use with surface mounted BX or non-metallic sheathed cable. Also provides through the ceiling connection.
1" Power Connector		HI-PWR		6 3/4" x 1 3/8" x 3/4"	Power entry point at the connection of 2 tracks.
1" Connector Left		HL-LEFT		2 3/4" x 2 3/4" x 3/4"	Use to join 2 track sections to make power feedable 90° left polarity turns.
1" Connector Right		HL-RIGHT		2 3/4" x 2 3/4" x 3/4"	Use to join 2 track sections to make power feedable 90° right polarity turns.
1" T Connector		HT	BK Black BN Brushed Nickel WT White DB Dark Bronze	4" x 2 3/4" x 3/4"	Use to join 3 tracks sections. "T" Connector with opposite polarity can be custom ordered.
1" X Connector		HX		4 1/8" x 4 1/8" x 3/4"	Use to join 4 track sections.
1" Connector		HI		9 3/4" x 1 3/8" x 3/4"	Use to join two sections of track with electrical continuity.
1" Dead End Connector		HI-DEC		3" x 1 3/8" x 3/4"	Joins two sections of track without electrical continuity.
Flexible Track Connector		HFLX		9 3/4" x 1 3/8" x 3/4"	Connects two track sections at variable angles. Use as a transition from wall-to-wall, wall-to-ceiling. Power feedable.
Suspension Loop		H-LOOP		1 3/8" x 1 3/8" x 3"	3" electrical loop accepts chain hung fixtures up to 35lbs. Contains compartment for electrical connections.
15' Cord, Male Plug		HCORD	BK Black WT White	15'	Maximum capacity: 7A, 800W, 120V.
T-Bar Drop Ceiling Attachment		T-BARCLIP	Chrome	1 1/2" x 1 1/4"	Attaches track to T-bar drop ceilings. Use two for 2' or 4' tracks, three for 6' or 8' tracks.
Monopoint Canopy Adapter		HMP		5 3/8" x 5 3/8"	Mount a single track fixture to a junction box. When used with a low voltage track head the transformer box will protrude off of the face of the monopoint.
Canopy Plate		CP	BK Black BN Brushed Nickel WT White DB Dark Bronze	4 1/2" x 4 1/2"	Covers a standard 4" junction box. Use with any powerable connectors.
Floating Canopy Connector		HFC		4 1/2" x 4 1/2" x 1 1/2"	Connects to octagon box. Allows track to be powered anywhere along the length of the track.

H TRACK CURRENT LIMITER

WAC TRACK CURRENT LIMITERS ARE DESIGNED TO ADDRESS ENERGY ALLOWANCES

WITHOUT A CURRENT LIMITER

WATTAGE TOWARDS ENERGY ALLOWANCE

ASHRAE 90.1 AND IECC

The greater of either:

- The sum of the maximum rated wattage of the luminaires OR
- 30 watts per linear ft of track circuit

CALIFORNIA'S TITLE 24

The greater of either:

- The sum of the maximum rated wattage of the luminaires OR
- 45 watts per linear ft of track circuit

WITH A CURRENT LIMITER

WATTAGE TOWARDS ENERGY ALLOWANCE



ASHRAE 90.1 AND IECC

Wattage rating of the current limiter

CALIFORNIA'S TITLE 24

The greater of either:

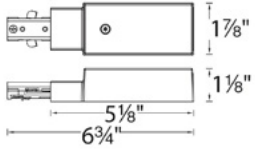
- Wattage rating of the current limiter OR
- 12.5 watts per linear foot of track circuit

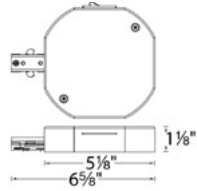

	Model	Circuit Breaker	Max Wattage	Finish	
 <p><i>Slim Single Live End</i></p> 	THL-HLES				
		1/2A	0.5A	60W	BK <i>Black</i> BN <i>Brushed Nickel</i> DB <i>Dark Bronze</i> WT <i>White</i>
		1A	1.0A	120W	
		2A	2.5A	300W	
		5A	5.0A	600W	
		7A	7.5A	900W	
 <p><i>Single Live End</i></p> 	THL-HLE				

Example: **THL-HLES-1A-BK**



LOW VOLTAGE
MR16 MULTIPLE SPOTS (1 WATT MINIMUM LOAD TRANSFORMERS)

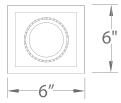

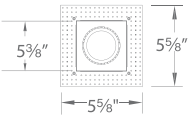
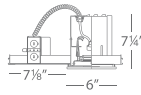
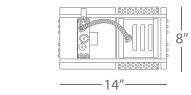

1 LIGHT

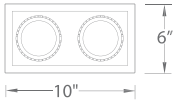
Trims (Order Housing Separately)	Model	Finish	Reflector/Trim	
 	1 Light Trim MT-116 Halogen MR16 sold separately MT-116LED LED MR16 included	WT/WT	White/White	
 	1 Light Invisible Trim™ MT-116TL Halogen MR16 sold separately MT-116LEDTL LED MR16 included	WT	White	
Low Voltage Multiple Spot Housings (Required)	Model	Type	Wattage	Rating
 	MT-116HS	1 Light	12V 50W MAX	Non-IC

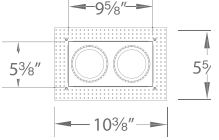
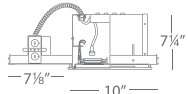
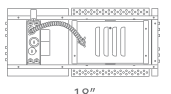
2 LIGHTS

Trims (Order Housing Separately)	Model	Finish	Reflector/Trim	
 	2 Light Trim MT-216 Halogen MR16 sold separately MT-216LED LED MR16 included	WT/WT	White/White	
 	2 Light Invisible Trim™ MT-216TL Halogen MR16 sold separately MT-216LEDTL LED MR16 included	WT	White	
Low Voltage Multiple Spot Housings (Required)	Model	Type	Wattage	Rating
 	MT-216HS	2 Lights	12V 50W MAX	Non-IC

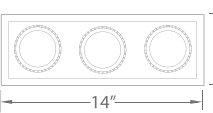
3 LIGHTS

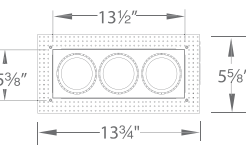
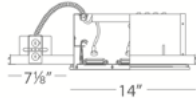
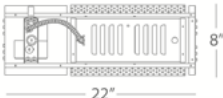
Trims (Order Housing Separately)	Model	Finish	Reflector/Trim	
 	3 Light Trim MT-316 Halogen MR16 sold separately MT-316LED LED MR16 included	WT/WT	White/White	
 	3 Light Invisible Trim™ MT-316TL Halogen MR16 sold separately MT-316LEDTL LED MR16 included	WT	White	
Low Voltage Multiple Spot Housings (Required)	Model	Type	Wattage	Rating
 	MT-316HS	3 Lights	12V 50W MAX	Non-IC

Non-IC housings require 3" of clearance from insulation on all sides. Recommended ELV dimming. Accommodates ceiling thickness of up to 1" for remodel & 3/4" for new construction.

LENSES, LOUVERS & LAMPS

Colored Lenses

LENS-16 Colored Lens	AMB Amber BLU Blue GRN Green RED Red
-----------------------------	---

Color

Lenses & Louvers

LENS-16-UVF UV Filter Lens	LENS-16-SPR Spread Lens
LENS-16-FR Frosted Lens	LENS-16-BEL Beam Elongating Lens
LENS-16-HCL Honeycomb Louver	

LED MR16 Lamp



MR16LED-BAB	BK Black WT White
--------------------	------------------------------------

Finish

2.5" LOW VOLTAGE

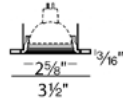

- 1 watt minimum load transformers
- Non-IC housings require 3" of clearance from insulation on all 3/4" sides
- Accommodates ceiling thickness of up to 3/4" for both remodel or new construction

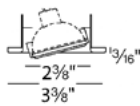
2.5" trims (Order Housing Separately)	Model	Finish	Baffle/Trim
 	HR-836 HR-836LED Metal Trim	BN CB WT	Brushed Nickel Copper Bronze White/White
 	HR-837 HR-837LED Gimbal Ring, 25° Adjustment from Vertical	BK BN CB WT	Black Brushed Nickel Copper Bronze White

2.5" Housings (Required)	Model	Input	Transformer	Output	Type
	HR-801	120V	Electronic	12V, 50W max 1W min	Remodel Non-IC
	HR-802	120V	Electronic	12V, 50W max 1W min	New Construction Non-IC

Non-IC housings require 3" of clearance from insulation on all sides.

4" LOW VOLTAGE MR16

Accommodates Most LED MR16 or Halogen MR16 Lamps

- Die-cast aluminum construction
- Steel spring clips secure trim to housing
- Abrasion resistant powder coat paint or plated metal finish

4" Downlight Trims (Order Housing Separately)	Model	Input	Finish	Description
 	<p>Square open reflector HR-D412-S Halogen MR16 sold separately HR-D412LED-S LED MR16 included</p>	MR16, 50W max	SC/BN SC/WT	Specular/Brushed Nickel Specular/White
 	<p>Round open reflector HR-D412 Halogen MR16 sold separately HR-D412LED LED MR16 included</p>	35° adjustment from vertical, MR16, 50W max		
 	<p>Step baffle HR-D411 LED Halogen MR16 sold separately HR-D411LED LED MR16 included</p>		WT/WT	White Baffle/White
 	<p>Gimbal ring HR-D417 Halogen MR16 sold separately HR-D417LED LED MR16 included</p>	25° adjustment from vertical, MR16, 50W max	BN WT	Brushed Nickel White
 	<p>Directional spot HR-D425 Halogen MR16 sold separately HR-D425LED LED MR16 included</p>	80° adjustment from vertical, MR16, 50W max	WT	White

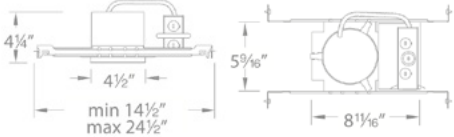
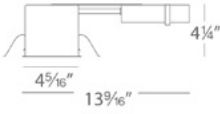
4" Low Voltage Housings (Required)	Model	Input	Transformer	Output	Type
	HR-8402E	120V	Electronic	12V, 50W max 1W min	New Construction Non-IC
	HR-8401E	120V	Electronic	12V, 50W max 1W min	Remodel Non-IC

Non-IC housings require 3" of clearance from insulation on all sides.
Accommodates ceiling thickness of up to 3/4" for remodel and new construction.



802

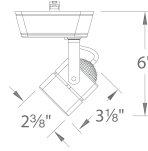

System	Model	Lamp (Voltage/Wattage)	Finish
HHT H	802LED	MR16 LED 12V 7W Included	BN Brushed Nickel
LHT L	802	MR16 12V 50W max (Sold Separately)	WT White
JHT J/J2			

Example: **LHT-802-WT**

809

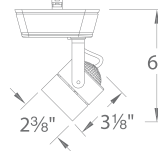

System	Model	Lamp (Voltage/Wattage)	Finish
HHT H	809LED	MR16 LED 12V 7W Included	BK Black
LHT L	809	MR16 12V 50W max (Sold Separately)	BN Brushed Nickel
JHT J/J2			WT White

Example: **LHT-809-BK**

180

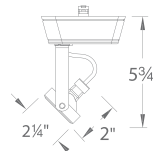

System	Model	Lamp (Voltage/Wattage)	Finish
HHT H	180LED	MR16 LED 12V 7W Included	BK Black
LHT L	180	MR16 12V 50W max (Sold Separately)	BN Brushed Nickel
JHT J/J2			WT White

Example: **LHT-180-BK**

LED LAMPS

	Model	Finish	Wattage	Color Temp	Input	Beam	CRI	Lumens	CBCP	Average Life	
	MR16	MR16LED-BAB-BK MR16LED-BAB-WT	Black White	7W	3000K	12V	35°	90	450	850	25,000 Hours

LENS ACCESSORIES

Amber **LENS-16-AMB**

Blue **LENS-16-BLU**
Green **LENS-16-GRN**

Red **LENS-16-RED**
Frosted **LENS-16-FR**

UV Filter **LENS-16-UVF**
Spread **LENS-16-SPR**

Beam Elongating **LENS-16-BEL**
Honeycomb Louver **LENS-16-HCL**

MR16 TRACK LUMINAIRES LED & HALOGEN (1 WATT MINIMUM LOAD)



007

System	Model	Lamp (Voltage/Wattage)	Finish
HHT H	007LED	MR16 LED 12V 7W included	BK Black
LHT L	007	MR16 12V 50W max (Sold Separately)	WT White
JHT J/J2			

Example: **JHT-007-BK** Clear lens included

Framing Projector Accessory		008FP-BK 008FP-WT	Black White
-----------------------------	---	------------------------------------	----------------



808

System	Model	Lamp (Voltage/Wattage)	Finish
HHT H	808LED	MR16 LED 12V 7W included	BK Black
LHT L	808	MR16 12V 50W max (Sold Separately)	WT White
JHT J/J2			

Example: **JHT-808LED-BK** Clear lens included

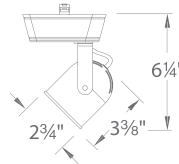

Available in Monopoint

DUNE

System	Model	Lamp (Voltage/Wattage)	Finish
HHT H	826LED	MR16 LED 12V 7W included	BK Black
LHT L	826	MR16 12V 50W max (Sold Separately)	WT White
JHT J/J2			

Example: **HHT-826-WT** Clear lens included

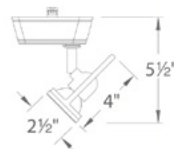

LED LAMPS

	Model	Finish	Wattage	Color Temp	Input	Beam	CRI	Lumens	CBCP	Average Life	
	MR16	MR16LED-BAB-BK MR16LED-BAB-WT	Black White	7W	3000K	12V	35°	90	450	850	25,000 Hours

LENS ACCESSORIES

Amber LENS-16-AMB	Blue LENS-16-BLU Green LENS-16-GRN	Red LENS-16-RED Frosted LENS-16-FR	UV Filter LENS-16-UVF Spread LENS-16-SPR	Beam Elongating LENS-16-BEL Honeycomb Louver LENS-16-HCL
--------------------------	---	---	---	---

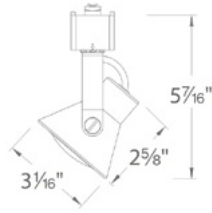

System	Model	Lamp (Voltage/Wattage)	Finish
HTK	<i>H</i>	<i>GU10LED 7W included</i>	BK <i>Black</i>
LTK	<i>L</i>		DB* <i>Dark Bronze</i>
JTK	<i>J/J2</i>		WT <i>White</i>

Example: **LTK-103LED-BK**

*DB Finish only available in HTK

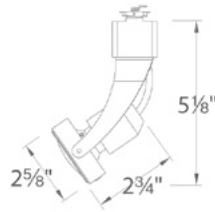

System	Model	Lamp (Voltage/Wattage)	Finish
HTK	<i>H</i>	<i>GU10LED 7W included</i>	BK <i>Black</i>
LTK	<i>L</i>		WT <i>White</i>
JTK	<i>J/J2</i>		

Example: **LTK-104LED-WT**

LED LAMPS

	Model	Finish	Power	Color Temp	Voltage	Beam	CRI	Lumens	CBCP	Average Life	
	<i>GU10</i>	GU10LED-BAB-BK GU10LED-BAB-WT	<i>Black</i> <i>White</i>	<i>7W</i>	<i>3000K</i>	<i>12V</i>	<i>35°</i>	<i>90</i>	<i>470</i>	<i>850</i>	<i>25,000 Hours</i>

PAR & BR TRACK LUMINAIRES LED & HALOGEN



720, 730



System	Model	Lamp (Voltage/Wattage)	Finish
HTK	<i>H</i>	720	BK Black WT White
LTK	<i>L</i>	730	
JTK	<i>J/J2</i>		

Example: **HTK-730-WT**

Order lamp separately

763, 764, 765

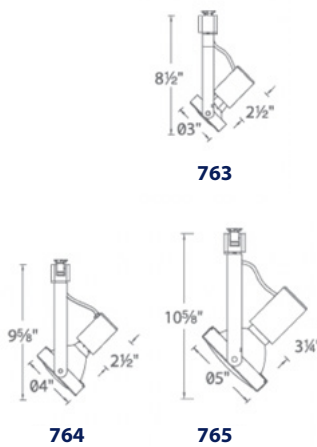

System	Model	Lamp (Voltage/Wattage)	Finish
HTK	<i>H</i>	763	BK Black WT White
LTK	<i>L</i>	764	
JTK	<i>J/J2</i>	765	

Example: **HTK-763-WT**

Order lamp separately



178 UNIVERSAL MEDIUM BASE

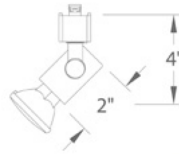

System	Model	Lamp (Voltage/Wattage)	Finish
HTK H	178	BR20/30/40. PAR20/30/38 120V 100W Max	BK Black
LTK L			BN Brushed Nickel
JTK J/J2			WT White

Example: **LTK-178-BN**

Order lamp separately

BARN DOOR (ORDER SEPARATELY)

PAR20BD	BK Black	
PAR30BD	BN Brushed Nickel	
PAR38BD	WT White	

725

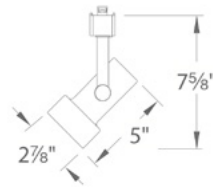

System	Model	Lamp (Voltage/Wattage)	Finish
HTK H	725	PAR20 / BR20 50W max	BK Black
LTK L			WT White
JTK J/J2			

Example: **HTK-725-WT**

Order lamp separately



704

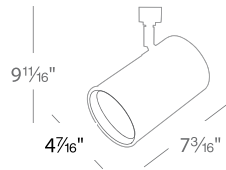

System		Model	Lamp (Voltage/Wattage)	Finish
HTK	<i>H</i>	704	120V BR30 and PAR30 75W Max	BK <i>Black</i>
LTK	<i>L</i>			WT <i>White</i>
JTK	<i>J/J2</i>			

Example: **LTK-704-WT**

Order lamp separately

703

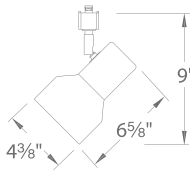

System		Model	Lamp (Voltage/Wattage)	Finish
HTK	<i>H</i>	703	BR30 and PAR30 75W Max	BK <i>Black</i>
LTK	<i>L</i>			WT <i>White</i>
JTK	<i>J/J2</i>			

Example: **HTK-703-BK**

Order lamp separately

INDEX

120/277V 48

2.5" LOW VOLTAGE 58

4" LOW VOLTAGE 59

ACCESSORIES 55

ATLANTIS FLUSH 7

ATLANTIS..... 6

BAR LIGHT 12

BLAZE 6" 27

BLO, FLO, GLO 32

BULLET 7010 52

CHARGE 53

CUBIX & CYLINDER 44

CYLINDER 45

DISC 2" 4

DISC 31

FUSE 42

GEMINI 8

GU10 TRACK LUMINAIRES 62

H TRACK CURRENT LIMITER 56

H TRACK SYSTEM 54

I CAN'T BELIEVE IT'S NOT RECESSED 30

ION 2" 25

LINK 43

LITHIUM EM BATTERY BACKUP 29

LOTOS 2" ADJUSTABLE 18

LOTOS 4 & 6" DOWNLIGHT 20

LOTOS FIRE RATED 22

LOW VOLTAGE LED/MR16 MULTIPLE SPOTS 51

LOW VOLTAGE MR16 MULTIPLE SPOTS 57

METRO 40

MINI PUCK 14

MR16 TRACK LUMINAIRES 60

PAR AND BR TRACK LUMINAIRES 63

PATRIOT 24

POP-IN 4" 26

POWER SUPPLY 9

PUCK LIGHT 16

REMI 36

ROUND & SQUARE 34

SOLO 50

TURBO 38

VEGA OUTDOOR SCONCE 46

VUE 47

Headquarters

Tel: 800.526.2588

Fax: 800.526.2585

44 Harbor Park Dr
Port Washington, NY 11050

South East Manufacturing Facility

1600 Distribution Ct
Lithia Springs, GA 30122

Central Manufacturing Facility

1700 South J Elmer Freeway
Suite 100
Cedar Hill, TX 75104

West Manufacturing Facility

1750 S Archibald Ave
Ontario, CA 91761

Consult our manufacturing facility to take advantage of our custom capabilities
in large quantities. For up to date product specifications and assistance please

visit **wacighting.com**

or call

1-800-526-2588

