

COLORSCAPING®

BY WAC ARTFUL ILLUMINATION





ARTFUL ILLUMINATION FROM WAC

Live your life in color and transform your outdoor space with Colorscaping by WAC.

This patent-pending smart lighting, power and control system is designed and engineered to illuminate your landscape. Create bold, personalized lighting experiences with tunable white light to complement your garden and architecture, or select from an endless amount of custom colors for holiday displays, entertainment and special events.

Colorscaping is easy to install, simple to add to existing systems and easily controlled by the WAC App.

INFINITE FLEXIBILITY

Using only two-wire conventional landscape wiring, all fixtures can be individually controlled to change both brightness and color.

FULL COLOR SPECTRUM TECHNOLOGY

From subtle tones to bold, vivid hues, pure white light from warm 2700K to cool 6500K and millions of colors, you can create just the right mood for each outdoor setting with only the touch of a button.

CONNECT VIA APP

The MyWAC app lets you choose custom colors and create scenes, zones and groups via Wi-Fi or wired ethernet. Schedule your luminaires according to dates/times, special events and dynamic patterns such as sunrise and sunset.

LEGACY PROOF

Connect your existing landscape fixtures to the Colorscaping transformer to make them smart. Control and automate legacy lighting circuits as a single group in the MyWAC app. They can be added to schedules or managed by the app or other supported control systems with brightness control over dimmable fixtures.

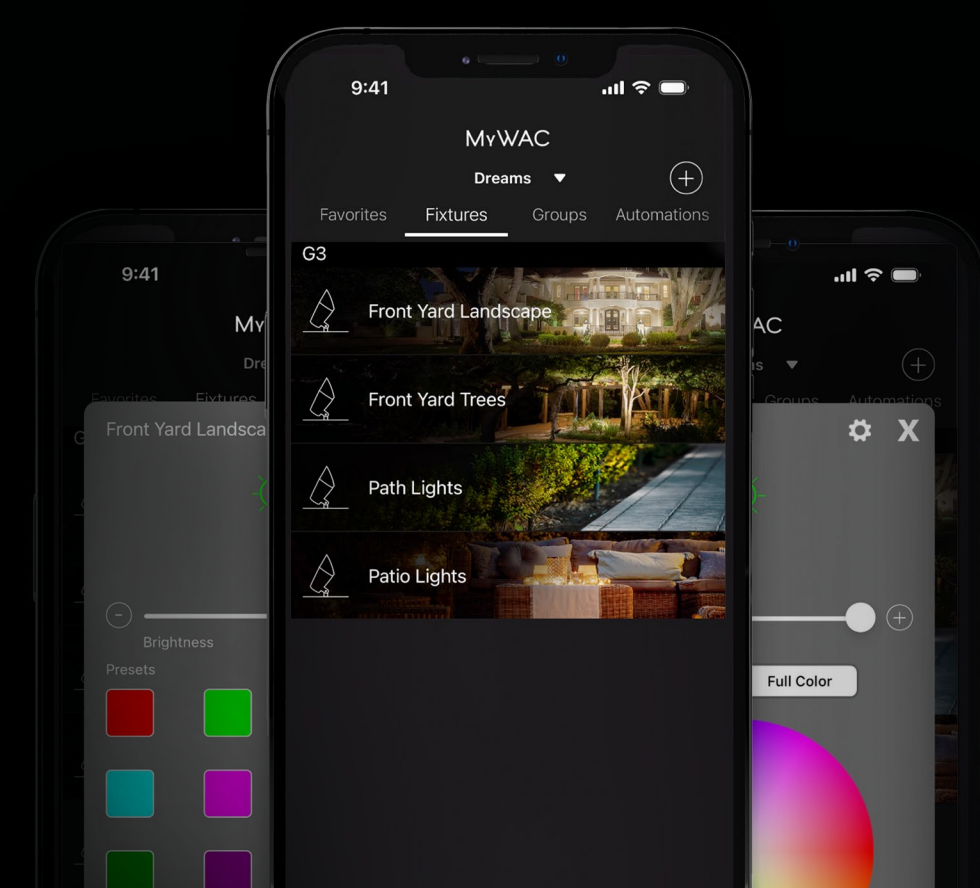



2700K

6500K



TUNABLE WHITE FULL COLOR SPECTRUM TECHNOLOGY

Colorscaping features advanced RGBWW technology, which uses both warm white and cool white LEDs to offer a wider range of color temperature options (2700K- 6500K), providing greater control over the ambiance of an outdoor space for different occasions, seasons or moods.

Colorscaping not only provides unlimited color to your outdoor space, but, most importantly, allows you to select the best white light to dramatically illuminate trees, shrubbery, walls, patios, water features and other landscape elements to create a stunning and dynamic outdoor environment.

When you're the artist, color temperatures can be blended around the property to create maximum impact.

TECHNIQUES TO ILLUMINATE YOUR LANDSCAPE WITH COLORSCAPING

- Tune white light to make evergreen trees greener and Japanese maples redder
- Position luminaires in tall trees to cast a moonlighting effect on the ground and watch shadows change with the wind
- For outdoor entertaining and nighttime activities, use warm white light to deliver an inviting vibe and relaxing atmosphere
- For safety, security, or simply a stunning look, use cooler color temperatures to increase the visibility of your outdoor space
- Create five or more different scenes in one evening, especially during the holiday seasons
- Spotlight distinctive vegetation in unique colors to complement foliage changes
- Make a white house "whiter" by lighting it to stand out against other homes
- Schedule beautiful sunrise and sunset scenes to enhance the warmth and beauty of your home

INNOVATIVE TRANSFORMER CONTROL PANEL

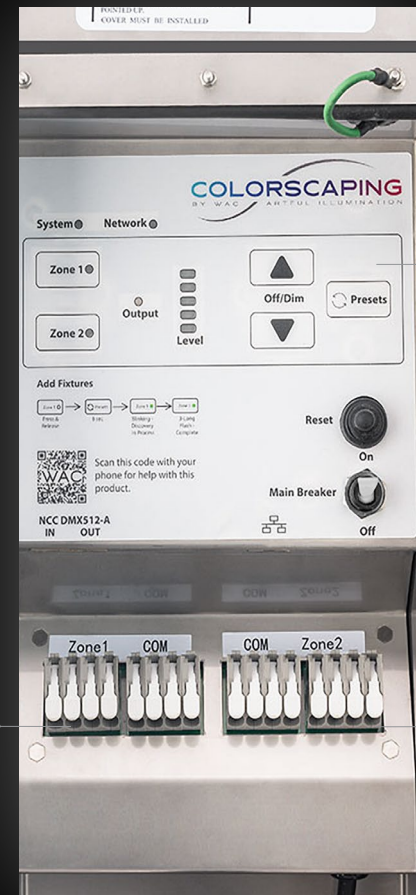

EASY FIXTURE DISCOVERY

Our innovative and smart transformer allows you to quickly install and test control of luminaires. Cycle through the presets of tunable whites and primary colors.

Offered with 150-watt and 300-watt capacities, the smart transformer enables robust wiring, as well as surge protection against power surges and voltage spikes.

The transformer eliminates any confusion in the field with a proprietary discovery process—identifying each fixture and location so the luminaires can be added, changed, and/or paired with the appropriate transformer with the push of a button.

We provide multiple methods to control Colorscaping using Wi-Fi, wired ethernet or DMX.

Operate each of the Colorscaping luminaires independently, or as a part of a group or your favorite scene.

Onboard Control Panel

Control legacy / white light products on the same transformer with on/off & dimming control

Control Colorscaping product using standard 2-conductor landscape wiring

Smart Magnetic Transformer - PATENT PENDING

Stainless Steel, 15VAC output, IP65 rated, UL 1838 listed
See transformer spec sheet for details and its accessories

Ordering Chart

150W Max 300W Max

8150CS-TRN-SS 8300CS-TRN-SS

TECHNOLOGY

INDIVIDUAL CONTROL

Operate each of the Colorscaping luminaires independently, or as a part of a group or your favorite scene. User presets allow you to change your lighting scheme on the fly.

SCHEDULE

Be flexible. Keep it simple with a 7-day weekly calendar or be different each day with a 365-day calendar that also adjusts for daylight saving time.

COMMISSION

Commission your lighting scenes with our exclusive MyWAC app. Use it to easily adjust color and intensity from anywhere in the world.

INTEGRATION

Our DMX controller integrates with popular control systems through DMX512-A for changing color and color temperature adjustment, plus On/Off/Dim functions. Higher-level integrations will be made available as these systems update, and new functions will be made available through future over-the-air updates.

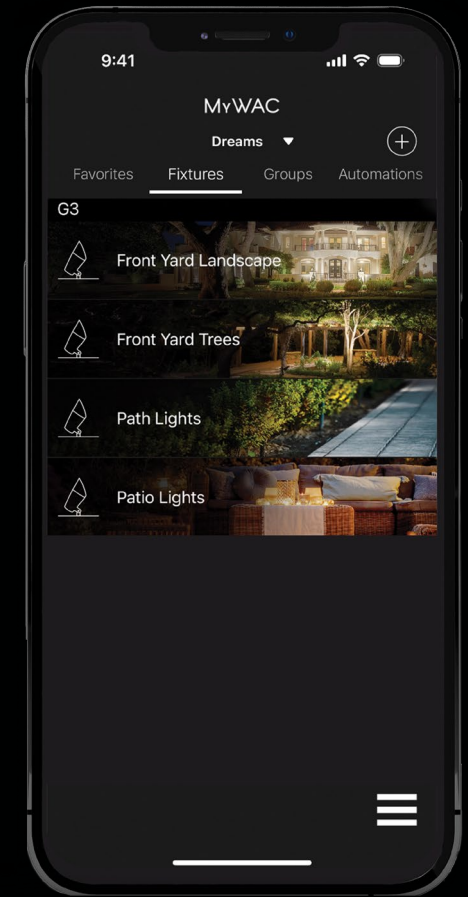

WALLSTATION SCENE DIMMING WALLSTATION

Featuring four pre-configured scenes button, a dedicated off button, and dimming capability, the wall station enables essential lighting control for an area. The wall station is fully customizable via the MyWAC app.

Model	Finish	Input	L	W	H	Description
LED-WCT-WT	White	120-230VAC	4 5/8"	2 3/4"	1 5/8"	Easy installation and a simple way to control lighting. The sleek, aesthetic designs are suitable for all interior locations. Multi-scene selection, Up and Down brightness dimming control, dedicated On/Off button. Suitable for standard single NEMA wall box. Setup and configuration via MyWAC app, no physical adjustment needed. Wi-Fi communication is required.



UL US
1838 listed

IP66

PATENT
PENDING

ACCENT

- Adjustable beam angle from 20° - 60°
- Fixtures can be individually controlled in addition to grouping, scheduling and automations
- Full white light tunability from 2700K to 6500K
- Fixtures can generate an endless number of colors



Ordering Chart

15V	Fixture Finish Options:
5811-CS	BK Black on Aluminum
	BZ Bronze on Aluminum
	BBR Bronze on Brass
Example: 5811-CSBZ	

Input	Power	Brightness	Beam Angle	CRI	Rated Life	
15VAC	15W / 16VA	White	570lm	20° - 60°	85	50,000 hours
		Red	185lm			
		Green	385lm			
		Blue	90lm			

Colorscaping Smart Transformer is required

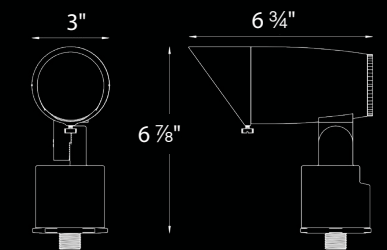

Accessories

6" Long Shroud	Accent Snoot	Mounting Stake	Surface Mount Flange/Stake	Guardian Mount	Gutter Mount Bracket
5010-LSHR-BK 5010-LSHR-BZ 5010-LSHR-BBR	5010-SNOOT-BK 5010-SNOOT-BZ 5010-SNOOT-BBR	9000-ST9-BZ	5000-SCP-BK 5000-SCP-BZ 5000-SCP-BBR	9000-SP9-BZ	5000-GM-BK 5000-GM-BZ

9" Mounting stake, detachable shroud, 6' lead wire and direct burial gel filled wire nuts included

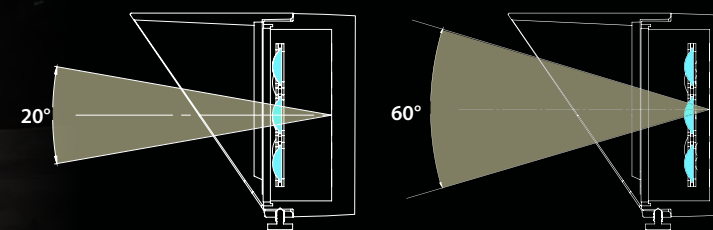

Tree Mount Junction Box	Extension Rods	Rod L-Coupler
5000-TCP-BK 5000-TCP-BZ	5000-X04-BZ,BK,BBR 5000-X08-BZ,BK,BBR 5000-X12-BZ,BK,BBR 5000-X18-BZ,BK,BBR 5000-X24-BZ,BK,BBR	5000-LCO-BK 5000-LCO-BZ

See Accessories page for more detail

ACCENT



UL US
1838 listed

IP66

PATENT
PENDING

GRAND ACCENT

- Adjustable beam angle from 20° - 70°
- Fixtures can be individually controlled in addition to grouping, scheduling and automations
- Full white light tunability from 2700K to 6500K
- Fixtures can generate an endless number of colors



Ordering Chart

15V	Fixture Finish Options:
5812-CS	BK Black on Aluminum BZ Bronze on Aluminum BBR Bronze on Brass
Example: 5812-CSBZ	

Input	Power	Brightness	Beam Angle	CRI	Rated Life
15VAC	24W / 25VA	White 1120lm Red 375lm Green 735lm Blue 170lm	20° - 70°	85	50,000 hours

Colorscaping Smart Transformer is required

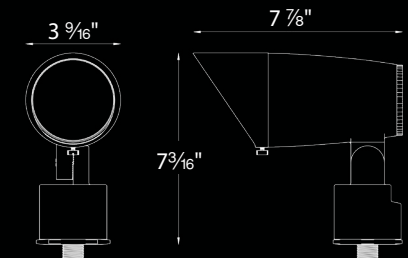

Accessories

5" Long Shroud	Grand Accent Snoot	Mounting Stake	Surface Mount Flange/Stake	Guardian Mount	Gutter Mount Bracket
5211-LSHR-BK 5211-LSHR-BZ 5211-LSHR-BBR	5211-SNOOT-BK 5211-SNOOT-BZ 5211-SNOOT-BBR	9000-ST9-BZ	5000-SCP-BK 5000-SCP-BZ 5000-SCP-BBR	9000-SP9-BZ	5000-GM-BK 5000-GM-BZ

9" Mounting stake, detachable shroud, 6' lead wire and direct burial gel filled wire nuts included

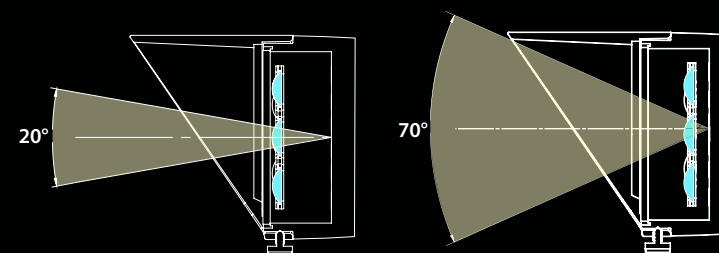

Tree Mount Junction Box	Extension Rods	Rod L-Coupler
5000-TCP-BK 5000-TCP-BZ	5000-X04-BZ, BK, BBR 5000-X08-BZ, BK, BBR 5000-X12-BZ, BK, BBR 5000-X18-BZ, BK, BBR 5000-X24-BZ, BK, BBR	5000-LCO-BK 5000-LCO-BZ

See Accessories page for more detail

GRAND ACCENT



UL US
1838 listed

IP66

PATENT
PENDING

POWER ACCENT

- Fixed lens beam angles for more power
- Lens angle options: 15°, 25°, 45° and 60° included
- Fixtures can be individually controlled in addition to grouping, scheduling and automations
- Full white light tunability from 2700K to 6500K
- Fixtures can generate an endless number of colors



Ordering Chart

15V	Fixture Finish Options:
5813-CS	BK Black on Aluminum
	BZ Bronze on Aluminum
	BBR Bronze on Brass
Example: 5813-CSBZ	

Input	Power	Brightness	Beam Angle	CRI	Rated Life	
15VAC	14W / 15VA	White	1125lm	15°, 25°, 45°, 60°	85	50,000 hours
		Red	700lm			
		Green	1160lm			
		Blue	170lm			

Colorscape Smart Transformer is required

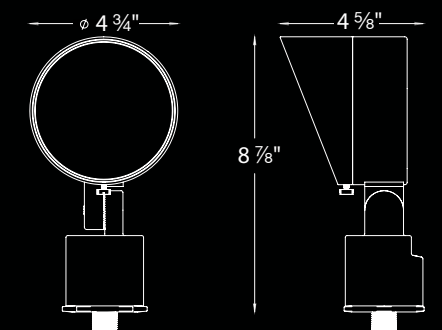

Accessories

Mounting Stake	Surface Mount Flange/Stake	Guardian Mount	Gutter Mount Bracket	Tree Mount Junction Box	Extension Rods	Rod L-Coupler
9000-ST9-BZ	5000-SCP-BK 5000-SCP-BZ 5000-SCP-BBR	9000-SP9-BZ	5000-GM-BK 5000-GM-BZ	5000-TCP-BK 5000-TCP-BZ	5000-X04-BZ,BK,BBR 5000-X08-BZ,BK,BBR 5000-X12-BZ,BK,BBR 5000-X18-BZ,BK,BBR 5000-X24-BZ,BK,BBR	5000-LCO-BK 5000-LCO-BZ

9" Mounting stake, detachable shroud, 6' lead wire and direct burial gel filled wire nuts included

See Accessories page for more detail

POWER ACCENT



UL US
1838 listed

IP66

PATENT
PENDING

WALL WASH

- A uniform wide distribution wall wash from a small form factor
- Fixtures can be individually controlled in addition to grouping, scheduling and automations
- Full white light tunability from 2700K to 6500K
- Fixtures can generate an endless number of colors



Ordering Chart

15V	Fixture Finish Options:
5821-CS	BK Black on Aluminum BZ Bronze on Aluminum BBR Bronze on Brass
Example: 5821-CSBZ	

Input	Power	Brightness	Beam Angle	CRI	Rated Life	
15VAC	16W / 24.5VA	White	1015lm	50° x 80°	85	50,000 hours
		Red	360lm			
		Green	680lm			
		Blue	140lm			

Colorscaping Smart Transformer is required

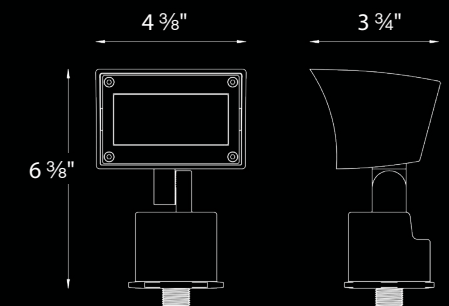

Accessories

Mounting Stake	Surface Mount Flange/Stake	Guardian Mount	Gutter Mount Bracket
9000-ST9-BZ 9000-ST14-BZ	5000-SCP-BK 5000-SCP-BZ 5000-SCP-BBR	9000-SP9-BZ	5000-GM-BK 5000-GM-BZ

9" Mounting stake, 6' lead wire and direct burial gel filled wire nuts included

Tree Mount Junction Box	Extension Rods	Rod L-Coupler
5000-TCP-BK 5000-TCP-BZ	5000-X04-BZ,BK,BBR 5000-X08-BZ,BK,BBR 5000-X12-BZ,BK,BBR 5000-X18-BZ,BK,BBR 5000-X24-BZ,BK,BBR	5000-LCO-BK 5000-LCO-BZ

See Accessories page for more detail

WALL WASH



cUL US
1838 listed

IP67

PATENT
PENDING

IN-GROUND

- Adjustable beam angle from 20° - 70°
- Directional aim with +/- 20° Tilt
- Fixtures can be individually controlled in addition to grouping, scheduling and automations
- Full white light tunability from 2700K to 6500K
- Fixtures can generate an endless number of colors



Ordering Chart

15V

Fixture Finish Options:

5831-CS

BZ
BBR

Bronze on Aluminum
Bronze on Brass

Example: **5831-CSBZ**

Input	Power	Brightness	Beam Angle	CRI	Rated Life	
15VAC	23W / 24VA	White	1020lm	20° - 70°	85	50,000 hours
		Red	330lm			
		Green	720lm			
		Blue	175lm			

Colorscaping Smart Transformer is required

Accessories

Rock Guard

Concrete Pour Kit

5830-GRD-BZ
5830-GRD-BBR

5830-PIP-PVC

See Accessories page for more detail

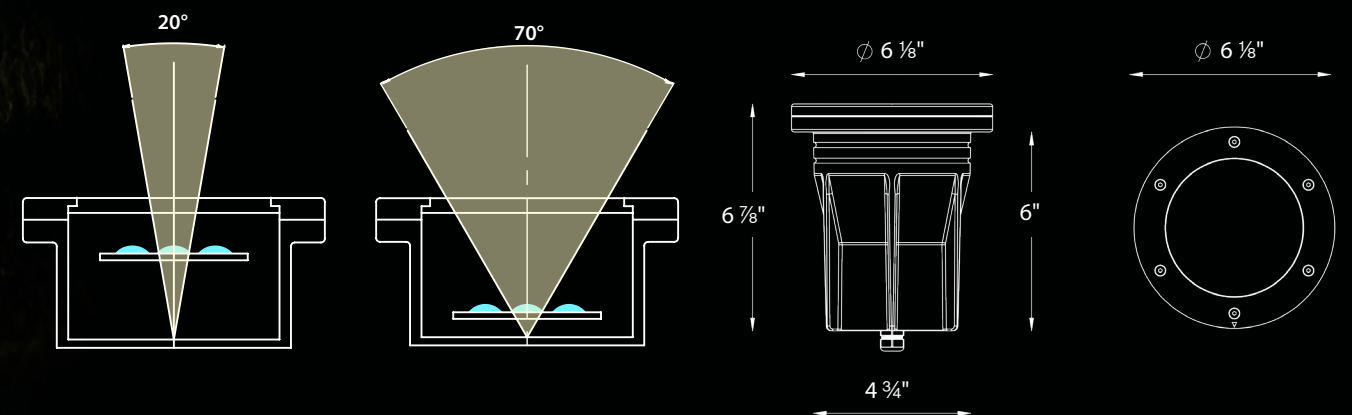

IN-GROUND



PATENT
PENDING

TIKI

- Sturdy center mount design works well in applications where area illumination is desired
- Fixtures can be individually controlled in addition to grouping, scheduling and automations
- Full white light tunability from 2700K to 6500K
- Fixtures can generate an endless number of colors

Ordering Chart

15V	Fixture Finish Options:
6841-CS	BK Black on Aluminum BZ Bronze on Aluminum BBR Bronze on Brass

Example: **6841-CSBZ**

Input	Power	Brightness	CRI	Rated Life	
15VAC	12W / 18.5VA	White	675lm	85	50,000 hours
		Red	230lm		
		Green	450lm		
		Blue	100lm		

Colorscape Smart Transformer is required

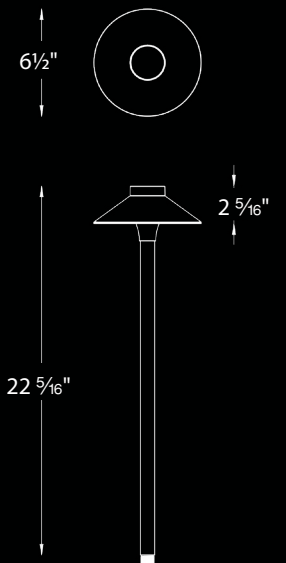
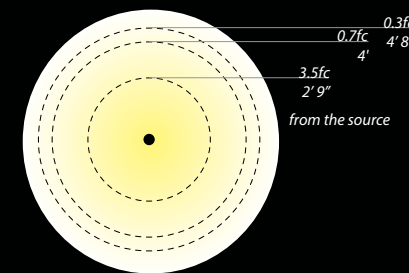

Accessories

9" Mounting Stake	14" Mounting Stake	Surface Mount Flange/Stake	Guardian Mount
9000-ST9-BZ	9000-ST14-BZ	5000-SCP-BK 5000-SCP-BZ 5000-SCP-BBR	9000-SP9-BZ

9" Mounting stake, detachable shroud, 6' lead wire and direct burial gel filled wire nuts included
See Accessories page for more detail



TIKI



UL US
1838 listed

IP66

PATENT
PENDING

LEDGE

- Sleek linear design blends seamlessly into pathways while providing soft, even illumination
- Fixtures can be individually controlled in addition to grouping, scheduling and automations
- Full white light tunability from 2700K to 6500K
- Fixtures can generate an endless number of colors

Ordering Chart

15V	Fixture Finish Options:	
6881-CS	BK	Black on Aluminum
	BZ	Bronze on Aluminum

Example: **6881-CSBZ**

Input	Power	Brightness	CRI	Rated Life	
15VAC	7W / 10VA	White	230lm	85	50,000 hours
		Red	80lm		
		Green	150lm		
		Blue	30lm		

Colorscaping Smart Transformer is required

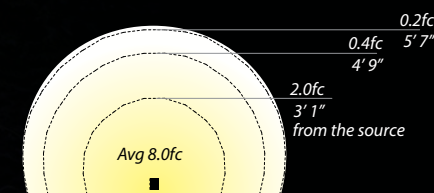

Accessories

9" Mounting Stake	14" Mounting Stake	Surface Mount Flange/Stake	Guardian Mount
9000-ST9-BZ	9000-ST14-BZ	5000-SCP-BK 5000-SCP-BZ 5000-SCP-BBR	9000-SP9-BZ

14" Mounting stake, detachable shroud, 6' lead wire and direct burial gel filled wire nuts included
See Accessories page for more detail

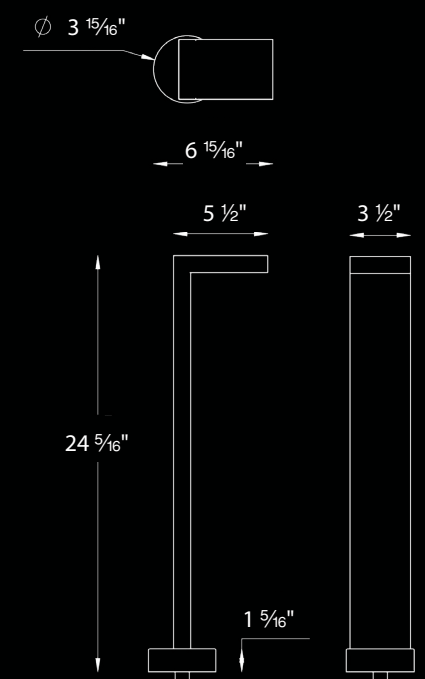
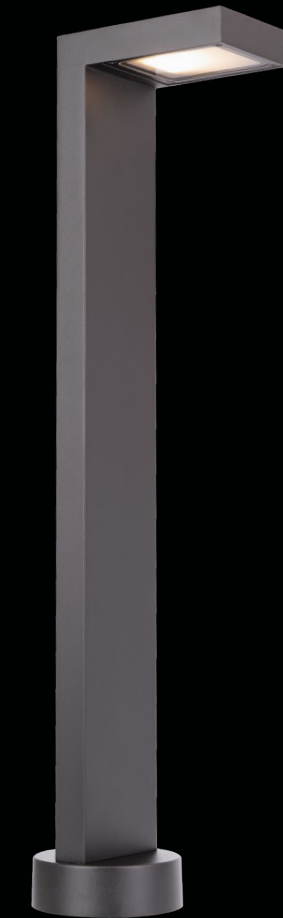

LEDGE



BALANCE

UL US
1838 listed

IP66

PATENT
PENDING

BALANCE

- Sleek linear design blends seamlessly into pathways while providing soft, even illumination
- Fixtures can be individually controlled in addition to grouping, scheduling and automations
- Full white light tunability from 2700K to 6500K
- Fixtures can generate an endless number of colors

Ordering Chart

15V	Fixture Finish Options:	
6861-CS	BK	Black on Aluminum
	BZ	Bronze on Aluminum
Example: 6861-CSBZ		

Input	Power	Brightness	CRI	Rated Life	
15VAC	7W / 10VA	White	310lm	85	50,000 hours
		Red	110lm		
		Green	205lm		
		Blue	45lm		

Colorscaping Smart Transformer is required

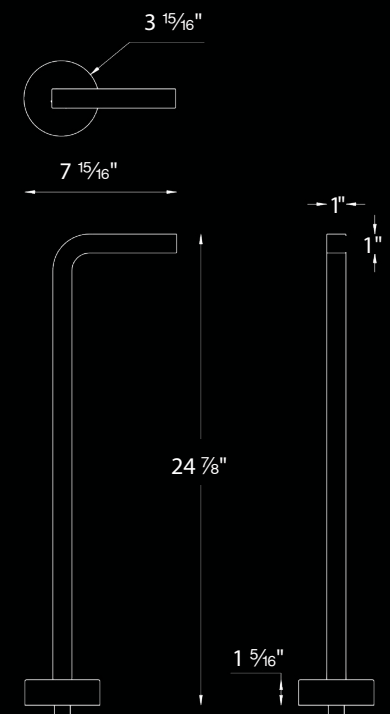
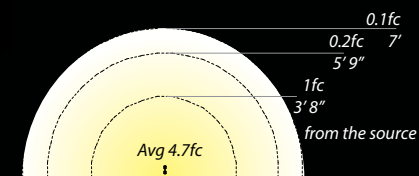

Accessories

9" Mounting Stake	14" Mounting Stake	Surface Mount Flange/Stake	Guardian Mount
9000-ST9-BZ	9000-ST14-BZ	5000-SCP-BK 5000-SCP-BZ 5000-SCP-BBR	9000-SP9-BZ

9" Mounting stake, detachable shroud, 6' lead wire and direct burial gel filled wire nuts included
See Accessories page for more detail



PATENT
PENDING

CYLINDER WALL MOUNT

UP AND DOWN LIGHT

- Fixtures can be individually controlled in addition to grouping, scheduling and automations
- Select up light, down light or both via MyWAC app
- Full white light tunability from 2700K to 6500K
- Fixtures can generate an endless number of colors



Ordering Chart

15V

Fixture Finish Options:

3911-CS

- BK** Black on Aluminum
- BZ** Bronze on Aluminum
- WT** White on Aluminum

Example: **3911-CSBZ**

Input	Power	Brightness	Beam Angle	CRI	Rated Life	
15VAC	7W / 10VA	White	160lm	80°	85	50,000 hours
		Red	60lm			
		Green	150lm			
		Blue	30lm			

Colorsclaping Smart Transformer is required
10' lead wire and gel filled wire nuts included

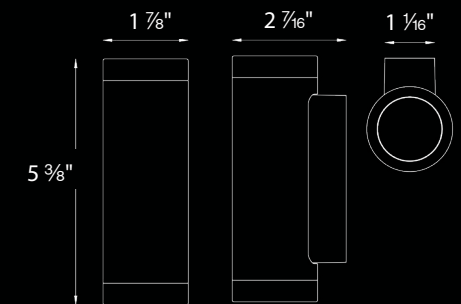

CYLINDER WALL MOUNT



HARDSCAPE

UL US
1838 listed

IP66

PATENT
PENDING

HARDSCAPE

- Quick Release connection at fixture to easily detach from capstone bracket after installation
- Fixtures can be grouped and controlled together
- Fixtures contain discrete warm, and cool white LEDs for full tunability
- Fixtures can generate an endless number of colors



Ordering Chart

15V	Size	Fixture Finish Options:	
7872-CS	7"	BK	Black on Aluminum
7822-CS	12"	BZ	Bronze on Aluminum
		BBR	Bronze on Brass

Example: **7872-CSBZ**

	Input	Power	Brightness	Beam Angle	CRI	Rated Life
7 INCH	15VAC	7W / 10VA	White	400lm	100°	85
			Red	125lm		
			Green	270lm		
			Blue	60lm		
12 INCH	15VAC	15W / 22VA	White	825lm	100°	85
			Red	275lm		
			Green	550lm		
			Blue	120lm		

6' lead wire and direct burial gel filled wire nuts included
Colorscaping Smart Transformer is required

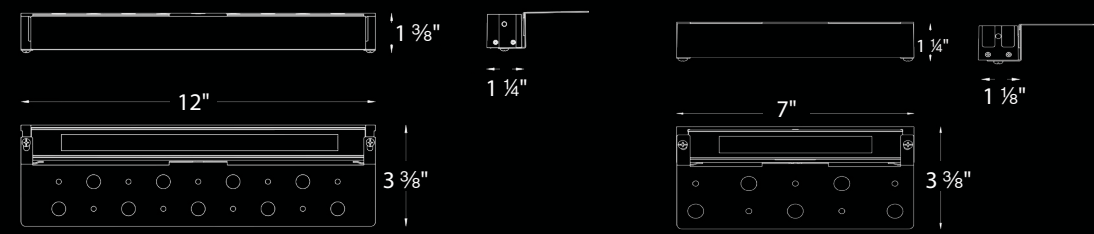

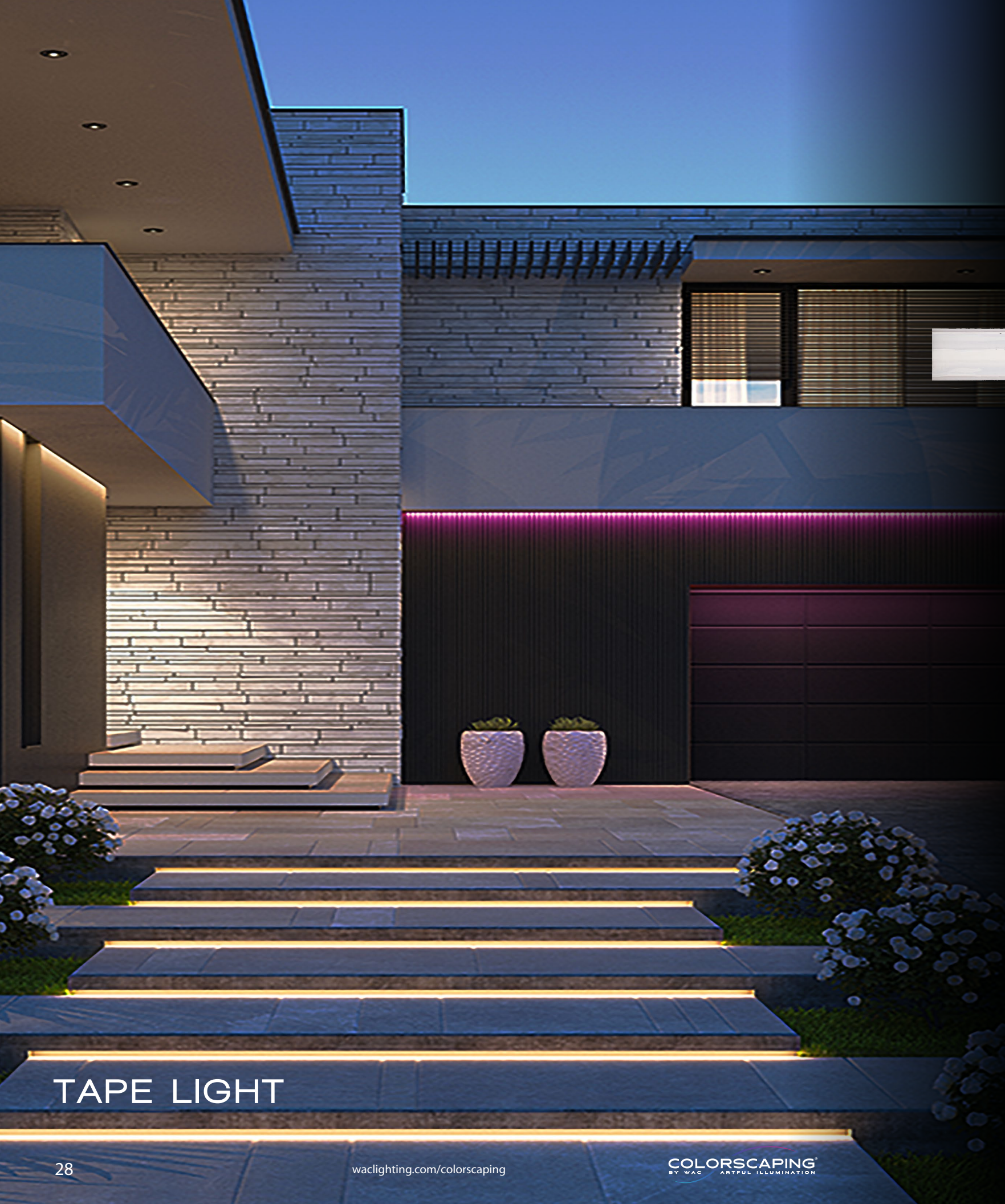





TAPE LIGHT

- Weatherproof resilience for all conditions
- Advanced IP66 rated protective silicone jacket
- Vivid full color spectrum
- Precisely tunable white light for perfect ambiance
- High-Definition vivid white illumination with superior CRI
- Effortless connectivity: plug and play connectors offer easy integration and hassle-free installation
- Comprehensive smart home system compatibility
- Cuttable every 2 inches and sealable with end caps for custom lengths

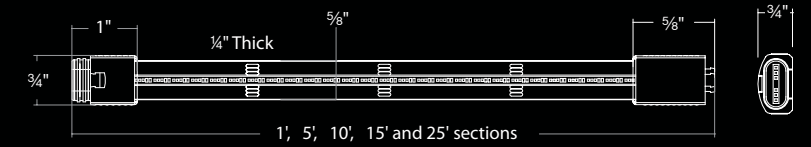

Ordering Chart

24VDC	Fixture Finish:	Input	Power	Lm/ft	Color Temp	CRI	Rated Life
01 1 foot	CC White	24VDC	3.57W/FT * 5.5W/FT **	White	100 lm/ft	R/G/B	90 50,000 hours
05 5 feet				Red	9.7 lm/ft	2700K-5000K	
T24-OD1 10 10 feet				Green	34 lm/ft		
15 15 feet				Blue	10.4 lm/ft		
25 25 feet							

Example: **T24-OD1-01-CC**

*Mobile MyWAC App/Wallstation Control

**DMX Control



Controller	Input	Output	IP
915CS-CTR-WT	9-15VAC 11W/17VA	24VDC/96W MAX	IP65

A controller is required for the system to work

Example: **915CS-CTR-WT**

Total Length of Lead Wire Between Controller & Tape	Max Run Tape Length/Control Through Colorscapeing Transformer & MyWAC App
3ft	25ft
6ft	25ft
9ft	25ft
12ft	22ft
18ft	15ft
24ft	12ft
30ft	10ft
40ft	7ft

Calculation based on 6' lead wire between Power Supply and controller

System Configuration

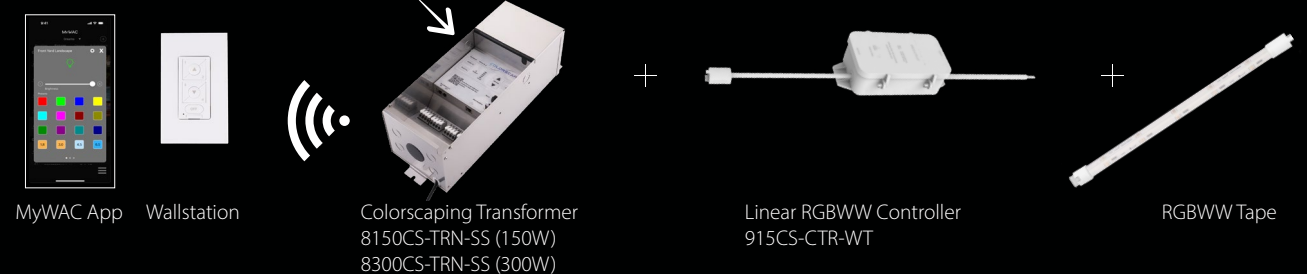















Accessories

Joiner Cable	Y Connector	X Connector	End Cap	5' Clear Channel	Surface Mounting Clip	Edge Mounting Clip	Underside Mounting Clip
T24-OD-IC6-WT T24-OD-IC12-WT T24-OD-IC72-WT T24-OD-IC120-WT	T24-OD-Y-WT	T24-OD-X-WT	T24-OD-EC-WT	T24-OD-CH5-CL	T24-OD-C1-WT	T24-OD-C2-WT	T24-OD-C3-WT





TAPE LIGHT

ACCESSORIES

MOUNTING + GLARE CONTROL

9" Mounting Stake		9000-ST9-BZ	Bronze	Durable PC stake
14" Mounting Stake		9000-ST14-BZ	Bronze	Durable PC stake
Surface Mount Flange/Stake		5000-SCP-BK 5000-SCP-BZ 5000-SCP-BBR	Black on Aluminum Bronze on Aluminum Bronze on Brass	Includes three 7 inch threaded stainless steel stabilizing pins for ground mounting or surface mounts with four screws or over a junction box
Guardian Mount		9000-SP9-BZ	Stainless Steel	Heavy duty stainless steel spike to position fixture
Grand Accent Snoot		5211-SNOOT-BK 5211-SNOOT-BZ 5211-SNOOT-BBR	Black on Aluminum Bronze on Aluminum Bronze on Brass	Shields lamp and reduces glare
Accent Snoot		5010-SNOOT-BK 5010-SNOOT-BZ 5010-SNOOT-BBR	Black on Aluminum Bronze on Aluminum Bronze on Brass	Shields lamp and reduces glare
6" Long Shroud		5010-LSHR-BK 5010-LSHR-BZ 5010-LSHR-BBR	Black on Aluminum Bronze on Aluminum Bronze on Brass	Reduce glare. Ideal for downlighting application.
5" Long Shroud		5211-LSHR-BK 5211-LSHR-BZ 5211-LSHR-BBR	Black on Aluminum Bronze on Aluminum Bronze on Brass	Reduce glare. Ideal for downlighting application.
Gutter Mount Bracket		5000-GM-BZ 5000-GM-BK	Stainless Steel	Stainless Steel universal mounting bracket for gutter mounting fixture
Tree Mount Junction Box		5000-TCP-BK 5000-TCP-BZ	Black on Aluminum Bronze on Aluminum	Bronze on Aluminum box with Stainless steel mounting screws. Two 1/2" NPT threaded holes.
Extension Rods		5000-X04-BZ 4 in 5000-X04-BK 4 in 5000-X04-BBR 4 in 5000-X08-BZ 8 in 5000-X08-BK 8 in 5000-X08-BBR 8 in 5000-X12-BZ 12 in 5000-X12-BK 12 in 5000-X12-BBR 12 in 5000-X18-BZ 18 in 5000-X18-BK 18 in 5000-X18-BBR 18 in 5000-X24-BZ 24 in 5000-X24-BK 24 in 5000-X24-BBR 24 in		Extends distance between Accent light and Surface Mount Canopy, Stake, or Tree Mount box
Rod L-Coupler		5000-LCO-BK 5000-LCO-BZ	Black Bronze	Extension rod coupler
Rock Guard		5830-GRD-BZ 5830-GRD-BBR	Bronze on Aluminum Bronze on Brass	Protects the fixture face
Concrete Pour Kit		5830-PIP-PVC	Shown with temporary dense foam cap	For installation in concrete Five 1/2" NPT threaded holes, PVC

TAPE LIGHT

	5' Clear Channel	T24-OD-CH5-CL	5 feet Includes mounting hardware
	Invisible Clip	T24-OD-C3-WT	Spring clip secures beneath tape (10pcs)
	Surface Mounting Clip	T24-OD-C1-WT	For installation on non-flat surfaces where there is no edge contact (10pcs/pack)
	Edge Mounting Clip	T24-OD-C2-WT	For installation on non-flat surfaces, allows for contact on one edge (10 pcs/pack)
	End Cap	T24-OD-EC-WT	Seal cut end with silicone after adding end cap
	Joiner Cable	T24-OD-IC6-WT T24-OD-IC12-WT T24-OD-IC72-WT T24-OD-IC120-WT	6 inch 1 foot 6 feet 10 feet
	4 Way "X" Connector	T24-OD-X-WT	
	3 Way "Y" Connector	T24-OD-Y-WT	

TRANSFORMER

	Smart Magnetic Transformer	150W MAX: 8150CS-TRN-SS 300W MAX: 8300CS-TRN-SS	Stainless Steel, 15VAC output, IP65 rated, UL 1838 listed
---	----------------------------	--	---

WALLSTATION

	Scene Dimming Wallstation	LED-WCT-WT	Easy installation and a simple way to control lighting. The sleek, aesthetic designs are suitable for all interior locations
---	---------------------------	-------------------	--

WARRANTY

Landscape Products, as defined by products offered at www.waclighting.com/landscape, carry a 10 year warranty on low voltage electronics, 5 years on 120V electronics, 5 years on outdoor finishes on aluminum housings, 10 years on outdoor finishes on brass housings, lifetime on stainless steel, under normal use.

Visit www.waclighting.com/warranty for full warranty information.

Headquarters

Tel: 800.526.2588
Fax: 800.526.5285
44 Harbor Park Dr
Port Washington, NY 11050

Distribution and Assembly Facilities

South East

1600 Distribution Ct
Lithia Springs, GA 30122

Central

1700 South J Elmer Freeway
Suite 100
Cedar Hill, TX 75104

West

1750 S Archibald Ave
Ontario, CA 91761

Consult our facility to take advantage of our custom capabilities in large quantities.
For up to date product specifications and assistance
please visit wacighting.com
or call
1-800-526-2588



WACLIGHTING.COM/COLORSCAPING



WAC Lighting technology and designs are protected by several patents and patent applications. WAC Lighting will not hesitate to enforce its intellectual property rights through injunctive relief and seek further relief through damages if it has reason to believe its patents are being infringed.

Copyright © 2024 WAC Lighting. All rights reserved. This catalog is copyrighted and WAC Lighting will use all measures available to it under the law against anyone who copies or derives from its copyrighted work.

WAC Lighting retains the right to modify the design of its products at any time as part of the company's continuous improvement program. Please refer to our website for the latest product specifications.